



# Catalyst 4500 Series Switches Installation Guide

December 2005

## **Corporate Headquarters**

Cisco Systems, Inc.  
170 West Tasman Drive  
San Jose, CA 95134-1706  
USA  
<http://www.cisco.com>  
Tel: 408 526-4000  
800 553-NETS (6387)  
Fax: 408 526-4100

Customer Order Number: DOC-7814409=  
Text Part Number: 78-14409-08



THE SPECIFICATIONS AND INFORMATION REGARDING THE PRODUCTS IN THIS MANUAL ARE SUBJECT TO CHANGE WITHOUT NOTICE. ALL STATEMENTS, INFORMATION, AND RECOMMENDATIONS IN THIS MANUAL ARE BELIEVED TO BE ACCURATE BUT ARE PRESENTED WITHOUT WARRANTY OF ANY KIND, EXPRESS OR IMPLIED. USERS MUST TAKE FULL RESPONSIBILITY FOR THEIR APPLICATION OF ANY PRODUCTS.

THE SOFTWARE LICENSE AND LIMITED WARRANTY FOR THE ACCOMPANYING PRODUCT ARE SET FORTH IN THE INFORMATION PACKET THAT SHIPPED WITH THE PRODUCT AND ARE INCORPORATED HEREIN BY THIS REFERENCE. IF YOU ARE UNABLE TO LOCATE THE SOFTWARE LICENSE OR LIMITED WARRANTY, CONTACT YOUR CISCO REPRESENTATIVE FOR A COPY.

The following information is for FCC compliance of Class A devices: This equipment has been tested and found to comply with the limits for a Class A digital device, pursuant to part 15 of the FCC rules. These limits are designed to provide reasonable protection against harmful interference when the equipment is operated in a commercial environment. This equipment generates, uses, and can radiate radio-frequency energy and, if not installed and used in accordance with the instruction manual, may cause harmful interference to radio communications. Operation of this equipment in a residential area is likely to cause harmful interference, in which case users will be required to correct the interference at their own expense.

The following information is for FCC compliance of Class B devices: The equipment described in this manual generates and may radiate radio-frequency energy. If it is not installed in accordance with Cisco's installation instructions, it may cause interference with radio and television reception. This equipment has been tested and found to comply with the limits for a Class B digital device in accordance with the specifications in part 15 of the FCC rules. These specifications are designed to provide reasonable protection against such interference in a residential installation. However, there is no guarantee that interference will not occur in a particular installation.

Modifying the equipment without Cisco's written authorization may result in the equipment no longer complying with FCC requirements for Class A or Class B digital devices. In that event, your right to use the equipment may be limited by FCC regulations, and you may be required to correct any interference to radio or television communications at your own expense.

You can determine whether your equipment is causing interference by turning it off. If the interference stops, it was probably caused by the Cisco equipment or one of its peripheral devices. If the equipment causes interference to radio or television reception, try to correct the interference by using one or more of the following measures:

- Turn the television or radio antenna until the interference stops.
- Move the equipment to one side or the other of the television or radio.
- Move the equipment farther away from the television or radio.
- Plug the equipment into an outlet that is on a different circuit from the television or radio. (That is, make certain the equipment and the television or radio are on circuits controlled by different circuit breakers or fuses.)

Modifications to this product not authorized by Cisco Systems, Inc. could void the FCC approval and negate your authority to operate the product.

The Cisco implementation of TCP header compression is an adaptation of a program developed by the University of California, Berkeley (UCB) as part of UCB's public domain version of the UNIX operating system. All rights reserved. Copyright © 1981, Regents of the University of California.

NOTWITHSTANDING ANY OTHER WARRANTY HEREIN, ALL DOCUMENT FILES AND SOFTWARE OF THESE SUPPLIERS ARE PROVIDED "AS IS" WITH ALL FAULTS. CISCO AND THE ABOVE-NAMED SUPPLIERS DISCLAIM ALL WARRANTIES, EXPRESSED OR IMPLIED, INCLUDING, WITHOUT LIMITATION, THOSE OF MERCHANTABILITY, FITNESS FOR A PARTICULAR PURPOSE AND NONINFRINGEMENT OR ARISING FROM A COURSE OF DEALING, USAGE, OR TRADE PRACTICE.

IN NO EVENT SHALL CISCO OR ITS SUPPLIERS BE LIABLE FOR ANY INDIRECT, SPECIAL, CONSEQUENTIAL, OR INCIDENTAL DAMAGES, INCLUDING, WITHOUT LIMITATION, LOST PROFITS OR LOSS OR DAMAGE TO DATA ARISING OUT OF THE USE OR INABILITY TO USE THIS MANUAL, EVEN IF CISCO OR ITS SUPPLIERS HAVE BEEN ADVISED OF THE POSSIBILITY OF SUCH DAMAGES.

CCSP, CCVP, the Cisco Square Bridge logo, Follow Me Browsing, and StackWise are trademarks of Cisco Systems, Inc.; Changing the Way We Work, Live, Play, and Learn, and iQuick Study are service marks of Cisco Systems, Inc.; and Access Registrar, Aironet, ASIST, BPX, Catalyst, CCDA, CCDP, CCIE, CCIP, CCNA, CCNP, Cisco, the Cisco Certified Internetwork Expert logo, Cisco IOS, Cisco Press, Cisco Systems, Cisco Systems Capital, the Cisco Systems logo, Cisco Unity, Empowering the Internet Generation, Enterprise/Solver, EtherChannel, EtherFast, EtherSwitch, Fast Step, FormShare, GigaDrive, GigaStack, HomeLink, Internet Quotient, IOS, IP/TV, iQ Expertise, the iQ logo, iQ Net Readiness Scorecard, LightStream, Linksys, MeetingPlace, MGX, the Networkers logo, Networking Academy, Network Registrar, *Packet*, PIX, Post-Routing, Pre-Routing, ProConnect, RateMUX, ScriptShare, SlideCast, SMARTnet, StrataView Plus, TeleRouter, The Fastest Way to Increase Your Internet Quotient, and TransPath are registered trademarks of Cisco Systems, Inc. and/or its affiliates in the United States and certain other countries.

All other trademarks mentioned in this document or Website are the property of their respective owners. The use of the word partner does not imply a partnership relationship between Cisco and any other company. (0502R)

*Catalyst 4500 Series Switches Installation Guide*

Copyright © 2002–2005 Cisco Systems, Inc. All rights reserved.





## **Preface ix**

- Audience **ix**
- Organization **ix**
- Related Documentation **x**
- Conventions **xi**
- Obtaining Documentation **xvii**
  - Cisco.com **xvii**
  - Product Documentation DVD **xviii**
  - Ordering Documentation **xviii**
- Documentation Feedback **xix**
- Cisco Product Security Overview **xix**
  - Reporting Security Problems in Cisco Products **xx**
- Obtaining Technical Assistance **xx**
  - Cisco Technical Support & Documentation Website **xxi**
  - Submitting a Service Request **xxi**
  - Definitions of Service Request Severity **xxii**
- Obtaining Additional Publications and Information **xxiii**

---

## **CHAPTER 1**

### **Product Overview 1-1**

- Switch Features **1-1**
  - Catalyst 4503 Switch Features **1-2**
  - Catalyst 4506 Switch Features **1-6**
  - Catalyst 4507R Switch Features **1-10**
  - Catalyst 4510R Switch Features **1-14**

- Supervisor Engines **1-18**
  - LEDs **1-24**
  - Gigabit Ethernet Uplink Ports **1-25**
  - 10-Gigabit Ethernet Uplink Ports **1-25**
  - SFP Ports **1-26**
  - 10/100BASE-T Port **1-26**
  - CONSOLE Port **1-26**
  - RESET Button **1-26**
  - CompactFlash Port **1-27**
- Fan Assembly **1-27**
- Power Supplies **1-31**
  - Power Supply LEDs **1-34**
  - Power Supply Fan **1-35**
  - Load-Sharing Feature **1-35**
  - Environmental Monitoring Feature **1-35**
  - 1400 W DC Triple-input Power Supply Operational Modes **1-36**
- System Architecture **1-40**
  - Power Flow **1-40**
    - Power over Ethernet **1-41**
    - Management Flow **1-45**
    - Switching Traffic Flow **1-46**

---

**CHAPTER 2****Preparing for Installation 2-1**

- Electrostatic Discharge **2-2**
  - Preventing Electrostatic Discharge Damage **2-3**
- Site Power Requirements and Heat Dissipation **2-4**
- Power Connection Guidelines for AC-Powered Systems **2-5**
- Power Connection Guidelines for DC-Powered Systems **2-12**
  - Calculating DC Input Current **2-13**

- Ventilation **2-14**
  - Calculating System Heat Dissipation **2-15**
- Site-Planning Checklist **2-16**

---

**CHAPTER 3****Installing the Switch in a Rack 3-1**

- Checking the Shipping Container Contents **3-2**
- Rack-Mounting the Switch **3-3**
  - Required Installation Tools **3-3**
  - Rack-Mounting Catalyst 4500 Series Switches **3-4**
- System Ground Connection Guidelines **3-18**
  - Parts and Required Tools **3-22**
  - Connecting System Ground and Power **3-23**

---

**CHAPTER 4****Removing and Replacing FRUs 4-1**

- Removing and Replacing the Power Supply **4-2**
  - Required Tools **4-5**
  - Removing an AC-Input Power Supply **4-5**
  - Installing an AC-Input Power Supply **4-8**
  - Removing a DC-Input Power Supply **4-11**
    - Required Tools **4-11**
    - Removal Procedure **4-11**
  - Installing a DC-Input Power Supply **4-16**
    - Required Tools **4-16**
    - Installation Procedure **4-16**
- Removing and Replacing the Chassis Fan Assembly **4-18**
  - Required Tools **4-22**
  - Removing the Fan Assembly **4-23**
  - Installing the Fan Assembly **4-23**
  - Verifying the Installation **4-24**

Replacing Backplane Modules on a Catalyst 4507R or 4510R Switch **4-24**  
Verify the New Modules **4-30**

---

**CHAPTER 5**

**Troubleshooting 5-1**

System Boot Verification **5-2**  
Problem Solving to the System Component Level **5-3**  
Using LEDs to Identify Startup Problems **5-4**  
Troubleshooting the Power Supply **5-6**  
    Troubleshooting Power Problems using Cisco IOS **5-7**  
Troubleshooting the Fan Assembly **5-8**  
Troubleshooting Backplane Modules **5-9**  
Troubleshooting Switching Modules **5-10**  
    Troubleshooting Switching Modules Using Cisco IOS **5-12**  
Troubleshooting Supervisor Engines **5-13**  
    Troubleshooting Supervisor Engines Using Cisco IOS **5-14**  
Contacting the Cisco Technical Assistance Center **5-16**  
    Serial Numbers **5-17**

---

**APPENDIX A**

**Specifications A-1**

Catalyst 4503 Switch Specifications **A-2**  
Catalyst 4506 Switch Specifications **A-3**  
Catalyst 4507R Switch Specifications **A-4**  
Catalyst 4510R Switch Specifications **A-6**  
Catalyst 4500 Series Power Supplies **A-7**

---

**APPENDIX B**

**Repacking a Switch B-1**

---

**INDEX**





# Preface

---

This preface describes the audience, organization, and conventions of the *Catalyst 4500 Series Switches Installation Guide* and provides information on how to obtain related documentation and technical assistance.

## Audience

Only trained and qualified service personnel (as defined in IEC 60950 and AS/NZS3260) should install, replace, or service the equipment.

## Organization

This guide is organized as follows:

Chapter	Title	Description
Chapter 1	Product Overview	Describes the hardware features, components, interfaces, and functionality of the Catalyst 4500 series switches.
Chapter 2	Preparing for Installation	Describes how to prepare your site for the installation of the switch.
Chapter 3	Installing the Switch in a Rack	Describes how to install the Catalyst 4500 series switches. Provides procedures for removing and installing chassis components.

Chapter	Title	Description
Chapter 4	Removing and Replacing FRUs	Describes how to remove and replace field-replaceable units (FRUs).
Chapter 5	Troubleshooting	Provides troubleshooting guidelines for the initial hardware installation and suggests steps to help isolate and resolve problems.
Appendix A	Specifications	Lists the cable and technical specifications of the Catalyst 4500 series switches.
Appendix B	Repacking a Switch	Provides instructions for repacking your Catalyst 4500 series switch in the event that you have to return it to the factory.

## Related Documentation

Refer to the following documents for additional Catalyst 4500 series information:

- *Catalyst 4500 Series Module Installation Guide* at [http://www.cisco.com/en/US/products/hw/switches/ps4324/products\\_module\\_installation\\_guide\\_book09186a008009c17d.html](http://www.cisco.com/en/US/products/hw/switches/ps4324/products_module_installation_guide_book09186a008009c17d.html) for information about individual switching modules and supervisors.
- *Regulatory Compliance and Safety Information for the Catalyst 4500 Series Switches* at [http://www.cisco.com/en/US/products/hw/switches/ps4324/products\\_regulatory\\_approvals\\_and\\_compliance09186a00800d7676.html](http://www.cisco.com/en/US/products/hw/switches/ps4324/products_regulatory_approvals_and_compliance09186a00800d7676.html)
- The release note appropriate to your software version. Release notes are at: [http://www.cisco.com/en/US/products/hw/switches/ps4324/prod\\_release\\_notes\\_list.html](http://www.cisco.com/en/US/products/hw/switches/ps4324/prod_release_notes_list.html)
- The software configuration guide appropriate to your software version. Software configuration guides are at: [http://www.cisco.com/en/US/products/hw/switches/ps4324/products\\_installation\\_and\\_configuration\\_guides\\_list.html](http://www.cisco.com/en/US/products/hw/switches/ps4324/products_installation_and_configuration_guides_list.html)
- The command reference appropriate to your software version. Command references are at: [http://www.cisco.com/en/US/products/hw/switches/ps4324/prod\\_command\\_reference\\_list.html](http://www.cisco.com/en/US/products/hw/switches/ps4324/prod_command_reference_list.html)

- The system message guide appropriate to your software version. System message guides are at:  
[http://www.cisco.com/en/US/products/hw/switches/ps4324/products\\_system\\_message\\_guides\\_list.html](http://www.cisco.com/en/US/products/hw/switches/ps4324/products_system_message_guides_list.html)
- There are a number of installation notes and technical tips available for this switch. The top level Catalyst 4500 documentation and technical support page is at  
[http://www.cisco.com/en/US/products/hw/switches/ps4324/tsd\\_products\\_support\\_series\\_home.html](http://www.cisco.com/en/US/products/hw/switches/ps4324/tsd_products_support_series_home.html)

## Conventions

This document uses the following conventions:

Convention	Description
<b>boldface font</b>	Commands and keywords are in <b>boldface</b> .
<i>italic font</i>	Arguments for which you supply values are in <i>italics</i> .
[ ]	Elements in square brackets are optional.
{ x   y   z }	Alternative keywords are grouped in braces and separated by vertical bars.
[ x   y   z ]	Optional alternative keywords are grouped in brackets and separated by vertical bars.
string	A nonquoted set of characters. Do not use quotation marks around the string, because the string will include the quotation marks.
screen font	Terminal sessions and information that the system displays are in <i>screen font</i> .
<b>boldface screen font</b>	Information that you must enter is shown in <b>boldface screen font</b> .
<i>italic screen font</i>	Arguments for which you supply values are in <i>italic screen font</i> .

Convention	Description
Ctrl-	Ctrl- represents the key labeled Control—for example, the key combination <b>Ctrl-D</b> means to hold down the Control key while you press the D key.
< >	Characters that do not print, such as passwords, are shown within angle brackets.

Notes use the following conventions:




---

**Note**

Means *reader take note*. Notes contain helpful suggestions or references to material not covered in the publication.

---

Cautions use the following conventions:




---

**Caution**

Means *reader be careful*. In this situation, you might do something that could result in equipment damage or loss of data.

---

Warnings use the following conventions:



**Warning**

### **IMPORTANT SAFETY INSTRUCTIONS**

**This warning symbol means danger. You are in a situation that could cause bodily injury. Before you work on any equipment, be aware of the hazards involved with electrical circuitry and be familiar with standard practices for preventing accidents. Use the statement number provided at the end of each warning to locate its translation in the translated safety warnings that accompanied this device.** Statement 1071

### **SAVE THESE INSTRUCTIONS**

**Waarschuwing**

### **BELANGRIJKE VEILIGHEIDSINSTRUCTIES**

**Dit waarschuwingssymbool betekent gevaar. U verkeert in een situatie die lichamelijk letsel kan veroorzaken. Voordat u aan enige apparatuur gaat werken, dient u zich bewust te zijn van de bij elektrische schakelingen betrokken risico's en dient u op de hoogte te zijn van de standaard praktijken om ongelukken te voorkomen. Gebruik het nummer van de verklaring onderaan de waarschuwing als u een vertaling van de waarschuwing die bij het apparaat wordt geleverd, wilt raadplegen.**

### **BEWAAR DEZE INSTRUCTIES**

**Varoitus**

### **TÄRKEITÄ TURVALLISUUSOHJEITA**

**Tämä varoitusmerkki merkitsee vaaraa. Tilanne voi aiheuttaa ruumiillisia vammoja. Ennen kuin käsittelet laitteistoa, huomioi sähköpiirien käsittelymiseen liittyvät riskit ja tutustu onnettomuuksien yleisiin ehkäisytapoihin. Turvallisuusvaroitusten käännökset löytyvät laitteen mukana toimitettujen käännettyjen turvallisuusvaroitusten joukosta varoitusten lopussa näkyvien lausuntonumeroiden avulla.**

### **SÄILYTÄ NÄMÄ OHJEET**

**Attention      IMPORTANTES INFORMATIONS DE SÉCURITÉ**

**Ce symbole d'avertissement indique un danger. Vous vous trouvez dans une situation pouvant entraîner des blessures ou des dommages corporels. Avant de travailler sur un équipement, soyez conscient des dangers liés aux circuits électriques et familiarisez-vous avec les procédures couramment utilisées pour éviter les accidents. Pour prendre connaissance des traductions des avertissements figurant dans les consignes de sécurité traduites qui accompagnent cet appareil, référez-vous au numéro de l'instruction situé à la fin de chaque avertissement.**

**CONSERVEZ CES INFORMATIONS****Warnung      WICHTIGE SICHERHEITSHINWEISE**

**Dieses Warnsymbol bedeutet Gefahr. Sie befinden sich in einer Situation, die zu Verletzungen führen kann. Machen Sie sich vor der Arbeit mit Geräten mit den Gefahren elektrischer Schaltungen und den üblichen Verfahren zur Vorbeugung vor Unfällen vertraut. Suchen Sie mit der am Ende jeder Warnung angegebenen Anweisungsnummer nach der jeweiligen Übersetzung in den übersetzten Sicherheitshinweisen, die zusammen mit diesem Gerät ausgeliefert wurden.**

**BEWAHREN SIE DIESE HINWEISE GUT AUF.****Avvertenza      IMPORTANTI ISTRUZIONI SULLA SICUREZZA**

**Questo simbolo di avvertenza indica un pericolo. La situazione potrebbe causare infortuni alle persone. Prima di intervenire su qualsiasi apparecchiatura, occorre essere al corrente dei pericoli relativi ai circuiti elettrici e conoscere le procedure standard per la prevenzione di incidenti. Utilizzare il numero di istruzione presente alla fine di ciascuna avvertenza per individuare le traduzioni delle avvertenze riportate in questo documento.**

**CONSERVARE QUESTE ISTRUZIONI**

**Advarsel VIKTIGE SIKKERHETSINSTRUKSJONER**

**Dette advarselssymbolet betyr fare. Du er i en situasjon som kan føre til skade på person. Før du begynner å arbeide med noe av utstyret, må du være oppmerksom på farene forbundet med elektriske kretser, og kjenne til standardprosedyrer for å forhindre ulykker. Bruk nummeret i slutten av hver advarsel for å finne oversettelsen i de oversatte sikkerhetsadvarslene som fulgte med denne enheten.**

**TA VARE PÅ DISSE INSTRUKSJONENE****Aviso INSTRUÇÕES IMPORTANTES DE SEGURANÇA**

**Este símbolo de aviso significa perigo. Você está em uma situação que poderá ser causadora de lesões corporais. Antes de iniciar a utilização de qualquer equipamento, tenha conhecimento dos perigos envolvidos no manuseio de circuitos elétricos e familiarize-se com as práticas habituais de prevenção de acidentes. Utilize o número da instrução fornecido ao final de cada aviso para localizar sua tradução nos avisos de segurança traduzidos que acompanham este dispositivo.**

**GUARDE ESTAS INSTRUÇÕES****¡Advertencia! INSTRUCCIONES IMPORTANTES DE SEGURIDAD**

**Este símbolo de aviso indica peligro. Existe riesgo para su integridad física. Antes de manipular cualquier equipo, considere los riesgos de la corriente eléctrica y familiarícese con los procedimientos estándar de prevención de accidentes. Al final de cada advertencia encontrará el número que le ayudará a encontrar el texto traducido en el apartado de traducciones que acompaña a este dispositivo.**

**GUARDE ESTAS INSTRUCCIONES**

**Varning! VIKTIGA SÄKERHETSANVISNINGAR**

Denna varningssignal signalerar fara. Du befinner dig i en situation som kan leda till personskada. Innan du utför arbete på någon utrustning måste du vara medveten om farorna med elkretsar och känna till vanliga förfaranden för att förebygga olyckor. Använd det nummer som finns i slutet av varje varning för att hitta dess översättning i de översatta säkerhetsvarningar som medföljer denna anordning.

**SPARA DESSA ANVISNINGAR****Figyelem FONTOS BIZTONSÁGI ELOÍRÁSOK**

Ez a figyelmeztető jel veszélyre utal. Sérülésveszélyt rejtő helyzetben van. Mielőtt bármely berendezésen munkát végezte, legyen figyelemmel az elektromos áramkörök okozta kockázatokra, és ismerkedjen meg a szokásos balesetvédelmi eljárásokkal. A kiadványban szereplő figyelmeztetések fordítása a készülékhez mellékelt biztonsági figyelmeztetések között található; a fordítás az egyes figyelmeztetések végén látható szám alapján kereshető meg.

**ORIZZE MEG EZEKET AZ UTASÍTÁSOKAT!****Предупреждение ВАЖНЫЕ ИНСТРУКЦИИ ПО СОБЛЮДЕНИЮ ТЕХНИКИ БЕЗОПАСНОСТИ**

Этот символ предупреждения обозначает опасность. То есть имеет место ситуация, в которой следует опасаться телесных повреждений. Перед эксплуатацией оборудования выясните, каким опасностям может подвергаться пользователь при использовании электрических цепей, и ознакомьтесь с правилами техники безопасности для предотвращения возможных несчастных случаев. Воспользуйтесь номером заявления, приведенным в конце каждого предупреждения, чтобы найти его переведенный вариант в переводе предупреждений по безопасности, прилагаемом к данному устройству.

**СОХРАНИТЕ ЭТИ ИНСТРУКЦИИ**



**警告** 重要的安全性说明

此警告符号代表危险。您正处于可能受到严重伤害的工作环境中。在您使用设备开始工作之前，必须充分意识到触电的危险，并熟练掌握防止事故发生的标准工作程序。请根据每项警告结尾提供的声明号码来找到此设备的安全性警告说明的翻译文本。

请保存这些安全性说明

**警告** 安全上の重要な注意事項

「危険」の意味です。人身事故を予防するための注意事項が記述されています。装置の取り扱い作業を行うときは、電気回路の危険性に注意し、一般的な事故防止策に留意してください。警告の各国語版は、各注意事項の番号を基に、装置に付属の「Translated Safety Warnings」を参照してください。

これらの注意事項を保管しておいてください。

---

## Obtaining Documentation

Cisco documentation and additional literature are available on Cisco.com. Cisco also provides several ways to obtain technical assistance and other technical resources. These sections explain how to obtain technical information from Cisco Systems.

### Cisco.com

You can access the most current Cisco documentation at this URL:

<http://www.cisco.com/techsupport>

You can access the Cisco website at this URL:

<http://www.cisco.com>

You can access international Cisco websites at this URL:

[http://www.cisco.com/public/countries\\_languages.shtml](http://www.cisco.com/public/countries_languages.shtml)

## Product Documentation DVD

Cisco documentation and additional literature are available in the Product Documentation DVD package, which may have shipped with your product. The Product Documentation DVD is updated regularly and may be more current than printed documentation.

The Product Documentation DVD is a comprehensive library of technical product documentation on portable media. The DVD enables you to access multiple versions of hardware and software installation, configuration, and command guides for Cisco products and to view technical documentation in HTML. With the DVD, you have access to the same documentation that is found on the Cisco website without being connected to the Internet. Certain products also have .pdf versions of the documentation available.

The Product Documentation DVD is available as a single unit or as a subscription. Registered Cisco.com users (Cisco direct customers) can order a Product Documentation DVD (product number DOC-DOCDVD=) from Cisco Marketplace at this URL:

<http://www.cisco.com/go/marketplace/>

## Ordering Documentation

Beginning June 30, 2005, registered Cisco.com users may order Cisco documentation at the Product Documentation Store in the Cisco Marketplace at this URL:

<http://www.cisco.com/go/marketplace/>

Nonregistered Cisco.com users can order technical documentation from 8:00 a.m. to 5:00 p.m. (0800 to 1700) PDT by calling 1 866 463-3487 in the United States and Canada, or elsewhere by calling 011 408 519-5055. You can also order documentation by e-mail at [tech-doc-store-mkpl@external.cisco.com](mailto:tech-doc-store-mkpl@external.cisco.com) or by fax at 1 408 519-5001 in the United States and Canada, or elsewhere at 011 408 519-5001.

# Documentation Feedback

You can rate and provide feedback about Cisco technical documents by completing the online feedback form that appears with the technical documents on Cisco.com.

You can send comments about Cisco documentation to [bug-doc@cisco.com](mailto:bug-doc@cisco.com).

You can submit comments by using the response card (if present) behind the front cover of your document or by writing to the following address:

Cisco Systems  
Attn: Customer Document Ordering  
170 West Tasman Drive  
San Jose, CA 95134-9883

We appreciate your comments.

# Cisco Product Security Overview

Cisco provides a free online Security Vulnerability Policy portal at this URL:

[http://www.cisco.com/en/US/products/products\\_security\\_vulnerability\\_policy.html](http://www.cisco.com/en/US/products/products_security_vulnerability_policy.html)

From this site, you can perform these tasks:

- Report security vulnerabilities in Cisco products.
- Obtain assistance with security incidents that involve Cisco products.
- Register to receive security information from Cisco.

A current list of security advisories and notices for Cisco products is available at this URL:

<http://www.cisco.com/go/psirt>

If you prefer to see advisories and notices as they are updated in real time, you can access a Product Security Incident Response Team Really Simple Syndication (PSIRT RSS) feed from this URL:

[http://www.cisco.com/en/US/products/products\\_psirt\\_rss\\_feed.html](http://www.cisco.com/en/US/products/products_psirt_rss_feed.html)

## Reporting Security Problems in Cisco Products

Cisco is committed to delivering secure products. We test our products internally before we release them, and we strive to correct all vulnerabilities quickly. If you think that you might have identified a vulnerability in a Cisco product, contact PSIRT:

- Emergencies—[security-alert@cisco.com](mailto:security-alert@cisco.com)

An emergency is either a condition in which a system is under active attack or a condition for which a severe and urgent security vulnerability should be reported. All other conditions are considered nonemergencies.

- Nonemergencies—[psirt@cisco.com](mailto:psirt@cisco.com)

In an emergency, you can also reach PSIRT by telephone:

- 1 877 228-7302
- 1 408 525-6532



**Tip**

---

We encourage you to use Pretty Good Privacy (PGP) or a compatible product to encrypt any sensitive information that you send to Cisco. PSIRT can work from encrypted information that is compatible with PGP versions 2.x through 8.x.

Never use a revoked or an expired encryption key. The correct public key to use in your correspondence with PSIRT is the one linked in the Contact Summary section of the Security Vulnerability Policy page at this URL:

[http://www.cisco.com/en/US/products/products\\_security\\_vulnerability\\_policy.html](http://www.cisco.com/en/US/products/products_security_vulnerability_policy.html)

The link on this page has the current PGP key ID in use.

---

## Obtaining Technical Assistance

Cisco Technical Support provides 24-hour-a-day award-winning technical assistance. The Cisco Technical Support & Documentation website on Cisco.com features extensive online support resources. In addition, if you have a valid Cisco

service contract, Cisco Technical Assistance Center (TAC) engineers provide telephone support. If you do not have a valid Cisco service contract, contact your reseller.

## Cisco Technical Support & Documentation Website

The Cisco Technical Support & Documentation website provides online documents and tools for troubleshooting and resolving technical issues with Cisco products and technologies. The website is available 24 hours a day, at this URL:

<http://www.cisco.com/techsupport>

Access to all tools on the Cisco Technical Support & Documentation website requires a Cisco.com user ID and password. If you have a valid service contract but do not have a user ID or password, you can register at this URL:

<http://tools.cisco.com/RPF/register/register.do>



### Note

---

Use the Cisco Product Identification (CPI) tool to locate your product serial number before submitting a web or phone request for service. You can access the CPI tool from the Cisco Technical Support & Documentation website by clicking the **Tools & Resources** link under Documentation & Tools. Choose **Cisco Product Identification Tool** from the Alphabetical Index drop-down list, or click the **Cisco Product Identification Tool** link under Alerts & RMAs. The CPI tool offers three search options: by product ID or model name; by tree view; or for certain products, by copying and pasting **show** command output. Search results show an illustration of your product with the serial number label location highlighted. Locate the serial number label on your product and record the information before placing a service call.

---

## Submitting a Service Request

Using the online TAC Service Request Tool is the fastest way to open S3 and S4 service requests. (S3 and S4 service requests are those in which your network is minimally impaired or for which you require product information.) After you describe your situation, the TAC Service Request Tool provides recommended

solutions. If your issue is not resolved using the recommended resources, your service request is assigned to a Cisco engineer. The TAC Service Request Tool is located at this URL:

<http://www.cisco.com/techsupport/servicerequest>

For S1 or S2 service requests or if you do not have Internet access, contact the Cisco TAC by telephone. (S1 or S2 service requests are those in which your production network is down or severely degraded.) Cisco engineers are assigned immediately to S1 and S2 service requests to help keep your business operations running smoothly.

To open a service request by telephone, use one of the following numbers:

Asia-Pacific: +61 2 8446 7411 (Australia: 1 800 805 227)

EMEA: +32 2 704 55 55

USA: 1 800 553-2447

For a complete list of Cisco TAC contacts, go to this URL:

<http://www.cisco.com/techsupport/contacts>

## Definitions of Service Request Severity

To ensure that all service requests are reported in a standard format, Cisco has established severity definitions.

**Severity 1 (S1)**—Your network is “down,” or there is a critical impact to your business operations. You and Cisco will commit all necessary resources around the clock to resolve the situation.

**Severity 2 (S2)**—Operation of an existing network is severely degraded, or significant aspects of your business operation are negatively affected by inadequate performance of Cisco products. You and Cisco will commit full-time resources during normal business hours to resolve the situation.

**Severity 3 (S3)**—Operational performance of your network is impaired, but most business operations remain functional. You and Cisco will commit resources during normal business hours to restore service to satisfactory levels.

**Severity 4 (S4)**—You require information or assistance with Cisco product capabilities, installation, or configuration. There is little or no effect on your business operations.

# Obtaining Additional Publications and Information

Information about Cisco products, technologies, and network solutions is available from various online and printed sources.

- Cisco Marketplace provides a variety of Cisco books, reference guides, documentation, and logo merchandise. Visit Cisco Marketplace, the company store, at this URL:

<http://www.cisco.com/go/marketplace/>

- *Cisco Press* publishes a wide range of general networking, training and certification titles. Both new and experienced users will benefit from these publications. For current Cisco Press titles and other information, go to Cisco Press at this URL:

<http://www.ciscopress.com>

- *Packet* magazine is the Cisco Systems technical user magazine for maximizing Internet and networking investments. Each quarter, Packet delivers coverage of the latest industry trends, technology breakthroughs, and Cisco products and solutions, as well as network deployment and troubleshooting tips, configuration examples, customer case studies, certification and training information, and links to scores of in-depth online resources. You can access Packet magazine at this URL:

<http://www.cisco.com/packet>

- *iQ Magazine* is the quarterly publication from Cisco Systems designed to help growing companies learn how they can use technology to increase revenue, streamline their business, and expand services. The publication identifies the challenges facing these companies and the technologies to help solve them, using real-world case studies and business strategies to help readers make sound technology investment decisions. You can access iQ Magazine at this URL:

<http://www.cisco.com/go/iqmagazine>

or view the digital edition at this URL:

<http://ciscoiq.texterity.com/ciscoiq/sample/>

- *Internet Protocol Journal* is a quarterly journal published by Cisco Systems for engineering professionals involved in designing, developing, and operating public and private internets and intranets. You can access the Internet Protocol Journal at this URL:

<http://www.cisco.com/ipj>

- Networking products offered by Cisco Systems, as well as customer support services, can be obtained at this URL:

<http://www.cisco.com/en/US/products/index.html>

- Networking Professionals Connection is an interactive website for networking professionals to share questions, suggestions, and information about networking products and technologies with Cisco experts and other networking professionals. Join a discussion at this URL:

<http://www.cisco.com/discuss/networking>

- World-class networking training is available from Cisco. You can view current offerings at this URL:

<http://www.cisco.com/en/US/learning/index.html>





# Product Overview

---

This chapter provides an overview of the features and components of the Catalyst 4500 series switches. The Catalyst 4500 series switches are the Catalyst 4503 switch, the Catalyst 4506 switch, the Catalyst 4507R switch, and the Catalyst 4510R switch. The information is presented in these major sections:

- Switch Features, page 1-1
- Supervisor Engines, page 1-18
- Fan Assembly, page 1-27
- Power Supplies, page 1-31
- System Architecture, page 1-40

## Switch Features

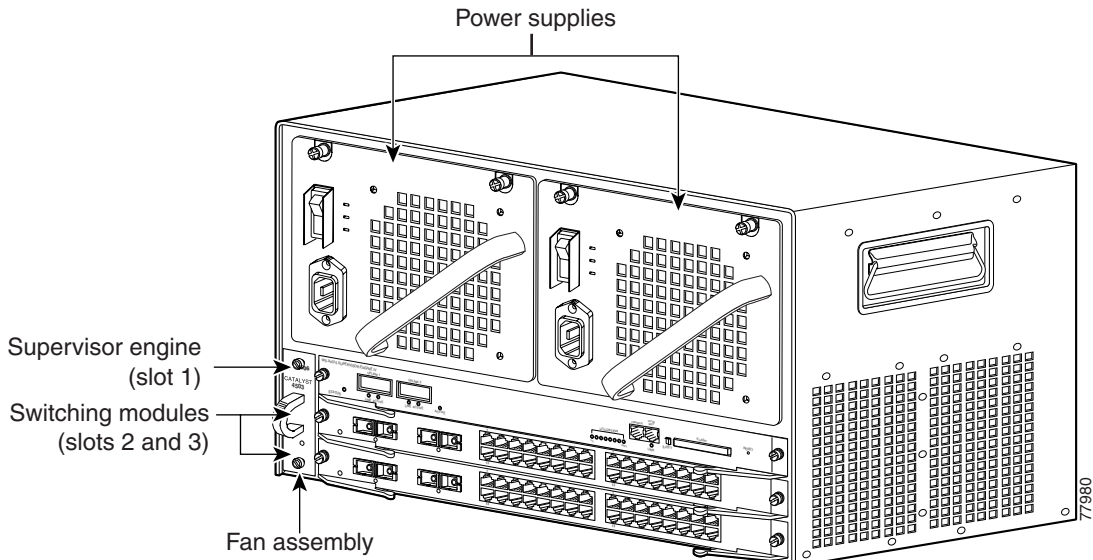
The following sections describe the features of the Catalyst 4500 series switches:

- Catalyst 4503 Switch Features, page 1-2
- Catalyst 4506 Switch Features, page 1-6
- Catalyst 4507R Switch Features, page 1-10
- Catalyst 4510R Switch Features, page 1-14

## Catalyst 4503 Switch Features

The Catalyst 4503 switch (see Figure 1-1) is a three-slot switch designed for high-performance, high-density wiring closet applications.

Figure 1-1 Catalyst 4503 Switch (Front View)



The Catalyst 4503 switch supports the Supervisor Engine II, II+, II+TS, II+10GE, IV, V, and V-10GE. The supervisor engine has a nonblocking, full-duplex, switching fabric that provides connections between the supervisor engine and the switching modules. The Gigabit Ethernet ports can be configured with any combination of copper 100BASE-T, shortwave SX, LX/LH, and ZX interfaces, or CWDM and DWDM GBICs. For a description of GBICs, refer to the *Catalyst 4500 Series Module Installation Guide* or the *Catalyst 4500 Series Supervisor Engines and Switching Modules Installation Note*. Some supervisor engines use SFP modules for Gigabit Ethernet connections, or X2 modules for 10-Gigabit Ethernet connections. Refer to the installation note for your supervisor engine for more details on these modules.

Slot 1 is reserved for the supervisor engine only, which provides switching, local and remote management, and switch-status monitoring. Slots 2 and 3 are available for switching modules.

Table 1-1 describes the features of the Catalyst 4503 switch.

**Table 1-1**      **Features of the Catalyst 4503 Switch**

Feature	Description
Ethernet speeds	<ul style="list-style-type: none"> <li>• Ethernet (10BASE-T) interface to workstations and repeaters</li> <li>• Fast Ethernet (100BASE-T) interface to workstations, servers, switches, and routers</li> </ul> <p><b>Note</b>    Autonegotiation of link speed on each 10/100 port allows migration to 100BASE-T from a 10BASE-T installed base.</p> <ul style="list-style-type: none"> <li>• Gigabit Ethernet (1000BASE-T and 1000BASE-X) interfaces for backbone interconnection of high-performance switches and routers</li> <li>• 10-Gigabit Ethernet interfaces for backbone interconnection of high-performance switches and routers</li> </ul>
Standard equipment	<ul style="list-style-type: none"> <li>• Three-slot modular chassis with one slot reserved for a supervisor engine and two slots for switching modules</li> <li>• One hot-swappable fan assembly</li> <li>• Two power supply bays</li> </ul>
Power supplies	<ul style="list-style-type: none"> <li>• Supports a 1000 W, 1300 W, 1400 W, 2800 W, or 4200W AC-input power supply or a 1400 W DC-input single input or triple-input power supply<sup>1</sup></li> <li>• Optional redundant power supply</li> </ul>
Supervisor engine support	<ul style="list-style-type: none"> <li>• Supports the Supervisor Engine II, II+, II+TS, II+10GE, III, IV, V</li> <li>• Holds the ASIC-based forwarding engine (data path) and the management processor and software (control path)</li> <li>• Features interface monitoring, environmental status, and SNMP and console/Telnet interface</li> </ul> <p><b>Note</b>    Packets are not forwarded while the module is removed; a system reboot occurs when a supervisor engine is reinserted.</p>

**Table 1-1**      **Features of the Catalyst 4503 Switch (continued)**

Feature	Description
Switching module support	<ul style="list-style-type: none"> <li>• 24-port 10/100BASE-TX Fast Ethernet switching module (WS-X4124-RJ45)</li> <li>• 24-port 100BASE-FX Fast Ethernet switching module (WS-X4124-FX-MT)</li> <li>• 48-port 100BASE-FX Fast Ethernet switching module (WS-X4148-FX-MT)</li> <li>• 48-port 100BASE-LX10 Fast Ethernet switching module (WS-X4148-FE-LX-MT)</li> <li>• 48-port 10/100-Mbps Fast Ethernet switching module (WS-X4148-RJ)</li> <li>• 48-port 100BASE-BX10-D Fast Ethernet switching module (WS-X4148-FE-BD-LC)</li> <li>• 48-port 10/100-Mbps Fast Ethernet switching module (WS-X4148-RJ21)</li> <li>• 48-port Cisco pre-standard Power over Ethernet (PoE) 10/100BASE-TX switching module (WS-X4148-RJ45V)</li> <li>• 48-port 100BASE-X Fast Ethernet switching module (WS-X4248-FE-SFP)</li> <li>• 24-port IEEE 802.3af-compliant PoE 10/100BASE-TX switching module (WS-X4224-RJ45V)</li> <li>• 48-port IEEE 802.3af compliant PoE 10/100BASE-TX RJ-45 switching module (WS-X4248-RJ45V)</li> <li>• 48 port IEEE 802.3af compliant PoE 10/100BASE-TX RJ-21 switching module (WS-X4248-RJ21V)</li> <li>• 32-port 10/100-Mbps Fast Ethernet plus 2-port Gigabit Ethernet switching module (WS-X4232-GB-RJ)</li> <li>• 32-port 10/100-Mbps Fast Ethernet plus 2-port 1000BASE-X Layer 3 Gigabit Ethernet routing module (WS-X4232-L3)</li> <li>• 32-port 10/100-Mbps Fast Ethernet switching module with modular uplink support (WS-X4232-RJ-XX) <ul style="list-style-type: none"> <li>– 4-port MT-RJ uplink module (WS-U4504-FX-MT) (optional)</li> </ul> </li> </ul>

**Table 1-1**      **Features of the Catalyst 4503 Switch (continued)**

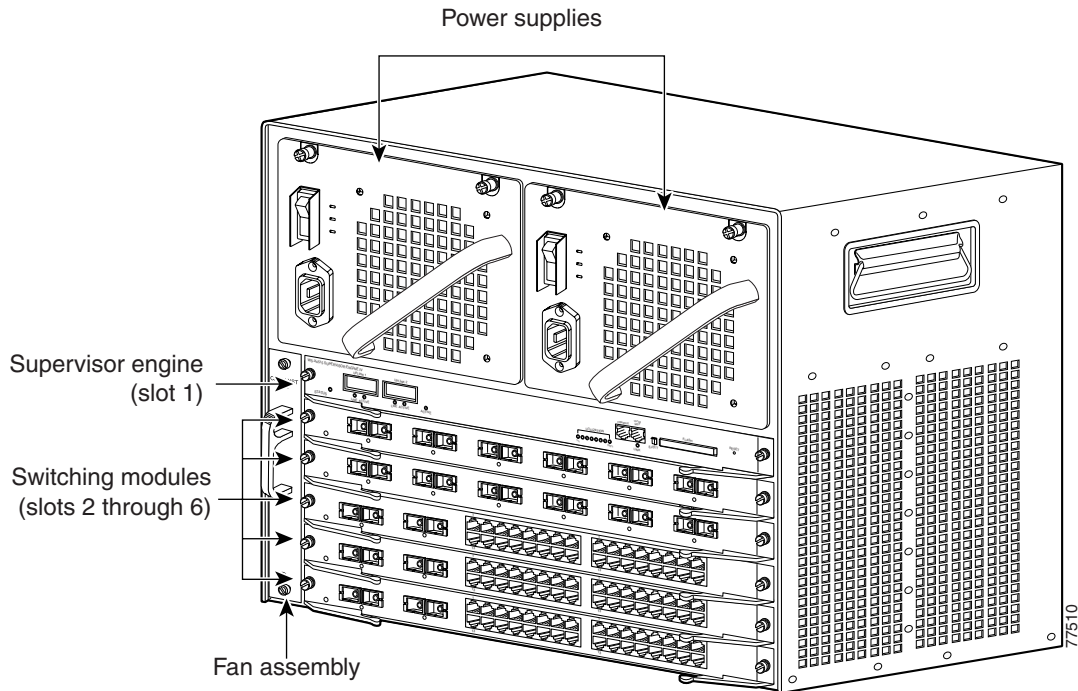
Feature	Description
Switching module support (continued)	<ul style="list-style-type: none"> <li>• 2-port Gigabit Ethernet switching module (WS-X4302-GB)</li> <li>• 6-port 1000BASE-X Gigabit Ethernet switching module (WS-X4306-GB)</li> <li>• 6-port Gigabit Ethernet switching module (WS-X4506-GB-T)</li> <li>• 12-port 1000BASE-T plus 2-port 1000BASE-X Gigabit Ethernet switching module (WS-X4412-2GB-T)</li> <li>• 18-port Gigabit Ethernet switching module (WS-X4418-GB)</li> <li>• 24-port 10/100/1000BASE-T Gigabit Ethernet switching module (WS-X4424-GB-RJ45)</li> <li>• 48-port Gigabit Ethernet 1000 BASE LX (SPF) switching module (WS-X4448-GB-LX)</li> <li>• 48-port 10/100/1000BASE-T Gigabit Ethernet switching module (WS-X4448-GB-RJ45)</li> <li>• 24-port IEEE 802.3af-compliant PoE 10/100/1000BASE-T RJ-45 switching module (WS-X4524-GB-RJ45V)</li> <li>• 48-port 10/100/1000BASE-T Gigabit Ethernet switching module (WS-X4548-GB-RJ45)</li> <li>• 48-port Gigabit Ethernet switching module (WS-X4448-GB-SFP)</li> <li>• 48-port IEEE 802.3af compliant PoE 10/100/1000BASE-T Gigabit Ethernet switching module (WS-X4548-GB-RJ45V)</li> <li>• Access Gateway Module (WS-X4604-GWY)</li> <li>• Backplane channel module (WS-X4019)</li> </ul>

1. You will need to configure the 1400 W DC input current as appropriate for the model of switch. Refer to Appendix A, "Specifications."

## Catalyst 4506 Switch Features

The Catalyst 4506 switch (see Figure 1-2) is a six-slot switch designed for high-performance, high-density wiring closet applications.

**Figure 1-2 Catalyst 4506 Switch (Front View)**



The Catalyst 4506 switch supports the Supervisor Engine II, II+, II+10GE, III, IV, V, and V-10GE. The supervisor engine has a nonblocking, full-duplex, switching fabric that provides connections between the supervisor engine and the switching modules. The Gigabit Ethernet ports can be configured with any combination of copper 1000BASE-T, shortwave SX, LX/LH, and ZX interfaces, or CWDM and DWDM GBICs. For a description of GBICs, refer to the *Catalyst 4500 Series Module Installation Guide* or the *Catalyst 4500 Series Supervisor Engines and Switching Modules Installation Note*. Some supervisor engines use SFP modules

for Gigabit Ethernet connections, or X2 modules for 10-Gigabit Ethernet connections. Refer to the installation note for your supervisor engine for more details on these modules.

Slot 1 is reserved for the supervisor engine only, which provides switching, local and remote management, and switch-status monitoring. Slots 2 through 6 are available for switching modules.

Table 1-2 describes the features of the Catalyst 4506 switch.

**Table 1-2**      **Features of the Catalyst 4506 Switch**

Feature	Description
Ethernet speeds	<ul style="list-style-type: none"> <li>• Ethernet (10BASE-T) interface to workstations and repeaters</li> <li>• Fast Ethernet (100BASE-T) interface to workstations, servers, switches, and routers</li> </ul> <p><b>Note</b> Autonegotiation of link speed on each 10/100 port allows migration to 100BASE-T from a 10BASE-T installed base.</p> <ul style="list-style-type: none"> <li>• Gigabit Ethernet (1000BASE-T and 1000BASE-X) interfaces for backbone interconnection of high-performance switches and routers</li> <li>• 10-Gigabit Ethernet interfaces for backbone interconnection of high-performance switches and routers</li> </ul>
Standard equipment	<ul style="list-style-type: none"> <li>• Six-slot modular chassis with one slot reserved for a supervisor engine and five slots for switching modules</li> <li>• One hot-swappable fan assembly</li> <li>• Two power supply bays</li> </ul>
Power supplies	<ul style="list-style-type: none"> <li>• Supports a 1000 W, 1300 W, 1400 W, 2800 W, or 4200 W AC-input power supply or a 1400 W DC-input single or triple-input power supply<sup>1</sup></li> <li>• Optional redundant power supply</li> </ul>

**Table 1-2**      **Features of the Catalyst 4506 Switch (continued)**

Feature	Description
Supervisor engine support	<ul style="list-style-type: none"> <li>• Supports the Supervisor Engine II, II+, II+10GE, III, IV, V</li> <li>• Holds the ASIC-based forwarding engine (data path) and the management processor and software (control path)</li> <li>• Features interface monitoring, environmental status, and SNMP and console/Telnet interface</li> </ul> <p><b>Note</b>    Packets are not forwarded while the module is removed; a system reboot occurs when a supervisor engine is reinserted.</p>
Switching module support	<ul style="list-style-type: none"> <li>• 24-port 10/100BASE-TX Fast Ethernet switching module (WS-X4124-RJ45)</li> <li>• 24-port 100BASE-FX Fast Ethernet switching module (WS-X4124-FX-MT)</li> <li>• 48-port 100BASE-FX Fast Ethernet switching module (WS-X4148-FX-MT)</li> <li>• 48-port 100BASE-LX10 Fast Ethernet switching module (WS-X4148-FE-LX-MT)</li> <li>• 48-port 10/100-Mbps Fast Ethernet switching module (WS-X4148-RJ)</li> <li>• 48-port 100BASE-BX10-D Fast Ethernet switching module (WS-X4148-FE-BD-LC)</li> <li>• 48-port 10/100-Mbps Fast Ethernet switching module (WS-X4148-RJ21)</li> <li>• 48-port Cisco pre-standard Power over Ethernet (PoE) 10/100BASE-TX switching module (WS-X4148-RJ45V)</li> <li>• 24-port IEEE 802.3af-compliant PoE 10/100BASE-TX switching module (WS-X4224-RJ45V)</li> <li>• 48-port IEEE 802.3af compliant PoE 10/100BASE-TX RJ-45 switching module (WS-X4248-RJ45V)</li> <li>• 48-port 100BASE-X Fast Ethernet switching module (WS-X4248-FE-SFP)</li> <li>• 48 port IEEE 802.3af compliant PoE 10/100BASE-TX RJ-21 switching module (WS-X4248-RJ21V)</li> </ul>



**Table 1-2**      **Features of the Catalyst 4506 Switch (continued)**

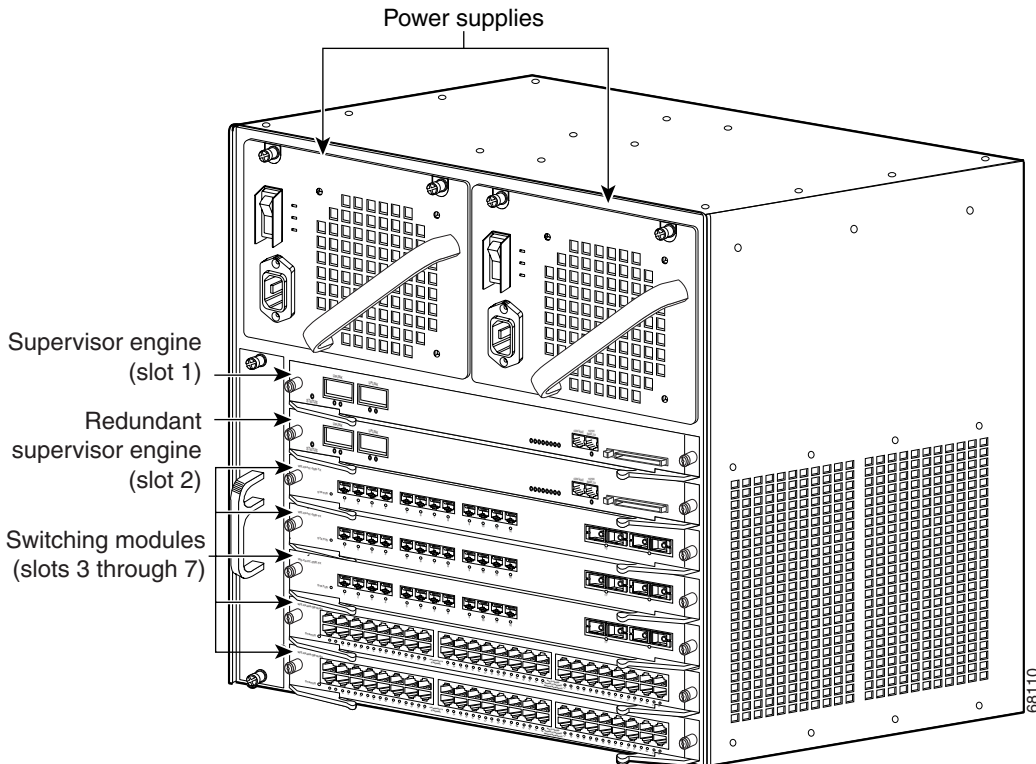
Feature	Description
Switching module support (continued)	<ul style="list-style-type: none"> <li>• 32-port 10/100-Mbps Fast Ethernet plus 2-port Gigabit Ethernet switching module (WS-X4232-GB-RJ)</li> <li>• 32-port 10/100-Mbps Fast Ethernet plus 2-port 1000BASE-X Layer 3 Gigabit Ethernet routing module (WS-X4232-L3)</li> <li>• 32-port 10/100-Mbps Fast Ethernet switching module with modular uplink support (WS-X4232-RJ-XX)</li> <li>• 2-port Gigabit Ethernet switching module (WS-X4302-GB)</li> <li>• 6-port 1000BASE-X Gigabit Ethernet switching module (WS-X4306-GB)</li> <li>• 6-port Gigabit Ethernet switching module (WS-X4506-GB-T)</li> <li>• 12-port 1000BASE-T plus 2-port 1000BASE-X Gigabit Ethernet switching module (WS-X4412-2GB-T)</li> <li>• 18-port Gigabit Ethernet switching module (WS-X4418-GB)</li> <li>• 24-port 10/100/1000BASE-T Gigabit Ethernet switching module (WS-X4424-GB-RJ45)</li> <li>• 48-port Gigabit Ethernet 1000 BASE LX (SPF) switching module (WS-X4448-GB-LX)</li> <li>• 48-port 10/100/1000BASE-T Gigabit Ethernet switching module (WS-X4448-GB-RJ45)</li> <li>• 24-port IEEE 802.3af-compliant PoE 10/100/1000BASE-T RJ-45 switching module (WS-X4524-GB-RJ45V)</li> <li>• 48-port 10/100/1000BASE-T Gigabit Ethernet switching module (WS-X4548-GB-RJ45)</li> <li>• 48-port Gigabit Ethernet switching module (WS-X4448-GB-SFP)</li> <li>• 48-port IEEE 802.3af compliant PoE 10/100/1000BASE-T Gigabit Ethernet switching module (WS-X4548-GB-RJ45V)</li> <li>• Access Gateway Module (WS-X4604-GWY)</li> <li>• Backplane channel module (WS-X4019)</li> </ul>

1. You will need to configure the 1400 W DC input current as appropriate for the model of switch. Refer to Appendix A, “Specifications.”

## Catalyst 4507R Switch Features

The Catalyst 4507R switch (see Figure 1-3) is a seven-slot switch designed for high-performance, high-density wiring closet applications.

Figure 1-3 Catalyst 4507R Switch (Front View)



The Catalyst 4507R switch supports the Supervisor Engine II+, II+10GE, IV, V, and V-10GE. The supervisor engine has two Gigabit Ethernet ports and a nonblocking, full-duplex, switching fabric that provides connections between the supervisor engine and the switching modules. The Gigabit Ethernet ports can be configured with any combination of copper 1000BASE-T, shortwave SX, LX/LH, and ZX interfaces, or CWDM and DWDM GBICs. For a description of GBICs, refer to the *Catalyst 4000 Series Module Installation Guide* or the *Catalyst 4500*

*Series Supervisor Engines and Switching Modules Installation Note.* Some supervisor engines use SFP modules for Gigabit Ethernet connections, or X2 modules for 10-Gigabit Ethernet connections. Refer to the installation note for your supervisor engine for more details on these modules.

Slot 1 is reserved for the supervisor engine only, which provides switching, local and remote management, and switch-status monitoring. Slot 2 is reserved for a redundant supervisor engine only. Slots 3 through 7 are available for switching modules.

Table 1-3 describes the features of the Catalyst 4507R switch.

**Table 1-3**      **Features of the Catalyst 4507R Switch**

Feature	Description
Ethernet speeds	<ul style="list-style-type: none"> <li>• Ethernet (10BASE-T) interface to workstations and repeaters</li> <li>• Fast Ethernet (100BASE-T) interface to workstations, servers, switches, and routers</li> </ul> <p><b>Note</b> Autonegotiation of link speed on each 10/100 port allows migration to 100BASE-T from a 10BASE-T installed base.</p> <ul style="list-style-type: none"> <li>• Gigabit Ethernet (1000BASE-T and 1000BASE-X) interfaces for backbone interconnection of high-performance switches and routers</li> <li>• 10-Gigabit Ethernet interfaces for backbone interconnection of high-performance switches and routers</li> </ul>
Standard equipment	<ul style="list-style-type: none"> <li>• Seven-slot modular chassis with one slot reserved for a supervisor engine, one slot reserved for a redundant supervisor engine, and five slots for switching modules</li> <li>• Two power supply bays</li> <li>• One hot-swappable fan assembly</li> </ul>
Power supplies	<ul style="list-style-type: none"> <li>• Can support a 1000 W, 1300 W, 1400 W, 2800 W, or 4200W AC-input power supply or a 1400 W DC-input single or triple-input power supply<sup>1</sup></li> <li>• Optional redundant power supply</li> </ul>

**Table 1-3**      **Features of the Catalyst 4507R Switch (continued)**

Feature	Description
Supervisor engine support	<ul style="list-style-type: none"> <li>• Supports the Supervisor Engine II, II+, II+10GE, III, IV, V, V-10GE</li> <li>• Holds the ASIC-based forwarding engine (data path) and the management processor and software (control path)</li> <li>• Features interface monitoring, environmental status, and SNMP and console/Telnet interface</li> </ul> <p><b>Note</b>    Packets are not forwarded while the module is removed; a system reboot occurs when a supervisor engine is reinserted.</p>
Switching module support	<ul style="list-style-type: none"> <li>• 32-port 10/100-Mbps Fast Ethernet plus 2-port Gigabit Ethernet switching module (WS-X4232-GB-RJ)</li> <li>• 32-port 10/100-Mbps Fast Ethernet plus 2-port 1000BASE-X Layer 3 Gigabit Ethernet routing module (WS-X4232-L3)</li> <li>• 32-port 10/100-Mbps Fast Ethernet switching module with modular uplink support (WS-X4232-RJ-XX) <ul style="list-style-type: none"> <li>– 4-port MT-RJ uplink module (WS-U4504-FX-MT) (optional)</li> </ul> </li> <li>• 2-port Gigabit Ethernet switching module (WS-X4302-GB)</li> <li>• 24-port 10/100BASE-TX Fast Ethernet switching module (WS-X4124-RJ45)</li> <li>• 24-port 100BASE-FX Fast Ethernet switching module (WS-X4124-FX-MT)</li> <li>• 48-port 100BASE-FX Fast Ethernet switching module (WS-X4148-FX-MT)</li> <li>• 48-port 100BASE-LX10 Fast Ethernet switching module (WS-X4148-FE-LX-MT)</li> <li>• 48-port 10/100-Mbps Fast Ethernet switching module (WS-X4148-RJ)</li> <li>• 48-port 100BASE-BX10-D Fast Ethernet switching module (WS-X4148-FE-BD-LC)</li> <li>• 48-port 10/100-Mbps Fast Ethernet switching module (WS-X4148-RJ21)</li> <li>• 48-port Cisco pre-standard Power over Ethernet (PoE) 10/100BASE-TX switching module (WS-X4148-RJ45V)</li> <li>• 48-port 100BASE-X Fast Ethernet switching module (WS-X4248-FE-SFP)</li> </ul>

**Table 1-3**      **Features of the Catalyst 4507R Switch (continued)**

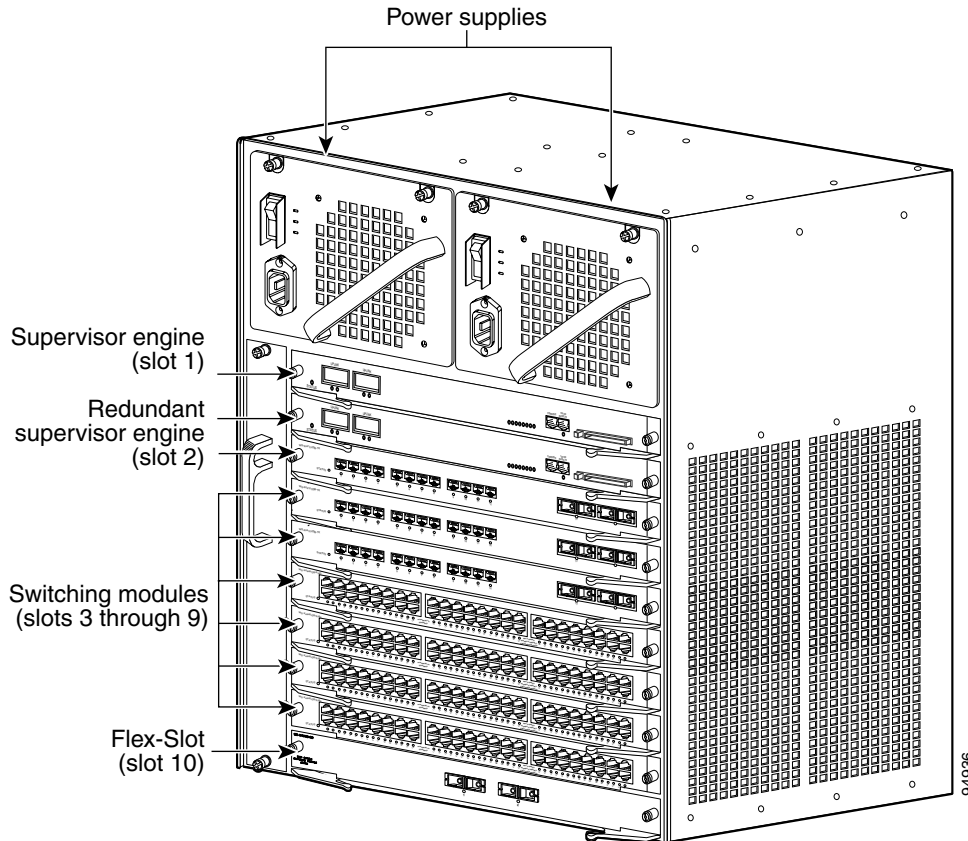
Feature	Description
Switching module support (continued)	<ul style="list-style-type: none"> <li>• 24-port IEEE 802.3af-compliant PoE 10/100BASE-TX switching module (WS-X4224-RJ45V)</li> <li>• 48-port IEEE 802.3af compliant PoE 10/100BASE-TX RJ-45 switching module (WS-X4248-RJ45V)</li> <li>• 48 port IEEE 802.3af compliant PoE 10/100BASE-TX RJ-21 switching module (WS-X4248-RJ21V)</li> <li>• 6-port 1000BASE-X Gigabit Ethernet switching module (WS-X4306-GB)</li> <li>• 6-port Gigabit Ethernet switching module (WS-X4506-GB-T)</li> <li>• 12-port 1000BASE-T plus 2-port 1000BASE-X Gigabit Ethernet switching module (WS-X4412-2GB-T)</li> <li>• 18-port Gigabit Ethernet switching module (WS-X4418-GB)</li> <li>• 24-port 10/100/1000BASE-T Gigabit Ethernet switching module (WS-X4424-GB-RJ45)</li> <li>• 48-port Gigabit Ethernet 1000 BASE LX (SPF) switching module (WS-X4448-GB-LX)</li> <li>• 48-port 10/100/1000BASE-T Gigabit Ethernet switching module (WS-X4448-GB-RJ45)</li> <li>• 24-port IEEE 802.3af-compliant PoE 10/100/1000BASE-T RJ-45 switching module (WS-X4524-GB-RJ45V)</li> <li>• 48-port 10/100/1000BASE-T Gigabit Ethernet switching module (WS-X4548-GB-RJ45)</li> <li>• 48-port Gigabit Ethernet switching module (WS-X4448-GB-SFP)</li> <li>• 48-port IEEE 802.3af compliant PoE 10/100/1000BASE-T Gigabit Ethernet switching module (WS-X4548-GB-RJ45V)</li> <li>• Access Gateway Module (WS-X4604-GWY)</li> </ul>

1. You will need to configure the 1400 W DC input current as appropriate for the model of switch. Refer to Appendix A, “Specifications.”

## Catalyst 4510R Switch Features

The Catalyst 4510R switch (see Figure 1-4) is a ten-slot switch designed for high-performance, high-density wiring closet applications.

Figure 1-4 Catalyst 4510R Switch (Front View)



The Catalyst 4510R switch supports the Supervisor Engine V and V-10GE. The supervisor engine has a nonblocking, full-duplex, switching fabric that provides connections between the supervisor engine and the switching modules. The Gigabit Ethernet ports can be configured with any combination of copper 1000BASE-T, shortwave SX, LX/LH, and ZX interfaces, or CWDM and DWDM GBICs. For a description of GBICs, refer to the *Catalyst 4500 Series Module*

*Installation Guide* or the *Catalyst 4500 Series Supervisor Engines and Switching Modules Installation Note*. Some supervisor engines use SFP modules for Gigabit Ethernet connections, or X2 modules for 10 Gigabit Ethernet connections. Refer to the installation note for your supervisor engine for more details on these modules.

Slot 1 is reserved for the supervisor engine only, which provides switching, local and remote management, and switch-status monitoring. Slot 2 is reserved for a redundant supervisor engine only. Slots 3 through 9 are available for switching modules. When using a Supervisor Engine V, slot 10 is a flex-slot for use with the 2-port Gigabit Ethernet switching module (WS-X4302-GB) or the Access Gateway Module (WS-X4604-GWY) only. When using a Supervisor Engine V-10GE, any supported module may be used in slot 10.

Table 1-4 describes the features of the Catalyst 4510R switch.

**Table 1-4 Features of the Catalyst 4510R Switch**

Feature	Description
Ethernet speeds	<ul style="list-style-type: none"> <li>• Ethernet (10BASE-T) interface to workstations and repeaters</li> <li>• Fast Ethernet (100BASE-T) interface to workstations, servers, switches, and routers</li> </ul> <p><b>Note</b> Autonegotiation of link speed on each 10/100 port allows migration to 100BASE-T from a 10BASE-T installed base.</p> <ul style="list-style-type: none"> <li>• Gigabit Ethernet (1000BASE-T and 1000BASE-X) interfaces for backbone interconnection of high-performance switches and routers</li> <li>• 10-Gigabit Ethernet interfaces for backbone interconnection of high-performance switches and routers</li> </ul>
Standard equipment	<ul style="list-style-type: none"> <li>• Ten-slot modular chassis with one slot reserved for a supervisor engine, one slot reserved for a redundant supervisor engine, and eight slots for switching modules</li> <li>• Two power supply bays</li> <li>• One hot-swappable fan assembly</li> </ul>
Power supplies	<ul style="list-style-type: none"> <li>• Can support a 1400 W, 2800 W, or 4200 W AC-input power supply or a 1400 W DC-input single or triple-input power supply<sup>1, 2</sup></li> <li>• Optional redundant power supply</li> </ul>

**Table 1-4**      **Features of the Catalyst 4510R Switch (continued)**

Feature	Description
Supervisor engine support	<ul style="list-style-type: none"> <li>• Supports the Supervisor Engine V and V-10GE</li> <li>• Holds the ASIC-based forwarding engine (data path) and the management processor and software (control path)</li> <li>• Features interface monitoring, environmental status, and SNMP and console/Telnet interface</li> </ul> <p><b>Note</b>    Packets are not forwarded while the module is removed; a system reboot occurs when a supervisor engine is reinserted.</p>
Switching module support	<ul style="list-style-type: none"> <li>• 24-port 10/100BASE-TX Fast Ethernet switching module (WS-X4124-RJ45)</li> <li>• 24-port 100BASE-FX Fast Ethernet switching module (WS-X4124-FX-MT)</li> <li>• 48-port 100BASE-FX Fast Ethernet switching module (WS-X4148-FX-MT)</li> <li>• 48-port 100BASE-LX10 Fast Ethernet switching module (WS-X4148-FE-LX-MT)</li> <li>• 48-port 10/100-Mbps Fast Ethernet switching module (WS-X4148-RJ)</li> <li>• 48-port 100BASE-BX10-D Fast Ethernet switching module (WS-X4148-FE-BD-LC)</li> <li>• 48-port 10/100-Mbps Fast Ethernet switching module (WS-X4148-RJ21)</li> <li>• 48-port Cisco pre-standard Power over Ethernet (PoE) 10/100BASE-TX switching module (WS-X4148-RJ45V)</li> <li>• 24-port IEEE 802.3af-compliant PoE 10/100BASE-TX switching module (WS-X4224-RJ45V)</li> <li>• 48-port IEEE 802.3af compliant PoE 10/100BASE-TX RJ-45 switching module (WS-X4248-RJ45V)</li> <li>• 48-port 100BASE-X Fast Ethernet switching module (WS-X4248-FE-SFP)</li> <li>• 48 port IEEE 802.3af compliant PoE 10/100BASE-TX RJ-21 switching module (WS-X4248-RJ21V)</li> <li>• 32-port 10/100-Mbps Fast Ethernet plus 2-port Gigabit Ethernet switching module (WS-X4232-GB-RJ)</li> <li>• 32-port 10/100-Mbps Fast Ethernet plus 2-port 1000BASE-X Layer 3 Gigabit Ethernet routing module (WS-X4232-L3)</li> </ul>



**Table 1-4**      **Features of the Catalyst 4510R Switch (continued)**

Feature	Description
Switching module support (continued)	<ul style="list-style-type: none"> <li>• 32-port 10/100-Mbps Fast Ethernet switching module with modular uplink support (WS-X4232-RJ-XX) <ul style="list-style-type: none"> <li>– 4-port MT-RJ uplink module (WS-U4504-FX-MT) (optional)</li> </ul> </li> <li>• 2-port Gigabit Ethernet switching module (WS-X4302-GB)</li> <li>• 6-port 1000BASE-X Gigabit Ethernet switching module (WS-X4306-GB)</li> <li>• 6-port Gigabit Ethernet switching module (WS-X4506-GB-T)</li> <li>• 12-port 1000BASE-T plus 2-port 1000BASE-X Gigabit Ethernet switching module (WS-X4412-2GB-T)</li> <li>• 18-port Gigabit Ethernet switching module (WS-X4418-GB)</li> <li>• 24-port 10/100/1000BASE-T Gigabit Ethernet switching module (WS-X4424-GB-RJ45)</li> <li>• 48-port Gigabit Ethernet 1000 BASE LX (SPF) switching module (WS-X4448-GB-LX)</li> <li>• 48-port 10/100/1000BASE-T Gigabit Ethernet switching module (WS-X4448-GB-RJ45)</li> <li>• 24-port IEEE 802.3af-compliant PoE 10/100/1000BASE-T RJ-45 switching module (WS-X4524-GB-RJ45V)</li> <li>• 48-port 10/100/1000BASE-T Gigabit Ethernet switching module (WS-X4548-GB-RJ45)</li> <li>• 48-port Gigabit Ethernet switching module (WS-X4448-GB-SFP)</li> <li>• 48-port IEEE 802.3af compliant PoE 10/100/1000BASE-T Gigabit Ethernet switching module (WS-X4548-GB-RJ45V)</li> <li>• Access Gateway Module (WS-X4604-GWY)</li> </ul>

1. You will need to configure the 1400 W DC input current as appropriate for the model of switch. Refer to Appendix A, “Specifications.”
2. The 1000 W AC and 1300 W AC power supplies for the Catalyst 4500 series will fit and function in a Catalyst 4510R; however, power management may be required in high-density configurations.

# Supervisor Engines

The following supervisor engines are available for the Catalyst 4500 series switches:

- Supervisor Engine II (WS-X4013) (Figure 1-5)
- Supervisor Engine II-Plus (WS-X4013+) (Figure 1-6)
- Supervisor Engine II-Plus TS (WS-X4013+TS) (Figure 1-7)
- Supervisor Engine II-Plus 10GE (WS-X4013+10GE) (Figure 1-8)
- Supervisor Engine III (WS-X4014) (Figure 1-9)
- Supervisor Engine IV (WS-X4515) (Figure 1-10)
- Supervisor Engine V (WS-X4516) (Figure 1-11)
- Supervisor Engine V-10GE (WS-X4516-10GE) (Figure 1-12)

The Catalyst 4500 series supervisor engines have the following features:

**Table 1-5 Supervisor Engine Features**

Feature	Description
Data path and control	Available on all network interfaces
Management functions	Interface monitoring Environmental status SNMP and console/Telnet interface
MAC addresses supported	32,768 per system (Cisco IOS only)
VLANS	Up to 4,096 VLANs with IEEE 802.1Q VLAN tagging on all ports and VLAN Trunking Protocol (VTP)
Port aggregation	PAgP <sup>1</sup> for 100-Mbps and 1000-Mbps EtherChannel
SNMP	Full implementation, including entity-MIB, all relevant standard MIBs, and all relevant Cisco MIBs
RMON	The first four groups (Ethernet statistics, Alarms, Events, and History) are on a per-port basis without an optional RMON processing module
SPAN <sup>2</sup>	Supported, which allows you to redirect traffic from any port or VLAN to a SPAN destination port
Performance management	Information provided

**Table 1-5 Supervisor Engine Features (continued)**

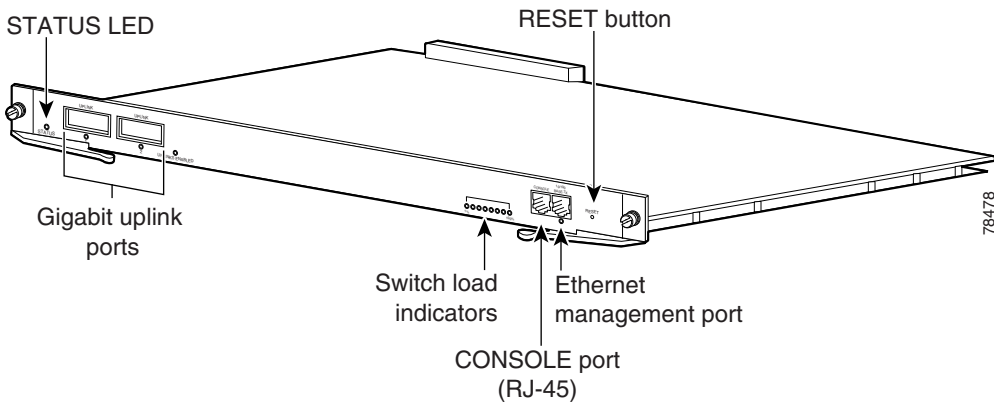
Feature	Description
Hot-swappable	Supported. On non-redundant systems, packets are not forwarded while the supervisor engine is removed, and a system reboot occurs when a supervisor engine is reinserted.
Gigabit Ethernet (using a GBIC or SFP)	Includes two (four on WS-X4516-10GE and WS-X4013+10GE) Gigabit Ethernet (1000BASE-X) interfaces for backbone interconnection of high-performance switches and routers
10-Gigabit Ethernet (WS-X4516-10GE and WS-X4013+10GE)	Includes two 10 Gigabit Ethernet interfaces for backbone interconnection of high-performance switches and routers
Forwarding	Layer 2, 3, and 4 forwarding (Cisco IOS only)
Supervisor Engine II	24-Gbps, 18 Mpps full-duplex Gigabit Ethernet switching engine
Supervisor Engine II-Plus	64 Gbps, 48 Mpps (with Catalyst 4506 and 4507R, or 28-Gbps, 21 Mpps with Catalyst 4503) full-duplex Gigabit Ethernet switching engine
Supervisor Engine II-Plus TS	64 Gbps, 48 Mpps (with Catalyst 4503 only) full-duplex Gigabit Ethernet switching engine
Supervisor Engine II-Plus 10GE	108 Gbps, 81 Mpps full-duplex Gigabit Ethernet switching engine
Supervisor Engine III	64 Gbps, 48 Mpps (with Catalyst 4506 and 4507R, or 28-Gbps, 21 Mpps with Catalyst 4503) full-duplex Gigabit Ethernet switching engine
Supervisor Engine IV	64 Gbps, 48 Mpps (with Catalyst 4506 and 4507R, or 28-Gbps, 21 Mpps with Catalyst 4503) full-duplex Gigabit Ethernet switching engine
Supervisor Engine V	96-Gbps, 72 Mpps (with Catalyst 4510R, 68 Gbps, 51 Mpps with Catalyst 4507R, 64 Gbps, 48 Mpps with Catalyst 4506, 28 Gbps, 21 Mpps with Catalyst 4503) full-duplex Gigabit Ethernet switching engine
Supervisor Engine V-10GE	136-Gbps, 101 Mpps (with Catalyst 4510R, 68 Gbps, 51 Mpps with Catalyst 4507R, 64 Gbps, 48 Mpps with Catalyst 4506, 28 Gbps, 21 Mpps with Catalyst 4503) full-duplex Gigabit Ethernet switching engine

1. PAgP = Port Aggregation Protocol
2. SPAN = switched port analyzer

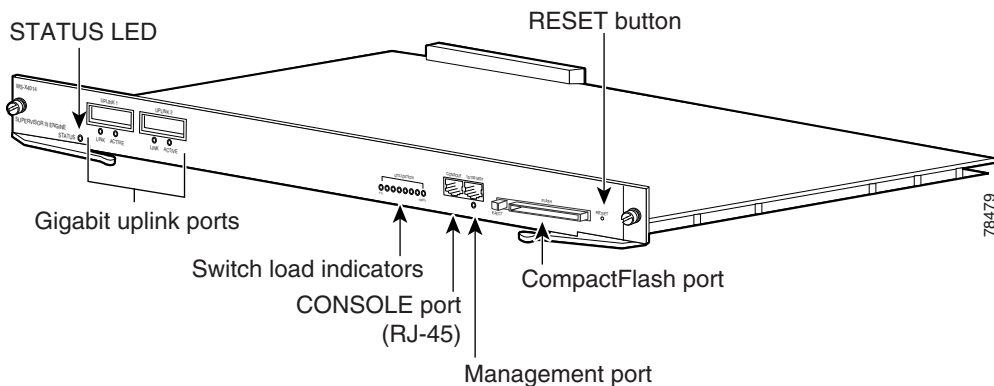
The Supervisor Engine IV and Supervisor Engine V support the Catalyst 4500 Series NetFlow Services Card (WS-F4531). The Supervisor Engine V-10GE supports NetFlow services without a NetFlow Services Card.

To install the supervisor engine, refer to the procedure in the *Catalyst 4500 Series Module Installation Guide*. The various supervisor engine models are shown in Figure 1-5 to Figure 1-12.

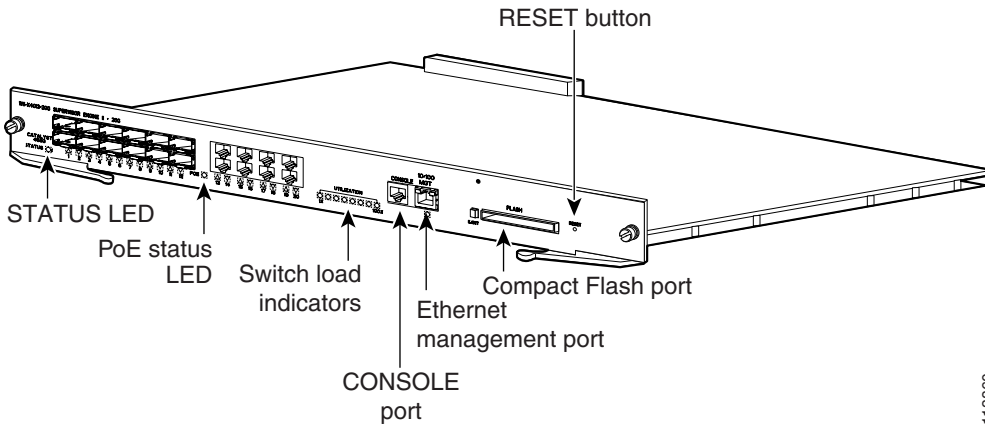
**Figure 1-5 Supervisor Engine II (WS-X4013)**



**Figure 1-6 Supervisor Engine II-Plus (WS-X4013+)**

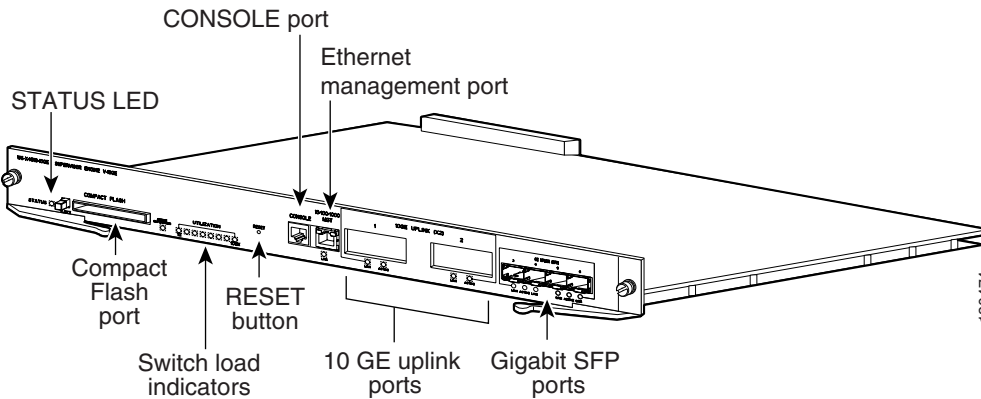


**Figure 1-7 Catalyst 4500 Series Supervisor Engine II-Plus TS (WS-X4013+TS)**



113860

**Figure 1-8 Supervisor Engine II-Plus 10GE (WS-X4013+10GE)**



120474

Figure 1-9 Supervisor Engine III (WS-X4014)

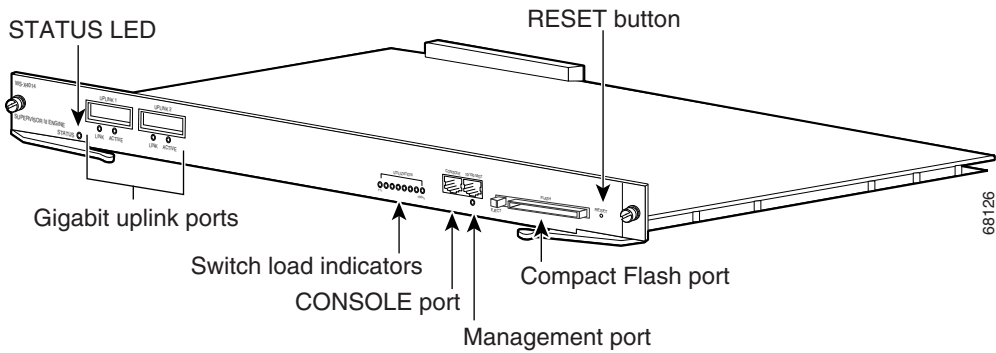


Figure 1-10 Supervisor Engine IV (WS-X4515)

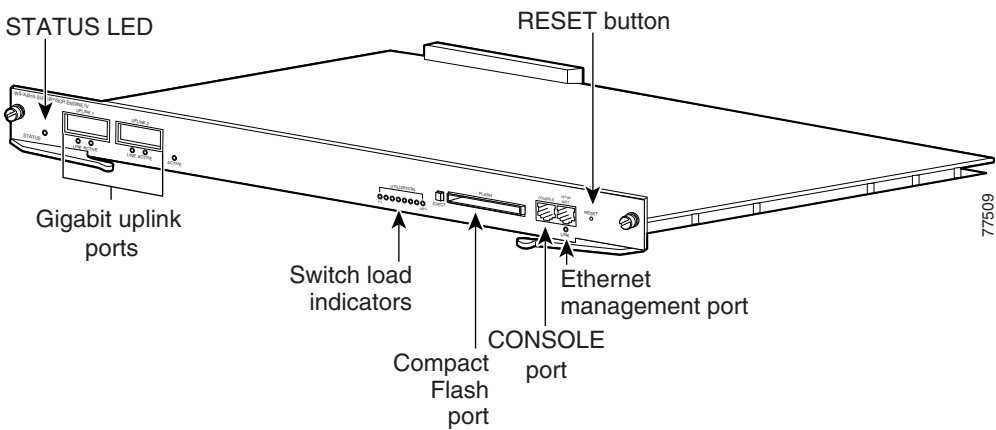


Figure 1-11 Supervisor Engine V (WS-X4516)

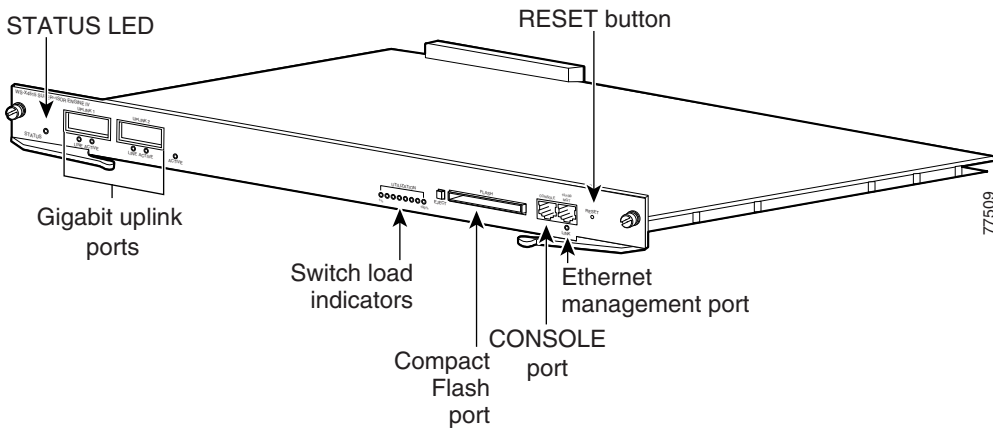
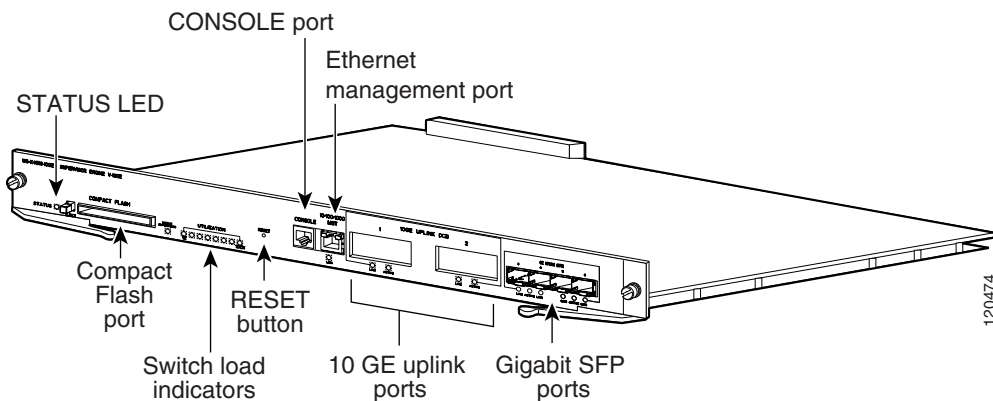


Figure 1-12 Supervisor Engine V-10GE (WS-X4516-10GE)



For information about the connectors, LEDs, and switches located on the front panel of the supervisor engine, see these sections:

- LEDs, page 1-24
- Gigabit Ethernet Uplink Ports, page 1-25
- 10/100BASE-T Port, page 1-26

- CONSOLE Port, page 1-26
- RESET Button, page 1-26
- CompactFlash Port, page 1-27

## LEDs

Table 1-6 describes the supervisor engine LEDs.

**Table 1-6** *Supervisor Engine LEDs*

LED	Color/State	Description
STATUS	Green	Indicates the results of a series of self-tests: All diagnostic tests passed.
	Red	A test failed.
	Orange	System boot or diagnostic test is in progress.
	Off	Module is disabled.
UTILIZATION	Green 1–100%	If the switch is operational, this display indicates the current traffic load over the backplane (as an approximate percentage).
LINK	Green	Indicates the status of the 10/100BASE-T port, 10/100/1000BASE-T or uplink ports: The link is operational.
	Orange	The link is disabled by user.
	Flashing orange	The power-on self-test indicates a faulty port.
	Off	No signal is detected or there is a link configuration failure.
ACTIVE	Green	Indicates whether the uplink port is active or not: The port is active.
	Off	The port is not active.
ACTIVE		The LED to the right of the uplink ports is only used in switches with two supervisors. The LED lights on the active supervisor.



## Gigabit Ethernet Uplink Ports

The Gigabit Ethernet uplink ports operate in full-duplex mode only. GBICs have SC connectors to interface with multimode fiber (MMF) and single-mode fiber (SMF) cable. For more information about GBICs, refer to the *Catalyst 4500 Series Module Installation Guide*.

When two Supervisor Engine Vs are present in a Catalyst 4507R and Catalyst 4510R, all four uplinks are active on both Primary (active) and Secondary (standby) supervisor engines by default, or two uplinks will be active in a nonredundant configuration. This limits access to slot 10 on the Catalyst 4510R to ports 3 and 4 only. You can only use the 2-port Gigabit Ethernet switching module (WS-X4302-GB) or the Access Gateway Module (WS-X4604-GWY) in slot 10 (flex-slot), when a Supervisor Engine V is used.

## 10-Gigabit Ethernet Uplink Ports

The 10-Gigabit Ethernet uplink ports operate in full-duplex mode only, and are only on the WS-X4516-10GE and WS-X4013+10GE. These ports use the hot-swappable 10GBASE X2 optical transceivers. The X2s have SC connectors to interface with multimode fiber (MMF) and single-mode fiber (SMF) cable.

On a Catalyst 4510R with a Supervisor Engine V-10GE, the user has the option to use either four Gigabit Ethernet uplinks using SFPs or two 10-Gigabit Ethernet uplinks using X2s. The user also has the option of using the Gigabit Ethernet and 10-Gigabit Ethernet uplinks simultaneously. With this option, the tenth slot can only support the WS-X4302-GB switching module. On a Catalyst 4507R, the user can use the Gigabit Ethernet uplinks and 10-Gigabit Ethernet uplinks simultaneously.

When two Supervisor Engine V-10GEs are present in a Catalyst 4510R or Catalyst 4507R switch, or two Supervisor Engine II-Plus 10GEs are present in a Catalyst 4507R, one X2 uplink is active on both the primary (active) and secondary (standby) supervisor engines by default, or two uplinks will be active in a nonredundant configuration.

## SFP Ports

Gigabit Ethernet SFP ports operate in full-duplex mode only and are present on the WS-X4013+TS, WS-X4516-10GE and WS-X4013+10GE supervisors, as well as some switching modules. These ports use the 1000BASE-SX, 1000BASE-LX, Cisco Coarse Wave Division Multiplexing (CWDM) SFPs, 1000BASE-T SFP, and 1000BASE-ZX SFP. SFP connectors vary with interface type and may use multimode fiber (MMF), single-mode fiber (SMF) cable, or copper Ethernet cables.

## 10/100BASE-T Port

The 10/100BASE-T port supports emergency image recovery. The 10/100BASE-T port supports image downloads from the ROMMON. You can use this feature when the onboard Flash memory does not contain any IOS images, usually after all images were accidentally deleted from onboard Flash.

## CONSOLE Port

The CONSOLE port has an EIA/TIA-232 RJ-45 connector. The CONSOLE port allows you to perform the following functions:

- Configure the switch from the CLI
- Monitor network statistics and errors
- Configure SNMP agent parameters

**Note**

---

EIA/TIA-232 was known as recommended standard RS-232 before its acceptance as a standard by the Electronic Industries Alliance (EIA) and Telecommunications Industry Association (TIA).

---

## RESET Button

The RESET button is used to restart the switch.

**Note**

---

Use a paper clip or other small, pointed object to press the Reset button.

---

## CompactFlash Port

The CompactFlash port accepts a Type 1 CompactFlash card. You can use it for file transfer tasks such as loading a new software image. The CompactFlash card is optional, and can be obtained from third-party suppliers.

For more information, refer to *Using the Compact Flash on the Catalyst 4000 Family Supervisor Engine III and IV* at the following URL:

[http://www.cisco.com/univercd/cc/td/doc/product/lan/cat4000/inst\\_nts/ol\\_2788.htm](http://www.cisco.com/univercd/cc/td/doc/product/lan/cat4000/inst_nts/ol_2788.htm)

## Fan Assembly

**Note**

---

For complete environmental specifications, including airflow requirements, see Appendix A, “Specifications.”

---

The system fan assembly provides cooling air for the internal chassis components. The fan assembly is a tray of fans that you can insert and remove from the chassis while the system is on line. The Catalyst 4503 fan assembly has two fans, the Catalyst 4506 fan assembly has four fans, the Catalyst 4507R fan assembly has six fans, and the Catalyst 4510R fan assembly has eight fans. The fans draw in fresh air from one side and exhaust air on the other side. Catalyst 4503 airflow is shown in Figure 1-13. Catalyst 4506 airflow is shown in Figure 1-14. Catalyst 4507R airflow is shown in Figure 1-15. Catalyst 4510R airflow is shown in Figure 1-16.

**Caution**

---

You must install module filler plates on unused switching module slots to ensure proper airflow.

---

Figure 1-13 Catalyst 4503 Airflow

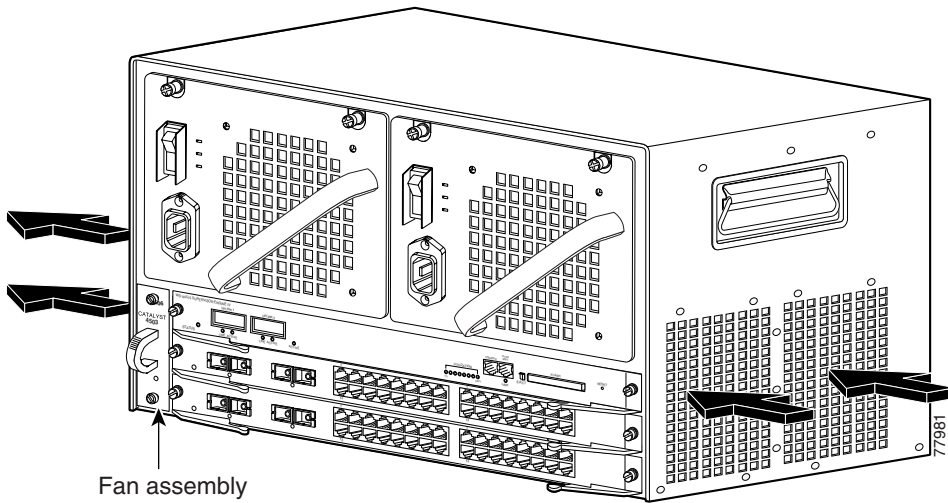


Figure 1-14 Catalyst 4506 Airflow

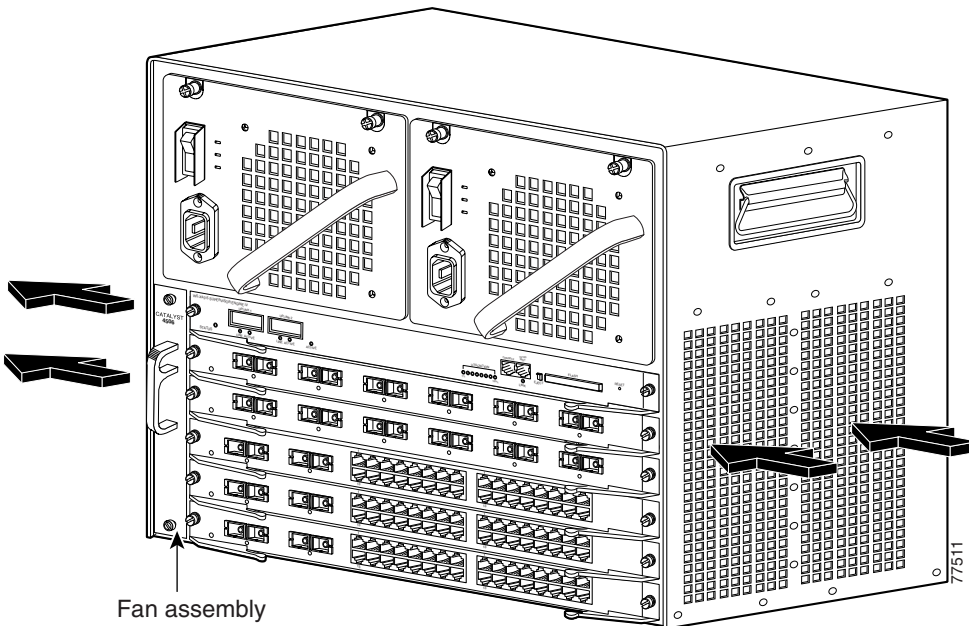


Figure 1-15 Catalyst 4507R Airflow

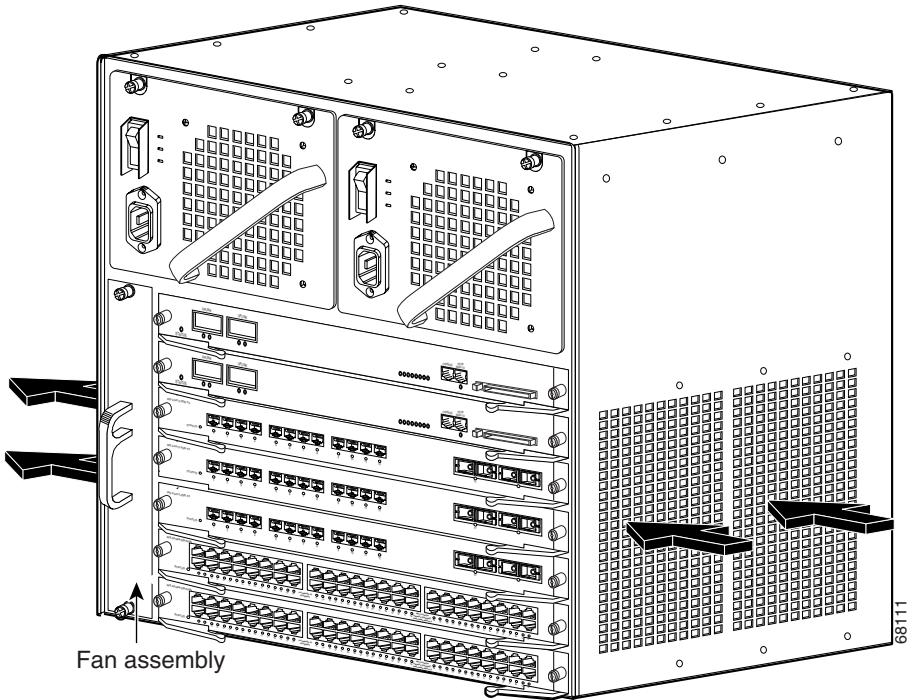
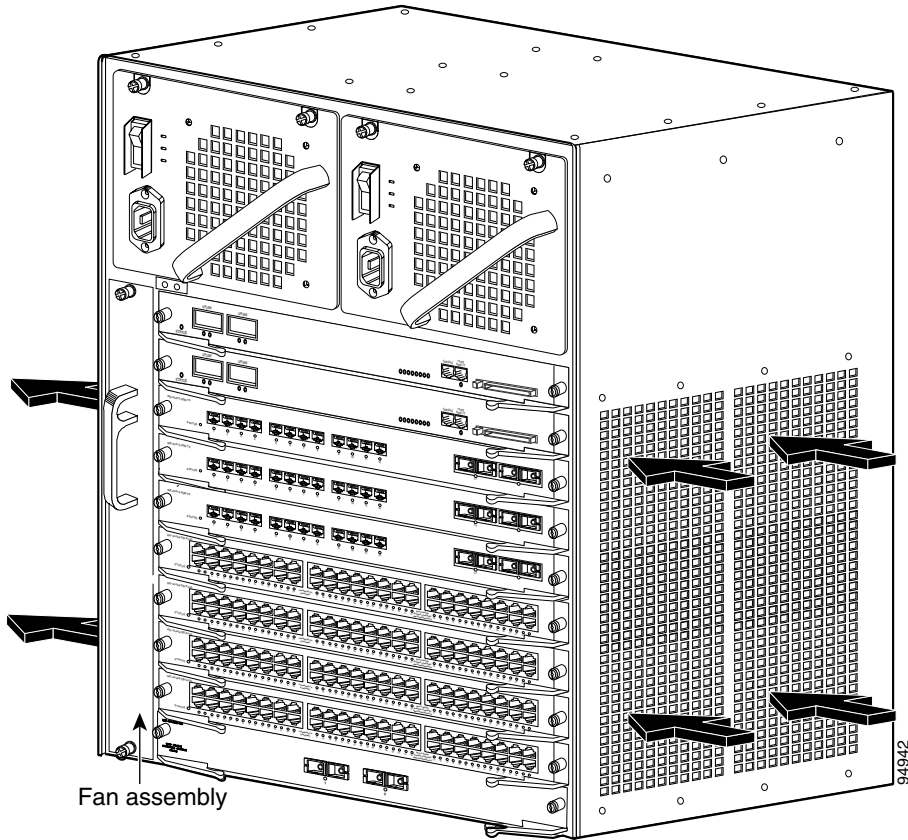


Figure 1-16 Catalyst 4510R Airflow



# Power Supplies

**Note**

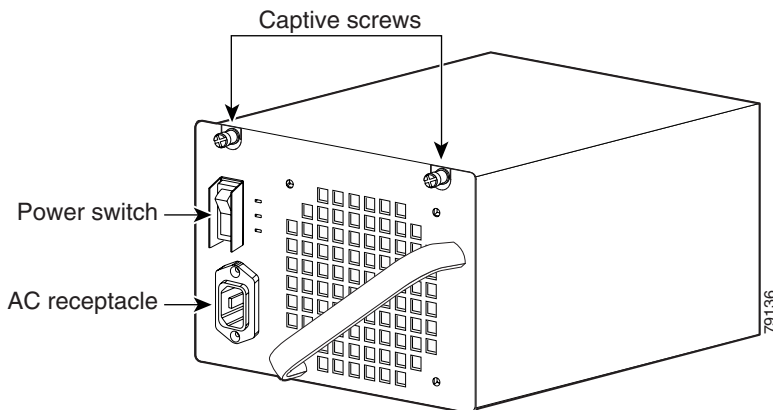
For detailed specifications on all Catalyst 4500 series power supplies, refer to the “Catalyst 4500 Series Power Supplies” section on page A-7.

A Catalyst 4500 series switch can use a 1000 W, 1300 W, 1400 W, 2800 W (see Figure 1-17), or 4200 W (with two inputs, see Figure 1-18) AC-input power supply, a 1400 W DC-input power supply with integrated PEM (see Figure 1-19), or a 1400 W DC multiple-input power supply (see Figure 1-20).

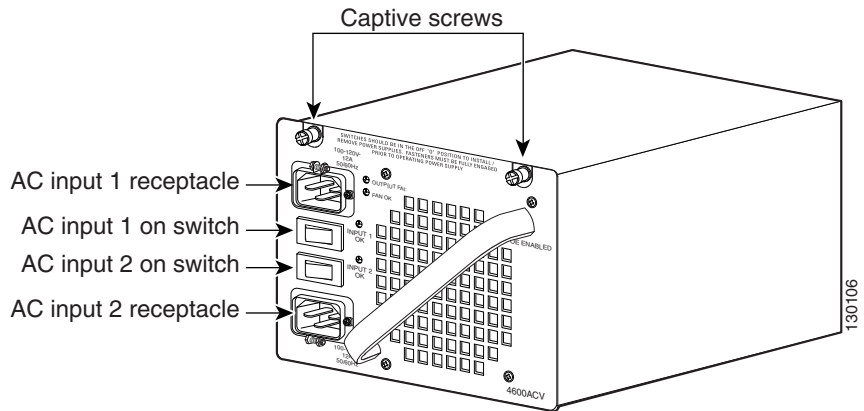
The AC-input power supply has a power cord that connects each power supply to the site power source. The DC-input power supply is equipped with an input terminal block that is directly connected to the site power wiring.

Each power supply has an ON/OFF switch that supplies power to the switch. For information on removing and replacing power supplies, see the “Removing and Replacing the Power Supply” section on page 4-2.

**Figure 1-17 AC-Input Power Supply (All Except 4200 W)**



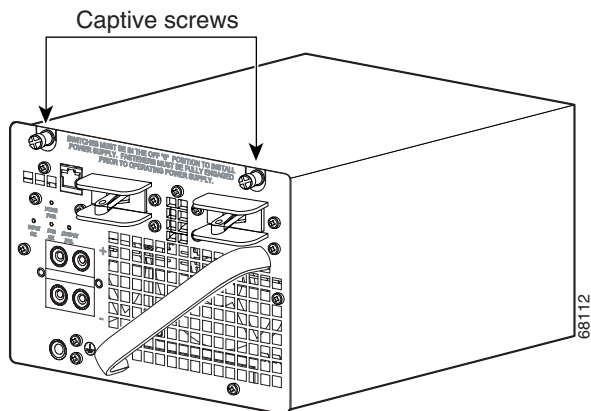
**Figure 1-18** 4200 W Dual Input AC Power Supply



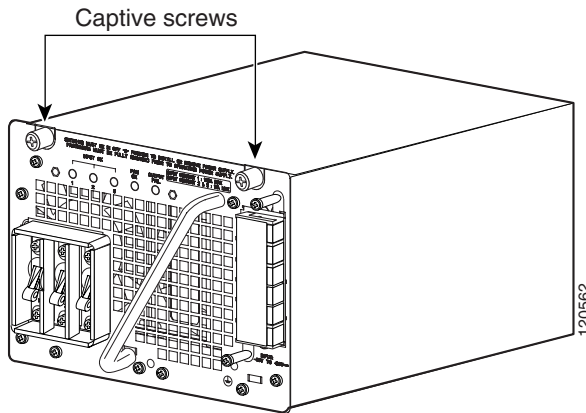
**Note**

The 4200 W AC power supply should not be used in mixed-voltage configurations. All the inputs in a chassis must be the same voltage (110 or 220 V).

**Figure 1-19** 1400 W DC-Input Power Supply





**Figure 1-20 1400 W DC Triple-Input Power Supply****Note**

The 1400 W DC triple-input power supply is not compatible with other power supplies used on these products, and can only be used with similar supplies. In redundant mode, the two power supplies must have identical inputs.

The 1400 W DC input power supply (either single or triple-input) may be used with the Catalyst 4500 Series AC Power Shelf. Documentation for the Catalyst 4500 Series AC Power Shelf is at [http://www.cisco.com/univercd/cc/td/doc/product/lan/cat4000/inst\\_nts/78\\_15068.htm](http://www.cisco.com/univercd/cc/td/doc/product/lan/cat4000/inst_nts/78_15068.htm)

Catalyst 4500 series switches support one power supply and an optional redundant power supply. Each AC power supply has an individual power cord and status LEDs. Systems with redundant power supplies will share the load, with each unit providing approximately one-half of the total load. For information about configuring your switch for redundant and combined modes, refer to the software configuration guide for your switch.

The Catalyst 4510R requires at least 1400 W of input power. (The 1000 W AC and 1300 W AC power supplies for the Catalyst 4500 series will fit and function in a Catalyst 4510R; however, power management may be required in high density configurations.) Cisco recommends the use of the 1400 W DC, 1400 W AC, and 2800 W AC power supplies for the Catalyst 4510R.

When power is removed from one power supply on a Catalyst 4500 series switch that has two power supplies, the redundant power feature causes the second power supply to produce full power.

To replace a power supply, see the “Removing and Replacing the Power Supply” section on page 4-2.

## Power Supply LEDs

Table 1-7 describes the power supply LEDs.

**Table 1-7** Power Supply LEDs

LED	Color/State	Description
INPUT OK	Green	Indicates whether the input voltage is within the required range: Input voltage is within the required range.
	Flashing	Input voltage is present, but is below required range.
	Off	Input voltage is below the required range or the power supply is off.
OUTPUT FAIL	Red	Output voltage is not within the specified range.
	Off	Output voltage is within the specified range.
FAN OK	Green	Indicates the status of the power supply fans: The fans are operational.
	Off	The fans are not operational.
In-line PWR (for 1400 W DC single input power supplies)	Green	-48 V passthru output voltage is enabled and is greater than -39 V and less than -60 V.
	Off	Indicates any of the following: <ul style="list-style-type: none"> <li>• Passthrough breakers are not enabled.</li> <li>• DC input is less than -40.5 V.</li> <li>• One or more -48 V outputs is less than -39 V.</li> </ul>
	Amber	Passthru breakers are enabled and input voltage exceeds -60 V.

## Power Supply Fan

Each power supply has a built-in fan. Air enters the front of the power supply (power-input end) and exits through the back. An air dam keeps the airflow separate from the rest of the chassis, which is cooled by the system fan assembly.

## Load-Sharing Feature

When you install and turn on a second power supply on a Catalyst 4500 series switch, it provides approximately one-half of the required power to the system. If one power supply fails, the other power supply immediately assumes full power to maintain uninterrupted system operation.

**Note**

---

Load sharing works only when both power supplies in the chassis are the same type.

---

When you install a redundant power supply, load sharing and fault tolerance are enabled automatically; no additional software configuration is required.

## Environmental Monitoring Feature

With the environmental monitoring and reporting feature, you can keep your system running by resolving adverse environmental conditions before loss of operation.

The power supply monitors its own internal temperature and voltages. In the event of excessive internal temperature, the power supply shuts down to prevent damage. When the power supply returns to a safe operating temperature, it restarts. If the power supply output voltage is not within the specified range, the LED labeled OUTPUT FAIL will light. An instance of substantial output overvoltage can shut down the power supply.

An instance of substantial input overvoltage (greater than  $-75$  V DC continuous) can damage the power supply input circuitry and can cause it to shut down permanently.

For a 1400 W DC power supply, the main power switch has an input range of  $-40.5$  to  $-72$  V DC, while the  $-48$  V PoE operates over a range of  $-40.5$  to  $-56$  V DC. The PoE either fails to start or shuts down if exposed to greater than  $-56$  V DC input. PoE recovers after you recycle input power within the proper voltage range. If the PoE shuts down due to input overvoltage (greater than  $-56$  V DC), the main converter section does not shut down.

The supervisor engine monitors the status of each power supply and provides a status report through the switch software. For more details on how the supervisor engine monitors the power supplies, refer to the “Environmental Monitoring and Power Management” chapter of the *Catalyst 4500 Series Switch Cisco IOS Software Configuration Guide*.

## 1400 W DC Triple-input Power Supply Operational Modes

The C4500 1400 W DC Triple Input SP Power Supply (data only) allows added redundancy by providing terminals for two DC inputs rated at 15 A and one rated at 12.5 A per power supply.

This power supply has five operational modes depending on the inputs receiving power. When all three inputs are active, at input voltages greater than  $-44.0$  V DC, the power supply delivers 1400 W maximum total output. Table 1-8 provides output information for these modes, given a single supply.

**Table 1-8**      **Input Modes**

Input Mode	Input Number	Input Configuration	Maximum Total Output Power
1	1	1 x 12.5 A	386 W @ $-40.5$ V DC 412 W @ $-44.0$ V DC
2	2 OR 3	1 x 15 A	466 W @ $-40.5$ V DC 495 W @ $-44.0$ V DC
3	1, 2 OR 3	1 x 12.5 A and 1 x 15 A	845 W @ $-40.5$ V DC 908 W @ $-44.0$ V DC
4	2, 3	2 x 15A	914 W @ $-40.5$ V DC 990 W @ $-44.0$ V DC
5	1, 2, 3	1 x 12.5A and 2 x 15 A	1294 W @ $-40.5$ V DC 1400 W @ $-44.0$ V DC

The maximum total input current is 42.5A and the maximum ambient temperature is 55 C. To determine total maximum input power to a supply, add up the active individual module input power ratings. Table 1-9 provides output information for these modes, given two supplies working in combined mode. Table 1-10 provides output information for these modes, given two supplies working in redundant mode.

**Table 1-9 Combined Mode Power Supply Configuration  
(2450 W Max Output Power)**

Input Number	Maximum Input Current	Maximum Input Power @ -44 V DC
1	12.5 A @ -44 V DC	550 W
2	15 A @ -44 V DC	660 W
3	15 A @ -44 V DC	660 W

**Table 1-10 Dual Redundant Mode Power Supply Configuration  
(1400 W Max Output Power)**

Input Number	Approximate Input Current	Approximate Input Power @ -40.5 V DC	Approximate Input Power @ -44 V DC
1	6.25 A @ -40.5 / -44 V DC	253 W	275 W
2	7.5 A @ -40.5 / -44 V DC	304 W	330 W
3	7.5 A @ -40.5 / -44 V DC	304 W	330 W



**Note**

In a redundant configuration with all inputs supplied, there must be a 100 W minimum system load or the OUTPUT FAIL LED shows a false failure.

The C4500 1400 W DC Triple Input SP Power Supply requires a minimum draw from the system that it is installed in. Table 1-11 shows

Table 1-11 Minimum Load Table

	PSU1			PSU2			12V Minimum Load	3.3V Minimum Load
	Input 1	Input 2	Input 3	Input 1	Input 2	Input 3		
<b>Single Operation</b>								
Mode 1	ON	OFF	OFF	–	–	–	1.33A	0.6A
Mode 2	OFF	ON	OFF	–	–	–	1.33A	0.6A
	OFF	OFF	ON	–	–	–	1.33A	0.6A
Mode 3	ON	ON	OFF	–	–	–	2.66A	0.6A
	ON	OFF	ON	–	–	–	2.66A	0.6A
Mode 4	OFF	ON	ON	–	–	–	2.66A	0.6A
Mode 5	ON	ON	ON	–	–	–	4A	0.6A

**Table 1-11 Minimum Load Table (continued)**

	PSU1			PSU2				
	Input 1	Input 2	Input 3	Input 1	Input 2	Input 3	12V Minimum Load	3.3V Minimum Load
<b>Dual Redundant Operation</b>								
Mode 1	ON	OFF	OFF	ON	OFF	OFF	2.66A	1.2A
Mode 2	OFF	ON	OFF	OFF	ON	OFF	2.66A	1.2A
	OFF	OFF	ON	OFF	OFF	ON	2.66A	1.2A
Mode 3	ON	ON	OFF	ON	ON	OFF	5.32A	1.2A
	ON	OFF	ON	ON	OFF	ON	5.32A	1.2A
Mode 4	OFF	ON	ON	OFF	ON	ON	5.32A	1.2A
Mode 5	ON	ON	ON	ON	ON	ON	8A	1.2A

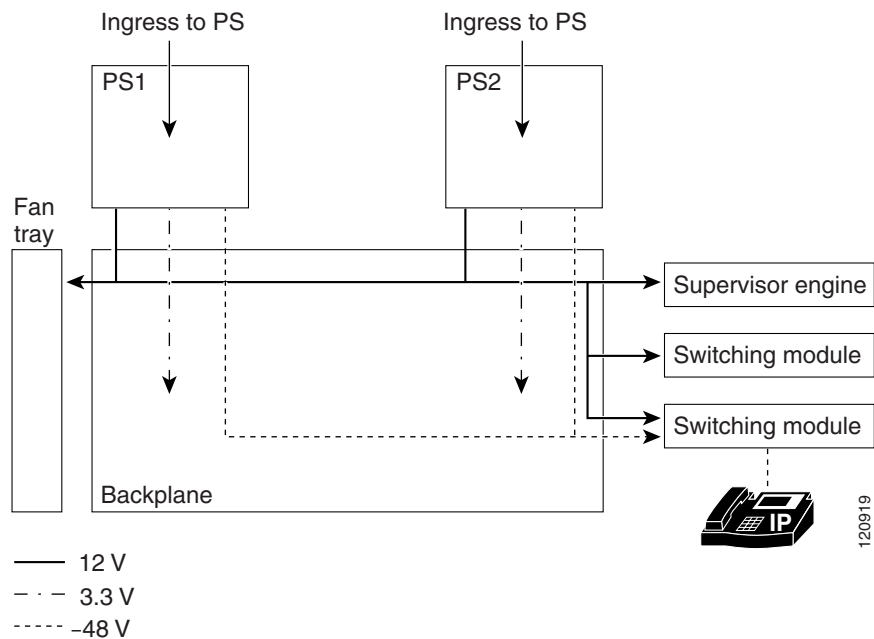
# System Architecture

This section describes the interaction between the various system components of Catalyst 4500 series switches. A Catalyst 4503 only is shown in the examples.

## Power Flow

Figure 1-21 shows power ingress and flow through the system.

**Figure 1-21 Power Flow**



Power enters the switch through the power supplies. Several types of power supplies are available, depending on the power needs for your system and the power type available on your site. All power supplies provide a 3.3 V circuit (shown as a dash-dot line) to the components on the backplane and a 12 V circuit (shown as a solid line) that is carried over the backplane to the fans, supervisor engine, and switching modules. Power supplies that support PoE (1300 W AC,



2800 W AC, 4200 W AC or 1400 W DC) also provide a –48 V circuit (shown as a dashed line) to PoE-enabled switching modules, which is then available to the powered device connected to the switching module.

**Note**

---

The Supervisor Engine II-Plus TS has internal DC-to-DC converters that use the 12 V circuit to provide PoE to powered devices connected to the Supervisor engine only. If your system has a Supervisor Engine II-Plus TS in slot 1, you still need a PoE-enabled power supply to provide PoE to the other slots.

---

All Catalyst 4500 series switches support dual power supplies, configurable as combined mode or redundant mode. In combined mode, the switch has available the combined rated wattage of both power supplies, less some expected efficiency loss. In redundant mode, one power supply provides power to the system and the other supply is on standby should there be a failure in either the power supply or the input voltage source it is connected to.

## Power over Ethernet

The Cisco Catalyst 4500 Series switches support the Cisco pre-standard and 802.3af standard for PoE on 10/100 or 10/100/1000 ports, enabling customers to support telephones, wireless base stations, video cameras, and other appliances. PoE makes it possible to place devices in unique locations without having to provide new outlets and costly electrical circuits. PoE also enables businesses to isolate critical devices on a single power system so that the entire system can be supported by uninterruptable power supply (UPS) backup.

All new Cisco Catalyst PoE line cards can support 15.4 W of power per port simultaneously. Not only do the cards support the IEEE standard, including the optional power classifications, but the Cisco pre-standard power implementation is also supported to help ensure backward compatibility with existing Cisco powered devices. The cards are compatible with any chassis and supervisor engine. Most importantly, the Catalyst 4500 series switch has the power supplies and accessories to support 15.4 W per port on every port simultaneously in any fully loaded chassis. (This requires an external power shelf or a 4200 W dual-input power supply.)

## PoE Over-subscription

With the advent of powered devices requiring as much as 15.4 W and the different combinations of power supplies and chassis port densities, it becomes quite possible to over-subscribe the PoE capacity of the power supplies. This temporary over-subscription typically occurs when a power supply configured in combined mode fails or when the user has not kept track of the powered devices and plugs in one too many. The best practice is to design a PoE system in which all devices receive the power needed at all times. When a power supply is over-subscribed—more power is being drawn from it than it can supply—the power supply shuts down. There are several ways to predictably manage a temporary PoE over-subscription:

1. Configure unused ports to never receive PoE. This prevents a user from inadvertently plugging a powered device into a port and causing problems for other powered devices.
2. Configure ports to be in static mode. This is for ports that have highest priority, such as phones for executives or wireless access points. If ports need to be disabled because of a power shortage, auto ports are disabled before static ports.
3. Configure the maximum wattage on ports to be less than the default, based on the maximum power consumption of the powered device. This disallows devices demanding unexpected amounts of power and also stretches the finite resources of the power supplies. For example, the default port wattage is 15.4 W. By configuring a maximum of 7 W, twice as many PoE powered devices can be supported with the same power supply.

## PoE Line Cards

The Cisco Catalyst 4500 series offers line cards, power supplies, and accessories required to deploy and operate a standards-based PoE internetwork. PoE provides –48 V DC power over standard Category 5 unshielded twisted-pair (UTP) cable up to 100 meters when an IEEE 802.3af-compliant or Cisco pre-standard powered device is attached to the PoE line card port. Instead of requiring wall power, attached devices such as IP phones, wireless base stations, video cameras, and other IEEE-compliant appliances can use power provided by the PoE line cards. This capability gives network administrators centralized control over power and eliminates the need to install outlets in ceilings and other out-of-the-way places where a powered device may be installed.

Although references to “PoE,” “inline-power,” and “voice” power supplies and line cards are synonymous, there are only two versions: Cisco prestandard and IEEE 802.3af compliant. Every Cisco Catalyst 4500 series chassis and PoE power supply supports the IEEE 802.3af standard and the Cisco prestandard power implementation ensuring backward compatibility with existing Cisco powered devices. All IEEE 802.3af-compliant line cards can distinguish an IEEE or Cisco prestandard powered device from an unpowered network interface card (NIC), ensuring that power is applied only when an appropriate device is connected.

All PoE line cards can distinguish an IEEE or Cisco prestandard powered device from an unpowered network interface card (NIC) to ensure power is applied only when an appropriate device is connected. With a Cisco PoE network, administrators can depend on a robust network that is safe to deploy and simple to maintain.

## Deploying PoE on the Cisco Catalyst 4500 Series

When the switch is properly configured, implementing PoE is easy when it is used with a Cisco powered device that supports Cisco Discovery Protocol. All PoE line cards automatically detect an attached powered device the moment it is installed. Also, the switch returns unused port power to the system power budget for use by other devices because it supports the IEEE802.3af optional power classifications.

The Cisco Catalyst 4500 series offers internal power supplies and external power devices for multiple deployment scenarios. These scenarios include small and large deployments in AC or DC environments for data-only configurations, and scalability of up to 15.4 W per port for PoE configurations.

The switches share a common power supply form factor. Each Cisco Catalyst 4500 Series chassis is designed for 1 + 1 power protection while meeting the needs of PoE demands. In addition to power resiliency, the Cisco Catalyst 4500 Series includes 1 + 1 supervisor-engine redundancy (Cisco Catalyst 4507R and Catalyst 4510R only) and software-based fault tolerance. Integrated resiliency in both hardware and software minimizes network downtime, helping ensure workforce productivity, portability, and customer success.

All available Cisco Catalyst 4500 Series power supplies can be used for data-only deployments, which typically require just a few hundred watts. For deployments that dictate support for PoE power, Cisco offers several options.

The Cisco Catalyst 4500 Series offers several internal supplies: 1000 W AC (data only), 1400 W AC (data only), 1300 W (data and PoE), 1400 W DC (data and PoE), 2800 W (data and PoE), and 4200 W AC (data and PoE). When more than

4200 W of redundant data and PoE are required for a Cisco Catalyst 4500 Series chassis in an AC-powered environment, Cisco offers an external AC power shelf that houses two 2500 W AC power supplies. When two power shelves are combined, they can produce 7500 W—the remaining 2500 W supply can be used for N + 1 protection.

The Cisco Catalyst 4500 Series has two DC power options; one is optimized for data-only deployments in service provider central offices (part number PWR-C45-1400DC), and the other is used for high-power PoE deployments (part number PWR-C45-1400DC-P).

### **Cisco Catalyst 4500 Series External AC Power Shelf and 1400 W DC Power Supply with Integrated Power Entry Module**

The external AC power shelf must be used in conjunction with the 1400 W DC power supply. In addition to providing power for the chassis, fans, and non-PoE line cards, the 1400 W DC power supply contains a power entry module (PEM). The PEM is used to pass additional power to the chassis backplane, power demanded by the PoE line cards. The chassis power trace used for PoE is independent from the one used by the supervisor engine(s), fan tray, and backplane components. The 1400 W DC power supply can accept up to 7500 W DC for data and PoE applications. Up to 1400 W can be dedicated for data (supervisor engine, fan tray, etc.), while the remaining power is passed through via the PEM and is used for PoE.

When only one external AC power shelf is used (with two 2500 W AC power supplies), it provides the 1400 W DC power supply with 5000 W of DC power in total. When two AC power shelves are strapped together, the switch can provide up to 7500 W of DC power (3 + 1 redundant).

### **Cisco Catalyst 4500 Series Service Provider DC Power Supply**

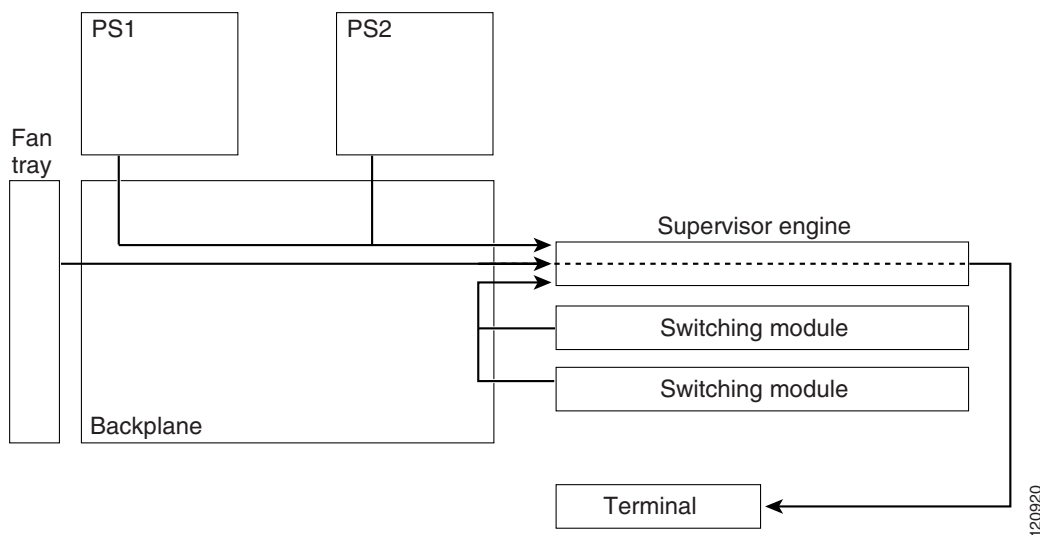
The triple-input 1400 W DC power supply is optimized for service provider or central-office deployments. By providing multiple inputs, the service provider DC power supply enables central-office technicians to customize the output power to meet their application needs. Many central-office deployments require only a fraction of the 1400 W available in the service provider power supply. Low current inputs mean technicians can connect the supply to smaller fuses and breakers. The service provider power supply makes it possible to deploy a Cisco Catalyst 4503

with a single 15A circuit. Likewise, it is possible to deploy a fully populated Cisco Catalyst 4510R with two 20A and one 15A circuits rather than a single 60A connection, which often requires rack rewiring.

## Management Flow

Figure 1-22 shows management and status information flow through the system.

**Figure 1-22 Management Flow**



Each system component has an EEPROM that identifies it to the supervisor engine over a serial connection on the backplane, which also passes along information like temperature, fan speed, power draw per slot and port, and port activity. LED status information is also sent to the supervisor engine, which makes it available to an administrator through a terminal connection or management software.

All Catalyst 4500 series switches support:

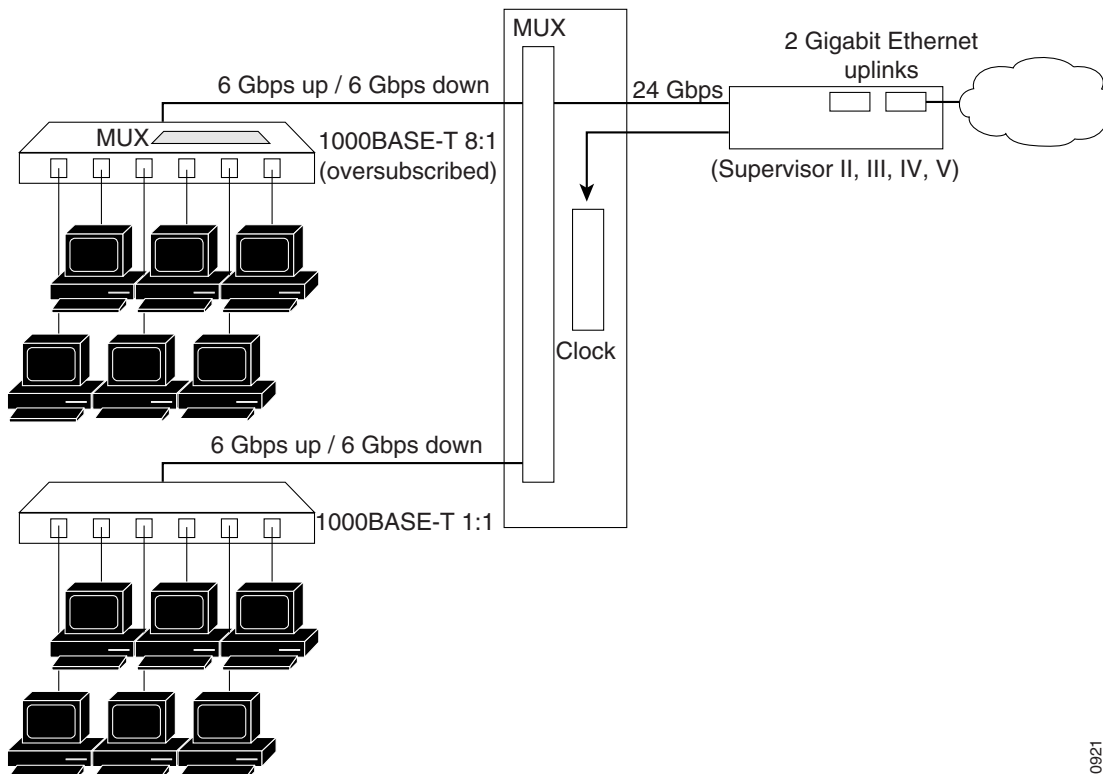
- Hardware-based multicast-Protocol Independent Multicast (PIM).
- Internet Group Management Protocol (IGMP).

- Cisco Group Management Protocol support standards-based and Cisco technology-enhanced efficient multimedia networking.
- Simple Network Management Protocol (SNMP).
- CiscoWorks, which can manage critical network characteristics such as availability, responsiveness, resilience, and security.
- Cisco NetFlow Services. The Cisco NetFlow Services Card for the Supervisor Engine IV and V support statistics capture in hardware for flow-based and VLAN-based statistics monitoring. This data can be exported, collected, and analyzed for virus detection and mitigation, network-traffic accounting, usage-based network billing, network planning, network monitoring, and data-mining capabilities. Cisco NetFlow Services is integral to the Supervisor Engine V-10GE.

## Switching Traffic Flow

Figure 1-23 shows switching traffic flow through the system.

Figure 1-23 Switching Traffic Flow



120921

Frames flow into the switch through interfaces on the switching modules. Each switching module connects to a mux/buffer on the backplane that supports a connection of up to 6 Gbps up (Tx) to the supervisor engine and 6 Gbps from (Rx) the supervisor engine. When a frame reaches the supervisor engine, it is examined and either sent out of an interface in one of the other slots, or out of the uplink on the supervisor engine.

## Over-subscription

Switching modules that have 24 or 48 Gigabit Ethernet (1000BASE-T) ports over-subscribe on a Catalyst 4500 switch by grouping the ports with an additional mux/buffer on the switching module, which creates a single, nonblocking, full-duplex Gigabit Ethernet connection to the internal switch fabric. For each group of ports, frames received are buffered and sent to the common Gigabit

Ethernet link to the internal switch fabric. If the amount of data received for a port begins to exceed buffer capacity, flow control sends pause frames to the remote port to temporarily stop traffic and prevent frame loss.

Each port in the group shares the bandwidth of a Gigabit Ethernet link. However, each port operates independently so that flow control, or configuration of one port, does not block or degrade the performance of another port in that group. Switching modules that have up to six 1000BASE-T ports do not use over-subscription.

The amount of over-subscription can be controlled by varying the number of ports used at 1000 Mbps. All ports can use Cisco Gigabit EtherChannel technology or IEEE 802.3ad for high-speed interconnection applications. All over-subscribed ports use the standard IEEE 802.1x flow control (PAUSE frame) mechanism to control Gigabit Ethernet host traffic.

## Supervisor Redundancy

The Cisco Catalyst 4507R and Catalyst 4510R switches support 1+1 supervisor-engine redundancy for integrated resiliency. Redundant supervisor engines help minimize network downtime. With the support of stateful switchover (SSO), the secondary supervisor engine serves as a backup to immediately take over after a primary supervisor failure. During the switchover, Layer 2 links are maintained transparently without the need to renegotiate sessions. As a result, business-critical applications such as Voice-over-IP (VoIP) calls are not dropped. The Nonstop Forwarding (NSF) Aware feature in Cisco IOS software is also supported, providing the ability to interface with NSF-capable devices and to continue forwarding packets as routing information is updated upon a supervisor-engine switchover.





## Preparing for Installation

---



**Warning**

---

**This unit is intended for installation in restricted access areas. A restricted access area can be accessed only through the use of a special tool, lock and key, or other means of security.** Statement 1017

---



**Warning**

---

**Only trained and qualified personnel should be allowed to install, replace, or service this equipment.** Statement 1030

---



**Warning**

---

**This equipment must be grounded. Never defeat the ground conductor or operate the equipment in the absence of a suitably installed ground conductor. Contact the appropriate electrical inspection authority or an electrician if you are uncertain that suitable grounding is available.** Statement 1024

---



**Warning**

---

**Class 1 laser product.** Statement 1008

---

If you will be using your switch as a PoE source, the following warning applies:

**Warning**

---

**Voltages that present a shock hazard can exist on inline power circuits if interconnections are made by using uninsulated exposed metal contacts, conductors, or terminals. Avoid using such interconnection methods unless the exposed metal parts are in a restricted access location and users and service people who are authorized to access the location are made aware of the hazard. A restricted access area can be accessed only through the use of a special tool, lock and key, or other means of security.** Statement 1072

---

This chapter describes how to prepare your site for the installation of the switch. The information is presented in these sections:

- Electrostatic Discharge, page 2-2
- Site Power Requirements and Heat Dissipation, page 2-4
- Power Connection Guidelines for AC-Powered Systems, page 2-5
- Site-Planning Checklist, page 2-16

**Note**

---

See the Site-Planning Checklist at the end of this chapter to help ensure that you complete all site-planning activities before you install the switch.

---

## Electrostatic Discharge

Electrostatic discharge is common on Category 5E and Category 6 cabling systems.

Category 5E and Category 6 cables have higher capacitance than Category 5 cables. As a result, Category 5E and Category 6 cables can store higher voltages than Category 5 cables and are more prone to damaging networking equipment if a differential discharge event occur.

Unshielded twisted-pair cables can store high voltages. When these charged cables are connected to networking equipment, energy is discharged into the networking equipment; this is known as electrostatic discharge (ESD). Networking equipment is commonly designed and tested to withstand common mode ESD events of up to 2000 V. The design for the common mode event is based on the expectation that the discharge is delivered to all pins of a port at once.

Sometimes, voltage is discharged to some of the pins of the connector and not others, or to some pins on the connector before others. This is known as a differential discharge event, which can damage the networking equipment being connected.

You can take the following measures to prevent ESD cable damage:

- Ground the cable before connecting the networking equipment. You can create a grounding cable using an RJ-45 patch cable by doing the following:
  - Bare the wires on one end
  - Connect the wires to a suitable and safe earth ground
  - Connect the RJ-45 cable to a female RJ-45 connector
- Briefly connect all cables to the grounded cable before connecting to networking equipment.
- Leave cables from the networking equipment in the distribution closet connected to ports at user desktops. After you make connections on either side of the cable to networking equipment, the cable will not build up charge.

## Preventing Electrostatic Discharge Damage

Electrostatic discharge (ESD) damage, which can occur when electronic cards or components are improperly handled, results in complete or intermittent failures. Port adapters and processor modules consist of printed circuit boards that are fixed in metal carriers. Electromagnetic interference (EMI) shielding and connectors are integral components of the carrier. Although the metal carrier helps to protect the board from ESD, use a preventive antistatic strap during handling.

Following are guidelines for preventing ESD damage:

- Always use an ESD wrist or ankle strap and ensure that it makes good skin contact.
- Connect the equipment end of the strap to an unfinished chassis surface.
- When installing a component, use any available ejector levers or captive installation screws to properly seat the bus connectors in the backplane or midplane. These devices prevent accidental removal, provide proper grounding for the system, and help to ensure that bus connectors are properly seated.

- When removing a component, use any available ejector levers or captive installation screws to release the bus connectors from the backplane or midplane.
- Handle carriers by available handles or edges only; avoid touching the printed circuit boards or connectors.
- Place a removed component board-side-up on an antistatic surface or in a static shielding container. If you plan to return the component to the factory, immediately place it in a static shielding container.
- Avoid contact between the printed circuit boards and clothing. The wrist strap only protects components from ESD voltages on the body; ESD voltages on clothing can still cause damage.
- Never attempt to remove the printed circuit board from the metal carrier.

**Caution**

---

For safety, periodically check the resistance value of the antistatic strap. The measurement should be between 1 and 10 megohm (Mohm).

---

## Site Power Requirements and Heat Dissipation

This section provides module power requirements and heat dissipation specifications for the Catalyst 4500 series switches. You should verify site power before you install the switch.

For more information about power management and planning, refer to the “Environmental Monitoring and Power Management” chapter in the *Catalyst 4500 Series Switch Cisco IOS Software Configuration Guide* version appropriate for your software.

Knowing the power requirements is useful for planning the power distribution system needed to support the switches. You should consider the heat dissipation specifications when estimating the air-conditioning requirements for an installation. For all Catalyst 4500 series switches, supervisor engines, and switching modules in AC or DC environments see the *Catalyst 4500 Series Module Installation Guide* at:

[http://www.cisco.com/univercd/cc/td/doc/product/lan/cat4000/hw\\_doc/mod\\_inst/0aspecs.htm#wp1012188](http://www.cisco.com/univercd/cc/td/doc/product/lan/cat4000/hw_doc/mod_inst/0aspecs.htm#wp1012188).

# Power Connection Guidelines for AC-Powered Systems

This section provides guidelines for connecting the Catalyst 4500 series switch AC power supplies to the site power source. Basic guidelines include the following:

- Make sure each chassis power supply has its own dedicated branch circuit.
- Size the circuits according to local and national codes.
- If you are using a 200/240 VAC power source in North America, use a two-pole circuit breaker to protect the circuit.
- Place the source AC outlet within 6 feet (1.8 meters) of the system and make sure it is easily accessible.
- Make sure the AC power receptacles used to plug in the chassis are the grounding type. The grounding conductors that connect to the receptacles should connect to protective earth ground at the service equipment.

Four types of AC-input power supplies are available:

- 1000 W—Table 2-1 lists the AC-input power cord options, specifications, Cisco part numbers, and shows the different styles of 1000 W AC-input power cord wall plugs that are available for North America and international locations as well as the appliance coupler that is attached to the power supply end of the power cord.
- 1300 W—Table 2-1 lists the AC-input power cord options, specifications, and Cisco product numbers, and shows the different styles of 1300 W AC-input power cord wall plugs that are available for North America or various international locations as well as the appliance coupler that is attached to the power supply end of the power cord.

**Note**

---

For North America, the power cord plug types and appliance couplers on the power supplies are different for the 1000 W power supplies and the 1300 W power supplies; for other countries, the plugs shown are the same for the 1000 W and 1300 W power supplies.

---

- 1400 W—Table 2-1 lists the AC-input power cord options, specifications, and Cisco product numbers, and shows the different styles of 1400 W AC-input power cord wall plugs that are available for North America or various international locations as well as the appliance coupler that is attached to the power supply end of the power cord.
- 2800 W—Table 2-1 lists the AC-input power cord options, specifications, and Cisco part numbers, and shows the different styles of 2800 W AC-input power cord wall plugs that are available for North America and international locations as well as the appliance coupler that is attached to the other end of the 2800 W power supply power cord.
- 4200 W—Table 2-1 lists the AC-input power cord options, specifications, and Cisco part numbers, and shows the different styles of 4200 W AC-input power cord wall plugs that are available for North America and international locations as well as the appliance coupler that is attached to the other end of the 4200 W power supply power cord.

**Table 2-1 AC-Input Power Cord Options**


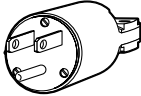
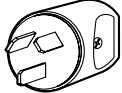
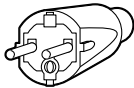
Locale	Part Number	Length	Plug Rating	Plug Type
<b>1000 W Power Supply (PWR-C45-1000AC=)</b>			<b>Appliance Coupler</b>	 120352
North America	CAB-7KAC=	8 ft (2.5 m)	125 VAC, 15 A	NEMA 5-15P  120354
Australia, New Zealand	CAB-7KACA=	8 ft (2.5 m)	250 VAC, 15 A	SAA/3, AS/NZS 3112-1993  120356
Europe (except Italy)	CAB-7KACE=	8 ft (2.5 m)	250 VAC, 16 A	CEE 7/7  120357

Table 2-1 AC-Input Power Cord Options (continued)





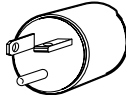

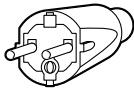
Locale	Part Number	Length	Plug Rating	Plug Type
Italy	CAB-7KACI=	8 ft (2.5 m)	250 VAC, 16 A	1/3/16 CEI 23-16  120358
United Kingdom	CAB-7KACU=	8 ft (2.5 m)	250 VAC, 13 A	BS 89/13 BS 1363/A  120359
Argentina	CAB-7KACR=	8 ft (2.5 m)	250 VAC, 10 A	IRAM 2073  120356
<b>Appliance Coupler</b>				
<b>1300 W (PWR-C45-1300ACV=) and 1400 W (PWR-C45-1400AC=) Power Supplies</b>				 120353
North America	CAB-7513AC=	14 ft (4.3 m)	125 VAC, 20 A	NEMA 5-20  120362
Australia, New Zealand	CAB-7513ACA=	14 ft (4.3 m)	250 VAC, 15 A	SAA/3, AS/NZS 3112-1993  120356
Europe (except Italy)	CAB-7513ACE=	14 ft (4.3 m)	250 VAC, 16 A	CEE 7/7  120357

Table 2-1 AC-Input Power Cord Options (continued)



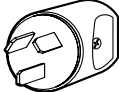

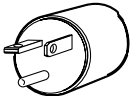
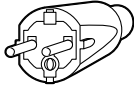
Locale	Part Number	Length	Plug Rating	Plug Type
Italy	CAB-7513ACI=	14 ft (4.3 m)	250 VAC, 16 A	1/3/16, CEI 23-16  120358
United Kingdom	CAB-7513ACU=	14 ft (4.3 m)	250 VAC, 13 A	BS 89/13 BS 1363/A  120359
Argentina	CAB-7513ACR=	14 ft (4.3 m)	250 VAC, 10 A	IRAM 2073  120356
North America (locking) 200–240 VAC operation	CAB-AC-2800W-TWLK=	14 ft (4.3 m)	250 VAC, 16 A	NEMA L6-20  120361
North America (non-locking) 200–240 VAC operation	CAB-AC-2800W-6-20	14 ft (4.3 m)	250 VAC, 16 A	NEMA 6-20 non-locking  120355
Europe	CAB-AC-2800W-EU=	14 ft (4.3 m)	250 VAC, 16 A	CEE 7/7  120357



Table 2-1 AC-Input Power Cord Options (continued)

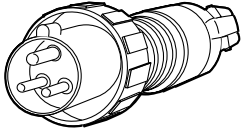

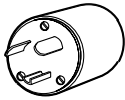
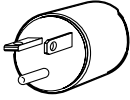
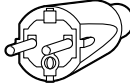
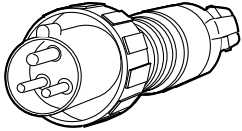

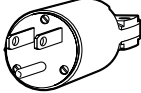

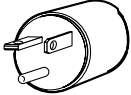
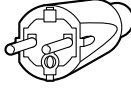
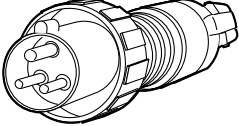

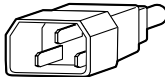
Locale	Part Number	Length	Plug Rating	Plug Type
International	CAB-AC-2800W-INT=	14 ft (4.3 m)	250 VAC, 16 A	IEC 309  120360
<b>Appliance Coupler</b>  120353				
<b>2800 W Power Supply (PWR-C45-2800ACV=)</b>				
North America (locking) 200–240 VAC operation	CAB-AC-2800W-TWLK=	14 ft (4.3 m)	250 VAC, 16 A	NEMA L6-20  120361
North America (non-locking) 200–240 VAC operation	CAB-AC-2800W-6-20	14 ft (4.3 m)	250 VAC, 16 A	NEMA 6-20 non-locking  120355
Europe	CAB-AC-2800W-EU=	14 ft (4.3 m)	250 VAC, 16 A	CEE 7/7  120357
International	CAB-AC-2800W-INT=	14 ft (4.3 m)	250 VAC, 16 A	IEC 309  120360

Table 2-1 AC-Input Power Cord Options (continued)

Locale	Part Number	Length	Plug Rating	Plug Type
<b>Appliance Coupler</b>				
<b>4200 W Power Supply (PWR-C45-4200ACV=)</b>				
 120353				
North America 120 VAC operation	CAB-US515P-C19-US	6 ft (1.82 m)	125VAC, 15A	NEMA 5-15P  120354
North America (locking) 200–240 VAC operation	CAB-USL620P-C19-US	6 ft (1.82 m)	250 VAC, 20 A	NEMA L6-20  120361
North America (non-locking) 200–240 VAC operation	CAB-US620P-C19-US	6 ft (1.82 m)	250 VAC, 20 A	NEMA 6-20 non-locking  120355
Europe	CAB-CEE77-C19-EU	6 ft (1.82 m)	250 VAC, 15 A	CEE 7/7  120357
International (including Argentina and South Africa)	CAB-IEC309-C19-INT	6 ft (1.82 m)	250 VAC, 16 A	IEC 309  120360

**Table 2-1 AC-Input Power Cord Options (continued)**

Locale	Part Number	Length	Plug Rating	Plug Type
Australia	CAB-AS3112-C19-AUS	6 ft (1.82 m)	250 VAC, 15 A	AS/NZS 3112  120356
Italy	CAB-CEI2316-C19-IT	6 ft (1.82 m)	250 VAC, 16 A	CEI 23-16  120358
United Kingdom	CAB-BS1363-C19-UK	6 ft (1.82 m)	250 VAC, 15 A	BS 1363  120359
Israeli	CAB-SI32-C19-ISRL	6 ft (1.82 m)	250 VAC, 16 A	SI32  130922
UPS 220V	CAB-C19-C20	6 ft (1.82 m)	250 VAC, 20 A	IEC-60320-C20  130923
UPS 110V	CAB-C19-C14	6 ft (1.82 m)	125 VAC, 16 A	IEC-60320-C14  130924

# Power Connection Guidelines for DC-Powered Systems

This section provides the basic guidelines for connecting the Catalyst 4500 series switch DC-input power supplies to the site power source or AC power shelf:

- All power connection wiring should conform to local and national codes.
- DC (–) and DC return (+) terminals are evaluated for use with 1/0 AWG wire (1400W DC supply only).
- The ground terminal is evaluated for use with 6 AWG wire (10 AWG for the multi-input power supply).
- DC (–) and DC return (+) wire lugs shall not exceed 0.83 inches in width (0.378 inches for the multi-input power supply).
- For DC power cables, we recommend that you use commensurately rated, high-strand-count copper wire cable. Connection to the DC-input power supply requires one earth ground cable, one source DC (–), and one source DC return (+). The length of the cables depends on your switch location. These cables are not available from Cisco Systems. They are available from any commercial cable vendor.
- The color coding of the source DC power cable leads depends on the color coding of the site DC power source. Typically, green or green and yellow indicate that the cable is a ground cable. Because there is no color code standard for source DC wiring, you must ensure that the power cables are connected to the DC-input power supply terminal block in the proper (+) and (–) polarity. In some cases, the source DC cable leads might have a positive (+) or a negative (–) label. This label is a relatively safe indication of the polarity, but you must verify the polarity by measuring the voltage between the DC cable leads. When making the measurement, the positive (+) lead and the negative (–) lead must always match the (+) and (–) labels on the DC-input power supply terminal block.

## Calculating DC Input Current

Complete power usage tables are in the *Catalyst 4500 Series Module Installation Guide*. To calculate the DC input current needed for data and inline power applications, use the following steps (the example shows the DC input current requirement in a Catalyst 4503 with a Supervisor Engine II and two WS-X4306-GB modules, and assumes a DC input voltage of -48 VDC):

- 
- Step 1** Add the power requirement for each component in your system.
- Catalyst 4503 uses 54 W
  - Supervisor Engine II uses 147 W
  - WS-X4306-GB uses  $2 \times 47 = 94$  W
  - Total DC input power = 295 W
- Step 2** After the entries for all components have been added together, divide that number by the DC input voltage to determine the DC input current.
- Input current =  $295 \text{ W} / 48 \text{ VDC} = 6.14 \text{ A}$  for data only.
- Step 3 to Step 5 are for applications requiring inline power. If your configuration does not include inline power devices, the DC input current is the result of Step 2.
- Step 3** If you want to add an inline-capable module (WS-X4148-RJ45V) with 10 inline devices (such as IP Phones) to your system, calculate the DC output power sent to inline devices.
- $10 \times 6.3 \text{ W} = 63 \text{ W}$  for inline devices.
- 6.3 Watts is correct for a Cisco IP phone. Wattage consumption will depend on the inline device used.
- Step 4** Find the DC input power using the DC output power.
- $63 / .96$  (efficiency) = 65 W of DC input power.
- Step 5** Divide the DC input power by the DC voltage input of -48 V to find the DC input current used by inline devices.
- $65 / 48 = 1.4$  Amps for inline devices.

**Step 6** Add the DC input current used by data and the DC input current used by inline devices to find the total DC input current.

- Total DC input current =  $6.14 + 1.4 = 7.54$  A.
- 

## Ventilation

Planning a proper location for the switch and the layout of your equipment rack or wiring closet is essential for successful system operation. You should install the switch in an enclosed, secure area, ensuring that only qualified personnel have access to the switch and control of the environment. Equipment placed too close together or inadequately ventilated can cause system overtemperature conditions. In addition, poor equipment placement can make chassis panels inaccessible and difficult to maintain.

The switch operates as a standalone system mounted in a rack in a secure wiring closet. It requires a dry, clean, well-ventilated, and air-conditioned environment. To ensure normal operation, maintain ambient airflow. If the airflow is blocked or restricted, or if the intake air is too warm, an overtemperature condition can occur. The switch environmental monitor can then shut down the system to protect the system components.

To ensure normal operation and avoid unnecessary maintenance, plan your site configuration and prepare your site before installation. After installation, make sure the site maintains an ambient temperature of 0 to 40°C (32 to 104°F). It is essential to keep the area around the chassis as free from dust and foreign conductive material (such as metal flakes from nearby construction activity) as is possible.

Multiple switches can be rack-mounted with little or no clearance above and below the chassis. However, when mounting a switch in a rack with other equipment, or when placing it on the floor near other equipment, ensure that the exhaust from other equipment does not blow into the intake vent of the chassis.

Cooling air is drawn in through the right side of the chassis. Keep the right side clear of obstructions, including dust and foreign conductive material, and away from the exhaust ports of other equipment.

Appendix A, “Specifications,” lists the operating and nonoperating environmental site requirements for the switches. To maintain normal operation and ensure high system availability, maintain an ambient temperature and clean power at your site. The environmental ranges listed in Appendix A, “Specifications,” are those within which the switch will continue to operate; however, a measurement that approaches the minimum or maximum of a range indicates a potential problem. You can maintain normal operation by anticipating and correcting environmental anomalies before they exceed the maximum operating range.

## Calculating System Heat Dissipation

To calculate the expected heat dissipation from a switch, add the total amount of power drawn from power supply by the system's configuration, then divide the total amount of power by the efficiency of the power supply. Multiply the result by 3.415 to get the system heat dissipation in BTUs/hr.

First example (System without any powered devices):

Components	Output Power
1 - Catalyst 4506 with fans	50 W
1 - Supervisor Engine IV	145 W
1 - WS-X4248-RJ45V with no phones	72 W
total output power	267 W
Total heat dissipated by system = $(267/0.75) * 3.415 = 1215$ BTUs/hr	



### Note

All Catalyst 4000/4500 power supplies have different efficiencies, An average efficiency figure of 75% was chosen.

Second example (same system but this time with one IEEE class 3 device):

Components	Output Power
1 - Catalyst 4506 with fans	50 W
1 - Supervisor Engine IV	145 W
1 - WS-X4248-RJ45V with no phones	72 W

1 - IEEE class 3 device	17.3 W
total output power	284 W
Total heat dissipated by system = $(284/.75) * 3.415 = 1293$ BTUs/hr	

**Note**

Although a class 3 device needs 15.4 W to power up, 17.3 W need to be generated from the backplane in order to have 15.4 W at the switch port. 17.3 W comes from the WS-X4248-RJ45V DC-DC converter's efficiency (89%).

## Site-Planning Checklist

Table 2-2 lists the site-planning activities that you should complete before you install a Catalyst 4500 series switch. Completing each activity helps to ensure a successful switch installation.

**Table 2-2 Site-Planning Checklist**

Task No.	Planning Activity	Verified by	Time	Date
1	Space evaluation: <ul style="list-style-type: none"> <li>• Space and layout</li> <li>• Floor covering</li> <li>• Impact and vibration</li> <li>• Lighting</li> <li>• Maintenance access</li> </ul>			
2	Environmental evaluation: <ul style="list-style-type: none"> <li>• Ambient temperature</li> <li>• Humidity</li> <li>• Altitude</li> <li>• Atmospheric contamination</li> <li>• Airflow</li> </ul>			



Table 2-2 Site-Planning Checklist (continued)

Task No.	Planning Activity	Verified by	Time	Date
3	Power evaluation: <ul style="list-style-type: none"> <li>• Input power type</li> <li>• Receptacle proximity to the equipment</li> <li>• Dedicated (separate) circuits for redundant power supplies</li> <li>• UPS for power failures</li> </ul>			
4	Grounding evaluation: <ul style="list-style-type: none"> <li>• Circuit breaker size</li> </ul>			
5	Cable and interface equipment evaluation: <ul style="list-style-type: none"> <li>• Cable type</li> <li>• Connector type</li> <li>• Cable distance limitations</li> <li>• Interface equipment (transceivers)</li> </ul>			
6	EMI evaluation: <ul style="list-style-type: none"> <li>• Distance limitations for signaling</li> <li>• Site wiring</li> <li>• RFI levels</li> </ul>			





## Installing the Switch in a Rack

---



### Warning

**This unit is intended for installation in restricted access areas. A restricted access area can be accessed only through the use of a special tool, lock and key, or other means of security.** Statement 1017

---



### Warning

**Only trained and qualified personnel should be allowed to install, replace, or service this equipment.** Statement 1030

---



### Warning

**To prevent personal injury or damage to the chassis, never attempt to lift or tilt the chassis using the handles on modules (such as power supplies, fans, or cards); these types of handles are not designed to support the weight of the unit.** Statement 1032

---

This chapter describes how to install Catalyst 4500 series switches in a rack. For first-time installations, perform the procedures in the following sections in the order listed:

- Checking the Shipping Container Contents, page 3-2
- Rack-Mounting the Switch, page 3-3



### Note

Before starting the installation procedures in this chapter, complete the site-planning checklist in Table 2-2 of Chapter 2, “Preparing for Installation.”

---

**Note**

---

For information on installing the supervisor engine and switching modules and verifying switch operation, refer to the *Catalyst 4500 Series Module Installation Guide*. For information on configuring the switching modules, refer to the software configuration guide for your switch and software release.

---

## Checking the Shipping Container Contents

**Note**

---

Do not discard the shipping cartons and poly bag when you unpack the switch. Flatten and store them. You will need the containers if you need to move or ship the switch in the future. Repacking instructions are provided in Appendix B, “Repacking a Switch.”

---

Follow these steps to check the contents of the shipping cartons:

- 
- Step 1** Check the contents of the accessories box against the Accessories Box Components Checklist and the packing slip that were included with your switch. Verify that you received all listed equipment, including the following:
- Switch hardware documentation and software documentation (if ordered)
  - Optional equipment that you ordered, such as network interface cables, transceivers, or special connectors
- Step 2** Check the switching modules in each slot. Ensure that the configuration matches the packing list and that all the specified interfaces are included.
-

# Rack-Mounting the Switch

A standard rack-mount kit is included for mounting the switch in a standard 19-inch (48.3 cm) equipment rack with two unobstructed outer posts, with a nominal depth (between the front and rear mounting posts) of 19.25 inches (48.9 cm) and a maximum depth of 32 inches (81.3 cm). This kit is not suitable for racks with obstructions (such as a power strip) that could impair access to the field-replaceable units (FRUs) of the switch.

Alternatively, you can obtain a 23-inch rack-mount kit.

## Required Installation Tools

You will need the following tools and equipment to install the chassis in a rack:

- Number 1 and number 2 Phillips screwdrivers to tighten the captive installation screws on most systems
- 3/16-inch flat-blade screwdriver for the captive installation screws on the supervisor engine and switching modules on some systems
- Antistatic mat or antistatic foam in case you need to remove switching modules to troubleshoot the installation
- Rack-mount kit
- Tape measure
- Level
- Your own electrostatic discharge (ESD) grounding strap or the disposable ESD strap included with the system

## Rack-Mounting Catalyst 4500 Series Switches



### Warning

**To prevent bodily injury when mounting or servicing this unit in a rack, you must take special precautions to ensure that the system remains stable. The following guidelines are provided to ensure your safety:**

- **This unit should be mounted at the bottom of the rack if it is the only unit in the rack.**
- **When mounting this unit in a partially filled rack, load the rack from the bottom to the top with the heaviest component at the bottom of the rack.**
- **If the rack is provided with stabilizing devices, install the stabilizers before mounting or servicing the unit in the rack.** Statement 1006

Follow these steps to install a Catalyst 4500 series switch in a rack:

### Step 1 Prepare for installation as follows:

- a. Place the chassis on the floor or on a sturdy table as close as possible to the rack. Leave enough clearance to allow you to move around the chassis.
- b. Use a tape measure to measure the depth of the rack. Measure from the outside of the front mounting posts to the outside of the rear mounting strip. The depth must be at least 19.25 inches (48.9 cm) but not greater than 32 inches (81.3 cm).
- c. Measure the space between the inner edges of the left front and right front mounting posts to ensure that it is 17.75 inches (45.09 cm) wide. (The chassis is 17.25 inches [43.8 cm] wide and must fit between the mounting posts.)
- d. Open the rack-mount kit and check the component checklist in Table 3-1 to verify that all parts are included.

**Table 3-1** Rack-Mount Kit Checklist

Quantity	Part Description
2	L brackets
6	M4 Phillips pan-head screws
6	12-24 x 3/4-inch Phillips binder-head screws



**Note** Some equipment racks provide a power strip along the length of one of the rear posts. If your rack has this feature, consider the position of the strip when planning fastener points. Before installing the L brackets on the chassis, determine whether to install the chassis from the front or the rear of the rack.

- Step 2** Install the L brackets, which connect the chassis to the rack, as follows:
- a. Remove the screws from the front of the switch side-cover panels.
  - b. Attach the left and right L brackets using the six M4 Phillips pan-head screws (three screws per side) provided in the rack-mount kit.
- See Figure 3-1 for the Catalyst 4503 switch, Figure 3-2 for the Catalyst 4506 switch, or Figure 3-3 for the Catalyst 4507R switch, or Figure 3-4 for the Catalyst 4510R switch.

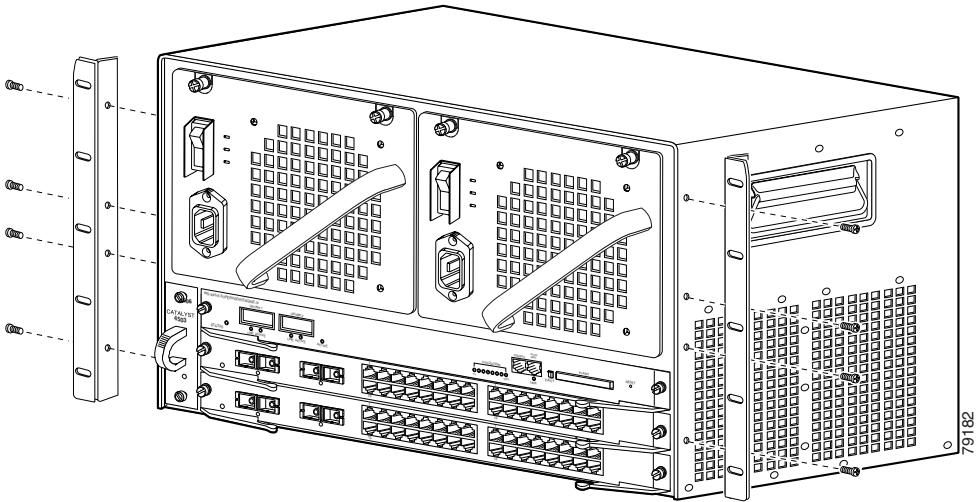
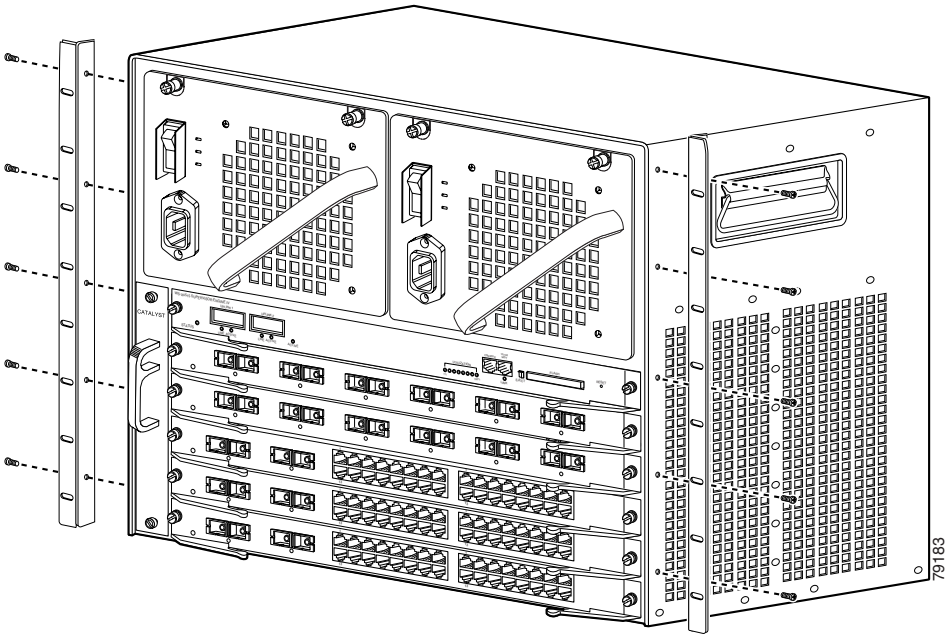
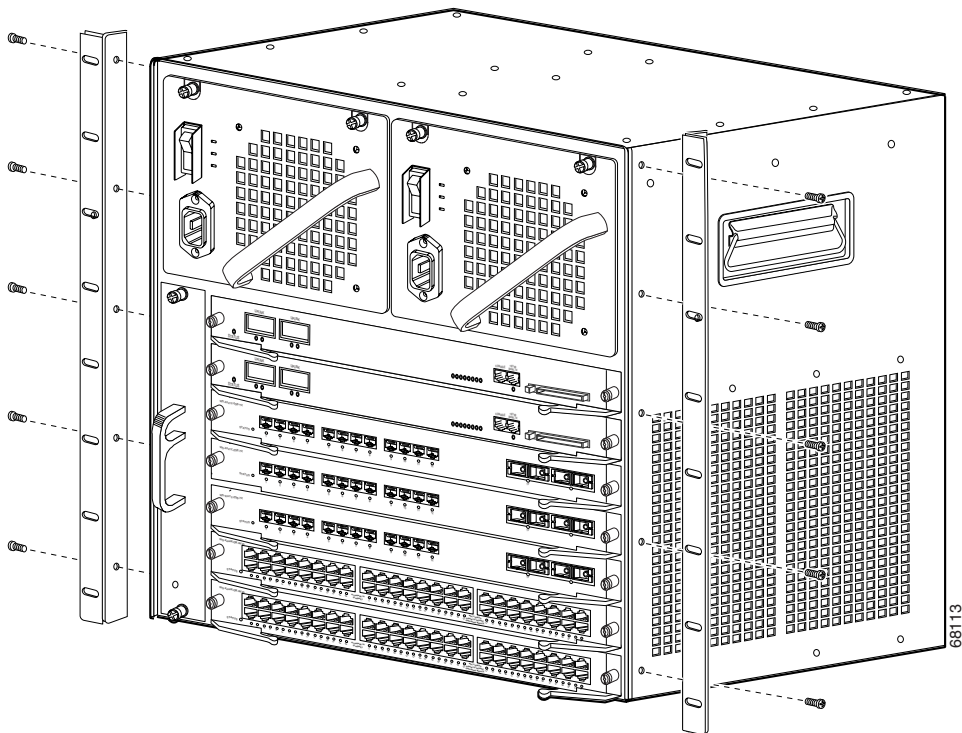
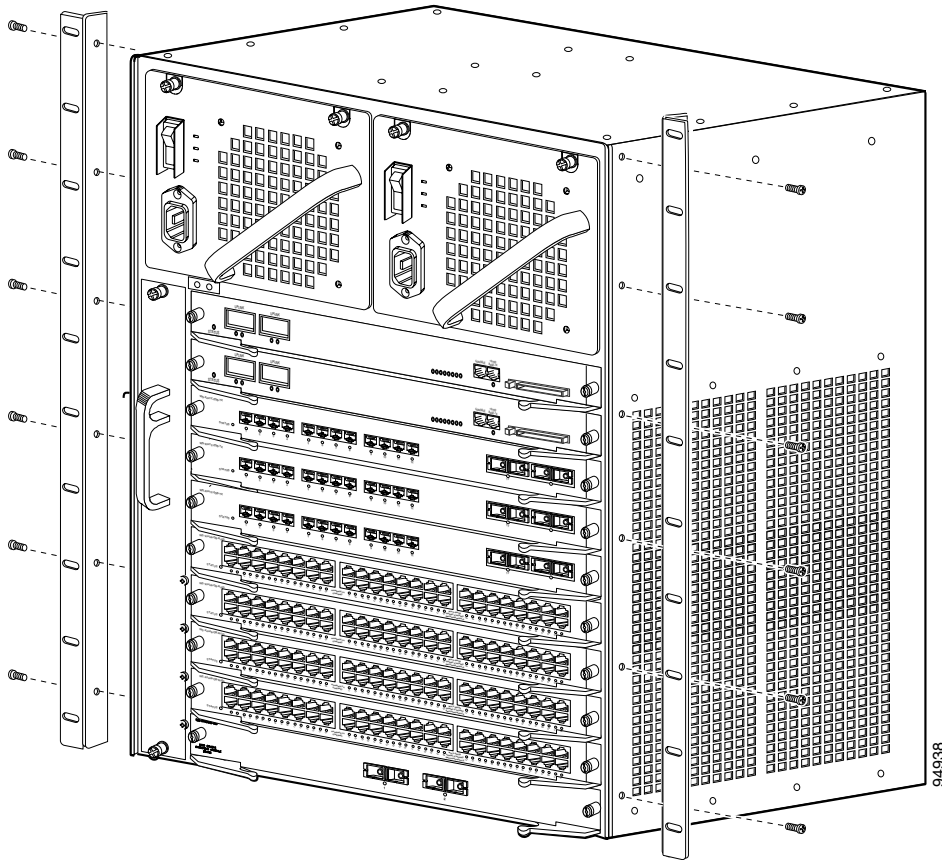
**Figure 3-1** L Brackets on the Front Edge of the Catalyst 4503 Switch



Figure 3-2 L Brackets on the Front Edge of the Catalyst 4506 Switch



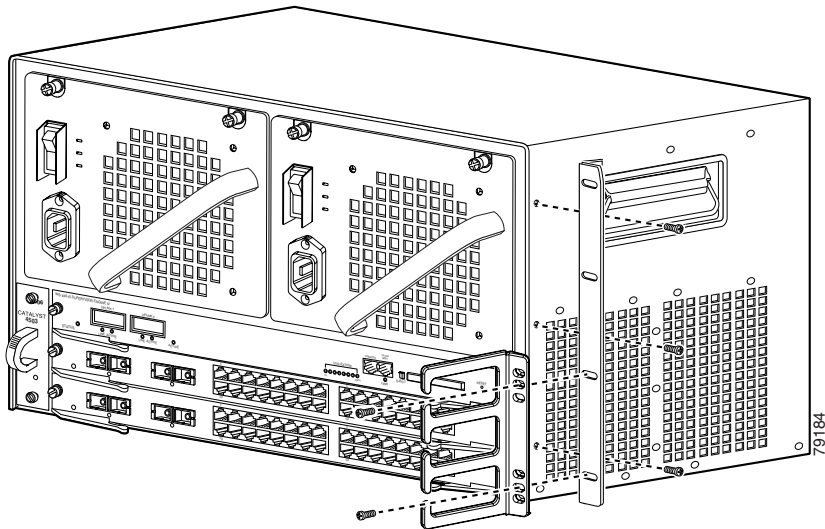
**Figure 3-3** L Brackets on the Front Edge of the Catalyst 4507R Switch

**Figure 3-4** L Brackets on the Front Edge of the Catalyst 4510R Switch

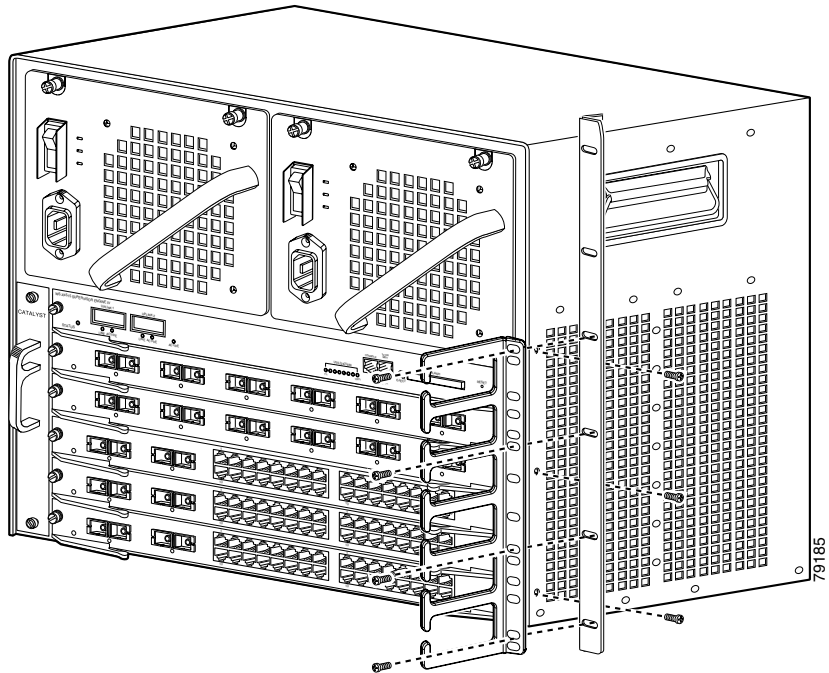
- c. Attach the cable guide, if needed, using the M3 screws provided in the cable management kit. The cable guide attaches to the L bracket. Attach the cable guide to the right side of the switch to prevent the cables from obscuring module LEDs.

See Figure 3-5 for the Catalyst 4503 switch, Figure 3-6 for the Catalyst 4506 switch, Figure 3-7 for the Catalyst 4507R switch, or Figure 3-8 for the Catalyst 4510R switch.

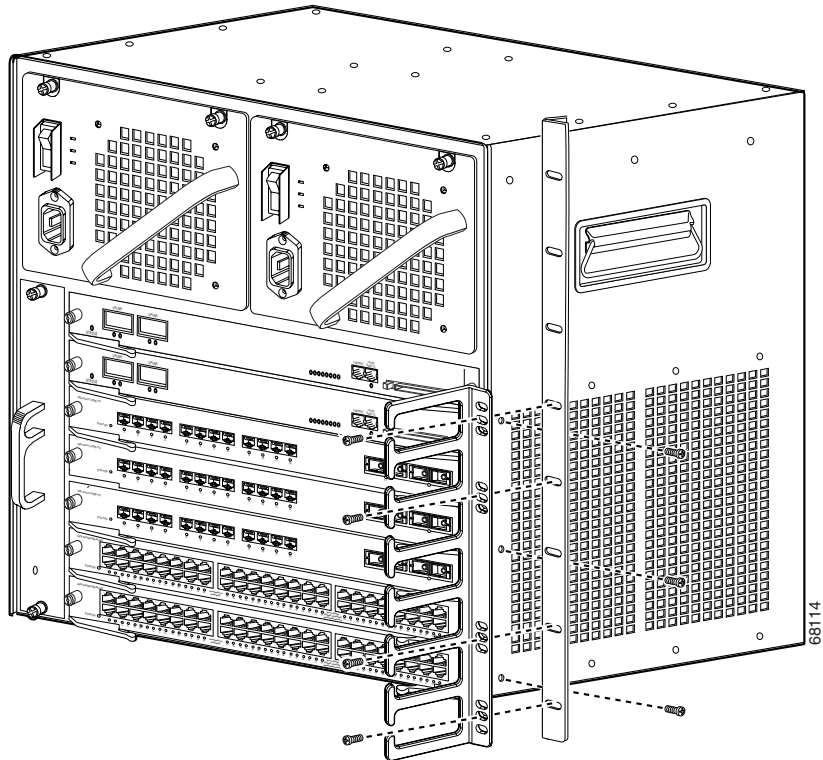
**Figure 3-5** Attaching the Cable Guide to the Catalyst 4503 Switch

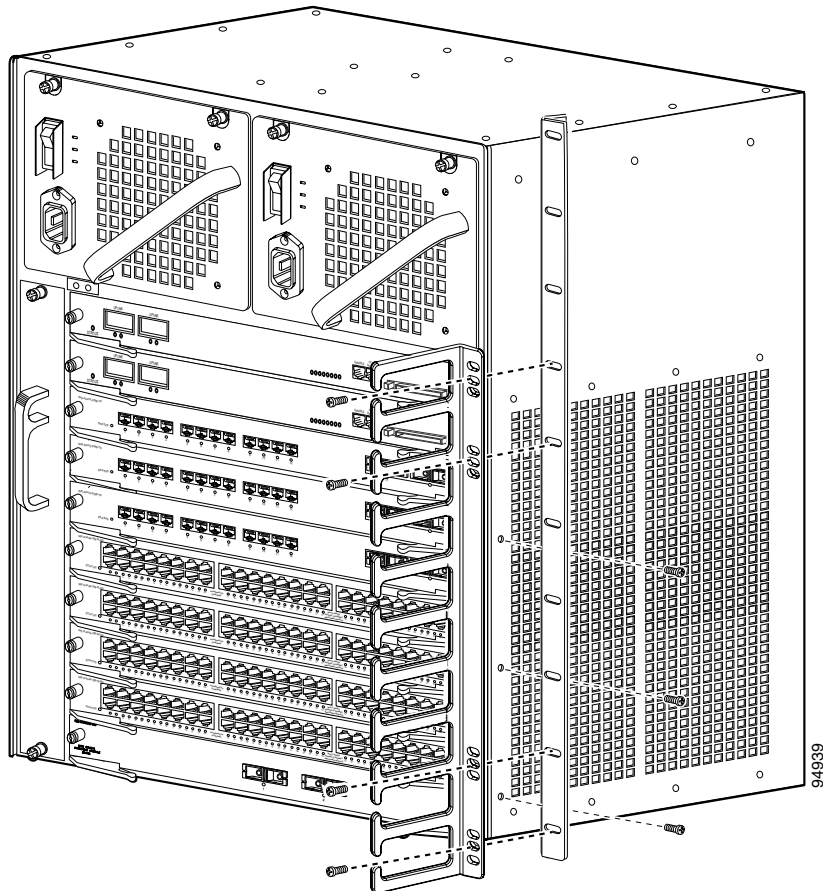


**Figure 3-6** Attaching the Cable Guide to the Catalyst 4506 Switch



**Figure 3-7** Attaching the Cable Guide to the Catalyst 4507R Switch



**Figure 3-8 Attaching the Cable Guide to the Catalyst 4510R Switch**

**Step 3** Install the chassis in the rack as follows:

- a. Insert the rear of the chassis between the mounting posts.

See Figure 3-9 to see how to install the Catalyst 4503 switch in a rack.

See Figure 3-10 to see how to install the Catalyst 4506 switch in a rack.

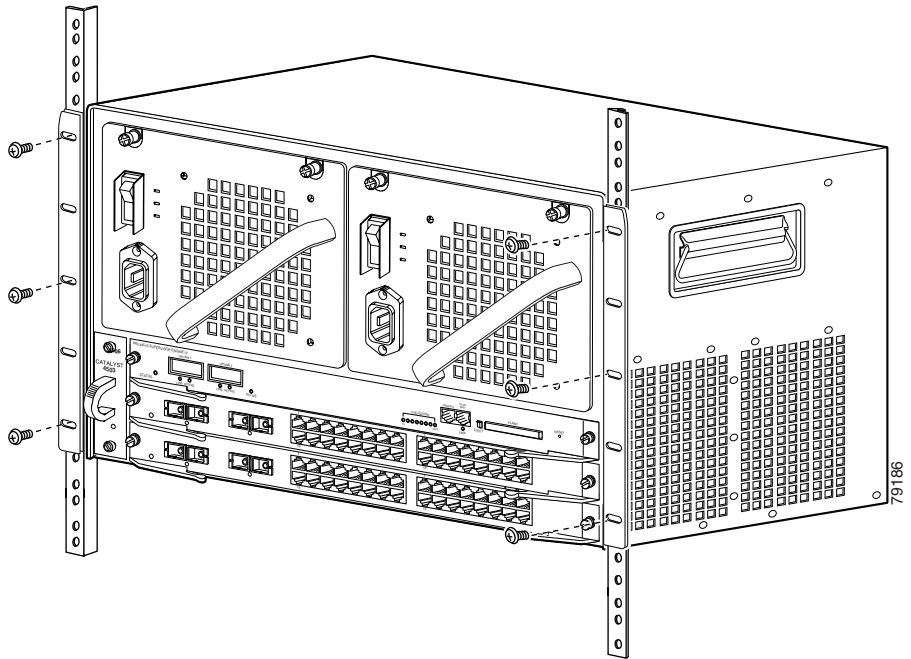
See Figure 3-11 to see how to install the Catalyst 4507R switch in a rack.

See Figure 3-12 to see how to install the Catalyst 4510R switch in a rack.

- b. Align the mounting holes in the L bracket with the mounting holes in the equipment rack.

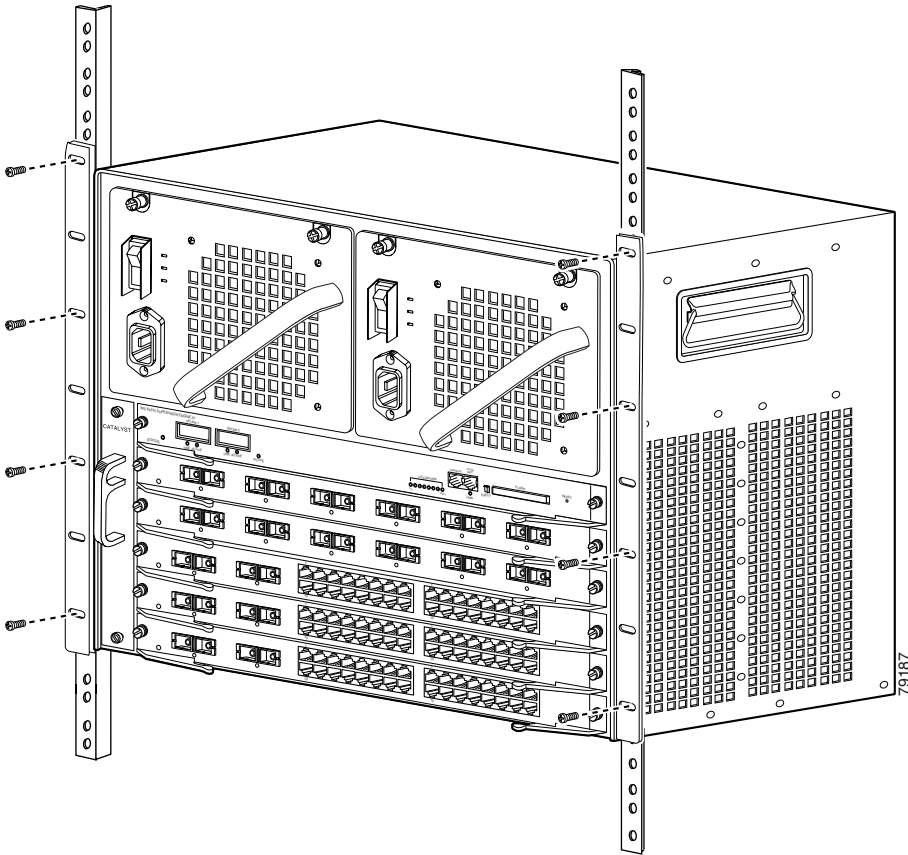
- c. Secure the chassis using at least six (three per side) 12-24 x 3/4-inch screws through the elongated holes in the L bracket and into the threaded holes in the mounting post.
- d. Use a tape measure and level to ensure that the chassis is installed straight and level.

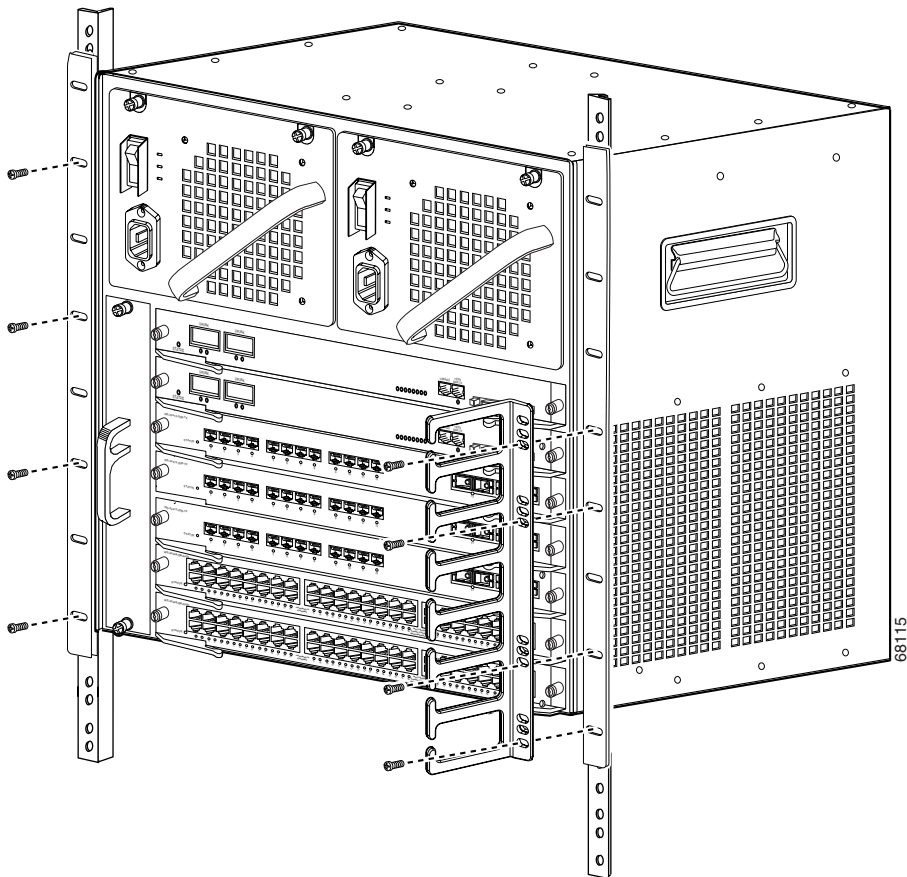
**Figure 3-9** *Installing a Catalyst 4503 Switch in the Rack*

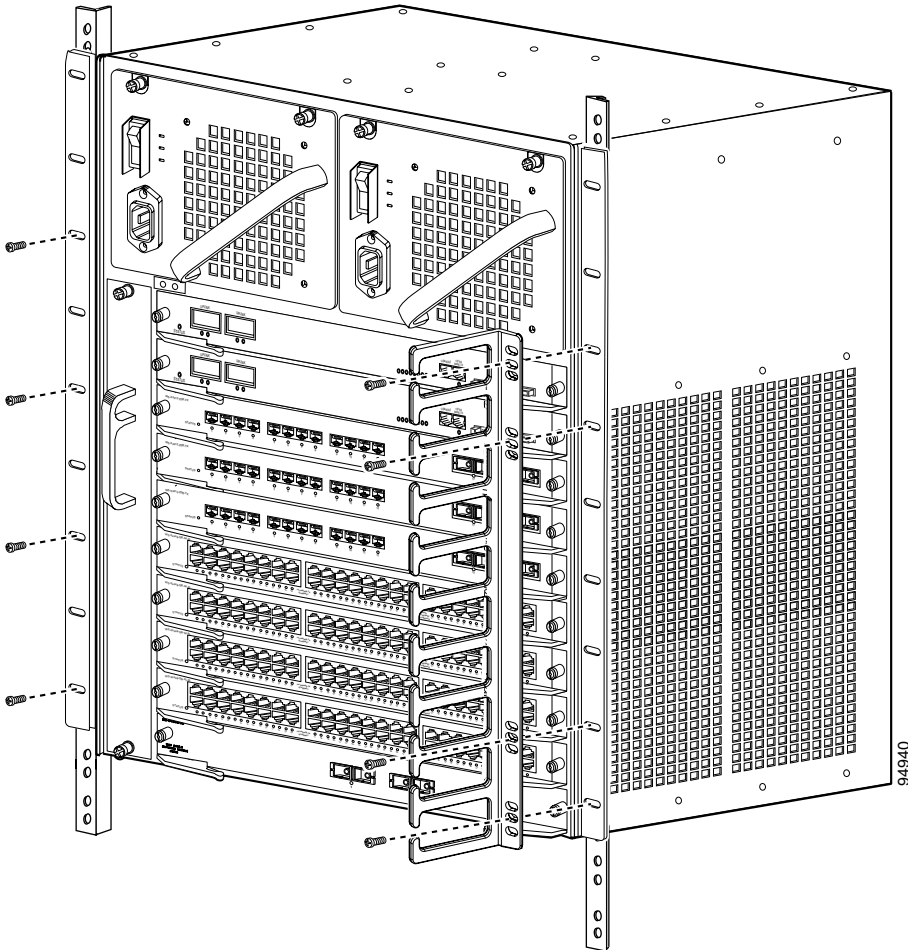




**Figure 3-10** Installing a Catalyst 4506 Switch in the Rack



**Figure 3-11** *Installing a Catalyst 4507R Switch in the Rack*

**Figure 3-12** Installing a Catalyst 4510R Switch in the Rack

- Step 4** Make sure that the ejector levers are completely closed and the supervisor engine and switching modules are installed securely.
- Step 5** Tighten any loose captive installation screws on the supervisor engine and the switching module.

- Step 6** Connect the switch to an appropriate ground. Refer to System Ground Connection Guidelines, page 3-18. The system must have a ground connection before power is supplied to the switch.

## System Ground Connection Guidelines

A grounding pad with two system (earth) grounding holes is provided in an enclosure near the left power supply on the Catalyst 4500 series switches. See Figure 3-13 for the location of the grounding holes on the Catalyst 4503 switch, Figure 3-14 for the location on the Catalyst 4506 switch, Figure 3-15 for the location on the Catalyst 4507R switch, and Figure 3-16 for the location on the Catalyst 4510R switch.

**Figure 3-13 Catalyst 4503 Grounding Holes**

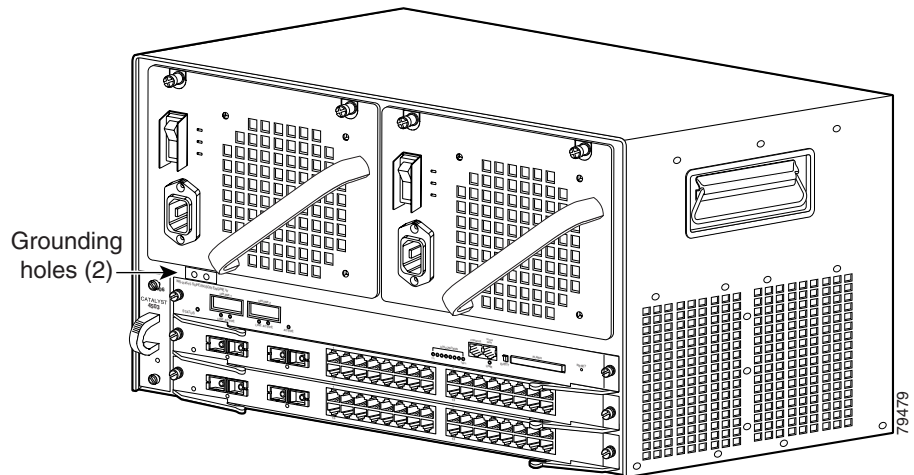
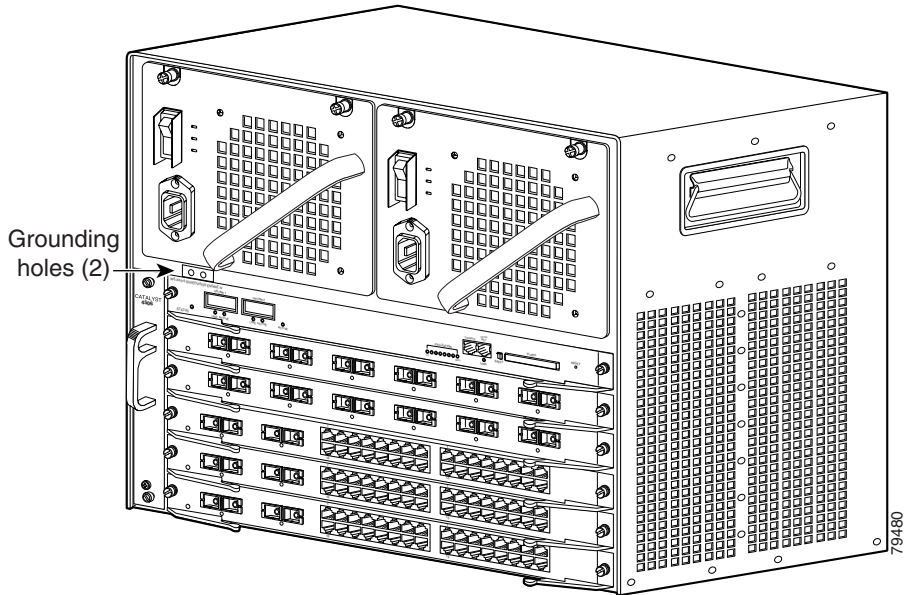


Figure 3-14 Catalyst 4506 Grounding Holes



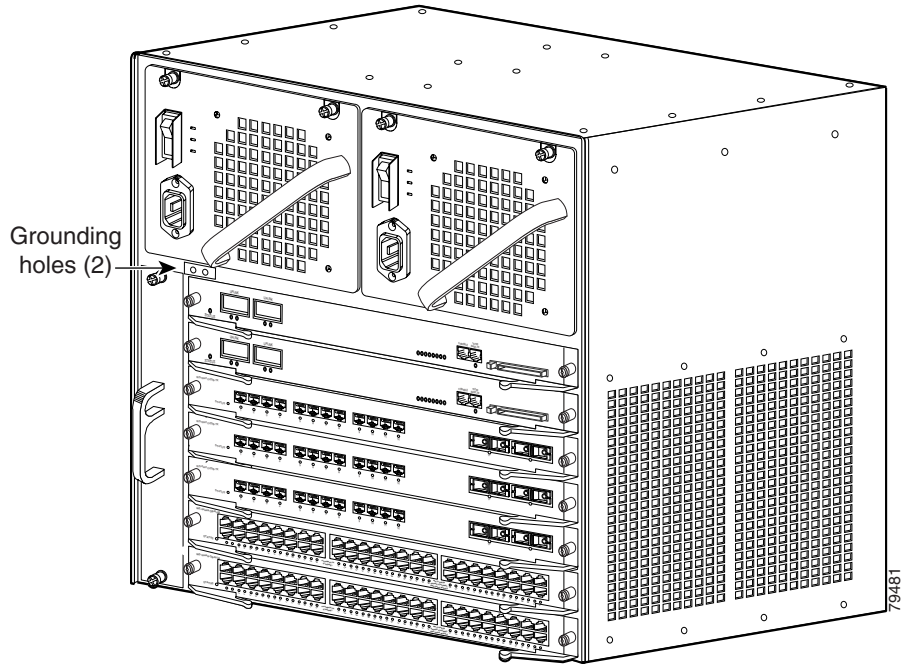
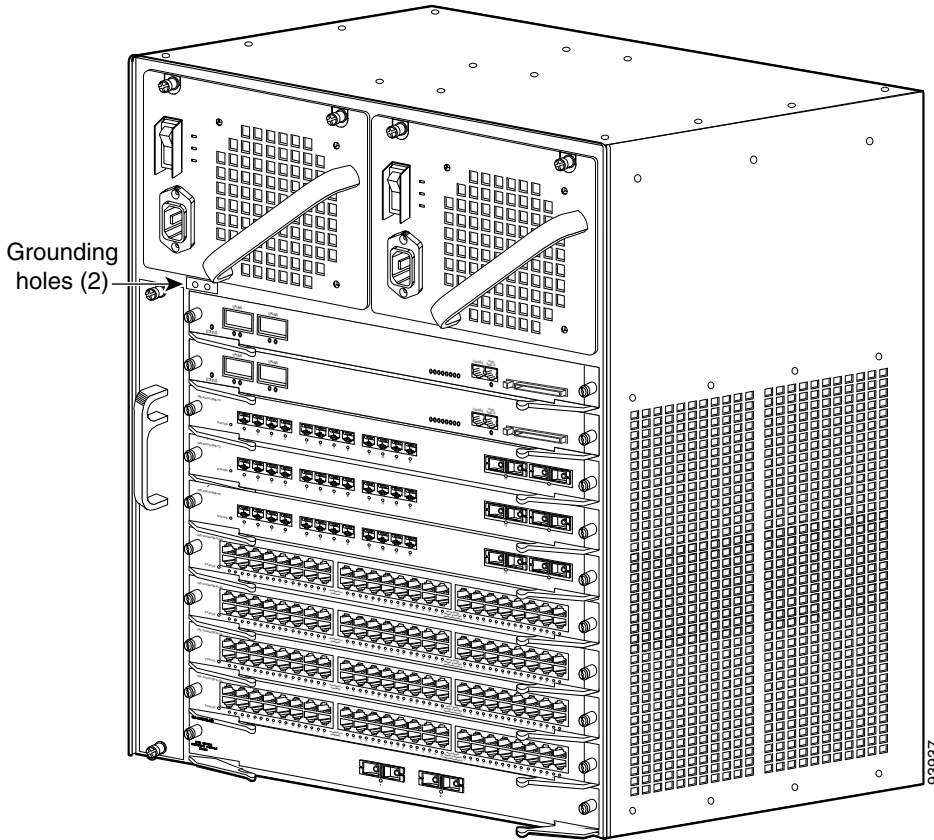
**Figure 3-15 Catalyst 4507R Grounding Holes**

Figure 3-16 Catalyst 4510R Grounding Holes



## Parts and Required Tools

**Note**

---

Some parts and required tools described in this section are not available from Cisco Systems. The grounding lug and associated screws are included with the accessory kit.

---

To make an adequate grounding connection, you will need the following parts and tools:

- Grounding lug—The grounding lug has two #10 AWG holes spaced 0.63 in center to center. A Panduit LCDX6-10A-L or Pencom EL1033 lug may be used if the lug from the accessory kit has been misplaced.
- Two M4 (metric) hex-head screws.
- One grounding wire (6 AWG recommended)—The length of the grounding wires depends on the location of your switch within the site and its proximity to proper grounding facilities.
- Number 2 Phillips screwdriver.
- Crimping tool—This tool must be large enough to accommodate the girth of the grounding lug when you crimp the grounding cable into the lug.
- Wire-stripping tool.



## Connecting System Ground and Power

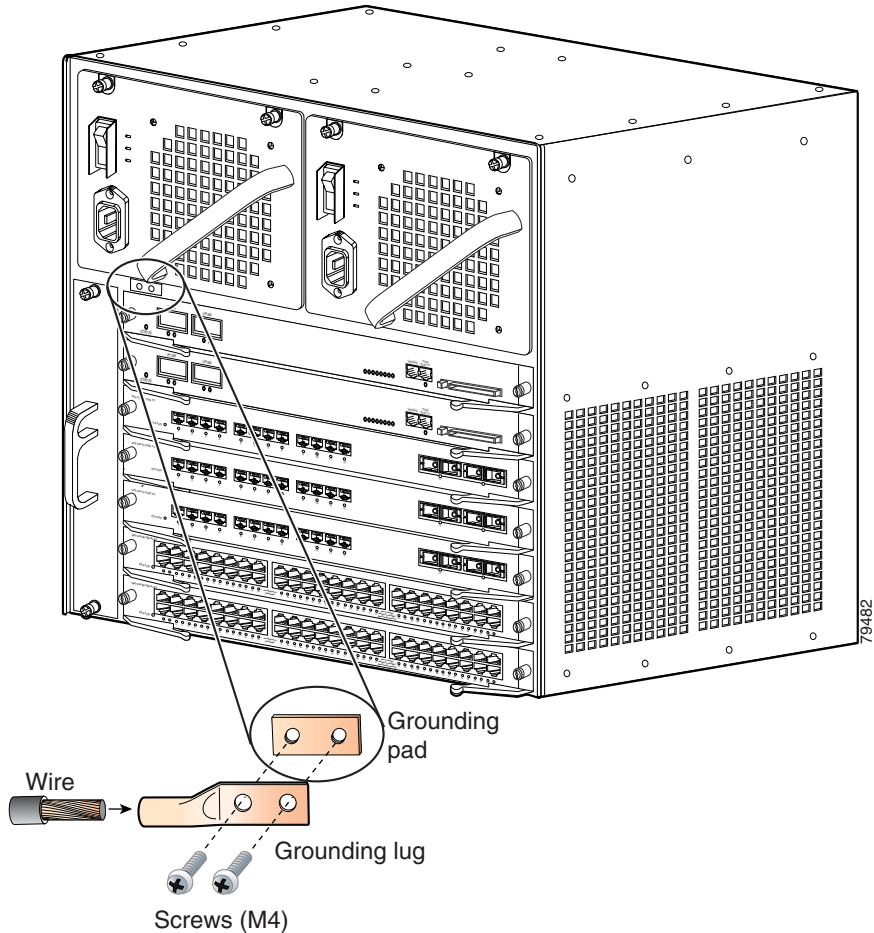
This section describes how to connect the Catalyst 4500 series switches to earth ground. The system ground connection is required if FXS modules are installed or if this equipment is installed in a US or European Central Office. You must complete this procedure before connecting system power or turning on your switch.

To attach the grounding lug and cable to the grounding pad on your Catalyst 4500 series switch, perform the following steps:

- 
- Step 1** Using a wire-stripping tool, remove approximately 0.75 inches (19 mm) of the covering from the end of the grounding wire.
  - Step 2** Insert the stripped end of the grounding wire into the open end of the grounding lug (Figure 3-17).
  - Step 3** Using a crimping tool, secure the grounding wire in place in the grounding lug.
  - Step 4** Locate the grounding pad on the switch.

See Figure 3-13 for the location of the grounding holes on the Catalyst 4503 switch, Figure 3-14 for the location on the Catalyst 4506 switch, Figure 3-15 for the location on the Catalyst 4507R switch, and Figure 3-16 for the location on the Catalyst 4510R switch.

**Figure 3-17** Connecting System Ground on the Switch



- Step 5** Remove the label that covers the grounding pad.
- Step 6** Place the grounding lug against the grounding pad, aligning the holes. Insert the two M4 screws through the holes in the grounding lug and grounding pad (Figure 3-15 and Figure 3-17).

Ensure that the grounding lug and the attached wire will not interfere with other switch hardware or rack equipment.

**Step 7** Tighten the screws to secure the grounding lug to the grounding pad.

**Step 8** Repeat steps 1 through 3 to prepare the other end of the grounding wire and connect it to an appropriate grounding point at your site to ensure adequate earth ground for the switch.

**Step 9** Connect the power supply cords.

The switch comes on when the cords are connected and the power supply on/off switch is on.



---

**Note** This equipment is suitable for connection to intra-building wiring only.

---



---

**Note** If you are using a DC power supply, the DC return connection to this system should remain isolated from the system frame and chassis (DC-I).

---

This completes the installation of the Catalyst 4500 series switches.

---

At this point you should use the RJ-45-to-RJ-45 rollover cable to connect the console port to a PC that runs terminal emulation software. Configure your terminal emulation program for 9600 baud, 8 data bits, no parity, and 1 stop bit. With this console connection, you can configure the switch as discussed in the software configuration guide appropriate for your switch's software release, and monitor the software as the switch goes through its startup routine. The pinout for the console port is detailed in the module installation guide at: [http://www.cisco.com/univercd/cc/td/doc/product/lan/cat4000/hw\\_doc/mod\\_inst/0aspecs.htm#wp1003732](http://www.cisco.com/univercd/cc/td/doc/product/lan/cat4000/hw_doc/mod_inst/0aspecs.htm#wp1003732)





## Removing and Replacing FRUs

---



**Warning**

**Read the installation instructions before connecting the system to the power source.** Statement 1004

---



**Warning**

**Only trained and qualified personnel should be allowed to install, replace, or service this equipment.** Statement 1030

---



**Warning**

**This equipment must be grounded. Never defeat the ground conductor or operate the equipment in the absence of a suitably installed ground conductor. Contact the appropriate electrical inspection authority or an electrician if you are uncertain that suitable grounding is available.** Statement 1024

---



**Warning**

**Before working on equipment that is connected to power lines, remove jewelry (including rings, necklaces, and watches). Metal objects will heat up when connected to power and ground and can cause serious burns or weld the metal object to the terminals.** Statement 43

---



**Warning**

**Ultimate disposal of this product should be handled according to all national laws and regulations.** Statement 1040

---

This chapter tells you how to remove and replace Catalyst 4500 series field-replaceable units (FRUs). The information is presented in these sections:

- Removing and Replacing the Power Supply, page 4-2
- Removing and Replacing the Chassis Fan Assembly, page 4-18
- Replacing Backplane Modules on a Catalyst 4507R or 4510R Switch, page 4-24

For instructions on installing and replacing supervisor engine and switching modules, refer to the *Catalyst 4500 Series Module Installation Guide*.

## Removing and Replacing the Power Supply

This section describes how to remove and install the AC-input power supply and DC-input power supply for the Catalyst 4500 series switches. This information is presented in the following sections:

- Required Tools, page 4-5
- Removing an AC-Input Power Supply, page 4-5
- Installing an AC-Input Power Supply, page 4-8
- Removing a DC-Input Power Supply, page 4-11
- Installing a DC-Input Power Supply, page 4-16



### Warning

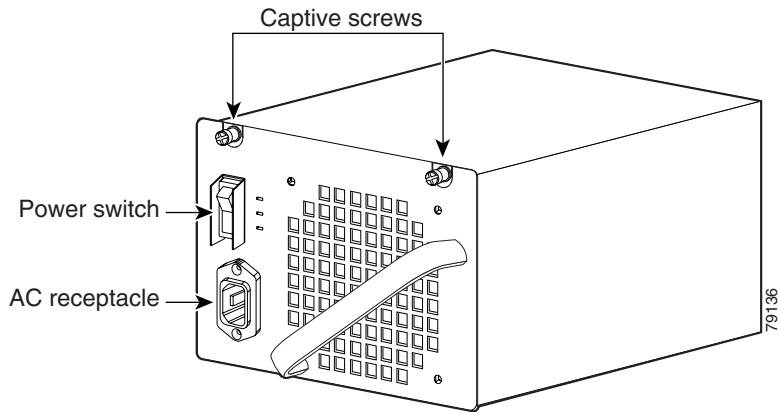
---

**Hazardous voltage or energy is present on the backplane when the system is operating. Use caution when servicing.** Statement 1034

---

Figure 4-1 and Figure 4-2 show the AC-input power supplies. Figure 4-3 and Figure 4-4 show a the DC-input power supplies. Locate your power supply and notice the location of the captive installation screws.

**Figure 4-1 AC-Input Power Supply**



**Figure 4-2 4200 W Dual-Input AC Power Supply**

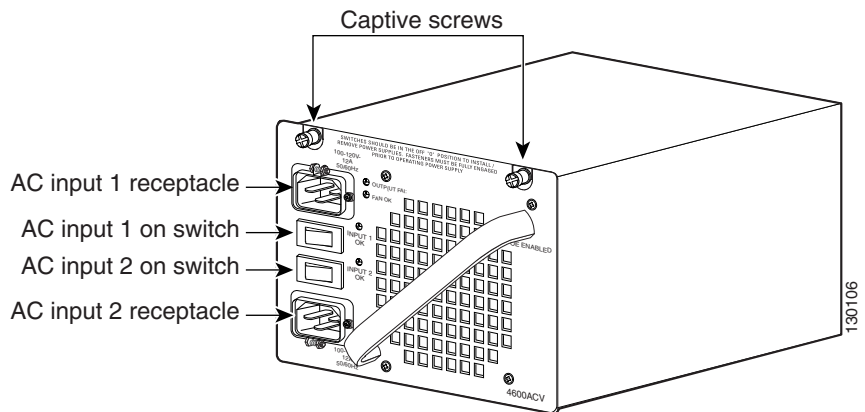


Figure 4-3 DC-Input Power Supply

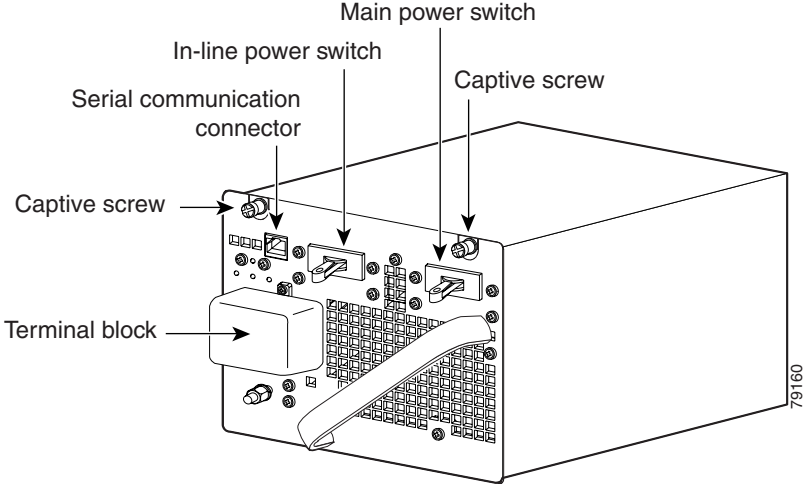
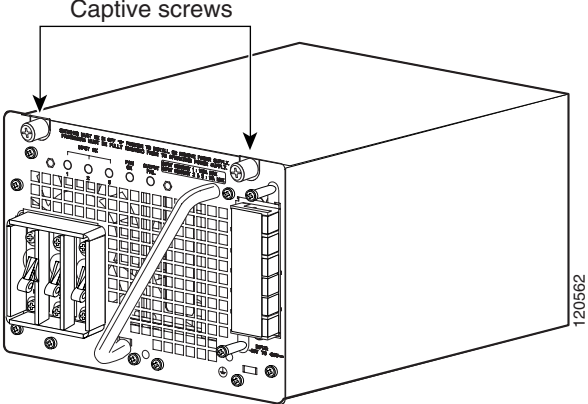


Figure 4-4 1400 W DC Triple-input Power Supply





## Required Tools

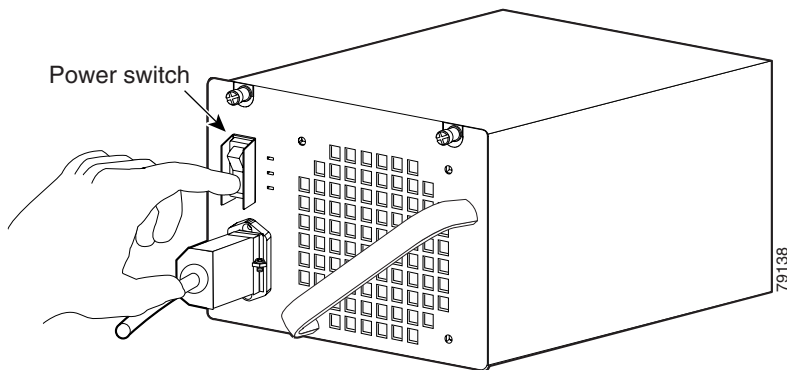
You will need a flathead or Phillips screwdriver to perform these procedures.

## Removing an AC-Input Power Supply

Follow these steps to remove the AC-input power supply:

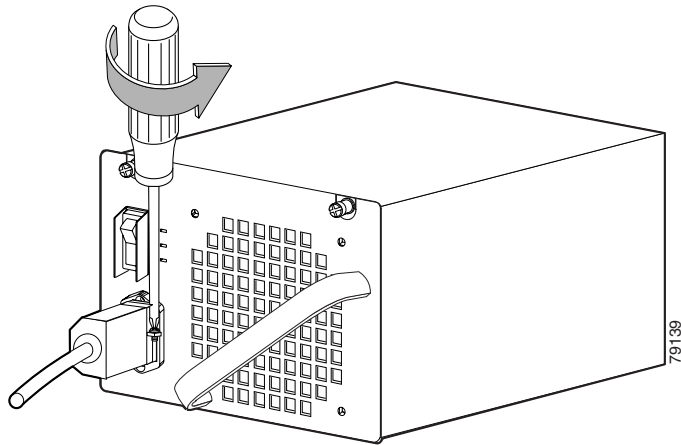
- Step 1** Press the power switch on the AC-input power supply down to the off (O) position (see Figure 4-5).

**Figure 4-5** Powering Off the Power Switch



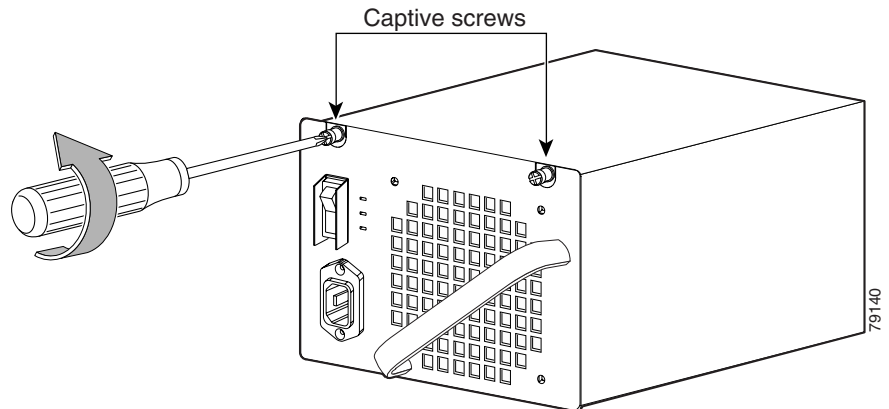
**Note** There are two on/off switches on a 4200 W AC power supply, one for each input.

- Step 2** Loosen the side-clamp screw on the right side of the power cord plug (see Figure 4-6).

**Figure 4-6** *Loosening the Side-Clamp Screw*

**Step 3** Disconnect the power cord from the power supply being removed.

**Step 4** Loosen the two captive screws (see Figure 4-7).

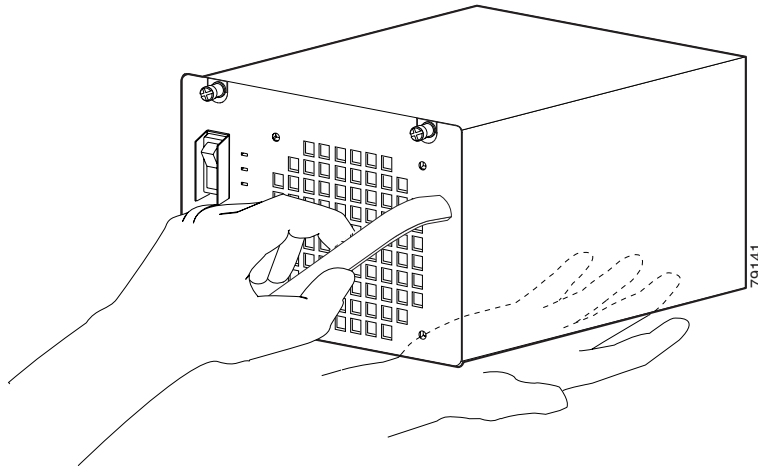
**Figure 4-7** *Loosening the Captive Screws*



**Caution** Use both hands to grasp a power supply.

**Step 5** Grasp the power supply handle with one hand. Place your other hand underneath to support the bottom of the power supply, as shown in Figure 4-8.

**Figure 4-8** Handling an AC-Input Power Supply



**Step 6** Pull the power supply out of the bay and set it aside.



**Warning** **Blank faceplates and cover panels serve three important functions: they prevent exposure to hazardous voltages and currents inside the chassis; they contain electromagnetic interference (EMI) that might disrupt other equipment; and they direct the flow of cooling air through the chassis. Do not operate the system unless all cards, faceplates, front covers, and rear covers are in place.**  
Statement 1029

**Step 7** If the power supply bay is to remain empty, install a blank power supply filler plate over the opening. Secure the filler plate with the two mounting screws and tighten them with a screwdriver.

## Installing an AC-Input Power Supply



### Warning

**The plug-socket combination must be accessible at all times, because it serves as the main disconnecting device.** Statement 1019

Follow these steps to install an AC-input power supply:

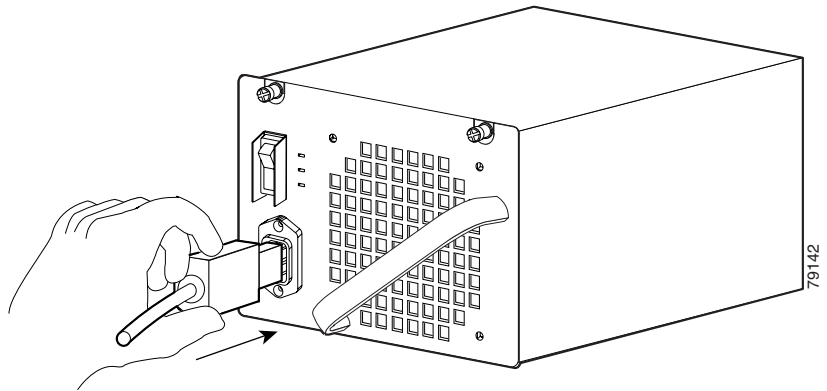
- Step 1** Make sure that the power supply you are installing is not plugged in to a power outlet and that the power cord is not connected to the power supply.
- Step 2** Remove the two Phillips-head screws from the power supply filler plate (if a filler plate is present).
- Step 3** Remove the power supply filler plate (if one is present) and set it aside.



### Caution

Use both hands to grasp a power supply.

- Step 4** Grasp the power supply handle with one hand. Place your other hand underneath to support the bottom of the power supply, as shown earlier in Figure 4-8.
- Step 5** Slide the power supply all the way into the power supply bay.
- Step 6** Using a screwdriver, tighten the two captive installation screws (see Figure 4-1) on the front panel of the AC-input power supply.
- Step 7** Make sure the power supply power switch is in the off position (O).
- Step 8** Before you connect the power supply to a power source, ensure that all site power and grounding requirements described in the *Site Preparation and Safety Guide* have been met.
- Step 9** Plug the power cord into the power supply (see Figure 4-9).

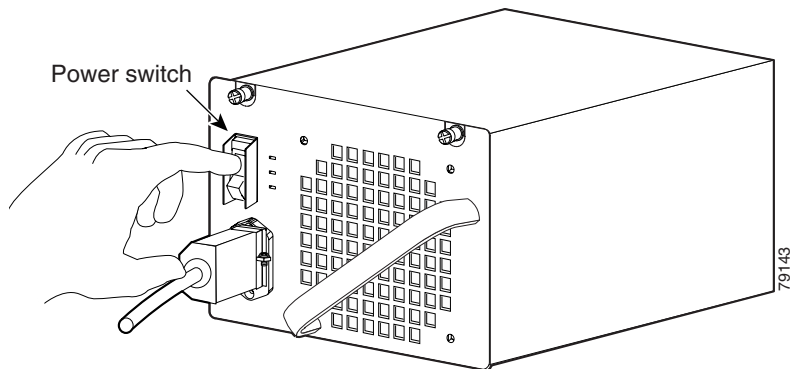
**Figure 4-9** *Plugging the Power Cord into the Power Supply*

**Step 10** Connect the other end of the power cord to an AC-power input source.

**Caution**

In a system with multiple power supplies, connect each power supply to a separate AC power source. In the event of a power source failure, if the second source is still available, it can maintain maximum overcurrent protection for each power connection.

**Step 11** Press the power switch down to the on (I) position (see Figure 4-10).

**Figure 4-10** *Powering On the Power Supply*

- Step 12** Verify power supply operation by checking the power supply's front-panel LEDs. You should see the following:
- The LED labeled GOOD is green.
  - The LED labeled FAIL is not lit.
  - The LED labeled FAN OK is green.
- Step 13** Check the power supply and system status from the system console by entering the **show system** command (Catalyst Operating System) or the **show power** command (Cisco IOS). For more information on this command, refer to the command reference publication for your switch.
- Step 14** If the LEDs or the **show system** command (Catalyst Operating System) or the **show power** command (Cisco IOS) output indicate a power problem or other system problem, see Chapter 5, "Troubleshooting," for more information.
-

## Removing a DC-Input Power Supply

This section describes how to remove a DC-input power supply.

### Required Tools

You will need the following tools to perform this procedure:

- A Phillips screwdriver
- A 10-mm wrench/socket

### Removal Procedure



#### Warning

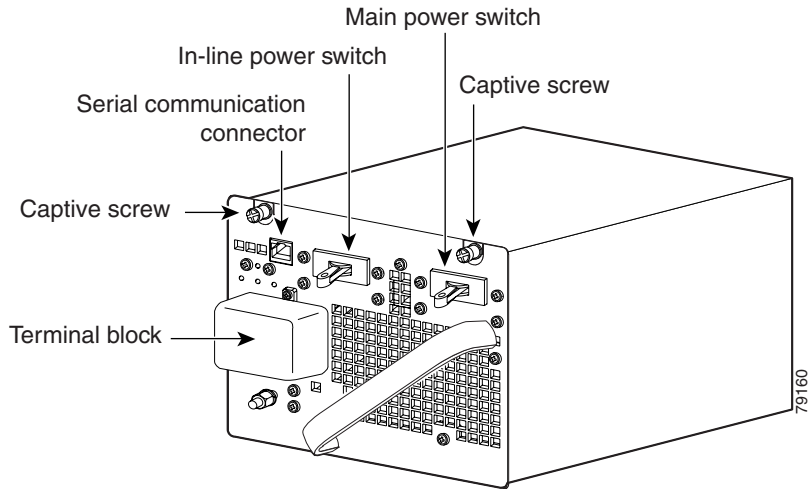
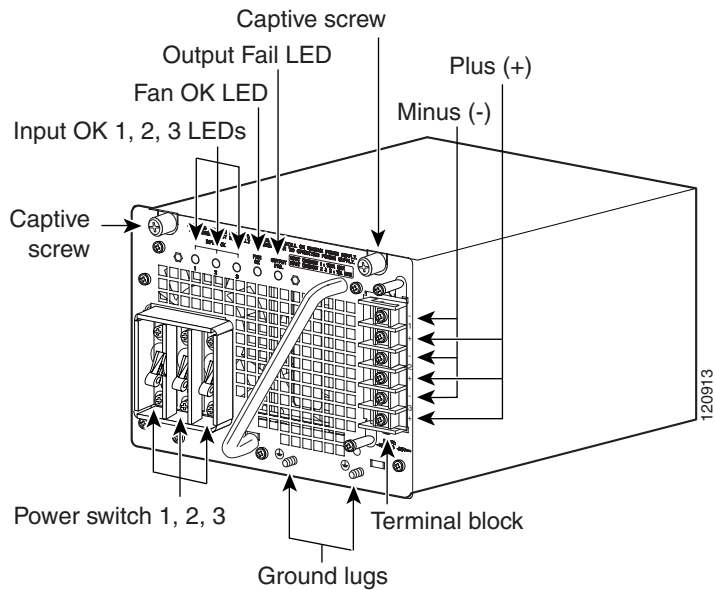
---

**Before performing any of the following procedures, ensure that power is removed from the DC circuit.** Statement 1003

---

Follow these steps to remove a DC-input power supply:

- 
- Step 1** Turn off the in-line power switch. (Single input only. The triple-input power supply does not have this switch.)
  - Step 2** Turn off the main power switch.
  - Step 3** Verify that power is off to the DC circuit on the power supply you are removing.
  - Step 4** Loosen the screw on the terminal block cover and remove it from the terminal block (see Figure 4-11 or Figure 4-12). The triple-input power supply has two screws on the cover.

**Figure 4-11 DC-Input Power Supply****Figure 4-12 DC Triple-input Power Supply**



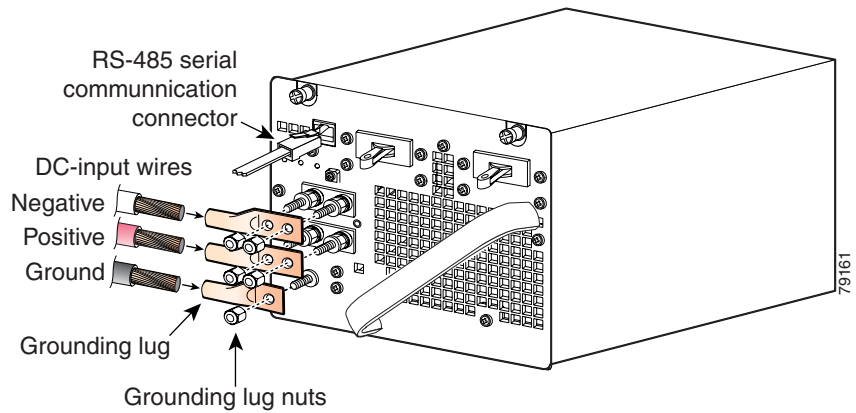
- Step 5** Disconnect the DC-input wires from the terminal block. Disconnect the ground wire last (see Figure 4-13 or Figure 4-14).



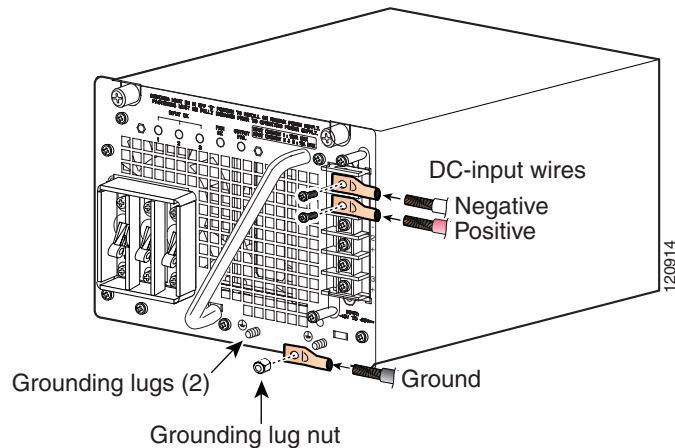
**Warning**

**When installing or replacing the unit, the ground connection must always be made first and disconnected last.** Statement 1046

**Figure 4-13** *Connecting the DC-Input Wires*

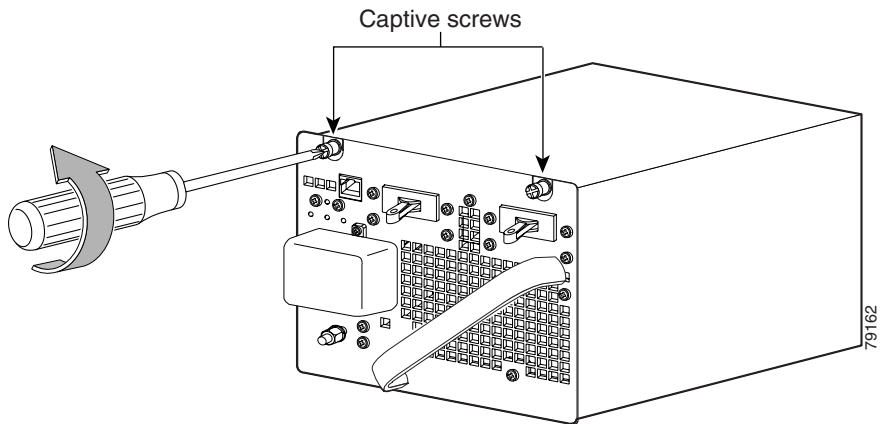


**Figure 4-14** *Connecting the DC-Input Wires (Triple-input Power Supply)*



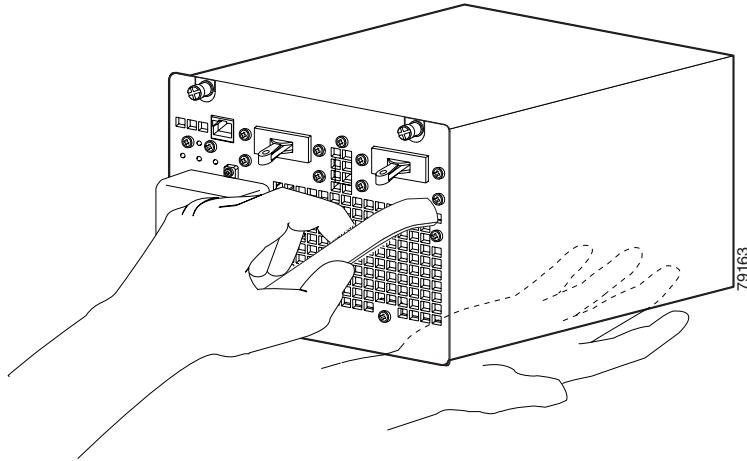
- Step 6** Using a screwdriver, loosen and remove the captive screws on the power supply. (See Figure 4-15, which shows the single input power supply. The triple-input power supply has captive screws in the same location.)

**Figure 4-15** *Loosening the Captive Screws*



- Step 7** Grasp the power supply handle with one hand. Place your other hand underneath as you slowly pull the power supply out of the bay (see Figure 4-16).

**Figure 4-16** Handling a DC-Input Power Supply



- Step 8** If the bay is to remain empty, install a blank power supply filler plate over the opening and secure it with the mounting screws. This protects the inner chassis from dust and prevents accidental contact with live voltage at the rear of the bay.



**Warning**

**Blank faceplates and cover panels serve three important functions: they prevent exposure to hazardous voltages and currents inside the chassis; they contain electromagnetic interference (EMI) that might disrupt other equipment; and they direct the flow of cooling air through the chassis. Do not operate the system unless all cards, faceplates, front covers, and rear covers are in place.**  
Statement 1029

# Installing a DC-Input Power Supply

This section describes how to install a DC-input power supply.

## Required Tools

You will need the following tools to perform this procedure:

- A Phillips screwdriver
- A 10-mm wrench/socket
- Connectors and wire for the DC circuit or circuits

## Installation Procedure



**Warning**

---

**Before performing any of the following procedures, ensure that power is removed from the DC circuit.** Statement 1003

---



**Warning**

---

**A readily accessible two-poled disconnect device must be incorporated in the fixed wiring.** Statement 1022

---



**Warning**

---

**This product requires short-circuit (overcurrent) protection, to be provided as part of the building installation. Install only in accordance with national and local wiring regulations.** Statement 1045

---



**Warning**

---

**Use copper conductors only.** Statement 1025

---



**Warning**

---

**When stranded wiring is required, use approved wiring terminations, such as closed-loop or spade-type with upturned lugs. These terminations should be the appropriate size for the wires and should clamp both the insulation and conductor.** Statement 1002

---

Follow these steps to install a DC-input power supply, connect it to a power source, and verify its operation:

- 
- Step 1** Verify that power is off to the DC circuit or circuits on the power supply you are installing.
- Step 2** Grasp the power supply handle with one hand. Place your other hand underneath it as you slowly insert the power supply into the bay (as shown earlier in Figure 4-16).
- Step 3** Using a screwdriver, tighten the captive screws on the power supply (see Figure 4-15).
- Step 4** Before you connect the power supply to a power source, ensure that all site power and grounding requirements have been met.
- Step 5** Connect the DC-input wires to the power supply terminal block. The proper wiring sequence is ground to ground, positive to positive, and negative to negative (see Figure 4-13 or Figure 4-14 depending on your installation).

The 1400W triple-input power supply has two grounding posts; use the one that is most convenient for your installation.

**Warning**

**When installing or replacing the unit, the ground connection must always be made first and disconnected last.** Statement 1046

- 
- Step 6** Replace the terminal cover.
- Step 7** Connect the other end of the power cords to a DC-power input source.

**Caution**

In a system with multiple power supplies or a single triple-input power supply, connect each power supply to a separate DC power source. In the event of a power source failure, if the second source is still available, it can maintain maximum overcurrent protection for each power connection.

- Step 8** Verify power supply operation by checking the power supply's front-panel LEDs. You should see the following:
- The LED labeled INPUT OK is green.
  - The LED labeled OUTPUT FAIL is not lit.
- Step 9** Check the power supply and system status from the system console by entering the **show system** command (Catalyst Operating System) or the **show power** command (Cisco IOS). For more information on these commands, refer to the command reference publication for your switch and software.
- Step 10** If the LEDs or the **show system** command (Catalyst Operating System) or the **show power** command (Cisco IOS) output indicate a power problem or other system problem, see Chapter 5, "Troubleshooting," for more information.
- 

## Removing and Replacing the Chassis Fan Assembly

This section describes how to remove and install the chassis fan assembly for the Catalyst 4500 series switches. See Figure 4-17 for the Catalyst 4503 system fan assembly, Figure 4-18 for the Catalyst 4506 system fan assembly, Figure 4-19 for the Catalyst 4507R system fan assemblies, and Figure 4-20 for the Catalyst 4510R system fan assemblies.

Figure 4-17 Catalyst 4503 System Fan Assembly

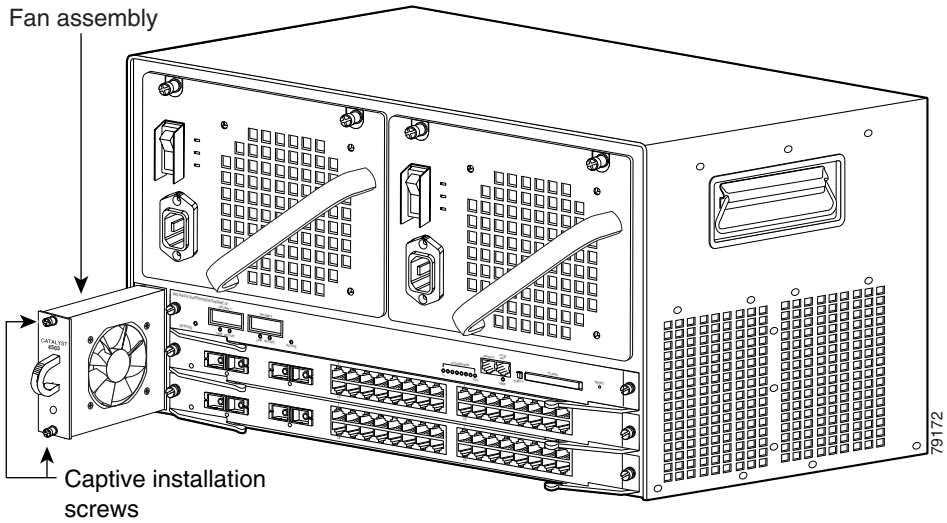


Figure 4-18 Catalyst 4506 System Fan Assembly

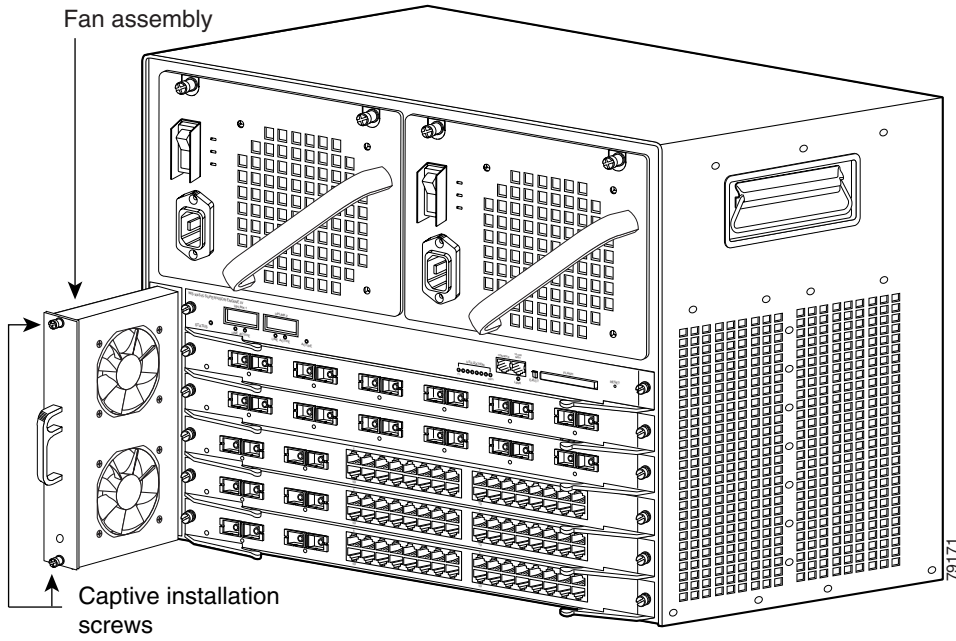




Figure 4-19 Catalyst 4507R System Fan Assembly

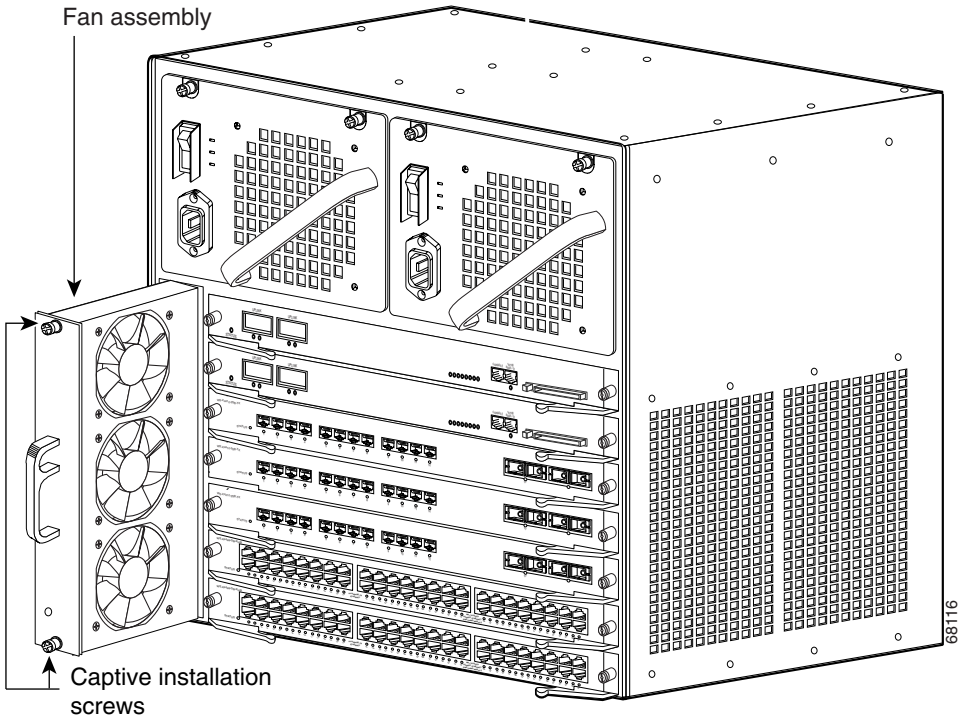
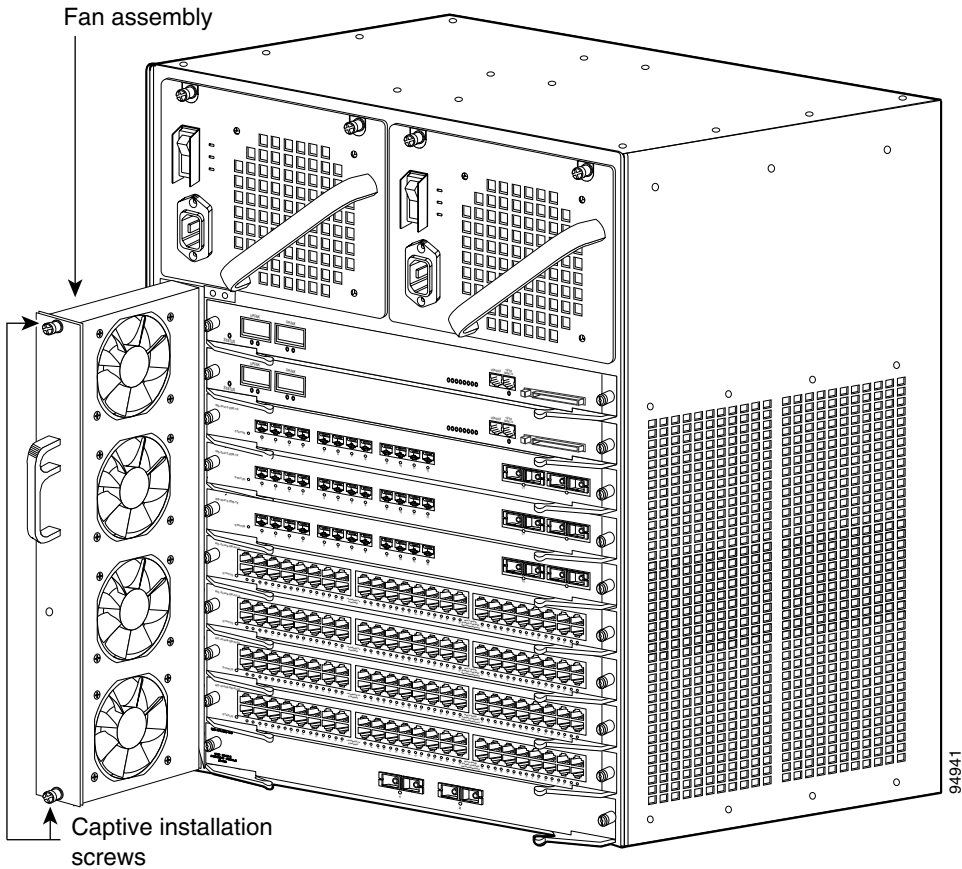


Figure 4-20 Catalyst 4510R System Fan Assembly



## Required Tools

You will need a Phillips screwdriver for the following two procedures.

## Removing the Fan Assembly

**Warning**

**When removing the fan tray, keep your hands and fingers away from the spinning fan blades. Let the fan blades completely stop before you remove the fan tray.** Statement 258

**Caution**

Never operate the system for an extended period if the fan assembly is removed or if it is not functioning properly. An over-temperature condition can cause severe equipment damage.

Follow these steps to remove the existing chassis fan assembly:

- Step 1** Loosen the two captive installation screws on the fan assembly by turning them counterclockwise.
- Step 2** Grasp the fan assembly with both hands and pull it outward; gently move it side to side if necessary to unseat it from the backplane. Slide it out of the chassis and place it in a safe place.

## Installing the Fan Assembly

Follow these steps to install the new fan assembly:

- Step 1** Hold the fan assembly with the fans facing to the right.
- Step 2** Place the fan assembly into the fan assembly bay so it rests on the chassis, and then lift the fan assembly up slightly, aligning the top and bottom guides.
- Step 3** Slide the fan assembly into the chassis until the two captive installation screws make contact with the chassis.
- Step 4** Using a screwdriver, tighten the two captive installation screws by turning them clockwise.

## Verifying the Installation

**Note**

---

To check the operation of the fans, you need to power up the chassis.

---

Follow these steps to verify that the new fan assembly was installed correctly:

- 
- Step 1** Listen for the fans; you should immediately hear them operating. If you do not hear them, ensure that the fan assembly is inserted completely in the chassis and that the faceplate is flush with the switch back panel.
  - Step 2** The fan tray LED should light and be green.
  - Step 3** If after several attempts the fans do not operate, or if you experience trouble with the installation (for instance, if the captive installation screws do not align with the chassis holes), contact the Cisco TAC for assistance.
- 

## Replacing Backplane Modules on a Catalyst 4507R or 4510R Switch

There are 5 redundancy modules (also called mux buffers) and 1 clock module on a Catalyst 4507R chassis backplane. A Catalyst 4510 has 8 redundancy modules on its backplane. They are accessible from the front if the switching modules and supervisor engines are removed. There are two types of redundancy modules, and they are interchangeable.

The clock module replacement procedure is identical to the redundancy module replacement procedure, the connectors are the same. These modules are not hot-swappable, the switch must be taken out of service to replace them.

To replace the backplane modules:

- 
- Step 1** Make sure you are grounded with an ESD strap.
  - Step 2** Turn off the power to the chassis.

**Step 3** Remove all supervisor engines and switching modules from the chassis, and find the backplane modules you need to replace.



---

**Note** Keep a record of switching module and their slots, so that you can put them back correctly.

---



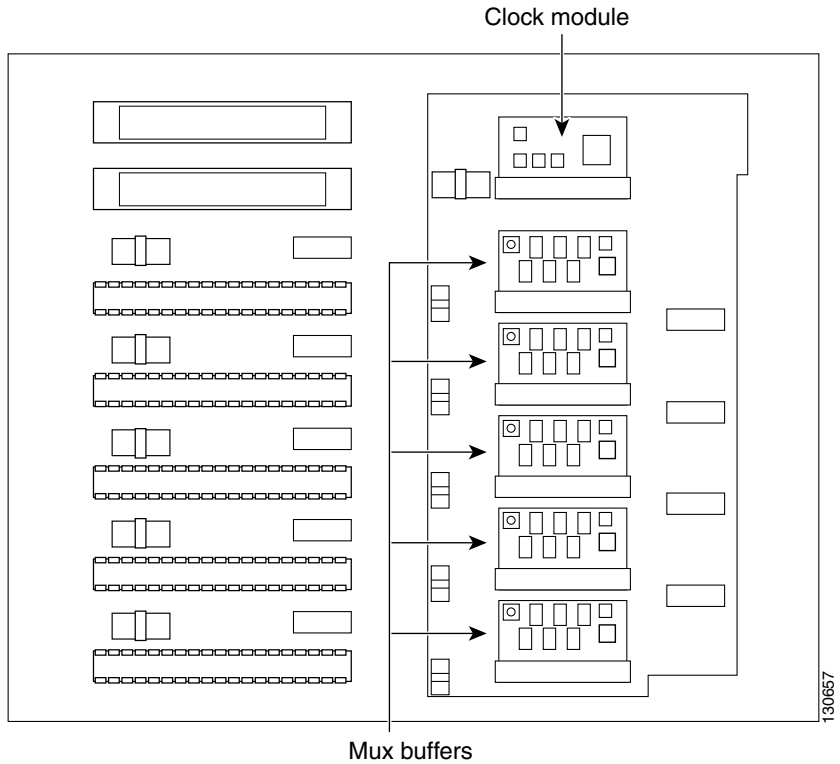
---

**Note** Generic switching module replacement procedures are documented at:  
[http://www.cisco.com/univercd/cc/td/doc/product/lan/cat4000/hw\\_doc/gmddf\\_nt.htm#wp21932](http://www.cisco.com/univercd/cc/td/doc/product/lan/cat4000/hw_doc/gmddf_nt.htm#wp21932)

---

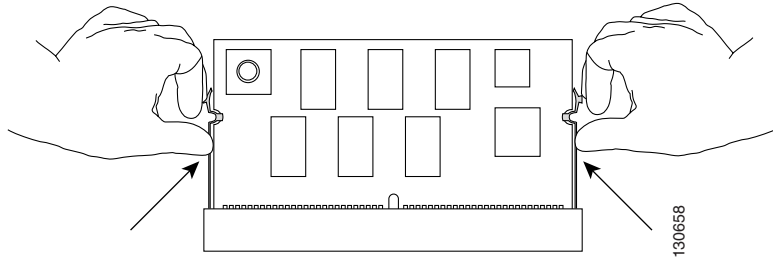
Figure 4-21 shows the front view of the backplane with supervisors and switching modules removed.

**Figure 4-21 Catalyst 4507R Backplane**



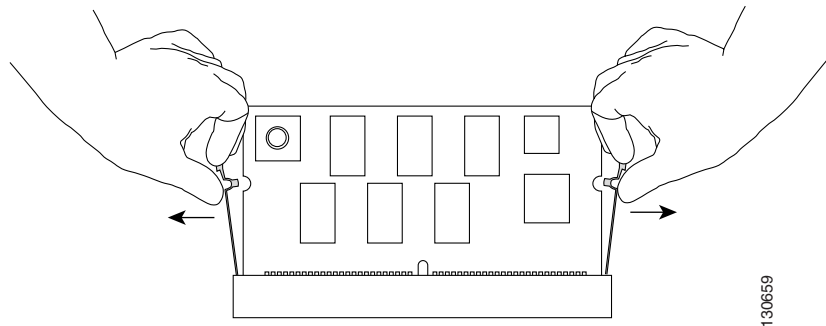
- Step 4** If you are removing a clock module, remove the two screws that attach the module to the backplane.
- Step 5** Find the seating levers on both sides of the connector for the module you wish to replace. (See Figure 4-22.)

**Figure 4-22** Finding the Seating Levers



- Step 6** To release the module from its connector, pull the levers outward with your fingernails. The module will pop out slightly. (See Figure 4-23.)

**Figure 4-23** Releasing the Module

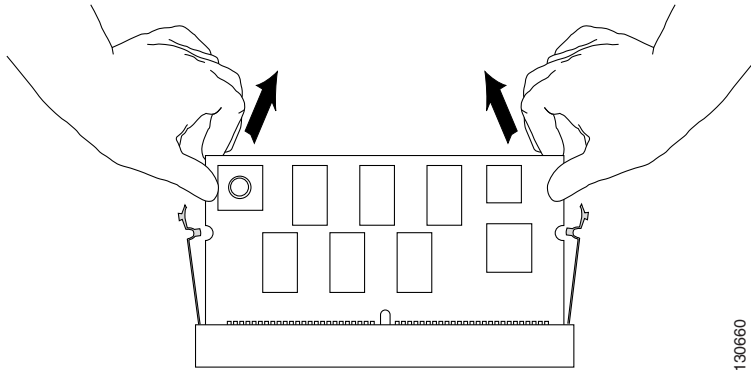


- Step 7** Pull out the module while holding the top left and top right corners. (See Figure 4-24.)



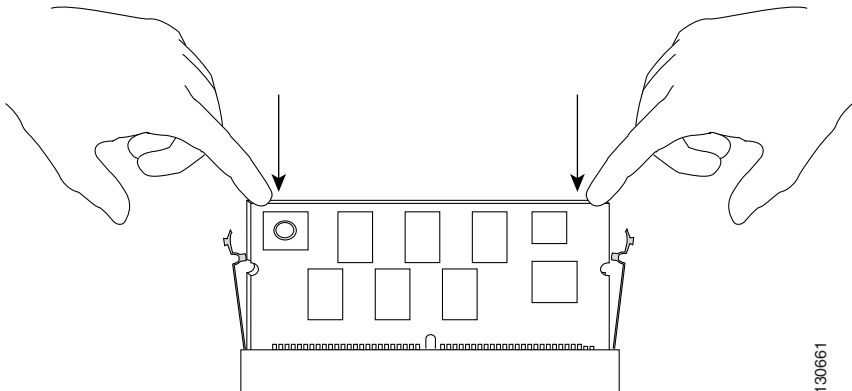
**Note** When handling the modules, do not touch the chips or the gold edge contacts on the module.

**Figure 4-24 Removing the Module**



- Step 8** Put the replacement module in at roughly a 30 degree angle, and gently push the module down. Make sure you apply force evenly on the left and right. (See Figure 4-25.)

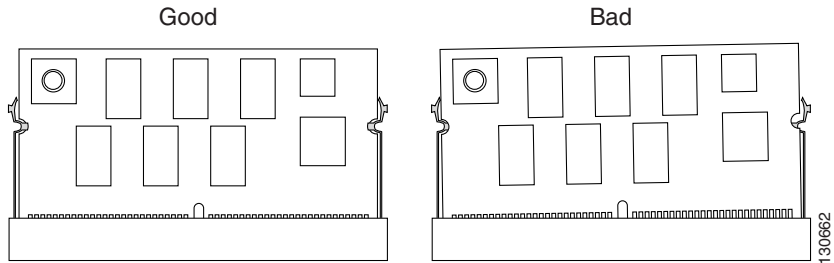
**Figure 4-25 Seating the Replacement Module**





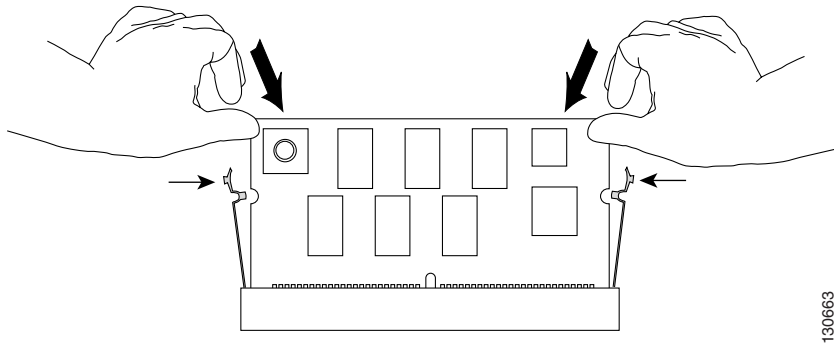
**Step 9** Make sure the module is fully seated. (See Figure 4-26.)

**Figure 4-26** *Correct Module Seating*



**Step 10** Push the module toward the back of the chassis and make sure it is clipped in by the levers on both sides. (See Figure 4-27.)

**Figure 4-27** *Securing the Module*



**Step 11** Repeat Step 4 to Step 10 for the other modules you need to replace.

**Step 12** If you are installing a clock module, secure the module to the backplane using the screws from the earlier removal.

**Step 13** Replace the supervisor engines and switching modules to their previous slots.

**Step 14** Restore power to the switch.

## Verify the New Modules

After the switch is reassembled and power is restored, connect a terminal to the supervisor engine and monitor the boot process. Look for the following messages (or any others), which may indicate a problem with the replaced modules:

```
00:00:20: %C4K_SUPERVISOR-2-MUXBUFFERNOTPRESENT: Mux buffer
(WS-X4K-MUX) 3 is not present
00:00:20: %C4K_SUPERVISOR-2-MUXBUFFERNOTPRESENT: Mux buffer
(WS-X4K-MUX) 4 is not present
00:00:20: %C4K_SUPERVISOR-2-MUXBUFFERNOTPRESENT: Mux buffer
(WS-X4K-MUX) 7 is not present
```

The above messages (either at startup or output from a **show logging** command) indicate that the mux-buffer is not present in slots 3, 4 and 7. You need to reinsert and reseal the modules in those slots.

If the switch has already started up, you may also verify the correct function of the new modules with the **show logging** command.



# Troubleshooting

---

If your system has problems during start up or operation, use the information in this chapter to help isolate the cause. Problems with the initial startup are often caused by a switching module that has become dislodged from the backplane or a power cord that is disconnected from the power supply.

Although temperature conditions above the maximum acceptable level rarely occur at initial startup, some environmental monitoring functions are included in this chapter because they also monitor power supply output voltages.

Information about troubleshooting software features and configuration problems is not discussed in this chapter.

The information is presented in these sections:

- System Boot Verification, page 5-2
- Problem Solving to the System Component Level, page 5-3
- Using LEDs to Identify Startup Problems, page 5-4
- Troubleshooting the Power Supply, page 5-6
- Troubleshooting the Fan Assembly, page 5-8
- Troubleshooting Backplane Modules, page 5-9
- Troubleshooting Switching Modules, page 5-10
- Troubleshooting Supervisor Engines, page 5-13
- Contacting the Cisco Technical Assistance Center, page 5-16

**Note**

---

This chapter covers only the chassis component hardware aspects of troubleshooting. For configuration issues, refer to the software configuration guide or command reference for your switch.

---

## System Boot Verification

When the initial system boot is complete, verify the following:

- That the power supplies are supplying power to the system  
The LEDs should be green. Use the **show environment** Cisco IOS command to view power supply activity.
- That the system fan assembly is operating  
Listen for fan activity. The Fan tray LED should be green during operation.
- That the system software boots successfully  
Hook up a terminal and view the startup banner. Use an RJ-45-to-RJ-45 rollover cable to connect the console port to a PC with terminal emulation software set for 9600 baud, 8 data bits, no parity, and 1 stop bit. Watch for any messages after startup.
- That the supervisor engine and all switching modules are installed properly in their slots, and that each initialized without problems

If all of these conditions are met and the hardware installation is complete, refer to the software configuration guide and command reference publications for your switch so that you can troubleshoot the software.

If any of these conditions is not met, use the procedures in this chapter to isolate and, if possible, resolve the problem.

# Problem Solving to the System Component Level

The key to success when troubleshooting the system is to isolate the problem to a specific system component. Your first step is to compare what the system *is doing* to what it *should be doing*. Because a startup problem can usually be caused by a single component, it is more efficient to isolate the problem to a subsystem rather than troubleshoot each separate component in the system.

The switch consists of the following subsystems:

- Power supply—Includes the power supplies and power supply fans. If you suspect problems with the power supplies, see the “Troubleshooting the Power Supply” section on page 5-6.
- Fan assembly—The system fan assembly should be operating whenever system power is on. You should be able to hear the fan assembly when the system is operating. If you determine that the fan assembly is not operating, see the “Troubleshooting the Fan Assembly” section on page 5-8.
- Supervisor engine—The supervisor engine contains the operating system software, so check the supervisor engine if you have trouble with the system software. Status LEDs on the supervisor engine indicate whether the supervisor engine has initialized correctly. If there is a problem with the supervisor engine, try reseating the supervisor engine in the chassis and restarting the switch. For more information about LED meanings, refer to the “LEDs” section on page 1-24. If the supervisor engine does not boot correctly after reseating and restarting, contact Cisco TAC. See the “Contacting the Cisco Technical Assistance Center” section on page 5-16.
- Switching modules—The LEDs labeled STATUS on each switching module indicate whether the switching module has been initialized correctly. The supervisor engine must be operating properly before the switching module will initialize. If a switching module is improperly installed in the switch, it will not function, so if the supervisor engine is working but a switching module is not, try reseating the module. For more information, see the “Troubleshooting Switching Modules” section on page 5-10. If you determine that the switching module is not operating, contact Cisco TAC as described in the “Contacting the Cisco Technical Assistance Center” section on page 5-16.

# Using LEDs to Identify Startup Problems

All system states in the startup sequence are indicated using LEDs. By checking the LEDs, you can determine when and where the system failed in the startup sequence. If you have problems after the switch is on, refer to the configuration procedures in the software configuration guide for your switch.

After you connect the power cords to your Catalyst 4500 series switch, follow these steps to determine whether your system is operating properly:

---

**Step 1** Check the power supply LEDs:

- The LED labeled GOOD should turn green when power is applied to the supply. The LED should remain on during normal system operation.
- If the LED labeled GOOD does not light, or if the LED labeled FAIL lights, see the “Troubleshooting the Power Supply” section on page 5-6.



---

**Note** If a power supply is installed and not connected to a power source, power supply LEDs will indicate a failure.

---

**Step 2** Listen for the system fan assembly. If you do not immediately hear it begin to operate, see the “Troubleshooting the Fan Assembly” section on page 5-8.**Step 3** Check that the LEDs on the supervisor engine light as follows:

- The LED labeled STATUS flashes orange once and stays orange during diagnostic boot tests.
  - It turns green when the module is operational (online).
  - If the system software is unable to start up, this LED stays orange.
  - If the LED labeled STATUS on the supervisor engine front panel is red or orange, connect a console to the management port and use the **show environment** command to check for possible problems. For more information, see the “Troubleshooting Supervisor Engines” section on page 5-13.
- The Ethernet management port LED turns green when the module is operational (online) and a link is established with another network device. If no signal is detected, the LED labeled LINK turns off.

**Step 4** Verify that the LEDs labeled STATUS on each switching module are green when the supervisor engine completes initialization.

This LED indicates that the supervisor engine and switching modules are receiving power, have been recognized by the supervisor engine, and contain a valid Flash code version. However, this LED does not indicate the state of the individual interfaces on the switching modules. If an LED labeled STATUS is red or orange, try reseating the switching module or supervisor engine and restarting the switch. If the problem persists, contact Cisco TAC. See the “Contacting the Cisco Technical Assistance Center” section on page 5-16.

**Step 5** If the boot information and system banner are not displayed, verify that the terminal is set for 9600 baud, 8 data bits, no parity, and 1 stop bit and connected properly to the console port.

---

# Troubleshooting the Power Supply

To help isolate a power subsystem problem, follow these steps:

- 
- Step 1** Check whether the power supply LED labeled GOOD is on or the LED labeled FAIL is on. (on the DC multi-input power supply, the LEDs are labeled INPUT 1, 2, or 3 or OUTPUT FAIL.)
- Step 2** If the LED labeled GOOD is off or if the LED labeled FAIL is on, take the following steps:
- Ensure that the power supply is flush with the back of the chassis.
  - Unplug the power cord, loosen and reinstall the power supply, tighten the captive installation screws, and then plug in the power cord.
- Step 3** If the LED labeled GOOD remains off, there might be a problem with the AC source or the power cable. Connect the power cord to another power source if one is available.
- Step 4** If the LED labeled GOOD fails to light after you connect the power supply to a new power source, replace the power cord.



---

**Note** If this unit has more than one power cord, repeat Step 1 through Step 4 for each power input.

---

- Step 5** If the LED labeled GOOD still fails to light when the switch is connected to a different power source with a new power cord, the power supply is probably faulty. Replace the power supply.
- Step 6** If the LED labeled FAN OK fails to light when the switch is connected to a power source with a known good power cord, there is a malfunction in the fan that cools the power supply. Replace the power supply.
- Step 7** If a second power supply is available, install it in the second power supply bay.
- Step 8** Check that the LED labeled GOOD is on for the additional power supply. Check that the LED labeled FAIL is off.
- Step 9** If the LEDs are not on, repeat the previous procedure to troubleshoot the second power supply.



If you are unable to resolve the problem, or if you determine that either a power supply or backplane connector is faulty, contact the Cisco Technical Assistance Center (TAC) for instructions.

---

## Troubleshooting Power Problems using Cisco IOS

Check for system messages related to the power supply, and refer to the system message guide for your software release. You may need to add a power supply or upgrade to a larger one for your current configuration or verify that the switches are set properly. Connect a terminal to the console port, and look for any of the following system messages:

```
C4K_CHASSIS-2-INLINEPOWEROFF
C4K_CHASSIS-2-INSUFFICIENTPOWERDETECTED
C4K_CHASSIS-2-INSUFFICIENTPOWERSHUTDOWN
C4K_CHASSIS-3-INSUFFICIENTPOWER
C4K_CHASSIS-3-INSUFFICIENTPOWERSUPPLIESDETECTED
C4K_CHASSIS-3-MIXINPOWERDETECTED
C4K_IOSMODPORTMAN-3-UNKNOWNPOWERSUPPLY
C4K_IOSMODPORTMAN-4-INLINEPOWEROVERMAX
C4K_IOSMODPORTMAN-4-INLINEPOWERSUPPLYBAD
C4K_IOSMODPORTMAN-4-POWERSUPPLYBAD
C4K_IOSMODPORTMAN-4-POWERSUPPLYFANBAD
C4K_SUPERVISOR-3-POWERSUPPLYSTATUSREADFAILED
C4K_SUPERVISOR-3-POWERSUPPLYSEEPROMREADFAILED
C4K_SUPERVISOR-3-POWERSUPPLYSEEPROMINVALID
C4K_SUPERVISOR-4-INLINEVOLTAGEOUTOFRANGE
```

You may also use the **show environment status powersupply**, **show module all**, and **show power** commands to monitor PS status, load, and activity.

The 1400 W DC multi-input supply can not be used with other power supply types, but other power supplies in this product line work with the other types during an upgrade. If you mix power supplies in a Catalyst 4500 series chassis, the switch detects the type of power supply in power supply bay 1 (PS1) and ignores the power supply in power supply bay 2 (PS2) while issuing system messages and showing the power supply in bay 2 as in the err-disable state in the output of the **show power** command. When the power supply in bay 1 is removed, the switch recognizes the power supply in bay 2, and you may then put a new matching power supply in bay 1. Both supplies should now resume normal function.

## Troubleshooting the Fan Assembly



### Note

---

All fans must be operating or a failure will occur.

---

Environmental problems may initially appear to be problems with the fan tray. To help isolate a fan assembly problem, follow these steps:

- 
- Step 1** Check the status LED on the fan tray.
- If the LED is off and the rest of the system is functioning, the fan tray is not getting power or is not seated correctly on the backplane.
  - If the LED is green, the fans are operating normally. There may be conditions impairing fan performance, but they are minimal in impact.
  - If the LED is red, one or more fans have failed.
- Step 2** Connect a terminal and determine the fan tray status shown by the **show environment status** CLI command.
- Step 3** Look for system messages reporting a temperature problem or problem with the fans. Individual messages may suggest different solutions. Connect a terminal to the console port, and look for any of the following system messages:

```
C4K_CHASSIS-2-INSUFFICIENTFANSDETECTED
C4K_CHASSIS-2-INSUFFICIENTFANSSHUTDOWN
C4K_IOSMODPORTMAN-4-CRITICALTEMP
C4K_IOSMODPORTMAN-4-FANTRAYBAD
```

C4K\_IOSMODPORTMAN-4-FANTRAYPARTIALFAILURE  
C4K\_IOSMODPORTMAN-4-FANTRAYREMOVED  
C4K\_SUPERVISOR-3-FANTRAYREADFAILED  
C4K\_SUPERVISOR-3-FANTRAYSEEPROMREADFAILED  
C4K\_SUPERVISOR-3-FANTRAYSEEPROMINVALID  
C4K\_IOSMODPORTMAN-4-TEMPHIGH  
C4K\_IOSMODPORTMAN-4-TEMPUNDERCRITICAL  
C4K\_CHASSIS-2-OVERHEATINGSHUTDOWN

- Step 4** Determine whether the airflow is restricted or if the ambient temperature in the room is too warm.
- Step 5** Determine whether the power supply is functioning properly. See the “Troubleshooting the Power Supply” section on page 5-6.
- Step 6** Verify that the fan assembly is properly seated in the backplane by loosening the captive installation screws, removing the fan assembly, and reinstalling it.
- Step 7** Restart the system.
- Step 8** Verify that all fans are operating. You should hear the fans at system start.
- Step 9** If the system is still detecting a fan assembly failure, contact the Cisco TAC for assistance.
- 

## Troubleshooting Backplane Modules

The Cisco Catalyst 4500 Series redundancy scheme uses removable redundancy modules (also called mux-buffers), on the passive backplane to switch traffic to the active supervisor engine. There is one redundancy module per switching module. Redundancy modules and a redundant clock ship standard with every Cisco Catalyst 4507R and 4510R chassis. Spare redundancy modules (**C4K-MUX=**) and a clock module (**C4K-CLOCK=**) are available for serviceability.

The following conditions indicate that you may need to replace the redundancy modules and clock module:

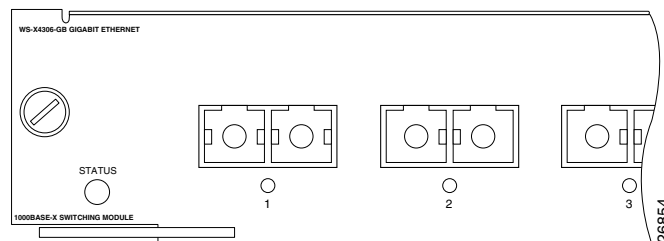
- The switch powers down and stays down for a few minutes to a few days for no clear reason.
- The output-fail LED on the power supplies are red and no power is delivered to the chassis. The other LEDs on the power supply are green.
- The Status LEDs on the switching modules and the supervisor engine are flashing green.
- CPU Utilization LEDs are flashing green or off.

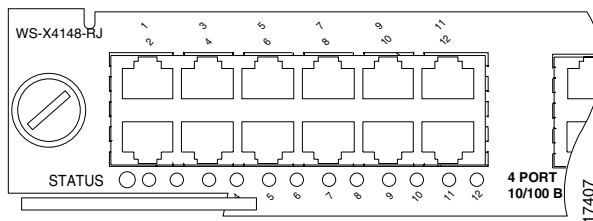
If you observe these conditions, contact the Cisco TAC for assistance in ordering replacement redundancy modules and a clock.

## Troubleshooting Switching Modules

Each switching module has one LED labeled STATUS that provides information about the module and one numbered LED labeled LINK for each port on the module. Figure 5-1 shows the Gigabit Ethernet port and status LEDs. Figure 5-2 shows the 10/100BASE-T port LEDs. Table 5-1 describes the switching module LEDs and their expected behavior.

**Figure 5-1** Gigabit Ethernet Port and Status LEDs



**Figure 5-2** 10/100BASE-T Port LEDs**Table 5-1** Switching Module LEDs

LED	Color/State	Description
STATUS	Green	Indicates the results of a series of self-tests and diagnostic tests performed by the switch. All the tests pass.
	Red	A test other than an individual port test failed.
	Orange	System boot, self-test diagnostics running, or the module is disabled.
LINK <sup>1</sup>	Green	Indicates the status of the port. The port is operational (a signal is detected).
	Orange	The link has been disabled by software.
	Flashing orange	The link has been disabled due to a hardware failure.
	Off	No signal is detected.
Port Status <sup>2</sup>	Green	Indicates individual port status. The port is operational (a signal is detected).
	Orange	The link has been disabled by software.
	Flashing orange	The link has been disabled due to a hardware failure.
	Off	No signal is detected.

1. Used on the WS-X4232-L3 Ethernet routing module.

2. LEDs labeled 1 through the number of ports on the switching module are the individual port link LEDs.

## Troubleshooting Switching Modules Using Cisco IOS

Connect a terminal to the console port, and look for any of the following system messages:

```
C4K_CHASSIS-3-LINECARDMUXBUFFERTOSUPALIGNMENTWRONG
```

```
C4K_CHASSIS-3-LINECARDNOTVALIDINSLOT
```

```
C4K_CHASSIS-3-MODULENOTSUPPORTHALF
```

```
C4K_IOSINTF-5-STALEPHYPORT
```

```
C4K_IOSMODPORTMAN-4-INLINEPOWEROVERMAX
```

If you observe any of these messages, follow the suggestion for that message.

Some problems can be solved by resetting the switching module. Use the **hw-module module <n> reset** command to reset a switching module, or remove and re-insert the switching module, which resets, restarts, and power cycles the switching module. The **show module** and **show diagnostics online module** commands can also provide information useful in solving problems with ports on individual modules.

Not all software versions support all switching modules. If you are having trouble with a module, refer to the software release notes to be sure that it is supported by your software.

# Troubleshooting Supervisor Engines

This section only addresses problems with hardware. Problems with features or configuration are not covered here. Refer for your software configuration guide and release notes for information on configuring features or identifying known problems.

Table 5-2 describes the supervisor engine LEDs. Check the LEDs on your supervisor and compare them to the described LED behaviors.

**Table 5-2** *Supervisor Engine LEDs*

LED	Color/State	Description
STATUS	Green	Indicates the results of a series of self-tests. All diagnostic tests passed.
	Red	A test failed.
	Orange	System boot or diagnostic test is in progress.
	Off	Module is disabled.
UTILIZATION	Green 1–100%	If the switch is operational, this display indicates the current traffic load over the backplane (as an approximate percentage).
LINK	Green	Indicates the status of the 10/100BASE-T Ethernet management port or uplink ports. The link is operational.
	Orange	The link is disabled by user.
	Flashing orange	The power-on self-test indicates a faulty port.
	Off	No signal is detected or there is a link configuration failure.

**Table 5-2 Supervisor Engine LEDs (continued)**

LED	Color/State	Description
ACTIVE		Indicates whether the uplink port is active or not.
	Green	The port is active.
	Off	The port is not active.
ACTIVE		The LED to the right of the uplink ports is used to identify the active supervisor engine in switches with two supervisor engines.

## Troubleshooting Supervisor Engines Using Cisco IOS

Connect a terminal to the console port, and look for any of the following system messages:

```

C4K_CHASSIS-3-LINECARDMUXBUFFERTOSUPALIGNMENTWRONG
C4K_SUPERVISOR-3-MUXBUFFERREADSUPERVISORSELECTIONFAILED
C4K_CHASSIS-3-TEMPERATURESENSORREADFAILED
C4K_HW-3-X2IDENTIFICATIONFAILURE
C4K_HW-3-X2OUIREGREADFAILURE
C4K_HWACLMAN-4-CLASSIFCAMPARITYERROR
C4K_HWACLMAN-4-CLASSIFCAMREPLYPARITYERROR
C4K_HWACLMAN-4-CLASSIFCAMREQPARITYERROR
C4K_HWNETFLOWMAN-3-NETFLOWSTOPPED
C4K_HWNETFLOWMAN-4-FATALERRORINTERRUPTSEEN
C4K_HWNETFLOWMAN-4-NONFATALPARITYERRORINTERRUPTSEEN
C4K_IOSMODPORTMAN-4-NFLABSENT
C4K_IOSMODPORTMAN-4-NFLIDPROMINVALID
C4K_IOSMODPORTMAN-4-NFLMISMATCH

```



C4K\_REDUNDANCY-2-HANDSHAKE\_TIMEOUT  
C4K\_REDUNDANCY-2-POSTFAIL\_RESET  
C4K\_REDUNDANCY-2-INCOMPATIBLE\_SUPERVISORS  
C4K\_REDUNDANCY-2-IOS\_VERSION\_CHECK\_FAIL  
C4K\_REDUNDANCY-2-IOS\_VERSION\_INCOMPATIBLE  
C4K\_REDUNDANCY-2-NON\_SYMMETRICAL\_REDUNDANT\_SYSTEM  
C4K\_REDUNDANCY-2-POSTFAIL  
C4K\_REDUNDANCY-2-POSTFAIL\_RESET  
C4K\_REDUNDANCY-4-CONFIGSYNCFAIL  
C4K\_SUPERVISOR-2-SUPERVISORSEEPROMINVALID  
C4K\_SUPERVISOR-3-RETIMERDISABLEFAILED  
C4K\_SUPERVISOR-3-RETIMERINITFAILED  
C4K\_SUPERVISOR-3-SEEPROMREADFAILED  
C4K\_SUPERVISOR-4-INLINEVOLTAGEOUTOFRANGE  
C4K\_SUPERVISOR-7-SEEPROMWRITEFAILED  
C4K\_SWITCHMANAGER-3-SSOACTIVEPORTACKTIMEOUT  
C4K\_SYSMAN-2-POWERONSELFTESTFAIL

These system messages indicate a problem with the supervisor engine. Some problems will prevent a console connection and will not allow you to use messages in diagnosing a problem. If you are unable to establish a terminal connection and the STATUS LED is red, contact Cisco TAC immediately to order a replacement.

Problems with redundant supervisor systems are often due to mismatched active and standby supervisor engines. Redundancy requires that both supervisor engines be the same model and running the same Cisco IOS release. If one supervisor has a NetFlow service card, the other must as well.

Some problems with supervisor engines are due to backplane connections that are not fully seated. If removing and reinserting the supervisor engine and then restarting the switch does not solve the problem, call Cisco TAC and replace the supervisor engine.

Some problems can be solved by resetting the supervisor engine. Use the **hw-module module <n> reset power-cycle** command to reset a switching module, or remove and re-insert the switching module, which resets, restarts and power cycles the switching module. Pressing the reset button on the supervisor engine causes the software to reload, but does not power cycle the supervisor engine.

**Note**

---

When you power-cycle or remove a supervisor engine in a redundant system the other supervisor engine becomes the active supervisor and the ports retain connectivity. In a non-redundant system, all of the switching modules lose connectivity until the supervisor engine is reinserted and completely restarted.

---

The **show diagnostics power-on** command may provide useful information for some supervisor engine problems.

Not all software versions support all supervisor engines. If you are having trouble with a supervisor engine, refer to the software release notes to be sure that it is supported by your software.

## Contacting the Cisco Technical Assistance Center

If you are unable to solve a startup problem after using the troubleshooting suggestions in this chapter, contact a Cisco TAC representative for assistance and further instructions.

Before you call, have the following information ready to help the Cisco TAC assist you as quickly as possible:

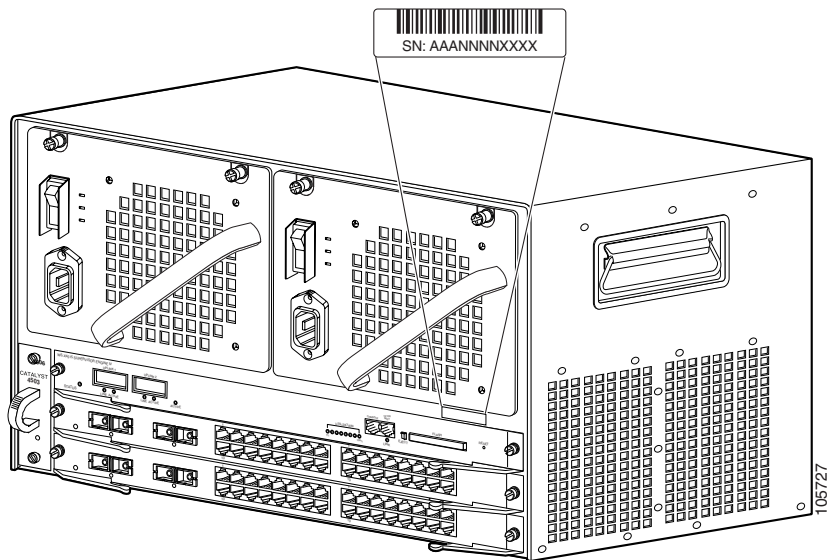
- Date you received the switch
- Chassis serial number (refer to Figure 5-3 to Figure 5-6 for serial number locations)
- Type of software and release number
- Maintenance agreement or warranty information
- Brief description of the problem
- Brief explanation of the steps you have already taken to isolate and resolve the problem

See the “Obtaining Technical Assistance” section on page xx for more information about contacting the TAC.

## Serial Numbers

When you contact Cisco Technical Assistance, have the serial number of your switch available. Refer to Figure 5-3 to 5-6 to locate the serial number on your switch. You may also get the serial number from the output of a **show version** command.

**Figure 5-3** Catalyst 4503 Serial Number Location



**Figure 5-4** Catalyst 4506 Serial Number Location

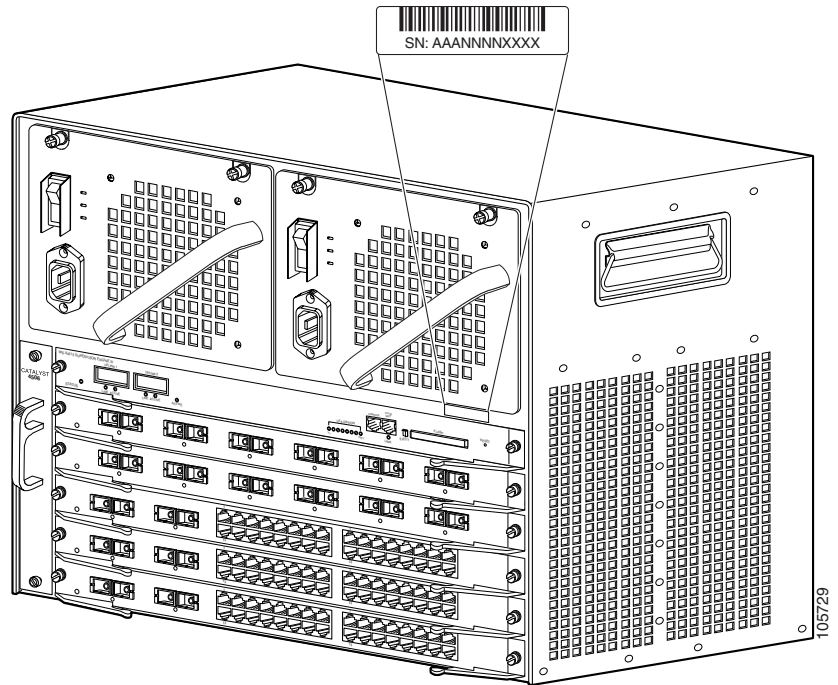
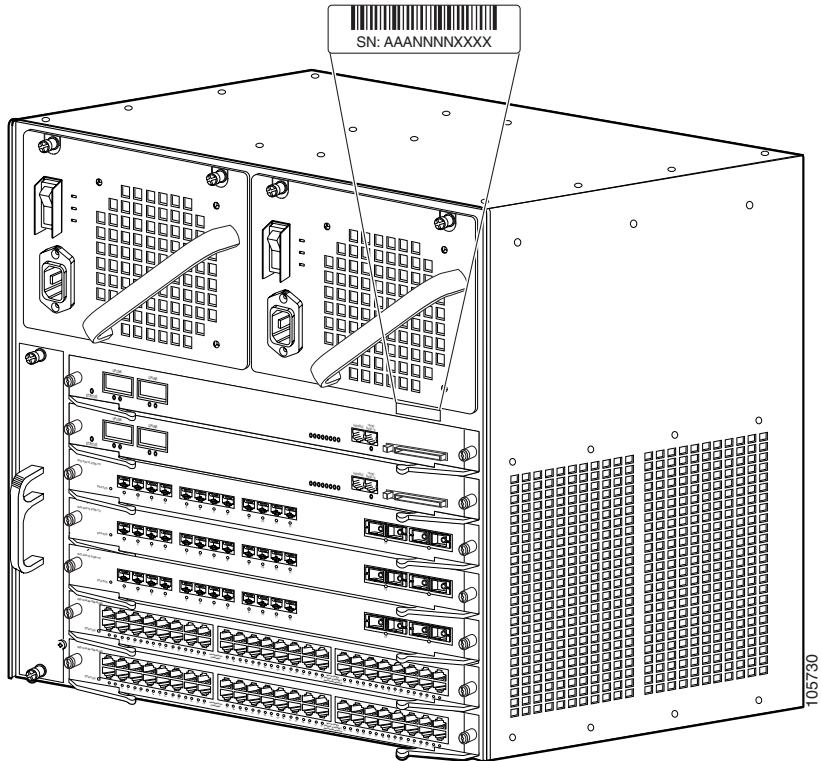
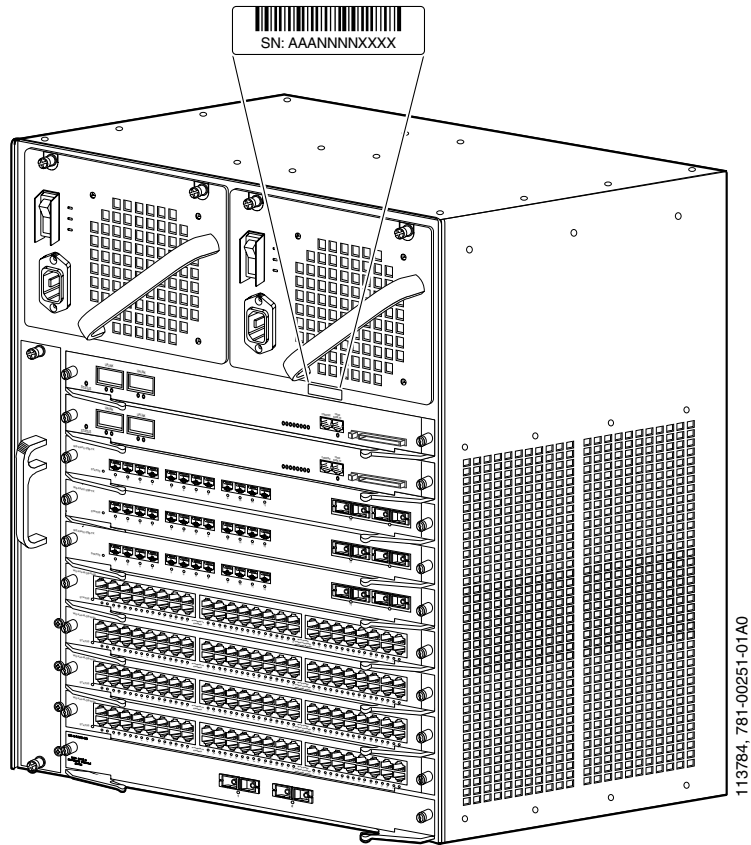


Figure 5-5 Catalyst 4507R Serial Number Location



**Figure 5-6 Catalyst 4510R Serial Number Location**



## Specifications

---

Cable and technical specifications for Catalyst 4500 series switches are provided in the following sections:

- Catalyst 4503 Switch Specifications, page A-2
- Catalyst 4506 Switch Specifications, page A-3
- Catalyst 4507R Switch Specifications, page A-4
- Catalyst 4510R Switch Specifications, page A-6
- Catalyst 4500 Series Power Supplies, page A-7



### Note

---

Specifications for individual switching modules and supervisor engines, including power consumption and thermal output information, are in the *Catalyst 4500 Series Module Installation Guide*, available online at: [http://www.cisco.com/univercd/cc/td/doc/product/lan/cat4000/hw\\_doc/mod\\_inst/index.htm](http://www.cisco.com/univercd/cc/td/doc/product/lan/cat4000/hw_doc/mod_inst/index.htm)

---

# Catalyst 4503 Switch Specifications

Table A-1 lists the Catalyst 4503 switch specifications.

**Table A-1** Catalyst 4503 Switch Specifications

Item	Specification
<b>Environmental</b>	
Temperature, ambient operating	32 to 104°F (0 to 40°C)
Temperature, ambient nonoperating and storage	-40 to 167°F (-40 to 75°C)
Humidity (RH), ambient (noncondensing), operating	10 to 90%
Humidity (RH), ambient (noncondensing), nonoperating and storage	5 to 95%
Altitude, operating and nonoperating	-200 to 6500 ft (-60 to 2000 m)
<b>Switching Components</b>	
Backplane	24 Gbps full duplex backplane 4 Gbps Uplinks
Port density	116 ports when using a Catalyst 4500 Series Supervisor Engine II-Plus TS, 96 ports with other supervisor engines
Inline power	integrated support, 820 W per switching module
<b>Physical Characteristics</b>	
Dimensions (H x W x D)	12.25 x 17.31 x 12.50 in. (31.12 x 43.97 x 31.70 cm)
Weight	Minimum weight: 31.25 lb (14.1 kg) Maximum weight: 75 lb (34 kg)  Chassis and backplane: 29 lb (13.1 kg) Fan tray: 2.25 lb (1.0 kg)
<b>Airflow</b>	
Switch	Right to left
Power supply	Front to back



**Table A-1** Catalyst 4503 Switch Specifications (continued)

Item	Specification
<b>Power</b>	
PoE supplied	–48 VDC
Power to Modules and fans	12 VDC
Power to backplane components	3.3 VDC
<b>Redundancy</b>	
Supervisor engine	no
Power supply	1 + 1

## Catalyst 4506 Switch Specifications

Table A-2 lists the Catalyst 4506 switch specifications.

**Table A-2** Catalyst 4506 Switch Specifications

Item	Specification
<b>Environmental</b>	
Temperature, ambient operating ambient nonoperating and storage	32 to 104°F (0 to 40°C) –40 to 167°F (–40 to 75°C)
Humidity (RH), ambient (noncondensing): operating nonoperating and storage	10 to 90% 5 to 95%
Altitude: operating nonoperating	–500 to 6500 ft (–150 to 2000 m) –1000 to 30,000 ft (–300 to 9150 m)
<b>Switching Components</b>	
Backplane	60 Gbps full duplex 4 Gbps Uplinks
Port density	240 (max)
Inline power	integrated support, 820 W per line card

## Catalyst 4507R Switch Specifications

**Table A-2** Catalyst 4506 Switch Specifications (continued)

Item	Specification
<b>Physical Characteristics</b>	
Dimensions (H x W x D)	17.38 x 17.31 x 12.50 in. (44.13 x 43.97 x 31.70 cm)
Weight	Minimum weight: 40.5 lb (18.4 kg) Maximum weight: 100 lb (45.4 kg) Chassis and backplane = 36.5 lb (16.5 kg) Fan tray: 4.0 lb (1.8 kg)
<b>Airflow</b>	
Switch	Right to left
Power supply	Front to back
<b>Power</b>	
PoE supplied	-48 VDC
Power to Modules and fans	12 VDC
Power to backplane components	3.3 VDC
<b>Redundancy</b>	
Supervisor engine	no
Power supply	1 + 1

# Catalyst 4507R Switch Specifications

Table A-3 lists the Catalyst 4507R switch specifications.

**Table A-3** Catalyst 4507R Switch Specifications

Item	Specification
<b>Environmental</b>	
Temperature, ambient operating ambient nonoperating and storage	32 to 104°F (0 to 40°C) -40 to 167°F (-40 to 75°C)

**Table A-3 Catalyst 4507R Switch Specifications (continued)**

Item	Specification
Humidity (RH), ambient (noncondensing): operating nonoperating and storage	10 to 90% 5 to 95%
Altitude: operating nonoperating	-500 to 6500 ft (-150 to 2000 m) -1000 to 30,000 ft (-300 to 9150 m)
<b>Switching Components</b>	
Backplane	60 Gbps full duplex 4 Gbps Uplinks with Sup II+, Sup III, and Sup IV 8 Gbps Uplinks with Supervisor Engine V
Port density	240 (max)
Inline power	integrated support, 820 W per line card
<b>Physical Characteristics</b>	
Dimensions (H x W x D)	19.19 x 17.31 x 12.50 in. (48.74 x 43.97 x 31.70 cm)
Weight	Minimum weight: 44.25 lb (20.1 kg) Maximum weight: 100 lb (45.4 kg)  Chassis and backplane: 40.0 lb (18.1 kg) Fan tray: 4.2 lb ( 1.9 kg)
<b>Airflow</b>	
Switch	Right to left
Power supply	Front to back
<b>Power</b>	
PoE supplied	-48 VDC
Power to Modules and fans	12 VDC
Power to backplane components	3.3 VDC
<b>Redundancy</b>	
Supervisor engine	yes
Power supply	1 + 1

# Catalyst 4510R Switch Specifications

Table A-4 lists the Catalyst 4510R switch specifications.

**Table A-4** Catalyst 4510R Switch Specifications

Item	Specification
<b>Environmental</b>	
Temperature, ambient operating ambient nonoperating and storage	32 to 104°F (0 to 40°C) –40 to 167°F (–40 to 75°C)
Humidity (RH), ambient (noncondensing): operating nonoperating and storage	10 to 90% 5 to 95%
Altitude: operating nonoperating	–500 to 6500 ft (–150 to 2000 m) –1000 to 30,000 ft (–300 to 9150 m)
<b>Switching Components</b>	
Backplane	88 Gbps full duplex with Supervisor Engine V, 96 Gbps with Supervisor Engine V-10GE 8 Gbps Uplinks with Supervisor Engine V 20 Gbps Uplinks with Supervisor Engine V-10GE
Port density	340 maximum using a Supervisor Engine V and a WS-X4302-GB in the Flex-Slot 386 maximum using a Supervisor Engine V-10GE
Inline power	integrated support, 820 W per line card
<b>Physical Characteristics</b>	
Dimensions (H x W x D)	24.35 x 17.31 x 12.50 in. (61.85 x 43.97 x 31.70 cm)
Weight	Minimum weight: 51.5 lb (23.4 kg) Maximum weight: 108 lb (45.4 kg) Chassis and backplane: 45.5 lb (20.6 kg) Fan tray: 6.0 lb (2.7 kg)

**Table A-4** Catalyst 4510R Switch Specifications (continued)

Item	Specification
<b>Airflow</b>	
Switch	Right to left
Power supply	Front to back
<b>Power</b>	
PoE supplied	-48 VDC
Power to Modules and Fans	12 VDC
Power to backplane components	3.3 VDC
<b>Redundancy</b>	
Supervisor engine	yes
Power supply	1 + 1

## Catalyst 4500 Series Power Supplies

Tables A-5 through A-12 list the specifications for the Catalyst 4500 series power supplies.



### Note

All Catalyst 4500 series switch AC-input power supplies require single-phase source AC. The source AC can be out of phase between multiple power supplies or multiple AC-power plugs on the same power supply because all AC power supply inputs are isolated. Each chassis power supply should have its own dedicated branch circuit: 15 A or 20 A for North America and circuits sized to local and national codes for International locations.

For more information about power management and planning, refer to the “Environmental Monitoring and Power Management” chapter in the *Catalyst 4500 Series Switch Cisco IOS Software Configuration Guide* version appropriate for your software.

**Table A-5 1000 W AC-Input Power Supply Specifications**

Item	Specification
Minimum software requirement	Cisco IOS Release 12.1(12c)EW Catalyst Operating System software version 7.4 (1)
Power over Ethernet	Not supported <sup>1</sup>
AC-input type	Autoranging input with power factor corrector
AC-input voltage	100 to 240 VAC ( $\pm 10\%$ for full range)
AC-input current	12 A @ 100 VAC, 5 A @ 240 VAC
Maximum KVA rating	1.32 KVA
AC-input frequency	50/60 Hz (nominal) ( $\pm 3$ Hz for full range)
Power supply output capacity	1000 W plus 40 W (fan)
Power supply output	12 V @ 83.4 A, 3.3V @ 12.2 A, 1667 W maximum
Output holdup time	20 ms minimum
Max heat dissipation	943 BTUs/hr

1. A Catalyst 4503 with a Catalyst 4500 series Supervisor Engine II-Plus TS and a 1000W power supply will be able to provide 158.4 W of Power over Ethernet to ports on the supervisor engine. Switching modules in other slots will not be able to provide PoE.

**Table A-6 1300 W AC-Input Power Supply Specifications**

Item	Specification
Minimum software requirement	Cisco IOS Release 12.1(12c)EW Catalyst Operating System software version 7.4 (1)
Power over Ethernet	Supported, up to 800 W (211 Cisco phones in combined mode)
AC-input type	Autoranging input with power factor corrector
AC-input voltage	100 to 240 VAC ( $\pm 10\%$ for full range)
AC-input current	16 A @ 100 VAC, 7 A @ 240 VAC
AC-input frequency	50/60 Hz (nominal) ( $\pm 3$ Hz for full range)
Maximum KVA rating	1.76 KVA

**Table A-6** 1300 W AC-Input Power Supply Specifications (continued)

Item	Specification
Power supply output	1300 W maximum 1000 W+ 40 W redundant mode (Data) 1667 W maximum in combined mode (Data)
Power supply output (AC supply)	800 W maximum each in redundant mode (PoE) 1333 W maximum in combined mode (PoE) 12 V @ 84.7 A, 3.3 V @ 12.5 A (Data), -50 V @ 16.7 A (PoE)
Max heat dissipation	1568 BTUs/hr
Output holdup time	20 ms minimum

**Table A-7** 1400 W AC-Input Power Supply Specifications

Item	Specification
Minimum software requirement	Cisco IOS Release 12.2(18)EW Catalyst Operating System software version 8.3 (1)GLX
Power over Ethernet	Not supported <sup>1</sup>
AC-input type	Autoranging input with power factor corrector
AC-input voltage	100 to 240 VAC ( $\pm 10\%$ for full range)
AC-input current	16 A @ 100 VAC, 7 A @ 240 VAC
AC-input frequency	50/60 Hz (nominal) ( $\pm 3$ Hz for full range)
Maximum KVA rating	1.76 KVA

**Table A-7** 1400 W AC-Input Power Supply Specifications (continued)

Item	Specification
Power supply output	2473 W maximum 1360 W+ 40 W redundant mode (Data)
Power supply output (AC supply)	12 V @ 113.4 A, 3.3 V @ 12.2 A (Data)
Max heat dissipation	1048 BTUs/hr
Output holdup time	20 ms minimum

1. A Catalyst 4503 with a Catalyst 4500 series Supervisor Engine II-Plus TS and a 1400W AC power supply provides 158.4 W of PoE to ports on the supervisor engine. Switching modules in other slots will not be able to provide PoE.

**Caution**

Do not mix the 1400 W DC power supply with any other power supply, even for a hot swap or other short-term emergency. Doing so can seriously damage your switch.

The 1400W DC Input power supply may be used with the Catalyst 4500 Series AC Power Shelf. Documentation for the Catalyst 4500 Series AC Power Shelf is at:

[http://www.cisco.com/univercd/cc/td/doc/product/lan/cat4000/inst\\_nts/78\\_15068.htm](http://www.cisco.com/univercd/cc/td/doc/product/lan/cat4000/inst_nts/78_15068.htm)

**Table A-8** 1400 W DC-Input Power Supply Specifications

Item	Specification
Minimum software requirement	Cisco IOS Release 12.1(19)EW Catalyst Operating System software version 7.5 (1)
Power over Ethernet	Supported, up to 7500 W minus power consumed for data (240 Cisco phones in combined mode)
DC-input voltage	Data only: -48 to -60 VDC Inline devices: -48 to -56 VDC



Table A-8 1400 W DC-Input Power Supply Specifications (continued)

Item	Specification
DC-input current	Data only: 31 A @ -60 VDC Data and inline devices: 180 A maximum @ -48 VDC input  <b>Note</b> The input power is configurable in the CLI. The Cisco IOS command is <b>power dc input</b> . The Catalyst Operating System command is <b>set power DC input</b> . Configure the switch software to match the requirements of your switch. To learn how to calculate the DC input current for your system, refer to the “Calculating DC Input Current” section on page 2-13.
Input power	1866 W (Data only)
Current draw At -40.5 V (min voltage)	46 A
Current draw at -72 V (max voltage)	25.9 A
Max heat dissipation at 1866 W	5760 BTUs
	179 A max @ 48 VDC
Maximum KVA rating	1.87 (data) 9.15 (data and voice)
Power supply output (DC supply)	Data: 12 V @120 A, 3.3 V @ 10 A Inline devices: 140 A total maximum (35 A maximum each per 5 channels) @-48 to 60 VDC input  1367 W+ 40 W redundant mode (Data) 2267 W maximum in combined mode (Data)  7500 W maximum each in redundant mode (PoE) 7280 W maximum in combined mode (PoE)
DC input terminal block	Accepts FCI p/n YAV25L2TC14FX90 or equivalent, barrel-type lug terminals with 90-degree angle, two-hole tongue, which accommodates 1/0 AWG size copper wire. The connector tongue width is 0.82 in, the stud hole spacing is 5/8 in, and the hole size is 1/4 in.
Output holdup time	4 ms
Max heat dissipation	1591 BTUs/hr (data) 2905 BTUs/hr (data and voice)

**Table A-8** 1400 W DC-Input Power Supply Specifications (continued)

Item	Specification
<b>Catalyst 4503-Specific Power Usage (data only)</b>	
Maximum draw	475 W
Maximum input	633 W
Current draw at -40.5 V (min voltage)	15.6 A
Current draw at -72 V (max voltage)	8.8 A
Max heat dissipation at 633 W	2160 BTUs
<b>Catalyst 4506-Specific Power Usage (data only)</b>	
Maximum draw (data only)	850 W
Maximum input	1133 W
Current draw at -40.5 V (min voltage)	28 A
Current draw at -72 V (max voltage)	15.8 A
Max heat dissipation at 1133 W	3515 BTUs
<b>Catalyst 4507R-Specific Power Usage (data only)</b>	
Maximum draw (data only)	1080 W
Max input is $1080\text{ W} / 0.75 =$	1440 W
Current draw at -40.5 V (min voltage)	35.6 A
Current draw at -72 V (max voltage)	20 A
Max heat dissipation 1440 W	4910 BTUs

**Table A-9** 1400 W DC Triple-Input Power Supply Specifications

Item	Specification
Minimum software requirement	Cisco IOS Release 12.2(25)EW
Power over Ethernet	Not supported
DC-input voltage	Domestic and international: -48 to -60 VDC
DC-input current	42.5 A maximum @ -48 VDC input Input 1: 12.5 A at -48 to -60 VDC Input 2: 15 A at -48 to -60 VDC Input 3: 15 A at -48 to -60 VDC
Input power	1772 W @ 1400 W output power
Current draw At -40.5 V (min voltage)	42.5 A
Current draw at -72 V (max voltage)	25 A
Max heat dissipation at 1400 W	1269 BTUs
Maximum KVA rating	1.77 at 1400 W load
Power supply output (DC supply)	12 V @ 8 A minimum, 115.3 A maximum 3.3 V @ 1.2 A minimum, 12.5 A maximum 1360 W+ 40 W redundant mode 2450 W maximum in combined mode
DC input terminal block	Model: Cooper Bussmann Magnum. Accepts terminals with flat angle, one hole tongue, which accommodates 10 to 12 AWG size copper wire. The connector the barrier spacing is 0.378 in (9.6 mm), and the screw size is 8-32.
Output holdup time	8 ms
Max heat dissipation	1269 BTUs/hr

**Table A-9** 1400 W DC Triple-Input Power Supply Specifications (continued)

Item	Specification
<b>Catalyst 4503-Specific Power Usage (data only)</b>	Two modules minimum required @ -40.5 VDC input One 15A module minimum required @ -44 VDC input
Maximum draw	475 W
Maximum input	609 W total / # of modules = W per module
Current draw at -40.5 V (min voltage)	15 A total / # of modules = A per module
Current draw at -72 V (max voltage)	8.5 A total / # of modules = A per module
Max heat dissipation at 609 W	2078 BTUs
<b>Catalyst 4506-Specific Power Usage (data only)</b>	Two modules minimum required @ -44 VDC input Three modules minimum required @ -40.5 VDC input
Maximum draw (data only)	850 W
Maximum input	1076 W total / # of modules = W per module
Current draw at -40.5 V (min voltage)	26.6 A total / # of modules = A per module
Current draw at -72 V (max voltage)	15 A total / # of modules = A per module
Max heat dissipation at 1076 W	3671 BTUs
<b>Catalyst 4507R-Specific Power Usage (data only)</b>	Three modules minimum required
Maximum draw (data only)	1080 W
Max input is 1080 W	1367 W total / # of modules = W per module
Current draw at -40.5 V (min voltage)	33.75 A total / # of modules = A per module
Current draw at -72 V (max voltage)	19 A total / # of modules = A per module
Max heat dissipation 1367 W	4665 BTUs

**Table A-10** *Input Modes*

<b>Input Mode</b>	<b>Input Number</b>	<b>Input Configuration</b>	<b>Maximum Total Output Power</b>
1	1	1 x 12.5 A	386 W @ -40.5 VDC 412 W @ -44.0 VDC
2	2 OR 3	1 x 15 A	466 W @ -40.5 VDC 495 W @ -44.0 VDC
3	1, 2 OR 3	1 x 12.5 A and 1 x 15 A	845 W @ -40.5 VDC 908 W @ -44.0 VDC
4	2, 3	2 x 15 A	914 W @ -40.5 VDC 990 W @ -44.0 VDC
5	1, 2, 3	1 x 12.5 A and 2 x 15 A	1294 W @ -40.5 VDC 1400 W @ -44.0 VDC

**Table A-11** *Allowable Power with Two 1400 W DC Triple-Input Power Supplies in Combined Mode*

<b>PS1/PS2</b>	<b>1</b>	<b>2 or 3</b>	<b>1 and (2 or 3)</b>	<b>2 and 3</b>	<b>1 and 2 and 3</b>
1	824 W	907 W	1320 W	1400 W	1700 W
2 or 3	907 W	990 W	1400 W	1450 W	1750 W
1 and (2 or 3)	1320 W	1400 W	1700 W	1750 W	1900 W
2 and 3	1400 W	1450 W	1750 W	1820 W	2130 W
1 and 2 and 3	1700 W	1750 W	1900 W	2130 W	2450 W

**Table A-12 2800 W AC-Input Power Supply Specifications**

<b>Item</b>	<b>Specification</b>
Minimum software requirement	Cisco IOS Release 12.1(13)EW Catalyst Operating System software version 7.5 (1)
Power over Ethernet	Supported, up to 1400 W (240 Cisco phones in combined mode)
AC-input type	Autoranging input with power factor corrector
AC-input voltage	200 to 240 VAC ( $\pm 10\%$ for full range)
AC-input current	16 A maximum at 200 VAC
AC-input frequency	50/60 Hz (nominal) ( $\pm 3\%$ for full range)
Maximum KVA rating	3.52 KVA
Power supply output	2800 W maximum 12 V @ 113.3 A, 3.3 V @ 12.1 A (Data) -50 V @ 28 A (PoE) 1360 W+ 40 W redundant mode (Data) 2473 W maximum in combined mode (Data) 1400 W maximum each in redundant mode (PoE) 2333 W maximum in combined mode (PoE)
Max heat dissipation	2387 BTUs/hr.
Output holdup time	20 ms minimum

**Table A-13** 4200 W AC-Input Power Supply Specifications

Item	Specification
Minimum software requirement	Cisco IOS Release 12.2(25)EWA
Power over Ethernet	Supported, up to 4200 W
AC-input type	Autoranging input with power factor corrector
AC-input voltage	100 to 240 VAC ( $\pm 10\%$ for full range)
AC-input current	16 A maximum at 200 VAC
AC-input frequency	50/60 Hz (nominal) ( $\pm 3\%$ for full range)
Maximum KVA rating	5.25 KVA
Power supply output	4200 W maximum @ 230 VAC 12 V @ 115.3 A, 3.3 V @ 12.5 A (Data) -50 V @ 77.1 A (PoE) with two inputs  2100 W maximum @ 230 VAC 12 V @ 115.3 A, 3.3 V @ 12.5 A (Data) -50 V @ 38.5 A (PoE) with one input  2100 W maximum @ 120 VAC 12 V @ 115.3 A, 3.3 V @ 12.5 A (Data) -50 V @ 38.0 A (PoE) with two inputs  1050 W maximum @ 120 VAC 12 V @ 55.9 A, 3.3 V @ 12.5 A (Data) -50 V @ 14.6 A (PoE) with one input
Max heat dissipation	3583 BTUs/hr.
Output holdup time	20 ms minimum

**Note**

The 4200 W AC power supply should not be used in mixed-voltage configurations. All the inputs in a chassis must be at the same voltage (110 VAC or 220 VAC).

Table A-14 shows the wattage output possible with the 4200W power supply in redundant mode. In redundant mode, both power supplies must have identical inputs and all inputs must be at the same voltage. If the input voltages are mismatched, choose the value matching the weaker of the two power supplies.

**Table A-14 Redundant Mode Output**

	<b>12V</b>	<b>3.3V</b>	<b>-50V</b>	<b>Total</b>
110	660	40	700	1050
110+110 or 220	1360	40	1850	2100
220+220	1360	40	3700	4200

Table A-15 shows the wattage output possible with the 4200W power supply in combined mode.

**Table A-15 Combined Mode Output**

	<b>12V</b>	<b>3.3V</b>	<b>-50V</b>	<b>Total</b>
Both sides at 110	1200	40	1200	1873
110+110, other side 110	1360	40	2000	2728
220+220	1360	40	3100	3782
Both sides at 110+110	1360	40	3100	3782
Both sides at 220	1360	40	4700	5493
Both sides at 220+220	1360	40	6800	7600





## Repacking a Switch

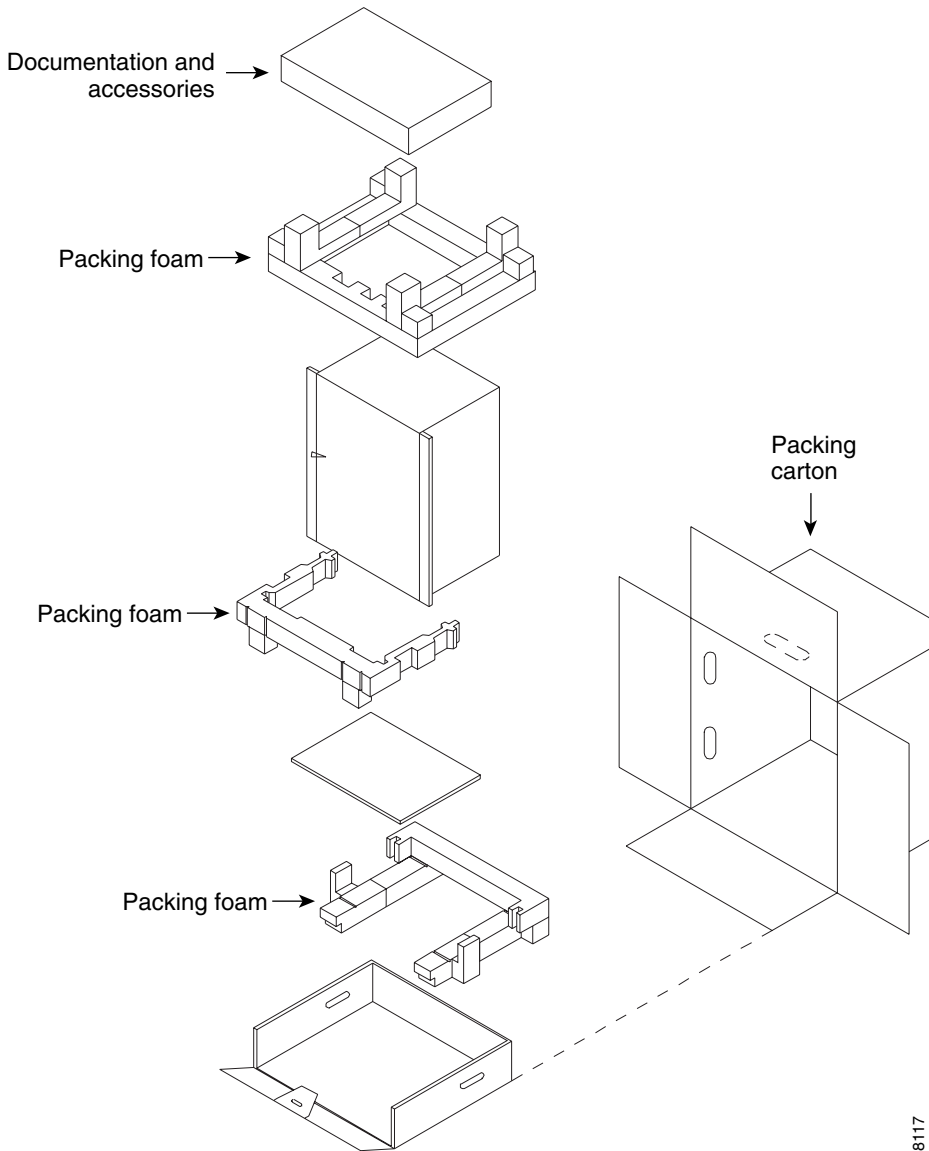
---

If you need to return your Catalyst 4500 series switch to the factory, use the instructions in this appendix to repack your switch in preparation for shipping.

To repack the switch using the original packaging material, follow these steps:

---

- Step 1** Slide the pieces of the packing foam over the Catalyst 4500 series switch. (See Figure B-1.)
  - Step 2** Place the documentation and accessory kit in the box or poly bag provided.
  - Step 3** Place the box or poly bag containing the documentation and accessory kit on top of the packing material.
  - Step 4** Place the switch (with packing foam pieces) into the packing carton.
  - Step 5** Fold in the top flaps of the packing carton and seal with packing tape.
-

**Figure B-1 Catalyst 4500 Series Switch Packing Material**



---

## Numerics

- 10/100BASE-T
  - port LEDs **5-11**
- 1000BASE-T
  - interfaces **1-3, 1-7, 1-11, 1-15**
- 1000BASE-X
  - Ethernet interfaces **1-19**
  - port and status LEDs (figure) **5-10**
- 1000 W power supplies
  - power cord plugs **2-5**
  - power cords (table) **2-6**
- 100BASE-T
  - interfaces **1-3, 1-7, 1-11, 1-15**
- 10BASE-T
  - interfaces **1-3, 1-7, 1-11, 1-15**
- 1300 W power supplies
  - power cord plugs **2-5, 2-6**
  - power cords (table) **2-7**
- 1400 W power supplies
  - power cord plugs **2-5, 2-6**
  - power cords (table) **2-7**
- 2800 W power supplies
  - power cord plugs **2-6**
  - power cords (table) **2-9, 2-10**

---

## A

- AC-input power cords
  - product numbers (table) **2-6**
- AC-input power supplies
  - description **1-31**
  - environmental monitoring **1-35**
  - figure **1-31, 1-32, 4-3**
  - handling (figure) **4-7**
  - installing **4-8**
  - removing **4-5**
  - replacing **4-8**
  - source circuit requirements **2-5**
  - troubleshooting **5-6**
  - verifying operation **4-10**
  - See also DC-input power supplies
- ACTIVE LED
  - description (table) **1-24**
- air-conditioning requirements **2-4**
- airflow
  - Catalyst 4503 switches (table) **A-2**
  - Catalyst 4506 switches (table) **A-4**
  - Catalyst 4507 switches (table) **A-5, A-7**
  - direction **1-27**
  - figure **1-29, 1-30**

## autonegotiation

- Catalyst 4503 switches (table) **1-3**
- Catalyst 4506 switches (table) **1-7**
- Catalyst 4507 switches (table) **1-11, 1-15**

**B**

## boot process

- troubleshooting **5-2**

## brackets

- See L brackets

**C**

## cables

- ESD **2-2**

## Catalyst 4503 switches

- attaching cable guides (figure) **3-12, 3-13**
- attaching L brackets (figure) **3-6**
- chassis dimensions **A-2**
- features **1-3**
- front view **1-2**
- installing in racks (figure) **3-14**
- power requirements **2-4**
- repacking **B-1**
- specifications **A-2**

## Catalyst 4506 switches

- attaching cable guides (figure) **3-11**
- attaching L brackets (figure) **3-7**

chassis dimensions **A-4**

- features **1-7**
- front view **1-6**
- installing in racks (figure) **3-15**
- power requirements **2-4**
- repacking **B-1**
- specifications **A-3**

## Catalyst 4507 switches

- attaching L brackets (figure) **3-8, 3-9**
- chassis dimensions **A-5, A-6**
- description **1-10, 1-14**
- features **1-11, 1-15**
- front view **1-10, 1-14**
- installing in racks (figure) **3-16, 3-17**
- power requirements **2-4**
- repacking **B-1**
- specifications **A-4, A-6**

## chassis dimensions

- See Catalyst 4503 switches; Catalyst 4506 switches; Catalyst 4507 switches

## checklists

- rack-mount kits **3-5**
- site planning **2-16**

## components

- troubleshooting **5-3 to 5-17**

## connecting

- system ground **3-18 to 3-25**

## conventions

- warnings **xiii**

**D**

## DC-input power supplies

connecting system ground **3-23**

description **1-31**

environmental monitoring **1-35**

figure **1-32, 1-33, 4-4**

handling (figure) **4-15**

installing **4-16**

removing **4-11**

replacing **4-16**

See also AC-input power supplies

troubleshooting **5-6**

verifying operation **4-18**

## dimensions

Catalyst 4503 switches (table) **A-2**

Catalyst 4506 switches (table) **A-4**

Catalyst 4507 switches (table) **A-5, A-6**

## disconnecting

ground connections (warning) **4-13**

## documentation

conventions **xi**

**E**

## electrostatic discharge

see ESD

## environmental monitoring

power supplies **1-35**

## ESD

cabling and preventing damage **2-2, 2-3**

## Ethernet management ports

figure **1-22**

LEDs **5-4**

troubleshooting **5-4**

**F**

## FAIL LEDs

checking **4-10**

verifying power supply status **4-18**

## fan assemblies

booting **5-2**

Catalyst 4503 switches (figure) **1-3**

Catalyst 4506 switches (figure) **1-7**

Catalyst 4507 switches (figure) **1-11, 1-15**

description **1-27**

installing **4-23**

power supplies **1-35**

removing **4-23**

replacing **4-22**

troubleshooting **5-8**

verifying installation **4-24**

## FAN OK LED

checking **4-10**

description **1-34**

## Fast Ethernet

See 100BASE-T

field-replaceable units

See FRUs

Flash code

troubleshooting **5-5**

FRUs

AC-input power supplies **4-5 to 4-10**

DC-input power supplies **4-11 to 4-18**

fan assemblies **4-18 to 4-24**

---

## G

Gigabit Ethernet

See 1000BASE-T

See 1000BASE-X

GOOD LEDs

checking **4-10**

troubleshooting **5-6**

verifying power supply status **4-18**

grounding

connecting systems **3-23**

ground wire

figure **4-13**

---

## H

heat dissipation

description (table) **2-4**

supervisor engines **2-4**

switch chassis **2-4**

switching modules **2-4**

help

See TAC

hot swapping

fan assemblies **4-18**

humidity

Catalyst 4503 switch specifications  
(table) **A-2**

Catalyst 4506 switch specifications  
(table) **A-3**

Catalyst 4507 switch specifications  
(table) **A-5, A-6**

---

## I

INPUT OK LED

description (table) **1-34**

installing

AC-input power supplies **4-5 to 4-10**

DC-input power supplies **4-11 to 4-18**

fan assemblies **4-18 to 4-24**

installing switches in racks **3-3 to 3-25**

---

## L

labels, chassis serial number

See serial numbers

L brackets

rack-mounting switches **3-5**

LEDs

checking power supplies **5-4**  
 checking supervisor engines **5-2**

See also specific types of LEDs

#### Link LED

description (table) **1-24**

LINK LEDs (table) **5-11**

load sharing, power supplies **1-35**

---

## M

### MAC addresses

supported on Catalyst 4503 switches  
 (table) **1-18**

### management

local, on Catalyst 4503 switches **1-3**  
 local, on Catalyst 4506 switches **1-7**  
 local, on Catalyst 4507 switches **1-11, 1-15**  
 remote, on Catalyst 4503 switches **1-3**  
 remote, on Catalyst 4506 switches **1-7**  
 remote, on Catalyst 4507 switches **1-11, 1-15**

### Media Access Control addresses

See MAC addresses

Mux buffers **4-24, 5-9**

---

## O

### OUTPUT FAIL LED

environmental monitoring **1-35**

---

## P

packaging materials **B-1**

port status LEDs **5-11**

### power

requirements **2-4**

### power cords

See AC-input power cords

### power supplies

LEDs **5-4**

load sharing **1-35**

See AC-input power supplies; DC-input  
 power supplies; external power  
 supplies

preventing ESD damage **2-3**

---

## R

### rack-mounting

checklist **3-5**

switches **3-4**

Redundancy modules **4-24, 5-9**

### removing

AC-input power supplies **4-5**

DC-input power supplies **4-11**

repacking switches **B-1**

### replacing

AC-input power supplies **4-8 to 4-10**

DC-input power supplies **4-16 to 4-18**

fan assemblies **4-23**

---

**S**

serial numbers **5-16**

shipping instructions **B-1**

show system command **4-10**

site planning  
     checklist **2-16**

slots  
     Catalyst 4503 switches (figure) **1-3**  
     Catalyst 4506 switches (figure) **1-7**  
     Catalyst 4507 switches (figure) **1-11, 1-15**

specifications  
     Catalyst 4503 switches (table) **A-2**  
     Catalyst 4506 switches (table) **A-3**  
     Catalyst 4507 switches (table) **A-4, A-6**

startup  
     troubleshooting **5-4**

STATUS LED  
     description (table) **1-24**

Supervisor Engine III  
     front panels (figure) **1-22**

Supervisor Engine IV  
     front panels (figure) **1-22, 1-23**

supervisor engines  
     Catalyst 4503 switches **1-3**  
     Catalyst 4506 switches **1-8, 1-12, 1-16**  
     description **1-18**  
     LEDs (table) **1-24**  
     slot locations **1-3, 1-7, 1-11, 1-15**

troubleshooting **5-3**

switching modules

    Catalyst 4503 supported **1-4**

    Catalyst 4506 supported **1-8**

    Catalyst 4507R supported **1-12**

    Catalyst 4510R supported **1-16**

    troubleshooting **5-3**

---

**T**

TAC

    contacting **5-16**

temperature

    Catalyst 4503 switches **A-2**

    Catalyst 4506 switches **A-3**

    Catalyst 4507 switches **A-4, A-6**

troubleshooting **5-6**

    boot process **5-2**

    fan assemblies **5-8**

    methodology **5-3**

    power supplies **5-6**

    startup **5-4**

    supervisor engines **5-3**

    switching modules **5-3**

---

**U**

uplink ports

    description **1-25**



## UTILIZATION LEDs

description (table) **1-24**

---

## V

voltage

specifications **A-10, A-13**

---

## W

weight

Catalyst 4503 switches (table) **A-2**

Catalyst 4506 switches (table) **A-4**

Catalyst 4507 switches (table) **A-5, A-6**



## Free Manuals Download Website

<http://myh66.com>

<http://usermanuals.us>

<http://www.somanuals.com>

<http://www.4manuals.cc>

<http://www.manual-lib.com>

<http://www.404manual.com>

<http://www.luxmanual.com>

<http://aubethermostatmanual.com>

Golf course search by state

<http://golfingnear.com>

Email search by domain

<http://emailbydomain.com>

Auto manuals search

<http://auto.somanuals.com>

TV manuals search

<http://tv.somanuals.com>