



Cisco Unified IP Phone User Guide for Cisco Unified Communications Manager 8.5 (SCCP and SIP)

For Cisco Unified IP Phone 8941 and 8945

Americas Headquarters

Cisco Systems, Inc.
170 West Tasman Drive
San Jose, CA 95134-1706
USA
<http://www.cisco.com>
Tel: 408 526-4000
800 553-NETS (6387)
Fax: 408 527-0883

Contents

Your Phone 1

Cisco Unified IP Phone 8941 **1**

Phone Connections **1**

Footstand **3**

Buttons and Hardware **4**

Phone Screen **7**

Phone with a Single Line **7**

Phone with Multiple Lines **8**

Power-Save Mode **10**

Handset Rest **10**

Cisco Unified IP Phone 8945 **11**

Phone Connections **11**

Bluetooth **13**

Footstand **14**

Buttons and Hardware **15**

Phone Screen **18**

Phone with a Single Line **18**

Phone with Multiple Lines **19**

Power-Save Mode **21**

Handset Rest **21**

Applications 23

Phone Applications **23**

Call History **23**

View Call History **24**

View Call Record Details **24**

Filter Call History **24**

Dial From Call History **25**

Edit Number From Call History **25**

- Clear Call History 25
- Delete Call Record From Call History 25
- Preferences 26
 - Ringtones 26
 - Brightness 26
 - Camera Settings 27
 - Bluetooth 27
- Accessories 28
 - View Accessories List 28
 - View Accessory Details 28
 - Set Up Wideband for Analog Headset 29
 - Add Bluetooth Accessory 29
 - Delete Bluetooth Accessory 30
 - Connect Bluetooth Accessory 30
 - Disconnect Bluetooth Accessory 30
- Administrator Settings 30
- Phone Information 30
 - View Phone Information 31

Contacts 33

- Phone Contacts 33
 - Corporate Directory 33
 - Search for and Dial a Contact 33
 - Search for and Dial a Contact While on a Call 34
 - Personal Directory 34
 - Personal Directory Options 34
 - Fast-Dial Codes with Personal Directory 36

Messages 39

- Voice Messages 39
 - Personalize Your Voicemail 39
 - Check for Voice Messages 39
 - Listen to Voice Messages 40

Calling Features 41

- Feature Buttons and Softkeys 41

Agent Greeting	42
Answer	42
Answer Your Oldest Call First	43
Auto Answer	43
Auto Answer with Your Headset	43
Auto Answer with Your Speakerphone	43
Barge	43
Add Yourself to a Call on a Shared Line	43
Call Back	43
Set up a Call Back Notification	44
Call Forward All	44
Forward Calls on Your Phone	45
Call Park	45
Park and Retrieve a Call Using Park	46
Park and Retrieve a Call Using Assisted Directed Call Park	46
Park and Retrieve a Call Using Manual Directed Call Park	46
Call Pickup	47
Answer a Call Using Pickup	48
Answer a Call Using Group Pickup and a Group Pickup Number	48
Answer a Call Using Group Pickup and a Phone Number	48
Answer a Call Using Other Pickup	48
Call Waiting	49
Respond to a Call Waiting Notification	49
Conference	49
Add Another Party to Your Call to Create a Conference	49
Join Calls Together in a Conference	50
Swap Between Calls Before Completing a Conference	50
View Conference Participants	50
Remove Conference Participants	50
Divert	51
Divert a Call	51
Do Not Disturb	51
Turn DND On and Off	52
Extension Mobility	52

Enable Extension Mobility	52
Fast Dial	52
Place a Call with a Fast-Dial Button	53
Hold	53
Hold and Resume a Call	53
Swap Between Holding and Active Calls	53
Put a Call on Hold by Answering a New Call	53
Determine if a Shared Line is on Hold	54
Remote Hold	54
Hold Reversion	54
Respond to a Hold Reversion Notification	54
Hunt Groups	54
Sign In and Out of a Hunt Group	54
Intercom	55
Place a Dedicated Intercom Call	55
Place a Dialable Intercom Call	55
Receive an Intercom Call	56
Line Status	56
Line Status Indicators	56
Malicious Call Identification	57
Trace a Suspicious Call	57
Meet Me	57
Host a Meet-Me Conference	57
Join a Meet-Me Conference	58
Mobile Connect	58
Turn On or Off Mobile Connect to All Your Remote Destinations From Your Desk Phone	58
Switch an In-Progress Call on Your Desk Phone to a Mobile Phone	59
Switch an In-Progress Call From a Mobile Phone to Your Desk Phone	59
Hand Off an In-Progress Call From a Mobile Phone to Your Desk Phone	59
Mute	59
Mute Your Phone	60
Mute Your Video	60
On-hook Dialing	60
Dial a Number On Hook	60

Plus Dialing	60
Dialing an International Number	61
Privacy	61
Enable Privacy on a Shared Line	61
Quality Reporting Tool	61
Report Problems on Your Phone	62
Redial	62
Redial a Number	62
Secure and Nonsecure Indication Tone	62
Shared Lines	63
Silent Monitoring and Recording	63
Speed Dial	63
Place a Call with a Speed-Dial Button	64
Place a Call with a Speed-Dial Code	64
Use a Speed-Dial Code On Hook	64
Use a Speed-Dial Code Off Hook	64
Transfer	64
Transfer a Call to Another Number	65
Swap Between Calls Before Completing a Transfer	65
Web Dialer	65
Use Web Dialer with Cisco Directory	65
Use Web Dialer with Another Online Corporate Directory	66
Set Up, View, or Change Web Dialer Preferences	66
Sign Out of Web Dialer	67
User Options	69
User Options Web Pages	69
Sign In and Out of User Options Web Pages	69
Device	70
Select a Device From the User Options Web Pages	70
Customize Do Not Disturb Options	70
Line Settings	71
Set Up Call Forwarding Per Line	71
Change the Voice Message Indicator Setting Per Line	71

- [Change the Audible Voice Message Indicator Setting Per Line](#) **72**
 - [Change the Ring Settings Per Line](#) **72**
 - [Change or Create a Line Text Label for Your Phone Display](#) **72**
 - [Speed Dial on the Web](#) **73**
 - [Set Up Speed-Dial Buttons](#) **73**
 - [Set Up Speed-Dial Codes](#) **73**
 - [Phone Services](#) **73**
 - [Subscribe to a Service](#) **74**
 - [Search for Services](#) **74**
 - [Change or End Services](#) **74**
 - [Change a Service Name](#) **74**
 - [Add a Service to an Available Programmable Feature Button](#) **74**
- [User Settings](#) **75**
 - [Change Your Browser Password](#) **75**
 - [Change Your PIN](#) **75**
 - [Change the Language for Your User Options Web Pages](#) **75**
 - [Change the Language for Your Phone Display](#) **76**
- [Directory](#) **76**
 - [Personal Address Book](#) **76**
 - [Add a New PAB Entry](#) **76**
 - [Search for a PAB Entry](#) **76**
 - [Edit a Personal Directory Entry](#) **77**
 - [Delete a Personal Directory Entry](#) **77**
 - [Assign a Feature Button for Personal Address Book](#) **77**
- [Fast Dials](#) **77**
 - [Assign a Feature Button for Fast Dial](#) **78**
 - [Assign a Fast Dial Code to a PAB Entry](#) **78**
 - [Assign a Fast Dial Code to a Phone Number Without Using a PAB Entry](#) **78**
 - [Search for a Fast Dial Entry](#) **78**
 - [Edit a Fast Dial Phone Number](#) **78**
 - [Delete a PAB Entry](#) **79**
 - [Mobility Settings](#) **79**
 - [Add a New Remote Destination](#) **79**
 - [Create an Access List](#) **80**
- [Plugins](#) **81**

[Access Plugins](#) **81**

FAQs and Troubleshooting **83**

[Frequently Asked Questions](#) **83**

[Troubleshooting Tips](#) **85**

[Personal Directory](#) **86**

[User Options](#) **86**

Product Safety, Security, Accessibility, and Related Information **87**

[Safety and Performance Information](#) **87**

[Power Outage](#) **87**

[External Devices](#) **87**

[Bluetooth Wireless Headset Performance](#) **88**

[FCC Compliance Statements](#) **88**

[FCC Part 15.21 Statement](#) **88**

[FCC RF Radiation Exposure Statement](#) **88**

[FCC Receivers and Class B Digital Statement](#) **89**

[Cisco Product Security](#) **89**

[Accessibility Features](#) **89**

[Additional Information](#) **90**

Warranty **111**

[Cisco One-Year Limited Hardware Warranty Terms](#) **111**

Index **1**

Your Phone

This chapter describes the features of the Cisco Unified IP Phones 8941 and 8945.

Cisco Unified IP Phone 8941

The Cisco Unified IP Phone 8941 provides these features:

- Phone connections
- Footstand
- Buttons and hardware
- Phone screen
- Power-save mode
- Handset rest

Phone Connections

Your system administrator can help you connect your phone to the corporate IP telephony network.



236959

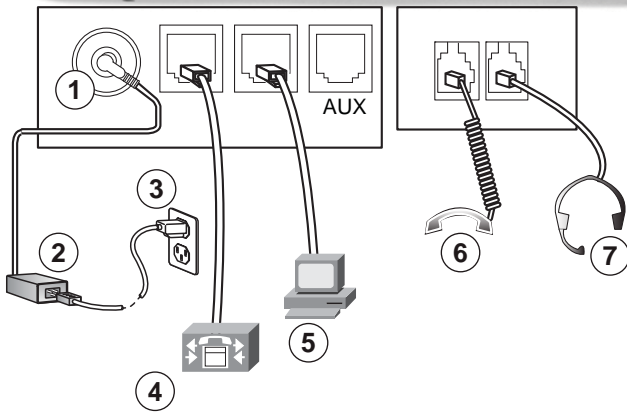

1	DC adapter port (DC48V)	5	Computer port (10/100 PC) connection
2	AC-to-DC power supply (optional)	6	Handset connection
3	AC power wall plug (optional)	7	Analog headset connection (headset optional)
4	Network port (10/100 SW) with IEEE 802.3af and 802.3at power enabled		

Footstand

If your phone is placed on a table or desk, connect the footstand to the back of the phone.

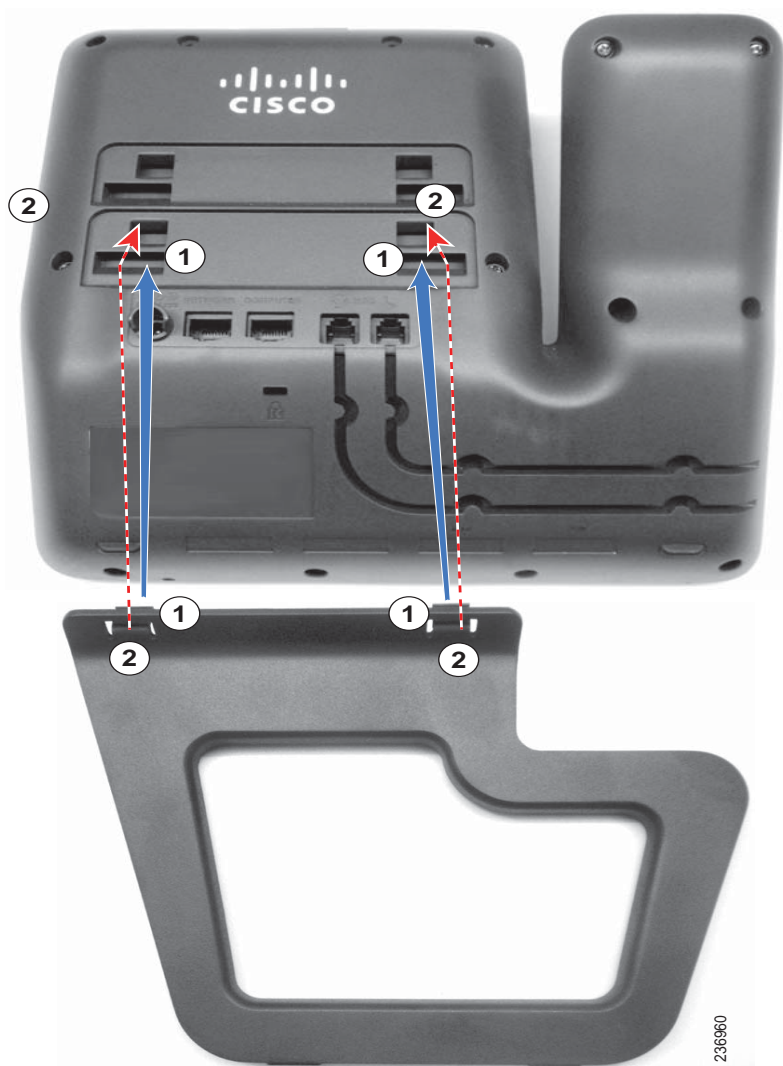

- | | |
|--|--|
| <p>1 Insert the curved connectors into the lower slots.</p> | <p>2 Lift the footstand until the connectors snap into the upper slots.</p> |
|--|--|



Note Connecting and disconnecting the footstand may require a little more force than you expect.











Buttons and Hardware











Your phone provides quick access to your phone lines, features, and call sessions. The Programmable Feature buttons (left side) is used to view calls on a line or access features such as speed dial or All Calls. (These buttons are also called Line buttons.)



236661

1	Phone screen	Shows information about your phone, including directory number, call information (for example caller ID, icons for an active call or call on hold) and available softkeys.
---	--------------	--

2	Video Camera 	Connects to your Cisco Unified IP Phone and allows you to make a point-to-point video call with another Cisco Unified IP Phone.
3	Lens Cover button	Integrated lens cover protects the camera lens.
4	Softkey buttons 	Allows you to access the softkey options (for the selected call or menu item) displayed on your phone screen.
5	Navigation pad and Select button 	The two-way Navigation pad allows you to scroll through menus, highlight items, and move within a text input field. The Select button (center of the Navigation pad) allows you to select a highlighted item as well as wake up the phone from deep sleep mode. The Select button is lit (white) when the phone is in power-save mode.
6	Conference button 	Creates a conference call.
7	Hold button 	Places a connected call on hold.
8	Transfer button 	Transfers a call.
9	Redial button 	Redials a call.
10	Keypad	Allows you to dial phone numbers, enter letters, and choose menu items (by entering the item number).
11	Speakerphone button 	Selects the speakerphone as the default audio path and initiates a new call, picks up an incoming call, or ends a call. During a call, the button is lit green. The speakerphone audio path does not change until a new default audio path is selected (for example, by picking up the handset). If external speakers are connected, the Speakerphone button selects them as the default audio path.
12	Video Mute button 	Mutes the video from the phone screen during a video call. When Video Mute is on, the Video Mute button is lit red.
13	Mute button 	Toggles the microphone on or off during a call. When the microphone is muted, the button is lit red.

14	Headset button 	Selects the headset as the default audio path and initiates a new call, picks up an incoming call, or ends a call. During a call, the button is lit green. A headset icon  in the phone screen header line indicates the headset is the default audio path. This audio path does not change until a new default audio path is selected (for example, by picking up the handset).
15	Volume button 	Controls the handset, headset, and speakerphone volume (off hook) and the ringer volume (on hook). Silences the ringer on the phone if an incoming call is ringing.
16	Messages button 	Auto-dials your voicemail system (varies by system).
17	Applications button 	Opens the Applications menu. Depending on how your system administrator sets up the phone, use it to access applications such as call history, preferences, administrator settings, and phone information.
18	Contacts button 	Opens/closes the Contacts menu. Depending on how your system administrator sets up the phone, use it to access personal directory, corporate directory, or call history.
19	Phone Speaker	Speaker for the phone.
20	Programmable feature buttons (also called Line buttons) 	Each corresponds with a phone line, speed dial, and calling feature. Pressing a button for a phone line displays the active calls for that line. Color LEDs indicate the line state: <ul style="list-style-type: none"> • Amber —Ringing call on this line • Green —Active or held call on this line • Red —Shared line in-use remotely
21	Handset rest	To rest the phone handset. When there is an incoming call, the LED in the handset rest flashes red. If there is a new voice message, the LED is lit red.

Phone Screen

The way that your system administrator sets up your phone determines what is displayed on your phone screen.

Phone with a Single Line



1	Line label	Displays the line phone information.
2	Header	Displays the date and time, and information (such as phone number) about the selected line.
3	Primary line details and other phone information	Displays information (such as phone number and duration) about a connected call on the line. The timer counts the call duration in minutes and seconds (MM:SS) until the call exceeds 60 minutes. Then the timer counts hours and minutes (HH:MM).

4	Softkeys	Softkey options for the selected (highlighted) call only. If you select a different call (by pressing a feature button or the Navigation pad, or by answering a ringing call), the softkey options may change.
---	----------	---

Phone with Multiple Lines

If you have multiple lines, it is recommended that you use the All Calls button to view all calls on all lines.

If you handle many calls at one time, it is recommended that you use the Answer button to answer the oldest incoming call without having to scroll down the call list and select the call.

For more information, see your system administrator.

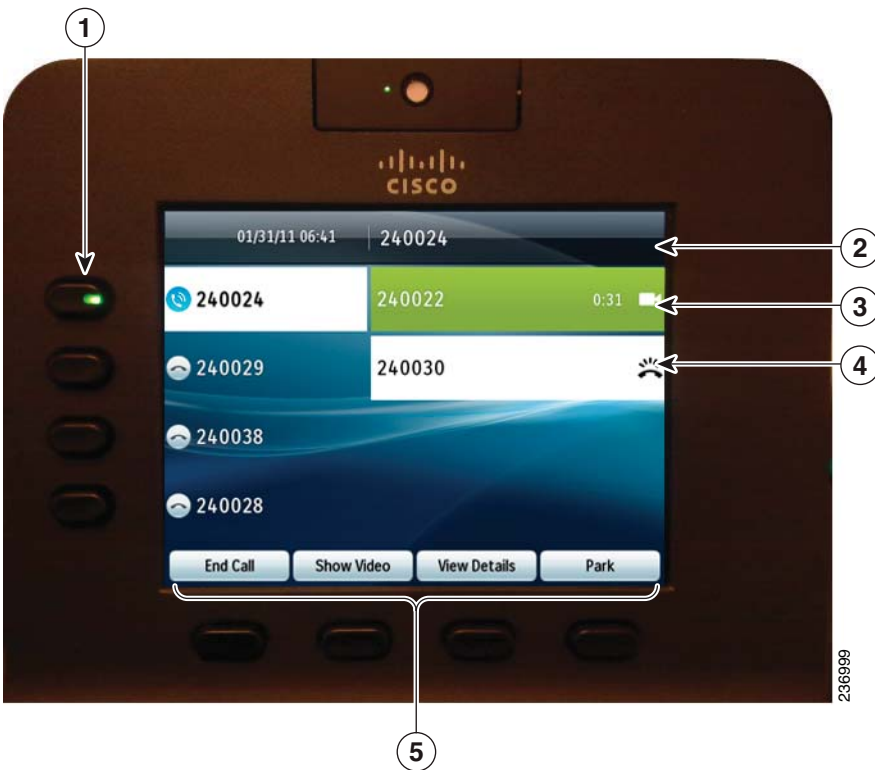

1	Primary line label	<p>Displays information about the primary phone line.</p> <p>Look for the blue icon on the line label to see which line is selected. In this case, the primary line is selected, and the information displayed is for the primary line only.</p>
2	Header	<p>Displays the date and time, and information (such as phone number) about the selected line.</p>
3	Primary line details and other phone information	<p>Displays information (such as call status and duration) about a connected call associated with the selected line.</p>
4	Secondary line details and other phone information.	<p>Displays information (such as call status and duration) about a connected call associated with the selected line.</p>
5	Softkeys	<p>Softkey options for the selected call only.</p> <p>If you select a different call (by pressing a feature button or the Navigation pad, or by answering a ringing call), the softkey options may change.</p>

Power-Save Mode

Depending on how your system administrator sets up your phone, the phone display may go into a power-save mode (the phone screen appears blank and the Select button is lit white).

To turn on the phone display, press any button or pick up the handset.

Handset Rest

Your system administrator may have mounted your phone on a wall. With a wall-mounted phone, you may need to adjust the handset rest to ensure that the receiver does not slip out of the cradle.

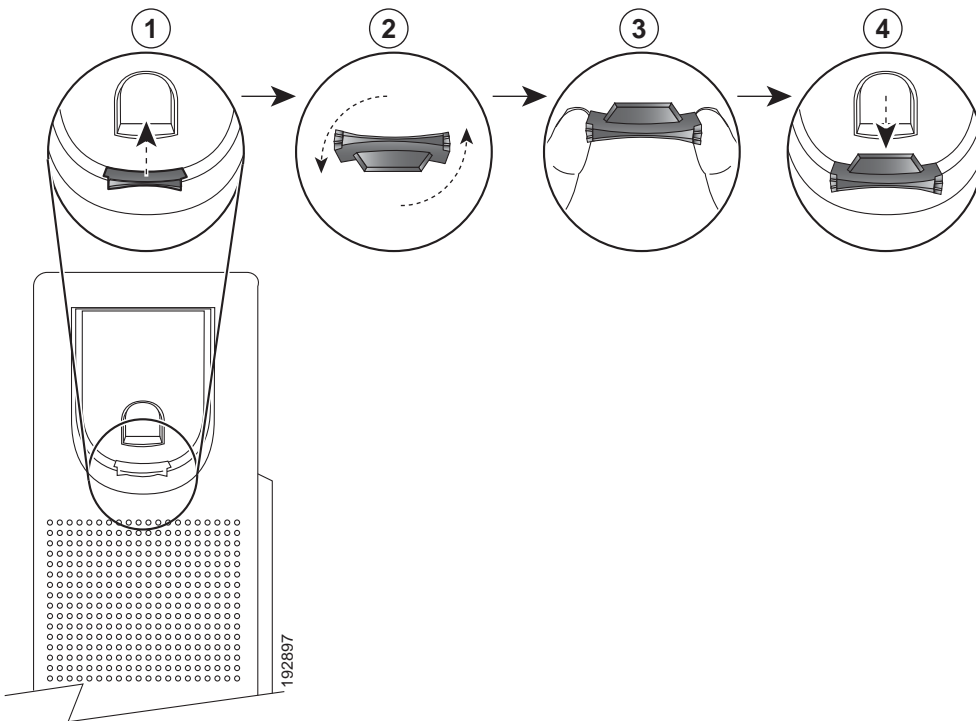

1	Remove the handset from the cradle and pull the plastic tab from the handset rest.
2	Rotate the tab 180 degrees.
3	Hold the tab between two fingers, with the corner notches facing you.
4	Line up the tab with the slot in the cradle and press the tab evenly into the slot. An extension protrudes from the top of the rotated tab. Return the handset to the handset rest.

Cisco Unified IP Phone 8945

The Cisco Unified IP Phone 8945 provides these features:

- Phone connections
- Bluetooth
- Footstand
- Buttons and hardware
- Phone screen
- Power-save mode
- Handset rest

Phone Connections

Your system administrator can help you connect your phone to the corporate IP telephony network.



236959

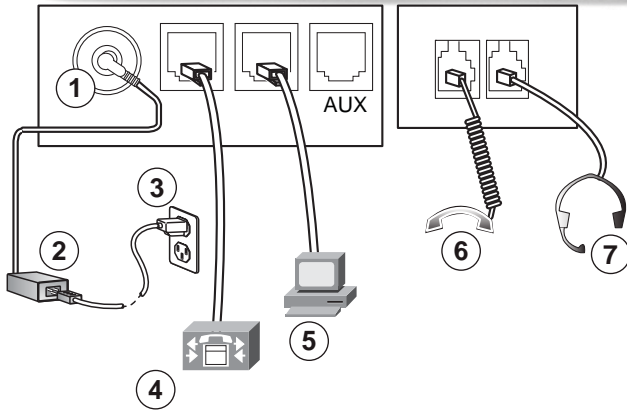

1	DC adapter port (DC48V)	5	Computer port (10/100/1000 PC) connection
2	AC-to-DC power supply (optional)	6	Handset connection
3	AC power wall plug (optional)	7	Analog headset connection (headset optional)
4	Network port (10/100/1000 SW) with IEEE 802.3af and 802.3at power enabled		

Bluetooth

Your phone supports Bluetooth Class 2 technology when the headsets support Bluetooth. You can add and pair up to five Bluetooth headsets to your phone, but the last Bluetooth headset connected becomes the default for use with the phone.

Footstand

If your phone is placed on a table or desk, connect the footstand to the back of the phone.

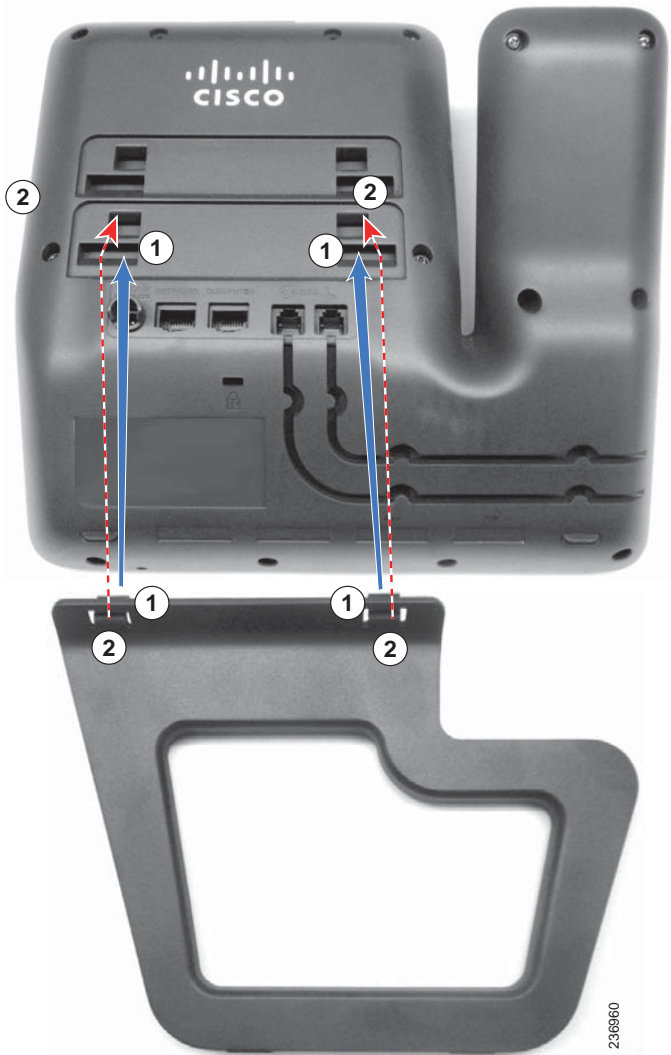

- | | | | |
|----------|--|----------|--|
| 1 | Insert the curved connectors into the lower slots. | 2 | Lift the footstand until the connectors snap into the upper slots. |
|----------|--|----------|--|

**Note**











Connecting and disconnecting the footstand may require a little more force than you expect.











Buttons and Hardware

Your phone provides quick access to your phone lines, features, and call sessions. The Programmable Feature buttons (left side) is used to view calls on a line or access features such as speed dial or All Calls. (These buttons are also called Line buttons.)



1	Phone screen	Shows information about your phone, including directory number, call information (for example caller ID, icons for an active call or call on hold) and available softkeys.
----------	--------------	--

2	Video Camera 	Connects to your Cisco Unified IP Phone and allows you to make a point-to-point video call with another Cisco Unified IP Phone.
3	Lens Cover button	Integrated lens cover protects the camera lens.
4	Softkey buttons 	Allows you to access the softkey options (for the selected call or menu item) displayed on your phone screen.
5	Navigation pad and Select button 	The two-way Navigation pad allows you to scroll through menus, highlight items, and move within a text input field. The Select button (center of the Navigation pad) allows you to select a highlighted item as well as wake up the phone from deep sleep mode. The Select button is lit (white) when the phone is in power-save mode.
6	Conference button 	Creates a conference call.
7	Hold button 	Places a connected call on hold.
8	Transfer button 	Transfers a call.
9	Redial button 	Redials a call.
10	Keypad	Allows you to dial phone numbers, enter letters, and choose menu items (by entering the item number).
11	Speakerphone button 	Selects the speakerphone as the default audio path and initiates a new call, picks up an incoming call, or ends a call. During a call, the button is lit green. The speakerphone audio path does not change until a new default audio path is selected (for example, by picking up the handset). If external speakers are connected, the Speakerphone button selects them as the default audio path.
12	Video Mute button 	Mutes the video from the phone screen during a video call. When Video Mute is on, the Video Mute button is lit red.
13	Mute button 	Toggles the microphone on or off during a call. When the microphone is muted, the button is lit red.

14	Headset button 	<p>Selects the headset as the default audio path and initiates a new call, picks up an incoming call, or ends a call. During a call, the button is lit green.</p> <p>A headset icon  in the phone screen header line indicates the headset is the default audio path. This audio path does not change until a new default audio path is selected (for example, by picking up the handset).</p>
15	Volume button 	<p>Controls the handset, headset, and speakerphone volume (off hook) and the ringer volume (on hook).</p> <p>Silences the ringer on the phone if an incoming call is ringing.</p>
16	Messages button 	<p>Auto-dials your voicemail system (varies by system).</p>
17	Applications button 	<p>Opens/closes the Applications menu. Depending on how your system administrator sets up the phone, use it to access applications such as call history, preferences, and phone information.</p>
18	Contacts button 	<p>Opens/closes the Contacts menu. Depending on how your system administrator sets up the phone, use it to access personal directory, corporate directory, or call history.</p>
19	Phone Speaker	<p>Speaker for the phone.</p>
20	Programmable feature buttons (also called Line buttons) 	<p>Each corresponds with a phone line, speed dial, and calling feature.</p> <p>Pressing a button for a phone line displays the active calls for that line.</p> <p>If you have multiple lines, you may have an All Calls button that displays a consolidated list of all calls from all lines (oldest at the top). Then it is recommended that you keep your phone in the All Calls view.</p> <p>Color LEDs indicate the line state:</p> <ul style="list-style-type: none"> • Amber —Ringing call on this line • Green —Active or held call on this line • Red —Shared line in-use remotely <p>(The positions of the feature buttons can be reversed on phones that use a locale with a right-to-left reading orientation, such as Hebrew and Arabic.)</p>
21	Handset rest	<p>To rest the phone handset.</p> <p>When there is an incoming call, the LED in the handset rest flashes red. If there is a new voice message, the LED is lit red.</p>

Phone Screen

The way that your system administrator set up your phone determines what is displayed on your phone screen.

Phone with a Single Line

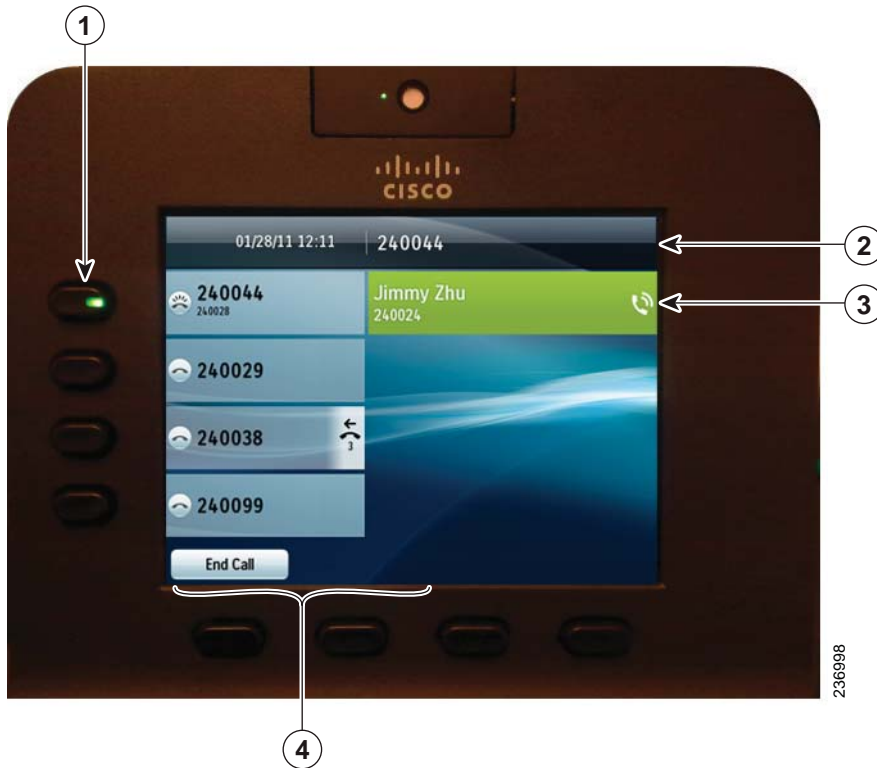

1	Line label	Displays the line phone information.
2	Header	Displays the date and time, and information (such as phone number) about the selected line.
3	Primary line details and other phone information	Displays information (such as phone number and duration) about a connected call on the line. The timer counts the call duration in minutes and seconds (MM:SS) until the call exceeds 60 minutes. Then the timer counts hours and minutes (HH:MM).
4	Softkeys	Softkey options for the selected (highlighted) call only. If you select a different call (by pressing a feature button or the Navigation pad, or by answering a ringing call), the softkey options may change.

Phone with Multiple Lines

If you have multiple lines, it is recommended that you use the All Calls button to view all calls on all lines.

If you handle many calls at one time, it is recommended that you use the Answer button to answer the oldest incoming call without having to scroll down the call list and select the call.

For more information, see your system administrator.

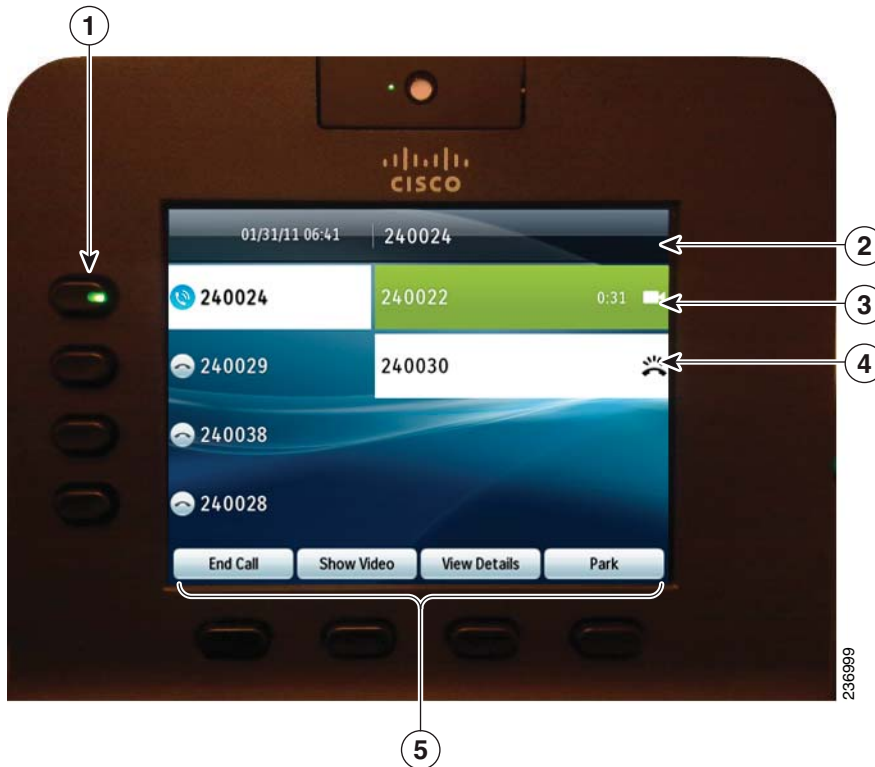

1	Primary line label	Displays information about the primary phone line. Look for the blue icon on the line label to see which line is selected. In this case, the primary line is selected, and the information displayed is for the primary line only.
2	Header	Displays the date and time, and information (such as phone number) about the selected line.
3	Primary line details and other phone information	Displays information (such as call status and duration) about a connected call associated with the selected line.
4	Secondary line details and other phone information.	Displays information (such as call status and duration) about a connected call associated with the selected line.
5	Softkeys	Softkey options for the selected call only. If you select a different call (by pressing a feature button or the Navigation pad, or by answering a ringing call), the softkey options may change.

Power-Save Mode

Depending on how your system administrator set up your phone, the phone display may go into a power-save mode (the phone screen appears blank and the Select button is lit white).

To turn on the phone display, press any button or pick up the handset.

Handset Rest

Your system administrator may have mounted your phone on a wall. With a wall-mounted phone, you may need to adjust the handset rest to ensure that the receiver does not slip out of the cradle.

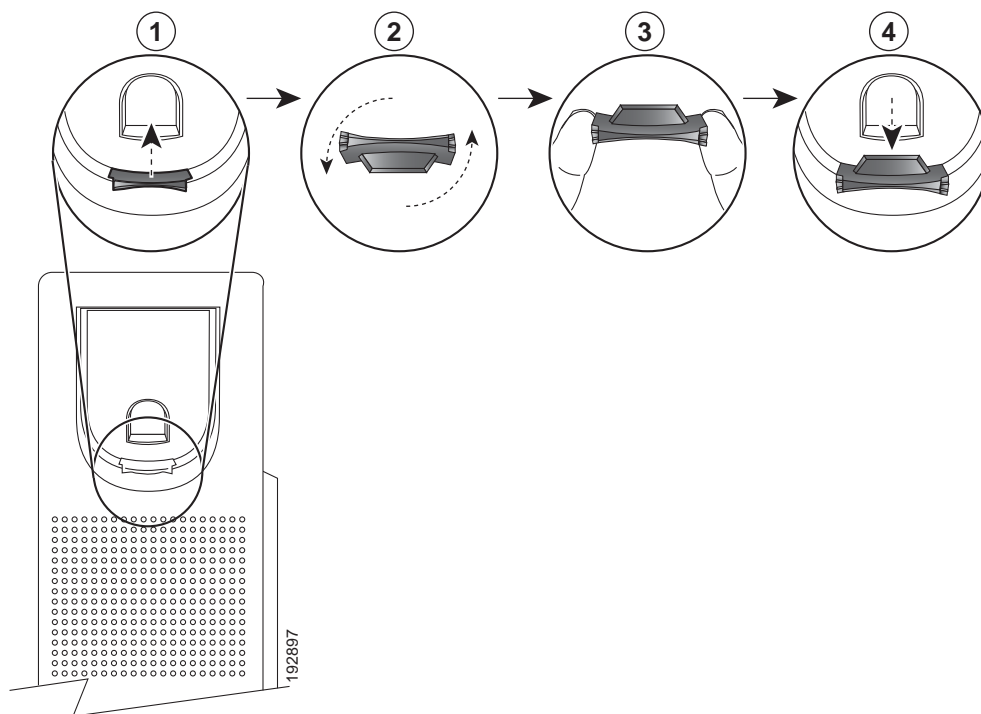

1	Remove the handset from the cradle and pull the plastic tab from the handset rest.
2	Rotate the tab 180 degrees.
3	Hold the tab between two fingers, with the corner notches facing you.
4	Line up the tab with the slot in the cradle and press the tab evenly into the slot. An extension protrudes from the top of the rotated tab. Return the handset to the handset rest.

Applications

Phone Applications

Phone applications allow you to access the following:



- Call History
- Preferences
- Accessories
- Administrator Settings (for system administrators only).
- Phone Information

Call History

Call History allows you to view information about the last 150 calls on your phone. Individual calls and call groups are listed chronologically from the most recent call to the oldest one. (If your phone has multiple lines, calls on all lines are added together. The oldest calls over the 150-call limit are dropped from the history.)

In the Call History screen, the line information, such as “Line: 5623,” is shown in the upper right corner to indicate the line name or number for which the call history is displayed.

For each call record or call group, an icon to the left of the caller ID shows the call type:

- Received—
- Placed—
- Missed—

If the caller ID is unavailable, “Unknown” is displayed, and the phone number is listed.

Calls for the same caller ID and phone number are grouped together only when if they occur in chronological order and do not have calls associated. For each group, the time of the latest call and the number of calls, such as “(3),” are displayed:

- Incoming (Received) and outgoing (Placed) calls are grouped together.
- Missed calls are grouped together in a separate group.



Hunt group and multiparty calls show an icon to the right of the caller ID that differentiates the call from a normal call, and these calls are not grouped even when they are next to each other in the list.

A (plus) + symbol on entries in call history, redial, or call directory indicates that your phone is set up to list international calls. For more information, see your system administrator.

View Call History

1. Press the **Applications** button .
2. Select **Call History**. (Use the Navigation pad and Select button to scroll and select a call record or call group.)
3. Press the **Exit** softkey to return to the Applications screen.

View Call Record Details

1. Press the **Applications** button .
2. Select **Call History**. (Use the Navigation pad and Select button to scroll and select.)
3. Select a call record or group and press the **Details** softkey (you may need to press the **More** softkey first).
 - For each individual call, the Details screen displays the line information in the upper right corner, such as “Line: 5782,” and the call name, call number, alternate number (if available), call disposition (call type), call duration, and time of the call.
 - For each call group, the details shown are the same as for an individual call. The only difference is that the multiple call-related information is shown, such as call disposition (call type), call duration, and time of call, because this is a group of calls (Placed/Received or Missed). (In a group of Missed calls, individual records show no call duration.)
 - For each multiparty or hunt group call, the Details screen displays the line information in the upper right corner. For the caller ID and number listed at the top of the screen, the call name, call number, alternate number, and as applicable, the hunt group information, if available.
4. Press the return softkey  to return to the Call History screen.
5. Press the **Exit** softkey to return to the Applications screen.
6. While on a connected call, press the **Show Details** softkey to show the Call Details screen. This screen displays single call information and call duration and is updated each second.



Filter Call History

1. Press the **Applications** button .
2. Select **Call History**. (Use the Navigation pad and Select button to scroll and select.)



The default view in Call History is for “All Calls,” which is shown at the top of the screen. The line information, such as “Line: 5623,” is shown in the upper right corner.
3. To sort calls for a specific phone line, select that phone line and view the individual calls or calls groups for that line.
4. To sort by missed calls for the selected line, press the **Missed Calls** softkey.

5. Press the **Exit** softkey to return to the Applications screen.

Dial From Call History

1. Press the **Applications** button .
2. Select **Call History**. (Use the Navigation pad and Select button to scroll and select.)
3. From the Call History screen, select the call record that you want to dial and do one of the following:
 - Press the **Call** softkey.
 - Pick up the handset.
 - Press the **Select** button.
 - Press the **Speakerphone** button  or **Headset** button .
4. When the phone is in idle, you can press the up arrow on the Navigation pad to display the Call History screen.

Edit Number From Call History

1. Press the **Applications** button .
2. Select **Call History**. (Use the Navigation pad and Select button to scroll and select.)
3. Highlight the call record that you want to edit.
4. Press the **EditDial** softkey. (You may need to press the **More** softkey first.)
5. Press the up or down arrow on the **Navigation** bar to move the cursor to the desired location.
6. Press the  softkey to delete numbers on the left of the cursor.
7. Press the **Call** softkey to dial the new edited number.
8. Press the return softkey  to return the Call History screen.

Clear Call History

1. Press the **Applications** button .
2. Select **Call History**. (Use the Navigation pad and Select button to scroll and select.)
3. Press the **Clear List** softkey to clear the entire call history on the phone.
4. Press the **Exit** softkey to return to Applications screen.

Delete Call Record From Call History

1. Press the **Applications** button .
2. Select **Call History**. (Use the Navigation pad and Select button to scroll and select.)
3. Highlight the individual call record or call group that you want to delete.

4. Press the **Delete** softkey. (You may need to press the **More** softkey first.)
For a call group, pressing **Delete** deletes all calls in the group. A Delete Record alert message displays to verify that you want to delete the entire group of calls.
5. Press the **Cancel** softkey if desired.
6. Press the **Exit** softkey to return to Applications screen.

Preferences



Preferences allows you to set user preferences for the following items:

- Ringtone
- Brightness
- Camera Settings
- Bluetooth

Ringtones

You can choose the ringtone, per line, that your phone plays to indicate an incoming call. For information about adding custom ringtones to your phone, see your system administrator.

Change Ringtone for a Line

1. Press the **Applications** button .
2. Select **Preferences**. (Use the Navigation pad and Select button to scroll and select.)
3. Select **Ringtone**.
4. Highlight a ringtone.
5. Press **Select** button or **Edit** softkey.
6. Press the **Play** softkey to play the sample ringtone.
7. Press the **Set** softkey to apply the ringtone.
8. Press the return softkey  to return to the Preferences screen.

Brightness

You can adjust your phone screen brightness level.

Adjust the Brightness

1. Press the **Applications** button .
2. Select **Preferences**. (Use the Navigation pad and Select button to scroll and select.)



3. Select **Brightness**.
 - To increase brightness, press the up arrow on the **Navigation** pad.
 - To decrease brightness, press the down arrow on the **Navigation** pad.
4. Press the **Save** softkey to set the brightness, or press the **Cancel** softkey to exit.

Camera Settings

You can change the phone camera settings by selecting the available options - Auto Transmit Video and Brightness.

Enable Auto Transmit Video

You can transmit the video automatically whenever a call is initiated or accepted. If a video transmission is in progress, the camera LED turns green, and when on video mute it turns red. The LED is turned off when the camera is not in use.

1. Press the **Applications** button .
2. Select **Preferences**. (Use the Navigation pad and Select button to scroll and select.)
3. Select **Camera Settings > Auto Transmit Video** option.
4. Select **Yes** to enable automatic video transmission or **No** to disable the feature.
5. Press the **Apply** softkey to apply the feature, or press the return softkey  to return to the Set-up screen.

Adjust Brightness

You can set the brightness of the camera.



1. Press the **Applications** button .
2. Select **Preferences**. (Use the Navigation pad and Select button to scroll and select.)
3. Select **Camera Settings > Brightness** option.
4. Select **Brightness**.
 - To increase brightness, press the up arrow on the Navigation pad.
 - To decrease brightness, press the down arrow on the Navigation pad.
5. Press the **Save** softkey to set the brightness, or press the **Exit** softkey to return to the Setup screen.

Bluetooth

If your system administrator has set up the Bluetooth feature for your phone, you can turn it on and off from your phone.



Turn On Bluetooth

(For Cisco Unified IP Phone 8945 only.)

1. Press the **Applications** button .
2. Select **Preferences**. (Use the Navigation pad and Select button to scroll and select.)
3. Select **Bluetooth**.
4. Press the **Yes** softkey. The Bluetooth icon  displays on the phone screen header.
To add a Bluetooth accessory from this screen, select **Bluetooth** again.

Turn Off Bluetooth

(For Cisco Unified IP Phone 8945 only.)

1. Press the **Applications** button .
2. Select **Preferences**. (Use the Navigation pad and Select button to scroll and select.)
3. Select **Bluetooth**.
4. Press the **No** softkey.
The Bluetooth icon  disappears from the phone screen header.

Accessories

You can connect external hardware to your phone using either the headset jack or Bluetooth. The accessory list, by default, contains an analog headset that can be set up to enable wideband.

View Accessories List

1. Press the **Applications** button .
2. Select **Accessories**. (Use the Navigation pad and Select button to scroll and select.)
A list of phone accessories is displayed.
3. Press the **Exit** softkey to return to a list of phone accessories.



View Accessory Details

1. Press the **Applications** button .
2. Select **Accessories**. (Use the Navigation pad and Select button to scroll and select.)
A list of phone accessories displays.
3. Select an accessory from the list and press the **Details** softkey.

The phone screen displays the details of the selected accessory. The information displayed on the phone screen depends on the selected accessory. Most of the accessories provide these details:

- Device Name
 - Device Type
 - Configured
4. Press the **Exit** softkey to return to a list of phone accessories.

Set Up Wideband for Analog Headset

1. Press the Applications button .
2. Select **Accessories**. (Use the Navigation pad and Select button to scroll and select. A list of phone accessories is displayed.)
3. Select **Analog Headset** and press the Setup softkey. The phone screen displays the wideband status for the analog headset.
4. Press the **Turn On** softkey to enable wideband for the analog headset.
5. Press the **Turn Off** softkey to disable wideband for the analog headset.
6. Press the return softkey  to return to a list of phone accessories.

Add Bluetooth Accessory

(For Cisco Unified IP Phone 8945 only.)

Before You Begin

Before you add a Bluetooth accessory, it must be discoverable by the phone. Look for a flashing LED on a Bluetooth accessory as an indication that it is discoverable. For more information, see the documentation from the Bluetooth accessory manufacturer.

1. Press the **Applications** button .
2. Select **Accessories**. (Use the Navigation pad and Select button to scroll and select.)
3. Select **Add Bluetooth Accessory**.
The phone searches for discoverable accessories that are supported. When an accessory is found, it is added to the list in the Adding Bluetooth Accessory screen.
4. Select the accessory and press the **Connect** softkey.
5. The phone automatically attempts to connect the accessory using a Bluetooth device PIN of “0000.” If your accessory requires a different PIN and the Adding PIN screen displays, enter the PIN for your accessory.

When the connection is completed, the Bluetooth active icon  displays on the phone screen header and a check mark displays next to the connected accessory.

Delete Bluetooth Accessory

(For Cisco Unified IP Phone 8945 only.)

1. Press the **Applications** button .
2. Select **Accessories**. (Use the Navigation pad and Select button to scroll and select.)
3. Select a Bluetooth accessory and press the **Delete** softkey.
4. When prompted, press the **Yes** softkey.

The Bluetooth accessory will be disconnected (if it was connected) and removed from the Accessories list.

Connect Bluetooth Accessory

(For Cisco Unified IP Phone 8945 only.)

Before You Begin

Before you can connect a Bluetooth accessory, it must be already added as an accessory to the phone.

1. Press the **Applications** button .
2. Select **Accessories**. (Use the Navigation pad and Select button to scroll and select.)
3. Select a Bluetooth accessory and press the **Connect** softkey.

When the connection is completed, the Bluetooth active icon  displays on the phone screen header and a check mark displays next to the connected accessory.

Disconnect Bluetooth Accessory

(For Cisco Unified IP Phone 8945 only.)

1. Press the **Applications** button .
2. Select **Accessories**. (Use the Navigation pad and Select button to scroll and select.)
3. Select a Bluetooth accessory and then press the **Disconnect** softkey.

Administrator Settings

For information on accessing and changing the Administrator Settings, see your system administrator.

Phone Information

Phone Information allows you to view the model information for your phone:

- Model Number

- IP Address
- Host Name
- Active Load
- Last Upgrade
- Active Server
- Stand-by Server

View Phone Information

1. Press the **Applications** button .
2. Select **Phone Information**. (Use the Navigation pad and Select button to scroll and select.)
3. Press the **Exit** softkey to return to the Applications screen.

Contacts

Phone Contacts

The Cisco Unified IP Phone 8941 and 8945 provide you with access to corporate and personal contacts using these directories:

- Corporate Directory
- Personal Directory

You may see other directories listed in Contacts. For more information, see your system administrator.

Related Topic

[Call History, page 23](#)

Corporate Directory



The corporate directory contains corporate contacts that you can access on your phone. Your system administrator sets up and maintains the directory.

You can dial calls from your corporate directory:

- When you are not on another call.
- When you are on another call.

Search for and Dial a Contact

1. Press the **Contacts** button .
2. Select **Corporate Directory**. (Use the Navigation pad and **Select** button to scroll and select.)
3. Select one or all of these search criteria to search for a co-worker:
 - First Name
 - Last Name
4. Enter the search criteria information, press the **Submit** softkey, and select a contact.
5. To dial, perform any of these actions:
 - Press the **Dial** softkey.
 - Press the **Select** button.

- From the keypad, press the number that is displayed in the upper right-hand corner of the contact label.
- Press the **Speakerphone** button .
- Press the **Headset** button .
- Pick up the handset.

Search for and Dial a Contact While on a Call

1. Press the **Contacts** button .
2. Select **Corporate Directory**. (Use the Navigation pad and **Select** button to scroll and select.)
3. Select one or both of these search criteria to search for a co-worker:
 - First Name
 - Last Name
4. Enter the search criteria information and press the **Search** softkey.
5. Press the **Dial** softkey. The first call gets automatically put on hold while the second call gets dialed.

Personal Directory

The personal directory contains a list of your personal contacts. You can assign fast-dial codes to your personal directory entries for fast dialing.

There are two ways you can set up and maintain your personal directory:

- **Phone**—Using your phone, you can:
 - Set up and use Personal Directory
 - Assign and use fast-dial codes
- **User Options Web Pages**—Using User Options web pages, you can also set up and use your personal directory.

Related Topics

[User Options, page 69](#)

Personal Directory Options

From your phone, you can use personal directory options to:

- Sign in and out
- Add an entry
- Search for an entry

- Dial a number
- Delete an entry
- Edit an entry

Sign In and Out of Personal Directory

1. Press the **Contacts** button .
2. Select **Personal Directory**. (Use the Navigation pad and **Select** button to scroll and select.)
3. Enter your user ID and PIN (provided by your system administrator) and then press the **Submit** softkey.
4. Select **Log Out**.
5. Press the **Select** softkey.
6. Press the **OK** softkey to sign out.

You are logged out automatically after a certain amount of time. This time limit can vary. For more information, see your system administrator.

Add a Personal Directory Entry

1. Press the **Contacts** button .
2. Sign in to **Personal Directory**.
3. Select **Personal Address Book**; the Search for an entry screen displays.
4. Press the **Submit** softkey.
5. Press the **New** softkey (you may need to press the **More** softkey first).
6. Enter the nickname information (you can also enter a name).
7. Press the **Phones** softkey and enter the phone numbers.
Include any required access codes such as a **9** or **1**.
8. Press the **Submit** softkey to add the entry to your personal directory.

Search for an Entry in Personal Directory

1. Press the **Contacts** button .
2. Sign in to **Personal Directory**.
3. Select **Personal Address Book**.
4. Select one, all, or none of these criteria to search for an entry:
 - Last Name
 - First Name
 - Nickname

5. Enter the search criteria information and then press the **Submit** softkey. The name displays.

Dial a Number from Personal Directory

1. Press the **Contacts** button .
2. Sign in to **Personal Directory**.
3. Select **Personal Address Book** and search for an entry.
4. Select the personal address book entry that you want to dial.
5. Press the **Dial** softkey.

Delete a Personal Directory Entry

1. Press the **Contacts** button .
2. Sign in to **Personal Directory**.
3. Select **Personal Address Book** and search for an entry.
4. Press the **Select** softkey.
5. Press the **Edit** softkey.
6. Press the **Delete** softkey. (You may need to press the **More** softkey first.)
7. Press the **OK** softkey to confirm the deletion.

Edit a Personal Directory Entry

1. Press the **Contacts** button .
2. Sign in to **Personal Directory**.
3. Select **Personal Address Book** and search for an entry.
4. Press the **Select** softkey.
5. Press the **Edit** softkey.
6. Modify the entry information.
7. Press the **Phones** softkey to modify a phone number.
8. Press the **Update** softkey.

Fast-Dial Codes with Personal Directory

Using the phone, you can:

- Assign a fast-dial code to a Personal Directory entry
- Place a call using a fast-dial code
- Delete a fast-dial code

Assign a Fast-Dial Code to a Personal Directory Entry

1. Press the **Contacts** button .
2. Sign in to **Personal Directory**. (Use the Navigation pad and **Select** button to scroll and select.)
3. Select **Personal Address Book**.
4. Enter the name information and press the **Submit** softkey.
5. Press the **Select** softkey and then press the **FastDial** softkey.
6. Select a number and press the **Select** softkey.
7. Scroll to an unassigned fast-dial index.
(You may have to press the **Next** softkey to get to more fast-dial indexes.)
8. Press the **Select** softkey.

Place a Call Using a Fast-Dial Code

1. Press the **Contacts** button .
2. Sign in to **Personal Directory**.
3. Select **Personal Fast Dials** and scroll to a fast-dial code.
(You may have to press the **Next** softkey to get to more fast-dial codes.)
4. Select the fast-dial code you want to dial and press the **Dial** softkey.

Delete a Fast-Dial Code

1. Press the **Contacts** button .
2. Sign in to **Personal Directory**.
3. Select **Personal Fast Dials** and search for a fast-dial code.
4. Select the fast-dial code that you want to delete and press the **Remove** softkey.
(You may need to press the **More** softkey first.)
5. Select the index to delete.
6. Press the **Remove** softkey.

Messages

Voice Messages

Voice messages are stored on your voicemail system. Your company determines the voicemail system your phone uses.

You can:



- Personalize your voicemail
- Check for voice messages
- Listen to voice messages

Personalize Your Voicemail

Press the **Messages** button , then follow the voice prompts.

Check for Voice Messages

Check for voice messages in any of these ways:

- Look for a solid red light on your handset.
You can set up the visual message waiting lamp using your User Options Web pages.
- Look for a Message icon  on a line label.
The red background indicates that there are new voice messages.
If call forwarding is set up on a line that has new voice messages, the Call Forward icon  replaces the Message icon on the line label.
- Listen for a stutter tone (if available) from your handset, headset, or speakerphone when you place a call.
The stutter tone is line-specific. You hear it only when using the line that has new voice messages.
You can set up audible message waiting tones using your User Options Web pages.

Related Topics

- [Change the Audible Voice Message Indicator Setting Per Line, page 72](#)

- [Change the Voice Message Indicator Setting Per Line, page 71](#)

Listen to Voice Messages

1. To listen to voice messages, press the **Messages** button .
2. Follow the prompts to listen to your voice messages.

After you listen to your new voice messages, the message indicators are updated on the phone screen. If there are no new voice messages, the Message icon is removed from the line label, and the Voicemail icon is removed from the right side of the phone screen.

Calling Features

Feature Buttons and Softkeys

Depending on how your system administrator set up your phone, some features included in this guide may not be available to you.

This table provides information about some of the features that are available on softkeys and dedicated feature buttons and some that your system administrator sets up on programmable feature buttons.

Feature Name	Dedicated Feature Button	Programmable Feature Button	Softkey
Answer		X	
Call Back		X	X
Call Forward All		X	X
Call Park		X	X
Call Park Line Status		X	
Call Pickup		X	
Call Pickup Line Status		X	
Conference	X		X (available while on a conference only)
Divert			X
Do Not Disturb		X	
Group Pickup		X	
Hold	X		
Hunt Groups		X	
Intercom		X	
Malicious Call Identification (MCID)		X	

Feature Name	Dedicated Feature Button	Programmable Feature Button	Softkey
Meet Me		X	
Mobile Connect		X	
Mute (Audio)	X		
Mute (Video)	X		
Other Pickup		X	
Privacy		X	
Quality Reporting Tool (QRT)		X	
Redial	X		
Speed Dial		X	X
Speed Dial Line Status		X	
Transfer	X		X (available during a transfer only)

Agent Greeting

The Agent Greeting feature allows an agent to create and update a prerecorded greeting that plays at the beginning of a call, such as a customer call, before the agent begins the conversation with the caller. The agent can prerecord a single greeting or multiple ones as needed.

When a customer calls, both callers hear the prerecorded greeting. The agent can remain on mute until the greeting ends or answer the call over the greeting.

For more information, see your system administrator.

Answer

Answer allows you to answer the oldest call that is available on all line appearances on your phone, including Hold Reversion and Park Reversion calls that are in an alerting state. Incoming calls are always given priority over Held or Park Reversion calls.

Your system administrator sets up the Answer button depending on your call-handling needs and work environment. This feature is typically set up for users who have multiple lines.

Answer Your Oldest Call First

To answer the oldest incoming call first, press the **Answer** button.

Auto Answer

Auto Answer prompts your phone to automatically answer incoming calls after one ring.

Your system administrator sets up Auto Answer to work with either your speakerphone or headset.

Auto Answer with Your Headset

If Auto Answer with Headset is active and set up by your administrator, the Headset button  is illuminated and headset is connected, incoming call is answered with the headset. Otherwise, calls ring normally and you must manually answer them. To keep the Headset button illuminated, use buttons and softkeys (instead of the Headset button) to place and end calls. Your administrator has to set headset as the default audio path for auto answer.

Auto Answer with Your Speakerphone

Keep the handset in the cradle and the Headset button  unlit. Otherwise, calls ring normally and you must manually answer them.

Barge

The barge feature allows you to add yourself to non-private calls on a shared line. You can convert the call into a conference and add new participants.

Add Yourself to a Call on a Shared Line

Press the red line button for the shared line. You are added to the call.

Call Back

Call Back allows you to receive an audio and visual notification on your phone when a busy or unavailable party becomes available.

Call Back, which is available as a softkey, may also be available as a feature button. See your system administrator for additional information.

Set up a Call Back Notification

1. Press the **Callback** softkey while listening to the busy tone or ring sound.
A confirmation screen displays on the phone.
2. Press the **Exit** softkey to exit the confirmation screen, if desired.
Your phone alerts you when the line is free.
3. Press the **Dial** softkey to place the call again, if desired.

Call Forward All

Call Forward All allows you to forward calls from any line on your phone to another number.

You can set up Call Forward All directly on your phone for any line. To set up Call Forward All remotely, go to your User Options web pages.

There are two types of call-forwarding features that your system administrator may set up on your phone:

- Unconditional call forwarding (Call Forward All)—Applies to all calls that you receive.
- Conditional call forwarding (Call Forward No Answer, Call Forward Busy, Call Forward No Coverage)—Applies to certain calls that you receive, according to conditions, and is accessible only from your User Options web pages.

When forwarding calls from your phone:

- Enter the call forward target number exactly as you would dial it from your phone. For example, enter an access code or the area code, if necessary.
- Call forwarding is phone-line specific. If a call reaches you on a line where call forwarding is not enabled, the call will ring as usual.
- Your system administrator can set up other call-forward options that do the following:
 - Allow calls placed from the call forward target number to your phone to ring through, rather than be forwarded.
 - Prevent you from creating a call-forward loop or exceeding the maximum number of links in a call forwarding chain.

Related Topics

[Set Up Call Forwarding Per Line, page 71](#)

Forward Calls on Your Phone

1. On any idle line from which you want to forward your calls, press the **Forward All** softkey.
2. Enter a phone number, or select an entry from the Call History list. (Depending on how your voicemail system is set up, you may be able to press the **Messages** button  to forward all calls to voicemail.)

Visual confirmation displays for a few seconds to confirm the number to which your calls will be forwarded.

3. To verify that your calls are forwarded, look for:
 - A Forward All icon  in the line label.
 - The forwarding information in the header.
4. To cancel call forwarding, press the **Forward Off** softkey.
To set up conditional call forwarding, go to your User Options Web pages.

Call Park

Call Park allows you to use your phone to park (temporarily store) a call, which you can then retrieve from another phone (such as a phone at a co-worker's desk or in a conference room).

There are two ways you can park a call:

- **Park**—Allows you to park an active call that you answered on your phone, and retrieve it using another phone in the Cisco Unified Communications Manager system.
- **Directed Call Park**—Allows you to park and retrieve an active call in two different ways:
 - **Assisted Directed Call Park**—Allows you to park an active call by pressing a feature button, which your system administrator sets up as a speed dial line.
With this type of directed call, you can monitor the status of the line (in-use, idle, or Do Not Disturb) using Line Status indicators.
 - **Manual Directed Call Park**—Allows you to park an active call by transferring it to a Directed Call number, which your system administrator sets up.
You retrieve the call at another phone by dialing a park retrieval prefix number (provided by your system administrator) and then dialing the Directed Call number you used to park the call.

Your system administrator sets up either the Directed Call Park or the Park feature on your phone, but not both.

Related Topics

[Line Status, page 56](#)

Park and Retrieve a Call Using Park

1. During a call, press the **Park** softkey, then hang up.

Your phone displays the number where the system parked the call. The parked call is put on hold, and you can press the **Resume** softkey to resume the call on your phone.

2. From any other Cisco Unified IP Phone in your network, enter the number where the call is parked to retrieve the call.

If you do not retrieve the call within a certain amount of time (set by your system administrator) you will receive an alert tone, at which time you can:

- Press the **Answer** softkey to answer the call on your phone.
- Retrieve the call from another phone.

If you fail to retrieve or answer the call within a specified amount of time, the call is redirected to another destination (set up by your system administrator), such as voicemail. If the call gets redirected, it can no longer be retrieved by using Call Park.

Park and Retrieve a Call Using Assisted Directed Call Park

1. During a call, press a **Directed Call Park** button displaying an idle Line Status indicator.
2. Retrieve the call, from any other Cisco Unified IP Phone in your network as follows:
 - a. Enter the park retrieval prefix.
 - b. Dial the Directed Call number.

For example, if the park retrieval prefix is “99” and the Directed Call number is “1234,” enter 991234.

If you do not retrieve the call within a certain amount of time (set by your system administrator) you will receive an alert tone, at which time you can:

- Press the **Resume** softkey to resume the call on your phone.
- Retrieve the call from another phone.

If you fail to retrieve or resume the call within a specified amount of time, the call is directed to another destination (set up by your system administrator), such as voicemail.

Park and Retrieve a Call Using Manual Directed Call Park

1. During a call, press the **Transfer** button .
2. Enter the Directed Call number where you will park the call.
3. Press **Transfer** again to finish parking the call, then hang up.

4. Retrieve the call, from any other Cisco Unified IP Phone in your network as follows:

- a. Enter the park retrieval prefix.
- b. Dial the Directed Call number.

For example, if the park retrieval prefix is “99” and the Directed Call number is “1234,” enter 991234.

If you do not retrieve the call within a certain amount of time (set by your system administrator) you will receive an alert tone, at which time you can:

- Press the **Resume** softkey to resume the call on your phone.
- Retrieve the call from another phone.

If you fail to retrieve or resume the call within a specified amount of time, the call is directed to another destination (set up by your system administrator), such as voicemail.

Call Pickup

Call Pickup allows you to answer a call that is ringing on a co-worker’s phone by redirecting the call to your phone.

You might use Call Pickup if you share call-handling tasks with co-workers.

There are three ways you can pick up a call:

- **Pickup**—Allows you to answer a call that is ringing on another phone within your call pickup group.
If multiple calls are available for pick up, your phone picks up the oldest call first (the call that has been ringing for the longest time).
- **Group Pickup**—Allows you to answer a call on a phone that is outside your call pickup group by:
 - Using a group pickup number (provided by your system administrator).
 - Dialing the ringing phone’s number.
- **Other Pickup**—Allows you to answer a call that is ringing on another phone within in your call pickup group or in an associated call pickup group.

Your system administrator sets up the call pickup group you are in, and the call pickup softkeys depending on your call-handling needs and work environment.

You can also monitor and pick up ringing calls using Line Status indicators if your system administrator has set up Line Status indicators on speed-dial buttons for you. Line Status indicators allow you to see if a line associated with a speed-dial button is idle, in-use, in a Do Not Disturb state, or ringing.

Related Topics

[Line Status Indicators, page 56](#)

Answer a Call Using Pickup

1. Press the **PickUp** button to transfer a ringing call within your pickup group to your phone.
If you have multiple lines and want to pick up the call on a non-primary line, first press the desired line button, then press **PickUp**.
If your phone supports auto-pickup, you are connected to the call.
2. If the call rings, press the **Answer** softkey to connect to the call.

Answer a Call Using Group Pickup and a Group Pickup Number

1. Press the **Group Pickup** button to answer a call on a phone outside your pickup group.
If you have multiple lines and want to pick up the call on another line, first press the desired line button, then press **Group Pickup**.
2. Enter the group pickup number.
If your phone supports auto-pickup, you are now connected to the call.
3. If the call rings, press the **Answer** softkey to connect to the call.

Answer a Call Using Group Pickup and a Phone Number

1. Press the **Group Pickup** button.
If you have multiple lines and want to pick up the call on a non-primary line, first press the desired line button, then press **Group Pickup**.
2. Enter the number of the phone line with the call that you want to pick up. For example, if the call is ringing on line 12345, enter 12345.
If your phone supports auto-pickup, you are now connected to the call.
3. If the call rings, press the **Answer** softkey to connect to the call.

Answer a Call Using Other Pickup

1. Press the **OPickup** button to transfer a call in your pickup group or in an associated group to your phone.
If your phone supports auto-pickup, you are now connected to the call.
2. If the call rings, press the **Answer** softkey to connect to the call.

Call Waiting

Call Waiting provides these cues to notify you that a new call is ringing on your phone when you are talking on another call:

- Call waiting tone (single beep)
- An amber flashing line button

Respond to a Call Waiting Notification

To answer the ringing call, press the flashing amber line button or press the **Answer** softkey to answer the call. You can also use the Navigation pad and scroll to the call and press the **Select** button to answer it. Your phone puts the original call on hold automatically and connects the ringing call.

- If the call is on a different line, you must first press the line button or the **All Calls** button, if available, to display the ringing session and then answer the call.
- If the call is on the same line and not visible, as there are many calls, then you must scroll to display the sessions.
- If a programmable feature button is set up by your system administrator to answer calls, you can press the feature button to answer a ringing call, regardless of the line of the call or the line that is currently visible. The phone automatically switches the line to display the call.

Conference

Conference allows you to talk simultaneously with multiple parties.

When you are talking on a call, use Conference to dial another party and add them to the call.

If you have multiple phone lines, you can alternately use Conference to combine two calls across two lines. For example, if you have a call on Line 1 and a call on Line 2, you can combine the calls into a conference.

As the conference host, you can remove individual participants from the conference. The conference ends when all of the participants hang up.

Add Another Party to Your Call to Create a Conference

1. Start with a connected call that is not on hold.
2. Press the **Conference** button  and do one of the following:
 - Enter the phone number for the party you want to add and press the **Call** softkey.
 - Press a **Speed Dial** button.
 - Press the **Speed Dial** softkey and enter a speed dial number, then press the **Speed Dial** softkey again.

- Press the **Active Calls** softkey and select a call.
 - Select a call from the Call History.
3. Wait for the party to answer (or skip to step 4 while the call is ringing).
 4. Press the **Conference** button or the **Conference** softkey.
The conference begins.
Repeat these steps to add more parties, if desired.

Join Calls Together in a Conference

1. Start with two connected calls.
2. Make sure that one of the calls is active (not on hold). If both calls are on hold, resume one call.
3. Press the **Conference** button .
4. Press the line button for the other (held) call.
5. If the held call is on another line:
 - a. Press the **Active Calls** softkey.
 - b. Choose a call from the list.
 - c. Press the **Conference** softkey.The conference begins. (The conference is established on the line that had the active call.)

Swap Between Calls Before Completing a Conference

After calling a new conference participant, but before adding the participant to the conference, press the **Swap** softkey to toggle between the two calls. This allows you to consult privately with the party or parties on each call before combining the calls into a conference.

View Conference Participants

While in a conference, press the **Show Details** softkey to view a list of participants. You can view the details of the last 16 participants who joined the conference.

Remove Conference Participants

1. While in a conference, press the **Show Details** softkey.
2. Highlight the participant that you want to remove, then press the **Remove** softkey.

Divert

Divert allows you to send an active or ringing call to your voicemail system or to a predetermined phone number (set up by your system administrator).

Divert a Call

Divert a call in any of these ways:

- To redirect an incoming (ringing) call while on another call, use the Navigation pad  to highlight the incoming call and then press the **Divert** softkey. (Otherwise pressing the **Divert** softkey will redirect the current, active call.)

You can silence the incoming (ringing) call by pressing the **Volume** button  down once, and then let the incoming call go to the target number (voicemail or predetermined number set up by the system administrator).

- To redirect an incoming call while not on a call, press the **Divert** softkey.
- To redirect a held call, first resume the call and then press the **Divert** softkey.

Do Not Disturb

Do Not Disturb (DND) allows you to turn off either:

- The ringer on your phone.
- The ringer and any visual notification that you have an incoming call.

When DND is enabled, your incoming calls are forwarded to another number, such as your voicemail, if it is set up and the call is not saved or listed in your Call History.

The DND feature affects all the lines on a phone. However it does not affect intercom or 911 calls. Your system administrator sets up a line button on your phone for DND with the ringer and visual notifications off by default. However, you can change your DND options from your User Options web pages.

Related Topics

[User Options, page 69](#)

Turn DND On and Off



1. Press the **DND** button to turn on DND.
Visual confirmation displays briefly.
2. Press the button again to turn off DND.
Visual confirmation displays briefly.

Extension Mobility

Cisco Extension Mobility (EM) allows you to configure a Cisco Unified IP Phone as your own temporarily. After you sign in to EM, the phone adopts your user profile, including your phone lines, features, established services, and web-based settings. Your system administrator sets up EM for you.

The Cisco Extension Mobility ChangePIN feature allows you to change your PIN from your Cisco Unified IP Phone.

Enable Extension Mobility

1. Press the **Applications** button .
2. Select **Extension Mobility** (name may vary).
3. Enter your user ID and PIN (provided by your system administrator).
4. If prompted, select a device profile.
(Running applications also appear in the **Running Applications** window.)
5. To sign out, press the **Applications** button .
6. Select **Extension Mobility** (name may vary).
7. When prompted to sign out, press the **Yes** softkey.

Fast Dial

Fast Dial allows you dial a phone number from the Fast Dial service on your phone. Before you can use Fast Dial on your phone, you must set up Fast Dial on your User Options Web pages.

Related Topics

[Fast Dials, page 77](#)

Place a Call with a Fast-Dial Button



(Before you can use Fast Dial on your phone, you must set up Fast Dial on your User Options Web pages.)

1. Press the **Fast-Dial** button.
2. Sign in to Personal Directory.
3. Select **Personal Fast Dials**.
4. Select a fast-dial code and then press the **Dial** softkey.

Hold

Hold allows you to put an active call into a held state. Your phone allows one active call at a time; other calls are put on hold.

Hold and Resume a Call

1. To put a call on hold, press the **Hold** button . The Hold icon  displays and the line button pulses green.
2. To resume the highlighted call, do one of these:
 - Press the pulsing green line button.
 - Press the **Resume** softkey.
 - Press the **Select** button in the Navigation pad.

Swap Between Holding and Active Calls

You can use line buttons to swap between holding and connected calls. For example, if you have a held call and an active call, pressing the line button for the held call resumes that call and places the other call on hold automatically.

Put a Call on Hold by Answering a New Call

If you are already on a call and receive a new call, answering the new call puts the first call on hold automatically.

You can answer the new call by:

- Pressing the flashing amber line button.
- Navigating to the new call by using the Navigation pad and either pressing the **Answer** softkey or the **Select** button.

Determine if a Shared Line is on Hold

Look for a pulsing red line button and the Hold icon . When these indicators display, a call on the shared line has been put on hold remotely by the other user.

Remote Hold

With the Remote Hold feature, when you place a call on hold while using a shared line, the line button pulses green and the phone displays the Hold icon . When another phone places a call on hold, the line button pulses red and the phone displays the Remote Hold icon.

Hold Reversion

Hold Reversion notifies you when a call is left on hold.

A Hold Reversion notification is similar to a new call notification and includes these cues:

- Single ring, repeating at intervals
- Flashing amber line button
- Flashing message indicator on the handset
- Visual notification on the phone screen

Respond to a Hold Reversion Notification

Press the flashing amber line button or the **Answer** softkey to resume the call from hold.

Hunt Groups

Hunt groups are used to share the call load in organizations that receive a large number of incoming calls.

Your system administrator sets up a hunt group with a series of directory numbers. When the first directory number in the hunt group is busy, the system hunts for the next available directory number in the group, then directs the call to that phone.

If you are a member of a hunt group, you can sign in to a hunt group when you want to receive calls, and you can sign out of the group when you want to prevent calls from ringing on your phone.

Sign In and Out of a Hunt Group

1. Press the **Hunt Group** button to sign in.

Visual confirmation displays briefly.

2. Press the button again to sign out.

Signing out of a hunt group does not prevent non-hunt group calls from ringing your phone.

Intercom

Intercom allows you to place and receive one-way calls using a dedicated or dialable intercom line.

When you place an intercom call, the recipient's phone auto-answers with mute activated (*whisper mode*) and broadcasts your message through the recipient's speakerphone, or through the headset or handset, if one of these devices is active.

After receiving the intercom call, the recipient can initiate two-way audio (*connected mode*) to allow for further conversation.

Place a Dedicated Intercom Call

1. Press the **Intercom** button.

Your phone enters whisper mode until the recipient accepts the intercom call. If you are on an active call, that call is placed on hold.

2. Listen for the intercom alert tone, then begin speaking.
3. Press the **Intercom** button to end the call.

Place a Dialable Intercom Call

1. Press the **Intercom** button.
2. Enter the intercom code.

Your phone enters whisper mode until the recipient accepts the intercom call. If you are on an active call, that call is placed on hold.

3. Listen for the intercom alert tone, then begin speaking.
4. Press the **Intercom** button to end the call.

Receive an Intercom Call

1. You will receive a message on your phone screen and an audible alert, and your phone answers the intercom call with mute activated. You can handle the intercom call in one of these ways:
 - Listen to the intercom caller in *whisper* mode. (Any current call activity you are already engaged in continues simultaneously.) In whisper mode, the intercom caller cannot hear you.
 - Press the active **Intercom** button to switch to *connected* mode. In connected mode, you can speak to the intercom caller.
2. Press the **Intercom** button to end the call.





Line Status

Line Status indicators allow you to view the state of a phone line that is associated with a speed-dial button.

Your system administrator sets up Line Status indicators on your phone.

Line Status Indicators

Line Status indicators show the state of a line.

Icon	Indicator
	Line is in use.
	Line is idle.
	Line is ringing. (Only for Call Pickup.)
	Line is in a Do Not Disturb (DND) state.

Line Status indicators can be set up on speed-dial buttons by your system administrator and can be used with these features:

- Speed Dial—Allows you to monitor the status of (and dial) a specific number on a speed-dial button. (If the monitored line is unavailable, the Line Status button changes to a normal speed-dial button.)
- Directed Call Park—Allows you to monitor the line status of (and dial) a Directed Call Park number on a speed-dial button.

- **Call Pickup**—Allows you to monitor the line status of (and pick up a ringing call on) a ringing call on a speed-dial button.

Your system administrator can also set up your phone to play an audible alert when a call is ringing on the monitored line.

Related Topics

- [Call Park, page 45](#)
- [Call Pickup, page 47](#)
- [Speed Dial, page 63](#)

Malicious Call Identification

Malicious Call Identification (MCID) allows you to identify an active call as suspicious, which initiates a series of automated tracking and notification messages.

Trace a Suspicious Call

Press the **Malicious Caller ID** button to send a silent notification message to your system administrator. When the silent notification message is sent, your phone provides both a visual and audible confirmation.

Meet Me

Meet Me allows you to call a predetermined number at a scheduled time to host or join a conference. The conference begins when the host connects. Participants who call the conference before the host has joined hear a busy tone and must dial again.

The conference ends when all participants hang up; the conference does not automatically end when the host disconnects.

Host a Meet-Me Conference

1. Obtain a Meet-Me phone number from your system administrator.
2. Distribute the Meet-Me phone number to participants.
3. When you are ready to start the meeting, lift the handset to get a dial tone and then press the **Meet Me** button.
4. Dial the Meet-Me phone number.

Join a Meet-Me Conference

Dial the Meet-Me phone number (provided by the conference host).

If you hear a busy tone, the host has not yet joined the conference. In this case, try your call again.

Mobile Connect

Mobile Connect allows you to use your mobile phone to handle calls associated with your desk phone number.

When you enable Mobile Connect:

- Your desk phone and remote destinations (your mobile phones) receive calls simultaneously.
- When you answer the call on your desk phone, the remote destinations stop ringing, are disconnected, and display a missed call message.
- When you answer the call on one remote destination, the other remote destinations and desk phone stop ringing and are disconnected, and a missed call message is shown on the other remote destinations.
- When you answer the call on one remote destination and then switch the call to a Cisco Unified device that shares lines, the Cisco Unified devices that share the same line display a Remote In Use message.

To set up Mobile Connect, use the User Options web pages to set up remote destinations and create access lists to allow or block calls from specific phone numbers from being passed to the remote destinations.

Related Topics

- [Create an Access List, page 80](#)
- [Add a New Remote Destination, page 79](#)

Turn On or Off Mobile Connect to All Your Remote Destinations From Your Desk Phone

1. Press the **Mobility** button to display the current remote destination status (Enabled or Disabled).
2. Press the **Select** button to change the status.
3. Press the **Exit** softkey.

Related Topics

[Add a New Remote Destination, page 79](#)

Switch an In-Progress Call on Your Desk Phone to a Mobile Phone

1. Press the **Mobility** button.
2. Select **Send call to mobile**.
3. Answer the in-progress call on your mobile phone.

The desk phone line button turns red and handset icons and the calling party number appear on the phone display. You cannot use the same phone line for any other calls, but if your desk phone supports multiple lines, you can use another line to make or receive calls.

Switch an In-Progress Call From a Mobile Phone to Your Desk Phone

1. Select a line on your desk phone.
2. Hang up the call on your mobile phone to disconnect the mobile phone, but not the call.
3. Press the **Resume** softkey on your desk phone within five to 10 seconds and start talking on the desk phone.

Hand Off an In-Progress Call From a Mobile Phone to Your Desk Phone

1. While on your mobile phone, press the access code for the handoff feature (for example, *74). See your system administrator for a list of access codes.
2. Hang up the call on your mobile phone to disconnect the mobile phone, but not the call.
3. Press the **Answer** softkey on your desk phone within 10 seconds and start talking on the desk phone. Your system administrator sets the number of seconds to answer the call on your desk phone.

The Cisco Unified devices that share the same line display a Remote In Use message.

Mute

Mute allows you to block audio input for your handset, headset, and speakerphone, so that you can hear other parties on the call but they cannot hear you. Video Mute allows you to block video for your camera, so that you can see other parties on the video call, but they cannot see you.

Mute Your Phone

1. Press the **Mute** button  to turn Mute on.
Visual confirmation displays.
2. Press the **Mute** button again to turn Mute off.

Mute Your Video

1. Press the **Video Mute** button  to mute the camera video.
Visual confirmation displays.
2. Press the **Video Mute** button again to unmute the camera video.

On-hook Dialing

On-hook dialing allows you to enter a phone number before getting a dial tone and lift the handset to complete the call.

Dial a Number On Hook

1. Enter or speed-dial a phone number. The On-Hook Dialing screen displays.
2. Press **Call**. If you are specifying an Abbreviated Dial, enter the abbreviated number and then press **Speed Dial**.
3. Lift the handset, or press the **Speakerphone** or **Headset** button.

Plus Dialing

Plus Dialing allows you to press and hold the “*” key for at least 1 second to add a plus “+” sign as the first digit in a phone number for international dialing. It applies only for on-hook or off-hook calling.

After the + sign has been added to phone numbers, users can go into directories, such as received calls and call history, and select and dial one of these entries with the + sign without having to add digits for international calls.

Dialing an International Number

1. Press and hold the “*” key for at least 1 second. The + sign is entered as the first digit in the phone number. (The corresponding tone stops to indicate that the * has changed to a + sign.)
2. Dial the international number.

Privacy

Privacy allows you to prevent others who share your line from seeing information about your calls.

It applies to all shared lines on your phone. If you have multiple shared lines and Privacy is enabled, others cannot view any of your shared lines.

If the phone that shares your line has Privacy enabled, you can make and receive calls using the shared line as usual.

Related Topics

[Shared Lines, page 63](#)

Enable Privacy on a Shared Line

1. Press the **Privacy** button to enable the feature.
Visual confirmation displays on your phone screen for as long as the feature is enabled.
2. Press the button again to turn off the feature.

Quality Reporting Tool

Your system administrator may temporarily setup on your phone with the Quality Reporting Tool (QRT) to troubleshoot performance problems. Depending on the way the system administrator set it up, use the QRT to:

- Immediately report an audio problem on a current call.
- Select a general problem from a list of categories and choose reason codes.

Report Problems on Your Phone

1. Press the **Quality Reporting Tool** button.
2. Select the item that most closely matches your problem. (Use the Navigation pad and Select button to scroll and select.)
3. Press the **Select** softkey.
The information is sent to your system administrator.

Redial

Redial allows you to call the most recently dialed phone number by pressing a button.

Redial a Number

Press the **Redial** softkey.

To place the call on a specific phone line, get a dial tone on that line, then press the **Redial** softkey.

Secure and Nonsecure Indication Tone

When a phone is configured as secure (encrypted and trusted), it can be given a “protected” status. After that if desired, the protected phone can be configured to play an indication tone at the beginning of a call.

Only protected phones hear these secure or nonsecure indication tones. (Nonprotected phones never hear tones.) If the overall call status changes during the call, the indication tone changes accordingly. The protected phone plays the appropriate tone.

A protected phone plays a tone or not under these circumstances:

- When the option to play a tone, “Play Secure Indication Tone option,” is enabled (True):
 - When end-to-end secure media is established and the call status is secure, the phone plays the secure indication tone (three long beeps with pauses).
 - When end-to-end nonsecure media is established and the call status is nonsecure, the phone plays the nonsecure indication tone (six short beeps with brief pauses). (This capability is a change with this release.)
- When the Play Secure Indication Tone option is disabled, no tone is played.

For more information, see your system administrator.

Shared Lines

Shared lines allow you to use one phone number for multiple phones.

If you share a line with a co-worker:

- When a call comes in on the shared line:
 - Your phone rings and the line button flashes amber.
 - Your co-worker's phone rings and the line button flashes amber, and either you or your co-worker can answer the call.
- When your co-worker has a call on the shared line:
 - The shared line button on your phone appears solid red to indicate that the line is in-use remotely.
 - Also, the co-worker's call displays on your screen (unless your co-worker has Privacy enabled)
- If you put the call on hold:
 - Your line button pulses green
 - Your co-worker's line button pulses red.

When the line flashes red, your co-worker can pick up the call.
- You or the co-worker can join a call on the shared line using the Barge feature. Barge converts the call into a conference. To barge, press the red line button for the remote in-use call on the shared line.

Silent Monitoring and Recording

The Silent Monitoring and Recording feature allows you to monitor and record calls if desired. Your system administrator enables this feature, which can be set up for automatic recording of all calls or recording of calls on a per-call basis.

You may hear notification tones during call monitoring and recording. By default, the person who monitors the call and records it (if also configured) does not hear the notification tones.

For more information, see your system administrator.

Speed Dial

Speed-dial features allow you to place a call by pressing a button or entering a code. Before you can use speed-dial features on your phone, you must set up speed-dial on your User Options Web pages.

Depending on setup, your phone can support these speed-dial features:

- **Speed-Dial Buttons**—Allow you to quickly dial a phone number from one or more line buttons set up for speed dialing.

If your system administrator has set up the Line Status feature, you can monitor the status of a speed-dial line by using the line status indicators.

- **Speed-Dial Codes**—Allow you to dial a phone number from a code (sometimes referred to as abbreviated dialing).

Related Topics

- [Speed Dial on the Web, page 73](#)
- [Line Status Indicators, page 56](#)

Place a Call with a Speed-Dial Button

Before you can use speed-dial buttons on your phone, you must set up speed dial on your User Options Web pages.

To place a call, press a speed-dial button  on the left side of your phone.

Place a Call with a Speed-Dial Code

Before you can use speed-dial codes on your phone, you must set up the codes on your User Options Web pages.

Use a Speed-Dial Code On Hook

Enter the speed-dial code and press the **Speed Dial** softkey.

Use a Speed-Dial Code Off Hook

1. Lift the handset and press the **Speed Dial** softkey.
2. Enter the speed-dial code and press the **Speed Dial** softkey again to complete the call.

Transfer

Transfer allows you to redirect a connected call from your phone to another number:

- You can redirect a single call to another number that you specify.
- You can also connect two calls on one line or two different lines to each other (without remaining on the line yourself).

Before completing a transfer procedure, you can press the **Release** button or **Cancel** softkey to cancel the transfer or you can press the **Swap** softkey to toggle between calls, which allows you to speak privately with each party.

Transfer a Call to Another Number

1. Start with an active call (not on hold).
2. Press the **Transfer** button  and do one of the following to enter the transfer recipient's phone number:
 - Press the pulsing green line button of a held call (right side).
 - Enter the transfer recipient's phone number.
 - Scroll to a Call History record and press the **Call** softkey.
 - Press a speed-dial button.
 - Press the **Speed Dial** softkey, enter a speed-dial number or highlight the number you want to call, and press the **Speed Dial** softkey again.
 - Press the **Active Calls** softkey and select a held call. (The transfer completes immediately.)
3. Press the **Transfer** button or the **Transfer** softkey.
(You do not have to wait for the recipient to answer to complete the transfer.)
The transfer is complete.

Swap Between Calls Before Completing a Transfer

After you connect to the transfer recipient—but before you transfer a call to this party—you can press the **Swap** softkey to toggle between the two calls. This allows you to consult privately with the party on each call before you complete the transfer.

Web Dialer

Cisco Web Dialer allows you to make calls on your Cisco Unified IP Phone to directory contacts by selecting items in a web browser. Your system administrator sets up this feature for you.

Use Web Dialer with Cisco Directory

1. Sign in to your User Options web pages.
2. Select **User Options > Directory** and search for a co-worker.
3. Select the number that you want to dial.

4. If this is your first time using Web Dialer, review the preferences on the Make Call page.
5. Select **Dial**.
The call is now placed on your phone.
6. To end a call, select **Hang up** or hang up from your phone.

Use Web Dialer with Another Online Corporate Directory

1. Sign in to a Web Dialer-enabled corporate directory and search for co-workers.
2. Select the number that you want to dial.
3. When prompted, enter your user ID and password.
4. If this is your first time using Web Dialer, review the preferences on the Make Call page.
5. Select **Dial**.
The call is now placed on your phone.
6. To end a call, select **Hang up** or hang up from your phone.

Set Up, View, or Change Web Dialer Preferences

1. Initiate a call using Web Dialer to access the Make Call page.
The Make Call page displays the first time that you use Web Dialer (after you select the number that you want to dial).
2. Select one of the following options from the Make Call page:
 - Preferred language—Determines the language used for Web Dialer settings and prompts.
 - Use preferred device—Identifies the Cisco Unified IP Phone (Calling device) and directory number (Calling line) that you will use to place Web Dialer calls. If you have one phone with a single line, the appropriate phone and line are automatically selected. Otherwise, choose a phone and/or line. If you have more than one phone of the same type, it will be specified by device type and MAC address. (To display the MAC address on your phone, select the **Applications** button  > **Phone Information**.)
If you have an Extension Mobility profile, you can select Extension Mobility from the Calling Device drop-down menu from the Make Call page.
 - Do not display call confirmation—If selected, the Web Dialer Make Call page will not display the next time Web Dialer is used. Calls will automatically be dialed after selecting a contact from the Cisco Directory.
 - Disable Auto Close—If selected, the call window does not close automatically after fifteen seconds.

Sign Out of Web Dialer

Select the Sign Out icon  in the Make Call or Hang Up page.

User Options

User Options Web Pages

Your Cisco Unified IP Phone is a network device that can share information with other network devices in your company, including your personal computer.

You can use your computer to sign in to your Cisco Unified CM User Options web pages, where you can control features, settings, and services for your Cisco Unified IP Phone. For example, you can set up speed-dial buttons from your User Options web pages.

After you have signed in to your User Options web pages, select User Options to access the following:

- Device
- User Settings
- Directory
- Personal Address Book
- Fast Dials
- Mobility Settings
- Plugins

Related Topics

- [Contacts, page 33](#)
- [Call Forward All, page 44](#)

Sign In and Out of User Options Web Pages

Before you can access any of your user options, such as speed-dial settings or personal address book, you must sign in. When you are finished using the user options web pages, you must sign out.

In some cases, you can access your user options without having to sign in. For more information, see your system administrator.

1. Obtain the User Options URL, user ID, and default password (provided by your system administrator).
2. Open a web browser on your computer and enter the URL.
3. If prompted to accept security settings, select **Yes** or **Install Certificate**.

4. Enter your userid in the Username field.
5. Enter your password in the Password field.
6. Select **Login**.

The Cisco Unified CM User Options home page displays. From this page you can select User Options to select a device, access User Settings, Directory features, your Personal Address Book, and Fast Dials.

7. To sign out of user options, select **Logout**.

Device

You can make changes to your device settings on your phone from the User Options web pages. You can make changes to these device settings on your phone:

- Lines
- Speed-dial settings
- Phone services

Related Topics

[Speed Dial, page 63](#)

Select a Device From the User Options Web Pages

1. On your User Options web pages, select **User Options > Device**.
The Device Configuration page displays. Toolbar buttons located at the top of the Device Configuration page are specific to the selected device type.
2. If you have multiple devices assigned to you, select the appropriate device (phone model, Extension Mobility profile, or Remote Destination profile) from the Name drop-down menu.

Customize Do Not Disturb Options

1. On your User Options web page, select **User Options > Device**.
2. Set the following options:
 - Do Not Disturb—Check the check box to enable or disable DND.
 - DND Option—Select either None or Ringer Off (to turn off only the ringer).

- DND Incoming Call Alert (applies to either DND option set)—Set the alert to Beep Only, Flash Only, Disable, or select “None” (to use the “Alert” setting set up by your system administrator).

Related Topics

[Do Not Disturb, page 51](#)

Line Settings

Line settings affect a specific phone line (directory number) on your phone. Line settings can include call forwarding, visual and audio message-waiting indicators, voice-message indicators, ring patterns, and other line-specific settings.

You can set up other line settings directly on your phone:

- Set up call forwarding for your primary phone line
- Change rings, display, and other phone-model specific settings

Related Topics

- [Call Forward All, page 44](#)
- [Call History, page 23](#)

Set Up Call Forwarding Per Line

1. On your User Options web page, select **User Options > Device**.
2. Select a phone from the Name drop-down menu.
3. Select **Line Settings**.
4. If you have more than one directory number (line) assigned to your phone, select a line from the Line drop-down menu.
5. In the Incoming Call Forwarding area, select call forwarding settings for various conditions.
6. Select **Save**.

Related Topics

[Call Forward All, page 44](#)

Change the Voice Message Indicator Setting Per Line

1. On your User Options web page, select **User Options > Device**.
2. Select a phone from the Name drop-down menu.
3. Select **Line Settings**.

4. If you have more than one directory number (line) assigned to your phone, select a line from the Line drop-down menu.
5. In the Message Waiting Lamp area, choose from various settings. Typically, the default message waiting setting prompts your phone to display a steady red light from the handset light strip to indicate a new voice message.
6. Select **Save**.

Change the Audible Voice Message Indicator Setting Per Line

1. On your User Options web page, select **User Options > Device**.
2. Select a phone from the Name drop-down menu.
3. Select **Line Settings**.
4. If you have more than one directory number (line) assigned to your phone, select a line from the Line drop-down menu.
5. In the Audible Message Waiting Lamp area, choose from various settings.
6. Select **Save**.

Change the Ring Settings Per Line

1. On your User Options web page, select **User Options > Device**.
2. Select a phone from the Name drop-down menu.
3. Select **Line Settings**.
4. If you have more than one directory number (line) assigned to your phone, select a line from the Line drop-down menu.
5. In the Ring Settings area, set the option for Ring Setting (Phone Idle) and Ring Setting (Phone Active) from the drop-down menus. The options are:
 - Use System Default
 - Disable
 - Flash Only
 - Ring Once
 - Ring
 - Beep Only [this option is only available for Ring Setting (Phone Active)]
6. Select **Save**.

Change or Create a Line Text Label for Your Phone Display

1. On your User Options web page, select **User Options > Device**.
2. Select a phone from the Name drop-down menu.

3. Select **Line Settings**.
4. If you have more than one directory number (line) assigned to your phone, select a line from the Line drop-down menu.
5. In the Line Text Label area, enter a text label.
6. Select **Save**.

Speed Dial on the Web

Depending on how your phone has been set up, you can use speed-dial buttons and speed-dial codes, which you can set up on your User Options Web pages.

Set Up Speed-Dial Buttons

1. On your User Options web page, select **User Options > Device**.
2. Select a phone from the Name drop-down menu.
3. Select **Speed Dials**.
4. In the Speed Dial Settings area, enter a number and label for a speed-dial button on your phone.
5. Select **Save**.

Set Up Speed-Dial Codes

1. On your User Options web page, select **User Options > Device**.
2. Select a phone from the Name drop-down menu.
3. Select **Speed Dials**.
4. In the Abbreviated Dial Settings area, enter a number and label for a speed-dial code.
5. Select **Save**.

Phone Services

Phone services can include special phone features, network data, and web-based information (such as stock quotes and movie listings). You must first subscribe to a phone service before accessing it on your phone. You can assign a service to a speed-dial button from the User Options web page.

The services available for your phone depend on how the system administrator set up the phone system and which services you are subscribed to. For more information, see your system administrator.

If only one service is set up, the service opens by default. If more than one service is set up, select an option from the menu.

Select a service by using one of these feature buttons:

 (Feature button that your system administrator sets up)

 Messages

 Applications

 Contacts

Subscribe to a Service

1. On your User Options web page, select **User Options > Device**.
2. Select a phone from the Name drop-down menu.
3. Select **Phone Services**.
4. Select **Add New**.
5. Select a service from the drop-down list and select **Next**.
6. Change the service label and/or enter additional service information, if available (optional).
7. Select **Save**.

Search for Services

1. On your User Options web page, select a device.
2. Select **Phone Services**.
3. Select **Find**.

Change or End Services

1. On your User Options web page, search for services.
2. Select one or more entries.
3. Select **Delete Selected**.

Change a Service Name

1. On your User Options web page, search for services.
2. Select a service name.
3. Change the information and select **Save**.

Add a Service to an Available Programmable Feature Button

1. On your User Options web page, select **User Options > Device**.

2. Select a phone from the Name drop-down menu.
3. Select **Service URL**. Your system administrator sets up a service URL button for your phone.
4. Select a service from the Button Service drop-down list.
5. If you want to rename the service, edit the label fields.
6. Select **Save**.
7. Select **Reset** to reset your phone (necessary to see the new button label on your phone).

User Settings

Your PIN and password allow you to access different features and services. For example, use your PIN to sign in to Cisco Extension Mobility or Personal Directory on your phone. Use your password to sign in to your User Options web pages and Cisco Web Dialer on your personal computer. For more information, see your system administrator.

User settings include your browser password, PIN, and language (locale) settings.

Change Your Browser Password

1. On your User Options web page, select **User Options > User Settings**.
2. Enter your Current Password.
3. Enter your New Password.
4. Reenter your new password in the Confirm Password field.
5. Select **Save**.

Change Your PIN

1. On your User Options web page, select **User Options > User Settings**.
2. Enter your Current PIN.
3. Enter your New PIN.
4. Reenter your new PIN in the Confirm PIN field.
5. Select **Save**.

Change the Language for Your User Options Web Pages

1. On your User Options web page, select **User Options > User Settings**.
2. In the User Locale area, select an item from the Locale drop-down list.

3. Select **Save**.

Change the Language for Your Phone Display

1. On your User Options web page, select **User Options > Device**.
2. Select an item from the User Locale drop-down list.
3. Select **Save**.

Directory

To get a list of co-workers in your corporate directory, select **User Options > Directory**.

The Directory features that you can access on your computer consist of:

- Personal Address Book (PAB), which can also be accessed from your phone
- Fast Dials, which can also be accessed from your phone
- Cisco Unified Communications Manager Address Book Synchronizer

Related Topics

- [Personal Directory, page 34](#)
- [Corporate Directory, page 33](#)

Personal Address Book

You can add, delete, or update personal address book entries from the User Options web page.

Add a New PAB Entry

1. On your User Options web page, select **User Options > Personal Address Book**.
2. Select **Add New**.
3. Enter information for the entry.
4. Select **Save**.

Search for a PAB Entry

1. On your User Options web page, select **User Options > Personal Address Book**.
2. Specify search information and select **Find**.

Edit a Personal Directory Entry

1. Sign in to **Personal Directory** and search for an entry. (Use the Navigation bar and button to scroll and select.)
2. Press the **Edit** softkey to modify the name or email address.
3. Modify the name or email address.
4. Press the **Phones** softkey to modify a phone number.
5. Press the **Update** softkey.

Delete a Personal Directory Entry

1. Sign in to **Personal Directory** and search for an entry. (Use the Navigation bar and button to scroll and select.)
2. Press the **Edit** softkey.
3. Press the **Delete** softkey. (You may need to select the **more** softkey first.)
4. Press the **OK** softkey to confirm the deletion.

Assign a Feature Button for Personal Address Book

1. On your User Options web page, select **User Options > Device**.
2. Select a phone from the Name drop-down menu.
3. Select **Service URL**.

Your system administrator sets up your phone to display services. For more information, see your system administrator.

4. Select the Personal Address Book service from the Button drop-down list box.
5. Enter a phone label for the button.
6. Select **Save**.
7. Select **Reset** and then select **Restart** to refresh the phone configuration.

You can now press the button to access PAB codes.

Fast Dials

You can add, delete, or update fast dial entries from the User Options web page.

You can create up to 500 Fast Dial and PAB entries. You can create a new Fast Dial entry without using a PAB entry. Such Fast Dial entries are labeled “raw” in the User Options web pages and do not display a configurable text label.

Assign a Feature Button for Fast Dial

1. On your User Options web page, select **User Options > Device**.
2. Select **Service URL** (provided by your system administrator).
3. Select the Fast Dial service from the Button drop-down list box.
4. Enter a phone label for the button.
5. Select **Save**.
6. Select **Reset** and then select **Restart** to refresh the phone configuration.

Assign a Fast Dial Code to a PAB Entry

1. On your User Options web page, select **User Options > Fast Dials**.
2. Select **Add New**.
3. Use the Search Options area to find the appropriate PAB entry.
4. Select a phone number in the Search Results area.
5. Change the Fast Dial code, if desired.
6. Select **Save**.

Assign a Fast Dial Code to a Phone Number Without Using a PAB Entry

1. On your User Options web page, select **User Options > Fast Dials**.
2. Select **Add New**.
3. Change the Fast Dial code, if desired.
4. Enter a phone number.
5. Select **Save**.

Search for a Fast Dial Entry

1. On your User Options web page, select **User Options > Fast Dials**.
2. Specify search information and select **Find**.

Edit a Fast Dial Phone Number

1. On your User Options web page, select **User Options > Fast Dials**.

2. Search for the Fast Dial entry that you want to edit.
3. Select a component of the entry.
4. Change the phone number.
5. Select Save.

Delete a PAB Entry

1. On your User Options web page, search for a Fast dial entry.
2. Select one or more entries.
3. Select **Delete Selected**.

Mobility Settings

When using Cisco Mobile Connect, you must add your mobile and other phones that you want to use to make and receive calls using the same directory numbers as your desk phone. These phones are called *remote destinations*. You can also define access lists to restrict or allow calls from certain numbers to be sent to your mobile phone.

Related Topics

[Mobile Connect, page 58](#)

Add a New Remote Destination

1. On your User Options web page, select **User Options > Mobility Settings > Remote Destinations**.
2. Select **Add New**.
3. Enter the following information:
 - Name—Enter a name for the mobile (or other) phone.
 - Destination Number—Enter your mobile phone number.
4. Select your remote destination profile from the drop-down list box. Your remote destination profile contains the settings that apply to remote destinations that you create.
5. Select the Mobile Phone check box to allow your remote destination to accept a call sent from your desk phone.
6. Select the Enable Mobile Connect check box to allow your remote destination to ring simultaneously with your desk phone.
7. Select one of the following options in the Ring Schedule area (the ring schedule drop-down list boxes include only the access lists that you have created):
 - All the time—Select this option if you do not want to impose day and time restrictions on ringing the remote destination.

- As specified below—Select this option and select from the following items to set up a ring schedule based on day and time:
 - a. Select a check box for each day of the week you want to allow calls to ring the remote destination.
 - b. For each day, select All Day or select the beginning and ending times from the drop-down lists.
 - c. Select the time zone from the drop-down list box.
- 8. Select one of these ringing options:
 - Always ring this destination.
 - Ring this destination only if the caller is in the allowed access list that you select.
 - Do not ring this destination if the caller is in the blocked access list that you select.
- 9. Select **Save**.

Create an Access List

1. On your User Options web page, select **User Options > Mobility Settings > Access Lists**.
2. Select **Add New**.
3. Enter a name to identify the access list and a description (optional).
4. Select whether the access list will allow or block specified calls.
5. Select **Save**.
6. Select **Add Member** to add phone numbers or filters to the list.
7. Select an option from the Filter Mask drop-down list box. You can filter a directory number, calls with restricted caller ID (Not Available), or calls with anonymous caller ID (Private).
8. If you select a directory number from the Filter Mask drop-down list box, enter a phone number or filter in the DN Mask field. You can use the following wild cards to define a filter:
 - X (upper or lower case)—Matches a single digit. For example, 408555123X matches any number between 4085551230 and 4085551239.
 - !—Matches any number of digits. For example, 408! matches any number starts with 408.
 - #—Used as a single digit for exact match.
9. To add this member to the access list, select **Save**.
10. To save the access list, select **Save**.

Plugins

Plugins on your User Options web pages allow you to download and access applications that your system administrator sets up for you.

For more information, see your system administrator.

Access Plugins

On your User Options web page, select **User Options > Plugins**. You can view plugins only if your system administrator has set them up for you.

FAQs and Troubleshooting

Frequently Asked Questions

Q. How do I redirect an incoming call when I am on a call?

A. To redirect an incoming (ringing) call while on another call, use the Navigation pad to highlight the incoming call, and then press the **Divert** softkey. (Otherwise pressing the **Divert** softkey will redirect the current, active call.)

Q. If I'm on a call, how can I silence the ringing of an incoming call?

A. You can silence the incoming (ringing) call by pressing the **Volume** button down once, and then let the incoming call go to the target number (voicemail or predetermined number set up the system administrator).

Q. How can I resume a call that is on hold?

A. To resume a call on hold, you can use any of the following methods:

- Press the pulsing green line button.
- Press the **Resume** softkey.
- Highlight the call by using the Navigation pad and press the **Select** softkey. Note that pressing the **Hold** button again does not resume the call.

Q. Why do the softkeys keep changing?

A. Softkeys act on the selected (highlighted) call or menu item only. Which softkeys are displayed depends on the call or item you have selected.

Q. What is the best way to look at calls when I have a shared line or multiple lines?

A. If you have a shared line or multiple lines, it is recommended that you use the All Calls feature to view calls. When you press the All Calls button (on the left), all calls for all your lines are listed on the phone screen in chronological order (oldest first). (If you do not have an All Calls button, ask your system administrator to set up this feature.)

Q. Why does my call disappear after I accidentally press a button?

A. If you are on a call and press a button for another line, your line view will change. Your current call disappears from view and calls for the newly selected line are displayed. To redisplay the call you are on, select the line it is on or press All Calls.

Q. How do I check missed calls on my phone?

A. To check missed calls on your phone you must:

1. Press the **Applications** button .

2. Select **Call History**. (Use the Navigation pad and Select button to scroll and select.)
3. Press the **Missed** softkey.

Q. How do I exit from a running application?

A. To exit from a running applications you must:

1. Press the **Applications** button .
2. Select **Running Applications**. (Use the Navigation pad and Select button to scroll and select.)
3. Select a running application and press the **Close App** softkey to close the application.
When prompted, save your changes.
4. Press the **Exit** softkey end the running application.

If you do not exit a running application, it will persist in the background.

Q. How do I connect two calls and then drop from the line myself?

A. When you are on an active call (not on hold), do the following:

1. Press the **Transfer** button  and enter the transfer recipient's phone number in one of these ways:
 - Press the line button of a held call.
 - Enter the transfer recipient's phone number.
 - Scroll to a Call History record and press the **Call** softkey.
 - Press a speed-dial button.
 - Press the **Speed Dial** softkey, enter a speed-dial number or highlight the number you want to call, and press the **Speed Dial** softkey again.
 - Press the **Active Calls** softkey and select a held call. (The transfer completes immediately.)
2. Press the **Transfer** button again. (You do not have to wait for the recipient to answer to complete the transfer.)

Q. What does the Swap softkey do?

A. The **Swap** softkey allows you to toggle between two calls before completing the transfer or creating a conference. This allows you to consult privately with the party or parties on each call before combining the calls into a conference.

Q. Can I cancel a conference or transfer procedure after I have started it?

A. Yes, before completing a conference or transfer, you can press the **Release** button  or **Cancel** softkey to cancel it.

Q. How can I combine two calls on hold into a single conference call?

A. Make sure that one of the calls is active (not on hold). If both calls are on hold, resume one call, then:

1. Press the **Conference** button .
2. Press the line button for the other (held) call.

The conference begins. (The conference is established on the line that had the active call.)

Q. Not all calls present video on my phone. Why not?

A. To see an image of the other party on your phone screen, the other party's phone must support video and the other party must have a camera installed and enabled on his or her phone. During conference calls, the conference system in use during the call must support video conferencing.

Q. What happens to video when I put a call on hold?

A. Video transmission is muted (blocked) until you resume the call.

Q. What does the different light colors on my Cisco Unified Video Camera indicate?

A. The colors indicate video transmission states as follows:

- Green—Your video is transmitting.
- Red—Your video is muted.

Troubleshooting Tips

Problem: Hold button does not resume a held call.

When I press the Hold button  to resume a call, nothing happens

Possible Cause

This is as designed. The Hold button is not a toggle.

Solution

Use any of the following methods:

- Press the pulsing green line button.
- Press the **Resume** softkey.

Highlight the call by using the Navigation pad and press the **Select** softkey.

Problem: Missing the All Calls button.

I would like to use the All Calls button but it is not on my phone.

Possible Cause

It has not been set up by your system administrator.

Solution

Ask your system administrator to enable the All Calls feature for you.

Personal Directory

Problem: Cannot sign in to Personal Directory

You are unable to sign in to your personal directory.

Possible Cause

Your PIN needs to be reset.

You are using your password to sign in, not your personal identification number (PIN).

Solution

See your system administrator.

Use your PIN, not your password.

User Options

Problem: Cannot access User Options web pages

You are unable to access your user options web pages.

Possible Cause

Your password needs to be reset.

Solution

See your system administrator.

Product Safety, Security, Accessibility, and Related Information

Safety and Performance Information

Power outages and other devices can affect your Cisco Unified IP Phone.

Power Outage

Your accessibility to emergency service through the phone is dependent on the phone being powered. If there is an interruption in the power supply, Service and Emergency Calling Service dialing will not function until power is restored. In the case of a power failure or disruption, you may need to reset or reconfigure equipment before using the Service or Emergency Calling Service dialing.

External Devices

Cisco recommends using good quality external devices (such as headsets) that are shielded against unwanted radio frequency (RF) and audio frequency (AF) signals.

Depending on the quality of these devices and their proximity to other devices such as mobile phones or two-way radios, some audio noise may still occur. In these cases, Cisco recommends that you take one or more of these actions:

- Move the external device away from the source of the RF or AF signals.
- Route the external device cables away from the source of the RF or AF signals.
- Use shielded cables for the external device, or use cables with a better shield and connector.
- Shorten the length of the external device cable.
- Apply ferrites or other such devices on the cables for the external device.

Cisco cannot guarantee the performance of the system because Cisco has no control over the quality of external devices, cables, and connectors. The system will perform adequately when suitable devices are attached using good quality cables and connectors.



Caution

In European Union countries, use only external speakers, microphones, and headsets that are fully compliant with the EMC Directive [89/336/EC].

Bluetooth Wireless Headset Performance

The Cisco Unified IP Phone 8945 supports Bluetooth Class 2 technology when the headsets support Bluetooth. Bluetooth enables low-bandwidth wireless connections within a range of 30 feet (10 meters). The best performance is in the 3- to 6-foot (1- to 2-meter) range. You can connect up to five headsets, but only the last one connected is used as the default.

Because there can be potential interference issues, it is recommended that you move 802.11b/g devices, Bluetooth devices, microwave ovens, and large metal objects away from the wireless headset.

For a Bluetooth wireless headset to work, it does not need to be within direct line-of-sight of the phone, but some barriers, such as walls or doors, and interference from other electronic devices, can affect the connection.

FCC Compliance Statements

The Federal Communications Commission requires compliance statements for the following:

- FCC Part 15.21
- FCC RF Radiation Exposure
- FCC Receivers and Class B Digital

FCC Part 15.21 Statement

Changes or modifications not expressly approved by the party responsible for compliance could void the user's authority to operate the equipment.

FCC RF Radiation Exposure Statement

This equipment complies with FCC radiation exposure limits set forth for an uncontrolled environment. End users must follow the specific operating instructions for satisfying RF exposure compliance. This transmitter must be at least 20 cm from the user and must not be co-located or operating in conjunction with any other antenna or transmitter.

FCC Receivers and Class B Digital Statement

This product has been tested and complies with the specifications for a Class B digital device, pursuant to Part 15 of the FCC Rules. These limits are designed to provide reasonable protection against harmful interference in a residential installation. This equipment generates, uses, and can radiate radio frequency energy and, if not installed and used according to the instructions, may cause harmful interference to radio communications. However, there is no guarantee that interference will not occur in a particular installation.

If this equipment does cause harmful interference to radio or television reception, which is found by turning the equipment off and on, the user is encouraged to try to correct the interference by one or more of the following measures:

- Reorient or relocate the receiving antenna
- Increase the separation between the equipment or devices
- Connect the equipment to an outlet other than the receiver's
- Consult a dealer or an experienced radio/TV technician for assistance

Cisco Product Security

This product contains cryptographic features and is subject to United States and local country laws governing import, export, transfer and use. Delivery of Cisco cryptographic products does not imply third-party authority to import, export, distribute or use encryption. Importers, exporters, distributors and users are responsible for compliance with U.S. and local country laws. By using this product you agree to comply with applicable laws and regulations. If you are unable to comply with U.S. and local laws, return this product immediately.

Further information regarding U.S. export regulations may be found at:

http://www.access.gpo.gov/bis/ear/ear_data.html.

Accessibility Features

The Cisco Unified IP Phones 8941 and 8945 provide accessibility features for the vision impaired, the blind, and the hearing and mobility impaired.

For detailed information about the accessibility features on these phones, see *[Accessibility Features for the Cisco Unified IP Phone 8941 and 8945](#)*.

You can also find more information about accessibility at this Cisco website:

<http://www.cisco.com/web/about/responsibility/accessibility/index.html>

Additional Information

- You can access the Cisco website at this URL:
<http://www.cisco.com/>
- Cisco Unified IP Phone 8941 and 8945 quick start guides and end-user guides:
http://www.cisco.com/en/US/products/ps10451/products_user_guide_list.html
- Licensing information:
http://www.cisco.com/en/US/products/ps10451/products_licensing_information_listing.html
- Cisco international websites:
Allows access to international Cisco websites from www.cisco.com by clicking the **Worldwide** [change] link at the top of the web page.

Warranty

Cisco One-Year Limited Hardware Warranty Terms

There are special terms applicable to your hardware warranty and various services that you can use during the warranty period.

Your formal Warranty Statement, including the warranties and license agreements applicable to Cisco software, is available on Cisco.com at the following URL:

http://www.cisco.com/en/US/docs/general/warranty/English/1Y1DEN__.html

Index

A

- access
 - plugins [81](#)
- access list, create [80](#)
- accessibility features [89](#)
- accessories [28](#)
- adapters [1, 11](#)
- add
 - PAB entry [76](#)
 - phone services to button [74](#)
 - remote destination for Mobile Connect [79](#)
- administrator settings [30](#)
- Agent Greeting [42](#)
- alerts
 - audible
 - call waiting [49](#)
 - Hold Reversion [54](#)
 - MCID [57](#)
 - silent [57](#)
 - visual
 - call waiting [49](#)
 - Hold Reversion [54](#)
 - MCID [57](#)
- answer oldest first [42](#)
- assign
 - fast-dial button [78](#)
 - fast-dial code [78](#)

audible message indicator. *See* message indicators

- Auto Answer
 - description [43](#)

B

- Barge [43](#)
- BLF. *See* Line Status
- Bluetooth [13](#)
 - accessory
 - add [29](#)
 - connect [30](#)
 - delete [30](#)
 - disconnect [30](#)
 - settings [27](#)
- brightness
 - phone [26](#)
- browser password, change [75](#)
- Busy Lamp Features. *See* Line Status
- buttons
 - and softkeys, per feature [41](#)
 - Cisco Unified IP Phone 8941
 - Lens Cover [5](#)
 - Phone Screen [4](#)
 - Cisco Unified IP Phone 8945
 - Lens Cover [16](#)
 - color LEDs [6, 17](#)

model-specific overview [4, 15](#)

C

Call Back [43](#)

set up notification [44](#)

Call Forward All [44](#)

call history [23](#)

Call Park [45](#)

Call Pickup

description [47](#)

Call Waiting, description [49](#)

calling features

Agent Greeting [42](#)

Answer [42](#)

Auto Answer [43](#)

Barge [43](#)

Call Back [43](#)

Call Forward All [44](#)

Call Park [45](#)

Call Pickup [47](#)

Call Waiting [49](#)

conference [49](#)

Divert [51](#)

DND

Fast Dial [52](#)

Hold [53](#)

Hold Reversion [54](#)

Hunt Group [54](#)

Intercom [55](#)

Line Status [56](#)

MCID [57](#)

Meet Me [57](#)

Mobile Connect [58](#)

Mute [59](#)

On-hook Dialing [60](#)

Plus Dialing [60](#)

Privacy [61](#)

QRT [61](#)

Redial [62](#)

Remote Hold [64](#)

Secure and Nonsecure Indication Tone [62](#)

Shared Lines [63](#)

Silent Monitoring and Recording [63](#)

Speed Dial [63](#)

Transfer [64](#)

Web Dialer [65](#)

Camera

settings [27](#)

change

browser password [75](#)

language

phone display [76](#)

user options web pages [75](#)

locale

phone display [76](#)

user options web pages [75](#)

phone line label [72](#)

phone service name [74](#)

phone services [74](#)

PIN [75](#)

Cisco Mobile Connect. *See* Mobile Connect

Cisco product security [89](#)

Cisco Unified IP Phone 8941 [1](#)

Cisco Unified IP Phone 8945 [11](#)

compliance [88](#)

conference
 Meet Me [57](#)
 swap between calls [50](#)
 using [49](#)
confirmation. *See* alerts
contacts
 corporate directory [33](#)
 personal directory [34](#)
 delete a contact [77](#)
 edit a contact [77](#)
contrast. *See* brightness
create
 access list for Mobile Connect [80](#)
 phone line label [72](#)

D

delete
 fast-dial PAB entry [79](#)
 personal directory contact [77](#)
dial, on hook [60](#)
directory
 corporate
 using [33](#)
 with Web Dialer [66](#)
 personal [34](#)
 delete a contact [77](#)
 edit a contact [77](#)
Divert, description [51](#)
DND
 customize [70](#)
 turn on and off [52](#)
Do Not Disturb. *See* DND

E

edit
 fast dials [78](#)
 personal directory contact [77](#)
enable
 Privacy [61](#)
end
 phone services [74](#)
external devices
 caution [87](#)
 information [87](#)

F

FAQs [83](#)
fast dials [77](#)
 assign a code [78](#)
 assign to a feature button [78](#)
 delete PAB entry [79](#)
 description [52](#)
 edit [78](#)
 place a call
 with a fast-dial button [53](#)
 search [78](#)
feature buttons. *See* buttons
footstand [3](#)
frequently asked questions [83](#)

G

Group Pickup, description [47](#)

H

handset rest [10, 21](#)

hardware, model-specific overview [4, 15](#)

Hold

and Resume [53](#)

on shared lines [54](#)

remote [54](#)

swap between calls [53](#)

to answer a new call [53](#)

Hold Reversion

description [54](#)

notification [54](#)

responding to notification [54](#)

Hunt Group

description [54](#)

sign in and out [54](#)

I

iDivert. *See* Divert

Intercom [55](#)

L

language

change for user options web pages [75](#)

change phone display [76](#)

Web Dialer settings [66](#)

lens cover

button

Cisco Unified IP Phone 8941 [5](#)

Cisco Unified IP Phone 8945 [16](#)

line

settings

DND [70](#)

voice message indicator [71, 72](#)

text label

change [72](#)

create [72](#)

Line Status

description [56](#)

indicators [56](#)

locale

change for user options web pages [75](#)

change phone display [76](#)

log in and out. *See* sign in and out

M

MAC address

Web Dialer [66](#)

Malicious Caller ID. *See* MCID

MCID

description [57](#)

trace a call [57](#)

Meet Me

conference

join [58](#)

description [57](#)

message indicators

audible, change [72](#)

voice, change [71](#)

messages [39](#)

Mobile Connect

add remote destination [79](#)

create access list [80](#)

- description [58](#)
- switch
 - from Desk to Mobile Phone [59](#)
 - from Mobile Phone to Desk [59](#)
- turn on and off [58](#)
- model [31](#)
- monitor and record [63](#)
- mute
 - description [59](#)
 - turn on and off [60](#)

N

- Navigation pad [5, 16](#)
- notification
 - Call Back [44](#)
 - Hold reversion [54](#)

O

- On-hook Dialing
 - description [60](#)
- Other Pickup, description [47](#)

P

- PAB
 - add [76](#)
 - search [76](#)
- password
 - troubleshooting with User Options [86](#)
- password. *See* browser password
- personal address book. *See* PAB

- personal directory [34](#)
 - delete a contact [77](#)
 - edit a contact [77](#)
- personal identification number. *See* PIN
- phone display
 - change language [76](#)
 - change line label [72](#)
 - create line label [72](#)
- phone model [31](#)
- phone screen
 - button
 - Cisco Unified IP Phone 8941 [4](#)
 - features [7, 18](#)
- phone services [73](#)
 - add to button [74](#)
 - change [74](#)
 - change name [74](#)
 - end [74](#)
 - search for [74](#)
 - subscribe to [74](#)
- phone, connecting [1, 11](#)
- PIN
 - adding Bluetooth device with [29](#)
 - troubleshooting with Personal Directory [86](#)
 - using with Personal Directory [35](#)
- PIN, change [75](#)
- plugins [81](#)
- Plus Dialing [60](#)
- ports [1, 11](#)
- power outage [87](#)
- power-save mode [10, 21](#)
- preferences
 - settings [26](#)

Web Dialer [66](#)

Privacy

enable on a shared line [61](#)

programmable feature buttons [6, 17](#)

Q

QRT [61](#)

quality reporting tool. *See* QRT

R

record and monitor [63](#)

Redial

a number [62](#)

description [62](#)

remote destination. *See* user options

Remote Hold [54](#)

revert, call

on hold [54](#)

ringtones [26](#)

S

safety and performance

external devices [87](#)

power outage [87](#)

search

fast dials [78](#)

PAB [76](#)

phone services [74](#)

Secure and Nonsecure Indication Tone [62](#)

security [89](#)

services. *See* phone services

set up

speed-dial buttons [73](#)

speed-dial codes [73](#)

Web Dialer preferences [66](#)

settings [26](#)

settings, user options [75](#)

shared lines

barge [43](#)

description [63](#)

enable Privacy [61](#)

on hold [54](#)

sign in and out

Hunt Group [54](#)

user options [69](#)

Web Dialer [65, 67](#)

Silent Monitoring and Recording [63](#)

softkey buttons [5, 16](#)

softkeys and feature buttons, per feature [41](#)

Speed Dial

buttons [73](#)

description [63](#)

set up [73](#)

codes

description [63](#)

set up [73](#)

subscribe to phone services [74](#)

suspicious call, trace [57](#)

swap

conference calls [50](#)

transfer calls [65](#)

T

To Voicemail. *See* Divert

trace a suspicious call [57](#)

Transfer

description [64](#)

swap [65](#)

using [65](#)

Troubleshooting [83](#)

turn on and off

DND [52](#)

Mobile Connect [58](#)

mute [60](#)

U

user options

device

phone services [73](#)

speed dial [73](#)

fast dials [77](#)

assign a code [78](#)

assign to a feature button [78](#)

delete PAB entry [79](#)

edit [78](#)

search [78](#)

mobility [79](#)

add remote destination [79](#)

create access list [80](#)

PAB [76](#)

add entry [76](#)

search for entry [76](#)

plugins [81](#)

sign in and out [69](#)

user settings [75](#)

change browser password [75](#)

change phone display language [76](#)

change PIN [75](#)

change user options web pages language [75](#)

user settings. *See* user options

V

video camera [5, 16](#)

view

Web Dialer preferences [66](#)

voice messages

checking [39](#)

voicemail [39](#)

W

warranty information [111](#)

Web Dialer

change preferences [66](#)

description [65](#)

MAC address [66](#)

set up preferences [66](#)

sign in [65](#)

sign out [67](#)

view preferences [66](#)

with Cisco Directory [65](#)

with corporate directory [66](#)



Americas Headquarters
Cisco Systems, Inc.
San Jose, CA

Asia Pacific Headquarters
Cisco Systems (USA) Pte. Ltd.
Singapore

Europe Headquarters
Cisco Systems International BV
Amsterdam, The Netherlands

Cisco has more than 200 offices worldwide. Addresses, phone numbers, and fax numbers are listed on the
Cisco Website at www.cisco.com/go/offices.

Cisco and the Cisco Logo are trademarks of Cisco Systems, Inc. and/or its affiliates in the U.S. and other countries. A listing of Cisco's trademarks can be found at www.cisco.com/go/trademarks. Third party trademarks mentioned are the property of their respective owners. The use of the word partner does not imply a partnership relationship between Cisco and any other company. (1005R)

© 2011 Cisco Systems, Inc. All rights reserved.



The Bluetooth word mark and logo are registered trademarks owned by Bluetooth SIG, Inc., and any use of such marks by Cisco Systems, Inc., is under license.

Free Manuals Download Website

<http://myh66.com>

<http://usermanuals.us>

<http://www.somanuals.com>

<http://www.4manuals.cc>

<http://www.manual-lib.com>

<http://www.404manual.com>

<http://www.luxmanual.com>

<http://aubethermostatmanual.com>

Golf course search by state

<http://golfingnear.com>

Email search by domain

<http://emailbydomain.com>

Auto manuals search

<http://auto.somanuals.com>

TV manuals search

<http://tv.somanuals.com>