

DB456MC

CD/MP3/WMA Receiver & Music Catcher

CD/MP3/WMA 接收机和音乐捕捉器

CD/MP3/WMA 수광부 및 뮤직 캐처

Thank you for purchasing this **Clarion** product.

- * Please read this owner's manual in its entirety before operating this equipment.
- * After reading this manual, be sure to keep it in a handy place (e.g., glove compartment).
- * Check the contents of the enclosed warranty card and keep it carefully with this manual.

Contents

| | |
|--|----|
| 1. FEATURES | 2 |
| 2. CONTROLS | 3 |
| 3. NOMENCLATURE | 4 |
| Names of the Buttons and their Functions | 4 |
| Display Items | 5 |
| LCD Screen | 5 |
| 4. PRECAUTIONS | 6 |
| Handling Compact Discs | 7 |
| 5. REMOTE CONTROL | 8 |
| Inserting the Battery | 8 |
| Functions of Remote Control Unit Buttons | 9 |
| 6. DCP | 10 |
| 7. OPERATIONS | 11 |
| Basic Operations | 11 |
| Radio Operations | 12 |
| CD/MP3/WMA Operations | 14 |
| MUSIC CATCHER Operations | 18 |
| Operations Common to Each Mode | 20 |
| 8. IN CASE OF DIFFICULTY | 22 |
| 9. ERROR DISPLAYS | 23 |
| 10. SPECIFICATIONS | 24 |

1. FEATURES

- "MUSIC CATCHER" for Recording CDDA
- MP3 and WMA File Playable with ID3-TAG and WMA-TAG Display
- Z-ENHANCER for Sound Creation
- MAGNA BASS EX for Dynamic Bass Tuning, Volume Level Dependent

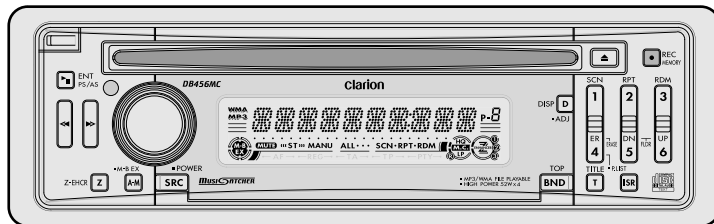

Be sure to unfold and read the next page. / 请务必展开并阅读下一页。
 반드시 다음 페이지를 펴서 읽으십시오.

2.CONTROLS / 控制键 / 컨트롤

Source unit / 主机 / 헤드유닛

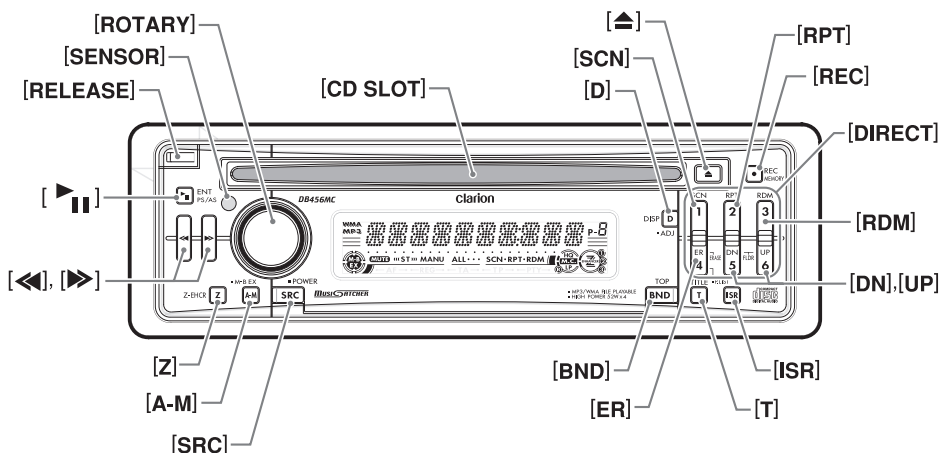

Note: Be sure to unfold this page and refer to the front diagrams as you read each chapter.

注意：阅读各章时请务必展开此页并阅读前面的图。

주: 이 페이지를 펼치고 각 장을 읽을 때 전면 그림을 참조하십시오.

3. NOMENCLATURE

Note:

- Be sure to read this chapter referring to the front diagrams of chapter "2. CONTROLS" on page 3 (unfold).
- MC is the abbreviation of MUSIC CATCHER.

Names of the Buttons and their Functions

[RELEASE] button

- Deeply push in the button to unlock the DCP.

[SENSOR]

- Receiver for remote control unit
- Operating range: 30° in all directions

[ROTARY] knob

- Adjust the volume by turning the knob clockwise or counterclockwise.
- Use the knob to perform various settings.

[CD SLOT]

- CD insertion slot.

[D] button

- Switch the display indication (Main display, Title display, Clock display).
- Press and hold the button for 1 second or longer to enter the display adjust mode.

[SCN] button

- Perform scan play for 10 seconds of each track while in the CD/MP3, MC mode.
- Press and hold the button for 1 second or longer to perform folder scan play while in the MP3/WMA disc, MC mode.

[▲] button

- Press to eject a CD loaded in the unit.

[RPT] button

- Repeat play while in the CD/MP3, MC mode.
- Press and hold the button for 1 second or longer to perform folder repeat play while in the MP3/WMA disc, MC mode.

[REC] button

- Press the button during CD playback, and the track currently being played back is recorded onto MC. (TRACK REC)
- Press and hold the button for 2 seconds or longer during CD playback, and all tracks are recorded onto MC. (DISC REC)

[DIRECT] buttons

- Store a station into memory or recall it directly while in the radio mode.

[RDM] button

- Perform random play while in the CD/MP3, MC mode.

- Press and hold the button for 1 second or longer to perform folder random play while in the MP3/WMA disc, MC mode.

[UP], [DN] buttons

- Select the Folder. (MP3/WMA disc MC mode only)

[ISR] button

- Recall ISR radio station in memory.
- Press and hold for 2 seconds or longer: Store current station into ISR memory (radio mode only).

[T] button

- Use the button to input a title in the Radio, CD or MC mode.
- Use the button to switch the user titles or track titles.
- Use the button to scroll the title during the CD-text play.

[ER] button

- Press and hold for 1 second or longer to turn on or off the play list mode. (MP3/WMA disc only)
- This functions as the [ER] button in the MC mode. Each time you press the button, the function switches in the following order: TRK ERASE → FLD ERASE → Normal mode.
- Press and hold the button for 2 seconds or longer, and the unit enters the ALL ERASE mode.

[BND] button

- Switch the band, or seek tuning or manual tuning while in the radio mode.
- Play a first track while in the CD/MP3, MC mode.
- Press the button to change the character.

[SRC] button

- Press the button to turn on the power.
- Press and hold the button for 1 second or longer to turn off the power.
- Switches the operation mode among the Radio mode, etc.

[A-M] button

- Use the button to switch to the audio mode (bass/treble, balance/fader)
- Press and hold for 1 second or longer to turn on or off the MAGNA BASS EXTENDED.

[Z] button

- Use the button to select one of the three types of sound characteristics already stored in memory. (Z-Enhancer)

Names of the Buttons and their Functions

[◀, ▶] buttons

- Select a station while in the radio mode or select a track when listening to a CD/MP3, MC mode. These buttons are used to make various settings.
- Press and hold the button for 1 second or longer to switch the fast-forward/fast-backward.

[⏮, ⏭] button

- Play or pause a CD while in the CD/MP3, MC mode.
- Press and hold the [⏮] button for 2 seconds or longer after selecting the ERASE mode, and the track is erased.
- Perform preset scan while in the radio mode. When the button is pressed and held, auto store is performed.

Display Items

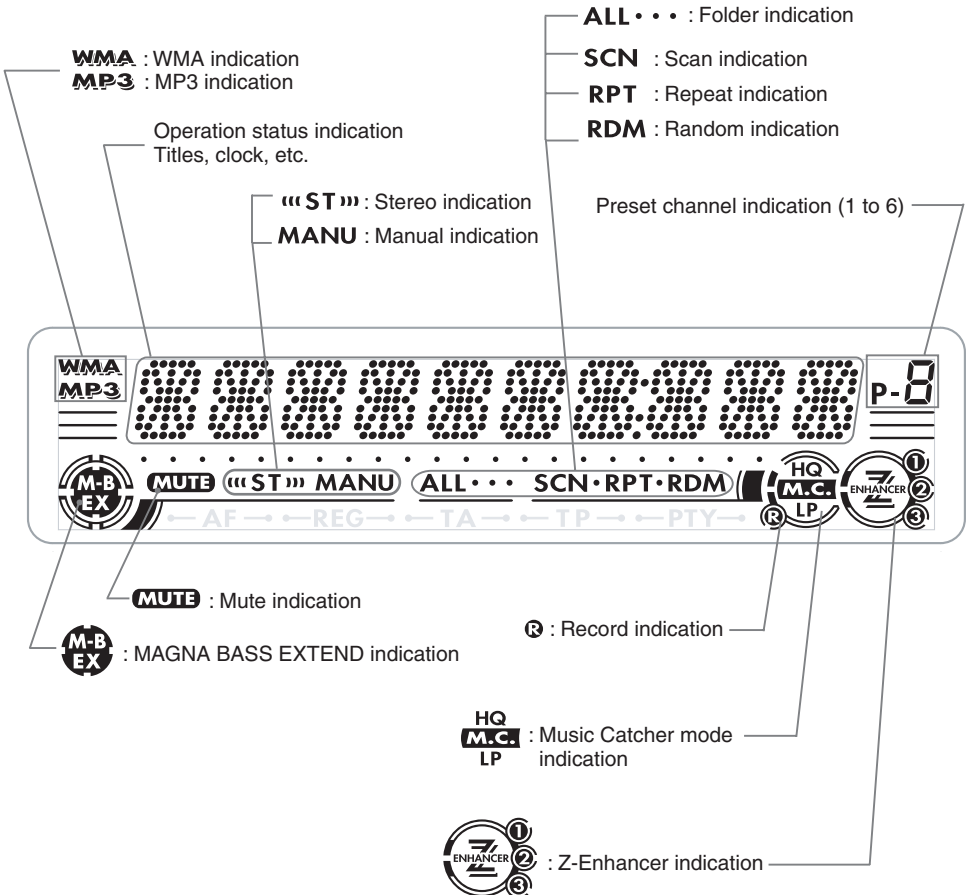

LCD Screen

In extreme cold, the screen movement may slow down and the screen may darken, but this is normal. The screen will recover when it returns to normal temperature.

4. PRECAUTIONS

1. When the inside of the car is very cold and the player is used soon after switching on the heater moisture may form on the disc or the optical parts of the player and proper playback may not be possible. If moisture forms on the disc, wipe it off with a soft cloth. If moisture forms on the optical parts of the player, do not use the player for about one hour. The condensation will disappear naturally allowing normal operation.
2. Driving on extremely bumpy roads which cause severe vibration may cause the sound to skip.
3. This unit uses a precision mechanism. Even in the event that trouble arises, never open the case, disassemble the unit, or lubricate the rotating parts.

⚠ CAUTION

USE OF CONTROLS, ADJUSTMENTS, OR PERFORMANCE OF PROCEDURES OTHER THAN THOSE SPECIFIED HEREIN, MAY RESULT IN HAZARDOUS RADIATION EXPOSURE.

THE COMPACT DISC PLAYER SHOULD NOT BE ADJUSTED OR REPAIRED BY ANYONE EXCEPT PROPERLY QUALIFIED SERVICE PERSONNEL.

CHANGES OR MODIFICATIONS NOT EXPRESSLY APPROVED BY THE MANUFACTURER FOR COMPLIANCE COULD VOID THE USER'S AUTHORITY TO OPERATE THE EQUIPMENT.



INFORMATION FOR USERS:

CHANGES OR MODIFICATIONS TO THIS PRODUCT NOT APPROVED BY THE MANUFACTURER WILL VOID THE WARRANTY.

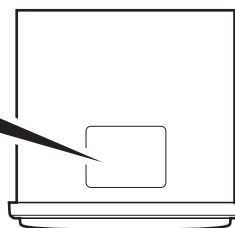
| | | |
|--|----------------------|---|
| MODEL | <input type="text"/> | clarion |
| 12V \ominus GROUND | | |
| AM 531-1629kHz / FM 87.0-108MHz | | |
| <small>This product includes technology owned by Microsoft Corporation and cannot be used or distributed without a license from MSLGP.</small> | | |
| 051 722 877 | | |
| SERIAL No. PE- <input type="text"/> | <input type="text"/> | Clarion Co., Ltd. MADE IN <input type="text"/> |



Handling Compact Discs

Use only compact discs bearing the  or  mark.

Do not play heart-shaped, octagonal, or other specially shaped compact discs.

Some CDs recorded in CD-R/CD-RW mode may not be usable.

Handling

- Compared to ordinary music CDs, CD-R and CD-RW discs are both easily affected by high temperature and humidity and some of CD-R and CD-RW discs may not be played. Therefore, do not leave them for a long time in the car.
- New discs may have some roughness around the edges. If such discs are used, the player may not work or the sound may skip. Use a ball-point pen or the like to remove any roughness from the edge of the disc.
- Never stick labels on the surface of the compact disc or mark the surface with a pencil or pen.
- Never play a compact disc with any cellophane tape or other glue on it or with peeling off marks. If you try to play such a compact disc, you may not be able to get it back out of the

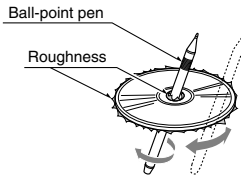

CD player or it may damage the CD player.

- Do not use compact discs that have large scratches, are misshapen, cracked, etc. Use of such discs may cause misoperation or damage.
- To remove a compact disc from its storage case, press down on the center of the case and lift the disc out, holding it carefully by the edges.
- Do not use commercially available CD protection sheets or discs equipped with stabilizers, etc. These may damage the disc or cause breakdown of the internal mechanism.

Storage

- Do not expose compact discs to direct sunlight or any heat source.
- Do not expose compact discs to excess humidity or dust.
- Do not expose compact discs to direct heat from heaters.

Cleaning

- To remove fingermarks and dust, use a soft cloth and wipe in a straight line from the center of the compact disc to the circumference.
- Do not use any solvents, such as commercially available cleaners, anti-static spray, or thinner to clean compact discs.
- After using special compact disc cleaner, let the compact disc dry off well before playing it.

5. REMOTE CONTROL

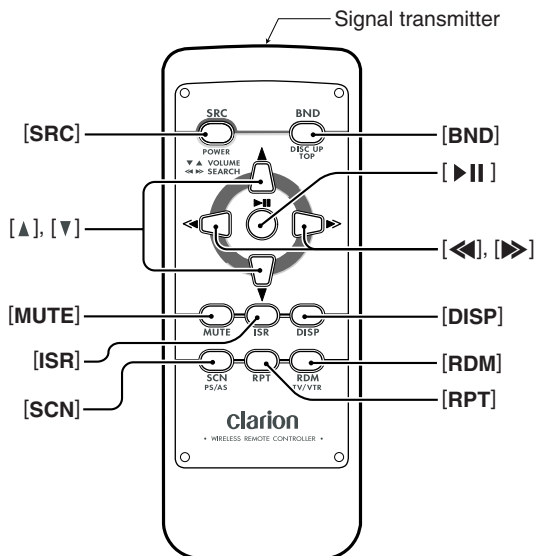

Inserting the Battery

- ① Turn over the remote control unit and slide the cover in the direction indicated by the arrow in the illustration.
- ② Insert the battery (CR2025) into the insertion guides, with the printed side (+) facing upwards.
- ③ Press the battery in the direction indicated by the arrow so that it slides into the compartment.
- ④ Replace the cover and slide in until it clicks into place.

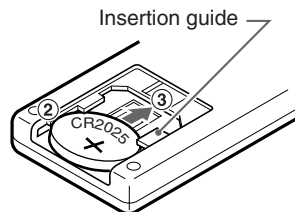
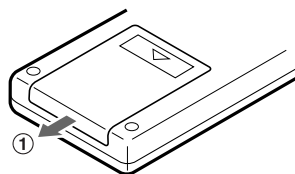

Notes:

Misuse may result in rupture of the battery, producing leakage of fluid and resulting in personal injury or damage to surrounding materials. Always follow these safety precautions:

- Use only the designated battery.
- When replacing the battery, insert properly, with +/- polarities oriented correctly.
- Do not subject battery to heat, or dispose of in fire or water. Do not attempt to disassemble the battery.
- Dispose of used batteries properly.

Functions of Remote Control Unit Buttons

| Mode Button | Radio | CD/MP3/MC (MUSIC CATCHER) |
|----------------|---|---|
| [SRC] | Switches among radio, CD/MP3, MC. | |
| [BND] | Switches reception band. | Plays the first track. Top play. |
| [▲], [▼] | Increases and decreases volume (in all modes). | |
| [◀], [▶] | Moves preset channels up and down. | Moves tracks up and down. When pressed and held for 1 second or longer: Fast-forward/fast-backward. |
| [▶▶] | No function. | Switches between playback and pause. |
| [MUTE] | Turns mute on and off. | |
| [ISR] | Recalls ISR radio station in memory. Press and hold for 2 seconds or longer: Stores current station into ISR memory (radio mode only). | |
| [DISP] | Switches among main display, title display, clock display. | |
| [SCN] | Preset scan. When pressed and held for 2 seconds or longer: Auto store. | Scan play. Press and hold the button for 1 second or longer to perform folder scan play while in the MP3/WMA disc, MC mode. |
| [RPT] | No function. | Repeat play. Press and hold the button for 1 second or longer to perform folder Repeat play while in the MP3/ WMA disc, MC mode. |
| [RDM] | No function. | Random play. Press and hold the button for 1 second or longer to perform folder Random play while in the MP3/ WMA disc, MC mode. |

* Some of the corresponding buttons on the main unit and remote control unit have different functions.

6. DCP

The control panel can be detached to prevent theft. When detaching the control panel, store it in the DCP (DETACHABLE CONTROL PANEL) case to prevent scratches.

We recommend taking the DCP with you when leaving the car.

Removing the DCP

1. Press the **[SRC]** button for 1 second or longer to switch off the power.
2. Press in the **[RELEASE]** button.

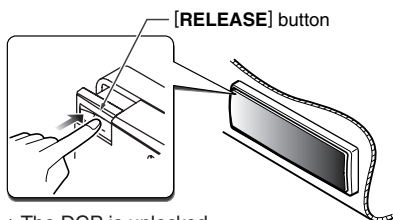

* The DCP is unlocked

3. Remove the DCP.

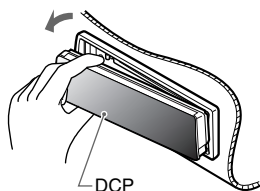

Attaching the DCP

1. Insert the right side of the DCP into the main unit.
2. Insert the left side of the DCP into the main unit.

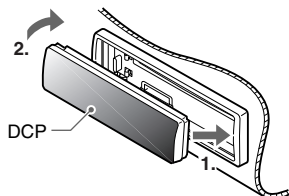

Storing the DCP in the DCP Case

Hold the DCP, in the orientation as shown in the figure below, and put it into the supplied DCP case. (Ensure the DCP is in the correct orientation.)

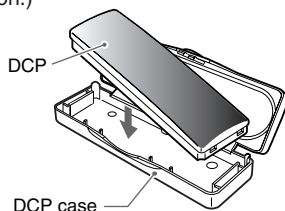

⚠ CAUTION

- The DCP can easily be damaged by shocks. After removing it, be careful not to drop it or subject it to strong shocks.
- When the Release button is pressed and the DCP is unlocked, the car's vibrations may cause it to fall. To prevent damage to the DCP, always store it in its case after detaching it. (See figure above.)
- The connector connecting the main unit and the DCP is an extremely important part. Be careful not to damage it by pressing on it with fingernails, pens, screwdrivers, etc.

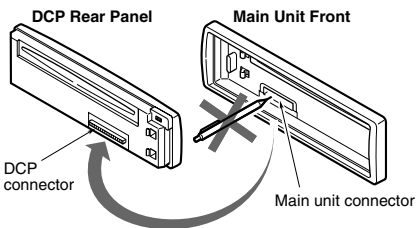

Note:

- If the DCP is dirty, wipe off the dirt with a soft, dry cloth only.

7. OPERATIONS

Basic Operations

Note: Be sure to read this chapter referring to the front diagrams of chapter "2. CONTROLS" on page 3 (unfold).

⚠ CAUTION

Be sure to lower the volume before switching off the unit power or the ignition key. The unit remembers its last volume setting. If you switch the power off with the volume up, when you switch the power back on, the sudden loud volume may hurt your hearing and damage the unit.

Turning on/off the power

Note:

• Be careful about using this unit for a long time without running the engine. If you drain the car's battery too far, you may not be able to start the engine and this can reduce the service life of the battery.

1. Press the [SRC] button.
2. The illumination and display on the unit light up. The unit automatically remembers its last operation mode and will automatically switch to display that mode.
3. Press and hold the [SRC] button for 1 second or longer to turn off the power for the unit.

Note:

• System check

The first time this unit is turned on after the wire connections are completed, it must be checked what equipment is connected. When the power is turned on, the "SYSTEM CHK" appears in the display, then the unit returns to the clock display mode. The system check starts within the unit. When the system check is complete, press the [SRC] button again.

Selecting a mode

1. Press the [SRC] button to change the operation mode.
2. Each time you press the [SRC] button, the operation mode changes in the following order:
Radio mode → CD/MP3 mode →
M-CATCHER mode → Radio mode...

Adjusting the volume

1. Turning the [ROTARY] knob clockwise increases the volume; turning it counterclockwise decreases the volume.
* The volume level is from 0 (minimum) to 33 (maximum).

Switching the display

1. Press the [D] button to select the desired display.
2. Each time you press the [D] button, the display switches in the following order:
Main display → Title display → Clock display → Main display ...
* Once selected, the preferred display becomes the display default. When a function adjustment such as volume is made, the screen will momentarily switch to that function's display, then revert back to the preferred display several seconds after the adjustment.
* When you have entered a title in a CD/MP3/WMA, it appears in the display. If you have not entered a title, "NO TITLE" appears in the display instead. For information on how to enter a title, refer to the subsection "Entering titles" in section "Operations Common to Each Mode".

Setting MAGNA BASS EXTEND

The MAGNA BASS EXTEND does not adjust the low sound area like the normal sound adjustment function, but emphasizes the deep bass sound area to provide you with a dynamic sound.

* The factory default setting is off.

1. Press and hold the [A-M] button for 1 second or longer to turn on the MAGNA BASS EXTEND effect. "M-B EX" lights in the display.
2. Press and hold the [A-M] button for 1 second or longer to turn off the MAGNA BASS EXTEND effect. "M-B EX" goes off from the display.

Setting the Z-Enhancer

This unit are provided with 3 types of sound tone effects stored in memory. Select the one you prefer.

* The factory default setting is "Z+ OFF".

Each time you press the [Z] button, the tone effect changes in the following order:

"Z-EHCER 1" → "Z-EHCER 2" → "Z-EHCER 3" → "Z+ OFF" → "Z-EHCER 1"...

- Z-EHCER 1 : bass emphasized
- Z-EHCER 2 : treble emphasized
- Z-EHCER 3 : bass and treble emphasized
- Z+ OFF : no sound effect

Basic Operations

Audio Mode Adjustments

1. Press the [A-M] button to select the adjustment mode. The mode switches as follows each time the [A-M] button is pressed:

BASS → TREB → BAL → FAD → Previous mode

- * The display returns to the previous mode 7 seconds after the adjustment.
- * When the adjustment is complete, press the [A-M] button several times until the function mode is reached.

Note:

- When the Z-Enhancer function is turned on, BASS (bass) and TREB (treble) cannot be selected.

• Adjusting the bass (BASS)

2. Turning the [ROTARY] knob clockwise emphasizes the bass; turning it counterclockwise attenuates the bass.
 - * The factory default setting is "0". (Adjustment range: -7 to +7)

• Adjusting the treble (TREB)

2. Turning the [ROTARY] knob clockwise emphasizes the treble; turning it counterclockwise attenuates the treble.
 - * The factory default setting is "0". (Adjustment range: -7 to +7)

• Adjusting the balance (BAL)

2. Turning the [ROTARY] knob clockwise emphasizes the sound from the right speaker; turning it counterclockwise emphasizes the sound from the left speaker.
 - * The factory default setting is "0". (Adjustment range: L13 to R13)

• Adjusting the fader (FAD)

2. Turning the [ROTARY] knob clockwise emphasizes the sound from the front speakers; turning it counterclockwise emphasizes the sound from the rear speakers.
 - * The factory default setting is "0". (Adjustment range: F12 to R12)

• When the adjustment is complete

3. Press the [A-M] button several times until the function mode is reached.

Illumination dimmer function

When the illumination line of this unit is connected with the car-side illumination signal line, the display illumination of this unit dims in connection with turning on the car-side illumination.

Radio Operations

Listening to the radio

1. Press the [SRC] button and select the radio mode. The frequency appears in the display.
2. Press the [BND] button and select the radio band. Each time the button is pressed, the radio reception band changes in the following order:
FM1 → FM2 → FM3 → AM → FM1...
3. Press the [◀] or [▶] button to tune in the desired station.

Tuning

There are 3 types of tuning mode available, seek tuning, manual tuning and preset tuning.

Seek tuning

1. Press the [BND] button and select the desired band (FM or AM).
 - * If "MANU" is lit in the display, press and hold the [BND] button for 1 second or longer. "MANU" in the display goes off and seek tuning is now available.
2. Press the [◀] or [▶] button to automatically seek a station.

When the [▶] button is pressed, the station is sought in the direction of higher frequencies; if the [◀] button is pressed, the station is sought in the direction of lower frequencies.

Manual tuning

There are 2 ways available: Quick tuning and step tuning.

When you are in the step tuning mode, the frequency changes one step at a time. In the quick tuning mode, you can quickly tune the desired frequency.

1. Press the [BND] button and select the desired band (FM or AM).
 - * If "MANU" is not lit in the display, press and hold the [BND] button for 1 second or longer. "MANU" is lit in the display and manual tuning is now available.
2. Tune into a station.

● Quick tuning:

Press and hold the [◀] or [▶] button for 1 second or longer to tune in a station.

● Step tuning:

Press the [◀] or [▶] button to manually tune in a station.

Radio Operations

Recalling a preset station

A total of 24 preset positions (6-FM1, 6-FM2, 6-FM3, 6-AM) exists to store individual radio stations in memory. Pressing the corresponding [DIRECT] button recalls the stored radio frequency automatically.

1. Press the [BND] button and select the desired band (FM or AM).
2. Press the corresponding [DIRECT] button to recall the stored station.
 - * Press and hold one of the [DIRECT] buttons for 2 seconds or longer to store that station into preset memory.

Manual memory

1. Select the desired station with seek tuning, manual tuning or preset tuning.
2. Press and hold one of the [DIRECT] buttons for 2 seconds or longer to store the current station into preset memory.



Auto store

Auto store is a function for storing up to 6 stations that are automatically tuned in sequentially. If 6 receivable stations cannot be received, a previously stored station remains unoverwritten at the memory position.

1. Press the [BND] button and select the desired band (FM or AM).
2. Press and hold the  button for 2 seconds or longer. The stations with good reception are stored automatically to the preset channels.

Preset scan

Preset scan receives the stations stored in preset memory in order. This function is useful when searching for a desired station in memory.

When the  button is pressed, the "SCN" will be indicated with preset memory numbers and the stations are tuned in for 7 seconds each in the order in which they were stored. Press the  button again to cancel the preset scanning mode.

Note:

- Be careful not to press and hold the  button for 2 seconds or longer, otherwise the auto store function is engaged and the unit starts storing stations.

Instant station recall (ISR)

Instant station recall is a special radio preset that instantly accesses a favorite radio station at a touch of a button. The ISR function even operates with the unit in other modes.

● ISR memory

1. Select the station that you wish to store in ISR memory.
2. Press and hold the [ISR] button for 2 seconds or longer.

● Recalling a station with ISR

In any mode, press the [ISR] button to turn on the radio function and tune the selected radio station. "ISR" appears in the display. Press the [ISR] button again to return to the previous mode.

CD/MP3/WMA Operations

MP3/WMA

What is MP3?

MP3 is an audio compression method and classified into audio layer 3 of MPEG standards. This audio compression method has penetrated into PC users and become a standard format.

This MP3 features the original audio data compression to about 10 percent of its initial size with a high sound quality. This means that about 10 music CDs can be recorded on a CD-R disc or CD-RW disc to allow a long listening time without having to change CDs.

What is WMA?

WMA is the abbreviation of Windows Media Audio, an audio file format developed by Microsoft Corporation.

Notes:

- If you play a file with DRM (Digital Rights Management) for WMA remaining ON, no audio is output. (The WMA indicator blinks.)
- Windows Media™, and the Windows ® logo are trademarks, or registered trademarks of Microsoft Corporation in the United States and/or other countries.

● To disable DRM (Digital Rights Management):

1. When using Windows Media Player 8, click on TOOLS → OPTIONS → COPY MUSIC tab, then under COPY SETTINGS, unclick the check box for PROTECT CONTENT. Then, reconstruct files.
2. When using Windows Media Player 9, click on TOOL → OPTIONS → MUSIC RECORD tab, then under Recording settings, unclick the Check box for RECORD PROTECTED MUSIC. Then, reconstruct files.

Personally constructed WMA files are used at your own responsibility.

Precautions when creating MP3/WMA disc

● Usable sampling rates and bit rates:

1. MP3: Sampling rate 11.025 kHz-48 kHz,
Bit rate: 8 kbps-320 kbps / VBR
2. WMA: Bit rate 48 kbps-192 kbps

● File extensions

1. Always add a file extension “.MP3” or “.WMA” to MP3 or WMA file by using single byte letters. If you add a file extension other than specified or forget to add the file extension, the file cannot be played.

2. Files without MP3/WMA data will not play. The indication “---:---” appears in the play time display if you attempt to play files without MP3/WMA data.

● Logical format (File system)

1. When writing MP3/WMA file on a CD-R disc or CD-RW disc, please select “ISO9660 level 1, 2 or JOLIET or Romeo” as the writing software format. Normal play may not be possible if the disc is recorded on another format.
2. The folder name and file name can be displayed as the title during MP3/WMA play but the title must be within 128 single byte alphabetical letters and numerals (including an extension).
3. Do not affix a name to a file inside a folder having the same name.

● Folder structure

1. A disc with a folder having more than 8 hierarchical levels will be impossible.

● Number of files or folders

1. Up to 255 files can be recognized per folder. Up to 500 files can be played.
2. Tracks are played in the order that they were recorded onto a disc. (Tracks might not always be played in the order displayed on the PC.)
3. Some noise may occur depending on the type of encoder software used while recording.

Multisession function

When a disc contains both normal CD type tracks and MP3/WMA type tracks mixedly, you can select which type of the recorded tracks to play.

● Default value is “CD”.

Each time you press and hold the [BND] button for 1 second or longer, the mixed mode is switched between CD type or MP3/WMA type. The following indication appears in the title display when switching the track type to be played.

● Display when CD type track is selected:

M-SESS CD

● Display when MP3/WMA type track is selected:

M-SESS MP3

1. Types of recording that can be played are as follows.

| Disc | Setting | Set to CD | Set to MP3/WMA |
|---------------------------------------|---------|--------------|----------------|
| Mixed with CD and MP3/WMA type tracks | | Play CD | Play MP3/WMA |
| CD type track only | | Play CD | Play CD |
| MP3/WMA type track only | | Play MP3/WMA | Play MP3/WMA |

2. After making these settings, remove the disc and then reinsert it.
3. When a mixed mode CD is loaded and CD is set, the track to be played first is MP3/WMA file data and no sound is heard.

Note:

• When playing a *CCCD (Copy Control CD)*, set the setting to *CD type*. When this is set to *MP3/WMA type*, the *CD cannot be played normally in some cases*.



Disc-In-Play function

As long as the ignition key is turned to the ON or ACC position, this function allows you to turn the power to the unit and start playing the disc automatically when the disc is inserted even if the power is not turned on.

Loading a CD

1. Insert a CD into the center of the CD SLOT with the label side facing up. The CD plays automatically after loading.

Notes:

- Never insert foreign objects into the CD SLOT.
- If the CD is not inserted easily, there may be another CD in the mechanism or the unit may require service.
- Discs not bearing the  or  mark and CD-ROMs cannot be played by this unit.
- Some CDs recorded in CD-R/CD-RW mode may not be usable.

Backup Eject function

Just pressing the [▲] button ejects the disc even if the power to the unit was not turned on.

1. Press the [▲] button. Remove the disc after it is ejected.

Notes:

- If you force a CD into before auto reloading, this can damage the CD.
- If a CD is left in the ejected position for 15 seconds, the CD is automatically reloaded. (Auto reload).

⚠ CAUTION

- Do not try to put your hand or fingers in the disc insertion slot. Also never insert foreign objects into the slot.
- Do not insert discs where adhesive comes out from cellophane tape or a rental CD label, or discs with marks where cellophane tape or rental CD labels were removed. It may be impossible to extract these discs from the unit and they may cause the unit to break down.

Listening to a disc already loaded in the unit

Press the [SRC] button to select the CD/MP3 mode.

When the unit enters the CD/MP3 mode, play starts automatically.

If there is no disc loaded, the indication “NO DISC” appears in the title display.

Radio → CD/MP3 → M-CATCHER → Radio...

* The mode changes each time the [SRC] button is pressed.

MUSIC CATCHER

In the M-CATCHER (MC) mode, the files recorded in the built-in flash memory are played back. Operations for listening to a recording made using MUSIC CATCHER are the same as “CD/MP3/WMA Operations”. For operations for recoding using MUSIC CATCHER, refer to the section “MUSIC CATCHER Operations”.

Pausing play

1. Press the [⏏] button to pause play. “PAUSE” appears in the display.
2. To resume CD play, press the [▶] button again.

Displaying CD titles

This unit can display title data for CD-text/MP3/WMA disc or M-CATCHER, and user titles input with this unit.

1. Press the [D] button to display the title.
2. Each time you press the [T] button, the title display changes in the following order:

● **CD-TEXT disc**

User title (disc) → CD-text title (disc) → Artist name → CD-text title (track) → User title (disc)...

CD/MP3/WMA Operations

● MP3/WMA disc

FOLDER → TRACK → ALBUM TAG →
ARTIST TAG → TITLE TAG → FOLDER...

● M-CATCHER

FOLDER ↔ TRACK

Notes:

- If the CD playing is not a CD-text CD or no user title has been input, "NO TITLE" appears in the display.
- If MP3/WMA disc is not input TAG, "NO TAG" appears in the display.
- For MP3, supports ID3 Tags V2.3 / 2.2 / 1.1 / 1.0.
- Tag displays give priority to V2.3 / 2.2.
- In the case of album Tags for WMA, the information written into the extension header is displayed.
- Only ASCII characters can be displayed in Tags.

Selecting a track

● Track-up

1. Press the [▶▶] button to move ahead to the beginning of the next track.
2. Each time you press the [▶▶] button, the track advances ahead to the beginning of the next track.

● Track-down

1. Press the [◀◀] button to move back to the beginning of the current track.
2. Press the [◀◀] button twice to move to the beginning of the previous track.

Fast-forward/fast-backward

● Fast-forward

Press and hold the [▶▶] button for 1 second or longer.

● Fast-backward

Press and hold the [◀◀] button for 1 second or longer.

* For MP3/WMA discs, it takes some time until the start of searching and between tracks. In addition, the playing time may have a margin of error.

Folder Select

This function allows you to select a folder containing MP3/WMA files and start playing from the first track in the folder.

1. Press the [UP] or [DN] button.
Press the [DN] button to move to the previous folder.
Press the [UP] button to move to the next folder.

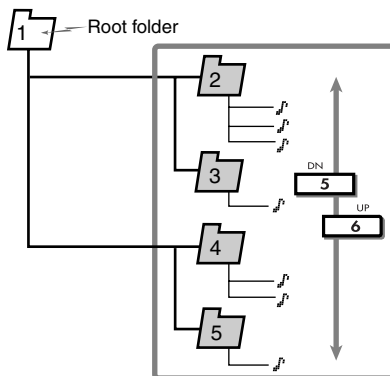

* Press the [UP] button while in the final folder to shift to the first folder.

* Folder without an MP3/WMA file is not selectable.

2. To select a track, press the [◀◀] or [▶▶] button.

Top function

The top function resets the CD player to the first track of the disc. Press the [BND] button to play the first track (track No. 1) on the disc.

* In case of MP3/WMA, the first track of a folder being played will be returned.

Other various play functions

● Scan play

This function allows you to locate and play the first 10 seconds of all the tracks recorded on a disc.

1. Press the [SCN] button to perform scan play.
The indication "SCN" lights in the display.
* Scan play starts from the next track after the track currently being played.

● Folder scan play

This function allows you to locate and play the first 10 seconds of the first track of all the folders on an MP3/WMA disc.

1. Press and hold the [SCN] button for 1 second or longer to perform folder scan play.
The indications "ALL..." and "SCN" light in the display.
* Folder scan play starts from the next track after the track currently being played.

● Repeat play

This function allows you to play the current track repeatedly.

1. Press the [RPT] button to perform repeat play.
The indication "RPT" lights in the display.

● Folder repeat play

This function allows you to play a track currently being played in the MP3/WMA folder repeatedly.

1. Press and hold the [RPT] button for 1 second or longer to perform folder repeat play.
The indications "ALL..." and "RPT" light in the display.

● Random play

This function allows you to play all tracks recorded on a disc in a random order.

1. Press the [RDM] button to perform random play.
The indication "RDM" lights in the display.

● Folder random play

This function allows you to play all the tracks of all the folders recorded on an MP3/WMA disc in a random order.

1. Press and hold the [RDM] button for 1 second or longer to perform folder random play.
The indications "ALL..." and "RDM" light in the display.

● To cancel play

1. Press the operating button previously selected.

Play list mode

This function allows you to play tracks, up to latest 5 time stamps, by reading the play list information written on the disc.

1. Press and hold the [ER] button for 1 second or longer to turn on or off the play list mode.
 - * Play list play is possible only when there is a file whose extension is ".M3U" on the CD-R/RW.
 - * Up to 5 play lists can be recognized, and up to 255 files can be recognized per play list.
2. Press the [◀] or [▶] button to change the track.
3. Press the [DN] button to move to the previous play list.
Press the [UP] button to move to the next play list.

Notes:

- The SCN/RPT/RDM functions cannot be used while in the play list mode.
- The title display changes from folder name to play list name.

Making a play list

1. Write desired tracks to a CD-R/RW, etc. Be sure to use alphanumeric/ASCII characters for all file names.
2. Make a play list by using a multimedia player, etc. and save the data. The file format must be M3U.
3. Again, write this play list to the CD-R/RW, etc.

Notes:

- When writing to a CD-R/RW, etc., be sure to use alphanumeric/ASCII characters.
- Up to 5 layers can be recognized as a list. For written play lists, latest 5 lists are recognized in the order in which they are written.
- When writing to a CD-R/RW, etc., turn off the Disc At Once function.
- When adding a play list, it is recommended to write it in the "Root" folder.

MUSIC CATCHER Operations

Note:

- Playback of recordings made with MUSIC CATCHER is performed in the same way as for CD/MP3. See pages 15-17 for details.

Setting a recording mode

The recording mode for MUSIC CATCHER (MC) can be switched between the following 2 modes:

- HQ (High Quality) MODE: about 130 minutes
- LP (Long Play) MODE: about 173 minutes

* The factory default setting is "HQ".

1. Press and hold the [D] button for 1 second or longer to switch to the adjustment selection display.
2. Press the [◀] or [▶] button and select "MC-REC".
3. Turning the [ROTARY] knob clockwise or counterclockwise and select "HQ" or "LP".
4. Press the [D] button to return to the previous mode.

Notes on recording using MUSIC CATCHER:

- Recording operations are to be performed in the CD/MP3 mode.
- Recordable media are CD-DAs only.
- Discs (CD-R/CD-RW) created by copying on a music recorder cannot be recorded.
- MP3/WMA discs cannot be recorded.
- Some CDs may show a subtractive time indication in the area between tracks when they are played back. A between-tracks area is not recorded in such a CD.
- In recording using MUSIC CATCHER, some amount of silent time is created between the tracks.
- If the disc contains some tracks that have been already recorded, the other tracks are recorded.
- Folder and file names are added automatically during recording. These file names cannot be changed. (The file names correspond to the track Nos. on the CD.)
These folder names can be changed.
- If the disc is not recordable, "NO REC DSC" shows on the display.
- If the disc contains some tracks previously recorded, "INCLUDED" shows on the display.
- If there is no empty folder available, "FOLDER FUL" shows on the display.

- When the memory capacity is used up, "MEMO FULL" shows on the display and recording is canceled.
- Recording cannot be performed during SCN, RPT, and RDM. In such cases, "BUSY" shows on the display.
- The [▶], [◀], [▶], [BND] and [SCN/RPT/RDM] buttons are invalid during recording. When these buttons are pressed, "INVALID" shows on the display.

Recording operation (REC function)

Recording using MUSIC CATCHER is performed in the CD/MP3 mode and the following 2 recording modes are available:

"TRACK REC" to record only one track currently being played back and "DISC REC" to record all tracks on the CD.

● TRACK REC

1. Press the [SRC] button to select the CD/MP3 mode.
2. Play back a track to be recorded and press the [REC] button. Then, the "R" indicator blinks on the display, "TRACK REC" shows on the title display for 2 seconds, and recording starts.

* When recording is complete, the "R" indicator goes off and "REC DONE" shows on the display for 2 seconds.

● DISC REC

1. Press the [SRC] button to select the CD/MP3 mode.
2. Play back a CD to be recorded and press and hold the [REC] button for 2 seconds or longer. Then, the "R" indicator blinks on the display, "DISC REC" shows on the display for 2 seconds, and recording starts.

* When recording is complete, the "R" indicator goes off and "REC DONE" shows on the display for 2 seconds.

Canceling recording

1. To suspend recording, press the [REC] button again. Then, recording is canceled. The display shows "CANCELED" for 2 seconds and then the playback of the CD continues.

Notes:

- Recording also can be canceled by pressing the [SRC], [▲] or [ISR] button.
- When recording is canceled, the file that has been recorded incompletely is deleted.

MUSIC CATCHER Operations

Erasing operation (ERASE function)

Erasing recordings made using MUSIC CATCHER is performed in the MC mode and the following 3 erasing modes are available.

- “TRK ERASE” : erase only one file.
- “FLD ERASE” : erase the whole folder.
- “ALL ERASE” : erase all the contents of the flash memory.

1. Press the [SRC] button to select the MC mode.
2. Each time you press the [ER] button, the display switches in the following order:
TRK ERASE → FLD ERASE → Normal mode

Note:

- Do not turn off the power to the unit or switch the operation mode during erasing recordings.

● TRK ERASE

1. Press the [SRC] button to select the MC mode.
2. Play back a track to be erased, and press the [ER] button to select “TRK ERASE”.
3. While “TRK ERASE” is showing on the display, press and hold the  button for 2 seconds or longer. The title display shows “ERASING” as the track currently being played back is erased.

● FLD ERASE

1. Press the [SRC] button to select the MC mode.
2. Play back any track of the folder to be erased, and press the [ER] button to select “FLD ERASE”.
3. While “FLD ERASE” is showing on the display, press and hold the  button for 2 seconds or longer. The title display shows “ERASING” as the folder currently being played back is erased.

● ALL ERASE

1. Press the [SRC] button to select the MC mode.
2. Press the [ER] button for 2 seconds or longer to select “ALL ERASE”.
3. While “ALL ERASE” is showing on the display, press and hold the  button for 2 seconds or longer. The title display shows “ERASING” as ALL ERASE is executed.

Remaining capacity of the memory

By pressing the [REC] button while in the MC mode, the remaining capacity of the flash memory can be displayed for 4 seconds as an approximate recordable time in “MM (minute): SS (second)”.

The title display shows “AVL 123:45”.

Note:

- The recordable time shown varies according to the set recording mode

Operations Common to Each Mode

To change settings

1. Press and hold the [D] button for 1 second or longer to switch to the adjustment selection display.

2. Press the [◀] or [▶] button to select the "item name".

"CLOCK <E>" ↔ "MC-REC" ↔ "SCREEN SVR" ↔ "MSG INP<E>" ↔ "AUTO SCROL" ↔ "DIMMER" ↔ "SYS CHK<E>" ↔...

3. Turn the [ROTARY] knob to select the "desired setting value".

* In the case of item names appearing with the "E" suffix, after the item name, the [▶] button must be pressed to display the setting value.

* After completing settings, press the [D] button to return to the previous mode.

● Setting the clock

2-1. Select "CLOCK <E>".

3-1. Press the [▶] button.

3-2. Press the [◀] or [▶] button to select the hour or the minute.

3-3. Turn the [ROTARY] knob to set the correct time.

* The clock is displayed in 12-hour format.

3-4. Press the [▶] button to store the time into memory.

Note:

• You cannot set the clock when it is displayed with only the ignition on. If you drain or remove the car's battery or take out this unit, the clock is reset. While setting the clock, if another button or operation is selected, the clock set mode is canceled.

● Turning the screen saver function on or off

This unit is provided with the screen saver function which allows you to show various kinds of patterns and characters in the Operation Status indication area of the display. You can turn on and off this function.

If the button operation is performed with the screen saver function on, the operation display corresponding to the button operation is shown for about 30 seconds and the display returns to the screen saver display.

* The factory default setting is "ON".

2-1. Select "SCREEN SVR".

3-1. Turn the [ROTARY] knob to select the setting. Each time you turning the [ROTARY] knob, the setting changes in the following order:

SS OFF → SS ON → SS MESSAGE

● Entering MESSAGE INFORMATION

When the use of the message is selected for the screen saver setting, you can change the contents of the message.

* Up to 30 characters can be entered.

* The factory default setting is "WELCOME TO CLARION".

2-1. Select "MSG INP<E>".

3-1. Press the [▶] button.

3-2. Press the [◀] or [▶] button to move the cursor.

3-3. Press the [BND] button to select a character. Each time you press the [BND] button, the character changes in the following orders:

Capital letters → Numbers → Symbols → Capital letters...

3-4. Turn the [ROTARY] knob to select the desired character.

3-5. Repeat step 3-2 to 3-4 to enter up to 30 characters for message.

3-6. Press and hold the [▶] button for 2 seconds or longer to store the message in memory and cancel input message mode.

* Press and hold the [BND] button for 1 second or longer to cancel the input message. Then press and hold the [▶] button for 2 seconds or longer to store the message and the message return to default setting.

● Setting the method for title scroll

Set how to scroll in CD-TEXT, MP3/WMA TITLE.

* The factory default setting is "ON".

2-1. Select "AUTO SCROL".

3-1. Turn the [ROTARY] knob to select "ON" or "OFF".

● ON:

To scroll automatically.

● OFF:

To scroll just 1 time when the title was changed or the [T] button was pressed for 1 second or longer.

● Dimmer control

You can setting the dimmer control "ON" or "OFF".

* The factory default setting is "ON".

2-1. Select "DIMMER".

3-1. Turn the [ROTARY] knob to select "ON" or "OFF".

Operations Common to Each Mode

● Performing a system check

2-1. Select "SYS CHK<E>".

3-1. Press and hold the  button for 1 second or longer.

"SYSTEM CHK" appears in the display, then the unit returns to the previous operation mode.

Entering titles

Titles up to 10 characters long can be stored in memory and displayed for CD, MC and Radio stations. The number of titles that can be entered for each mode are as follows.

| Mode | Number of titles |
|------------|------------------|
| CD mode | 50 titles |
| MC mode | 64 titles |
| Radio mode | 30 titles |

1. Press the [SRC] button to select the mode you want to enter a title (Radio, CD or MC).
2. Select and play a CD or MC, or tune in to a Radio station for which you want to enter the title.
3. Press the [D] button and display the title.
4. Press the [T] button to select user title in the CD mode (or folder in the MC mode).
5. Press and hold [T] button for 1 second or longer.
6. Press the [◀] or [▶] button to move the cursor.
7. Press the [BND] button to select a character. Each time you press the [BND] button, the character changes in the following order:
Capital letters → Numbers → Symbols → Capital letters...
8. Turn the [ROTARY] knob to select the desired character.
9. Repeat steps 6 to 8 to enter up to 10 characters for the title.
10. Press and hold the  button for 2 seconds or longer to store the title into memory and cancel title input mode.

Clearing titles

1. Select and play a CD or MC, or tune in to a Radio station for which you want to clear the title.
2. Press the [D] button and display the title.
3. Press the [T] button to select user title in the CD mode (or folder in the MC mode).
4. Press and hold the [T] button for 1 second or longer.
5. Press and hold the [BND] button for 1 second or longer.
6. Press and hold the  button for 2 seconds or longer to clear the title and cancel title input mode.

Note:

- When the folder name was cleared, it automatically returns to the folder name which is added automatically during recording.

8. IN CASE OF DIFFICULTY

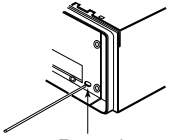
| | Problem | Cause | Measure |
|--|--|---|--|
| General | Power does not turn on. (No sound is produced.) | Fuse is blown. | Replace with a fuse of the same amperage. If the fuse blows again, consult your store of purchase. |
| | | Incorrect wiring. | Consult your store of purchase. |
| | No sound output when operating the unit with amplifiers or power antenna attached. | Power antenna lead is shorted to ground or excessive current is required for remote-on the amplifiers or power antenna. | <ol style="list-style-type: none"> 1. Turn the unit off. 2. Remove all wires attached to the power antenna lead. Check each wire for a possible short to ground using an ohm meter. 3. Turn the unit back on. 4. Reconnect each amplifier remote wire to the power antenna lead one by one. If the amplifiers turn off before all wires are attached, use an external relay to provide remote-on voltage (excessive current required). |
| | Nothing happens when buttons are pressed. Display is not accurate. | The microprocessor has malfunctioned due to noise, etc. | Turn off the power, then press the [RELEASE] button and remove the DCP. Press the reset button for about 2 seconds with a thin rod.  |
| | | DCP or main unit connectors are dirty. | Wipe the dirt off with a soft cloth moistened with cleaning alcohol. |
| CD/MP3/WMA | No sound heard. | MP3/WMA files are absent in a disc. | Write MP3/WMA files onto the disc properly. |
| | | Files are not recognized as an MP3/WMA file. | Use MP3/WMA files encoded properly. |
| | | File system is not correct. | Use ISO9660 level 1, 2 or JOLIET or Romeo file system. |
| | Sound skips or is noisy. | Disc is dirty. | Clean the disc with a soft cloth. |
| | | Disc is heavily scratched or warped. | Replace with a disc with no scratches. |
| Sound is cut or skipped. Noise is generated or noise is mixed with sound. | MP3/WMA files are not encoded properly. | Use MP3/WMA files encoded properly. | |

| | Problem | Cause | Measure |
|------------|---|---|---|
| CD/MP3/WMA | Sound is bad directly after power is turned on. | Water droplets may form on the internal lens when the car is parked in a humid place. | Let dry for about 1 hour with the power on. |
| | Wrong filename | File system is not correct. | Use ISO9660 level 1, 2 or JOLIET or Romeo file system. |
| | Play list play is not performed. | File name or extension is not correct. | Use alphanumeric/ASCII characters for MP3/WMA file name. Use ".M3U" for the file extension of a play list. |

9. ERROR DISPLAYS

If an error occurs, one of the following displays is displayed.
Take the measures described below to eliminate the problem.

| | Error Display | Cause | Measure |
|------------|----------------|---|---|
| CD/MP3/WMA | ERROR 2 | A DISC is caught inside the CD deck and is not ejected. | This is a failure of CD deck's mechanism and consult your store of purchase. |
| | ERROR 3 | A DISC cannot be played due to scratches, etc. | Replace with a non-scratched, non-warped-disc. |
| | ERROR 6 | A DISC is loaded upside-down inside the CD deck and does not play. | Eject the disc then reload it properly. |
| M-CATCHER | ERROR 7 | The format of the flash memory is damaged. | Execute ALL ERASE on the flash memory, and the problem is solved. |
| | ERROR 8 | There is a failure with the flash memory. | Turn POWER/ACC off and then turn it on again, and the problem is solved. If not solved, executed ALL ERASE on the flash memory, and the problem is solved. |
| | ERROR 9 | An error during recording, scratch on the disc, or error due to sound skips | Turn POWER/ACC off and then turn it on again, or eject the CD. The problem is solved. |

If an error display other than the ones described above appears, press the reset button. If the problem persists, turn off the power and consult your store of purchase.

10. SPECIFICATIONS

FM Tuner

Frequency Range: 87.0 MHz to 108.0 MHz
 Usable Sensitivity: 9 dBf
 50dB Quieting Sensitivity: 15 dBf
 Alternate Channel Selectivity: 70 dB
 Stereo Separation (1 kHz): 35 dB
 Frequency Response (± 3 dB): 30 Hz to 15 kHz

AM Tuner

Frequency Range: 531 kHz to 1629 kHz
 Usable Sensitivity: 25 μ V

CD Player

System: Compact disc digital audio system
 Usable Discs: Compact disc
 Frequency Response (± 1 dB): 10 Hz to 20 kHz
 Signal to Noise Ratio (1 kHz): 100 dB
 Dynamic Range (1 kHz): 93 dB
 Harmonic Distortion: 0.03%

MC mode

HQ: Approximately 130 minutes, 32 tracks
 (4 minutes for each)
 LP: Approximately 173 minutes, 43 tracks
 (4 minutes for each)

Audio

Maximum Power Output: 208 W (52 W \times 4 ch)
 Continuous Average Power Output:
 17 W \times 4, into 4 Ω , 20 Hz to 20 kHz, 1%THD
 Bass Control Action (100 Hz): +14 dB, -14dB
 Treble Control Action (10 kHz):
 +14dB, -14dB
 Line Output Level (CD 1 kHz): 1.8 V

General

Power Supply Voltage:
 14.4 V DC (10.8 to 15.6 V allowable), negative ground
 Current Consumption: Less than 15 A
 Speaker Impedance: 4 Ω (4 Ω to 8 Ω allowable)
 Weight / Source unit: 1.3 kg
 Weight / Remote control unit:
 40 g (including battery)
 Dimensions / Source unit:
 178 mm Width \times 50 mm Height \times 155 mm Depth
 Dimensions / Remote control unit:
 144 mm Width \times 110 mm Height \times 11 mm Depth

Notes:

- Specifications and design are subject to change without notice for further improvement.

Clarion Co., Ltd.

All Rights Reserved. Copyright © 2004: Clarion Co., Ltd.

2004/12 (Y-C)

PE-2732K
280-8138-00

Free Manuals Download Website

<http://myh66.com>

<http://usermanuals.us>

<http://www.somanuals.com>

<http://www.4manuals.cc>

<http://www.manual-lib.com>

<http://www.404manual.com>

<http://www.luxmanual.com>

<http://aubethermostatmanual.com>

Golf course search by state

<http://golfingnear.com>

Email search by domain

<http://emailbydomain.com>

Auto manuals search

<http://auto.somanuals.com>

TV manuals search

<http://tv.somanuals.com>