

Thank you for purchasing the DCZ625 system. The DCZ625 is designed incorporating the latest digital technologies, while featuring a newly developed CD mechanism to achieve excellent performance and good reliability. Please read this owner's manual entirely before proceeding with installation.



This equipment has been tested and found to comply with the limits for a Class B digital device, pursuant to Part 15 of the FCC Rules.

These limits are designed to provide reasonable protection against harmful interference in a residential installation. This equipment generates, uses, and can radiate radio frequency energy and, if not installed and used in accordance with the instructions, may cause harmful interference to radio communications. However, there is no guarantee that interference will not occur in a particular installation. If this equipment does cause harmful interference to radio or television reception, which can be determined by turning the equipment off and on, the user is encouraged to consult the dealer or an experienced radio/TV technician for help.

USE OF CONTROLS, ADJUSTMENTS, OR PERFORMANCE OF PROCEDURES OTHER THAN THOSE SPECIFIED HEREIN, MAY RESULT IN HAZARDOUS RADIATION EXPOSURE.

THE COMPACT DISC PLAYER SHOULD NOT BE ADJUSTED OR REPAIRED BY ANYONE EXCEPT PROPERLY QUALIFIED SERVICE PERSONNEL. CHANGES OR MODIFICATIONS NOT EXPRESSLY APPROVED BY THE MANUFACTURER FOR COMPLIANCE COULD VOID THE USER'S AUTHORITY TO OPERATE THE EQUIPMENT.

INFORMATION FOR USERS: CHANGES OR MODIFICATIONS TO THIS PRODUCT NOT APPROVED BY THE MANUFACTURER WILL VOID THE WARRANTY AND WILL VIOLATE FCC APPROVAL.

1 FEATURES

- 6-Disc Capability
- CeNET with Balanced Audio Line Transmission and Dynamic Noise Canceling
- 8-Times Oversampling Digital Filter
- Dual 1-Bit D/A Converters
- Zero-Bit Detector™ Mute Circuit
- 3-Beam Laser System
- Spring-Loaded Silicon Oil-Dampened Suspension System
- Eject Capability While Ignition-Off
- 120° Mounting Capability
- Optical Digital Output
- CD TEXT
- Dimensions: 8-7/8"(225mm)W x 2-1/2"(63mm)H x 6-9/16"(167mm)D

2 PRECAUTIONS

- This unit does not operate independently. The unit must be used with a source unit that has a cable connection for CeNET wire bound (sold separately).
- CD singles cannot be used.
- The pickup, the heart of a player, is built in deep behind the door. Do not leave this door open for extended periods to prevent dust adhering to the pickup.
 - When the inside of the car is very cold and the player is used soon after switching on the heater, dew may form on the disc or optical parts of the player and proper playback may not be possible. If dew forms on the disc, wipe it with a soft cloth. If dew forms on the optical parts of the player do not use the player for about one hour and the condensation will disappear naturally to allow normal operation.
- While the system is in play, do not plug or unplug the cables as this will cause damage.
- This unit is compatible with CD TEXT. When it is connected to a center unit suitable for CD TEXT display, CD TEXT can be displayed. (When it is connected to a center unit without CD TEXT function, CD TEXT can not be displayed.)
- Do not expose the magazine to direct sunlight, the car heater or other sources of strong heat. Replace the CD magazine (CAA-397) with a new one if bent or otherwise damaged.

Caution

- The following magazines cannot be used for this unit. Using them will result in a damage to the mechanism and cause the magazine not to eject.
 - magazine (CAA-122) for the 12-disc CD changer (CDR1255z, CDR1240Z, CDC1235, etc.)
 - magazine (CAA-355) for the 6-disc CD changer (CDR655Tz, CDR655z, CDR640Z, etc.)

3 CAUTIONS ON HANDLING CDs

Use only compact discs bearing the mark and the mark. Do not play heart-shaped, octagonal, or other specially shaped compact discs.

Handling

- New discs may have some roughness around the edge. The set may not work or the sound may skip if such discs are used. Use a ball-point pen, etc., to remove roughness from the edge of the disc.

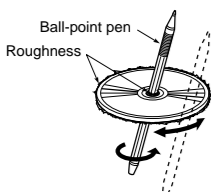

- Never stick labels on the surface of the compact disc or mark the surface with a pencil or pen.
- Never play a compact disc with any cellophane tape or other glue on it or with peeling off marks. If you try to play such a compact disc, you may not be able to get it back out of the CD player or it may damage the CD player.
- Always handle the compact disc by the edges. Never touch the surface.

- Do not use commercially available CD protection sheets or discs equipped with stabilizers, etc. These may get caught in the internal mechanism and damage the disc.

Storage

- Do not expose compact discs to direct sunlight or any heat source.
- Do not expose compact discs to excess humidity or dust.
- Do not expose compact discs to direct heat from heaters.

Cleaning

- To remove fingermarks and dust, use a soft cloth and wipe in a straight line from the center of the compact disc to the circumference.
- Do not use any solvents, such as commercially available cleaners, anti-static spray or thinner to clean compact discs.
- After using special compact disc cleaner, let the compact disc dry off well before playing it.

4 IDENTIFICATION OF PARTS

- 1 Installation selector levers
- 2 Eject button
- 3 Flip down door
- 4 CeNET terminal for input and output (13-pin)
- 5 Digital optical fiber output terminal
- 6 Address switch

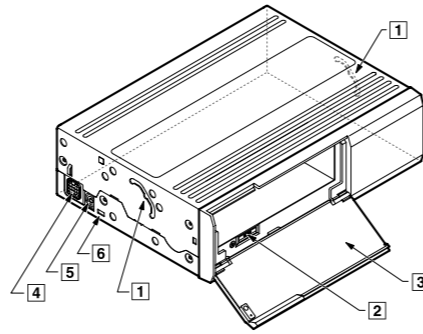

<How to change the address switch>

Switch the address by using a plastic stick with a sharp tip or equivalent.

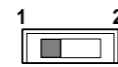

<Example of address switch setting>

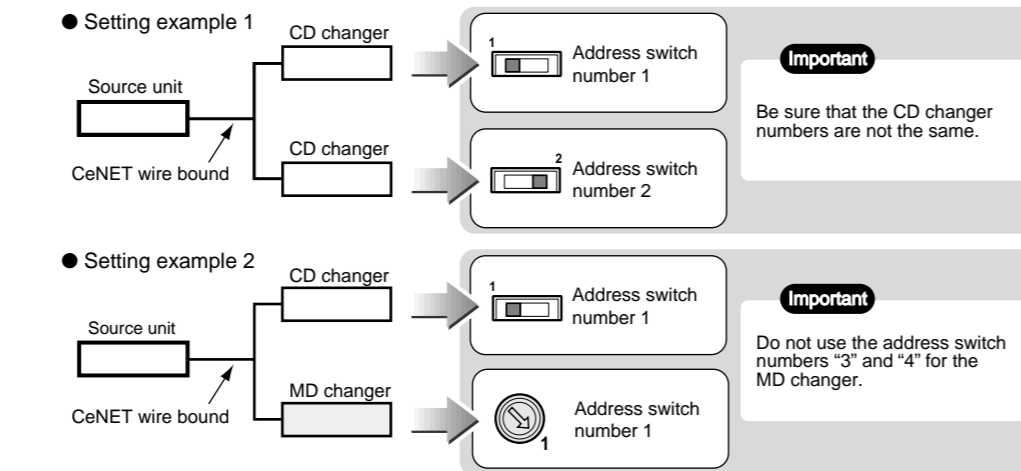

Caution

- The unit may not operate when both CD changers are set to the same address switch number.
- Never change the address switch during operation. Doing so can cause malfunction or breakdown. Do not change the address switch forcibly, because this may also cause malfunction.
- The CeNET cable wiring must be less than 65.62 ft (20m) in length.

5 CD MAGAZINE

Inserting the CD

- Put your finger on the disc holder release knob and draw out the disc holder.
- Insert a CD into the concave portion of the disc holder with its label side (printed side with a title, etc.) facing up.
- Press in on the disc holder until it locks securely into the magazine. After loading a CD, make sure that it is correctly loaded.

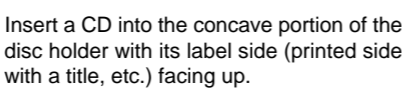
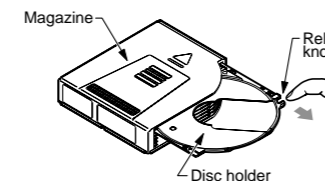

Caution

- Look through the magazine opening and check whether or not the CD is tilted. If the disc holder does not slide in fully, or slides with difficulty, it is possible that the CD is not correctly loaded. Reload in such cases.

Caution

- Pulling strongly on the disc holder may cause it to come out of the magazine. In such cases, press in on the disc holder tabs and re-insert into the magazine. Be sure that the disc holder is correctly inserted.

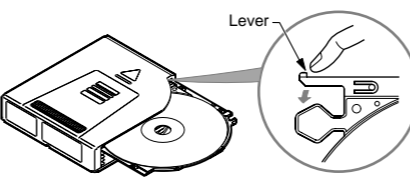

Extracting the CD

Take out the CD after pulling out the disc holder.

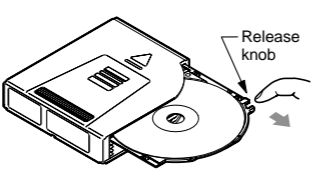

Note:

- When taking out the CD do not let your fingers touch the signal side of the CD.

Inserting the Magazine

- Open the flip down door.
- Insert the magazine (facing up as shown below) into the unit with the CD load/unload side on the right. Press the magazine into the unit until it locks securely.

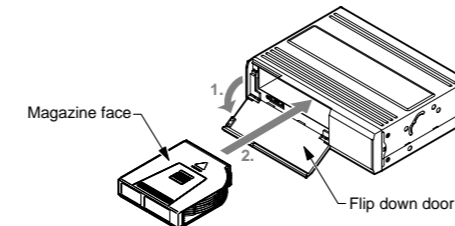

- Close the flip down door.

Extracting the Magazine

- Open the flip down door.
- Press the eject button and take out the magazine.

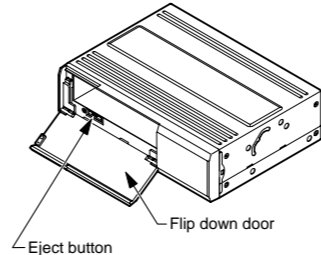

Caution

- Dust and other objects may cause malfunctions if they get into the unit. Always be sure to shut the flip down door once finished with loading or unloading the magazine.

6 SYSTEM EXAMPLE

This unit is available for upgrade in various ways.

When you want to upgrade the system, make sure that the upgrade unit fits and wire it correctly.

STANDARD SYSTEM

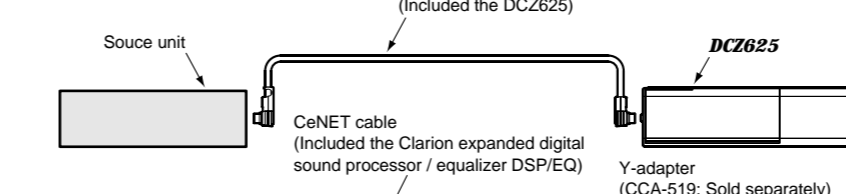

FULL SYSTEM

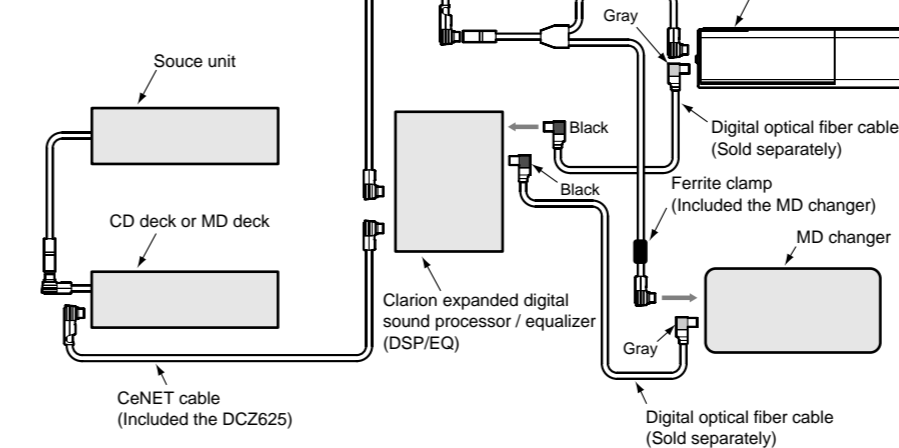

7 INSTALLATION OF CONNECTORS

Note:

Only the provided screws and brackets should be used during installation. Using screws other than those specified will cause damage.

- When connecting the CeNET cable, fully insert it. After connection, fix the connector with a clasper as shown in the figure.
- When removing the digital optical fiber cable, rotate it to loosen it and pull it gently while holding the slide cap (a gray color part on the source unit).
- Do not coil up the digital optical fiber cable with a radius of less than 1" (3 cm). With a radius of less than 1", the performance of the cable will be greatly impaired.
- When installed in a glove box or console box, make sure that the source unit cables or cords do not interfere with the opening or closing of the flip down door.

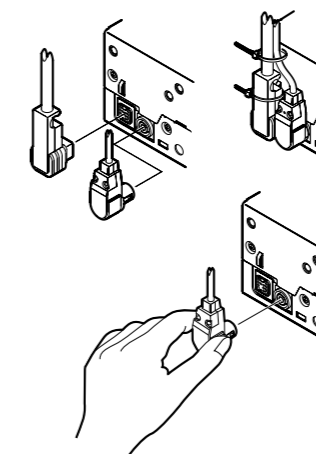

8 INSTALLATION

Prior to Installation

- Before attempting to use this unit you must first remove the packing safety lock pins (3 positions). Store these lock pins carefully so they can be used again if needed.
- Decide on the installation place and direction.
- Insert an item such as a screwdriver with a fine point or the tip of a ballpoint pen into the round hole of the installation selector lever to switch to the position you need.

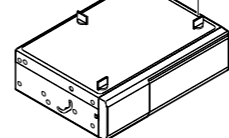

Note:

- Reinstall these lock pins when shipping the unit back for repair.

- Before shipment from the factory, the levers are normally placed in the horizontal position.

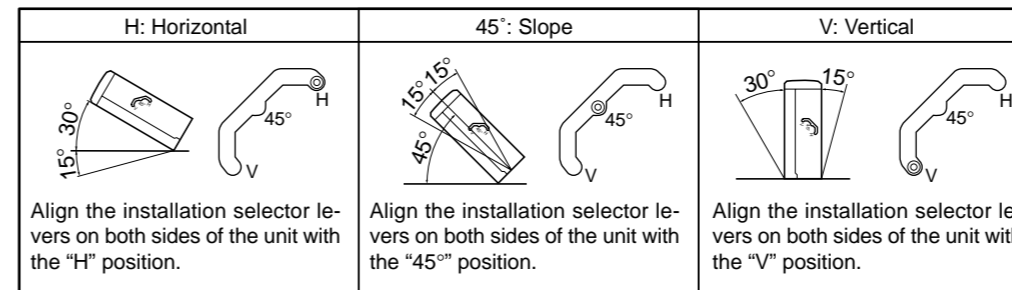

Caution

- Set the installation selector lever to the same position on both sides.
- When the unit is installed below the horizontal position (up to 15 degrees) the ejected magazine, when left in that position, will drop due to vibrations from the car.
- Adjust the installation selector levers into the correct locations. Setting the locations incorrectly or in varied positions will cause skipping.
- Do not move the installation selector levers while the unit is in use. This will cause damage to the mechanism and the disc.

Installation Procedure

- Use the double seamed hexagonal bolts to fix installation bracket to the unit (on both sides) in the desired direction of installation.
- Use the wing nut to hold in place the installation bracket with bolt to the installation bracket, which is attached to the unit. Then affix the cushion rubber.

<Vertical Position>

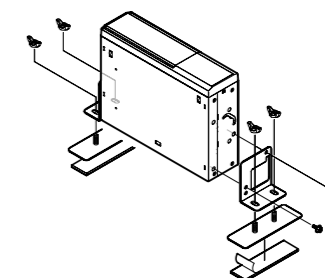

<Horizontal Position>

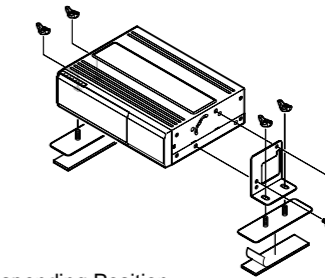

<Suspending Position>

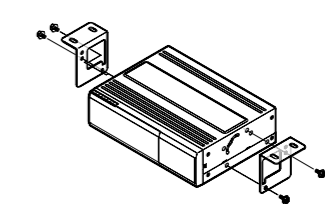

- Remove the floor carpet and decide on the place to install. Adjust the installation bracket with bolts to suit the place of installation.

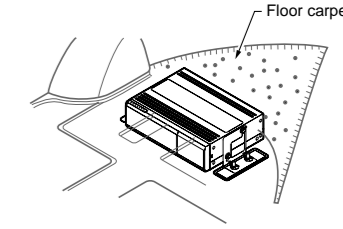

- Remove the separator of the cushion rubber that is attached to the installation bracket with bolt and install accordingly.

- Unfasten the wing nut and remove the unit.

- Return the floor carpet to its original place. Use a knife to cut into the carpet where the bolt can be felt, and allow the bolt to protrude from the carpet.

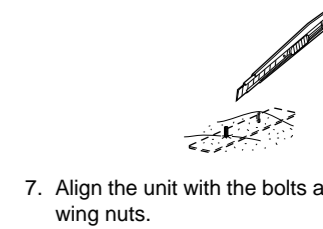

- Align the unit with the bolts and secure it with the wing nuts.

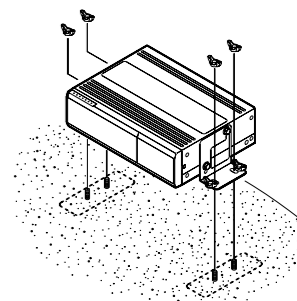

9 TROUBLESHOOTING

Symptom	Cause	Remedy
Loss of power Connection with the source unit is not recognized.	Bad connection.	Check connections. Connect the cable again.
	The length of the CeNET cable wiring is more than 65.62 ft (20m).	Rewire the connection so that the length of cable is less than 65.62 ft (20m).
	Address switch numbers are the same.	When the 2 CD changers are connected, set the address switch so that they do not have the same address number. Refer to the "Example of address switch setting" in the section titled "IDENTIFICATION OF PARTS".
Magazine cannot be loaded.	Magazine inserted wrongly.	Insert correctly.
	A magazine is already in the player.	Eject the magazine and insert the other.
	Distorted magazine.	Buy New Magazine CAA-397.
"No Disc" sign appears when searching for discs.	Disc inserted upside-down.	Read the section on "Inserting The CD" carefully and reinsert the CD correctly.
	Moisture or dirt on disc.	Wipe disc free of moisture and dirt.
Noise, skipping	The installation selector levers are set to different positions on both sides.	Set the installation selector levers to the same position on both sides.
	The unit installation direction and the installation selector lever positions do not match.	Set the unit installation direction and the installation selector lever positions to match each other. When installed at an angle, change the installation selector lever to a position (H, 45°, V) not prone to noise or sound loss.
	Disc bent or badly damaged.	Compare with another disc. If bad, discard the damaged disc.
	Disc is very dirty.	Clean the disc.
Mechanism does not function.	Mechanical error.	1. Referring to section "INSTALLATION", check the three angle of installation selector levers are properly set. If not, set them at the proper position for the angle of installation. 2. Check whether the CD magazine can be ejected by pressing the CD magazine eject button, then insert a new CD magazine.
Magazine is ejected even when inserted into the unit.	Disc holder is not correctly inserted into the magazine.	Read the section on "Inserting the CD" carefully and reinsert the disc holder correctly.

If the same phenomenon still occurs after checking the above, or it is impossible to remove the magazine, please consult your local dealer.

10 SPECIFICATIONS

Frequency Response	: 5Hz-20kHz(±1dB)
Signal-to-Noise Ratio	: 105dB(1kHz)HF+A
Wow and Flutter	: Below measurement limits
Power Supply	: DC14.4V (10.8-15.6V) negative ground
Current Consumption	: Less than 1A
Unit Weight	: 3.6lb. (1.65kg)
Dimensions	: 8-7/8"(Width) x 2-1/2"(Height) x 6-9/16"(Depth) [225mm(W) x 63mm(H) x 167mm(D)]

*Due to improvements, the design and these specifications may be modified without prior notice.

Free Manuals Download Website

<http://myh66.com>

<http://usermanuals.us>

<http://www.somanuals.com>

<http://www.4manuals.cc>

<http://www.manual-lib.com>

<http://www.404manual.com>

<http://www.luxmanual.com>

<http://aubethermostatmanual.com>

Golf course search by state

<http://golfingnear.com>

Email search by domain

<http://emailbydomain.com>

Auto manuals search

<http://auto.somanuals.com>

TV manuals search

<http://tv.somanuals.com>