

Clarion®

Owner's manual
Mode d'emploi
Manual de instrucciones

DXZ275MP

DXZ375MP

CD/MP3/WMA RECEIVER WITH CeNET CONTROL
AUTORADIO CD/MP3/WMA / AVEC COMMANDE CeNET
RECEPTOR CD/MP3/WMA CON CONTROL CeNET



This equipment has been tested and found to comply with the limits for a Class B digital device, pursuant to Part 15 of the FCC Rules.

These limits are designed to provide reasonable protection against harmful interference in a residential installation.

This equipment generates, uses, and can radiate radio frequency energy and, if not installed and used in accordance with the instructions, may cause harmful interference to radio communications. However, there is no guarantee that interference will not occur in a particular installation.

If this equipment does cause harmful interference to radio or television reception, which can be determined by turning the equipment off and on, the user is encouraged to consult the dealer or an experienced radio/TV technician for help.

Cet appareil a été testé et jugé conforme aux limites des appareils numériques de Classe B, aux termes de la Section 15 des Règlements FCC.

Ces limites ont pour but d'assurer une protection raisonnable contre les interférences parasites dans une installation résidentielle.

Cet appareil engendre, utilise et peut émettre une énergie radioélectrique et, s'il n'est pas installé et utilisé en stricte conformité avec ces instructions, il peut provoquer des interférences parasites sur les liaisons radiophoniques. Ceci ne garantit par pour autant qu'une installation particulière ne provoquera aucune interférence.

Si l'appareil engendre des interférences sur la réception des ondes radio ou de télévision, ce qui peut être vérifié en mettant l'appareil hors tension puis sous tension, l'utilisateur est invité à consulter son revendeur ou un technicien expérimenté en radio/télévision pour lui demander conseil.

Este equipo ha sido probado y se ha comprobado que cumple con los límites de un dispositivo digital de clase B, según lo indicado en la Parte 15 de las Normas de FCC.

Estos límites se han establecido para ofrecer una protección razonable contra interferencias perjudiciales en instalaciones residenciales.

Este equipo genera, emplea, y puede radiar energía de radiofrecuencia y, si no se instala y emplea de acuerdo con las instrucciones, puede causar interferencias perjudiciales en las radiocomunicaciones. Sin embargo, no se garantiza que las interferencias no ocurran en una instalación en particular.

Si este equipo causa interferencias perjudiciales en la recepción de radio o de televisión, lo cual podrá determinarse conectando y desconectando la alimentación del equipo, se aconseja al usuario que consulte al abastecedor o que pida ayuda a un técnico en radio/televisión experimentado.

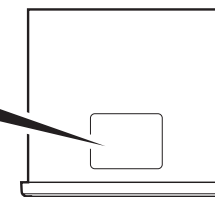
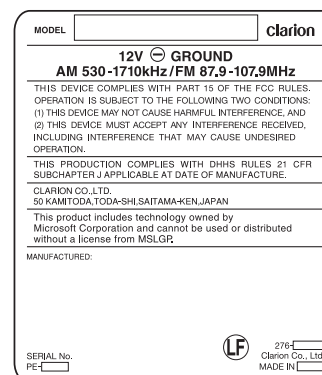

Bottom View of Source Unit
Fond de l'appareil pilote
Vista inferior de la unidad fuente

Be sure to unfold and read the next page.
Veillez déplier et vous référer à la page suivante.
Cerciórese de desplegar y de leer la página siguiente.

CONTROLS / LES COMMANDES / CONTROLES

Source unit / Appareil pilote / Unidad fuente

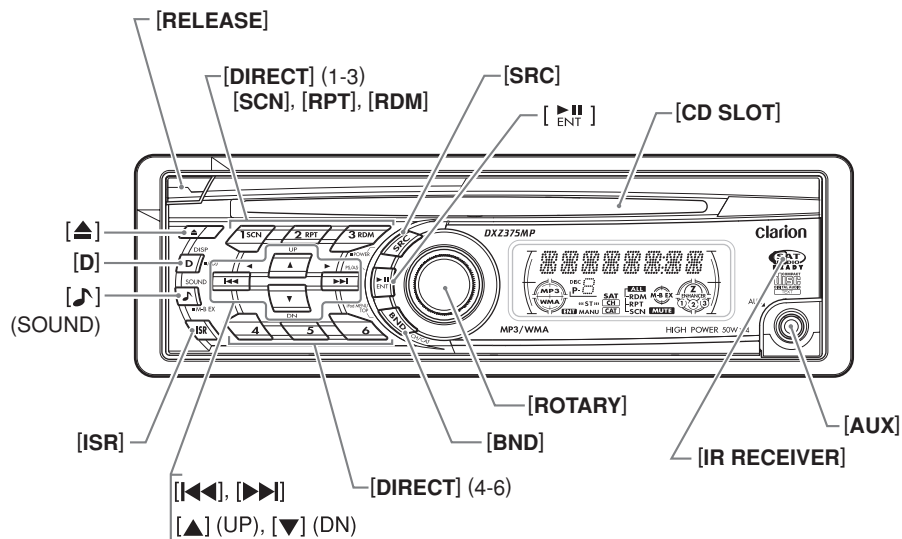

CLARION PRODUCT REGISTRATION INFORMATION

For USA and Canada only
www.clarion.com

Dear Customer:

Congratulations on your purchase of a Clarion mobile electronic products. We are confident that you'll enjoy your Clarion experience.

There are many benefits to registering your product. We invite you to visit our website at www.clarion.com to register your Clarion product.

We have made product registration simple with our easy to use website. The registration form is short and easy to complete. Once you're registered, we can keep you informed of important product information.

Register at www.clarion.com - it's easy to keep your Clarion product up to date.

INFORMATIONS DE L'ENREGISTREMENT DE PRODUITS CLARION

Pour les États Unis et le Canada seulement
www.clarion.com

Cher client:

Nous vous remercions d'avoir acheté ce produit électronique mobile Clarion. Nous sommes confiants que vous apprécierez votre expérience Clarion.

Il y a beaucoup d'avantage à enregistrer votre produits. Nous vous invitons à visiter notre site Web www.clarion.com pour enregistrer votre produit Clarion.

Nous avons facilité la tâche d'enregistrement de produit simple et facile grâce à notre site Web. Le formulaire d'enregistrement est court et facile à compléter. Lorsque vous êtes enregistrer, nous pouvons vous tenir informé des informations important de produits.

Enregistrer à www.clarion.com - c'est facile de mettre à jour votre produit Clarion.

INFORMACIÓN DEL REGISTRO DE PRODUCTO DE CLARION

Para USA y Canada nomas
www.clarion.com

Querido Cliente:

Felicitaciones por su compra de producto electrónico móvil de Clarion. Estamos seguros que usted gozará de su experiencia con el producto de Clarion.

Hay muchas ventajas al registrar su producto. Le invitamos a que visite nuestro sitio en internet www.clarion.com para registrar su producto de Clarion.

Hemos hecho el registro de producto fácil en nuestro sitio. La forma de registro es corta y fácil de completar. Una vez que lo registre, podremos proporcionarle la información de su producto.

Regístrese en www.clarion.com - es fácil mantener su producto de Clarion actualizado.

Note: Be sure to unfold this page and refer to the front diagrams as you read each chapter.

Remarque: Veuillez déplier cette page et vous référer aux schémas quand vous lisez chaque chapitre.

Nota: Cuando lea los capítulos, despliegue esta página y consulte los diagramas.

Thank you for purchasing this **Clarion** product.

- * Please read this owner's manual in its entirety before operating this equipment.
- * After reading this manual, be sure to keep it in a handy place (e.g., glove compartment).
- * Check the contents of the enclosed warranty card and keep it carefully with this manual.
- * This manual includes the operating procedures of the iPod® interface, CD/DVD changer, Satellite Radio Receiver and TV tuner connected via the CeNET cable. The iPod interface, CD/DVD changer and TV tuner have their own manuals, but no explanations for operating them are described. "iPod" is a trademark of Apple Computer, Inc., registered in the U.S. and other countries.

Contents

CONTROLS	ii
1. FEATURES	2
2. PRECAUTIONS	2
Handling Compact Discs	3
3. NOMENCLATURE	4
Names of the Buttons and Their Functions	4
Display Items	5
LCD Screen	5
4. DCP	6
5. REMOTE CONTROL	7
Inserting the Battery	7
Functions of Remote Control Unit Buttons	8
6. OPERATIONS	10
Basic Operations	10
Radio Operations	13
CD/MP3/WMA Operations	15
Operations Common to Each Mode	19
7. OPERATIONS OF ACCESSORIES	22
iPod BB Operations	22
Satellite Radio Operations.....	24
CD Changer Operations.....	26
DVD Changer Operations	27
TV Operations	27
8. IN CASE OF DIFFICULTY	28
9. ERROR DISPLAYS	29
10. SPECIFICATIONS	30

1. FEATURES

- High Visibility Single Line Display
- 2ch/2V RCA Output (DXZ275MP)
- 4ch/4V RCA Output (DXZ375MP)
- Front Panel 3.5mm Auxiliary Input (DXZ275MP)
- Built-in LPF/HPF (DXZ375MP)

2. PRECAUTIONS

1. When the inside of the car is very cold and the player is used soon after switching on the heater moisture may form on the disc or the optical parts of the player and proper playback may not be possible. If moisture forms on the disc, wipe it off with a soft cloth. If moisture forms on the optical parts of the player, do not use the player for about one hour. The condensation will disappear naturally allowing normal operation.
2. Driving on extremely bumpy roads which cause severe vibration may cause the sound to skip.
3. This unit uses a precision mechanism. Even in the event that trouble arises, never open the case, disassemble the unit, or lubricate the rotating parts.

▲ CAUTION

USE OF CONTROLS, ADJUSTMENTS, OR PERFORMANCE OF PROCEDURES OTHER THAN THOSE SPECIFIED HEREIN, MAY RESULT IN HAZARDOUS RADIATION EXPOSURE.

THE COMPACT DISC PLAYER SHOULD NOT BE ADJUSTED OR REPAIRED BY ANYONE EXCEPT PROPERLY QUALIFIED SERVICE PERSONNEL.

CHANGES OR MODIFICATIONS NOT EXPRESSLY APPROVED BY THE MANUFACTURER FOR COMPLIANCE COULD VOID THE USER'S AUTHORITY TO OPERATE THE EQUIPMENT.

INFORMATION FOR USERS:

CHANGES OR MODIFICATIONS TO THIS PRODUCT NOT APPROVED BY THE MANUFACTURER WILL VOID THE WARRANTY AND WILL VIOLATE FCC APPROVAL.

Handling Compact Discs

Use only compact discs bearing the  or



mark.

Do not play heart-shaped, octagonal, or other specially shaped compact discs.

Some CDs recorded in CD-R/CD-RW mode may not be usable.

Handling

- Compared to ordinary music CDs, CD-R and CD-RW discs are both easily affected by high temperature and humidity and some of CD-R and CD-RW discs may not be played.

Therefore, do not leave them for a long time in the car.

- New discs may have some roughness around the edges. If such discs are used, the player may not work or the sound may skip. Use a ball-point pen or the like to remove any roughness from the edge of the disc.

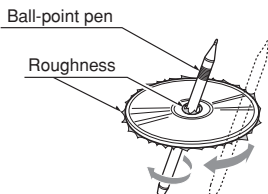

- Never stick labels on the surface of the compact disc or mark the surface with a pencil or pen.
- Never play a compact disc with any cellophane tape or other glue on it or with peeling off marks. If you try to play such a compact disc, you may not be able to get it back out of the CD player or it may damage the CD player.
- Do not use compact discs that have large scratches, are misshapen, cracked, etc. Use of such discs may cause misoperation or damage.
- To remove a compact disc from its storage case, press down on the center of the case and lift the disc out, holding it carefully by the edges.
- Do not use commercially available CD protection sheets or discs equipped with stabilizers, etc. These may damage the disc or cause breakdown of the internal mechanism.

Storage

- Do not expose compact discs to direct sunlight or any heat source.
- Do not expose compact discs to excess humidity or dust.
- Do not expose compact discs to direct heat from heaters.

Cleaning

- To remove fingermarks and dust, use a soft cloth and wipe in a straight line from the center of the compact disc to the circumference.
- Do not use any solvents, such as commercially available cleaners, anti-static spray, or thinner to clean compact discs.
- After using special compact disc cleaner, let the compact disc dry off well before playing it.

3. NOMENCLATURE

Note:

- Be sure to read this chapter referring to the front diagrams of chapter "CONTROLS" on page ii (unfold).

Names of the Buttons and Their Functions

[RELEASE] button

- Deeply push in the button to unlock the DCP.

[DIRECT] buttons

- Store a station into memory or recall it directly while in the radio mode.

[SCN] button

- Perform scan play for 10 seconds of each track while in the CD/MP3/WMA mode.
- Press and hold the button for 1 second or longer to perform folder scan play while in the MP3/WMA mode.

[RPT] button

- Perform repeat play while in the CD/MP3/WMA mode.
- Press and hold the button for 1 second or longer to perform folder repeat play while in the MP3/WMA mode.

[RDM] button

- Perform random play while in the CD/MP3/WMA mode.
- Press and hold the button for 1 second or longer to perform folder random play while in the MP3/WMA mode.

[SRC] button

- Press the button to turn on the power.
- Press and hold the button for 1 second or longer to turn off the power.
- Switch the operation mode among the radio mode, etc.

[▶||] button

- Perform preset scan while in the radio mode. When the button is pressed and held, auto store is performed.
- Play or pause a track while in the CD/MP3/WMA mode.
- Confirm various settings.

[CD SLOT]

- CD insertion slot.

[AUX] input jack

- The input jack for connecting an external device.

[IR RECEIVER]

- Receiver for remote control unit. (Operating range: 30° in all directions)

[ROTARY] knob

- Adjust the volume by turning the knob clockwise or counterclockwise.

[BND] button

- Switch the band, or seek tuning or manual tuning while in the radio mode.
- Play a first track while in the CD/MP3/WMA mode.
- Press the button to change the character.

[◀◀], [▶▶] buttons

- Select a station while in the radio mode or select a track while in the CD/MP3/WMA mode. This button is used to make various settings.
- Press and hold the button for 1 second or longer to enter the fast-forward or fast-backward mode.

[▲] (UP), [▼] (DN) buttons

- Select the folder while in the MP3/WMA mode.
- Use the buttons to perform various settings.

[ISR] button

- Recall ISR radio station in memory.
- Press and hold the button for 2 seconds or longer: Store current station into ISR memory (radio mode only).

[🔊] (SOUND) button

- Use the button to switch to the sound adjust mode.
- Press and hold the button for 1 second or longer to turn on or off the MAGNA BASS EXTEND mode.

[D] button

- Switch the display indication.
- Press and hold the button for 1 second or longer to enter the adjust mode.

[▶] (EJECT) button

- Press to eject a disc loaded in the unit.

Display Items

Operation status indication
Frequency, Titles, Clock, etc. are displayed

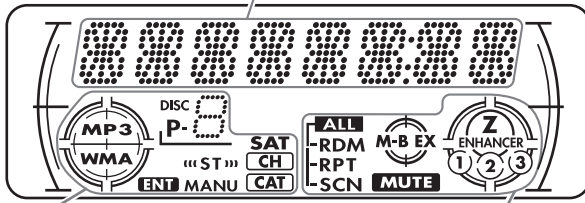

- : MP3 indication
- : WMA indication



- : Disc number indication
- : Preset channel indication (1 to 6)

“ST” : Stereo indication



: Enter indication

MANU : Manual indication

SAT : Satellite indication



: Channel indication



: Category indication



: Z-enhancer indication



: MAGNA BASS EX indication



: MUTE indication



: Disc or Folder random/
repeat/scan indication

RDM : Random indication

RPT : Repeat indication

SCN : Scan indication

: Scan indication

LCD Screen

In extreme cold, the screen movement may slow down and the screen may darken, but this is normal. The screen will recover when it returns to normal temperature.

4. DCP

The control panel can be detached to prevent theft. When detaching the control panel, store it in the DCP (DETACHABLE CONTROL PANEL) case to prevent scratches.

We recommend taking the DCP with you when leaving the car.

Removing the DCP

1. Press the **[SRC]** button for 1 second or longer to switch off the power.
2. Press in the **[RELEASE]** button.

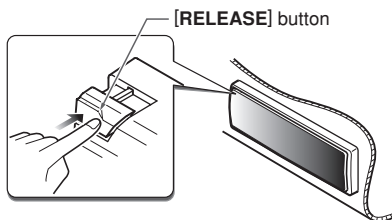

* The DCP is unlocked

3. Remove the DCP.

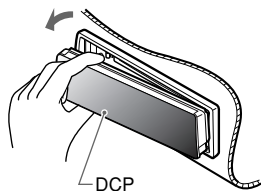

Attaching the DCP

1. Insert the right side of the DCP into the main unit.
2. Insert the left side of the DCP into the main unit.

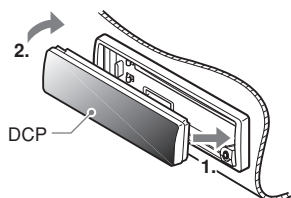

Storing the DCP in the DCP Case

Hold the DCP, in the orientation as shown in the figure below, and put it into the supplied DCP case. (Ensure the DCP is in the correct orientation.)

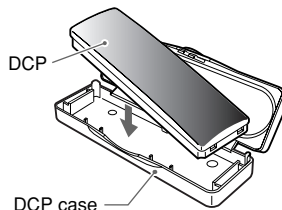

CAUTION

- The DCP can easily be damaged by shocks. After removing it, be careful not to drop it or subject it to strong shocks.
- When the **[RELEASE]** button is pressed and the DCP is unlocked, the car's vibrations may cause it to fall. To prevent damage to the DCP, always store it in its case after detaching it. (See figure below.)
- The connector connecting the main unit and the DCP is an extremely important part. Be careful not to damage it by pressing on it with fingernails, pens, screwdrivers, etc.

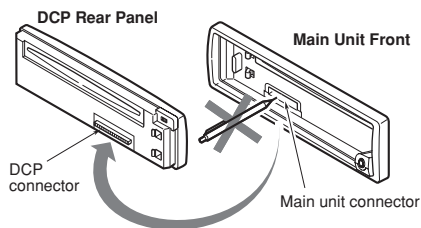

Note:

- If the DCP is dirty, wipe off the dirt with a soft, dry cloth only.

5. REMOTE CONTROL

* If you buy the RCB-176-200 sold separately, you can enjoy the use of the Remote Control function.

Inserting the Battery

- ① Turn over the remote control unit and slide the cover in the direction indicated by the arrow in the illustration.
- ② Insert the battery (CR2025) into the insertion guides, with the printed side (+) facing upwards.
- ③ Press the battery in the direction indicated by the arrow so that it slides into the compartment.
- ④ Replace the cover and slide in until it clicks into place.

Notes:

Misuse may result in rupture of the battery, producing leakage of fluid and resulting in personal injury or damage to surrounding materials. Always follow these safety precautions:

- Use only the designated battery.
- When replacing the battery, insert properly, with +/- polarities oriented correctly.
- Do not subject battery to heat, or dispose of in fire or water. Do not attempt to disassemble the battery.
- Dispose of used batteries properly.

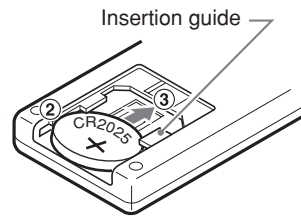
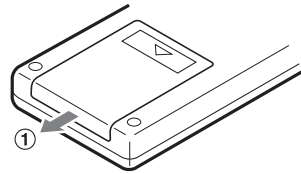

Functions of Remote Control Unit Buttons

* Some buttons on the remote control unit have different functions from the corresponding buttons on the main unit.

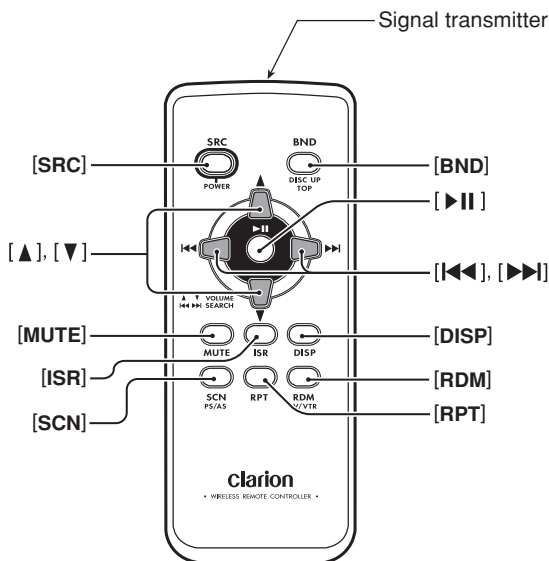

● Shared modes

[SRC] button

- Press the button to turn on the power.
Press and hold the button for 1 second or longer to turn off the power.
- Use to alternate operation mode among the various modes.

[▲], [▼] buttons

- Increases and decreases volume.

[MUTE] button

- Turns mute function on and off.

[ISR] button

- Recalls ISR radio station stored in memory.
- Press and hold the button for 2 seconds or longer to store current station in ISR memory (radio mode only).

[DISP] button

- Press to alternate between main display, title display and clock time display.

● Radio/Satellite Radio modes

[BND] button

- Switches reception band.

[◀◀], [▶▶] buttons

- Moves preset channels up and down.

[SCN] button

- Press to perform preset scan.
- Press and hold the button for 2 seconds or longer to perform auto store.
- In the Satellite Radio mode, press once to perform category scan; hold depressed for 1 second or longer to perform preset scan.

Functions of Remote Control Unit Buttons

● CD/MP3/WMA modes

[BND] button

- Press to play the first track.

[◀◀], [▶▶] buttons

- Press to move the tracks up and down.
- Press and hold the button for 1 second or longer to perform fast-forward/fast-backward.

[▶||] button

- Switches between playback and pause.

[SCN] button

- Press to perform scan play.
- When in MP3/WMA mode, press and hold the button for 1 second or longer to perform folder scan play.

[RPT] button

- Press to perform repeat play.
- When in MP3/WMA mode, press and hold the button for 1 second or longer to perform folder repeat play.

[RDM] button

- Press to perform random play.
- When in MP3/WMA mode, press and hold the button for 1 second or longer to perform folder random play.

● CD changer/DVD changer modes

[BND] button

- Press to switch to next disc in ascending order.

[◀◀], [▶▶] buttons

- Press to move the tracks up and down.
- Press and hold the button for 1 second or longer to perform fast-forward/fast-backward.

[▶||] button

- Switches between playback and pause.

[SCN] button

- Press to perform scan play.
- Press and hold the button for 1 second or longer to perform disc scan play.

[RPT] button

- Press to perform repeat play.
- Press and hold the button for 1 second or longer to perform disc repeat play.

[RDM] button

- Press to perform random play.
- Press and hold the button for 1 second or longer to perform disc random play.

● iPod BB mode

[◀◀], [▶▶] buttons

- Press to move the tracks up and down.
- Press and hold the button for 1 second or longer to perform fast-forward/fast-backward.

[▶||] button

- Switches between playback and pause.

[RPT] button

- Press to perform repeat play.
- Press and hold the button for 1 second or longer to perform all repeat play.

[RDM] button

- Press to perform random play.
- Press and hold the button for 1 second or longer to perform all random play.

● TV mode

[BND] button

- Switches reception band.

[◀◀], [▶▶] buttons

- Moves preset channels up and down.

[SCN] button

- Press to perform preset scan.
- Press and hold the button for 2 seconds or longer to perform auto store.

[RDM] button

- Press to alternate between TV and VTR.

6. OPERATIONS

Note:

- Be sure to read this chapter referring to the front diagrams of chapter "CONTROLS" on page ii (unfold).

Basic Operations

⚠ CAUTION

Be sure to lower the volume before switching off the unit power or the ignition key. The unit remembers its last volume setting. If you switch the power off with the volume up, when you switch the power back on, the sudden loud volume may hurt your hearing and damage the unit.

Turning on/off the power

Note:

- Be careful about using this unit for a long time without running the engine. If you drain the car's battery too far, you may not be able to start the engine and this can reduce the service life of the battery.

1. Press the [SRC] button.
2. Press and hold the [SRC] button for 1 second or longer to turn off the power for the unit.

Note:

- System check
The first time this unit is turned on after the wire connections are completed, it must be checked what equipment is connected. When the power is turned on, the "S-CHECK" appears in the display, then the unit returns to the clock display mode. The system check starts within the unit. When the system check is complete, press the [SRC] button again.

Selecting a mode

1. Press the [SRC] button to change the operation mode.
2. Each time you press the [SRC] button, the operation mode changes in the following order:
Radio → (Satellite radio) → CD/MP3/WMA → (iPod BB) → (CD changer) → (DVD changer) → (TV) → AUX → Radio...
* External equipment not connected with CeNET is not displayed.

Adjusting the volume

1. Turning the [ROTARY] knob clockwise increases the volume; turning it counterclockwise decreases the volume.
* The volume level is from 0 (minimum) to 33 (maximum).

Switching the display

Press the [D] button to select the desired display.









- * If the button operation is performed with the screen saver function on, the operation display corresponding to the button operation is shown for about 30 seconds and the display returns to the screen saver display.

For details, refer to the subsection "Turning the screen saver function on or off" in section "Operations Common to Each Mode".

Sound Adjustment

You can adjust a sound effect or tone quality to your preference.

To change sound setting



1. Press the [] button to switch to the sound adjustment selection display.
 - * The factory default sound setting is "Z-EHCR".
2. Then press the [] or [] button to select the sound adjustment mode. Each time you press the [] or [] button, the sound adjustment mode changes as following order:
 "Z-EHCR" ↔ "BASS" ↔ "TREBLE" ↔ "BALANCE" ↔ "FADER" ↔ "REAR/S-W" ↔ "S-W VOL" ↔ "HPF"
 The sound adjust mode will be display for 2 seconds before showing the sound setting.
3. Press the [] or [] button to adjust the selected audio mode.
 - * In the case of display blinking "ENT", you can press the [] button to adjust the setting value.
4. After completing settings, press the [] button to return to the previous mode.

● Setting the Z-Enhancer





This unit are provided with 3 types of sound tone effects stored in memory.

Select the one you prefer.





* The factory default setting is "OFF".

- 2-1. Select "Z-EHCR".
- 3-1. Each time you press the [] or [] button, the tone effect changes in the following order:
 "EXCITE" ↔ "IMPACT" ↔ "B-BOOST" ↔ "OFF"
EXCITE : bass and treble emphasized
 mid deemphasized
IMPACT : bass and treble emphasized
B-BOOST : bass emphasized
OFF : no sound effect





When "EXCITE" is set:

- 3-2. Press the [] button.
- 3-3. Press the [] or [] button to adjust the bass and treble in the range of +3 to -3.
 - * The factory default setting is "0".
- 3-4. Press the [] button to return to previous mode.

When "IMPACT" is set:



- 3-2. Press the [] button.
- 3-3. Press the [] or [] button to adjust the bass and treble in the range of +3 to -3.
 - * The factory default setting is "0".
- 3-4. Press the [] button to return to previous mode.

When "B-BOOST" is set:

- 3-2. Press the [] button.
- 3-3. Press the [] or [] button to adjust the bass in the range of +3 to -3.
 - * The factory default setting is "0".
- 3-4. Press the [] button to return to previous mode.



● Adjusting the bass

This adjustment can be performed only when the Z-Enhancer is set to "OFF".



- 2-1. Select "BASS".
- 3-1. Press the [] or [] button to adjust the bass.
 - * The factory default setting is "0".
(Adjustment range: +8 to -8)

● Adjusting the treble

This adjustment can be performed only when the Z-Enhancer is set to "OFF".

- 2-1. Select "TREBLE".
- 3-1. Press the [] or [] button to adjust the treble.
 - * The factory default setting is "0".
(Adjustment range: +7 to -7)

● Adjusting the balance

- 2-1. Select "BALANCE".
- 3-1. Press the [] or [] button to adjust the balance of the right and left speakers.
 - * The factory default setting is "CENTER" (center). (Adjustment range: RIGHT12 to LEFT12 (right 12 to left 12))

Basic Operations

● Adjusting the fader

2-1. Select "FADER".

3-1. Press the [▲] or [▼] button to adjust the balance of the rear and front speakers.

- * The factory default setting is "CENTER" (center). (Adjustment range: FRONT12 to REAR12 (front 12 to rear 12))

● Setting the subwoofer (DXZ375MP only)

You can set the low pass filter of subwoofer.

2-1. Select "REAR/S-W".

3-1. Each time you press the [▲] or [▼] button to select the setting, the setting changes in the following order:

"LPF 120" ↔ "LPF 80" ↔ "LPF 50" ↔ "REAR"

- * The factory default setting is "REAR" (rear).

● Adjusting the subwoofer output volume (DXZ375MP only)

You can adjust the volume output from the unit's subwoofer output terminal.

This adjustment can be performed only when the "REAR/S-W" is set to "LPF 120", "LPF 80" or "LPF 50".

2-1. Select "S-W VOL".

3-1. Press the [▲] or [▼] button to increases or decreases the subwoofer volume.

- * The factory default setting is "0". (Adjustment range: +6 to -6)
- * When the volume level is more than 30, the subwoofer volume adjustment value can not reach +6.

● Adjusting the high pass filter (DXZ375MP only)

2-1. Select "HPF".

3-1. Each time you press the [▲] or [▼] button to select the setting.

The setting changes in the following order: "120Hz" ↔ "THROUGH"

- * The factory default setting is "THROUGH" (through).

● Setting the MAGNA BASS EXTEND

The MAGNA BASS EXTEND does not adjust the low frequencies like the normal sound adjustment function, but emphasizes the deep bass frequencies to provide you with a dynamic sound.

- * The factory default setting is "OFF" (off).

1. Press and hold the [↵] button for 1 second or longer to turn on the MAGNA BASS EXTEND effect. "M-B EX" lights in the display.
2. Press and hold the [↵] button for 1 second or longer to turn off the MAGNA BASS EXTEND effect. "M-B EX" goes off.

Note:

- During SOUND adjustment mode, if no operation is performed for more than 10 seconds, this mode can be cancelled and return to previous mode.

Radio Operations

Listening to the radio

1. Press the [SRC] button and select the radio mode. The frequency appears in the display.
2. Press the [BND] button and select the radio band. Each time the button is pressed, the radio reception band changes in the following order:
F1 (FM1) → F2 (FM2) → F3 (FM3) → AM → F1 (FM1)...
3. Press the [◀◀] or [▶▶] button to tune in the desired station.

Tuning

There are 3 types of tuning mode available, seek tuning, manual tuning and preset tuning.

Seek tuning

1. Press the [BND] button and select the desired band (FM or AM).
 - * If "MANU" is lit in the display, press and hold the [BND] button for 1 second or longer. "MANU" in the display goes off and seek tuning is now available.
2. Press the [◀◀] or [▶▶] button to automatically seek a station.
 When the [▶▶] button is pressed, the station is sought in the direction of higher frequencies; if the [◀◀] button is pressed, the station is sought in the direction of lower frequencies.

Manual tuning

There are 2 ways available: Quick tuning and step tuning.

When you are in the step tuning mode, the frequency changes one step at a time. In the quick tuning mode, you can quickly tune the desired frequency.

1. Press the [BND] button and select the desired band (FM or AM).
 - * If "MANU" is not lit in the display, press and hold the [BND] button for 1 second or longer. "MANU" is lit in the display and manual tuning is now available.
2. Tune into a station.

● Quick tuning

Press and hold the [◀◀] or [▶▶] button for 1 second or longer to tune in a station.

● Step tuning

Press the [◀◀] or [▶▶] button to manually tune in a station.

Recalling a preset station

A total of 24 preset positions (6-FM1, 6-FM2, 6-FM3, 6-AM) exists to store individual radio stations in memory. Pressing the corresponding [DIRECT] button or the [▲] / [▼] button recalls the stored radio frequency automatically.

1. Press the [BND] button and select the desired band (FM or AM).
2. Press the corresponding [DIRECT] button or the [▲] / [▼] button to recall the stored station.

Note:

- Press and hold one of the [DIRECT] buttons for 2 seconds or longer to store that station into preset memory.

Manual memory

1. Select the desired station with seek tuning or manual tuning.
2. Press and hold one of the [DIRECT] buttons for 2 seconds or longer to store the current station into preset memory.

Auto store

Auto store is a function for storing up to 6 stations that are automatically tuned in sequentially. If 6 receivable stations cannot be received, a previously stored station remains unoverwritten at the memory position.

1. Press the [BND] button and select the desired band (FM or AM).
2. Press and hold the [ENT] button for 2 seconds or longer. The stations with good reception are stored automatically to the preset channels.

Radio Operations

Preset scan

Preset scan receives the stations stored in preset memory in order. This function is useful when searching for a desired station in memory.

1. Press the **[▶]]** button.
2. When a desired station is tuned in, press the **[▶]]** button again to continue receiving that station.

Note:

- Be careful not to press and hold the **[▶]]** button for 2 seconds or longer, otherwise the auto store function is engaged and the unit starts storing stations.

Instant station recall (ISR)

Instant station recall is a special radio preset that instantly accesses a favorite radio station at a touch of a button. The ISR function even operates with the unit in other modes.

● ISR memory

1. Select the station that you wish to store in ISR memory.
2. Press and hold the **[ISR]** button for 2 seconds or longer.

● Recalling a station with ISR

In any mode, press the **[ISR]** button to turn on the radio function and tune the selected radio station. "ISR" appears in the display. Press the **[ISR]** button again to return to the previous mode.

MP3/WMA

What is MP3?

MP3 is an audio compression method and classified into audio layer 3 of MPEG standards. This audio compression method has penetrated into PC users and become a standard format.

This MP3 features the original audio data compression to about 10 percent of its initial size with a high sound quality. This means that about 10 music CDs can be recorded on a CD-R disc or CD-RW disc to allow a long listening time without having to change CDs.

What is WMA?

WMA is the abbreviation of Windows Media Audio, an audio file format developed by Microsoft Corporation.

Notes:

- If you play a file with DRM (Digital Rights Management) for WMA remaining ON, no audio is output (The WMA indicator blinks).
- Windows Media™, and the Windows® logo are trademarks, or registered trademarks of Microsoft Corporation in the United States and/or other countries.

● To disable DRM (Digital Rights Management)

1. When using Windows Media Player 8, click on TOOLS → OPTIONS → COPY MUSIC tab, then under COPY SETTINGS, unclick the check box for PROTECT CONTENT. Then, reconstruct files.
2. When using Windows Media Player 9, click on TOOL → OPTIONS → MUSIC RECORD tab, then under Recording settings, unclick the Check box for RECORD PROTECTED MUSIC. Then, reconstruct files.
Personally constructed WMA files are used at your own responsibility.

Precautions when creating MP3/WMA disc

● Usable sampling rates and bit rates

1. MP3: Sampling rate 8 kHz-48 kHz,
Bit rate: 8 kbps-320 kbps / VBR
2. WMA: Bit rate 48 kbps-192 kbps

● File extensions

1. Always add a file extension “.MP3” or “.WMA” to MP3 or WMA file by using single byte letters. If you add a file extension other than specified or forget to add the file extension, the file cannot be played.
2. Files without MP3/WMA data will not play. The indication “- -: -” appears in the play time display if you attempt to play files without MP3/WMA data.

● Logical format (File system)

1. When writing MP3/WMA file on a CD-R disc or CD-RW disc, please select “ISO9660 level 1, 2 or JOLIET or Romeo” as the writing software format. Normal play may not be possible if the disc is recorded on another format.
2. The folder name and file name can be displayed as the title during MP3/WMA play but the title must be within 64 single byte alphabetical letters and numerals (including an extension).
3. Do not affix a name to a file inside a folder having the same name.

● Folder structure

1. A disc with a folder having more than 8 hierarchical levels will be impossible.

● Number of files or folders

1. Up to 255 files can be recognized per folder. Up to 510 files can be played.
2. Tracks are played in the order that they were recorded onto a disc. (Tracks might not always be played in the order displayed on the PC.)
3. Some noise may occur depending on the type of encoder software used while recording.

CD/MP3/WMA Operations

Set the type of file to be played (multi-session function)

When a single disc holds both normal CD type tracks and MP3/WMA type tracks, use this command to select which type of track to play.

* Default setting is "M-SESS CD".

- When only one type of track (either music CD or MP3/WMA) is recorded on a disc, selecting either type will allow playback of the disc.
 - When playing CCCD (copy-control CDs), set to CD type.
1. Press and hold the [BND] button for 1 second or longer.

Each time the button is held pressed in this way "M-SESS" will be displayed for 1 second, then "CD" or "MP3" appears in the display, the playback type alternates between CD type and MP3/WMA type.

• M-SESS CD

When playing music CD only.

• M-SESS MP3

When playing music MP3/WMA only.

2. When setting is completed, remove the disc and reinsert it.

Disc-In-Play function

As long as the ignition key is turned to the ON or ACC position, this function allows you to turn the power to the unit and start playing the disc automatically when the disc is inserted even if the power is not turned on.

⚠ CAUTION

- Do not try to put your hand or fingers in the disc insertion slot. Also never insert foreign objects into the slot.
- Do not insert discs where adhesive comes out from cellophane tape or a rental CD label, or discs with marks where cellophane tape or rental CD labels were removed. It may be impossible to extract these discs from the unit and they may cause the unit to break down.

Ejecting a CD

1. Press the [▲] to eject the CD. Take it out from the ejected position. "EJECT" appears in the display.

Notes:

- If a CD (12 cm) is left in the ejected position for 15 seconds, the CD is automatically reloaded. (Auto reload)
- If you force a CD into before auto reloading, this can damage the CD.

Listening to a disc already loaded in the unit

Press the [SRC] button to select the CD/MP3/WMA mode.

When the unit enters the CD/MP3/WMA mode, play starts automatically.

If there is no disc loaded, the indication "NO DISC" appears in the display.



The mode changes each time the [SRC] button is pressed. (Modes are not displayed for equipment that is not connected.)

Radio → (Satellite radio) → CD/MP3/WMA → (iPod BB) → (CD changer) → (DVD changer) → (TV) → AUX → Radio ...

Loading a CD

1. Insert a CD into the centre of the CD SLOT with the labeled side facing up. "LOADING" appears in the display, the CD enters into the slot, and the play starts.

Notes:

- Never insert foreign objects into the CD SLOT.
- If the CD is not inserted easily, there may be another CD in the mechanism or the unit may require service.
- Discs not bearing the  or  mark and CD-ROMs cannot be played by this unit.
- Some CDs recorded in CD-R/CD-RW mode may not be usable.

Pausing play

1. Press the [▶||] button to pause play.
"PAUSE" appears in the display.
2. To resume CD play, press the [▶||] button again.

Displaying CD titles

This unit can display title data for CD-text/MP3/WMA disc and user titles input with this unit.

1. Each time you press the [D] button to change the title display.

● CD-TEXT disc

User → Track → Disc → Artist → User ...

● MP3/WMA disc

Track → Folder → Title → Album → Artist → Track ...

Notes:

- If the CD playing is not a CD-text CD or no user title has been input, "NO TITLE" appears in the display.
- If MP3/WMA disc is not input TAG, "NO TAG" appears in the display.
- For MP3, supports ID3 Tags V2.3 / 2.2 / 1.1 / 1.0.
- Tag displays give priority to V2.3 / 2.2.
- In the case of album Tags for WMA, the information written into the extension header is displayed.
- Only ASCII characters can be displayed in Tags.

Selecting a track

● Track-up

1. Press the [▶▶] button to move ahead to the beginning of the next track.
2. Each time you press the [▶▶] button, the track advances ahead to the beginning of the next track.

● Track-down

1. Press the [◀◀] button to move back to the beginning of the current track.
2. Press the [◀◀] button twice to move back to the beginning of the previous track.

Fast-forward/fast-backward

● Fast-forward

1. Press and hold the [▶▶▶] button for 1 second or longer.

● Fast-backward

1. Press and hold the [◀◀◀] button for 1 second or longer.

* For MP3/WMA discs, it takes some time until the start of searching and between tracks. In addition, the playing time may have a margin of error.

Folder Select

This function allows you to select a folder containing MP3/WMA files and start playing from the first track in the folder.

1. Press the [▼] or [▲] button.
Press the [▲] button to move the next folder. Press the [▼] button to move the previous folder.
2. To select a track, press the [◀◀] or [▶▶] button.

Top function

The top function resets the CD player to the first track of the disc. Press the [BND] button to play the first track (track No. 1) on the disc.

* In case of MP3/WMA, the first track of a folder being played will be returned.

Other various play functions**● Scan play**

This function allows you to locate and play the first 10 seconds of all the tracks recorded on a disc.

1. Press the **[SCN]** button to perform scan play. "TRK SCN" appears in the display.

* Scan play starts from the next track after the track currently being played.

● Folder scan play

This function allows you to locate and play the first 10 seconds of the first track of all the folders on an MP3/WMA disc.

1. Press and hold the **[SCN]** button for 1 second or longer to perform folder scan play. "ALL SCN" appears in the display.

* Folder scan play starts from the next folder after the folder currently being played.

● Repeat play

This function allows you to play the current track repeatedly.

1. Press the **[RPT]** button to perform repeat play. "TRK RPT" appears in the display.

● Folder repeat play

This function allows you to play a track currently being played in the MP3/WMA folder repeatedly.

1. Press and hold the **[RPT]** button for 1 second or longer to perform folder repeat play.

"ALL RPT" appears in the display.

● Random play

This function allows you to play all tracks recorded on a disc in a random order.

1. Press the **[RDM]** button to perform random play.

"TRK RDM" appears in the display.

● Folder random play

This function allows you to play all the tracks of all the folders recorded on an MP3/WMA disc in a random order.

1. Press and hold the **[RDM]** button for 1 second or longer to perform folder random play.

"ALL RDM" appears in the display.

● To cancel play

1. Press the operating button previously selected.

To change adjustment setting

1. Press and hold the [D] button for 1 second or longer to switch to the adjustment selection display.
2. Press the [◀◀] or [▶▶] button to select the "item name".
 "CLOCK" ↔ "SCRN SVR" ↔ "MSG INP"
 ↔ "SCROLL" ↔ "DIMMER" ↔ "A-CANCEL"
 ↔ "TEL-SP" ↔ "TEL-SW" ↔ "S-CHECK"
 * The adjustment item name will be display for 2 seconds before showing the desired value.
3. Press the [▲] or [▼] button to select the "desired setting value".
 * In the case of display blinking "ENT", you can press the [▶▶] button to adjust the setting value.
 * After completing settings, press the [D] button to return to the previous mode.

● Setting the clock

- 2-1. Select "CLOCK".
- 3-1. Press the [▶▶] button
- 3-2. Press the [◀◀] or [▶▶] button to select the hour or the minute.
- 3-3. Press the [▲] or [▼] button to set the correct time.
 * The clock is displayed in 12-hour format.
- 3-4. Press the [▶▶] button to store the time into memory.

Note:

- You cannot set the clock when it is displayed with only the ignition on. If you drain or remove the car's battery or take out this unit, the clock is reset. While setting the clock, if another button or operation is selected, the clock set mode is canceled.

● Turning the screen saver function on or off

This unit is provided with the screen saver function which allows you to show various kinds of patterns and characters in the operation status indication area of the display in a random order. You can turn on or off this function. If the button operation is performed with the screen saver function on, the operation display corresponding to the button operation is shown for about 30 seconds and the display returns to the screen saver display.

* The factory default setting is "ON".

- 2-1. Select "SCRN SVR".

- 3-1. Press the [▲] or [▼] button to select the setting.

Each time you press the [▲] or [▼] button, the setting changes in the following order:

"MESSAGE" ↔ "ON" ↔ "OFF"

● Entering message information

Message up to 30 characters long can be stored in memory and displayed as a type of screen saver setting.

* The factory default setting is "WELCOME TO CLARION".

- 2-1. Select "MSG INP".

- 3-1. Press the [▶▶] button.

- 3-2. Press and hold the [BND] button for 1 second or longer to clear the old message.

- 3-3. Press the [◀◀] or [▶▶] button to move the cursor.

- 3-4. Press the [BND] button to select a character type. Each time you press the [BND] button, the character type changes in the following orders:

Capital letters → Numbers → Symbols → Capital letters...

- 3-5. Press the [▲] or [▼] button to select the desired character.

- 3-6. Repeat step 3-3 to 3-5 to enter up to 30 characters for message.

- 3-7. Press and hold the [▶▶] button for 2 seconds or longer to store the message in memory.

* Press and hold the [BND] button for 1 second or longer to cancel the input message. Then press and hold the [▶▶] button for 2 seconds or longer to store the message and the message return to default setting.

Operations Common to Each Mode

● Setting the method for title scroll

Set how to scroll in CD-TEXT, MP3/WMA title.

* The factory default setting is "ON".

2-1. Select "**SCROLL**".

3-1. Press the [▲] or [▼] button to select "**ON**" or "**OFF**".

• **ON:**

To scroll automatically.

• **OFF:**

To scroll just 1 time.

● Setting the dimmer control

You can set the dimmer control "ON" or "OFF".

* The factory default setting is "ON".

2-1. Select "**DIMMER**".

3-1. Press the [▲] or [▼] button to select "**ON**" or "**OFF**".

● Setting the external amplifier

* The factory default setting is "OFF".

2-1. Select "**A-CANCEL**".

3-1. Press the [▲] or [▼] button to select "**ON**" or "**OFF**".

• **ON:**

Use with connected AMP.

• **OFF:**

Use with inside AMP.

● Setting the car speaker output for the cellular phone

* The factory default setting is "RIGHT".

* To output the telephone calls, set the cellular phone interrupt to "ON".

When the AUX input jack is used to connect an AUX BLUETOOTH BB (BLT370) (sold separately):

2-1. Select "**TEL-SP**".

3-1. Press the [▲] or [▼] button to select "**RIGHT**" or "**LEFT**".

• **RIGHT:**

Telephone calls can be heard on the front right speaker connected to this unit.

• **LEFT:**

Telephone calls can be heard on the front left speaker connected to this unit.

● Cellular phone interrupt setting

If you connect this unit and your cellular phone with a separately sold cable, you can listen to your telephone calls on your car speakers.

* The factory default setting is "OFF".

When the AUX input jack is used to connect an AUX BLUETOOTH BB (BLT370) (sold separately):

2-1. Select "**TEL-SW**".

3-1. Press the [▲] or [▼] button to select the setting. Each time you press the [▲] or [▼] button, the setting changes in the following order:

"OFF" ↔ "ON" ↔ "MUTE"

• **OFF:**

This unit continues normal operation even when the cellular phone is used.

• **ON:**

You can listen to your telephone calls from the speakers connected to this unit.

* When listening to your calls on your car speakers, you can adjust the volume by turning the [ROTARY] knob.

• **MUTE:**

The sound from this unit is muted during telephone calls.

Note:

• If connecting a hands-free kit, please ensure the setting is ON to receive the telephone audio through the system.

● Performing a system check

This function allows you to perform a system check from the adjust mode when required.

2-1. Select "**S-CHECK**".

3-1. Press and hold the [ENT] button for 1 second or longer.

"S-CHECK" appears in the display, then the unit returns to the previous operation mode.

Operations Common to Each Mode

Entering titles

Titles up to 8 characters long can be stored in memory and displayed for CD, CD changer, Radio stations and TV stations. The number of titles that can be entered for each mode are as follows.

Mode	Number of titles
CD mode	50 titles
TV mode	20 titles
Radio mode	30 titles

CD changer mode	Number of titles
DCZ625 connected	100 titles

1. Press the **[SRC]** button to select the mode you want to enter a title (Radio, CD, CD changer or TV).
2. Select and play a CD in the CD changer or tune in to a TV station or Radio for which you want to enter the title.
3. Press and hold the **[D]** button for 1 second or longer to switch to the adjustment selection display.
4. Press the **[◀◀]** or **[▶▶]** button to select "TITLE IN".
5. Press the **[ENT]** button.
The display switches to the title input display.
6. Press the **[◀◀]** or **[▶▶]** button to move the cursor.
7. Press the **[BND]** button to select a character type. Each time you press the **[BND]** button, the character type changes in the following order:
Capital letters → Numbers → Symbols → Capital letters...
8. Press the **[▲]** or **[▼]** button to select the desired character.
9. Repeat steps 6 to 8 to enter up to 8 characters for the title.
10. Press and hold the **[ENT]** button for 2 seconds or longer to store the title into memory.

Clearing titles

1. Select and play a CD in the CD changer or tune in to a TV station or Radio for which you want to clear the title.
2. Press and hold the **[D]** button for 1 second or longer to switch to the adjustment selection display.
3. Press the **[◀◀]** or **[▶▶]** button to select "TITLE IN".
4. Press the **[ENT]** button.
The display switches to the title input display.
5. Press and hold the **[BND]** button for 1 second or longer.
All characters in the title disappear.
6. Press and hold the **[ENT]** button for 2 seconds or longer to store the setting.

AUX function

This system has an external input jack on the front panel so you can listen to sounds and music from external devices connected to this unit.

● Selecting AUX IN sensitivity

Make the following settings to select the sensitivity when sounds from external devices connected to this unit are difficult to hear even after adjusting the volume.

* The factory default setting is "MID".

1. Press and hold the **[DISP]** button for 1 second or longer.
2. Select "AUX SENS".
3. Press the **[▲]** or **[▼]** button to select "LOW", "MID" or "HIGH".

7. OPERATIONS OF ACCESSORIES

iPod BB Operations

● iPod BB

This section describes operations when connected to a CeNET iPod Interface (EA-1276B). (Hereinafter, "iPod Interface (EA-1276B)" is abbreviated as iPod BB.)

Note:

- See the iPod BB Owner's Manual for details regarding iPod BB connections and operation conditions.

Connecting an iPod

When an iPod is connected to the iPod BB interface, the "Repeat" set on the iPod will become "All repeat play" instead. Likewise, "Shuffle" set on the iPod will become as follows:

- "Shuffle (Albums)" play → Random play
- "Shuffle (Songs)" play → All random play

The iPod BB interface has two modes, the "Play mode" and the "iPod menu mode" for selecting tracks. Switch between these modes by pressing the [BND] button.

Select iPod BB Interface

1. Press the [SRC] button.

Playback will begin from the last file that was played on the iPod alone or through the iPod BB.

Note:

- The following operations in Play mode operate the same as in CD mode:

* **Track selection:** [◀◀], [▶▶]

* **Fast-forward/fast-backward:** [◀◀], [▶▶]

* **Pause:** [⏸]

See "CD/MP3/WMA Operations" (page 15-18) for details.

Other various play functions (in Play mode)

Notes:

- These functions are not supported when in the iPod menu mode.
- The Random function set on the iPod or when connected to iPod BB, remains the same after attachment/ detachment of the iPod.
- The iPod BB can be set simultaneously for All repeat and All random. The display will appear as follows:

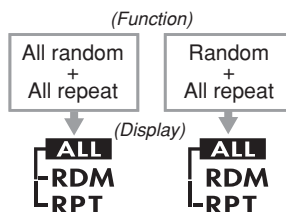

● Repeat play

Play back one track repeatedly.

1. Press the [RPT] button.

● All repeat play

Repeatedly play all tracks within a selected category.

1. Press and hold the [RPT] button for 1 second or longer.

● Random play

Play all albums within a selected category, in random order. (Corresponds to "Shuffle (Albums)" command on iPod.)

1. Press the [RDM] button.

● All random play

Play all tracks within a selected category, in random order. (Corresponds to "Shuffle (Songs)" command on iPod.)

1. Press and hold the [RDM] button for 1 second or longer.

● To cancel play

1. Press the same play button once again.

Note:

- When the all repeat play mode is canceled, playback will stop when all tracks have been played.

Selecting category from the iPod menu

1. Press the [BND] button to select the iPod menu mode.
The iPod menu categories will be displayed.

Note:

- Repeat and Random mode operations are not supported when in the iPod menu mode.
2. Press the [▲] or [▼] button to switch between categories.
The iPod menu categories alternate in the following order:
"PLAY LIST" ↔ "COMPOSER" ↔ "GENRE"
↔ "SONG" ↔ "ALBUM" ↔ "ARTIST" ↔ ...

Note:

The iPod menu mode can be canceled by performing one of the following operations:

- Press the [BND] button.
 - When the category select screen is displayed, press the [▶▶] button.
3. Press the [▶▶] button to select the category.
 4. When the track name display is showing, press the [▶▶] button.
Playback will begin from the first track in the selected category, and the iPod menu mode will be canceled.
 - * Subfolders may be displayed, depending on the category.
In this case, use the [▲] and [▼] buttons to switch between subfolders, then use the [▶▶] button to select the desired subfolder.
 - * When the track name display is showing, pressing the [◀◀] button will return to the currently playing folder name display.
 5. Use the [▲] and [▼] buttons to select a track within a category.

Selecting category using preset memory

1. Press the [BND] button to select the iPod menu mode.

The category can be set as follows in the [DIRECT] (1-6) buttons.

- [1] : PLAY LIST
- [2] : ARTIST
- [3] : ALBUM
- [4] : SONG
- [5] : GENRE
- [6] : COMPOSER

2. Press the desired [DIRECT] (1-6) button to select the category.
 - * Subfolders may be displayed, depending on the category.
In this case, use the [▲] and [▼] buttons to switch between subfolders, then use the [▶▶] button to select the desired subfolder.
3. When the track name display is showing, press the [▶▶] button.
Playback will begin from the first track in the selected category, and the iPod menu mode will be canceled.
 - * Use the [▲] and [▼] buttons to select a track within a category.

About title display

This unit supports the display of title information transmitted from a connected iPod.

- Character code information is UTF-8; displayable characters include English alphanumerics, some symbols, and some umlaut characters.
- Unsupported characters will be replaced by asterisks (*).

Satellite Radio Operations

This function is available when a Satellite Radio Receiver is connected through the CeNET cable.

This unit can control the following satellite radio receivers:

- XM Satellite Radio Receiver: XMD1000
- XM Smart Digital Adapter: XM SDA
- SIRIUS Satellite Radio Receiver: SIRCL2, SIRCL3

Note:

• When the function is differ depending to the connected receiver, they are distinguished by the following notations:

“XM”: for an XM Satellite Radio Receiver

“SIRIUS”: for a SIRIUS Satellite Radio Receiver

Selecting a Satellite Radio mode

1. Press the [SRC] button.

The system changes to the specified Satellite Radio mode.

Selecting a band

1. Press the [BND] button to select a band.

This changes the reception band as follows:

- **XM:** XM1 → XM2 → XM3 → XM1 ...
- **SIRIUS:** SR1 → SR2 → SR3 → SR1 ...

● Information displayed during reception

The following information is displayed when the satellite radio cannot be received normally.

- When the receiver is turned on the first time or after a reset: “**UPDATING**”
- When a channel is being tuned in (no signal is yet received):
XM: “**LOADING**”, SIRIUS: “**LINKING**”
- A channel without a broadcast has been selected:
XM: “**--- CH**”, SIRIUS: “**INVLD CH**”
- A channel not covered by your contract:
XM: “**UPDATING**”, SIRIUS: “**CALL 888**” ↔ “**539-SIRI**” (alternated)

Confirming your SIRIUS ID

1. Press and hold the [D] button for 1 second or longer to display the ADJUST item.
2. Press the [◀◀] or [▶▶] button to select “**SID DISP**”.
3. Press the [ENT] button, the display will display the upper 6 digits.
4. Press the [▲] or [▼] button to switch between the display for the upper 6 digits and lower 6 digits.
5. To return to the previous mode, press the [D] button.

Displaying channel labels

1. Press the [D] button to select the desired channel label.
Channel → Category → Title → Artist → Radio text → Channel...

Channel selection

1. Channels are selected with the [◀◀] or [▶▶] button.
* For details, see the following operation descriptions.

Note:

• The audio output is muted and other button operations are not accepted during channel selection.

Tuning mode

There are two channel selection modes: quick tuning mode and step tuning mode.

● Quick tuning

1. Press and hold the [◀◀] or [▶▶] button for 1 second or longer.

● Step tuning

1. Press the [◀◀] or [▶▶] button.

Recalling a preset station

A total of 18 satellite radio stations can be stored.

- **XM:** 6-XM1, 6-XM2 and 6-XM3
- **SIRIUS:** 6-SR1, 6-SR2 and 6-SR3

This allows you to store your favorite satellite radio stations in memory for later recall.

1. Press the [BND] button to select the desired band.
2. Press the [▲] / [▼] button or [DIRECT] button to select the desired preset station.

Preset memory

1. Press the [BND] button to select the desired band.
2. Select the desired channel with quick tuning or step tuning.
3. Press and hold the [DIRECT] button for 2 second or longer to store the current channel into preset memory.

Receiving stations selected by category

Satellite Radio allows you to select broadcast channel category (contents).

1. Press and hold the [BND] button for 1 second or longer to select the category selection mode.
 - * It press once again, return to the channel selection mode.
2. Press the [▲] or [▼] button to change the category item.
3. Press the [◀◀] or [▶▶] button to tune in a station.

Note:

- When the category selection mode is entered, the category of the last received channel is displayed first.
- The category selection mode is canceled when no channel with the selected category can be found.
- The [◀◀] or [▶▶] button are not pressed within 7 seconds, the category selection mode is canceled, and resumes to the channel mode.

Presetting a category

A category can be preset by registering specific categories in [DIRECT] buttons 1 to 6. Then the desired category can be recalled by pressing the corresponding [DIRECT] button.

1. Press and hold the [BND] button for 1 second or longer to enter the category mode.
2. Press the [▲] or [▼] button to select a category.
3. Press and hold one of the [DIRECT] buttons for 2 seconds or longer to store the current category into preset memory.

Notes:

- When the name of a channel stored in memory is changed by a broadcasting channel, the display may show a channel name that differs from the stored name.
- A channel stored in memory may be discontinued at the option of the broadcasting channel.
- If no operation is performed for more than 1 second, category seek tuning can automatically tune in a receivable broadcast channel category.

Scan function

There are two scan modes: the category scan mode and the preset scan mode.

During scanning channels are displayed in abbreviated form, the display mode cannot be switched.

● Category scanning

In a category scan, broadcast channels in the same category as the current channel are selected about every 10 seconds.

1. Press and hold the [BND] button for 1 second or longer to select the channel mode.
2. Press the [▶▶] button to select the category scan mode. And start the category scanning.

Note:

- Category scanning is not available when no category is defined for the current channel.

● Preset scan

A preset scan scans the channels (up to 18 channels) stored in the preset memory about every 10 seconds.

1. Press and hold the [BND] button for 1 second or longer to select the channel mode.
2. Press and hold the [▶▶] button for 1 second or longer to select the preset scan mode. And start the preset scanning.

CD Changer Operations

Note:

- The following operations are the same as for CD mode:

- * **Pause**
- * **Track selection**
- * **Fast-forward/fast-backward**
- * **Scan play**
- * **Repeat play**
- * **Random play**

See “**CD/MP3/WMA Operations**” (page 15-18) for details.

CD changer functions

When an optional CD changer is connected through the CeNET cable, this unit controls all CD changer functions. This unit can control a total of 2 changers.

Press the [SRC] button and select the CD changer mode to start play. If 2 CD changers are connected, press the [SRC] button to select the CD changer for play.

- * If “**NO MAG**” appears in the display, insert the magazine into the CD changer. “**D-CHECK**” appears in the display while the player loads (checks) the magazine.
- * If “**NO DISC**” appears in the display, eject the magazine and insert discs into each slot. Then, reinsert the magazine back into the CD changer.

Note:

- Some CDs recorded in CD-R/CD-RW mode may not be usable.

⚠ CAUTION

CD-ROM discs cannot be played from every CD changer, it's depended on the model.

Displaying CD titles

This unit can display title data for CD-text CDs and user titles input with this unit.

- * Title data for CD-text CDs can be displayed with this unit only when it is connected to DCZ625.

1. Press the [D] button to change the title display.

Notes:

- If the CD playing is not a CD-text CD or no user title has been input, “**NO TITLE**” appears in the display.
- If a CD-text CD is not input its disc title or a track title, “**NO TITLE**” appears in the display.

Procedure to scroll a title

Set “**SCROLL**” to “**ON**” or “**OFF**”.

(The factory default setting is “**ON**”. Refer to the subsection “**Setting the method for title scroll**” in section “**Operations Common to Each Mode**”.)

● When set to “**ON**”

The title is automatically kept scrolling.

● When set to “**OFF**”

To scroll just 1 time.

Selecting a CD

1. Press the [▲] or [▼] button to select the desired disc.

- * If a CD is not loaded in a slot of magazine, pressing the [▲] or [▼] button can not work.

Other various play functions

● Disc scan play

Disc scan play locates and plays the first 10 seconds of the first track on each disc in the currently selected CD changer. This function continues automatically until it is cancelled.

- * Disc scan play is useful when you want to select a desired CD.

1. Press and hold the [SCN] button for 1 second or longer. “**ALL SCN**” appears in the display and disc scan play starts.

● Disc repeat play

After all the tracks on the current disc have been played, disc repeat play automatically replays the current disc over from the first track. This function continues automatically until it is cancelled.

1. Press and hold the [RPT] button for 1 second or longer. “**ALL RPT**” appears in the display and disc repeat play starts.

● Disc random play

The disc random play selects and plays individual tracks or discs automatically in no particular order. This function continues automatically until it is cancelled.

1. Press and hold the [RDM] button for 1 second or longer. “**ALL RDM**” appears in the display and disc random play starts.

● To cancel play

1. Press the operating button previously selected.

DVD Changer Operations

By connecting an optional DVD changer that supports CeNET wiring, this unit can be used to control the DVD changer. To view DVDs, an optional monitor is required.

- The DVD control and display functions supported by this unit are limited; the unit does not support all the functions possible on a DVD changer.

For fullest functionality, use the remote control unit provided with your DVD changer to control its operations. For details, consult the Owner's Manual provided with your DVD changer.

Note:

- The following operations are the same as for CD and CD Changer modes:

- * **Pause**
- * **Track selection**
- * **Fast-forward/fast-backward**
- * **Scan play**
- * **Repeat play**
- * **Random play**

See "**CD/MP3/WMA Operations**" (page 15-18) and "**CD Changer Operations**" (page 26) for details.

TV Operations

Note:

- The following operations are performed the same as for radio mode:

- * **Channel selection**
- * **Storing channels in memory**
- * **Calling channels from memory**
- * **Auto store**
- * **Preset scan**

See "**Radio Operations**" (page 13-14) for details.

TV tuner functions

When an optional TV tuner is connected through the CeNET cable, this unit controls all TV tuner functions. To watch TV requires a TV tuner and monitor.

Watching a TV

1. Press the [SRC] button and select the TV mode.
2. Press the [BND] button to select the desired TV band (TV1 or TV2). Each time the button is pressed, the input selection toggles between TV1 and TV2.
3. Press the [◀◀] or [▶▶] button to tune in the desired TV station.

Watching a video

The TV tuner has a VTR input terminal to which 1 external device can be connected. Connect a 12 V video cassette player (VCP) or video cassette recorder (VCR) to the TV tuner input terminal.

- * The factory default setting is "TV".

1. Press and hold the [D] button for 1 second or longer to switch to the adjustment selection display.
2. Press the [◀◀] or [▶▶] button to select "TV/VTR".
3. Press and hold the [▶▶] button for 1 second or longer to set to "VTR".
4. To return to the TV broadcast, press and hold the [D] button for 1 second or longer to switch to the adjustment selection display.
5. Press the [◀◀] or [▶▶] button to select "TV/VTR".
6. Press and hold the [▶▶] button for 1 second or longer to set to "TV".

Setting the TV diver

You can change the reception setting for the TV antenna connected to the TV tuner.

- * The factory default setting is "ON".

1. Press and hold the [D] button for 1 second or longer to switch to the adjustment selection display.
2. Press the [◀◀] or [▶▶] button to select "TV DIVER".
3. Press the [▲] or [▼] button to set to "ON" or "OFF".
 - **ON:**
Sets the diver setting to ON.
 - **OFF:**
Sets the diver setting to OFF.
4. Press the [D] button to return to the previous mode.

8. IN CASE OF DIFFICULTY

	Problem	Cause	Measure
General	Power does not turn on. (No sound is produced.)	Fuse is blown.	Replace with a fuse of the same amperage. If the fuse blows again, consult your store of purchase.
		Incorrect wiring.	Consult your store of purchase.
	No sound output when operating the unit with amplifiers or power antenna attached.	Power antenna lead is shorted to ground or excessive current is required for remote-on the amplifiers or power antenna.	<ol style="list-style-type: none"> 1. Turn the unit off. 2. Remove all wires attached to the power antenna lead. Check each wire for a possible short to ground using an ohm meter. 3. Turn the unit back on. 4. Reconnect each amplifier remote wire to the power antenna lead one by one. If the amplifiers turn off before all wires are attached, use an external relay to provide remote-on voltage (excessive current required).
	Nothing happens when buttons are pressed. Display is not accurate.	The microprocessor has malfunctioned due to noise, etc.	Turn off the power, then press the [RELEASE] button and remove the DCP. Press the reset button for about 2 seconds with a thin rod.
		DCP or main unit connectors are dirty.	Wipe the dirt off with a soft cloth moistened with cleaning alcohol.
	No sound heard	The speaker protection circuit is operating.	<ol style="list-style-type: none"> 1. Turn down sound volume. Function can also be restored by turning the power off and on again. (Speaker volume is reduced automatically when the speaker protection circuit operates). 2. If the sound is muted again, consult our service department.
CD/MP3/WMA	No sound heard	MP3/WMA files are absent in a disc.	Write MP3/WMA files onto the disc properly.
		Files are not recognized as an MP3/WMA file.	Use MP3/WMA files encoded properly.
		File system is not correct.	Use ISO9660 level 1, 2 or JOLIET or Romeo file system.
	Sound skips or is noisy.	Compact disc is dirty.	Clean the compact disc with a soft cloth.
		Compact disc is heavily scratched or warped.	Replace with a compact disc with no scratches.
	Sound is cut or skipped. Noise is generated or noise is mixed with sound.	MP3/WMA files are not encoded properly.	Use MP3/WMA files encoded properly.
	Sound is bad directly after power is turned on.	Water droplets may form on the internal lens when the car is parked in a humid place.	Let dry for about 1 hour with the power on.
	Wrong filename	File system is not correct.	Use ISO9660 level 1, 2 or JOLIET or Romeo file system.

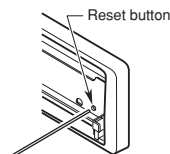

9. ERROR DISPLAYS

If an error occurs, one of the following displays is displayed.
Take the measures described below to eliminate the problem.

	Error Display	Cause	Measure
CD/MP3/WMA	ERROR 2	A CD is caught inside the CD deck and is not ejected.	This is a failure of CD deck's mechanism and consult your store of purchase.
	ERROR 3	A CD cannot be played due to scratches, etc.	Replace with a non-scratched, non-warped-disc.
	ERROR 6	A CD is loaded upside-down inside the CD deck and does not play.	Eject the disc then reload it properly.
CD changer	ERROR 2	A CD inside the CD changer is not loaded.	This is a failure of CD changer's mechanism and consult your store of purchase.
	ERROR 3	A CD inside the CD changer cannot be played due to scratches, etc.	Replace with a non-scratched, non-warped disc.
	ERROR 6	A CD inside the CD changer cannot be played because it is loaded upside-down.	Eject the disc then reload it properly.
DVD changer	ERROR 2	A DISC inside the DVD changer cannot be played.	This is a failure of DVD mechanism and consult your store of purchase.
	ERROR 3	A DISC cannot be played due to scratches, etc.	Retry or replace with a non-scratched, non-warped-disc.
	ERROR 6	A DISC inside the DVD changer cannot be played because it is loaded upside-down.	Eject the disc then reload it properly.
	ERROR P	Parental level error	Set the correct Parental level.
	ERROR R	Region code error	Eject the disc and replace correct region code disc.
iPod	ERROR 1	A communication error occurs between the iPod and the iPod CeNET Controller.	Disconnect the iPod, then connect it again.
	NO IPOD	There is no iPod connected.	Please connect the iPod.

If an error display other than the ones described above appears, press the reset button. If the problem persists, turn off the power and consult your store of purchase.

10. SPECIFICATIONS

FM Tuner

Frequency Range: 87.9 MHz to 107.9 MHz
 Usable Sensitivity: 9 dBf
 50dB Quieting Sensitivity: 15 dBf
 Alternate Channel Selectivity: 70 dB
 Stereo Separation (1 kHz): 35 dB
 Frequency Response (± 3 dB): 30 Hz to 15 kHz

AM Tuner

Frequency Range: 530 kHz to 1710 kHz
 Usable Sensitivity: 25 μ V

CD Player

System: Compact disc digital audio system
 Usable Discs: Compact disc
 Frequency Response (± 1 dB): 5 Hz to 20 kHz
 Dynamic Range (1 kHz): 95 dB
 Harmonic Distortion: 0.01%

Audio

Maximum Power Output: 200 W (50 W \times 4 ch)
 Bass Control Action (100 Hz): +14 dB, -14 dB
 Treble Control Action (10 kHz): +14 dB, -14 dB
 Line Output Level (CD 1 kHz):
 DXZ375MP: 3.6 V
 DXZ275MP: 1.8 V

Note:

- Specifications and design are subject to change without notice for further improvement.

General

Power Supply Voltage:
 14.4 V DC (10.8 to 15.6 V allowable), negative ground
 Current Consumption: Less than 15 A
 Speaker Impedance: 4 Ω (4 Ω to 8 Ω allowable)
 Auto Antenna Rated Current: 500 mA or less
 Weight / Source unit: 2.57 lb. (1.14 kg)
 Dimensions / Source unit:
 7" (Width) \times 2" (Height) \times 6-1/8" (Depth)
 [178 (W) \times 50 (H) \times 155 (D) mm]

Power Output :

19 W RMS \times 4 Channels at 4 Ω
 and 1 % THD+N

Signal to Noise Ratio:

80 dBA (reference: 1 W into 4 Ω)



Clarion Co., Ltd.

All Rights Reserved. Copyright © 2006: Clarion Co., Ltd.
Printed in China / Imprimé en Chine / Impreso en China

PE-2908B
PE-2907B
280-8450-00

2006/12

Free Manuals Download Website

<http://myh66.com>

<http://usermanuals.us>

<http://www.somanuals.com>

<http://www.4manuals.cc>

<http://www.manual-lib.com>

<http://www.404manual.com>

<http://www.luxmanual.com>

<http://aubethermostatmanual.com>

Golf course search by state

<http://golfingnear.com>

Email search by domain

<http://emailbydomain.com>

Auto manuals search

<http://auto.somanuals.com>

TV manuals search

<http://tv.somanuals.com>