

# clarion®

Owner's manual  
Mode d'emploi  
Manual de instrucciones

## DXZ675USB

CD/USB/MP3/WMA/AAC RECEIVER WITH CeNET CONTROL  
AUTORADIO CD/USB/MP3/WMA / AVEC COMMANDE CeNET  
RECEPTOR DE CD/USB/MP3/WMA/AAC CON CONTROL CeNET



This equipment has been tested and found to comply with the limits for a Class B digital device, pursuant to Part 15 of the FCC Rules.

These limits are designed to provide reasonable protection against harmful interference in a residential installation.

This equipment generates, uses, and can radiate radio frequency energy and, if not installed and used in accordance with the instructions, may cause harmful interference to radio communications. However, there is no guarantee that interference will not occur in a particular installation.

If this equipment does cause harmful interference to radio or television reception, which can be determined by turning the equipment off and on, the user is encouraged to consult the dealer or an experienced radio/TV technician for help.

Cet appareil a été testé et jugé conforme aux limites des appareils numériques de Classe B, aux termes de la Section 15 des Règlements FCC.

Ces limites ont pour but d'assurer une protection raisonnable contre les interférences parasites dans une installation résidentielle.

Cet appareil engendre, utilise et peut émettre une énergie radioélectrique et, s'il n'est pas installé et utilisé en stricte conformité avec ces instructions, il peut provoquer des interférences parasites sur les liaisons radiophoniques. Ceci ne garantit par pour autant qu'une installation particulière ne provoquera aucune interférence.



Si l'appareil engendre des interférences sur la réception des ondes radio ou de télévision, ce qui peut être vérifié en mettant l'appareil hors tension puis sous tension, l'utilisateur est invité à consulter son revendeur ou un technicien expérimenté en radio/télévision pour lui demander conseil.

Este equipo ha sido probado y se ha comprobado que cumple con los límites de un dispositivo digital de clase B, según lo indicado en la Parte 15 de las Normas de FCC.

Estos límites se han establecido para ofrecer una protección razonable contra interferencias perjudiciales en instalaciones residenciales.

Este equipo genera, emplea, y puede radiar energía de radiofrecuencia y, si no se instala y emplea de acuerdo con las instrucciones, puede causar interferencias perjudiciales en las radiocomunicaciones. Sin embargo, no se garantiza que las interferencias no ocurran en una instalación en particular.

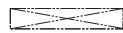
Si este equipo causa interferencias perjudiciales en la recepción de radio o de televisión, lo cual podrá determinarse conectando y desconectando la alimentación del equipo, se aconseja al usuario que consulte al abastecedor o que pida ayuda a un técnico en radio/televisión experimentado.

MODEL	<input type="text"/>	clarion
12V $\ominus$ GROUND		
AM 530-1710kHz/FM 87.9-107.9MHz		
THIS DEVICE COMPLIES WITH PART 15 OF THE FCC RULES. OPERATION IS SUBJECT TO THE FOLLOWING TWO CONDITIONS: (1) THIS DEVICE MAY NOT CAUSE HARMFUL INTERFERENCE, AND (2) THIS DEVICE MUST ACCEPT ANY INTERFERENCE RECEIVED, INCLUDING INTERFERENCE THAT MAY CAUSE UNDESIRABLE OPERATION.		
THIS PRODUCTION COMPLIES WITH DHS RULES 21 CFR SUBCHAPTER J APPLICABLE AT DATE OF MANUFACTURE.		
CLARION CO., LTD. 50 KAMITODA, TODA-SHI, SAITAMA-KEN, JAPAN		
This product includes technology owned by Microsoft Corporation and cannot be used or distributed without a license from MSLGP.		
MANUFACTURED:		
		
SERIAL No. PC <input type="text"/>		276- <input type="text"/> Clarion Co., Ltd. MADE IN <input type="text"/>

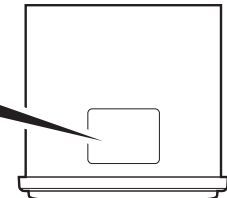

Bottom View of Source Unit  
Fond de l'appareil pilote  
Vista inferior de la unidad fuente

**Be sure to unfold and read the next page.**  
**Veuillez déplier et vous référer à la page suivante.**  
**Cerciórese de desplegar y de leer la página siguiente.**

# CONTROLS / LES COMMANDES / CONTROLES

Source unit / Appareil pilote / Unidad fuente

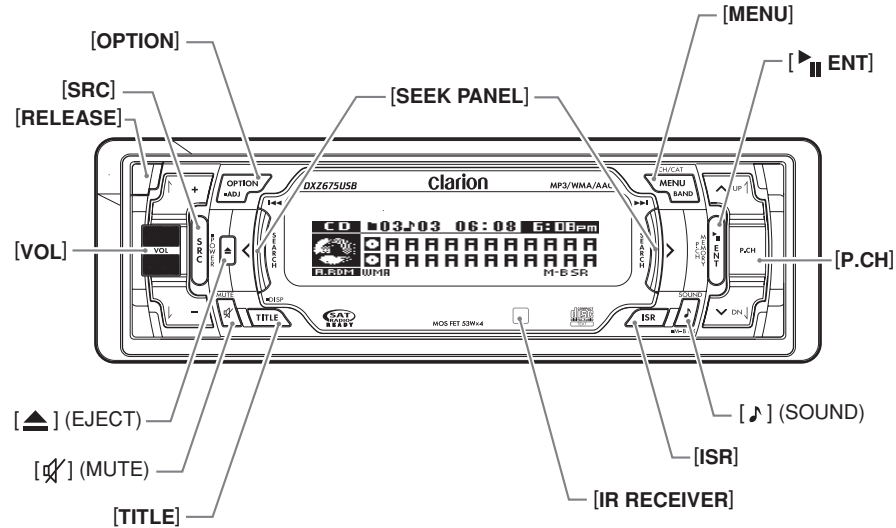

With the **MOTORIZED FACE** opened/ Ouvrez la **FACE MOTORISÉE**  
Apertura del **FRONTAL MOTORIZADO**

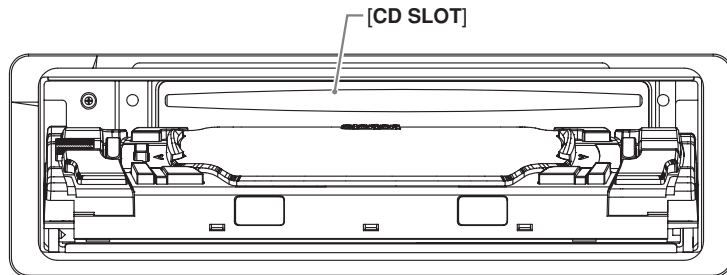

Note: Be sure to unfold this page and refer to the front diagrams as you read each chapter.  
Remarque: Veuillez déplier cette page et vous référer aux schémas quand vous lisez chaque chapitre.  
Nota: Cuando lea los capítulos, despliegue esta página y consulte los diagramas.

English

Français

Español

## CLARION PRODUCT REGISTRATION INFORMATION

For USA and Canada only  
[www.clarion.com](http://www.clarion.com)

Dear Customer:

Congratulations on your purchase of a Clarion mobile electronic products. We are confident that you'll enjoy your Clarion experience.

There are many benefits to registering your product. We invite you to visit our website at [www.clarion.com](http://www.clarion.com) to register your Clarion product.

We have made product registration simple with our easy to use website. The registration form is short and easy to complete. Once you're registered, we can keep you informed of important product information.

Register at [www.clarion.com](http://www.clarion.com) - it's easy to keep your Clarion product up to date.

## INFORMATIONS DE L'ENREGISTREMENT DE PRODUITS CLARION

Pour les États Unis et le Canada seulement  
[www.clarion.com](http://www.clarion.com)

Cher client:

Nous vous remercions d'avoir acheté ce produit électronique mobile Clarion. Nous sommes confiants que vous apprécierez votre expérience Clarion.

Il y a beaucoup d'avantage à enregistrer votre produits. Nous vous invitons à visiter notre site Web [www.clarion.com](http://www.clarion.com) pour enregistrer votre produit Clarion.

Nous avons facilité la tâche d'enregistrement de produit simple et facile grâce à notre site Web. Le formulaire d'enregistrement est court et facile à compléter. Lorsque vous êtes enregistrer, nous pouvons vous tenir informé des informations important de produits.

Enregistrer à [www.clarion.com](http://www.clarion.com) - c'est facile de mettre à jour votre produit Clarion.

## INFORMACIÓN DEL REGISTRO DE PRODUCTO DE CLARION

Para USA y Canada nomas  
[www.clarion.com](http://www.clarion.com)

Querido Cliente:

Felicitaciones por su compra de producto electrónico móvil de Clarion. Estamos seguros que usted gozará de su experiencia con el producto de Clarion.

Hay muchas ventajas al registrar su producto. Le invitamos a que visite nuestro sitio en internet [www.clarion.com](http://www.clarion.com) para registrar su producto de Clarion.

Hemos hecho el registro de producto fácil en nuestro sitio. La forma de registro es corta y fácil de completar. Una vez que lo registre, podremos proporcionarle la información de su producto.

Regístrese en [www.clarion.com](http://www.clarion.com) - es fácil mantener su producto de Clarion actualizado.

Thank you for purchasing this **Clarion** product.

- \* Please read this owner's manual in its entirety before operating this equipment.
- \* After reading this manual, be sure to keep it in a handy place (e.g., glove compartment).
- \* Check the contents of the enclosed warranty card and keep it carefully with this manual.
- \* This manual includes the operating procedures of the iPod® interface, CD/DVD changer, Satellite Radio Receiver and TV tuner connected via the CeNET cable. The iPod interface, CD/DVD changer and TV tuner have their own manuals, but no explanations for operating them are described. "iPod" is a trademark of Apple Computer, Inc., registered in the U.S. and other countries.

## Contents

<b>CONTROLS</b> .....	<b>ii</b>
<b>1. FEATURES</b> .....	<b>1</b>
<b>2. PRECAUTIONS</b> .....	<b>2</b>
Motorized Face.....	2
Handling Compact Discs .....	3
<b>3. NOMENCLATURE</b> .....	<b>4</b>
Names of the Buttons and Their Functions .....	4
Display Items.....	5
LCD Screen.....	5
<b>4. DCP</b> .....	<b>6</b>
<b>5. REMOTE CONTROL</b> .....	<b>7</b>
Inserting the Battery .....	7
Functions of Remote Control Unit Buttons .....	8
<b>6. OPERATIONS</b> .....	<b>10</b>
Basic Operations .....	10
Radio Operations .....	14
CD/MP3/WMA/AAC Operations .....	16
Operations Common to Each Mode .....	20
<b>7. OPERATIONS OF ACCESSORIES</b> .....	<b>24</b>
USB Operations .....	24
iPod BB Operations.....	26
Satellite Radio Operations.....	28
CD Changer Operations.....	30
DVD Changer Operations .....	31
TV Operations .....	32
<b>8. IN CASE OF DIFFICULTY</b> .....	<b>33</b>
<b>9. ERROR DISPLAYS</b> .....	<b>35</b>
<b>10. SPECIFICATIONS</b> .....	<b>36</b>

## 1. FEATURES

- Motorized Full Dot LCD with SLIDETRAK
- 6ch/6V RCA Output / 53W X 4 Built-in MOSFET Amplifier
- Built-in LPF/HPF

## 2. PRECAUTIONS

1. When the inside of the car is very cold and the player is used soon after switching on the heater moisture may form on the disc or the optical parts of the player and proper playback may not be possible. If moisture forms on the disc, wipe it off with a soft cloth. If moisture forms on the optical parts of the player, do not use the player for about one hour. The condensation will disappear naturally allowing normal operation.
2. Driving on extremely bumpy roads which cause severe vibration may cause the sound to skip.
3. This unit uses a precision mechanism. Even in the event that trouble arises, never open the case, disassemble the unit, or lubricate the rotating parts.

### **⚠ CAUTION**

**USE OF CONTROLS, ADJUSTMENTS, OR PERFORMANCE OF PROCEDURES OTHER THAN THOSE SPECIFIED HEREIN, MAY RESULT IN HAZARDOUS RADIATION EXPOSURE.**

**THE COMPACT DISC PLAYER SHOULD NOT BE ADJUSTED OR REPAIRED BY ANYONE EXCEPT PROPERLY QUALIFIED SERVICE PERSONNEL.**

**CHANGES OR MODIFICATIONS NOT EXPRESSLY APPROVED BY THE MANUFACTURER FOR COMPLIANCE COULD VOID THE USER'S AUTHORITY TO OPERATE THE EQUIPMENT.**

### **INFORMATION FOR USERS:**

**CHANGES OR MODIFICATIONS TO THIS PRODUCT NOT APPROVED BY THE MANUFACTURER WILL VOID THE WARRANTY AND WILL VIOLATE FCC APPROVAL.**

## *Motorized Face*

This unit uses motorized face to make large-screen displays possible.



When you use the motorized face, be sure to close it.

### **⚠ CAUTION**

**BE CAREFUL NOT TO GET YOUR FINGERS CAUGHT WHEN OPENING AND CLOSING THE MOTORIZED FACE.**

1. For safety's sake, always close the MOTORIZED FACE before leaving this unit unused for a prolonged period or switching OFF the ignition key.  
If you switch OFF the ignition key with the MOTORIZED FACE tilted, the MOTORIZED FACE does not close.
2. Before the MOTORIZED FACE closes, there may be a braking sound from the safety mechanism. This is normal.
3. If you move the MOTORIZED FACE by hand, this may create play. To correct this play, with the power on for the unit, press the [▲] button to close the MOTORIZED FACE.
4. After a disc is ejected, the MOTORIZED FACE automatically returns to the tilted or closed state. If there is any obstruction when the MOTORIZED FACE tries to close, the safety mechanism is triggered and the MOTORIZED FACE returns to the open state. If this happens, remove the obstruction, then press the [▲] button.
5. To avoid scratching the compact disk, keep the CD level when inserting or removing them.

# Handling Compact Discs

Use only compact discs bearing the  or  mark.

Do not play heart-shaped, octagonal, or other specially shaped compact discs.

Some CDs recorded in CD-R/CD-RW mode may not be usable.

## Handling

- Compared to ordinary music CDs, CD-R and CD-RW discs are both easily affected by high temperature and humidity and some of CD-R and CD-RW discs may not be played. Therefore, do not leave them for a long time in the car.

- New discs may have some roughness around the edges. If such discs are used, the player may not work or the sound may skip. Use a ball-point pen or the like to remove any roughness from the edge of the disc.

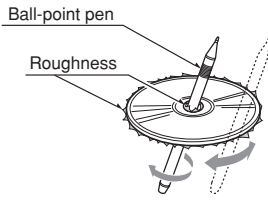

- Never stick labels on the surface of the compact disc or mark the surface with a pencil or pen.
- Never play a compact disc with any cellophane tape or other glue on it or with peeling off marks. If you try to play such a compact disc, you may not be able to get it back out of the CD player or it may damage the CD player.
- Do not use compact discs that have large scratches, are misshapen, cracked, etc. Use of such discs may cause misoperation or damage.
- To remove a compact disc from its storage case, press down on the center of the case and lift the disc out, holding it carefully by the edges.
- Do not use commercially available CD protection sheets or discs equipped with stabilizers, etc. These may damage the disc or cause breakdown of the internal mechanism.

## Storage

- Do not expose compact discs to direct sunlight or any heat source.
- Do not expose compact discs to excess humidity or dust.
- Do not expose compact discs to direct heat from heaters.

## Cleaning

- To remove fingermarks and dust, use a soft cloth and wipe in a straight line from the center of the compact disc to the circumference.
- Do not use any solvents, such as commercially available cleaners, anti-static spray, or thinner to clean compact discs.
- After using special compact disc cleaner, let the compact disc dry off well before playing it.

# 3. NOMENCLATURE

## Note:

• Be sure to read this chapter referring to the front diagrams of chapter "CONTROLS" on page ii (unfold).

## Names of the Buttons and Their Functions

### [RELEASE] button

- Deeply push in the button to unlock the DCP.

### [SRC] button

- Press the button to turn on the power.
- Press and hold the button for 1 second or longer to turn off the power.
- Switch the operation mode among the radio mode, etc.

### [OPTION] button

- Press the button to enter the option mode.
- Press and hold the button for 1 second or longer to enter the adjust mode.

### [SEEK PANEL]

- The [SEEK PANEL] allows the controls on the ends to be moved to right or left to permit station tuning (radio), track selection (CD), and to perform various settings in the adjustment mode.

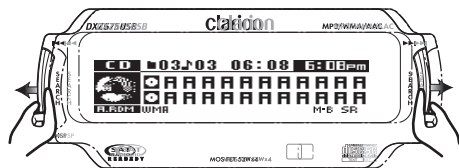

### [MENU] button

- Switch the band, or seek tuning or manual tuning while in the radio mode.
- Press the button to enter the list search mode while in the CD/MP3/WMA/AAC mode.
- Press and hold the button for 1 second or longer to play the first track while in the CD/MP3/WMA/AAC mode.
- Press the button to change the character.

### [▶||] [ENT] button

- Play or pause a track while in the CD/MP3/WMA/AAC mode.
- Confirm various settings.
- Press the button to enter the preset memory mode (radio).

### [P.CH] button

- Push the button upward or downward to recall the stored station while in the radio mode.
- Select the folder while in the MP3/WMA/AAC mode.
- Perform various settings.

### [♪] (SOUND) button

- Press the button to enter the sound mode.
- Press and hold the button for 1 second or longer to turn on or off the MAGNA BASS EXTEND mode.

### [ISR] button

- Recall ISR radio station in memory.
- Press and hold the button for 2 seconds or longer: Store current station into ISR memory (radio mode only).

### [IR RECEIVER]

- Receiver for remote control unit. (Operating range: 30° in all directions)

### [TITLE] button

- Use the button to switch the user titles or track titles, etc. while in the CD/MP3/WMA/AAC mode.
- Press and hold the button to switch the display indication (Action display, Title display and Clock time display).

### [🔇] (MUTE) button

- Turn mute on or off.

### [▶] (EJECT) button

- Press to open the MOTORIZED FACE and insert a CD into the CD SLOT.
- Press to eject a CD loaded in the unit.

### [VOL] button

- Push the button upward or downward to adjust the volume.

### [CD SLOT]

- CD insertion slot.

## Display Items

### Source indication

- **FM1-3, AM** : Radio mode
- **SR1-3** : Satellite radio mode (SIRIUS)
- **XM1-3** : Satellite radio mode (XM)
- **CD** : CD/MP3/WMA/AAC mode
- **USB** : USB mode
- **iPod** : iPod BB mode
- **CDC1-4** : CD changer mode
- **DVDC1-4** : DVD changer mode
- **TV1-2** : TV mode
- **AUX** : AUX mode
- **TEL** : Telephone mode

- Radio mode: Preset No. / frequency
- CD mode : Track No. / playback time
- MP3/WMA/AAC mode : Folder No. / track No. / playback time
- CD / DVD changer mode : Disc No. / track No. / playback time
- TV mode : Preset No. / channel



Clock time indication

Source icon  
(3 patterns)

Operation status indication  
Titles indication

- A.RDM** : Disc/Folder random
- A.RPT** : Disc/Folder repeat
- A.SCN** : Disc/Folder scan
- RDM** : Track random
- RPT** : Track repeat
- SCN** : Track/Preset/Service scan
- AS** : Auto store
- ST** : Stereo indication (radio only)

- WMA** : MP3/WMA/AAC indication
- MANU** : Manual indication
- CAT MODE** : Category mode indication
- CH MODE** : Channel mode indication
- SAT** : Satellite indication
- M-B** : MAGNA BASS EXTEND indication
- (DZE** : Digital Z-Enhancer indication)
- SR** : Sound restorer indication

## LCD Screen

In extreme cold, the screen movement may slow down and the screen may darken, but this is normal. The screen will recover when it returns to normal temperature.

## 4. DCP

The control panel can be detached to prevent theft. When detaching the control panel, store it in the DCP (DETACHABLE CONTROL PANEL) case to prevent scratches.

We recommend taking the DCP with you when leaving the car.

### Removing the DCP

1. With the **MOTORIZED FACE** closed, turn off the power.
2. Press the **[RELEASE]** button deeply to open the DCP.

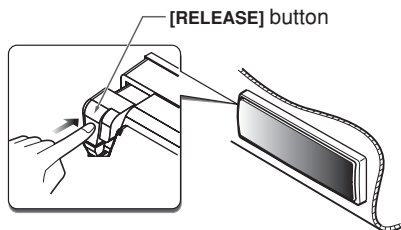

3. Pull the DCP toward you and remove it.

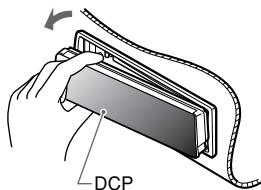

### ⚠ CAUTION

- Always close the **MOTORIZED FACE** before removing the DCP.
- If you remove the DCP with the **MOTORIZED FACE** open, the **MOTORIZED FACE** closes immediately. Be careful not to get your fingers caught.

### Attaching the DCP

1. Insert the DCP so that the **(A)** section on the right side of the DCP catches on the hook **(B)** on the unit.

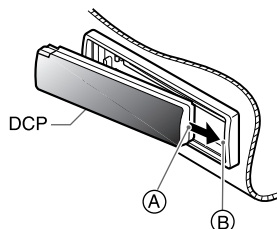

2. Press the left side **(C)** of the DCP carefully to fit it in place.

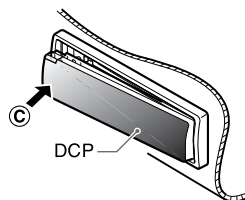

### ⚠ CAUTION

- The DCP can easily be damaged by shocks. After removing it, be careful not to drop it or subject it to strong shocks.
- If the **[RELEASE]** button is pressed and the DCP is not locked into place, it may fall out from vibration of the car. This can break the DCP, so after removing it, either install it on the unit or put it in its DCP case.
- The connector connecting the unit and the DCP is an extremely important part. Be careful not to damage it by pressing on it with fingernails, screwdrivers, etc.

#### Note:

- If the DCP is dirty, wipe off the dirt with a soft, dry cloth only.



# 5. REMOTE CONTROL

## Inserting the Battery

- ① Turn over the remote control unit and slide the cover in the direction indicated by the arrow in the illustration.
- ② Insert the battery (CR2025) into the insertion guides, with the printed side (+) facing upwards.
- ③ Press the battery in the direction indicated by the arrow so that it slides into the compartment.
- ④ Replace the cover and slide in until it clicks into place.

### Notes:

*Misuse may result in rupture of the battery, producing leakage of fluid and resulting in personal injury or damage to surrounding materials. Always follow these safety precautions:*

- Use only the designated battery.
- When replacing the battery, insert properly, with +/- polarities oriented correctly.
- Do not subject battery to heat, or dispose of in fire or water. Do not attempt to disassemble the battery.
- Dispose of used batteries properly.

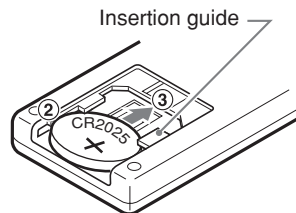
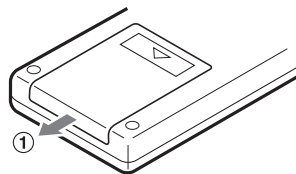

# Functions of Remote Control Unit Buttons

\* Some buttons on the remote control unit have different functions from the corresponding buttons on the main unit.

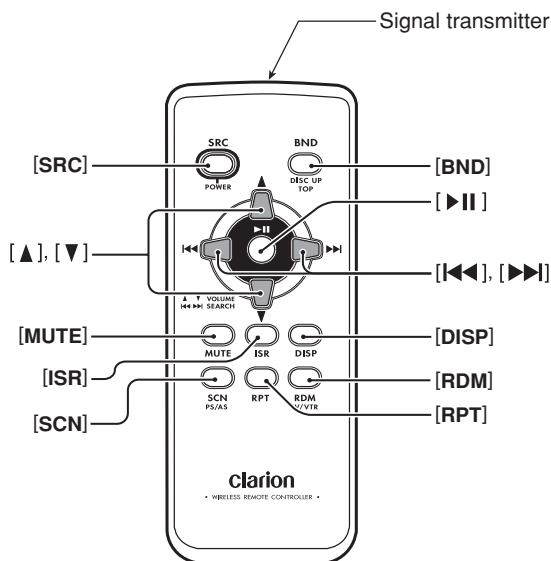

## ● Shared modes

### [SRC] button

- Press the button to turn on the power.  
Press and hold the button for 1 second or longer to turn off the power.
- Use to alternate operation mode among the various modes.

### [▲], [▼] buttons

- Increases and decreases volume.

### [MUTE] button

- Turns mute function on and off.

### [ISR] button

- Recalls ISR radio station stored in memory.
- Press and hold the button for 2 seconds or longer to store current station in ISR memory (radio mode only).

### [DISP] button

- Press to alternate among action display, title display and Clock time display, etc.

## ● Radio/Satellite Radio modes

### [BND] button

- Switches reception band.

### [◀◀], [▶▶] buttons

- Moves preset channels up and down.

### [SCN] button

- Press to perform preset scan.
- Press and hold the button for 2 seconds or longer to perform auto store.
- In the Satellite Radio mode, press once to perform category scan; hold depressed for 1 second or longer to perform preset scan.

## ● CD/MP3/WMA/AAC and USB modes

### [BND] button

- Press to play the first track.

### [◀◀], [▶▶] buttons

- Press to move the tracks up and down.
- Press and hold the button for 1 second or longer to perform fast-forward/fast-backward.

## Functions of Remote Control Unit Buttons

### [▶||] button

- Switches between playback and pause.

### [SCN] button

- Press to perform scan play.
- When in MP3/WMA/AAC and USB modes, press and hold the button for 1 second or longer to perform folder scan play.

### [RPT] button

- Press to perform repeat play.
- When in MP3/WMA/AAC and USB modes, press and hold the button for 1 second or longer to perform folder repeat play.

### [RDM] button

- Press to perform random play.
- When in MP3/WMA/AAC and USB modes, press and hold the button for 1 second or longer to perform folder random play.

## ● CD changer/DVD changer modes

### [BND] button

- Press to switch to next disc in ascending order.

### [◀◀], [▶▶] buttons

- Press to move the tracks up and down.
- Press and hold the button for 1 second or longer to perform fast-forward/fast-backward.

### [▶||] button

- Switches between playback and pause.

### [SCN] button

- Press to perform scan play.
- Press and hold the button for 1 second or longer to perform disc scan play.

### [RPT] button

- Press to perform repeat play.
- Press and hold the button for 1 second or longer to perform disc repeat play.

### [RDM] button

- Press to perform random play.
- Press and hold the button for 1 second or longer to perform disc random play.

## ● iPod BB mode

### [◀◀], [▶▶] buttons

- Press to move the tracks up and down.
- Press and hold the button for 1 second or longer to perform fast-forward/fast-backward.

### [▶||] button

- Switches between playback and pause.

### [RPT] button

- Press to perform repeat play.
- Press and hold the button for 1 second or longer to perform all repeat play.

### [RDM] button

- Press to perform random play.
- Press and hold the button for 1 second or longer to perform all random play.

## ● TV mode

### [BND] button

- Switches reception band.

### [◀◀], [▶▶] buttons

- Moves preset channels up and down.

### [SCN] button

- Press to perform preset scan.
- Press and hold the button for 2 seconds or longer to perform auto store.

### [RDM] button

- Press to alternate between TV and VTR.

# 6. OPERATIONS

## Note:

- Be sure to read this chapter referring to the front diagrams of chapter "CONTROLS" on page ii (unfold).

## Basic Operations

### ⚠ CAUTION

Be sure to lower the volume before switching off the unit power or the ignition key. The unit remembers its last volume setting. If you switch the power off with the volume up, when you switch the power back on, the sudden loud volume may hurt your hearing and damage the unit.

### Turning on/off the power

#### Note:

- Be careful about using this unit for a long time without running the engine. If you drain the car's battery too far, you may not be able to start the engine and this can reduce the service life of the battery.

1. Press the [SRC] button.  
The mode that was previous active is displayed.
2. Press and hold the [SRC] button for 1 second or longer to turn off the power for the unit.

#### Note:

- The first time this unit is turned on after the wire connections are completed, it must be checked what equipment is connected. When the power is turned on, "SYSTEM CHECK" appears in the display, then the unit returns to the clock display mode. The system check starts within the unit. When the system check is complete, press the [SRC] button again.

### Selecting a mode

1. Press the [SRC] button to change the operation mode.
2. Each time you press the [SRC] button, the operation mode changes in the following order:  
Radio → (Satellite radio) → CD/MP3/WMA/AAC → USB → (iPod BB) → (CD changer) → (DVD changer) → (TV) → AUX → Radio...  
\* External equipment not connected with CeNET is not displayed.

### Adjusting the volume

1. Push the [VOL] button upward or downward to adjust the volume.  
\* The volume level is from 0 (minimum) to 33 (maximum).

### Switching the display

Press and hold the [TITLE] button for 1 second or longer to select the desired display.

#### ● When the power is turned on

1. Each time you press and hold the [TITLE] button for 1 second or longer, the display switches in the following order:  
Action display → Title display → Clock time display → Action display...



#### ● When the power is turned off

1. Each time you press the [TITLE] button, the clock time appears or disappears in the display.

## Basic Operations



### Adjusting MAGNA BASS EXTEND

The MAGNA BASS EXTEND does not adjust the low sound area like the normal sound adjustment function, but emphasizes the deep bass sound area to provide you with a dynamic sound.

1. Press and hold the [  ] button for 1 second or longer to turn on the MAGNA BASS EXTEND effect. “**M-B**” lights in the display.
2. Press and hold the [  ] button for 1 second or longer to turn off the MAGNA BASS EXTEND effect. “**M-B**” goes off from the display.
  - \* The adjustment can only be performed when the DZE is set to “**DZE OFF**”.
  - \* The factory default setting is off.

### Mute

Use this function to turn off the sound immediately.



1. Press the [  ] button.  
The sound turns off and “**MUTE**” blinks in the display.
2. Press the [  ] button again to cancel the mute mode.

## Adjusting Sound Mode

### To change sound mode

1. Press the [  ] button and select the sound mode to adjust.



2. Push the [SEEK PANEL] leftward or rightward to select the “item name”.  
“**S-W VOLUME**” ↔ “**DZE**” ↔ “**BASS**” ↔ “**TREBLE**” ↔ “**S RESTORER**” ↔ “**HPF**” ↔ “**S-W LPF**” ↔ “**BALANCE**” ↔ “**FADER**”
3. Push the [P.CH] button upward or downward to select the “desired setting value”.
  - \* In the case of item names appearing with the “**ENT**” suffix after the item name, the [  ] ENT button must be pressed to display the setting value.
  - \* “**BASS**” and “**TREBLE**” can be adjusted only when “**DZE**” is set to “**DZE OFF**” (page 12).
  - \* After completing settings, press the [  ] button to return to the previous mode.

#### Note:

- During sound adjustment mode, if no operation is performed for more than 10 seconds, this mode can be canceled and return to the previous mode.

### ● Adjusting the subwoofer output volume

You can adjust the volume output from the unit’s subwoofer output terminal.

- 2-1. Select the “**S-W VOLUME**”.
- 3-1. Push the [P.CH] button upward or downward to change the output volume.
  - \* The factory default setting is “**0**”.  
(Setting range: +5 to -5)

## Basic Operations

### ● Setting the Digital Z-Enhancer

This unit are provided with 3 types of sound tone effects stored in memory. Select the one you prefer.

\* The factory default setting is "DZE OFF".

2-1. Select the "DZE".

3-1. Press the [  ENT ] button.

3-2. Push the [SEEK PANEL] leftward or rightward to select the tone effect. Each time you push the [SEEK PANEL], the tone effect changes in the following order:

"DZE OFF" ↔ "DZE 1" ↔ "DZE 2" ↔ "DZE 3"

**DZE OFF** : no sound effect

**DZE 1** : Suitable for genuine speakers

**DZE 2** : Suitable for separate speakers

**DZE 3** : Suitable for co-axial speakers

3-3. When the "DZE 1", "DZE 2" or "DZE 3" is set, push the [P.CH] button upward or downward to change the DZE level from +3 to -3.

\* The factory default setting is "0".

3-4. Press the [  ENT ] button to return to the previous mode.

### ● Compensation

There is no need to compensate frequency characteristics if they are flat (no peaks or valleys) when you have measured the frequency characteristics with a measuring device. However, sometimes the frequency characteristics rise and fall in some places. If this happens, the frequency characteristics must be compensated. Create a frequency curve having characteristics that are opposite to the center frequency of parts where the characteristics rise and fall to cancel out these peaks and valleys, and make the frequency characteristics as flat as possible.

Making the frequency characteristics as flat as possible is called "Compensation".

### ● Compensation of frequency characteristics

The figure below shows the relationship between the center frequency, gain and Q curve.

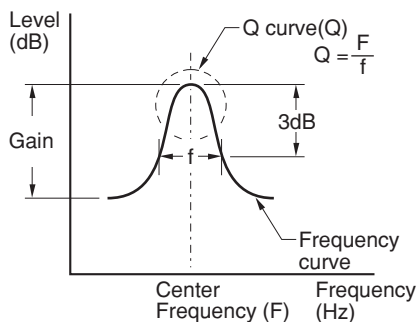

### ● Q curve

The Q curve becomes sharper when the numerical value is increased, and smoother when the numerical value is decreased.

Flat frequency characteristics can be made by selecting a Q curve opposite to that of the curve to be compensated.

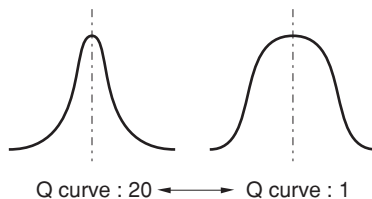

### ● Adjusting the bass

The bass gain, bass FREQ (center frequency) and bass Q can be adjusted as follows.

The adjustment can only be performed when the DZE is set to "DZE OFF".

2-1. Select "BASS".

2-2. Press the [  ENT ] button.

2-3. Push the [SEEK PANEL] leftward or rightward and select from:

"BASS GAIN" ↔ "BASS FREQ" ↔ "BASS Q"

## Basic Operations

- 3-1. Push the [P.CH] button upward or downward to adjust the gain, the **FREQ** (center frequency) and the **Q**.

**BASS GAIN:** +7 to -7 (The factory default setting is "0")

**BASS FREQ:** 50Hz/80Hz/120Hz (The factory default setting is "50")

**BASS Q:** 1/1.25/1.5/2 (The factory default setting is "1")

- 3-2. Press the [  ENT ] button to return to the previous mode.

### ● Adjusting the treble

The treble gain and treble **FREQ** (center frequency) can be adjusted as follows.

The adjustment can only be performed when the **DZE** is set to "**DZE OFF**".

- 2-1. Select "**TREBLE**".

- 2-2. Press the [  ENT ] button.

- 2-3. Push the [ **SEEK PANEL** ] leftward or rightward and select from:  
**"TREB GAIN"** ↔ **"TREB FREQ"**

- 3-1. Push the [P.CH] button upward or downward to adjust the gain and **FREQ** (center frequency).

**TREB GAIN:** +6 to -6 (The factory default setting is "0")

**TREB FREQ:** 8KHz/12KHz (The factory default setting is "12K")

- 3-2. Press the [  ENT ] button to return to the previous mode.

### ● Adjusting the sound restorer

The sound restorer enriches the playback of all types of music files that have undergone any level of data compression.

- 2-1. Select "**S RESTORER**".

- 3-1. Push the [P.CH] button upward or downward to adjust.

Each time you push the [P.CH] button, the sound restorer changes in the following order:

**"OFF"** ↔ **"1"** ↔ **"2"** ↔ **"3"**

\* The factory default setting is "**OFF**".

Set this adjustment in accordance with the music source used

**OFF:** For music sources compressed at high bit rate

**1:** For music sources compressed for high quality at low bit rate

**2:** For music sources compressed for standard quality at low bit rate

**3:** For music sources compressed for low quality at low bit rate

### ● Setting high pass filter

- 2-1. Select "**HPF**".

- 3-1. Push the [P.CH] button upward or downward to select the setting. Each time you push the [P.CH] button, the setting changes in the following order:

**"THRGH"** ↔ **"50Hz"** ↔ **"80Hz"** ↔ **"120Hz"**

\* The factory default setting is "**THRGH**" (through).

### ● Setting low pass filter

- 2-1. Select "**S-W LPF**".

- 3-1. Push the [P.CH] button upward or downward to select the setting.

Each time you push the [P.CH] button, the setting changes in the following order:

**"THRGH"** ↔ **"50Hz"** ↔ **"80Hz"** ↔ **"120Hz"**

\* The factory default setting is "**THRGH**" (through).

### ● Adjusting the balance

- 2-1. Select "**BALANCE**".

- 3-1. Push the [P.CH] button upward to emphasize the sound from the right speaker, push the button downward to emphasize the sound from the left speaker.

\* The factory default setting is "**0**".  
 (Adjustment range: L12 to R12)

### ● Adjusting the fader

- 2-1. Select "**FADER**".

- 3-1. Push the [P.CH] button upward to emphasize the sound from the front speaker, push the button downward to emphasize the sound from the rear speaker.

\* The factory default setting is "**0**".  
 (Adjustment range: R12 to F12)

# Radio Operations

## Listening to the radio

1. Press the [SRC] button and select the radio mode. The frequency appears in the display.
2. Press the [MENU] button and select the radio band. Each time the button is pressed, the radio reception band changes in the following order:  
FM1 → FM2 → FM3 → AM → FM1...
3. Push the [SEEK PANEL] leftward or rightward to tune in the desired station.

## Tuning

There are 3 types of tuning mode available, seek tuning, manual tuning and preset tuning.

### Seek tuning

1. Press the [MENU] button and select the desired band (FM or AM).
2. Tune into a station.
  - \* If "MANU" is lit in the display, press and hold the [MENU] button for 1 second or longer. "MANU" in the display goes off and seek tuning is now available.

When the [SEEK PANEL] is pushed rightward, the station is sought in the direction of higher frequencies; if the [SEEK PANEL] is pushed leftward, the station is sought in the direction of lower frequencies.

### Manual tuning

There are 2 ways available: Quick tuning and step tuning.

When you are in the step tuning mode, the frequency changes one step at a time. In the quick tuning mode, you can quickly tune the desired frequency.

1. Press the [MENU] button and select the desired band (FM or AM).
  - \* If "MANU" is not lit in the display, press and hold the [MENU] button for 1 second or longer. "MANU" is lit in the display and manual tuning is now available.
2. Tune into a station.

### ● Quick tuning

Push the [SEEK PANEL] leftward or rightward and hold in position for 1 second or longer to tune in a station.

### ● Step tuning

Push the [SEEK PANEL] leftward or rightward to manually tune in a station.

## Recalling a preset station

A total of 24 preset positions (6-FM1, 6-FM2, 6-FM3, 6-AM) exists to store individual radio stations in memory. Pushing the [P.CH] button upward or downward recalls the stored radio frequency automatically.

1. Press the [MENU] button and select the desired band (FM or AM).
2. Push the [P.CH] button upward or downward to recall the stored station.
  - \* Press the [▶||ENT] button to enter the preset memory mode. Push the [P.CH] button upward or downward, then press and hold the [▶||ENT] button for 2 seconds or longer to store that station into preset memory.

## Manual memory

1. Select the desired station with seek tuning or manual tuning.
2. Press the [▶||ENT] button to enter the preset memory mode.
3. Push the [P.CH] button upward or downward to select a desired station, then press and hold the [▶||ENT] button for 2 seconds or longer to store the current station into preset memory.



### Auto store

Auto store is a function for storing up to 6 stations that are automatically tuned in sequentially. If 6 receivable stations cannot be received, a previously stored station remains unoverwritten at the memory position.

1. Press the **[MENU]** button and select the desired band (FM or AM).
2. Press the **[OPTION]** button.
3. Push the **[SEEK PANEL]** leftward or rightward to select "**AUTO STORE**".
4. Press and hold the **[▶|| ENT]** button for 2 seconds or longer. The stations with good reception are stored automatically to the preset channels.

### Preset scan

Preset scan receives the stations stored in preset memory in order. This function is useful when searching for a desired station in memory.

1. Press the **[OPTION]** button.
2. Push the **[SEEK PANEL]** leftward or rightward to select "**PRESET SCN**".
3. Press the **[▶|| ENT]** button.
  - \* When a desired station is tuned in, press the **[▶|| ENT]** button again to continue receiving that station.

### Instant station recall (ISR)

Instant station recall is a special radio preset that instantly accesses a favorite radio station at a touch of a button. The ISR function even operates with the unit in other modes.

#### ● ISR memory

1. Select the station that you wish to store in ISR memory.
2. Press and hold the **[ISR]** button for 2 seconds or longer.

#### ● Recalling a station with ISR

In any mode, press the **[ISR]** button to turn on the radio function and tune the selected radio station. "**ISR**" appears in the display. Press the **[ISR]** button again to return to the previous mode.

# CD/MP3/WMA/AAC Operations

## MP3/WMA/AAC

### What is MP3?

MP3 is an audio compression method and classified into audio layer 3 of MPEG standards. This audio compression method has penetrated into PC users and become a standard format. This MP3 features the original audio data compression to about 10 percent of its initial size with a high sound quality. This means that about 10 music CDs can be recorded on a CD-R disc or CD-RW disc to allow a long listening time without having to change CDs.

### What is WMA?

WMA is the abbreviation of Windows Media Audio, an audio file format developed by Microsoft Corporation.

#### Notes:

- If you play a file with DRM (Digital Rights Management) for WMA remaining ON, no audio is output (The WMA indicator blinks).
- Windows Media™, and the Windows © logo are trademarks, or registered trademarks of Microsoft Corporation in the United States and/or other countries.

#### ● To disable DRM (Digital Rights Management)

1. When using Windows Media Player 8, click on TOOLS → OPTIONS → COPY MUSIC tab, then under COPY SETTINGS, unclick the check box for PROTECT CONTENT. Then, reconstruct files.
2. When using Windows Media Player 9, click on TOOL → OPTIONS → MUSIC RECORD tab, then under Recording settings, unclick the Check box for RECORD PROTECTED MUSIC. Then, reconstruct files.

Personally constructed WMA files are used at your own responsibility.

### What is AAC?

- AAC is an acronym for "Advanced Audio Coding" and refers to the audio compression method used with video compression standards MPEG-2 and MPEG-4.
- AAC files composed with the following conditions can be played:
  - AAC files encoded with iTunes.
  - iTunes Ver. 7.0 or earlier.
  - File extension ".m4a" ("M4A")

- Tracks purchased at an iTunes Music store, and copyright-protected files cannot be played.
- When playing AAC files that include image data, additional time may be required before playback begins.
- Files may not play properly, depending on the iTunes version under which an AAC file is encoded.

### Precautions when creating MP3/WMA/AAC disc

#### ● Usable sampling rates and bit rates

1. MP3: Sampling rate 8 kHz-48 kHz,  
Bit rate 8 kbps-320 kbps / VBR
2. WMA: Bit rate 32 kbps-192 kbps
3. AAC: Sampling rate 8 kHz-48 kHz,  
Bit rate 8 kbps-320 kbps / VBR

#### ● File extensions

1. Always add a file extension ".MP3" (.mp3), ".WMA" (.wma) or ".M4A" (.m4a) to MP3, WMA or AAC file by using single byte letters. If you add a file extension other than specified or forget to add the file extension, the file cannot be played.
2. Files without MP3/WMA/AAC data will not play. The indication "- :- -" appears in the play time display if you attempt to play files without MP3/WMA/ACC data.

#### ● Logical format (File system)

1. When writing MP3/WMA/AAC file on a CD-R disc or CD-RW disc, please select "ISO9660 level 1, 2 or JOLIET or Romeo or APPLE ISO" as the writing software format. Normal play may not be possible if the disc is recorded on another format.
2. The folder name and file name can be displayed as the title during MP3/WMA/AAC play but the title must be within 64 single byte alphabetical letters and numerals (including an extension).
3. Do not affix a name to a file inside a folder having the same name.

#### ● Folder structure

1. A disc with a folder having more than 8 hierarchical levels will be impossible.

## CD/MP3/WMA/AAC Operations

### ● Number of files or folders

- Up to 255 files can be recognized per folder.  
Up to 510 files can be played.
- Tracks are played in the order that they were recorded onto a disc. (Tracks might not always be played in the order displayed on the PC.)
- Some noise may occur depending on the type of encoder software used while recording.

### Set the type of file to be played (multi-session function)

When a single disc holds both normal CD type tracks and MP3/WMA/AAC type tracks, use this command to select which type of track to play.

\* Default setting is "CD".

- When only one type of track (either music CD or MP3/WMA/AAC) is recorded on a disc, selecting either type will allow playback of the disc.
- When playing CCCD (copy-control CDs), set to CD type.
  - Press the [OPTION] button.
  - Push the [SEEK PANEL] leftward or rightward to select "MULTI SESS".
  - Push the [P.CH] button upward or downward to select "CD" or "MP3". The mixed mode is switched between CD type or MP3/WMA/AAC type.
    - **CD**  
When playing music CD only.
    - **MP3**  
When playing music MP3/WMA/AAC only.
  - When setting is completed, remove the disc and reinsert it.

### Disc-In-play function

As long as the ignition key is turned to the ON or ACC position, this function allows you to turn the power to the unit and start playing the disc automatically when the disc is inserted even if the power is not turned on.

### Backup Eject function

You can eject a disc by pressing the [▲] button even if the engine key or ACC is at the OFF position.

#### ⚠ CAUTION

**When the disc is ejected, press the [▲] button to close the control panel. If the control panel is left open, you will hear a double beep, and the control panel automatically closes.**

- Press the [▲] button.  
The control panel opens.
- Press the [▲] button.  
The disc is ejected.

#### Note:

- Always close the **MOTORIZED FACE** after opening it or ejecting the CD.

#### ⚠ CAUTION

- **Be careful not to catch your hand or fingers while closing the MOTORIZED FACE.**
- **Do not try to put your hand or fingers in the disc insertion slot. Also never insert foreign objects into the slot.**
- **Do not insert discs where adhesive comes out from cellophane tape or a rental CD label, or discs with marks where cellophane tape or rental CD labels were removed. It may be impossible to extract these discs from the unit and they may cause the unit to break down.**

### Listening to a disc already loaded in the unit

Press the [SRC] button to select the CD/MP3/WMA/AAC mode.

When the unit enters the CD/MP3/WMA/AAC mode, play starts automatically.



If there is no disc loaded, the indication "NO DISC" appears in the title display.

## CD/MP3/WMA/AAC Operations

### Loading a CD

1. Press the [**▲**] button. The MOTORIZED FACE opens.
2. Insert a CD into the center of the CD SLOT with the labeled side facing up. The CD plays automatically after loading.

#### Notes:

- Never insert foreign objects into the CD SLOT.
- If the CD is not inserted easily, there may be another CD in the mechanism or the unit may require service.
- Discs not bearing the  or  mark and CD-ROMs cannot be played by this unit.
- Some CDs recorded in CD-R/CD-RW mode may not be usable.

### Pausing play

1. Press the [**⏸** ENT] button to pause play. "PAUSE" appears in the display.
2. To resume CD play, press the [**⏸** ENT] button again.

### Displaying CD titles

This unit can display title data for CD-text/MP3/WMA/AAC disc and user titles input with this unit.

1. Each time you press the [TITLE] button, the title display changes in the following order:

#### ● CD-TEXT disc

Title scan → User title (disc) → CD-text title (track) → CD-text title (disc) → Artist name → Title scan ...

#### ● MP3/WMA/AAC disc

Title scan → Track → Folder → Title TAG → Album TAG → Artist TAG → Title scan ...

#### ● TITLE SCAN

When the display is changed to the title scan mode, all titles of the track scroll automatically.

When "AUTO SCROLL" is set "ON", the title scan automatically. When "AUTO SCROLL" is set "OFF", the title only scan one time. (The factory default setting is "ON". Refer to the subsection "Setting the method for title scroll" in section "Operations Common to Each Mode".)

#### Notes:

- If the CD playing is not a CD-text CD or no user title has been input, "**NO TITLE**" appears in the display.

- If MP3/WMA/AAC disc is not input TAG, "**NO TITLE**" appears in the display.
- For MP3, supports ID3 Tags V2.3 / 2.2 / 1.1 / 1.0.
- Tag displays give priority to V2.3 / 2.2.
- In the case of album Tags for WMA, the information written into the extension header is displayed.
- Only ASCII characters can be displayed in Tags.

### Selecting a track

#### ● Track-up

1. Push the [SEEK PANEL] rightward to move ahead to the beginning of the next track.
2. Each time you push the [SEEK PANEL] rightward, the track advances ahead to the beginning of the next track.

#### ● Track-down

1. Push the [SEEK PANEL] leftward to move back to the beginning of the current track.
2. Push the [SEEK PANEL] leftward twice to move back to the beginning of the previous track.

### Fast-forward/fast-backward

#### ● Fast-forward

1. Push the [SEEK PANEL] rightward and hold in position for 1 second or longer.

#### ● Fast-backward

1. Push the [SEEK PANEL] leftward and hold in position for 1 second or longer.
  - \* For MP3/WMA/AAC discs, it takes some time until the start of searching and between tracks. In addition, the playing time may have a margin of error.

### Folder Select

This function allows you to select a folder containing MP3/WMA/AAC files and start playing from the first track in the folder.

1. Push the [P.CH] button upward or downward.
  - Push the [P.CH] button upward to move the next folder. Push the [P.CH] button downward to move the previous folder.
  - \* Folder without an MP3/WMA/AAC file is not selectable.
2. To select a track, push the [SEEK PANEL] leftward or rightward.

## CD/MP3/WMA/AAC Operations

### Top function

The top function resets the CD player to the first track of the disc. Press and hold the [MENU] button for 1 second or longer to play the first track (track No. 1) on the disc.

\* In case of MP3/WMA/AAC, the first track of a folder being played will be returned.

### List search function

1. Press the [MENU] button to enter the list search mode. And then the track list appears in the display.
2. Push the [P.CH] button upward or downward to select a track.
  - \* If you push the [SEEK PANEL] leftward or rightward, the track list scrolls 5 lines at a time.
3. Press the [▶|| ENT] button to play.
  - \* In case of MP3/WMA/AAC, this function is performed in the current folder.

#### Note:

• If no operation is performed for more than 10 seconds, this mode can be cancel and return to the usual mode.

### Other various play functions

1. Press the [OPTION] button.



#### ● Scan play

This function allows you to locate and play the first 10 seconds of all the tracks recorded on a disc.

2. Push the [SEEK PANEL] leftward or rightward to select "SCN".
3. Push the [P.CH] button upward or downward to select "♪", and then press the [▶|| ENT] button to perform scan play.
  - "TRACK SCN" appears in the display.
  - \* Scan play starts from the next track after the track currently being played.

#### ● Folder scan play

This function allows you to locate and play the first 10 seconds of the first track of all the folders on an MP3/WMA/AAC disc.

2. Push the [SEEK PANEL] leftward or rightward to select "SCN".

3. Push the [P.CH] button upward or downward to select "ALL", and then press the [▶|| ENT] button to perform folder scan play.
  - "FOLDER SCN" appears in the display.
  - \* Folder scan play starts from the next folder after the folder currently being played.

#### ● Repeat play

This function allows you to play the current track repeatedly.

2. Push the [SEEK PANEL] leftward or rightward to select "RPT".
3. Push the [P.CH] button upward or downward to select "♪", and then press the [▶|| ENT] button to perform repeat play.
  - \* "TRACK RPT" appears in the display.

#### ● Folder repeat play

This function allows you to play a track currently being played in the MP3/WMA/AAC folder repeatedly.

2. Push the [SEEK PANEL] leftward or rightward to select "RPT".
3. Push the [P.CH] button upward or downward to select "ALL", and then press the [▶|| ENT] button to perform folder repeat play. "FOLDER RPT" appears in the display.

#### ● Random play

This function allows you to play all tracks recorded on a disc in a random order.

2. Push the [SEEK PANEL] leftward or rightward to select "RDM".
3. Push the [P.CH] button upward or downward to select "♪", and then press the [▶|| ENT] button to perform random play.
  - "TRACK RDM" appears in the display.

#### ● Folder random play

This function allows you to play all the tracks of all the folders recorded on an MP3/WMA/AAC disc in a random order.

2. Push the [SEEK PANEL] leftward or rightward to select "RDM".
3. Push the [P.CH] button upward or downward to select "ALL", and then press the [▶|| ENT] button to perform folder random play. "FOLDER RDM" appears in the display.

#### ● To cancel the trick play

2. Push the [SEEK PANEL] leftward or rightward to select "TRICK OFF".
3. Press the [▶|| ENT] button to cancel the trick play.

## Operations Common to Each Mode

### To change adjustment setting

1. Press and hold the [OPTION] button for 1 second or longer to switch to the adjustment selection display.
2. Push the [SEEK PANEL] leftward or rightward to select the "item name".  
 "CLOCK EDIT" ↔ "CONTRAST" ↔  
 "SCREEN SAVER" ↔ "MSG INPUT" ↔  
 "AUTO SCROLL" ↔ "SCROLL SPEED" ↔  
 "DIMMER" ↔ "BLINK LED" ↔ "AMP  
 CANCEL" ↔ "TEL-SPEAKER" ↔ "TEL-  
 SWITCH" ↔ "SYSTEM CHECK"
3. Push the [P.CH] button upward or downward to select the "desired setting value".
  - \* In the case of display appearing "ENT", the [▶|| ENT] button must be pressed to display the setting value.
  - \* After completing settings, press the [OPTION] button to return to the previous mode.

### ● Setting the clock

- 2-1. Select "CLOCK EDIT".
- 3-1. Press the [▶|| ENT] button
- 3-2. Push the [SEEK PANEL] leftward or rightward to select the hour or the minute.
- 3-3. Push the [P.CH] button upward or downward to set the correct time.
  - \* The clock is displayed in 12-hour format.
- 3-4. Press the [▶|| ENT] button to store the time into memory.

#### Note:

- You cannot set the clock when it is displayed with only the ignition on. If you drain or remove the car's battery or take out this unit, the clock is reset. While setting the clock, if another button or operation is selected, the clock set mode is canceled.

### ● Setting the contrast

You can adjust the display contrast to match the angle of installation of the unit.

- \* The factory default setting is "8". (Adjustment level: 1 to 16)

- 2-1. Select "CONTRAST".
- 3-1. Push the [P.CH] button upward or downward to adjust the contrast.

### ● Turning the screen saver function on or off

This unit is provided with the screen saver function which allows you to show various kinds of patterns and characters in the operation status indication area of the display in a random order. You can turn on or off this function. If the button operation is performed with the screen saver function on, the operation display corresponding to the button operation is shown for about 30 seconds and the display returns to the screen saver display.

- \* The factory default setting is "Pattern RANDOM".

- 2-1. Select "SCREEN SAVER".
- 3-1. Press the [▶|| ENT] button.
- 3-2. Push the [P.CH] button upward or downward to select the setting.  
 "Pattern RANDOM" ↔ "Pattern  
 MESSAGE" ↔ "Pattern SS" ↔ "Pattern  
 OFF"
- 3-3. Press the [▶|| ENT] button to return to the previous mode.

### ● Entering message information

Message up to 30 characters long can be stored in memory and displayed as a type of screen saver setting.

- \* The factory default setting is "Welcome to Clarion".

- 2-1. Select "MSG INPUT".
- 3-1. Press the [▶|| ENT] button.
- 3-2. Press and hold the [MENU] button for 1 second or longer to clear the old message.
- 3-3. Push the [SEEK PANEL] leftward or rightward to move the cursor.

## Operations Common to Each Mode

3-4 Press the [MENU] button to select a character type. Each time you press the [MENU] button, the character type changes in the following order:

Capital letters → Small letters → Numbers/  
Symbols → Umlaut → Capital letters...

3-5. Push the [P.CH] button upward or downward to select the desired character.

3-6. Repeat step 3-3 to 3-5 to enter up to 30 characters for message.

3-7. Press and hold the [  ENT ] button for 2 seconds or longer to store the message in memory and cancel the input message mode.

\* Press and hold the [MENU] button for 1 second or longer to cancel the input message. Then press and hold the [  ENT ] button for 2 seconds or longer to store the message and the message return to the default setting.

### ● Setting the method for title scroll

Set how to scroll in CD-TEXT, MP3/WMA/AAC title.

\* The factory default setting is "ON".

2-1. Select "AUTO SCROLL".

3-1. Push the [P.CH] button upward or downward to select "ON" or "OFF".

#### • ON:

To scroll automatically.

#### • OFF:

To scroll just 1 time.

### ● Setting the speed of the title scroll

This function allows you to adjust the speed of the title scroll.

\* The factory default setting is "3".

2-1. Select "SCROLL SPEED".

3-1. Push the [P.CH] button upward or downward to select from "1" to "6".

### ● Setting the dimmer control

You can set the dimmer control "HIGH", "MID", "LOW" or "OFF".

\* The factory default setting is "MID".

2-1. Select "DIMMER".

3-1. Push the [P.CH] button upward or downward to select "HIGH", "MID", "LOW" or "OFF".

### ● Anti-theft indicator

The red Anti-theft indicator is a function for preventing theft. When the DCP is removed from the unit, this indicator blinks.

\* The factory default setting is "OFF".

2-1. Select "BLINK LED".

3-1. Push the [P.CH] button upward or downward to select "ON" or "OFF".

### ● Setting the external amplifier

\* The factory default setting is "OFF".

2-1. Select "AMP CANCEL".

3-1. Push the [P.CH] button upward or downward to select "ON" or "OFF".

#### • ON:

Use with connected AMP.

#### • OFF:

Use with inside AMP.

### ● Setting the car speaker output for the cellular phone

When the AUX input cable is used to connect a AUX BLUETOOTH BB (BLT370) (sold separately)

\* The factory default setting is "R".

\* To output the telephone calls, set the cellular phone interrupt to ON.

2-1. Select "TEL-SPEAKER".

3-1. Push the [P.CH] button upward or downward to select "R" or "L".

#### • R:

Telephone calls can be heard on the front right speaker connected to this unit.

#### • L:

Telephone calls can be heard on the front left speaker connected to this unit.

## Operations Common to Each Mode

### ● Cellular phone interrupt setting

If you connect this unit and your cellular phone with a separately sold cable, you can listen to your telephone calls on your car speakers.

When the AUX input cable is used to connect a AUX BLUETOOTH BB (BLT370) (sold separately).

\* The factory default setting is "OFF".

2-1. Select "**TEL-SWITCH**".

3-1. Push the [**P.CH**] button upward or downward to select the setting in the following order:

"OFF" ↔ "ON" ↔ "MUTE"

#### • OFF:

This unit continues normal operation even when the cellular phone is used.

#### • ON:

You can listen to your telephone calls from the speakers connected to this unit.

\* When listening to your calls on your car speakers, you can adjust the volume by pushing the [**P.CH**] button upward or downward.

#### • MUTE:

The sound from this unit is muted during telephone calls.

#### Note:

• If connecting a hands-free kit, please ensure the setting is ON to receive the telephone audio through the system.

### ● Performing a system check

2-1. Select "**SYSTEM CHECK**".

3-1. Press and hold the [**ENT**] button for 1 second or longer.

"**SYSTEM CHECK**" appears in the display, then the unit returns to the previous operation mode.

### AUX function

This system has an external input cable so you can listen to sounds and music from external devices connected to this unit.

#### ● Selecting AUX IN sensitivity

Make the following settings to select the sensitivity when sounds from external devices connected to this unit are difficult to hear even after adjusting the volume.

\* The factory default setting is "MID".

1. Press the [**OPTION**] button, "**AUX SENSE MID**" appears in the display.
2. Push the [**P.CH**] button upward or downward to select "**LOW**", "**MID**" or "**HIGH**".

### Entering titles

Titles up to 10 characters long can be stored in memory and displayed for CD, CD changer and TV stations. The number of titles that can be entered for each mode are as follows.

Mode	Number of titles
Radio mode	30 titles
CD mode	50 titles
TV mode	20 titles

CD changer mode	Number of titles
DCZ625 connected	100 titles

1. Press the [**SRC**] button to select the mode you want to enter a title (CD, CD changer or TV).
2. Select and play a CD in the CD changer or tune in to a TV station for which you want to enter the title.
3. Press the [**OPTION**] button.
4. Push the [**SEEK PANEL**] leftward or rightward to select "**TITLE INPUT**".
5. Press the [**ENT**] button.  
The display switches to the title input display.
6. Push the [**SEEK PANEL**] leftward or rightward to move the cursor.



## Operations Common to Each Mode

7. Press the **[MENU]** button to select a character. Each time you press the **[MENU]** button, the character changes in the following order:  
Capital letters → Small letters → Numbers/  
Symbols → Umlaut → Capital letters...
8. Push the **[P.CH]** button upward or downward to select the desired character.
9. Repeat steps 6 to 8 to enter up to 10 characters for the title.
10. Press and hold the **[▶|| ENT]** button for 2 seconds or longer to store the title into memory.

### Clearing titles

1. Select and play a CD in the CD changer or tune in to a TV station for which you want to clear the title.
2. Press the **[OPTION]** button.
3. Push the **[SEEK PANEL]** leftward or rightward to select "TITLE INPUT".
4. Press the **[▶|| ENT]** button.  
The display switches to the title input display.
5. Press and hold the **[MENU]** button for 1 second or longer.  
All characters in the title disappear.
6. Press and hold the **[▶|| ENT]** button for 2 seconds or longer to store the setting.

# 7. OPERATIONS OF ACCESSORIES

## USB Operations

### USB memory device operation

#### Note:

- The following operations are the same as for CD mode:
    - \* **Pause**
    - \* **Track selection**
    - \* **Fast-forward/fast-backward**
    - \* **Top function**
    - \* **Scan play**
    - \* **Repeat play**
    - \* **Random play**
    - \* **Folder selection**
    - \* **List search function**
- See "CD/MP3/WMA/AAC Operations" (page 16-19) for details.

### About USB memory

- USB is an acronym for Universal Serial Bus, and refers to an external bus standard supporting data transfer rates of 12 Mbps.
- This unit is compatible with USB 1.1/2.0 with maximum data transfer rates of 12 Mbps.
- USB memory devices that can be played by connecting to the unit's USB cable are limited to those recognized as "USB mass storage class devices"; operation is not guaranteed with all USB memory devices.
  - \* Devices compatible with "USB Mass Storage Class" can be used merely by connecting to the host device, without need for special drivers or application software.
- Consult the manufacturer of your USB memory device for information regarding whether it is supported by "USB Mass Storage Class" standards.
- Audio files playable on this unit are limited to MP3/WMA/AAC files. For details, see the section "MP3/WMA/AAC" (page 16). Copy-protected WMA/AAC files cannot be played on this unit.

- To prevent the accidental loss of data, always back up important data on your computer.
- This unit does not support connections to a computer. In addition, connections made through a USB hub device are also not supported.
- When a USB memory device is composed of two or more drives, only one of the drives will be detected.
- USB memory devices with security functions cannot be played.
- Do not connect an iPod to the USB connector, since playback and controls may not function properly. To connect an iPod, use the CeNET iPod interface. For details, see the section "iPod BB Operations" (page 26).
- The order in which tracks are recorded may differ depending on the USB memory device connected (the actual playback order may not be the same as that indicated on your computer's display).

### CAUTION

- **Insert and remove a USB memory device only when the device is not being accessed. Connecting or disconnecting the device at the following times may result in the loss of data:**
  - **If the USB memory device is removed or power is disconnected during writing to the device.**
  - **When the device is subjected to static electricity or electric noise.**
- **Do not leave a USB memory device unattended in an automobile. Exposure to direct sunlight or high temperatures may cause deformation or other malfunction of the USB memory device.**

### Connecting a USB memory device

1. Connect the USB memory device to the USB cable.

Playback will begin from the first file recorded on the USB memory device.

- \* If the USB memory device is not recognized, press the [SRC] button to switch the source to the device.
- \* Always insert the USB memory device fully into the connector. Incomplete connections may cause the USB memory device not to be recognized.
- \* Depending on the number of tracks recorded, some amount of time may be required until all tracks are read into the unit.
- \* The order in which tracks are recorded may differ depending on the USB memory device connected (the actual playback order may not be the same as that indicated on your computer's display).

### To listen to tracks on a connected USB memory device

1. Press the [SRC] button to switch the source. When USB memory device is selected, playback will begin from the location at which playback was previously stopped.
  - \* When a USB memory device is connected the USB mode will be displayed.
  - \* When a USB memory device is disconnected and then reconnected, playback will begin from the beginning of the USB memory device.

### To stop play

1. Press the [SRC] button and switch the function to a source other than the USB memory.

#### CAUTION

**Do not remove the USB memory device when the USB mode is selected, since it may result in loss or damage to data on the USB memory device.**

**Always backup and save important data on your computer.**

2. Remove the USB memory device from the USB cable.

# iPod BB Operations

## ● iPod BB

This section describes operations when connected to a CeNET iPod Interface (EA-1276B). (Hereinafter, “iPod Interface (EA-1276B)” is abbreviated as iPod BB.)

### Note:

- See the *iPod BB Owner's Manual for details regarding iPod BB connections and operation conditions.*

## Connecting an iPod

When an iPod is connected to the iPod BB interface, the “Repeat” set on the iPod will become “All repeat play” instead. Likewise, “Shuffle” set on the iPod will become as follows:

- “Shuffle (Albums)” play → Random play
- “Shuffle (Songs)” play → All random play

The iPod BB interface has two modes, the “Play mode” and the “iPod menu mode” for selecting tracks. Switch between these modes by pressing the [MENU] button.

## Select iPod BB Interface

1. Press the [SRC] button.

Playback will begin from the last file that was played on the iPod alone or through the iPod BB.

### Note:

- The following operations in Play mode operate the same as in CD mode:
  - \* **Track selection:** [SEEK PANEL]
  - \* **Fast-forward/fast-backward:** [SEEK PANEL]
  - \* **Pause:** [▶||ENT]
- See “CD/MP3/WMA/AAC Operations” (page 16-19) for details.

## Other various play functions (in Play mode)

### Notes:

- These functions are not supported when in the iPod menu mode.
- The Random function set on the iPod or when connected to iPod BB, remains the same after attachment/ detachment of the iPod.
- The iPod BB can be set simultaneously for All repeat and All random.

1. Press the [OPTION] button.

### ● Repeat play

Play back one track repeatedly.

2. Push the [SEEK PANEL] leftward or rightward to select “RPT”.
3. Push the [P.CH] button upward or downward to select “♪”, and then press the [▶||ENT] button to perform repeat play.

### ● All repeat play

Repeatedly play all tracks within a selected category.

2. Push the [SEEK PANEL] leftward or rightward to select “RPT”.
3. Push the [P.CH] button upward or downward to select “ALL”, and then press the [▶||ENT] button to perform all repeat play.

### ● Random play

Play all albums within a selected category, in random order. (Corresponds to “Shuffle (Albums)” command on iPod.)

2. Push the [SEEK PANEL] leftward or rightward to select “RDM”.
3. Push the [P.CH] button upward or downward to select “♪”, and then press the [▶||ENT] button to perform random play.

### ● All random play

Play all tracks within a selected category, in random order. (Corresponds to “Shuffle (Songs)” command on iPod.)

2. Push the [SEEK PANEL] leftward or rightward to select “RDM”.
3. Push the [P.CH] button upward or downward to select “ALL”, and then press the [▶||ENT] button to perform all random play.

## iPod BB Operations

### ● To cancel the trick play

2. Push the [SEEK PANEL] leftward or rightward to select "RPT OFF" or "RDM OFF".
3. Press the [  ENT ] button.

#### Note:

- When the all repeat play mode is canceled, playback will stop when all tracks have been played.

### Selecting category from the iPod menu

1. Press the [MENU] button.  
The iPod menu categories will be displayed.
2. Push the [P.CH] button upward or downward to switch between categories.

The iPod menu categories alternate in the following order:

"Composers" ↔ "Playlist" ↔ "Artists" ↔  
"Albums" ↔ "Songs" ↔ "Genres" ↔  
"Composers" ...

#### Note:

The iPod menu mode can be canceled by performing the following operation:

- Press the [MENU] button.
3. Push the [SEEK PANEL] rightward to select the category.
  4. When the track name display is showing, push the [SEEK PANEL] rightward.  
Playback will begin from the first track in the selected category, and the iPod menu mode will be canceled.
    - \* Subfolders may be displayed, depending on the category.  
In this case, push the [P.CH] button upward or downward to switch between subfolders, then push the [SEEK PANEL] rightward to select the desired subfolder.
    - \* When the track name display is showing, pushing the [SEEK PANEL] leftward will return the display to the currently playing folder name display.
  5. Push the [P.CH] button upward or downward to select a track within a category.
  6. Push the [SEEK PANEL] rightward to play the desired track.

### About title display

This unit supports the display of title information transmitted from a connected iPod.

- Character code information is UTF-8; displayable characters include English alphanumerics, some symbols, and some umlaut characters.
- Unsupported characters will be replaced by asterisks (\*).

# Satellite Radio Operations

This function is available when a Satellite Radio Receiver is connected through the CeNET cable.

This unit can control the following satellite radio receivers:

- XM Satellite Radio Receiver: XMD1000
- XM Smart Digital Adapter: XM SDA
- SIRIUS Satellite Radio Receiver: SIRCL2, SIRCL3

## Note:

- When the function is differ depending to the connected receiver, they are distinguished by the following notations:

"XM": for an XM Satellite Radio Receiver

"SIRIUS": for a SIRIUS Satellite Radio Receiver

## Selecting a Satellite Radio mode

1. Press the [SRC] button.

The system changes to the specified Satellite Radio mode.

## Selecting a band

1. Press the [MENU] button to select a band.

This changes the reception band as follows:

•XM: XM1 → XM2 → XM3 → XM1 ...

•SIRIUS: SR1 → SR2 → SR3 → SR1 ...

### ● Information displayed during reception

The following information is displayed when the satellite radio cannot be received normally.

- When the receiver is turned on the first time or after a reset: "UPDATING"
- When a channel is being tuned in (no signal is yet received):  
XM: "LOADING", SIRIUS: "ACQUIRING"
- A channel without a broadcast has been selected:  
XM: "-- -- CH", SIRIUS: "INVALID CH"
- A channel not covered by your contract:  
XM: "UPDATING", SIRIUS: "CALL 888" ↔ "539-SIRI" (alternated)
- When your contract is expired: "SUB UPDATE"

## Confirming your SIRIUS ID

1. Press the [OPTION] button.
2. Push the [SEEK PANEL] leftward or rightward to select "SID DISP".
3. Press the [ENT] button.  
Your SIRIUS ID will be displayed 12 digits number.
4. To return to the previous mode, press the [OPTION] button.

## Displaying channel labels

1. Press the [TITLE] button to select the desired channel label.  
Channel → Category → Title → Artist → Radio text → Channel...

## Channel selection

1. Channels are selected with the [SEEK PANEL].  
\* For details, see the following operation descriptions.

## Note:

- The audio output is muted and other button operations are not accepted during channel selection.

## Tuning mode

There are two channel selection modes: quick tuning mode and step tuning mode.

### ● Quick tuning

1. Push the [SEEK PANEL] leftward or rightward and hold in position for 1 second or longer.

### ● Step tuning

1. Push the [SEEK PANEL] leftward or rightward.

## Satellite Radio Operations

### Recalling a preset station

A total of 18 satellite radio stations can be stored.

- **XM:** 6-XM1, 6-XM2 and 6-XM3
- **SIRIUS:** 6-SR1, 6-SR2 and 6-SR3

This allows you to store your favorite satellite radio stations in memory for later recall.

1. Press the **[MENU]** button to select the desired band.
2. Push the **[P.CH]** button upward or downward to select the desired preset station.

### Preset memory

1. Press the **[MENU]** button to select the desired band.
2. Select the desired channel with quick tuning or step tuning.
3. Press the **[▶|| ENT]** button to enter the P.CH memory screen.
4. Push the **[P.CH]** button upward or downward to select the desired preset channel.
5. Press and hold the **[▶|| ENT]** button for 2 seconds or longer to store the current channel into preset memory.

### Receiving stations selected by category

Satellite Radio allows you to select broadcast channel category (contents).

1. Press and hold the **[MENU]** button for 1 second or longer to select the category selection mode.
  - \* It press once again, return to the channel selection mode.
2. Push the **[P.CH]** button upward or downward to change the category item.
3. Push the **[SEEK PANEL]** leftward or rightward to tune in a station.

#### Note:

- When the category selection mode is entered, the category of the last received channel is displayed first.
- The category selection mode is canceled when no channel with the selected category can be found.
- If the **[SEEK PANEL]** are not pushed within 7 seconds, the category selection mode is canceled, and resumes to the channel mode.

### Scan function

There are two scan modes: the category scan mode and the preset scan mode.

During scanning channels are displayed in abbreviated form, the display mode cannot be switched.

#### ● Category scan (CATEGORY SCN)

In a category scan, broadcast channels in the same category as the current channel are selected about every 10 seconds.

1. Press the **[OPTION]** button.
2. Push the **[SEEK PANEL]** leftward or rightward to select "**CATEGORY SCN**".
3. Press the **[▶|| ENT]** button.

#### Note:

- Category scanning is not available when no category is defined for the current channel.

#### ● Preset scan (PRESET SCN)

A preset scan scans the channels (up to 18 channels) stored in the preset memory about every 10 seconds.

1. Press the **[OPTION]** button.
2. Push the **[SEEK PANEL]** leftward or rightward to select "**PRESET SCN**".
3. Press the **[▶|| ENT]** button.

# CD Changer Operations

## Note:

• The following operations are the same as for CD mode:

\* **Pause**

\* **Track selection**

\* **Fast-forward/fast-backward**

\* **Scan play**

\* **Repeat play**

\* **Random play**

See "CD/MP3/WMA/AAC Operations" (page 16-19) for details.

## CD changer functions

When an optional CD changer is connected through the CeNET cable, this unit controls all CD changer functions. This unit can control a total of 2 changers.

Press the [SRC] button and select the CD changer mode to start play. If 2 CD changers are connected, press the [SRC] button to select the CD changer for play.

\* If "NO MAGAZINE" appears in the display, insert the magazine into the CD changer. "DISC CHECK" appears in the display while the player loads (checks) the magazine.

\* If "NO DISC" appears in the display, eject the magazine and insert discs into each slot. Then, reinsert the magazine back into the CD changer.

## Note:

• Some CDs recorded in CD-R/CD-RW mode may not be usable.

## ⚠ CAUTION

**CD-ROM discs cannot be played from every CD changer, it's depended on the model.**

## Displaying CD titles

This unit can display title data for CD-text CDs and user titles input with this unit.

1. Press and hold the [TITLE] button for 1 second or longer to display the title.
2. Press the [TITLE] button to change the title display.

## Procedure to scroll a title

Set "AUTO SCROLL" to "ON" or "OFF".

(The factory default setting is "ON". Refer to the subsection "Setting the method for title scroll" in section "Operations Common to Each Mode".)

### ● When set to "ON"

The title is automatically kept scrolling.

### ● When set to "OFF"

To scroll just 1 time.

## Note:

• User title can't scroll.

## Selecting a CD

1. Push the [P.CH] button upward or downward to select a desired disc in the magazine.

\* If a CD is not loaded in a slot of magazine, "NO DISC" appears in the display

## Other various play functions

### ● Disc scan play

Disc scan play locates and plays the first 10 seconds of the first track on each disc in the currently selected CD changer. This function continues automatically until it is cancelled.

\* Disc scan play is useful when you want to select a desired CD.

1. Press the [OPTION] button.
2. Push the [SEEK PANEL] leftward or rightward to select "SCN".
3. Push the [P.CH] button upward or downward to select "ALL", and then press the [▶|| ENT] button. "DISC SCN" appears in the display and disc scan play starts.

### ● Disc repeat play

After all the tracks on the current disc have been played, disc repeat play automatically replays the current disc over from the first track. This function continues automatically until it is cancelled.

1. Press the [OPTION] button.
2. Push the [SEEK PANEL] leftward or rightward to select "RPT".
3. Push the [P.CH] button upward or downward to select "ALL", and then press the [▶|| ENT] button. "DISC RPT" appears in the display and disc repeat play starts.



## CD Changer Operations

### ● Disc random play

The disc random play selects and plays individual tracks or discs automatically in no particular order. This function continues automatically until it is cancelled.

1. Press the [OPTION] button.
2. Push the [SEEK PANEL] leftward or rightward to select "RDM".
3. Push the [P.CH] button upward or downward to select "ALL", and then press the [▶||ENT] button. "DISC RDM" appears in the display and disc random play starts.

### ● To cancel the trick play

1. Press the [OPTION] button.
2. Push the [SEEK PANEL] leftward or rightward to select "TRICK OFF".
3. Press the [▶||ENT] button to cancel the trick play.

## DVD Changer Operations

By connecting an optional DVD changer that supports CeNET wiring, this unit can be used to control the DVD changer. To view DVDs, an optional monitor is required.

- The DVD control and display functions supported by this unit are limited; the unit does not support all the functions possible on a DVD changer.

For fullest functionality, use the remote control unit provided with your DVD changer to control its operations. For details, consult the Owner's Manual provided with your DVD changer.

### **Note:**

- The following operations are the same as for CD and CD Changer modes:

\***Pause**

\***Track selection**

\***Fast-forward/fast-backward**

\***Scan play**

\***Repeat play**

\***Random play**

See "CD/MP3/WMA/AAC Operations" (page 16-19) and "CD Changer Operations" (page 30-31) for details.

# TV Operations

## Note:

- The following operations are performed the same as for radio mode:

- \* **Channel selection**

- \* **Storing channels in memory**

- \* **Calling channels from memory**

- \* **Auto store**

- \* **Preset scan**

See "**Radio Operations**" (page 14-15) for details.

## TV tuner functions



When an optional TV tuner is connected through the CeNET cable, this unit controls all TV tuner functions. To watch TV requires a TV tuner and monitor.

### Watching a TV

1. Press the [**SRC**] button and select the TV mode.
2. Press the [**MENU**] button to select the desired TV band (TV1 or TV2). Each time the button is pressed, the input selection toggles between TV1 and TV2.
3. Push the [**SEEK PANEL**] leftward or rightward to tune in the desired TV station.

### Watching a video

The TV tuner has a VTR input terminal to which 1 external device can be connected. Connect a 12 V video cassette player (VCP) or video cassette recorder (VCR) to the TV tuner input terminal.

1. Press the [**OPTION**] button.
2. Push the [**SEEK PANEL**] leftward or rightward to select "**TV/VTR**".
3. Press the [  **ENT** ] button to enter the VTR mode.
4. To return to the TV broadcast, press the [**OPTION**] button.
5. Press the [  **ENT** ] button to return to the TV mode.

## Setting the TV diver

You can change the reception setting for the TV antenna connected to the TV tuner.

1. Press the [**OPTION**] button to switch to the adjustment selection display.
2. Push the [**SEEK PANEL**] leftward or rightward to select "**TV DIVER**".
3. Push the [**P.CH**] button upward or downward to set to "**ON**" or "**OFF**".
  - **ON:**  
Sets the diver setting to ON.
  - **OFF:**  
Sets the diver setting to OFF.
4. Press the [**OPTION**] button to return to the previous mode.

# 8. IN CASE OF DIFFICULTY

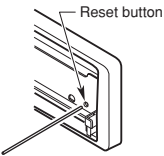
	Problem	Cause	Measure
General	Power does not turn on. (No sound is produced.)	Fuse is blown.	Replace with a fuse of the same amperage. If the fuse blows again, consult your store of purchase.
		Incorrect wiring.	Consult your store of purchase.
	No sound output when operating the unit with amplifiers or power antenna attached.	Power antenna lead is shorted to ground or excessive current is required for remote-on the amplifiers or power antenna.	<ol style="list-style-type: none"> <li>1. Turn the unit off.</li> <li>2. Remove all wires attached to the power antenna lead. Check each wire for a possible short to ground using an ohm meter.</li> <li>3. Turn the unit back on.</li> <li>4. Reconnect each amplifier remote wire to the power antenna lead one by one. If the amplifiers turn off before all wires are attached, use an external relay to provide remote-on voltage (excessive current required).</li> </ol>
	Nothing happens when buttons are pressed.  Display is not accurate.	The microprocessor has malfunctioned due to noise, etc.	Turn off the power, then press the <b>[RELEASE]</b> button and remove the DCP. Press the reset button for about 2 seconds with a thin rod. 
		DCP or main unit connectors are dirty.	Wipe the dirt off with a soft cloth moistened with cleaning alcohol.
	No sound heard	The speaker protection circuit is operating.	<ol style="list-style-type: none"> <li>1. Turn down sound volume. Function can also be restored by turning the power off and on again. (Speaker volume is reduced automatically when the speaker protection circuit operates).</li> <li>2. If the sound is muted again, consult our service department.</li> </ol>
CD/MP3/WMA/AAC	No sound heard	MP3/WMA/AAC files are absent in a disc.	Write MP3/WMA/AAC files onto the disc properly.
		Files are not recognized as an MP3/WMA/AAC file.	Use MP3/WMA/AAC files encoded properly.
		File system is not correct.	Use ISO9660 level 1, 2 or JOLIET or Romeo or APPLE ISO file system.
	Sound skips or is noisy.	Compact disc is dirty.	Clean the compact disc with a soft cloth.
		Compact disc is heavily scratched or warped.	Replace with a compact disc with no scratches.
	Sound is cut or skipped. Noise is generated or noise is mixed with sound.	MP3/WMA/AAC files are not encoded properly.	Use MP3/WMA/AAC files encoded properly.
	Sound is bad directly after power is turned on.	Water droplets may form on the internal lens when the car is parked in a humid place.	Let dry for about 1 hour with the power on.
Wrong filename	File system is not correct.	Use ISO9660 level 1, 2 or JOLIET or Romeo or APPLE ISO file system.	

	Problem	Cause	Measure
USB	No sound heard.	The USB memory device contains no MP3/WMA/AAC files.	Record MP3/WMA/AAC files properly to the USB memory device.
		The files are not proper MP3/WMA/AAC format.	Use only properly encoded MP3/WMA/AAC files.
		Files are DRM copyright protected.	See page 16 for details on how to cancel DRM protection.
		Connectors are loose.	Disconnect the USB memory device and reconnect securely.
	Sound is interrupted or has noise.	The MP3/WMA/AAC files are improperly encoded.	Use only properly encoded MP3/WMA/AAC files.
	USB memory device isn't recognized.	The USB memory device is damaged.	Disconnect the USB memory device and reconnect. If the device is still not recognized, try replacing with a different USB memory device.
		Connectors are loose.	
	Can't insert USB memory device.	The USB memory devices has been inserted improperly.	Try reversing the connection direction of the USB device (usually the brand name surface should be facing left).
The USB connector is broken.		Replace with a new USB memory device.	

# 9. ERROR DISPLAYS

If an error occurs, one of the following displays is displayed.  
Take the measures described below to eliminate the problem.

	Error Display	Cause	Measure
CD/MP3/WMA/AAC	<b>ERROR 2</b>	A CD is caught inside the CD deck and is not ejected.	This is a failure of CD deck's mechanism and consult your store of purchase.
	<b>ERROR 3</b>	A CD cannot be played due to scratches, etc.	Replace with a non-scratched, non-warped-disc.
	<b>ERROR 6</b>	A CD is loaded upside-down inside the CD deck and does not play.	Eject the disc then reload it properly.
CD changer	<b>ERROR 2</b>	A CD inside the CD changer is not loaded.	This is a failure of CD changer's mechanism and consult your store of purchase.
	<b>ERROR 3</b>	A CD inside the CD changer cannot be played due to scratches, etc.	Replace with a non-scratched, non-warped disc.
	<b>ERROR 6</b>	A CD inside the CD changer cannot be played because it is loaded upside-down.	Eject the disc then reload it properly.
DVD changer	<b>ERROR 2</b>	A DISC inside the DVD changer cannot be played.	This is a failure of DVD mechanism and consult your store of purchase.
	<b>ERROR 3</b>	A DISC cannot be played due to scratches, etc.	Retry or replace with a non-scratched, non-warped-disc.
	<b>ERROR 6</b>	A DISC inside the DVD changer cannot be played because it is loaded upside-down.	Eject the disc then reload it properly.
	<b>ERROR P</b>	Parental level error	Set the correct Parental level.
	<b>ERROR R</b>	Region code error	Eject the disc and replace correct region code disc.
iPod	<b>ERROR 1</b>	A communication error occurs between the iPod and the iPod CeNET Controller.	Disconnect the iPod, then connect it again.
	<b>NO IPOD</b>	There is no iPod connected.	Please connect the iPod.
USB	<b>ERROR 1</b>	Device mechanism is damaged.	The unit's mechanism may be damaged. Consult your dealer.
	<b>NO FILE</b>	USB memory device contains no audio files.	Insert USB memory device containing audio files.
	<b>DSP ERROR</b>	USB connector is short-circuited or USB memory device is overloaded.	Disconnect USB memory device, then hold [SRC] button depressed to turn power OFF. Then press [SRC] button once again to turn power ON.

If an error display other than the ones described above appears, press the reset button. If the problem persists, turn off the power and consult your store of purchase.

# 10. SPECIFICATIONS

## FM Tuner

Frequency Range: 87.9 MHz to 107.9 MHz  
 Usable Sensitivity: 9 dBf  
 50dB Quieting Sensitivity: 15 dBf  
 Alternate Channel Selectivity: 70 dB  
 Stereo Separation (1 kHz): 35 dB  
 Frequency Response ( $\pm 3$  dB): 30 Hz to 15 kHz

## AM Tuner

Frequency Range: 530 kHz to 1710 kHz  
 Usable Sensitivity: 25  $\mu$ V

## CD Player

System: Compact disc digital audio system  
 Usable Discs: Compact disc  
 Frequency Response ( $\pm 1$  dB): 5 Hz to 20 kHz  
 Dynamic Range (1 kHz): 95 dB  
 Harmonic Distortion: 0.01%

## Audio

Maximum Power Output: 212 W (53 W  $\times$  4 ch)  
 Bass Control Action (80 Hz): +14 dB, -14 dB  
 Treble Control Action (10 kHz): +12 dB, -12 dB  
 Line Output Level (CD 1 kHz): 5.6 V

### Note:

• Specifications and design are subject to change without notice for further improvement.

## General

Power Supply Voltage:  
 14.4 V DC (10.8 to 15.6 V allowable), negative ground  
 Current Consumption: Less than 15 A  
 Speaker Impedance: 4  $\Omega$  (4  $\Omega$  to 8  $\Omega$  allowable)  
 Auto Antenna Rated Current: 500 mA or less  
 Weight / Source unit: 2.75 lb. (1.6 kg)  
 Weight / Remote control unit:  
 1.41 oz. (40 g) (including battery)  
 Dimensions / Source unit:  
 7" (Width)  $\times$  2" (Height)  $\times$  6-1/8" (Depth)  
 [178 (W)  $\times$  50 (H)  $\times$  158 (D) mm]  
 Dimensions / Remote control unit:  
 1-3/4" (Width)  $\times$  4-5/16" (Height)  $\times$  7/16"  
 (Depth)  
 [44 (W)  $\times$  113 (H)  $\times$  11 (D) mm]

### Power Output :

19 W RMS x 4 Channels at 4  $\Omega$   
 and 1 % THD+N

### Signal to Noise Ratio:

85 dBa (reference: 1 W into 4  $\Omega$ )



# Clarion Co., Ltd.

---

All Rights Reserved. Copyright © 2006: Clarion Co., Ltd.  
Printed in China / Imprimé en Chine / Impreso en China

**PE-2901B**  
**280-8467-00**

2006/12

## Free Manuals Download Website

<http://myh66.com>

<http://usermanuals.us>

<http://www.somanuals.com>

<http://www.4manuals.cc>

<http://www.manual-lib.com>

<http://www.404manual.com>

<http://www.luxmanual.com>

<http://aubethermostatmanual.com>

Golf course search by state

<http://golfingnear.com>

Email search by domain

<http://emailbydomain.com>

Auto manuals search

<http://auto.somanuals.com>

TV manuals search

<http://tv.somanuals.com>