

clarion®

Owner's manual

使用说明书

사용 설명서

WXZ466MP

2-DIN 6-disc CD/MP3/WMA Receiver / CeNET Control

2-DIN 6碟CD/MP3/WMA接收器/ CeNET控制

2DIN 6디스크 CD/MP3/WMA 리시버/CeNET 컨트롤

Thank you for purchasing this **Clarion** product.

- * Please read this owner's manual in its entirety before operating this equipment.
- * After reading this manual, be sure to keep it in a handy place (e.g., glove compartment).
- * This manual includes the operating procedures of the CD changer and TV tuner connected via the CeNET cable. The CD changer and TV tuner have their own manuals, but no explanations for operating them are described.

Contents

1. FEATURES	2
2. PRECAUTIONS	3
Handling Compact Discs	4
3. CONTROLS	5
Display Items	5
Display Screen	5
4. NOMENCLATURE	6
Names of the Buttons and their Functions	6
Major Button Operations When External Equipment is Connected to This Unit	7
5. REMOTE CONTROL	8
Inserting the Battery	8
Functions of the Remote Control Unit Buttons	9
6. OPERATIONS	10
Basic Operations	10
Radio Operations	13
CD/MP3/WMA Operations	14
Common Operations	18
7. OPERATIONS OF ACCESSORIES	22
CD Changer Operations	22
TV Operations	24
8. TROUBLE SHOOTING	26
9. ERROR DISPLAYS	28
10. SPECIFICATIONS	29

1. FEATURES



- Built-in 6 disc CD changer & MP3/WMA compatible
- VF display with spectrum analyser and message information
- "Digital Z-Enhancer" and "Listening Position Optimizer" for Sound Creation

2. PRECAUTIONS

1. When the inside of the car is very cold and the player is used soon after switching on the heater moisture may form on the disc or the optical parts of the player and proper playback may not be possible. If moisture forms on the disc, wipe it off with a soft cloth. If moisture forms on the optical parts of the player, do not use the player for about one hour. The condensation will disappear naturally allowing normal operation.
2. Driving on extremely bumpy roads which cause severe vibration may cause the sound to skip.
3. This unit uses a precision mechanism. Even in the event that trouble arises, never open the case, disassemble the unit, or lubricate the rotating parts.

⚠ CAUTION

USE OF CONTROLS, ADJUSTMENTS, OR PERFORMANCE OF PROCEDURES OTHER THAN THOSE SPECIFIED HEREIN, MAY RESULT IN HAZARDOUS RADIATION EXPOSURE.



THE COMPACT DISC PLAYER and MINI DISC PLAYER SHOULD NOT BE ADJUSTED OR REPAIRED BY ANYONE EXCEPT PROPERLY QUALIFIED SERVICE PERSONNEL.

CHANGES OR MODIFICATIONS NOT EXPRESSLY APPROVED BY THE MANUFACTURER FOR COMPLIANCE COULD VOID THE USER'S AUTHORITY TO OPERATE THE EQUIPMENT.

INFORMATION FOR USERS:

CHANGES OR MODIFICATIONS TO THIS PRODUCT NOT APPROVED BY THE MANUFACTURER WILL VOID THE WARRANTY.

Handling Compact Discs

Use only compact discs bearing the  or  mark.

Do not play heart-shaped, octagonal, or other specially shaped compact discs.

Some CDs recorded in CD-R/CD-RW mode may not be usable.

Handling

• Compared to ordinary music CDs, CD-R and CD-RW discs are both easily affected by high temperature and humidity and some of CD-R and CD-RW discs may not be played. Therefore, do not leave them for a long time in the car.

• New discs may have some roughness around the edges. If such discs are used, the player may not work or the sound may skip. Use a ball-point pen or the like to remove any roughness from the edge of the disc.

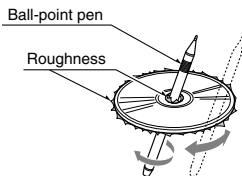

• Never stick labels on the surface of the compact disc or mark the surface with a pencil or pen.

• Never play a compact disc with any cellophane tape or other glue on it or with peeling off marks. If you try to play such a compact disc, you may not be able to get it back out of the CD player or it may damage the CD player.

- Do not use compact discs that have large scratches, are misshapen, cracked, etc. Use of such discs may cause misoperation or damage.
- To remove a compact disc from its storage case, press down on the center of the case and lift the disc out, holding it carefully by the edges.
- Do not use commercially available CD protection sheets or discs equipped with stabilizers, etc. These may damage the disc or cause breakdown of the internal mechanism.

Storage

- Do not expose compact discs to direct sunlight or any heat source.
- Do not expose compact discs to excess humidity or dust.
- Do not expose compact discs to direct heat from heaters.

Cleaning

- To remove fingermarks and dust, use a soft cloth and wipe in a straight line from the center of the compact disc to the circumference.
- Do not use any solvents, such as commercially available cleaners, anti-static spray, or thinner to clean compact discs.
- After using special compact disc cleaner, let the compact disc dry off well before playing it.

⚠ WARNING

About a Single CD (8cm CD)

- Since the unit is not compatible with a single CD, do not load it into the unit.
- Keep in mind the fact that a single CD cannot be played even using a single CD adaptor for the unit.
- If you try to push it into the unit forcibly without removing it, the CD cannot be ejected. This will result in damage to the mechanism. Please never do this.

Be sure to unfold and read the next page. / 务必打开并阅读下一页。

이 페이지를 펼친 채로 다음 페이지를 읽어 주십시오.

3. CONTROLS / 控制键 / 컨트롤

Source unit / 主机 / 본체

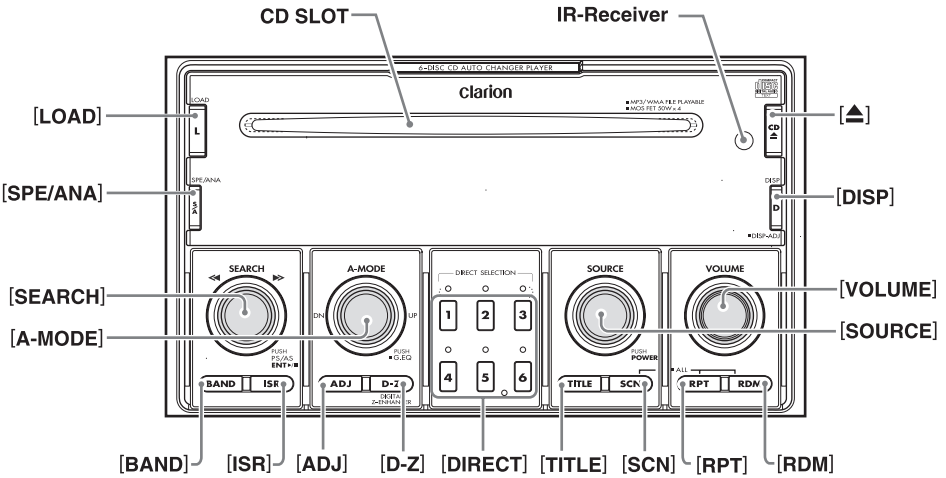

Display Items / 显示选项 / 화면 표시 항목

<p>Source indication 音源指示 음원 표시</p>	<p>Preset channel indication (1 to 6) Disc number indication (1 to 6) 预置频道指示 (1~6) 光盘号指示 (1~6) 프리셋 채널 표시 (1~6) 디스크 번호 표시 (1~6)</p>	<p>Operation status indication Titles, clock, etc. are displayed. 操作状态指示 显示标题、时钟等 작동 상태 표시 타이틀, 시간 등이 표시됩니다.</p>
<p>Spectrum analyzer display 频谱分析显示 스펙트럼 분석기 표시</p>	<p>Function indication 功能指示 기능 표시</p>	

Display Screen / 显示屏 / 표시 화면

In extreme cold, the screen movement may slow down and the screen may darken, but this is normal. The screen will recover when it returns to normal temperature.

在极冷的状态下，屏幕显示可能变慢并且屏幕变黑，但这属于正常现象。回到正常温度后，屏幕将恢复原状。

매우 추운 상태에서 화면의 움직임이 느려지고 화면이 어두워질 수도 있지만, 이것은 정상입니다. 통상적인 온도로 돌아가면 화면은 다시 원상태로 회복될 것입니다.

Note: Be sure to unfold this page and refer to the front diagrams as you read each chapter.

注: 请务必打开此页, 并在阅读每一章节时参照上面的正视图。

주: 이 페이지를 펼쳐두고, 각 장을 읽을 때 전면 그림을 참조하십시오.

4. NOMENCLATURE

Notes:

- Be sure to read this chapter referring to the front diagrams of chapter "3. CONTROLS" on page 5 (unfold).

Names of the Buttons and their Functions

[CD SLOT]

- CD insertion slot.

IR-Receiver

- Receiver for remote control unit. (Operating range: 30° in all directions)

[▲] button

- Ejects a disc.
- Press and hold for 1 second or longer to eject all discs.

[DISP] button

- Switches the display indication (main display, title display, and clock display).
- Press and hold for 1 second or longer to switch to the display adjust mode.

[VOLUME] knob

- Turn to adjust the volume.

[RDM] button

- Performs random play while in the CD/MP3 mode.
- Press and hold for 1 second or longer to perform all random play.

[RPT] button

- Repeats play while in the CD/MP3 mode.
- Press and hold for 1 second or longer to perform all repeat play.

[SOURCE] knob (PUSH POWER)

- Turn to switch the operation mode among the radio mode, etc.
- Press to turn on the power.
- Press and hold for 1 second or longer to turn off the power.

[SCN] button

- Performs scan play for 10 seconds of each track while in the CD/MP3 mode.
- Press and hold for 1 second or longer to perform all scan play.

[TITLE] button

- Switches the titles.
- Press and hold for 1 second or longer to input or scroll the title.

[DIRECT] buttons

- Stores a station into memory or recalls it directly while in the radio mode.
- Selects the disc.

[A-MODE] knob (PUSH G.EQ)

- Turn to select the folder. (MP3/WMA disc only)
- Press to switch to the audio mode (LPO, D-Z LEVEL, G.EQ EDIT, BASS, TREBLE, BALANCE, FADER).
- Press and hold for 1 second or longer to turn on or off the G.EQ.

[D-Z] button

- Selects one of the 3 types of sound characteristics preset in memory.

[ADJ] button

- Switches to the adjust mode.

[SEARCH] knob (PUSH PS/AS, ►II, ENT)

- Turn to select a station while in the radio mode or selects a track while in the CD/MP3 mode.
- Turn for 1 second or longer to switch the fast-forward/fast-rewind.
- Press to perform preset scan in the radio mode. Press and hold for 2 seconds or longer to perform auto store.
- Press to play or pause a CD while in the CD/MP3 mode.

[ISR] button (Instant station recall)

- Recalls ISR radio station in memory.
- Press and hold for 2 seconds or longer: Stores current station into ISR memory (radio mode only).

[BAND] button

- Switches the band.
- Press and hold for 1 second or longer to switch seek or manual tuning.
- Press and hold for 1 second or longer to switch the track type to play in the CD/MP3 mode.

[SPE/ANA] button

- Switches the spectrum analyzer pattern (Scan, Pattern 1 to 7, Off).

[LOAD] button

- Inserts a disc.
- Press and hold for 1 second or longer to insert two or more discs.

Major Button Operations When External Equipment is Connected to This Unit

● When the CD/DVD changer is connected

- * For details, see the section "CD Changer Operations". For the DVD changer, refer to the Owner's Manual provided with the DVD changer.

[DISP] button

- Switches the display indication (main display, title display, and clock display).

[RDM] button

- Performs random play.
- Press and hold for 1 second or longer to perform disc random play.

[RPT] button

- Performs repeat play.
- Press and hold for 1 second or longer to perform disc repeat play.

[SCN] button

- Performs scan play for 10 seconds of each track.
- Press and hold for 1 second or longer to perform disc scan play.

[TITLE] button

- Switches the titles.
- Press and hold for 1 second or longer to input or scroll the title. (only CD changer)

[DIRECT] buttons

- Selects the disc.

[SEARCH] knob (PUSH PS/AS, ►II, ENT)

- Turn to repeat or advance a track when listening to a disc.
- Turn for 1 second or longer to switch the fast-forward/fast-rewind.
- Press to play or pause a CD or DVD.

● When the TV is connected

- * For details, see the section "TV Operations".

[DIRECT] buttons

- Stores a station into memory or recalls it directly.

[ADJ] button

- Press and hold for 1 second or longer to switch the TV picture mode or VTR (external) picture mode.

[SEARCH] knob (PUSH PS/AS, ►II, ENT)

- Turn to select a station.
- Press to perform preset scan. Press and hold for 2 seconds or longer to perform auto store.

[BAND] button

- Switches the band.
- Press and hold for 1 second or longer to switch seek or manual tuning.

5. REMOTE CONTROL

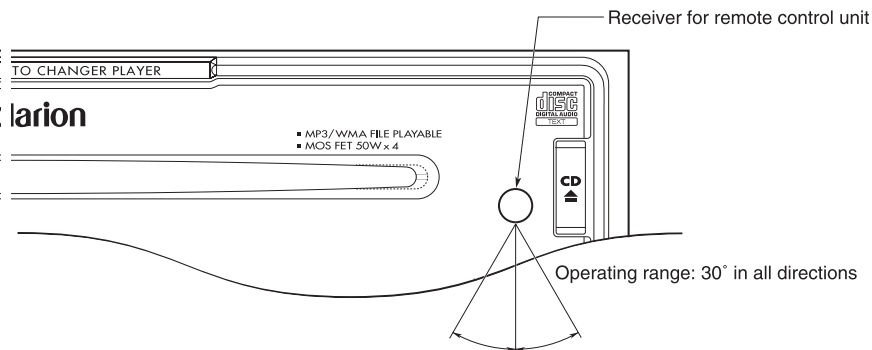

Remote control unit

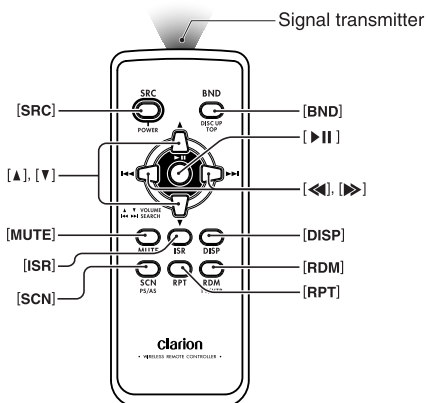

Inserting the Battery

- ① Turn over the remote control unit and slide the cover in the direction indicated by the arrow in the illustration.
- ② Insert the battery (CR2025) into the insertion guides, with the printed side (+) facing upwards.
- ③ Press the battery in the direction indicated by the arrow so that it slides into the compartment.
- ④ Replace the cover and slide in until it clicks into place.

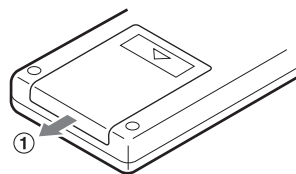

Notes:

Misuse may result in rupture of the battery, producing leakage of fluid and resulting in personal injury or damage to surrounding materials. Always follow these safety precautions:

- Use only the designated battery .
- When replacing the battery, insert properly, with +/- polarities oriented correctly.
- Do not subject battery to heat, or dispose of in fire or water. Do not attempt to disassemble the battery.
- Dispose of used batteries properly.

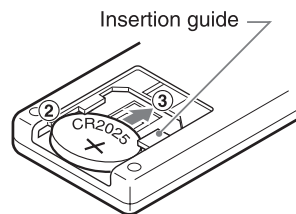

Functions of the Remote Control Unit Buttons

Mode Button	Radio	CD/MP3	CD changer DVD changer	TV
[SRC]	Switches among radio, CD/MP3, CD changer, DVD changer, TV and AUX.			
[BND]	Switches reception band.	Moves the next disc in increasing order.		Switches reception band.
[▲], [▼]	Increases and decreases volume (in all modes).			
[◀], [▶]	Moves preset channels up and down.	Moves tracks up and down. When pressed and held for 1 second or longer: Fast-forward/fast-rewind.		Moves preset channels up and down.
[▶▶]	No function.	Switches between playback and pause.		No function.
[MUTE]	Turns mute on and off.			
[ISR]	Recalls ISR radio station in memory. When pressed and held for 2 seconds or longer: Stores current station into ISR memory (radio mode only).			
[DISP]	Switches among main display, title display, and clock display. When pressed and held for 1 second or longer: Switches the titles (except in the radio, DVD changer, TV mode).			
[SCN]	Preset scan. When pressed and held for 2 seconds or longer: Auto store.	Scan play. When pressed and held for 1 second or longer: All scan play.	Scan play. When pressed and held for 1 second or longer: Disc scan play.	Preset scan. When pressed and held for 2 seconds or longer: Auto store.
[RPT]	No function.	Repeat play. When pressed and held for 1 second or longer: All repeat play.	Repeat play. When pressed and held for 1 second or longer: Disc repeat play.	No function.
[RDM]	No function.	Random play. When pressed and held for 1 second or longer: All random play.	Random play. When pressed and held for 1 second or longer: Disc random play.	Switches between TV and VTR.

* Some of the corresponding buttons on the main unit and remote control unit have different functions.

6. OPERATIONS

Basic Operations

Note: Be sure to read this chapter referring to the front diagrams of chapter "3. CONTROLS" on page 5 (unfold).

⚠ CAUTION

Be sure to lower the volume before switching off the unit power or the ignition key. The unit remembers its last volume setting. If you switch the power off with the volume up, when you switch the power back on, the sudden loud volume may hurt your hearing and damage the unit.

Turning on/off the power

Note:

- Be careful about using this unit for a long time without running the engine. If you drain the car's battery too far, you may not be able to start the engine and this can reduce the service life of the battery.

1. Press the [SOURCE] knob.
2. The illumination and display on the unit light up. The unit automatically remembers its last operation mode and will automatically switch to display that mode.
3. Press and hold the [SOURCE] knob for 1 second or longer to turn off the power for the unit.

Note:

- **Disk check**
This unit will check the discs inside it when you turn on the power for the first time after wiring or when you press the reset button.
- **System check**
During the initial power up of this unit, it will go through a system check procedure. This procedure verifies any devices connected through CeNET. Any additional CeNET devices plugged into the unit after the initial power up will initiate the system check procedure. When the power is turned on, "SYS CHECK" appears in the display if the wire connections were modified. The system check starts automatically within the unit.

Selecting a mode

1. Turn the [SOURCE] knob to change the operation mode.
2. Each time you turn the [SOURCE] knob, the operation mode changes in the following order:

Radio mode ↔ CD/MP3 mode ↔ CD changer mode ↔ DVD changer mode ↔ TV mode ↔ AUX mode ↔ Radio mode...

- * External equipment not connected through CeNET will not be displayed.

Adjusting the volume

1. Turn the [VOLUME] knob to adjust the volume.
 - * The volume level is from 0 (minimum) to 33 (maximum).

Switching the display

● When the power is turned on

1. Each time you press the [DISP] button, the display switches in the following order:

● Radio mode

Main display (frequency) → Title display → Clock display ...

● CD/MP3 mode

Folder/Track No. display (MP3/WMA disc only) → Main display (Play time) → Title display → Clock display ...

- * Once selected, the preferred display becomes the display default. When a function adjustment such as volume is made, the screen will momentarily switch to that function's display, then revert back to the preferred display several seconds after the adjustment.

- * When you have entered a title in a CD/MP3/WMA, it appears in the display. If you have not entered a title, "NO TITLE" appears in the display. For information on how to enter a title, refer to the subsection "Entering titles" in the section "Common Operations".

● When the power is turned off

1. Each time you press the [DISP] button, the display switches in the following order:

Clock display → Display off → Clock display...

● When the display is turned on

1. Press the [SPE/ANA] button for 1 second or longer to turn off the display.

To turn on the display, press the [SPE/ANA] button again or press the [DISP] button.

- * The following buttons are valid while the display is turned off.

[SOURCE] / [VOLUME] / [ISR] / [LOAD] / [▲]

Setting the spectrum analyzer pattern

* The factory default setting is "SCAN".

- Each time you press the [SPE/ANA] button, the spectrum analyzer pattern changes in the following order:

Scan → Pattern 1 to 7 → Off → Scan ...

* The bars in the display move downward before scanning begins.

Setting the G.EQ (Graphic Equalizer)

This adjustment can only be performed when the DZE is set to "DZE OFF".

* The factory default setting is "ON".

- Press and hold the [A-MODE] knob for 1 second or longer to turn on the G.EQ effect. "G.EQ" appears on the display.
- Press and hold the [A-MODE] knob for 1 second or longer to turn off the G.EQ effect. "G.EQ OFF" appears on the display.

Setting the DZE (Digital Z-Enhancer)

This unit is provided with 3 types of sound tone effects stored in memory. Select the one you prefer.

* The factory default setting is "DZE OFF".

Each time you press the [D-Z] button, the tone effect changes in the following order:

"DZE 1" → "DZE 2" → "DZE 3" → "DZE OFF" → "DZE 1" ...

- DZE 1 : suitable for the genuine speakers
- DZE 2 : suitable for separate speakers
- DZE 3 : suitable for coaxial speakers
- DZE OFF : no sound effect

Notes:

- The volume changes each time the DZE (Digital Z-Enhancer) setting is switched.
- Sufficient effects cannot be obtained with some speaker systems. In such cases, adjust the volume.

Adjusting the tone

Press the [A-MODE] knob and select the item to adjust. Each time you press the [A-MODE] knob, the item changes as following order:

●When "DZE 1, 2, 3" is set

"LPO" → "DZE LEVEL" → "BALANCE" → "FADER" → Last function mode...

●When "DZE OFF" is set

"LPO" → "G.EQ EDIT" → "BASS" → "TREBLE" → "BALANCE" → "FADER" → Last function mode...

Note:

- The display automatically returns to the previous mode.

Adjusting the LPO (Listening Position Optimizer)

This is the function that virtually optimizes the speaker distances of each type of a car to the listening position, which realizes the clearer soundstage.

The setting value has to be adjusted to the listening position and the type of your car.

* The factory default setting is "OFF".

- Press the [A-MODE] knob and select "LPO".
- Turn the [A-MODE] knob to select the listening position. The adjustment items you can select are as follows: **L3, L2, L1, OFF, R1, R2, R3**.

●The setting value of the listening position

L: left seat, R: right seat, 1.: COMPACT (compact car), 2.: SEDAN (sedan), 3.: 1 BOX (van)

- When the adjustment is complete, press the [A-MODE] knob several times until the function mode is reached.

Adjusting the DZE level

You can adjust the DZE level in 3 steps and register each adjustment respectively.

This adjustment can only be performed when the DZE is set to "DZE 1,2,3".

- Press the [A-MODE] knob and select "DZE LEVEL".
- Turn the [A-MODE] knob to adjust the level.
 - * The factory default setting is "MID". (Adjustment LOW/MID/HIGH)
- When the adjustment is complete, press the [A-MODE] knob several times until the function mode is reached.

Basic Operations

Adjusting the G.EQ EDIT

This function allows you to correct each frequency band by 9 band equalizer.

This adjustment can only be performed when the DZE is set to "DZE OFF".

1. Press the [A-MODE] knob and select "G.EQ EDIT".
2. Turn the [SEARCH] knob to select the frequency. (Adjustment range: 63Hz to 16kHz)
3. Turn the [A-MODE] knob to adjust the gain.
 - * The factory default setting is "0". (Adjustment range: -6 to +6)
4. Repeat steps 2 and 3 to adjust the gain and the frequency.

Adjusting the bass (Gain, Frequency)

This adjustment can only be performed when the DZE is set to "DZE OFF".

1. Press the [A-MODE] knob and select "BASS".
2. Turn the [A-MODE] knob to adjust the bass.
 - * The factory default setting is "0". (Adjustment range: -6 to +7)
3. Turn the [SEARCH] knob to select "BASS FREQ".

Turn the [A-MODE] knob to select the frequency.

 - * The factory default setting is "60". (Adjustment 60/80/120 Hz)
4. When the adjustment is complete, press the [A-MODE] knob several times until the function mode is reached.

Adjusting the treble (Gain, Frequency)

This adjustment can only be performed when the DZE is set to "DZE OFF".

1. Press the [A-MODE] knob and select "TREBLE".
2. Turn the [A-MODE] knob to adjust the treble.
 - * The factory default setting is "0". (Adjustment range: -6 to +6)
3. Turn the [SEARCH] knob to select "TREBLE FREQ".

Turn the [A-MODE] knob to select the frequency.

 - * The factory default setting is "12k". (Adjustment 8 kHz/12 kHz)
4. When the adjustment is complete, press the [A-MODE] knob several times until the function mode is reached.

Adjusting the balance

1. Press the [A-MODE] knob and select "BALANCE".
2. Turn the [A-MODE] knob to adjust the balance of the left and right speakers.
 - * The factory default setting is "0". (Adjustment range: L13 to R13)
3. When the adjustment is complete, press the [A-MODE] knob several times until the function mode is reached.

Adjusting the fader

1. Press the [A-MODE] knob and select "FADER".
2. Turn the [A-MODE] knob to adjust the balance of the front and rear speakers.
 - * The factory default setting is "0". (Adjustment range: F12 to R12)
3. When the adjustment is complete, press the [A-MODE] knob several times until the function mode is reached.

Radio Operations

Listening to the radio

1. Turn the **[SOURCE]** knob and select the radio mode. The frequency appears in the display.
2. Press the **[BAND]** button and select the radio band. Each time the button is pressed, the radio reception band changes in the following order:
FM1 → FM2 → FM3 → AM → FM1...
3. Turn the **[SEARCH]** knob to tune in the desired station.

Tuning

There are 3 types of tuning modes available, seek, manual and preset tuning.

Seek tuning

1. Press the **[BAND]** button and select the desired band (FM or AM).
 - * If "MANU" is lit in the display, press and hold the **[BAND]** button for 1 second or longer. "MANU" in the display goes off and seek tuning is now available.
2. Turn the **[SEARCH]** knob to automatically seek a station.

When the knob is turned right, the station is sought in the direction of higher frequencies; if the knob is turned left, the station is sought in the direction of lower frequencies.

Manual tuning

There are 2 ways available: Quick tuning and step tuning.

When you are in the step tuning mode, the frequency changes one step at a time. In the quick tuning mode, you can quickly tune the desired frequency.

1. Press the **[BAND]** button and select the desired band (FM or AM).
 - * If "MANU" is not lit in the display, press and hold the **[BAND]** button for 1 second or longer. "MANU" is lit in the display and manual tuning is now available.
2. Tune into a station.

● Quick tuning:

Turn the **[SEARCH]** knob for 1 second or longer to tune in a station.

● Step tuning:

Turn the **[SEARCH]** knob to manually tune in a station.

Recalling a preset station

A total of 24 preset positions (6-FM1, 6-FM2, 6-FM3, 6-AM) exists to store individual radio stations in memory. Pressing the corresponding **[DIRECT]** button recalls the stored radio frequency automatically.

1. Press the **[BAND]** button and select the desired band (FM or AM).
2. Press the corresponding **[DIRECT]** button to recall the stored station.
 - * Press and hold one of the **[DIRECT]** buttons for 2 seconds or longer to store that station into preset memory.

Manual memory

1. Select the desired station with seek tuning, manual tuning or preset tuning.
2. Press and hold one of the **[DIRECT]** buttons for 2 seconds or longer to store the current station into preset memory.

Auto store

Auto store is a function for storing up to 6 stations that are automatically tuned in sequentially. If 6 receivable stations cannot be received, a previously stored station remains unoverwritten at the memory position.

1. Press the **[BAND]** button and select the desired band (FM or AM).
2. Press and hold the **[SEARCH]** knob for 2 seconds or longer. The stations with good reception are stored automatically to the preset channels.

Radio Operations

Preset scan

Preset scan receives the stations stored in preset memory in order. This function is useful when searching for a desired station in memory.

1. Press the **[SEARCH]** knob.
2. When a desired station is tuned in, press the **[SEARCH]** knob again to continue receiving that station.

Note:

- Be careful not to press and hold the **[SEARCH]** knob for 2 seconds or longer, otherwise the auto store function is engaged and the unit starts storing stations.

Instant station recall (ISR)

Instant station recall is a special radio preset that instantly accesses a favorite radio station at a touch of a button. The ISR function even operates with the unit in other modes.

● ISR memory

1. Select the station that you wish to store in ISR memory.
2. Press and hold the **[ISR]** button for 2 seconds or longer.

● Recalling a station with ISR

In any mode, press the **[ISR]** button to turn on the radio function and tune the selected radio station. "ISR" appears in the display. Press the **[ISR]** button again to return to the previous mode.

CD/MP3/WMA Operations

MP3/WMA

What is MP3?

MP3 is an audio compression method and classified into audio layer 3 of MPEG standards. This audio compression method has penetrated into PC users and become a standard format.

This MP3 features the original audio data compression to about 10 percent of its initial size with a high sound quality. This means about 10 music CDs can be recorded on a CD-R disc or CD-RW disc to allow a long listening time without having to change CDs.

What is WMA?

WMA is the abbreviation of Windows Media Audio, an audio file format developed by Microsoft Corporation.

Notes:

- If you play a file with DRM (Digital Rights Management) for WMA remaining ON, no audio is output. (The WMA indicator blinks.)
- Windows Media™, and the Windows® logo are trademarks, or registered trademarks of Microsoft Corporation in the United States and/or other countries.

● To disable DRM (Digital Rights Management):

1. When using Windows Media Player 9, click on **TOOL → OPTIONS → MUSIC RECORD** tab, then under Recording settings, unclick the Check box for **RECORD PROTECTED MUSIC**. Then, reconstruct files.
2. When using Windows Media Player 10, click on **TOOLS → OPTIONS → RIP MUSIC** tab, then under **RIP SETTINGS**, unclick the Check box for **COPY PROTECT MUSIC**. Then, reconstruct files.

Personally constructed WMA files are used at your own responsibility.

Precautions when creating MP3/WMA disc

● Usable sampling rates and bit rates:

1. MP3: Sampling rate 11.025 kHz-48 kHz,
Bit rate: 8 kbps-320 kbps / VBR
2. WMA: Bit rate 48 kbps-192 kbps

● File extensions

1. Always add a file extension ".MP3" or ".WMA" to MP3 or WMA file by using single byte letters. If you add a file extension other than specified or forget to add the file extension, the file cannot be played.

- Files without MP3/WMA data will not play. The indication “---:---” appears in the play time display if you attempt to play files without MP3/WMA data.

● **Logical format (File system)**

- When writing MP3/WMA file on a CD-R disc or CD-RW disc, please select “**ISO9660 level 1, 2 or JOLIET or Romeo**” as the writing software format. Normal play may not be possible if the disc is recorded on another format.
- The folder name and file name can be displayed as the title during MP3/WMA play but the title must be within 128 single byte alphabetical letters and numerals (including an extension).
- Do not affix a name to a file inside a folder having the same name.

● **Folder structure**

- A disc with a folder having more than 8 hierarchical levels will be impossible.

● **Number of files or folders**

- Up to 255 files can be recognized per folder. Up to 500 files can be played.
- Tracks are played in the order that they were recorded onto a disc. (Tracks might not always be played in the order displayed on the PC.)
- Some noise may occur depending on the type of encoder software used while recording.

Multisession function

When a disc contains both normal CD type tracks and MP3/WMA type tracks mixedly, you can select which type of the recorded tracks to play.

● **Default value is “CD”.**

Each time you press and hold the [BAND] button for 1 second or longer, the mixed mode is switched between CD type and MP3/WMA type.

- Types of recording that can be played are as follows.

Disc \ Setting	Set to CD	Set to MP3/WMA
Mixed with CD and MP3/WMA type tracks	Play CD	Play MP3/WMA
CD type track only	Play CD	Play CD
MP3/WMA type track only	Play MP3/WMA	Play MP3/WMA

- After making these settings, remove the disc and then reinsert it. (in case of one disc)

- When a mixed mode CD is loaded and CD is set, the track to be played first is MP3/WMA file data and no sound is heard.

Note:

- When playing a CCCD (Copy Control CD), set the setting to CD type. When this is set to MP3/WMA type, the CD cannot be played normally in some cases.

⚠ WARNING

About a Single CD (8cm CD)

- Since the unit is not compatible with a single CD, do not load it into the unit.
- Keep in mind the fact that a single CD cannot be played even using a single CD adaptor for the unit.
- If you try to push it into the unit forcibly without removing it, the CD cannot be ejected. This will result in damage to the mechanism. Please never do this.

Disc-In-Play function

Pressing the [LOAD] button inserts the disc even if the power to the unit is not turned on.

Loading a CD

● **Inserting a CD**

- Press the [LOAD] button. The disc indicator of available slot blinks and the indication “- - -” appears in the display. After that, the indication “CD IN” and “SHUTTER OPEN” appears in the display.
 - Insert a CD into the CD SLOT. The corresponding disc indicator lights when loading is completed and the CD plays automatically.
- If you want to insert a disc into the particular slot, press the [DIRECT] button with corresponding disc indicator not lighting after pressing the [LOAD] button.
 - To cancel loading, Press the [LOAD] button again.

Note:



- You can insert a disc only within 15 seconds, during “CD IN” appears in the display and the shutter inside the slot is open. When it’s out of time, “CD IN” disappears and the shutter is closed, and you cannot insert a disc. Please do not insert a disc forcibly when the shutter is closed. This may damage a disc or the mechanism of the shutter.

CD/MP3/WMA Operations

● Inserting CDs at one time

1. Press and hold the [LOAD] button for 1 second or longer.
2. Insert a CD into the CD SLOT one by one.

Notes:



- Never insert foreign objects into the CD SLOT.
- If the CD does not insert easily, there may be another CD in the mechanism or the unit may require service.
- Discs not bearing the  or  mark and CD-ROMs cannot be played by this unit.
- Some CDs recorded in CD-R/CD-RW mode may not be usable.

Eject function

● Ejecting a CD

1. Press the corresponding [DIRECT] button that you want to eject the CD.
2. Press the [] button.

● Ejecting all CDs

1. Press and hold the [] button for 1 second or longer.
 - * Pressing the [] button ejects the disc even if the power to the unit is not turned on.
 - * If you leave the ejected CD without removing it, it will be drawn into the unit automatically after about 15 seconds. (Auto reload function)

⚠ CAUTION

- Do not try to put your hand or fingers in the disc insertion slot. Also never insert foreign objects into the slot.
- Do not insert discs where adhesive comes out from cellophane tape or a rental CD label, or discs with marks where cellophane tape or rental CD labels were removed. It may be impossible to extract these discs from the unit and they may cause the unit to break down.

Listening to a disc already loaded in the unit

Turn the [SOURCE] knob to select the CD/MP3 mode.

When the unit enters the CD/MP3 mode, play starts automatically.

If there is no disc loaded, the indication “**NO DISC**” appears in the display.

Pausing play

1. Press the [SEARCH] knob to pause play. “**PAUSE**” appears in the display.
2. To resume CD play, press the [SEARCH] knob again.

Displaying CD titles

This unit can display title data for CD-text/MP3/WMA disc and user titles input with this unit.

1. Press the [DISP] button to select the title display.
2. Each time you press the [TITLE] button, the title changes in the following order:

● CD-TEXT disc

User title (user) → CD-text title (disc) → Artist name → CD-text title (track) → User title (user)...

● MP3/WMA disc

Folder → Track → Album → Artist → Title → Folder...

Notes:

- If the CD playing is not a CD-text CD or no user title has been input, “**NO TITLE**” appears in the display.
- If MP3/WMA disc is not input TAG, “**NO TAG**” appears in the display.
- For MP3, supports ID3 Tags V2.3 / 2.2 / 1.1 / 1.0.
- Tag displays give priority to V2.3 / 2.2.
- In the case of album Tags for WMA, the information written into the extension header is displayed.
- Only ASCII characters can be displayed in Tags.

Selecting a track

● Track-up

1. Turn the [SEARCH] knob right to move ahead to the beginning of the next track.
2. Each time you turn the knob right, the track advances ahead to the beginning of the next track.

● Track-down

1. Turn the [SEARCH] knob left to move back to the beginning of the current track.
2. Turn the knob left twice to move to the beginning of the previous track.

Fast-forward/fast-rewind

● Fast-forward

Turn the [SEARCH] knob right for 1 second or longer.

● Fast-rewind

Turn the [SEARCH] knob left for 1 second or longer.

* For MP3/WMA discs, it takes some time until the start of searching and between tracks. In addition, the playing time may have a margin of error.

Folder select

This function allows you to select a folder containing MP3/WMA files and start playing from the first track in the folder.

1. Turn the [A-MODE] knob left to move to the previous folder.

Turn the [A-MODE] knob right to move to the next folder.

- * Turn the [A-MODE] knob right while in the final folder to shift to the first folder.
- * Folder without an MP3/WMA file is not selectable.

Selecting a CD

Press the [DIRECT] buttons to select the desired disc.

The [DIRECT] button is valid only when corresponding disc indicator is turned on.

Top function

The top function resets the CD player to the first track of the disc. Press the [DIRECT] button to play the first track (track No. 1) on the disc.

* In case of MP3/WMA, the first track of a folder being played will be returned.

Scan play

This function allows you to locate and play the first 10 seconds of all the tracks recorded on a disc or folder.

1. Press the [SCN] button to perform scan play.
 - * Scan play starts from the next track after the track currently being played.
2. To cancel scan play, press the [SCN] button again.

All scan play

This function allows you to locate and play the first 10 seconds of the first track of all discs or folders.

1. Press and hold the [SCN] button for 1 second or longer to perform all scan play.
 - * All scan play starts from the next disc or folder after the disc or folder currently being played.
2. To cancel all scan play, press the [SCN] button again.

Repeat play

This function allows you to play the current track repeatedly.

1. Press the [RPT] button to perform repeat play.
2. To cancel repeat play, press the [RPT] button again.

All repeat play

This function allows you to play all tracks repeatedly in the disc or folder currently being played.

1. Press and hold the [RPT] button for 1 second or longer to perform all repeat play.
2. To cancel all repeat play, press the [RPT] button again.

Random play

This function allows you to play all tracks recorded on a disc or folder in a random order.

1. Press the [RDM] button to perform random play.
2. To cancel random play, press the [RDM] button again.

All random play

This function allows you to play all the tracks of all discs or folders in a random order.

1. Press and hold the [RDM] button for 1 second or longer to perform all random play.
2. To cancel all random play, press the [RDM] button again.

Common Operations

CATS function (Clarion Anti-Theft System)

This unit can deter theft by checking registered optional PIN (Personal Identification Number).

How to register/delete PIN

1. Press the [ADJ] button to switch to the adjust mode.
2. Turn the [SEARCH] knob to select "CODE".
3. Press the [SEARCH] knob.
 - * When registering: "ENTRY 0000" appears.
 - * When deleting: "DEL 0000" appears.
4. Press the [DIRECT] buttons to input optional PIN in 4 digits.

⚠ CAUTION

- Establish your PIN by combining numbers from 1 to 6 as you like in 4 digits.

Do not forget your PIN, for you cannot perform any further operation without your PIN when you remove the battery for repair etc.

- Write down your PIN for the future use.

5. Press and hold the [SEARCH] knob for 2 seconds or longer to enter the PIN.

Note:

- When registering PIN is completed, the unit enters the CATS mode. If ACC is set to ON from OFF or if the power is turned on while in the CATS mode, "CODE" appears in the display for 2 seconds and the unit starts up.

If you input wrong number when deleting your PIN, you cannot complete the operation. In that case, the unit requests you to input the correct PIN.

6. Press the [ADJ] button to return to the previous mode.

PIN (Personal Identification Number) check in the CATS Mode

When the main power source is unconnected for battery exchange etc. while the CATS mode is on, input your PIN.

1. Press the [DIRECT] buttons to input your PIN in 4 digits.

⚠ CAUTION

- If you input your PIN wrongly, "----" is to be displayed and CATS lock mode is to be entered. You cannot perform any operation for a given period while in the CATS lock mode.

If your mistakes are less than 6 times, the locking time will be for 15 seconds; if more than 7 times, it will be for 15 minutes.

- If you forget your PIN and enter a wrong PIN, you cannot perform any further operation.

Display Adjust Mode

Setting the clock

1. Press and hold the **[DISP]** button for 1 second or longer to switch to the display adjust mode.
2. Turn the **[SEARCH]** knob to select “**CLOCK**”.
3. Press the **[SEARCH]** knob.
4. Turn the **[SEARCH]** knob to select the hour or the minute.
5. Turn the **[A-MODE]** knob to set the correct time.
 - * The clock is displayed in 12-hour format.
6. Press the **[SEARCH]** knob to store the time into memory.
7. Press the **[DISP]** button to return to the previous mode.

Note:

- You cannot set the clock when it is displayed with only the ignition on. If you drain or remove the car's battery or take out this unit, the clock is reset. While setting the clock, if another button or operation is selected, the clock set mode is canceled.

Setting the sensitivity of the spectrum analyzer display

- * The factory default setting is “**MID**”.
1. Press and hold the **[DISP]** button for 1 second or longer to switch to the display adjust mode.
 2. Turn the **[SEARCH]** knob to select “**S/A SENSE**”.
 3. Turn the **[A-MODE]** knob to select from “**LOW**”, “**MID**” or “**HIGH**”.
 4. Press the **[DISP]** button to return to the previous mode.

Setting the speed of the spectrum analyzer display

- * The factory default setting is “**MID**”.
1. Press and hold the **[DISP]** button for 1 second or longer to switch to the display adjust mode.
 2. Turn the **[SEARCH]** knob to select “**S/A SPEED**”.
 3. Turn the **[A-MODE]** knob to select from “**LOW**”, “**MID**” or “**HIGH**”.
 4. Press the **[DISP]** button to return to the previous mode.

Turning the screen saver function on or off

If the screen savers are not desired, they can be turned off.

If the button operation is performed with the screen saver function on, the operation display corresponding to the button operation is shown for about 30 seconds and the display returns to the screen saver display.

- * The factory default setting is “**ON**”.

1. Press and hold the **[DISP]** button for 1 second or longer to switch to the display adjust mode.
2. Turn the **[SEARCH]** knob to select “**SCRN SVR**”.
3. Turn the **[A-MODE]** knob to select “**ON**” or “**OFF**”.
4. Press the **[DISP]** button to return to the previous mode.

Entering MESSAGE INFORMATION

When “**ON**” is selected for the screen saver setting, you can change the contents of the message.

- * Up to 30 characters can be entered.
- * The factory default setting is “**Welcome to Clarion**”.

1. Press and hold the **[DISP]** button for 1 second or longer to switch to the display adjust mode.
2. Turn the **[SEARCH]** knob to select “**MSG INPUT**”.
3. Press the **[SEARCH]** knob.
4. Turn the **[SEARCH]** knob to move the cursor.
5. Press the **[BAND]** button to select a character. Each time you press the **[BAND]** button, the character changes in the following orders:

Capital letters → Small letters → Numbers and Symbols → Umlaut → Capital letters...

6. Turn the **[A-MODE]** knob to select the desired character.
7. Repeat steps 4 to 6 to enter up to 30 characters for message.

Common Operations

8. Press and hold the **[SEARCH]** knob for 2 seconds or longer to store the message in memory and return to the display adjust mode.
 - * Press and hold the **[BAND]** button for 1 second or longer to delete the message. Then press and hold the **[SEARCH]** knob for 2 seconds or longer to return the message to the default setting.
9. Press the **[DISP]** button to return to the previous mode.

Setting the method for title scroll

Set how to scroll in CD-TEXT, MP3/WMA TITLE.

- * The factory default setting is **"ON"**.
1. Press and hold the **[DISP]** button for 1 second or longer to switch to the display adjust mode.
 2. Turn the **[SEARCH]** knob to select **"AUTO SCROLL"**.
 3. Turn the **[A-MODE]** knob to select **"ON"** or **"OFF"**.
 - **ON:**
Scrolls automatically.
 - **OFF:**
Scrolls just 1 time when the title was changed or you press and hold the **[TITLE]** button for 1 second or longer.
 4. Press the **[DISP]** button to return to the previous mode.

Dimmer control

You can set the dimmer control.

- * The factory default setting is **"ON"**.
1. Press and hold the **[DISP]** button for 1 second or longer to switch to the display adjust mode.
 2. Turn the **[SEARCH]** knob to select **"DIMMER"**.
 3. Turn the **[A-MODE]** knob to select **"ON"** or **"OFF"**.
 4. Press the **[DISP]** button to return to the previous mode.

Adjust Mode

Anti-theft indicator

The red Anti-theft indicator is a function for deterring theft.

The disc indicator of the **[DIRECT]** button "2" blinks.

- * The factory default setting is **"OFF"**.
1. Press the **[ADJ]** button to switch to the adjust mode.
 2. Turn the **[SEARCH]** knob to select **"BLINK LED"**.
 3. Turn the **[A-MODE]** knob to select **"ON"** or **"OFF"**.
 4. Press the **[ADJ]** button to return to the previous mode.

Adjusting the auxiliary input sensitivity

Adjust the auxiliary sensitivity when the audio from an external device is difficult to hear even after adjusting the volume.

- * The factory default setting is **"MID"**.
1. Press the **[ADJ]** button to switch to the adjust mode.
 2. Turn the **[SEARCH]** knob to select **"AUX SENSE"**.
 3. Turn the **[A-MODE]** knob to select from **"LOW"**, **"MID"** or **"HIGH"**.
 4. Press the **[ADJ]** button to return to the previous mode.

Performing a system check

This function verifies the devices hooked up through CeNET.

1. Press the **[ADJ]** button to switch to the adjust mode.
2. Turn the **[SEARCH]** knob to select **"SYS CHECK"**.
3. Press and hold the **[SEARCH]** knob for 1 second or longer to start the system check.

The digital connection configuration is automatically checked.

When the system check is complete, the display returns to the previous mode.

Entering titles

Titles up to 10 characters long can be stored in memory and displayed for CD, CD changer and Radio/TV stations. The number of titles that can be entered for each mode are as follows.

Mode	Number of titles
CD mode	50 titles
TV mode	20 titles
Radio mode	30 titles

CD changer mode	Number of titles
DCZ625 connected	100 titles
CDC655Tz connected	100 titles

- Turn the **[SOURCE]** knob to select the mode you want to enter a title (Radio, CD, CD changer or TV).
- Play a track or tune in to a radio/TV station for which you want to enter the title.
- Do one of the following:
 - **In the CD or CD changer mode**
Press the **[TITLE]** button to select **"USER"**.
 - **In the radio or TV mode**
Skip this step.
- Press and hold the **[TITLE]** button for 1 second or longer to switch to the title input display.
- Turn the **[SEARCH]** knob to move the cursor.
- Press the **[BAND]** button to select a character. Each time you press the **[BAND]** button, the character changes in the following order:
Capital letters → Small letters → Numbers and Symbols → Umlaut → Capital letters...
- Turn the **[A-MODE]** knob to select the desired character.
- Repeat steps 5 to 7 to enter up to 10 characters for the title.
- Press and hold the **[SEARCH]** knob for 2 seconds or longer to store the title into memory and return to the previous mode.

Clearing titles

- Play a track or tune in to a radio/TV station for which you want to delete the title.
- Do one of the following:
 - **In the CD or CD changer mode**
Press the **[TITLE]** button to select **"USER"**.
 - **In the radio or TV mode**
Skip this step.
- Press and hold the **[TITLE]** button for 1 second or longer to switch to the title input display.
- Press and hold the **[BAND]** button for 1 second or longer to delete the title.
- Press and hold the **[SEARCH]** knob for 2 seconds or longer to store the setting and return to the previous mode.

Cellular telephone mute

This unit requires special wiring to mute the audio signal automatically when a cellular telephone rings in the car.

* This function is not compatible with all cellular telephones. Contact your local authorized Clarion dealer for information on proper installation and compatibility.

AUX function

This system has an external input jack so you can listen to audio from an external device connected to this unit.

7. OPERATIONS OF ACCESSORIES

CD Changer Operations

CD changer functions

When an optional CD changer is connected through the CeNET cable, this unit controls all CD changer functions. This unit can control a total of 2 changers.

Turn the **[SOURCE]** knob and select the CD changer mode to start play. If 2 CD changers are connected, turn the **[SOURCE]** knob to select the CD changer for play.

* If **"NO MAG"** appears in the display, insert the magazine into the CD changer. **"DISC CHECK"** appears in the display while the player loads (checks) the magazine.

* If **"NO DISC"** appears in the display, eject the magazine and insert discs into each slot. Then, reinsert the magazine back into the CD changer.

Note:

- Some CDs recorded in CD-R/CD-RW mode may not be usable.

⚠ CAUTION

CD-ROM discs cannot be played from every CD changer, it's depended on the model.

Pausing play

1. Press the **[SEARCH]** knob to pause play. **"PAUSE"** appears in the display.
2. To resume play, press the **[SEARCH]** knob again.

Displaying CD titles

This unit can display title data for CD-text CDs and user titles input with this unit.

●When connected to CDC655Tz or DCZ625

1. Press the **[DISP]** button to select the title display.
2. Each time you press the **[TITLE]** button, the title changes in the following order:

**User title (user) → CD-text title (disc) →
Artist name → CD-text title (track) → User
title (user)...**

Notes:

- If the CD playing is not a CD-text CD or no user title has been input, **"NO TITLE"** appears in the display.
- If a CD-text CD is not input its disc title or a track title, **"NO TITLE"** appears in the display.

Procedure to scroll a title

Set **"SCROLL"** to **"ON"** or **"OFF"**.

(The factory default setting is **"ON"**. Refer to the subsection **"Setting the method for title scroll"** in the section **"Common Operations"**.)

●When set to "ON"

The title is automatically kept scrolling.

●When set to "OFF"

To scroll just 1 time when the title was changed or you press and hold the **[TITLE]** button for 1 second or longer.

Selecting a CD

Press the **[DIRECT]** buttons to select the desired disc.

- * The **[DIRECT]** button is valid only when corresponding disc indicator is turned on.

Selecting a track

●Track-up

1. Turn the **[SEARCH]** knob right to move ahead to the beginning of the next track.
2. Each time you turn the knob right, the track advances ahead to the beginning of the next track.

●Track-down

1. Turn the **[SEARCH]** knob left to move back to the beginning of the current track.
2. Turn the knob left twice to move to the beginning of the previous track.

Fast-forward/fast-rewind

●Fast-forward

Turn the **[SEARCH]** knob right for 1 second or longer.

●Fast-rewind

Turn the **[SEARCH]** knob left for 1 second or longer.

Scan play

Scan play locates and plays the first 10 seconds of each track on a disc automatically. This function continues on the disc until it is cancelled.

* The scan play is useful when you want to select a desired track.

1. Press the **[SCN]** button.
2. To cancel the scan play, press the **[SCN]** button again.

Disc scan play

Disc scan play locates and plays the first 10 seconds of the first track on each disc in the currently selected CD changer. This function continues automatically until it is cancelled.

* Disc scan play is useful when you want to select a desired CD.

1. Press and hold the **[SCN]** button for 1 second or longer.
2. To cancel disc scan play, press the **[SCN]** button again.

Repeat play

Repeat play continuously plays the current track. This function continues automatically until it is cancelled.

1. Press the **[RPT]** button.
2. To cancel repeat play, press the **[RPT]** button again.

Disc repeat play

After all the tracks on the current disc have been played, disc repeat play automatically re-plays the current disc over from the first track. This function continues automatically until it is cancelled.

1. Press and hold the **[RPT]** button for 1 second or longer.
2. To cancel disc repeat play, press the **[RPT]** button again.

Random play

Random play selects and plays individual tracks on the disc in no particular order. This function continues automatically until it is cancelled.

1. Press the **[RDM]** button.
2. To cancel random play, press the **[RDM]** button again.

Disc random play

The disc random play selects and plays individual tracks or discs automatically in no particular order. This function continues automatically until it is cancelled.

1. Press and hold the **[RDM]** button for 1 second or longer.
2. To cancel disc random play, press the **[RDM]** button again.

TV Operations

TV tuner functions

When an optional TV tuner is connected through the CeNET cable, this unit controls all TV tuner functions. To watch TV it requires a TV tuner and a monitor.

Watching a TV

1. Turn the **[SOURCE]** knob and select the TV mode.
2. Press the **[BAND]** button to select the desired TV band (TV1 or TV2). Each time the button is pressed, the input selection toggles between TV1 and TV2.
3. Turn the **[SEARCH]** knob to tune in the desired TV station.

Watching a video

The TV tuner features a VTR input for an external A/V source, such as a DVD player or game station.

1. Press and hold the **[ADJ]** button for 1 second or longer to select VTR.
2. To return to the TV broadcast, press and hold the **[ADJ]** button for 1 second or longer.

TV tuning

There are 3 types of TV tuning modes available, seek, manual and preset tuning.

Seek tuning

1. Press the **[BAND]** button and select the desired TV band (TV1 or TV2).
 - * If "MANU" is lit in the display, press and hold the **[BAND]** button for 1 second or longer. "MANU" in the display goes off and seek tuning is now available.
2. Turn the **[SEARCH]** knob to automatically seek a station. Turn the knob right to automatically tune up the frequency band to the next available TV station; turn the knob left to automatically tune down.

Manual tuning

There are 2 ways available: Quick tuning and step tuning.

When you are in the step tuning mode, the frequency changes one step at a time. In the quick tuning mode, you can quickly tune the desired frequency.

1. Press the **[BAND]** button and select the desired band (TV1 or TV2).
 - * If "MANU" is not lit in the display, press and hold the **[BAND]** button for 1 second or longer. "MANU" lights in the display and manual tuning is now available.
2. Tune into a station.
 - **Quick tuning:**
Turn the **[SEARCH]** knob for 1 second or longer to tune in a station.
 - **Step tuning:**
Turn the **[SEARCH]** knob to manually tune in a station.

Recalling a preset station

A total of 12 TV stations can be stored (6-TV1 and 6-TV2). This allows you to select your favorite TV stations and store them in memory.

1. Press the **[BAND]** button and select the desired TV band (TV1 or TV2).
2. To recall a stored TV station, press the desired **[DIRECT]** button to select that station.
 - * Press and hold one of the **[DIRECT]** buttons for 2 seconds or longer to store the current station into preset memory.

Manual memory

1. Select the desired station with seek tuning, manual tuning or preset tuning.
2. Press and hold one of **[DIRECT]** buttons for 2 seconds or longer to store the current station into preset memory.

Auto store

Auto store selects 6 TV stations automatically and stores each one into preset memory.

If the 6 stations with good reception are available, stations previously stored in memory remain. Only stations with strong reception are stored into memory.

1. Press the **[BAND]** button and select the desired TV band (TV1 or TV2).
2. Press and hold the **[SEARCH]** knob for 2 seconds or longer. The stations with good reception are stored automatically to the preset channels.

Preset scan

Preset scan allows the user to view each preset position before it automatically advances to the next preset. This function is useful for searching for a desired TV station in memory.

1. Press the **[SEARCH]** knob.
2. When the desired station is found, press the **[SEARCH]** knob again to remain tuned to that station.

Note:

- Do not press and hold the **[SEARCH]** knob for 2 seconds or longer. Doing so will trigger the auto store function and start storing stations into memory.

Setting the TV area

When you select the TV area (TV reception area), the TV tuner area setting changes.

1. Press the **[ADJ]** button to switch to the adjust mode.
2. Turn the **[SEARCH]** knob to select “**TV AREA**”.
3. Press the **[SEARCH]** knob.
4. Turn the **[A-MODE]** knob to select the reception area.
5. Press the **[SEARCH]** knob.
6. Press the **[ADJ]** button to return to the previous mode.

The above operations are required when a TV tuner other than TTX7501z is connected.

Setting the TV diver

You can change the reception setting for the TV antenna connected to the TV tuner.

* The factory default setting depends on the TV.

1. Press the **[ADJ]** button to switch to the adjust mode.
2. Turn the **[SEARCH]** knob to select “**TV DIVER**”.
3. Turn the **[A-MODE]** knob to select “**ON**” or “**OFF**”.
 - **ON:**
Sets the diver setting to ON.
 - **OFF:**
Sets the diver setting to OFF.
4. Press the **[ADJ]** button to return to the previous mode.

8. TROUBLE SHOOTING

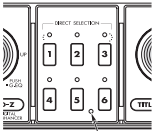
	Problem	Cause	Measure
General	Power does not turn on. (No sound is produced.)	Fuse is blown.	Replace with a fuse of the same amperage. If the fuse blows again, consult Clarion dealer.
		Incorrect wiring.	Consult Clarion dealer.
	No audio when operating the unit with amplifiers.	Amplifier turn-on lead is shorted to ground or excessive current is required.	Turn the unit off and check each wire for a possible short. If the amplifier turn-on lead shorts out, cover it with insulation such as tape.
	Nothing happens when buttons are pressed.	The microprocessor has malfunctioned due to noise, etc.	Press the reset button for about 2 seconds with a thin rod. 
	No audio.	The speaker protection circuit is operating.	<ol style="list-style-type: none"> 1. Check the speaker connection. 2. Turn down sound volume. Function can also be restored by turning the power off and on again. 3. If the sound is muted again, consult Clarion dealer.
	"Push EJECT" is displayed.	Something is wrong with disc or mechanism.	Press the [▲] button to avoid the trouble. If the situation is not improved despite you press the [▲] button several times, please consult Clarion dealer.
	"FAIL ****" is displayed.	Anti-theft function is out of order.	Press and hold the reset button for 2 seconds or longer. If the situation is not improved, please consult Clarion dealer.
CD/MP3	No audio.	MP3/WMA files are absent on the disc.	Write MP3/WMA files onto the disc properly.
		Files are not recognized as an MP3/WMA file.	Use MP3/WMA files encoded properly.
		File system is not correct.	Use ISO9660 level 1, 2 or JOLIET or Romeo file system.
	Sound skips or is noisy.	Disc is dirty.	Clean the disc with a soft cloth.
		Disc is heavily scratched or warped.	Replace with a disc with no scratches.

	Problem	Cause	Measure
CD/MP3	Sound is cut or skipped. Noise is generated or noise is mixed with sound.	MP3/WMA files are not encoded properly.	Use MP3/WMA files encoded properly.
	Poor sound quality in extremely cold weather or extreme humidity.	Water droplets may form on the internal lens when the car is parked in a humid place.	Let dry for about 1 hour with the power on.
	Wrong filename	File system is not correct.	Use ISO9660 level 1, 2 or JOLIET or Romeo file system.

9. ERROR DISPLAYS

If an error occurs, one of the following displays is displayed.
Take the measures described below to eliminate the problem.

	Error Display	Cause	Measure
CD/MP3	ERROR 3	A DISC cannot be played due to scratches, etc.	Replace with a non-scratched disc.
	ERROR 4	A foreign object is pinched in the DISC slot, or the shutter is damaged due to opening the shutter forcibly, etc.	Remove the object inside the slot. If there is no foreign object or the situation is not improved in spite of removing it, please consult Clarion dealer.
	ERROR 6	A DISC is loaded upside-down inside the CD deck and cannot play.	Eject the disc then reload it properly.
CD changer	ERROR 2	A DISC inside the CD changer is not loaded properly.	This is a failure of CD changer's mechanism and consult Clarion dealer.
	ERROR 3	A DISC inside the CD changer cannot be played due to scratches, etc.	Replace with a non-scratched disc.
	ERROR 6	A DISC inside the CD changer cannot be played because it is loaded upside-down.	Eject the disc then reload it properly.
DVD changer	ERROR 2	A DISC inside the DVD changer is not loaded properly.	This is a failure of DVD mechanism and consult Clarion dealer.
	ERROR 3	A DISC cannot be played due to scratches, etc.	Retry or replace with a non-scratched disc.
	ERROR 6	A DISC inside the DVD changer cannot be played because it is loaded upside-down.	Eject the disc then reload it properly
	ERROR P	Parental level error	Set the correct Parental level.
	ERROR R	Region code error	Eject the disc and replace correct region code disc.

If an error display other than the ones described above appears, press the reset button. If the problem persists, turn off the power and consult Clarion dealer.

10. SPECIFICATIONS

FM Tuner

Frequency Range:
87.0 MHz to 108.0 MHz

Usable Sensitivity:
9 dBf

50dB Quieting Sensitivity:
15 dBf

Alternate Channel Selectivity:
70 dB

Stereo Separation (1 kHz):
35 dB

Frequency Response (± 3 dB):
30 Hz to 15 kHz

AM Tuner

Frequency Range:
531 kHz to 1629 kHz

Usable Sensitivity:
25 μ V

CD Player

System:
Compact disc digital audio system

Usable Discs:
Compact disc

Frequency Response (± 1 dB):
10 Hz to 20 kHz

Signal to Noise Ratio (1 kHz):
90 dB

Dynamic Range (1 kHz):
90 dB

Harmonic Distortion:
0.01%

Channel Separation (1 kHz):
75 dB

Audio

Maximum Power Output:
200 W (50 W \times 4 ch)

Continuous Average Power Output:
17 W \times 4, into 4 Ω , 20 Hz to 20 kHz, 1%THD

Bass Control Action (60 Hz/80 Hz/120 Hz):
+14 dB, -12dB

Treble Control Action (8 kHz/12 kHz):
 ± 12 dB

9 Band-G-EQ (63Hz to 16kHz)
1 oct step GAIN ± 12 dB

Line Output Level (CD 1 kHz):
1.8 V

General

Power Supply Voltage:
14.4 V DC (10.8 to 15.6 V allowable), negative ground

Current Consumption:
Less than 15 A, 3A

Speaker Impedance:
4 Ω (4 Ω to 8 Ω allowable)

Weight / Source unit:
5.06 lb. (2.3 kg)

Weight / Remote control unit:
1.41 oz. (40g) (including battery)

Dimensions / Source unit:
7" (Width) \times 4" (Height) \times 6-5/16" (Depth)
[178 (W) \times 100 (H) \times 160 (D) mm]

Dimensions / Remote control unit:
1-3/4"(Width) \times 4-7/16"(Height) \times 1/2"(Depth)
[44 (W) \times 113 (H) \times 13 (D) mm]

Note:

- Specifications and design are subject to change without notice for further improvement.

Clarion Co., Ltd.

2005/11

All Rights Reserved. Copyright © 2005: Clarion Co., Ltd.

PE-2757K
280-8289-00

Download from Www.Somanuals.com. All Manuals Search And Download.

Free Manuals Download Website

<http://myh66.com>

<http://usermanuals.us>

<http://www.somanuals.com>

<http://www.4manuals.cc>

<http://www.manual-lib.com>

<http://www.404manual.com>

<http://www.luxmanual.com>

<http://aubethermostatmanual.com>

Golf course search by state

<http://golfingnear.com>

Email search by domain

<http://emailbydomain.com>

Auto manuals search

<http://auto.somanuals.com>

TV manuals search

<http://tv.somanuals.com>