

# 10. 规格

## FM 调谐器

频率范围……87.0 MHz 到 108 MHz  
 实际灵敏度……11 dBf  
 50 dB 无噪声灵敏度……17 dBf  
 相隔信道专一度……75 dB  
 立体声分离度 (1 kHz)……35 dB  
 频率响应 (± 3 dB)……30 Hz 到 15 kHz

## AM 调谐器

频率范围……531 kHz 到 1602 kHz  
 实际灵敏度……25  $\mu$ V

## 磁带

抖晃率 (WRMS)……0.08%  
 信道分离 (1 kHz)……45 dB  
 信噪比……70  $\mu$ s  
 (二氧化铬、铬化铁、金属带): 58 dB  
 频率响应 (± 3 dB)  
 120  $\mu$ s (普通) ……30 Hz 到 18 kHz  
 70  $\mu$ s (二氧化铬、铬化铁、金属带)  
 ……30 Hz 到 20 kHz

## 音频

最大功率输出……200 W (50 W x 4 声道)  
 连续平均功率输出……17 W x 4, 接 4 $\Omega$  20 Hz  
 到 20 kHz, 1% THD  
 低音控制 (30 Hz)……± 13 dB  
 高音控制 (10 kHz)……± 10 dB  
 线路输出……1.8 V (在 CD A/C 1kHz 10 k $\Omega$  状态)

## 整机

电源电压……14.4 V DC  
 (10.8 V 到 15.6 V 均可)  
 耗电……小于 15 A  
 扬声器阻抗……4 $\Omega$  (4 $\Omega$  到 8 $\Omega$ )  
 重量……1.5 kg  
 尺寸  
 ……宽 178 mm x 高 50 mm x 深 155 mm

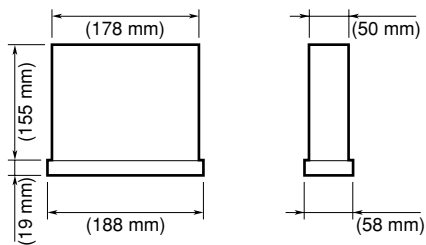

### 注意:

- 本规格符合 EIA 标准。
- 由于产品更新的需要, 规格和设计若有变更, 恕不另行通知。

# clarion®

Owner's manual  
 使用说明书

# AX430

AM/FM CASSETTE PLAYER  
 WITH CD CHANGER CONTROL

AM/FM 盒式放音机  
 带有 CD 换片机控制

## ProAudio C-BUS

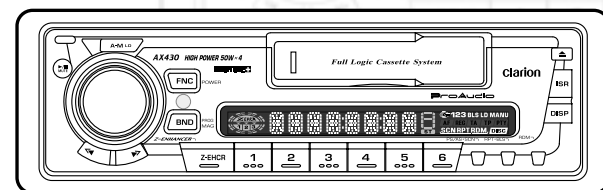

Thank you for purchasing the Clarion product.

- \* Please read this owner's manual in its entirety before operating this equipment.
- \* After reading this manual, be sure to keep it in a handy place (e.g., glove compartment).
- \* Check the contents of the enclosed warranty card and keep it carefully with this manual.

## Contents

1. FEATURES .....	2
2. CONTROLS .....	3
3. NOMENCLATURE .....	4
Names of Buttons .....	4
4. PRECAUTIONS .....	4
5. DCP .....	5
6. REMOTE CONTROL .....	6
Inserting the Batteries .....	6
Functions of Remote Control Unit Buttons .....	7
7. OPERATIONS .....	8
Basic Operations .....	8
Radio Operations .....	9
Tape Operations .....	11
CD Changer Operations .....	12
8. IN CASE OF DIFFICULTY .....	13
9. ERROR DISPLAYS .....	13
10. SPECIFICATIONS .....	14

# 1. FEATURES

- DIN Chassis with Detachable Control Panel
- Z-Enhancer with 3 Mode Sound Selector
- MAGI-TUNE FM Reception System
- AM/FM Bands-1 AM, 3 FM/18 FM/6 AM Touchbutton Memory
- Full Logic Tape Transport with True Function
- Auto Reverse with Azimuth Adjust
- Auto Metal Tape EQ
- Multi-Color LC Display
- 2-Channel RCA Line Level Output with Fader Control
- 200 W (50 W x 4) Maximum Power Output
- Infrared Remote Control

# Clarion Co., Ltd.

All Rights Reserved. Copyright © 2002: Clarion Co., Ltd.

PE-1712K-E  
 280-7890-00

2002/11 (C/A)

Be sure to unfold and read the next page.  
 请务必展开并阅读下页。

## 2. CONTROLS / 控制键

**Note:** Be sure to unfold this page and refer to the front diagrams as you read each chapter.  
注意：阅读各章时务请展开此页并参照前视图。

### SOURCE UNIT / 主机

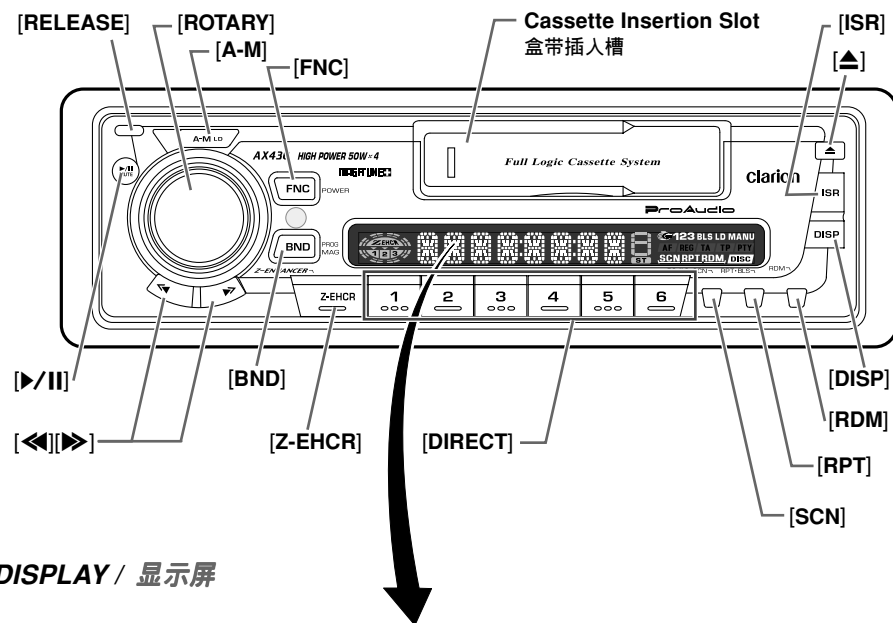

### DISPLAY / 显示屏



**Note:** Be sure to unfold this page and refer to the front diagrams as you read each chapter.  
注意：阅读各章时请务必展开本页并参照前视图。

## 3. NOMENCLATURE

**Note:**  
• Be sure to read this chapter referring to the front diagrams of chapter "2. CONTROLS" on page 3 (unfold).

### Names of Buttons

- [RELEASE] button
- [ROTARY] knob
- [A-M] button
  - Loudness button
- [FNC] button
  - Power button
- [▲] button
- [ISR] button
- [DISP] button
- [RDM] button
- [RPT] button
  - Blank Skip button
- [SCN] button
  - Preset Scan/Auto Store button
- [DIRECT] buttons (1 to 6)
- [Z-EHCR] button
- [BND] button
  - Program button
  - Magazine button
- [<<], [>>] buttons
- [▶/II] button
  - Mute button

## 4. PRECAUTIONS

1. Tape slack can lead to operating difficulties. Remove tape slack before inserting a cassette, particularly when using C-90 or prerecorded cassettes.
2. Use C-30 to C-90 cassettes. Avoid use of C-120 or longer cassettes (The very thin tape may stretch or break).
3. Clean the head periodically with a good commercial head cleaner. Avoid touching the head with magnetic or hard objects.
4. Do not oil the cassette mechanism.
5. Always remove the cassette from the mechanism when not in use. Exposure to direct sunlight, extreme temperatures or high humidity may damage cassettes.
6. The cassette tape will automatically eject from the mechanism if it is damaged. Always ensure that cassette tapes are in good condition prior to use.

#### INFORMATION FOR USERS:

**CHANGES OR MODIFICATIONS TO THIS PRODUCT NOT APPROVED BY THE MANUFACTURER WILL VOID THE WARRANTY AND WILL VIOLATE FCC APPROVAL.**

# 5. DCP

The control panel can be detached to prevent theft. When detaching the control panel, store it in the included DCP case to prevent scratches. We recommend taking the control panel with you when leaving the car.

## Removing the DCP

1. Turn off the power.
2. Press the [RELEASE] button.



\* The DCP is unlocked.

3. Remove the DCP.

### CAUTION

Do not insert the DCP from the left side. Doing so may damage it.

## Attaching the DCP

1. Insert the right side of the DCP into the main unit.
2. Insert the left side of the DCP into the main unit.

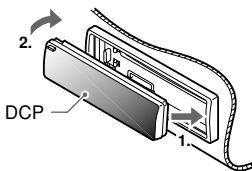

## Storing the DCP in the DCP Case

Hold the DCP, in the orientation as shown in the figure below, and put it into the supplied DCP case. (Ensure the DCP is in the correct orientation.)

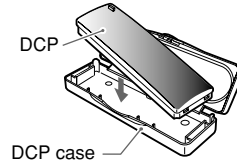

### CAUTION

- The DCP can easily be damaged by shocks. After removing it, place it in its case and be careful not to drop it or subject it to strong shocks.
- When the [RELEASE] button is pressed and the DCP is unlocked, the car's vibrations may cause it to fall. To prevent damage to the DCP, always store it in its case after detaching it.
- The connector connecting the source unit and the DCP is an extremely important part. Be careful not to damage it by pressing on it with fingernails, pens, screwdrivers, etc.

DCP Rear Panel      Source Unit Front

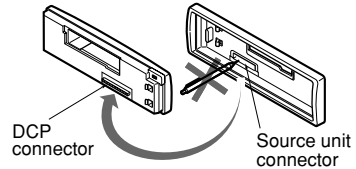

### Note:

- If the DCP is dirty, wipe off with a soft, dry cloth.

# 6. REMOTE CONTROL

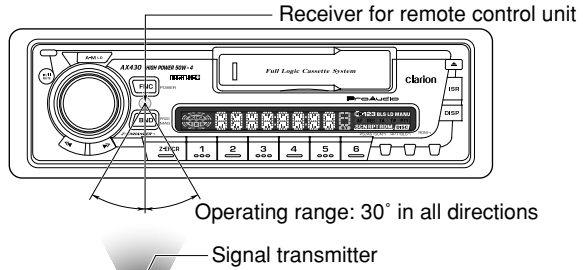

## Remote control unit

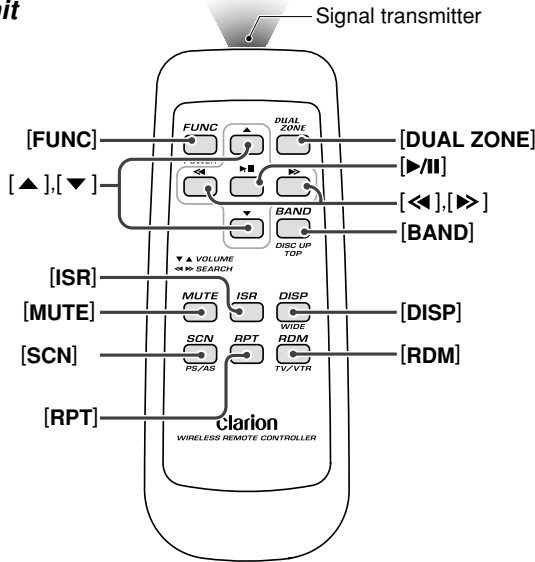

## Inserting the Batteries

1. Turn the remote control unit over, then slide the rear cover in the direction of the arrow.
2. Insert the AA (UM-3/1.5V) batteries that came with the remote control unit facing in the directions shown in the figure, then close the rear cover.

### Notes:

Using batteries improperly can cause them to explode. Take note of the following points:

- When replacing batteries, replace both batteries with new ones.
- Do not short-circuit, disassemble or heat batteries.
- Do not dispose of batteries into fire or flames.
- Dispose of spent batteries properly.

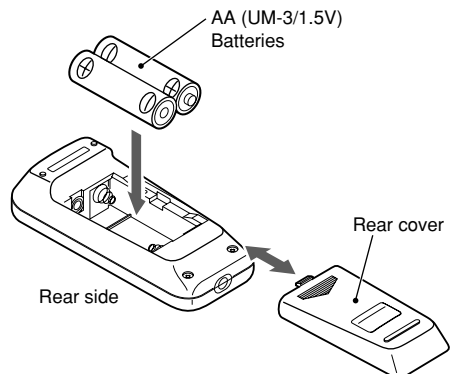

# Functions of Remote Control Unit Buttons

Button \ Mode	Radio	Tape	CD changer
[FUNC]	Turns power on and off. When pressed and held for 1 second: Turns power off. Switches between radio, Tape and CD changer.		
[BAND]	Switches reception band.	Switches the side of the tape.	Moves the next disc in increasing order.
[▲], [▼]	Increases and decreases volume (in all modes).		
[◀], [▶]	Moves preset channels up and down.	Fast-forward and rewinds tape. APC fast-forward and rewind.	Moves tracks up and down. When pressed and held for 1 second: Fast-forward/ fast-backward.
[▶/II]	Turns mute on and off.	Switches between playback and pause.	Switches between playback and pause.
[MUTE]	Turns mute on and off.	Switches between playback and pause.	Switches between playback and pause.
[ISR]	Recalls ISR radio station in memory. Press and hold for more than 2 seconds: Stores current station into ISR memory (radio mode only).		
[DISP]	Switches among main display and clock display.		
[SCN]	Preset scan. When pressed and held for 2 seconds: Auto store.	Fast-forward scan.	Scan play. When pressed and held for 1 second: Disc scan play.
[RPT]	No function.	Repeat play. When pressed and held for 1 second: Blank tape skip function turns on and off.	Repeat play. When pressed and held for 1 second: Disc repeat play.
[RDM]	No function.	No function.	Random play. When pressed and held for 1 second: Disc random play.

- \* Some of the corresponding buttons on the source unit and remote control unit have different functions.
- \* [DUAL ZONE] button is not available.

# 7. OPERATION

## Note:

- Be sure to read this chapter referring to the front diagrams of chapter "2. CONTROLS" on page 3 (unfold).

## Basic Operation

### ⚠ CAUTION

**When this unit is turned on, starting and stopping the engine of a car with its volume raised to the maximum level may harm your hearing.**

**Be careful about adjusting the volume.**

- 1) Press the [FNC] button.
  - \* To turn the power off, press the [FNC] button for at least 1 second.
- 2) Press the [FNC] button to select the operation mode. The mode switches as follows each time the [FNC] button is pressed:  
Radio → Tape → CD changer → Radio
  - \* If a component is not connected, that operation mode cannot be selected.
  - \* "CASS" appears when no tape is loaded in the source unit, and "DISC" appears when no disc is loaded in the CD changer.
- 3) Turning the [ROTARY] knob clockwise increases the volume; turning it counterclockwise decreases the volume.
  - \* The volume level is from 0 (minimum) to 33 (maximum).

### Audio Mode Adjustments

Press the [A-M] button to select the adjustment mode. The mode switches as follows each time the [A-M] button is pressed:

BASS → TREB → BAL → FAD → Previous mode

### Adjusting the Bass

- 1) Press [A-M] button and select "BASS".
- 2) Turning the [ROTARY] knob clockwise emphasizes the bass; turning it counterclockwise attenuates the bass.
  - \* The factory default setting is "0". (Adjustment range: -6 to +6)
- 3) When the adjustment is complete, press [A-M] button several times until the function mode is reached.

### Adjusting the Treble

- 1) Press [A-M] button and select "TREB".
- 2) Turning the [ROTARY] knob clockwise emphasizes the treble; turning it counterclockwise attenuates the treble.
  - \* The factory default setting is "0". (Adjustment range: -6 to +6)
- 3) When the adjustment is complete, press [A-M] button several times until the function mode is reached.

### Adjusting the Balance

- 1) Press [A-M] button and select "BAL".
- 2) Turning the [ROTARY] knob clockwise emphasizes the sound from the right speaker; turning it counterclockwise emphasizes the sound from the left speaker.
  - \* The factory default setting is "0". (Adjustment range: L9 to R9)
- 3) When the adjustment is complete, press [A-M] button several times until the function mode is reached.

### Adjusting the Fader

- 1) Press [A-M] button and select "FAD".
- 2) Turning the [ROTARY] knob clockwise emphasizes the sound from the front speakers; turning it counterclockwise emphasizes the sound from the rear speakers.
  - \* The factory default setting is "0". (Adjustment range: F9 to R9)
- 3) When the adjustment is complete, press [A-M] button several times until the function mode is reached.

### Setting the Z-enhancer

This unit comes with three types of sound tone effects stored in memory. Select the one you prefer.

- \* The factory default setting is "Z-EHCR OFF".

Each time you press [Z-EHCR] button, the tone effect changes in the following order.

"Z-ENHANCER 1" → "Z-ENHANCER 2" →

"Z-ENHANCER 3" → "Z-EHCR OFF" →

"Z-ENHANCER 1"...

## Basic Operation

- Z-ENHANCER 1: bass emphasized
- Z-ENHANCER 2: treble emphasized
- Z-ENHANCER 3: bass and treble emphasized
- Z-EHCR OFF: no sound effect

### Loudness Function

Press the **[A-M]** button for at least 1 second to turn the loudness function on and off.

### Switching the Display

Press the **[DISP]** button to enter the clock display mode.

Operation mode display → Clock display → Operation mode display

### Setting the Clock

- 1) Press the **[DISP]** button to enter the clock display mode.
- 2) Press the **[DISP]** button for 1 second or longer. This enables clock editing.
  - \* The editable fields will be indicated by flash.
- 3) To move between the hour and minute fields, use the **[◀◀]** Left (hour) and **[▶▶]** Right (minute) buttons.
- 4) To confirm the clock setting, press the **[DISP]** button.

#### Notes:

- If you select another operation mode before completing the above procedure, the clock setting operation will be canceled.
- Removing the battery for a check or repair causes the clock to be reset. Set the clock again in such a case.

## Radio Operation

### FM Reception

For enhanced FM performance the **MAGITUNE+** tuner includes signal actuated stereo control and Multipath noise reduction circuits.

### Listening to the Radio

- 1) Press the **[FNC]** button and select the radio mode. The radio turns on.
- 2) To tune in a preset station, first press the **[BND]** button and select FM1, FM2, FM3 or AM. The band changes as follows each time the **[BND]** button is pressed:  
FM1 → FM2 → FM3 → AM → FM1
- 3) Use the **[DIRECT]** buttons to select the desired station.

### Mute

Use this function to turn off the sound immediately.

Press the **[▶/||]** button. The sound turns off and “MUTE” appears on the display. Press the **[▶/||]** button again to cancel the mute mode.

### Seek Tuning

- 1) Press the **[BND]** button and select the desired band.
- 2) Press the **[◀◀]** or **[▶▶]** button. Seek tuning automatically stops when a station is found.

### Manual Tuning

- 1) Press the **[BND]** button and select the desired band.
- 2) Press the **[BND]** button again for more than 1 second. “MANU” lights in the display and the manual tuning mode is set.
- 3) Use the **[◀◀]** and **[▶▶]** buttons to tune in the desired frequency.

### Presetting Stations

A total of 24 stations can be preset, 6 each for the FM1, FM2, FM3 and AM bands.

#### Note:

- When a station is preset, the station previously stored in the memory at that position is cleared.

## Radio Operation

### ● Presetting stations manually

- 1) Press the [BND] button to select the band at which to store the station.
- 2) Use the [◀] and [▶] buttons to tune in the station to be preset.
- 3) Press the [DIRECT] button at which you want to store that station for at least 2 seconds.

### ● Auto store function

- 1) Press the [BND] button to select the band at which to store the stations.
- 2) Press the [SCN] button for at least 2 seconds. Stations with good reception are automatically stored at [DIRECT] buttons 1 to 6.

\* If there are fewer than 6 stations with good reception, the stations previously stored at the remaining buttons are not cleared.

### Preset Scanning (Preset Station Scan)

When the [SCN] button is pressed, the preset memory numbers flash and the stations are tuned in for 7 seconds each in the order in which they were stored. Press the [SCN] button again to cancel the preset scanning mode.

### Instant Station Recall (ISR)

This function allows you to recall a specific radio station from any mode. Use it to find stations quickly when you want to hear specific information (such as traffic announcements) while driving. The ISR station is set to 87.5 MHz upon shipment from the factory.

### ● ISR memory

- 1) Press the [FNC] button to select the radio mode.
- 2) Tune in the station to be set as the ISR station.
- 3) Press the [ISR] button for more than 2 seconds to store that station in the memory as the ISR station.

### ● Recalling a station with ISR

Press the [ISR] button from any mode. "ISR" appears on the display and the set station is tuned in. To cancel, press the [ISR] button again.

## Area Change

Use this to listen to the radio in the United States. This car stereo is initially set to tune in frequency intervals of 9 kHz for AM and 50 kHz for FM, the standard calibrations outside the U.S. When using the unit in the U.S., use the following procedure to switch the frequency steps and frequency range:

### ● Switching the area change U.S standard (New Setting)

- 1) Set the tuner mode.
- 2) While pressing the [BND] button, press the [▶] button.
- 3) Release the buttons.

This procedure changes the factory setting to 10 kHz steps for AM and 200 kHz steps for FM.

### ● Switching the area change outside U.S (Initial Setting)

- 1) Set the tuner mode.
- 2) While pressing the [BND] button, press the [◀] button.
- 3) Release the buttons.

Your car stereo will once again be calibrated to receive outside U.S. transmissions.

### ● The chart below lists the frequency specifications for the U.S. and other countries.

		Initial Setting (outside U.S.)	New Setting (U.S. standard)
AM	Frequency spacing	9 kHz	10 kHz
	Frequency range	531 to 1602 kHz	530 to 1710 kHz
FM	Frequency spacing	50 kHz	200 kHz
	Frequency range	87.0 to 108 MHz	87.9 to 107.9 MHz



# Tape Operation

## Loading Tapes

Insert the cassette tape into the Cassette insertion slot with the side on which the tape is exposed facing the right. Playback starts automatically.

- \* The metal tape setting is set automatically when a metal or chrome tape is loaded.
- \* When the end of the cassette tape is reached, the auto reverse mechanism is activated and the other side of the tape begins playing automatically.

### Listening to a tape which is already loaded

Press the [FNC] button to select the tape mode. Playback begins automatically.

## Stopping Playback Temporarily

Press the [▶/II] button. Press the button again to resume playback.

## Ejecting Cassette Tapes

Press the [▲] button. The cassette tape is ejected.

- \* The radio mode is set automatically 4 seconds after the [▲] button is pressed.

## Fast-Forwarding and Rewinding

Use the [◀◀] and [▶▶] buttons.

- ▶▶: Press this to fast-forward the tape.
- ◀◀: Press this to rewind the tape.

## APC (Auto Program Control)

Press the [◀◀] and [▶▶] button twice.

- ▶▶: Press this twice to move ahead to the beginning of the next selection.
- ◀◀: Press this twice to move back to the beginning of the current selection.

## Switching to the Other Side of the Tape

Press the [BND] button. Playback is switched to the other side of the cassette tape.

## FF Scan Function (Intro Music Scan)

When the [SCN] button is pressed, "SCN" appears on the display, and the first 10 seconds of all the tracks on the cassette tape are played. Press the [SCN] button again to stop scanning.

## Repeat Function (Repeat Play)

When the [RPT] button is pressed, "RPT" appears on the display and the current track is played repeatedly. Press the [RPT] button again to cancel the repeat mode.

## Blank Skip Function

Use this function to automatically skip to the beginning of the next recorded section when there is a blank section of 12 seconds or more on the tape.

When the [RPT] button is pressed for 1 second or longer, the blank skip mode is set and "BLS" appears on the display. Press the [RPT] button again for 1 second or longer to cancel the blank skip mode.

### Notes:

*The APC, scan, repeat and blank skip functions will not work with the following types of tapes:*

- Tapes on which the recording level is low
- Tapes on which there is less than 4 seconds of blank space between selections
- Tapes on which there are long pauses in the middle of selections
- Tapes on which there is much noise between selections

# CD Changer Operation

When a separately sold CD changer is connected, it can be controlled from the source unit.

## Notes:

- Some CDs recorded in CD-R mode may not be usable.
- Even when recorded in CD-RW mode, some CDs may not be usable.

## Listening to the Disc

Press the [FNC] button and select the CD changer mode, then the CD starts playing.

## Stopping (pausing) Playback

Press the [▶/||] button.

Press the [▶/||] button again to resume playback.

## Selection of CDs

Press the [DIRECT] button to select 1 to 6, then select the CD you wish to play.

## Selecting Tracks (songs)

Press the [◀◀] and [▶▶] buttons.

▶▶: Playback will start from the next track.

◀◀: Playback will start from the beginning of the track currently playing. When this button is pressed again, the CD will play from the previous track.

## Fast-Forward and Fast-Backward

Press and hold the [◀◀] and [▶▶] buttons.

▶▶: To fast-forward

◀◀: To fast-backward

\* Pressing the [◀◀] / [▶▶] button for 1 second or longer will move forward or backward 5 times faster than normal play, and pressing it for 3 seconds or longer will do the operation 30 times faster.

## Scan Play (Intro Music Scan)

Press the [SCN] button, then the display shows "SCN", then the CD will play the first 10 seconds of all the tracks of all CDs. Press the [SCN] button again to disengage the unit from scan play.

\* A scan play will start from the track following the one currently playing.

## Disc scan play

Press and hold the [SCN] button for 1 second or longer, then the display will show "DISC" and "SCN", and plays the first 10 seconds of the first tracks of all the CDs in the CD changer.

Press the [SCN] button again to disengage the unit from disc play.

\* A scan play will start from the first tracks of next CDs following the one currently playing.

## Repeat Play

Press the [RPT] button, then the display shows "RPT", then the track currently playing will be played repeatedly. Press the [RPT] button again to disengage the unit from repeat play.

## Disc repeat play

Press and hold the [RPT] button for 1 second or longer, then the display shows both the "DISC" and "RPT", then the disc currently being played will be played repeatedly.

Press the [RPT] button again to disengage the unit from disc repeat play.

## Random Play

Press the [RDM] button, then the display will show "RDM", then the entire tracks on the disc will be played at random.

Press the [RDM] button again to disengage the unit from disc random play.

## Disc random playback

Press and hold the [RDM] button for 1 second or longer, then the display will show both the "DISC" and "RDM", then the entire tracks of all the discs in the CD changer will be played at random.

Press the [RDM] button again to disengage the unit from disc play.

## Switching Magazine

This function can be used only when the connected CD changer can store a multiple number of magazines.

Every time the [BND] button is pressed, the next magazine will be selected.

## 8. IN CASE OF DIFFICULTY

Problem	Cause	Measure
Power does not turn on. (or no sound is produced.)	Fuse is blown.	Replace with a fuse of the same amperage as the old fuse.
	Connections are improper.	Read the attached "Installation/Wire Connection Guide" once again and wire properly.
Sound quality is poor.	Playback head is dirty.	Use a cleaning tape, etc. to clean the head.
No sound while unit can be operated.	Power ANT lead is shorted to the ground.	Turn the unit off, first. Remove all connecting wires from the power ANT lead, and turn the unit on, then re-connect a wire one by one to the power ANT lead. When sound is muted again, check the unit with a wire connected last.

## 9. ERROR DISPLAYS

If an error occurs, one of the following displays is displayed.  
Take the measures described below to eliminate the problem.

	Error Display	Cause	Measure
Tape	<b>ERROR 1</b>	Tape cannot be played due to defective tape such as cut tape.	Eject the tape then replace it with a new one.
	<b>ERROR 2</b>	Tape is caught and cannot be played.	Remove the caught or wound tape.
	<b>ERROR 4</b>	Tape mode cannot be detected.	This is a failure of tape mechanism and consult your store of purchase.
	<b>ERROR 8</b>	Tape is caught and cannot be ejected.	Eliminate the reason for which the tape is caught.
CD changer	<b>ERROR 2</b>	A CD inside the CD changer is not loaded.	This is a failure of CD changer's mechanism and consult your store of purchase.
	<b>ERROR 3</b>	A CD inside the CD changer cannot be played due to scratches, etc.	Replace with a non-scratched, non-warped disc.
	<b>ERROR 6</b>	A CD inside the CD changer cannot be played because it is loaded upside-down.	Eject the disc then reload it properly.

If a display other than one of the displays above appears, press the reset button. If the problem persists, turn the power off and contact your store of purchase.

# 10. SPECIFICATIONS

## FM Tuner

Frequency Range.....87.0 MHz to 108 MHz  
Usable Sensitivity.....11 dBf  
50 dB Quieting Sensitivity.....17 dBf  
Alternate Channel Selectivity.....75 dB  
Stereo Separation (1 kHz).....35 dB  
Frequency Response ( $\pm 3$  dB)  
.....30 Hz to 15 kHz

## AM Tuner

Frequency Range.....531 kHz to 1602 kHz  
Usable Sensitivity.....25  $\mu$ V

## Tape

Wow & Flutter (WRMS).....0.08%  
Channel Separation (1 kHz).....45 dB  
Signal to Noise Ratio  
.....70  $\mu$ s (CrO<sub>2</sub>, FeCr, Metal): 58 dB  
Frequency Response ( $\pm 3$  dB)  
120  $\mu$ s (normal).....30 Hz to 18 kHz  
70  $\mu$ s (CrO<sub>2</sub>, FeCr, Metal).....30 Hz to 20 kHz

## Audio

Maximum Power Output.....200 W (50 W  $\times$  4ch)  
Continuous Average Power Output  
.....17 W  $\times$  4, into 4  $\Omega$ , 20 Hz to 20 kHz, 1%  
THD  
Bass Control Action (30 Hz)..... $\pm 13$  dB  
Treble Control Action (10 kHz)..... $\pm 10$  dB  
Line Output.....1.8 V (with CD A/C 1kHz 10 k $\Omega$ )

## General

Power Supply Voltage  
.....14.4 V DC (10.8 V to 15.6 V allowable)  
Current Consumption..... Less than 15 A  
Speaker Impedance  
.....4  $\Omega$  (4  $\Omega$  to 8  $\Omega$  allowable)  
Weight.....3.3 lb. (1.5 kg)  
Dimensions  
.....7" (178 mm) Width  $\times$  2" (50 mm) Height  
 $\times$  6-3/32" (155 mm) Depth

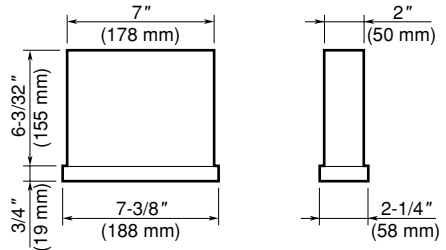

## Notes:

- Specifications comply with EIA Standards.
- Specifications and design are subject to change without notice for further improvement.

## Free Manuals Download Website

<http://myh66.com>

<http://usermanuals.us>

<http://www.somanuals.com>

<http://www.4manuals.cc>

<http://www.manual-lib.com>

<http://www.404manual.com>

<http://www.luxmanual.com>

<http://aubethermostatmanual.com>

Golf course search by state

<http://golfingnear.com>

Email search by domain

<http://emailbydomain.com>

Auto manuals search

<http://auto.somanuals.com>

TV manuals search

<http://tv.somanuals.com>