

Clarion®

Owner's manual & Installation manual

用户手册和安装手册

사용 설명 및 설치 설명서

คู่มือผู้ใช้ & คู่มือติดตั้ง

**Buku Petunjuk Penggunaan dan
Petunjuk Peningkatan**

VRX766VD

**DVD MULTIMEDIA STATION WITH
TOUCH PANEL CONTROL**

触屏式控制多媒体 DVD 播放器

**터치패널 컨트롤이 있는
DVD 멀티미디어 스테이션**

DVD มัลติมีเดียสเตชัน พร้อมหน้าจอ

ควบคุมสัมผัส

**STASIUN DVD MULTIMEDIA
DENGAN KONTROL PANEL
SENTUH**

Thank you for purchasing the Clarion **VRX766VD**.

* This owner's manual is for the **VRX766VD**.

* Please read this manual thoroughly before operating this equipment.

* After reading this manual, be sure to keep it in a handy place (e.g., glove compartment).

* Check the contents of the enclosed warranty card and keep it carefully with this manual.

* This manual includes the operating procedures of the 2-ZONE control, iPod control, CD changer, DVD changer, TV tuner, 5.1ch surround decoder. The CD changer, DVD Changer, TV tuner and 5.1ch surround decoder have their own manuals, but no explanations for operating them are described.

Contents

1. FEATURES	3
Expanding Systems	3
2. PRECAUTIONS	4
3. CONTROLS	5
4. NOMENCLATURE	6
Names of Buttons	6
5. OUTLINE OF BUTTON AND TOUCHKEY OPERATION	7
6. REMOTE CONTROL	13
Functions of Remote Control Unit Buttons	14
7. DCP	17
8. CAUTIONS ON HANDLING	18
Liquid crystal panel/Generalities	18
Cleaning	18
Handling Discs	19
9. DVD VIDEO SYSTEM	20
DVD Video Features	20
Discs	21
About the registered marks etc.	22
10. OPERATIONS	23
Basic Operations	23
Radio Operations	32
DVD Video Player Operations	34
Other Functions	49
11. OPERATIONS OF ACCESSORIES	51
iPod Operations	51
VISUAL Operations	54
CD Changer Operations	54
DVD Changer Operations	56
TV Operations	56
5.1 ch Surround Decoder Operations	59
12. IN CASE OF DIFFICULTY	63
13. ERROR DISPLAYS	65
14. SPECIFICATIONS	66
INSTALLATION AND WIRE CONNECTION MANUAL	67
1. BEFORE STARTING	67
2. PACKAGE CONTENTS	67
3. GENERAL CAUTIONS	67
4. CAUTIONS ON INSTALLATION	68
5. INSTALLING THE MAIN UNIT	69
6. REMOVING THE MAIN UNIT	71
7. CAUTIONS ON WIRING	71
8. WIRE CONNECTION	72
9. SAMPLE SYSTEM	75

1. FEATURES

- Fully-Motorized 7" Widescreen LCD
 - Touch Panel Control
 - DVD Video/CD-DA/MP3/WMA/Video CD Play Capability
 - RCA 6(+2)-Channel (2-zone) Output
 - Built-in 50 W × 4 Amplifier
 - CeNET with Balanced Audio Line Transmission and Dynamic Noise Canceling
 - CD-R/CD-RW/DVD-R/DVD-RW Compatible
 - 5.1 Channel Decoder for DTS and Dolby Digital Capability
 - Optical Digital Output
 - 2-ZONE Control
 - iPod® Control
- "iPod" is a trademark of Apple Computer, Inc., registered in the U.S. and other countries.



Expanding Systems

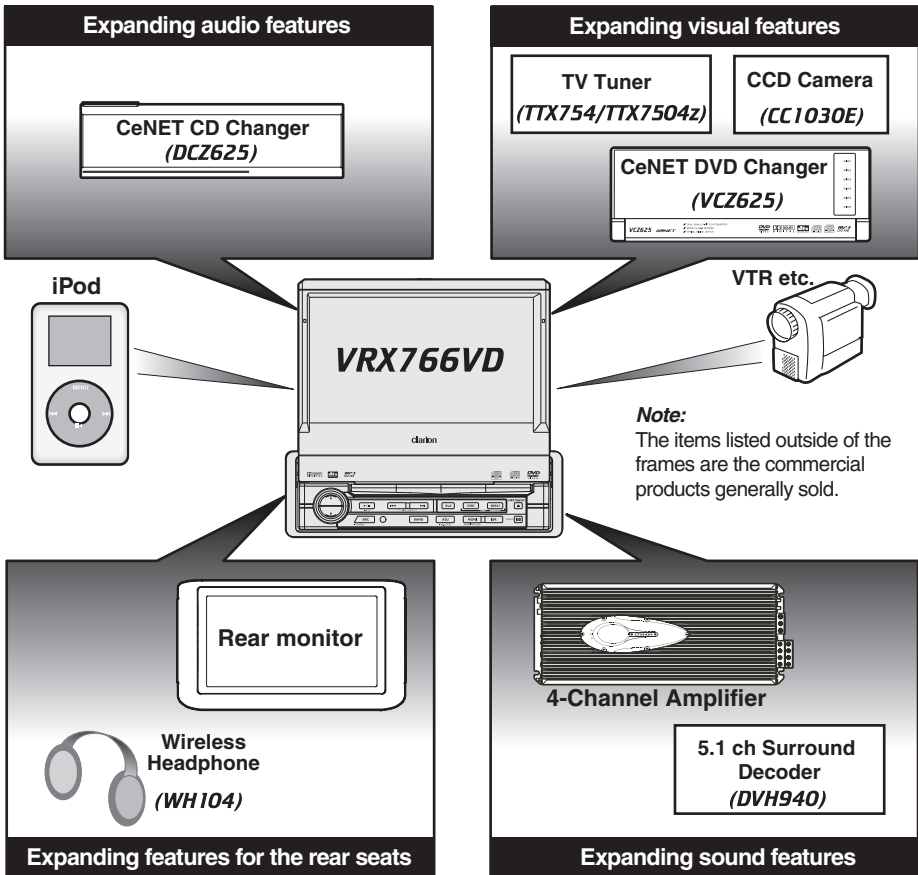

2. PRECAUTIONS

⚠ WARNING

For your safety, the driver should not watch the DVD video/TV/VTR or operate the controls while driving. Please note that watching and operating the DVD video/TV/VTR while driving are prohibited by law in some countries. Also, while driving, keep the volume to a level at which external sounds can be heard.

1. When the inside of the car is very cold and the player is used soon after switching on the heater, moisture may form on the disc (DVD/CD) or the optical parts of the player and proper playback may not be possible. If moisture forms on the disc (DVD/CD), wipe it off with a soft cloth. If moisture forms on the optical parts of the player, do not use the player for about one hour. The condensation will disappear naturally allowing normal operation.
2. Driving on extremely bumpy roads which cause severe vibration may cause the sound to skip.
3. This unit uses a precision mechanism. Even in the event that trouble arises, never open the case, disassemble the unit, or lubricate the rotating parts.
4. TV broadcast reception (when the optional TV tuner is connected)
When receiving the TV broadcast, the strength of the signals changes since the car is moving, so in some cases it may not be possible to receive clear pictures.
 - TV signals are strongly linear, so reception is affected by buildings, mountains and other obstacles.
 - Such external factors such as electric train lines, a high voltage lines, and signal devices may disturb the picture or cause noise.

* If the reception is poor, switch to a station with good reception.

**INFORMATION FOR USERS:.
CHANGES OR MODIFICATIONS TO THIS
PRODUCT NOT APPROVED BY THE
MANUFACTURER WILL VOID THE
WARRANTY.**

Be sure to unfold and read the next page.

请务必展开并阅读下一页。

반드시 다음 페이지를 펴서 읽으십시오.

โปรดคลี่ส่วนที่พับไว้เพื่ออ่านหน้าต่อไป
Pastikan anda membuka dan
membaca halaman berikutnya

3. CONTROLS / 控制鍵 / 컨트롤 / ส่วนควบคุม / PENGONTROLAN

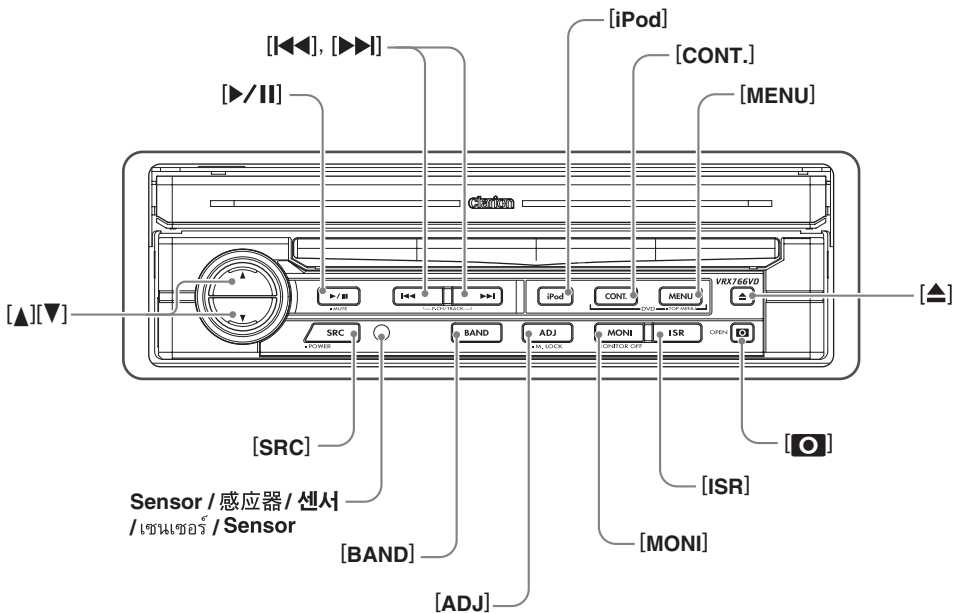

Note : Be sure to unfold this page and refer to the front diagrams as you read each chapter.

*The control panel can be detached to prevent theft. For details, see the pages entitled "7. DCP".

注意 : 阅读各章时请务必展开此页并阅读前面的图。

*控制面板可以拆卸以防被盗。详细信息，请参见以“7. DCP (可拆卸控制面板)”为标题的页。

주 : 이 페이지를 펼치고 각 장을 읽을 때 전면 그림을 참조하십시오.

*컨트롤 패널은 도난 방지를 위해 분리 가능합니다. 자세한 내용은 "7. DCP" 페이지를 참조하십시오.

หมายเหตุ : โปรดคลี่หน้าทีพับไว้เพื่ออ้างอิงกับแผนภาพของแผงด้านหน้าเมื่ออ่านเนื้อหาแต่ละบท

*แผงควบคุมสามารถถอดออกได้เพื่อกันขโมย สำหรับรายละเอียด ดูหน้าที่มีหัวข้อ "7.DCP"

Catatan : Pastikan anda membuka halaman berikut dan mengacunya pada diagram di depan pada saat membaca setiap bab.

*Panel kontrol dapat dilepas untuk mencegah pencurian. Untuk lebih jelasnya, baca bagian berjudul "7. DCP".

4. NOMENCLATURE

Names of Buttons

Note:

- Be sure to read this chapter while referring to the front diagrams for chapter "3.CONTROLS" on page 5 (unfold).

[▲], [▼] buttons

- Use these buttons to increase/decrease the volume.

[▶/⏸] button

- Press this button to enter the play pause mode in the DVD PLAYER/iPod/changer modes. Press the button again to resume playback.
- Keep pressing this button more than 1 second to mute the sound in the DVD PLAYER/iPod/changer modes.
- Press this button to mute the sound in the TUNER/TV/VISUAL modes.

[SRC] button

- Press this button to turn on the power. Keep pressing this button more than 1 second to turn off the power.
- When the liquid crystal panel closed, press this button to change to the next mode such as TUNER mode.
- When the liquid crystal panel open, press this button to display the Source menu screen to switch the mode.

[◀◀], [▶▶] buttons

- Use these buttons to change to the previous/next preset station in the TUNER/TV modes.
- Use these buttons to select a track in the CD, Video CD, MP3/WMA, iPod and CD changer modes.
- Use these buttons to select a chapter in the DVD video and DVD changer modes.

[BAND] button

- Press this button to switch the receiving bands for TUNER/TV modes. Keep pressing this button more than 1 second to switch the Seek/Manual tuning modes.
- Use this button to move to the first track in the CD, Video CD and iPod modes, or the first chapter in the DVD video mode.
- Use this button to move to the next folder in the MP3/WMA mode.
- Use this button to switch to the next disc in the changer modes.
- Keep pressing this button more than 1 second to play all tracks in the iPod mode.

[iPod] button

- Press this button to switch to the iPod mode.

[CONT.] button

- Press this button to show/hide the key pad on the menu screen of DVD video/Video CD.

[MENU] button

- Press this button to show the menu screen of DVD video/Video CD. Keep pressing this button more than 1 second to show the top menu screen of DVD video.

[ADJ] button

- Press this button to enter/exit the ADJUST mode to change the settings.
- Keep pressing this button more than 1 second switches the liquid crystal panel to a composite screen to lock the monitor (To enable this function, go to the GENERAL menu (within the ADJUST menu), and use the [CONNECT] key to select "NAVI" or "OTHER").

[MONI] button

- Press this button to enter/exit the Monitor Adjust mode.
- Keep pressing this button more than 1 second to turn off the back light of the liquid crystal panel.

[ISR] button

- Use this button to enter/exit the ISR (Instant Station Recall) standby mode.
- Keep pressing this button more than 2 seconds to store the current station into ISR memory in the radio mode.

- * The [ISR] button is disabled when the SUB zone is selected in the 2-ZONE mode.

[▲] (EJECT) button

- Use this button to eject the disc set in this unit.

[○] (OPEN) button

- Use this button to open/close the liquid crystal panel.
- Keep pressing this button more than 2 seconds so that the liquid crystal panel is positioned horizontally when the liquid crystal panel is open (Air Conditioner Operation mode).
- When the liquid crystal panel closed, Keep pressing this button more than 5 seconds to perform the panel calibration function to memorize the maximum angle of the liquid crystal panel.

5. OUTLINE OF BUTTON AND TOUCHKEY OPERATION

Turning the power on

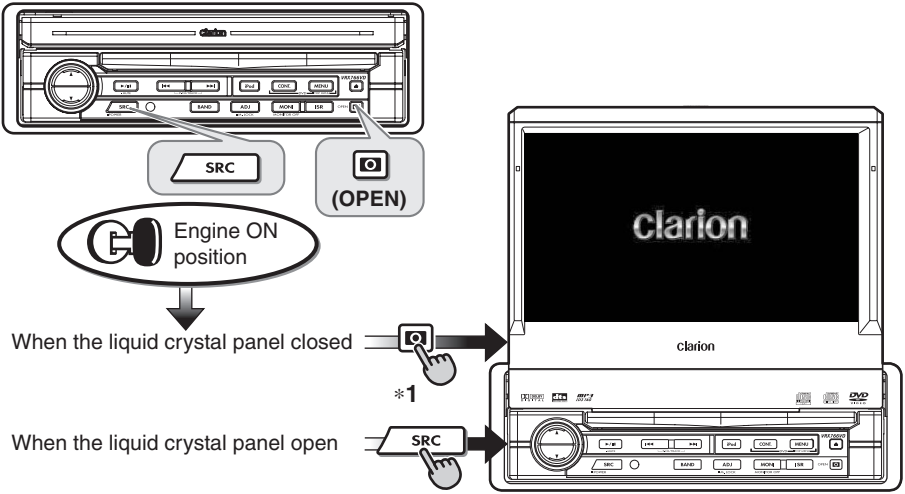

System check

The CeNET format utilized on this unit is provided with a system check function. When the system check function is performed under the following conditions, the power is automatically turned off. Press the [SRC] button again.

- When power is first turned on after initial installation.
- When an external device is connected or disconnected.
- When Reset button is pressed.

*In addition to the above conditions, the system check function can be performed from the GENERAL menu in the ADJUST mode.

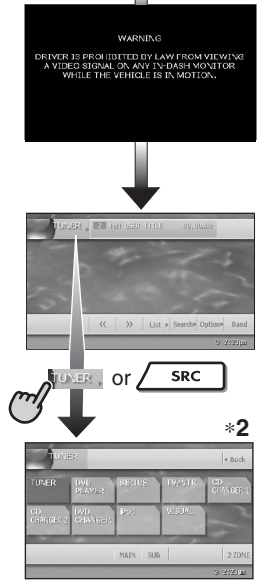

*You can change the media sources.

TUNER mode operation

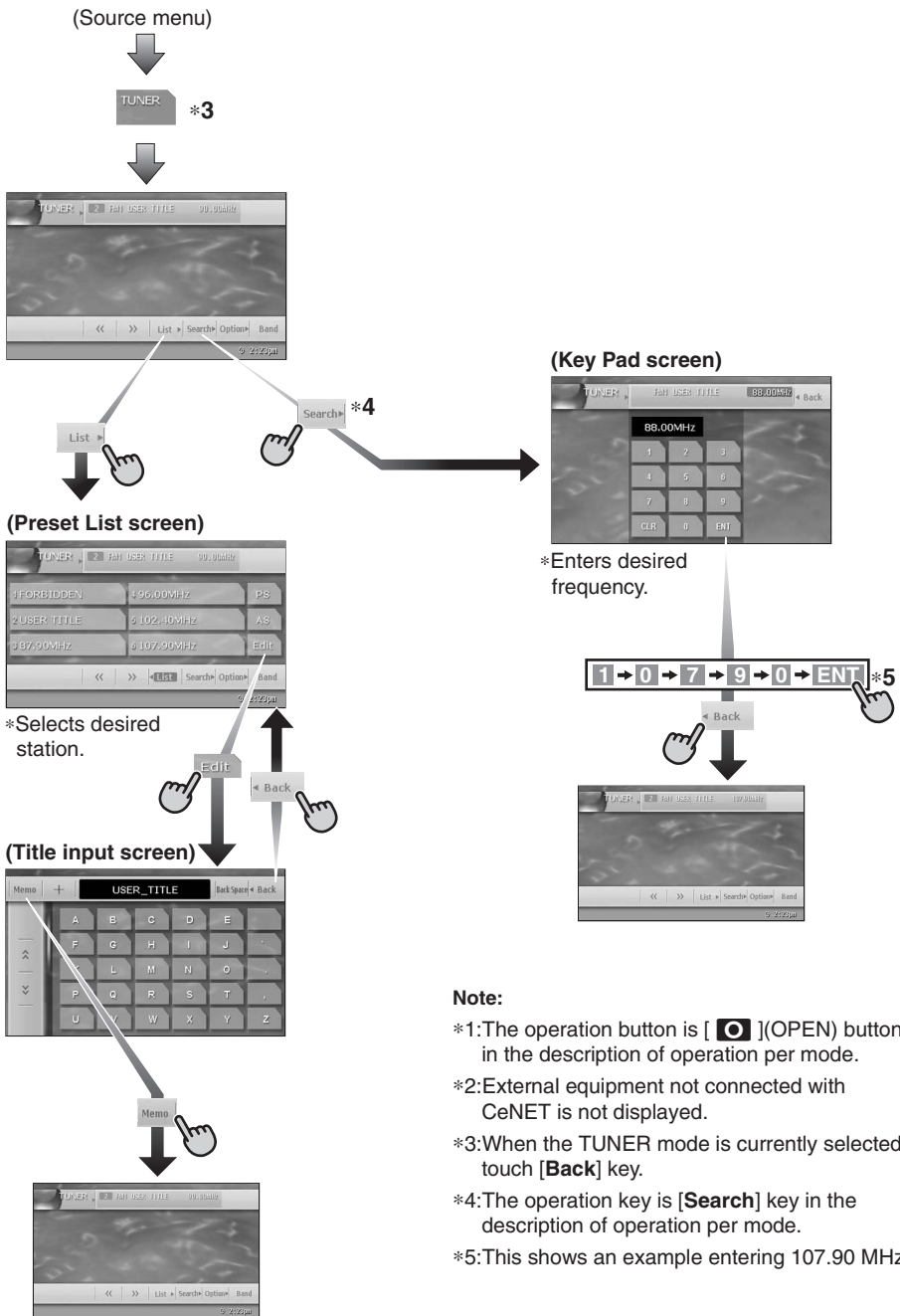

Note:

- *1: The operation button is [] (OPEN) button in the description of operation per mode.
- *2: External equipment not connected with CeNET is not displayed.
- *3: When the TUNER mode is currently selected, touch [Back] key.
- *4: The operation key is [Search] key in the description of operation per mode.
- *5: This shows an example entering 107.90 MHz.

DVD Video mode operation

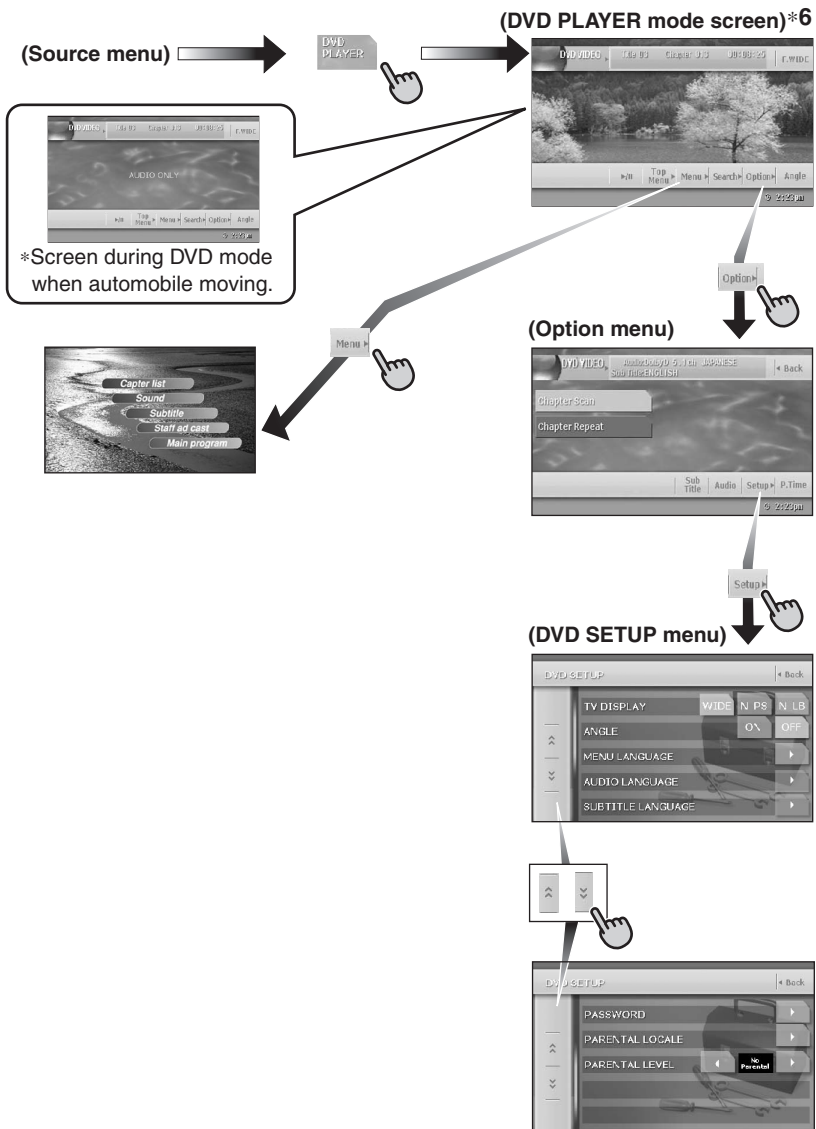

Note:

*6: When displaying movies in DVD video mode, touching the screen surface will cause the DVD PLAYER mode screen to be displayed.

Adjusting audio feature settings

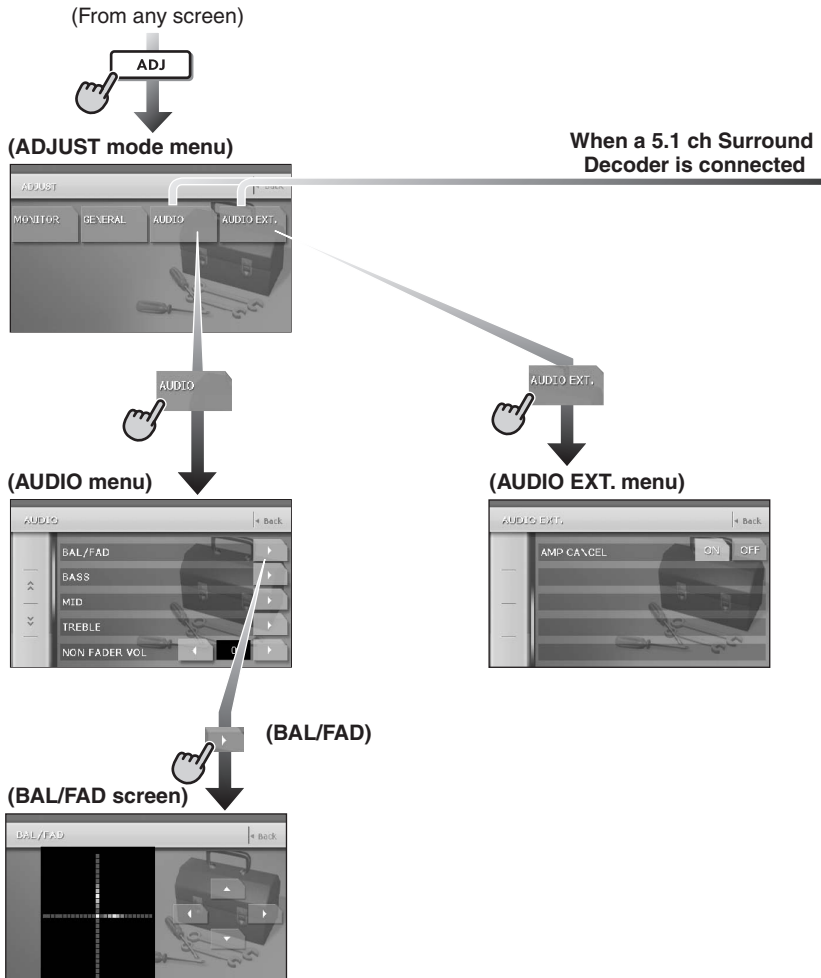

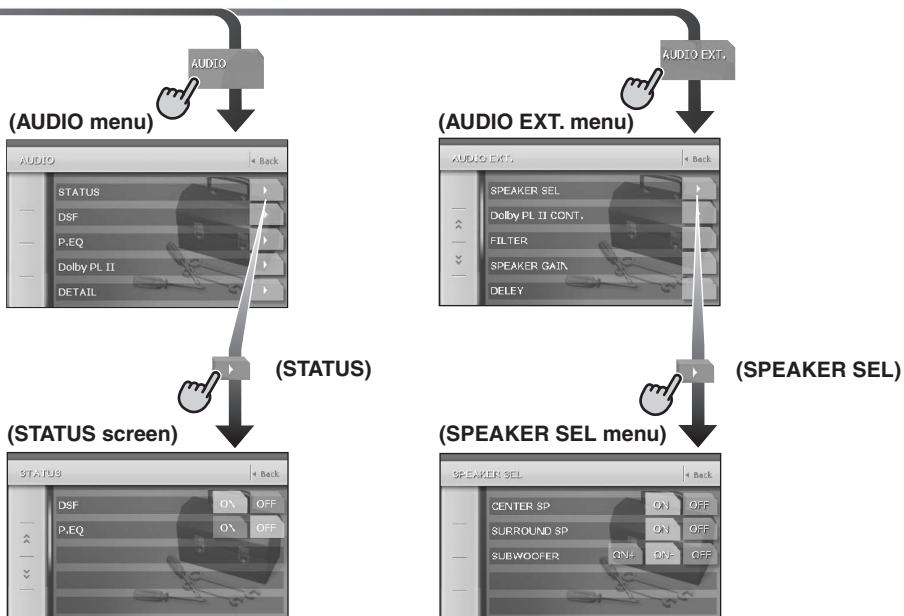

Adjusting the other system settings

(From any screen)



(ADJUST mode menu)

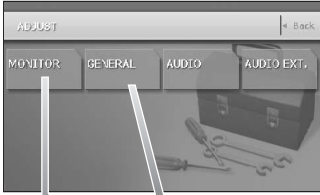

(GENERAL menu)

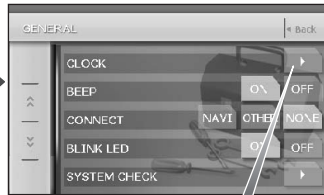

(CLOCK)

(CLOCK screen)



(Hour, Minute, a.m./p.m.)



(MONITOR menu)

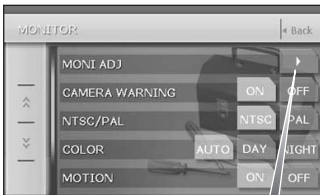

(MONI ADJ)

(Monitor Adjust screen)



Bright → Color → Hue → Dimmer

*Switched by touching this key repeatedly.



6. REMOTE CONTROL

Remote control unit

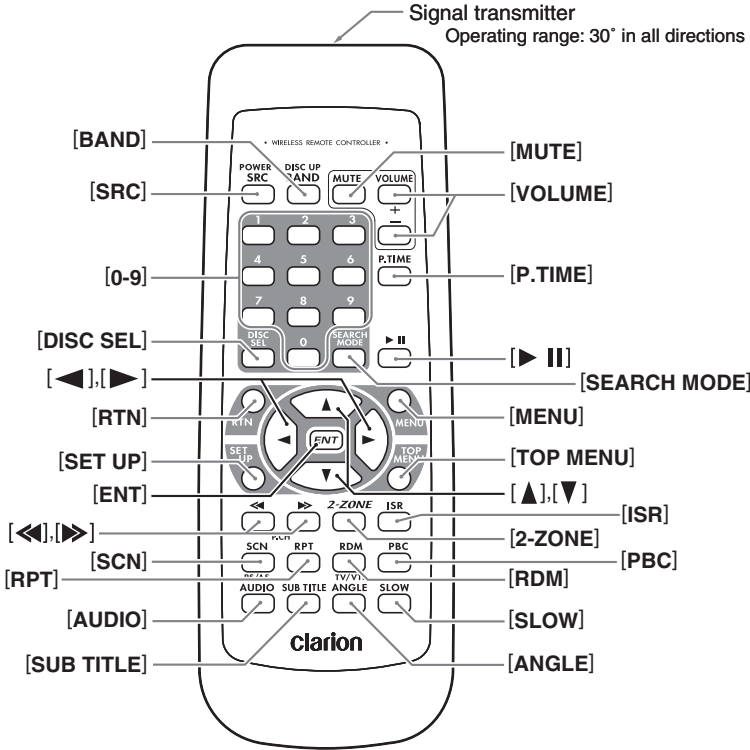

Inserting the Batteries

1. Slide the rear cover in the direction of the arrow, and remove it.
2. Insert the AA (SUM-3, IECR-6/1.5V) batteries bundled with the remote control unit in the directions shown in the figure, then close the rear cover.

Note:

Using batteries improperly can cause them to explode. Take note of the following points:

- When replacing batteries, replace both batteries with new ones.
- Do not short-circuit, disassemble or heat batteries.
- Do not dispose of batteries into fire or flames.
- Dispose of spent batteries properly.

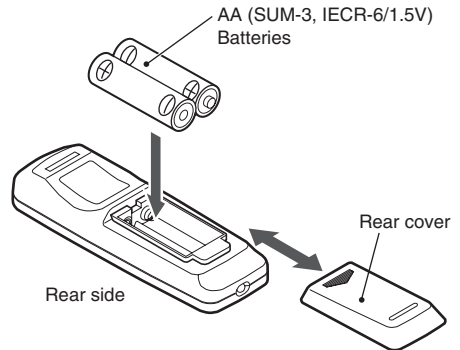

Functions of Remote Control Unit Buttons

You can use the remote control unit to control the VRX766VD. When the 2-ZONE function is ON, the controls work upon the selected zone.

Shared modes

[SRC] button

- Press this button to turn on the power. Keep pressing this button more than 1 second to turn off the power.
- Press this button to switch the modes such as TUNER mode, DVD PLAYER mode.

[VOLUME] buttons

- Increase and decrease volume.

[MUTE] button

- Turns mute on and off.

[RTN] button

- Returns to the previous screen from the list or menu screens.
- Displays the menu screen when playing a Video CD.

[2-ZONE] button

- Keep pressing more than 1 second to turn on the 2-ZONE, and keep pressing again to turn off 2-ZONE.
- Press to switch between the MAIN zone and SUB zone when the 2-ZONE is turned on.

TUNER/TV mode

[BAND] button

- Switches reception band.
- Keep pressing more than 1 second to switch the Seek/Manual tuning modes.

[0 - 9] button

- Use in the Key Pad screen to set the radio frequency or TV channels.
- Use to select the preset number in the Preset List screen.

[DISC SEL] button

- Press to show/hide the Preset List screen.

[SEARCH MODE] button

- Press to show/hide the Key Pad screen.

[ENT] button

- Press to fix the entered data in the Key Pad screen.

[◀], [▶] buttons

- Press to select the next higher or lower preset station in TUNER and TV modes.

[SCN] button

- Press to perform preset scans in the TUNER and TV modes.
- Keep pressing more than 1 second to perform the auto store operation in the TUNER and TV modes.

[ISR] button

- Recall ISR radio station in memory.
- Keep pressing more than 2 seconds to store current station into ISR memory (radio mode only).

[RDM] button

- Press to switch between TV mode and VTR mode.

DVD PLAYER mode

[BAND] button

- Press to return to the first chapter in DVD video mode.
- Press to return to the first track in CD and Video CD modes when playing back.
- Press to move to the next folder when more than 1 folder are played back in MP3/WMA mode.

[P.TIME] button

- Press to turn on and off the playtime display in the DVD video/Video CD modes.

[▶ II] button

- Press to play or pause video and audio media.
- Keep pressing more than 1 second to stop video playback in DVD video.

[0 - 9] buttons

- Press to enter DVD video chapters/titles in the Key Pad screen.
- Press to set the track/folder number of the CD, Video CD or MP3/WMA in the Key Pad screen.

[DISC SEL] button

- Press to show/hide the Track List screen in the CD mode.
- Press to show/hide the Folder List screen in the MP3/WMA mode.

[SEARCH MODE] button

- Press to display the Key Pad operation screen.
- Keep pressing more than 1 second to switch the search mode.

[RTN] button

- Press to switch to the menu screen while a Video CD is being played back. Press to switch to the previous screen display while the Menu screen is being displayed. However, it may occur that this button operation does not work on some discs.

[MENU] button

- Press to display menu stored on video disc.

[SET UP] button

- Press to show the DVD SETUP menu screen during DVD video playback.

[TOP MENU] button

- Press to display the Top Menu screen stored on DVD video disc. Some discs do not display the top menu screen.

[▲], [▼], [◀], [▶] buttons

- Press to select button items on the menu screen of a DVD video.
- Press [▲], [▼] to scroll the Track/Folder List screen in the CD and MP3/WMA modes.

[ENT] button

- Press to fix the entered data in the Key Pad screen.
- Press to fix the selected item in the menu screens.

[◀◀], [▶▶] buttons

- Press to select the next higher or lower chapter number in DVD video mode.
- Press to select the next higher or lower track in CD, Video CD and MP3/WMA modes.
- Keep pressing to perform fast-forward and fast-backward.
- Keep pressing to perform slow playback while pausing a DVD video/Video CD play.

[SCN] button

- Press to perform chapter scans in the DVD video mode, and track scans in CD and MP3/WMA modes.
- Keep pressing more than 1 second to perform folder scans in MP3/WMA mode.

[RPT] button

- Press to perform chapter repeat in the DVD video mode, and track repeat in CD and MP3/WMA modes.
- Keep pressing more than 1 second to perform folder repeat in MP3/WMA mode.

[RDM] button

- Press to play tracks at random in CD and MP3/WMA modes.
- Keep pressing more than 1 second to play folders at random in MP3/WMA mode.

[PBC] button

- Press to turn on and off the PBC function in the Video CD mode.

[AUDIO] button

- Press to switch the AUDIO function in the DVD video/Video CD modes.

[SUB TITLE] button

- Press to display subtitles in the DVD video mode.

[ANGLE] button

- Press to switch the ANGLE function in the DVD video mode when the Angle mark is displayed. (This button is available only on multiple angles DVDs and when the ANGLE function in the SET UP menu is set to ON.)

[SLOW] button

- Press to perform slow playback in the DVD video/Video CD modes.

iPod mode

[BAND] button

- Press to return to the first track in the current play list.
- Keep pressing more than 1 second to change to the All play mode. All tracks in the Song list will be played back.

[▶ II] button

- Press to play or pause the selected media.

[▲], [▼] buttons

- Press to scroll the list screens.

[◀◀], [▶▶] buttons

- Press to select the next higher or lower track numbers.
- Keep pressing to perform fast-forward or fast-backward.

CD changer mode

[BAND] button

- Press to switch discs.

[DISC SEL] button

- Press to show/hide the Disc List screen.

[▶ II] button

- Press to play and pause the selected media.

Functions of Remote Control Unit Buttons

[0 - 9] buttons

- Press to enter track numbers in the Key Pad screen.
- Press to select the disc number in the Disc List screen.

[▲], [▼] buttons

- Press to scroll the Disc/Track List screen.

[◀], [▶] buttons

- Press to select the next higher or lower track numbers.
- Keep pressing to perform fast-forward or fast-backward.

[SCN] button

- Press to perform track scan.
- Keep pressing more than 1 second to perform disc scan.

[RPT] button

- Press to perform track repeat.
- Keep pressing more than 1 second to perform disc repeat.

[RDM] button

- Press to play tracks of all discs at random.
- Keep pressing more than 1 second to play folders of all discs at random.

DVD changer mode

[BAND] button

- Press to switch discs.

[P.TIME] button

- Keep pressing more than 1 second to switch between the time progress and remaining time to be displayed.

[DISC SEL] button

- Press to show/hide the Disc List screen.

[0 - 9] buttons

- Press to enter track numbers in the Key Pad screen.
- Press to select the disc number in the Disc List screen.

[▲], [▼], [◀], [▶] buttons

- Press to scroll the Disc/Track List screen.

[SCN] button

- Press to perform track scan.
- Keep pressing more than 1 second to perform disc scan.

[RPT] button

- Press to perform track repeat.
- Keep pressing more than 1 second to perform disc repeat.
- Other button operations in this mode are the same as those in DVD PLAYER mode.

When SUB zone is selected

SUB zone operations are supported, but button functions are limited as follows:

Shared modes

[VOLUME] buttons

- Controls sound volume for MAIN zone source.

[MUTE] button

- Controls audio mute function for MAIN zone source.

[ISR] button

Not supported.

CD changer mode

- This mode is disabled when MAIN zone is set to an external equipment other than the CD changer.

DVD changer mode

- This mode is disabled when MAIN zone is set to an external equipment other than the DVD changer.

7. DCP

The control panel can be detached to prevent theft. When detaching the control panel, store it in the DCP (Detachable Control Panel) case to prevent scratches.

We recommend taking the DCP with you when leaving the car.

Removing the DCP

1. Keep pressing the [SRC] button more than 1 second to turn off the power.

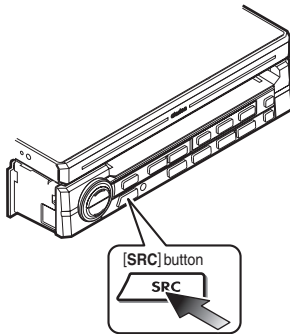

2. Pull the left side of the DCP toward you, and remove it.

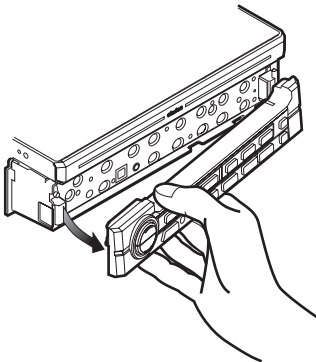

⚠ CAUTION

When the Auto Panel function (see page 29) is set to "OFF", be sure to close the liquid crystal panel for safe before removing the DCP.

Attaching the DCP

1. Hook the right side of the DCP to the right side of the main unit.
2. Settle the left side of the DCP to the main unit.

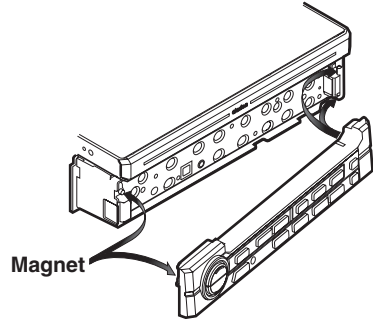

⚠ CAUTION

- This unit uses a magnet to fix the DCP. For the items that can be affected by magnetism, such as magnetic cards, be sure to keep them away from this unit.
- The DCP can easily be damaged by impact. After removing it be careful not to drop it nor subject it to strong impact.
- Remote control unit cannot be used when the DCP is removed.

Note:

- If the DCP is dirty, wipe it off by using a soft dry cloth.

8. CAUTIONS ON HANDLING

Liquid crystal panel/Generalities

For a longer service life, be sure to read the following cautions.

- Be sure to house the liquid crystal panel inside the main unit when parking the car outdoors for long period of time. The liquid crystal panel will operate properly in a temperature range of 0 to 60°C.
- Do not allow any liquids on the set from drinks, umbrellas etc. Doing so may damage the internal circuitry.
- Do not disassemble or modify the set in any way. Doing so may result in damage.
- Do not draw the liquid crystal panel out and use it as a tray. Also, subjecting the liquid crystal panel to shocks may result in breakage, deformation or other damage.
- Do not let cigarettes burn the display. Doing so may damage or deform the cabinet.
- If a problem should occur, have the set inspected at your store of purchase.
- Do not insert objects or poke in the space between the liquid crystal panel and the main unit when the panel is tilted.
- Do not place anything on the display when the panel is tilted.
- The remote control may not work if the remote control sensor is exposed to direct sunlight.
- In extremely cold weather, the display movement may slow down and the display may darken, but this is not a malfunction. The display will work normally when the temperature increases.
- Small black and shiny spots inside the liquid crystal panel are normal for LCD products.
- The liquid crystal panel may stop temporarily when it opens or closes, when the engine stops or when it is cold.
- The touchkeys on the display operate when slightly touched. Do not press the touchkey screen with much force.
- Do not push the case surrounding the touchkey panel with much force. This may cause malfunctioning of the touchkeys.

Cleaning

- **Cleaning the cabinet**

Use a soft, dry cloth and gently wipe off the dirt. For tough dirt, apply some neutral detergent diluted in water to a soft cloth, wipe off the dirt gently, then wipe again with a dry cloth.

Do not use benzene, thinner, car cleaner, etc., as these substances may damage the cabinet or cause the paint to peel. Also, leaving rubber or plastic products in contact with the cabinet for long periods of time may cause stains.

- **Cleaning the liquid crystal panel**

The liquid crystal panel tends to collect dust, so wipe it off occasionally with a soft cloth. The surface is easily scratched, so do not rub it with hard objects.

Handling

- New discs may have some roughness around the edges. If such discs are used, the player may not work or the sound may skip. Use a ball-point pen or the like to remove any roughness from the edge of the disc.

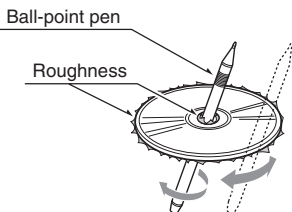

- Never stick labels on the surface of the disc or mark the surface with a pencil or pen.
- Never play a disc with any cellophane tape or other glue on it or with peeling off marks. If you try to play such a disc, you may not be able to get it back out of the DVD player or it may damage the DVD player.
- Do not use discs that have large scratches, are misshapen, cracked, etc. Use of such discs may cause misoperation or damage.
- To remove a disc from its storage case, press down on the center of the case and lift the disc out, holding it carefully by the edges.
- Do not use commercially available disc protection sheets or discs equipped with stabilizers, etc. These may damage the disc or cause breakdown of the internal mechanism.

Storage

- Do not expose discs to direct sunlight or any heat source.
- Do not expose discs to excess humidity or dust.
- Do not expose discs to direct heat from heaters.

Cleaning

- To remove fingermarks and dust, use a soft cloth and wipe in a straight line from the center of the disc to the circumference.
- Do not use any solvents, such as commercially available cleaners, anti-static spray, or thinner to clean discs.
- After using special disc cleaner, let the disc dry off well before playing it.

On Discs

- Exercise a good precaution when loading a disc with the panel open.
- Never turn off the power and remove the unit from the car with a disc loaded.

⚠ CAUTION

With the screen open, a driver may not be able to see the disc insertion slot. For your safety, insert a disc with the screen closed.

Even when the screen is closed, however, the recessed disc slot may be difficult for a driver to see, care is needed whenever inserting discs.

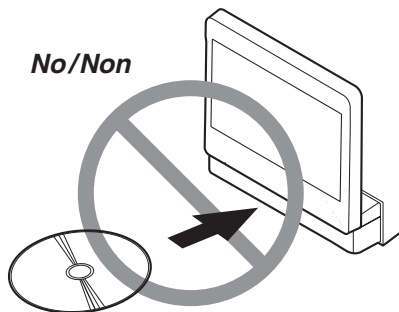

9. DVD VIDEO SYSTEM

DVD video is a high-quality digital video source that provides crisp and clear images. One 12 cm disc contains either one film or four hours of music.

DVD Video Features

This unit provides the following functions in addition to the high image quality and sound quality of DVD video.

Note:

- The functions described in the section, "**Features**", for example, the recorded language, subtitles, angles, etc. differ with the DVD video disc. Refer to the instructions provided with the DVD video.
- Some disc functions may operate differently from described in this manual.

Multi-sound function

DVD video can store up to 8 languages for one film; select the language of your preference.

- The languages stored on the disc are indicated by the icon shown below.



Multi-angle function

A DVD video that is filmed from multiple angles allows you to select the angle of choice.

- The number of recorded angles are indicated by the icon shown below.

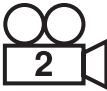

Subpicture (subtitles) function

A DVD video can record subtitles for up to 32 languages and you can select the language of the subtitles you wish to see.

- The number of recorded subtitle languages are indicated by the icon shown below.



Multi-story function

When a DVD video contains more than one story for a film, you can select the story you wish to enjoy. The operation procedures vary with the disc; observe the instructions for selecting a story provided during playback.

Dolby digital

Dolby digital enables up to 5.1 independent multi-channel audio reproduction, the same type of surround system that is used in movie theaters.

DTS

DTS (Digital Theater System) is a digital sound compression technique developed by Digital Theater Systems, Inc.

This low sound compression format delivers a large amount of data and makes it possible to reproduce a high quality sound.

Menu screens







Menus can be called up during DVD video playback to perform menu setting.

- Example showing menu display



Playable discs

This DVD video player can play the following discs.

Playable discs		
DVD video discs 	video CDs 	CD TEXT 
Audio CDs 	MP3 ID3 TAG 	WMA 

About CD Extra discs

A CD Extra disc is a disc in which a total of two sessions have been recorded. The first session is Audio session and the second session is Data session.

Your personally-created CDs with more than second data sessions recorded cannot be played on this DVD video player.

Note:

- When you play a CD Extra disc, only the first session will be recognized.

About playing a CD-R/CD-RW disc (MP3, WMA)

This player can play CD-R/CD-RW discs previously recorded in music CD format (MP3, WMA) or video CD format.

About playing a DVD-R/RW or DVD+R/RW disc

This player cannot play DVD-R/RW and DVD+R/RW discs previously recorded in video CD format.

However, MP3/WMA files recorded on DVD-R/RW and DVD+R/RW discs can be played.

Discs that cannot be played back

This DVD video player cannot play back DVD-Audio, DVD-RAM, Photo CDs, etc.

Note:

- It may also not be possible to play back CDs recorded on a CD-R unit and CD-RW unit. (Cause: disc characteristics, cracks, dust/dirt, dust/dirt on player's lens, etc.)
- If a CD-R or CD-RW disc that has not been finalized is played, it will take a long time to start playing. Also, it may not be possible to play depending on its recording conditions.
- You cannot play Super Audio CDs. Playback of the CD player is not supported even if it is a hybrid disc.

About MP3/WMA playback

This unit can play back CD-R/CD-RW, DVD-R/RW and DVD+R/RW discs on which MP3/WMA music data have been recorded.

For a detailed information, see the section entitled "Listening to an MP3/WMA" (page 45).

Note on region numbers

The DVD video system assigns a region number to DVD video players and DVD discs by sales area.

The DVD video region number is marked on the disc jacket as shown below.

(Asia)



(Oceania)



About the registered marks etc.

- This product incorporates copyright protection technology that is protected by U.S. patents and other intellectual property rights. Use of this copyright protection technology must be authorized by Macrovision, and is intended for home and other limited viewing uses only unless otherwise authorized by Macrovision. Reverse engineering or disassembly is prohibited.
- Manufactured under license from Dolby Laboratories. “**Dolby**”, and the double-D symbol are trademarks of Dolby Laboratories.
- “**DTS**” and “**DTS Digital Out**” are trademarks of Digital Theater Systems, Inc.
- “**iPod**” is for legal or rightholder-authorized copying only. Do not steal music.
- Windows Media™, and the Windows® logo are trademarks, or registered trademarks of Microsoft Corporation in the United States and/or other countries.

Basic Operations

Note:

Be sure to read this chapter referring to the chapter "3. CONTROLS" on page 5.

⚠ CAUTION

When the unit is turned on, starting and stopping the engine with its volume raised to the maximum level may harm your hearings. Be careful about adjusting the volume.

Turning on and off the power

Note:

- Start the engine before using this unit.
- Be careful about using this unit for a long time without running the engine. If you drain the car's battery too far, you may not be able to start the engine and this can reduce the service life of the battery.

1. Start the engine. The illuminations on this unit light up.



Engine ON
position

2. Press the [SRC] button. When the liquid crystal panel is not open, press the [OPEN] button to turn on the power. The unit automatically memorizes its last operation mode and will automatically switch to display that mode.
3. To turn off the power, press and hold the [SRC] button for more than 1 second.

Selecting a mode

When the liquid crystal panel is open

1. Press the [SRC] button to display the Source menu.
 - * External equipment not connected to this unit is not displayed.
2. Touch the desired mode key.

When the liquid crystal panel is closed

1. Press the [SRC] button to change the operation mode.
Each time you press the [SRC] button, the operation mode changes in the following order:
TUNER mode → DVD PLAYER mode → (CD CHANGER mode) → (DVD CHANGER mode) → (TV/VTR mode) → VISUAL mode → (iPod mode) → TUNER mode...
 - * External equipment not connected to this unit will not be selected.
 - * When 2-ZONE function is ON, the [SRC] button operates only for the MAIN zone. To switch to a SUB zone source, specify from the Source menu screen, or use the optional remote control unit.

Adjusting the volume

1. Press the [▲]/[▼] buttons to adjust the volume.
 - [▲]: Increases the volume.
 - [▼]: Decreases the volume.
 - * The volume level indicated in the display is in a range from 0 (min.) to 33 (max.).

⚠ CAUTION

While driving, keep the volume level at which external sounds can be heard.

Basic Operations

Mute

- When in the TUNER, VISUAL or TV mode, press the [▶/III] button to turn the mute on and off.
When in the DVD PLAYER, iPod or changer mode, keep pressing the [▶/III] button more than 1 second to turn the mute on and off.
* When the mute is turned on, "MUTE" appears at the bottom left of the screen.

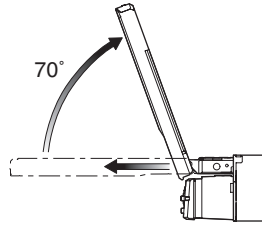

Opening and turning the liquid crystal panel

⚠ WARNING

- To prevent the battery from going dead, operate this unit with the engine running if possible.
- When the liquid crystal panel is operating, be careful not to get your hand or finger caught between the panel and main unit or the instrument panel of the car.
- Do not move the liquid crystal panel by hand.

Standing up the liquid crystal panel

- Press the [O] (OPEN) button.
The liquid crystal panel comes out and stands up automatically.
The power of this unit will be turned on.

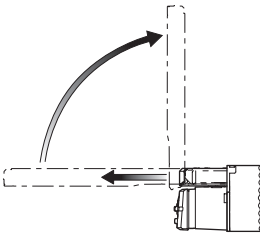

Note:

- If the liquid crystal panel stops in the middle of its operation, press the [O] (OPEN) button to house the panel and press the button again to raise it.
The unit will enter the same display mode as the display was in when last turned off.

Panel calibration function

The liquid crystal panel's maximum angle of inclination can be adjusted to match the installation configuration within the automobile.

- Perform this with the panel in its closed position.
- Keep pressing the [O] (OPEN) button more than 5 seconds.
The electronic beep will be heard.
After the beep sounds twice, the panel will come out and stand up to the maximum angle.
After completion of the calibration, the panel will be housed into the unit automatically.
* If the panel does not strike the instrument panel or other parts of the car during calibration, the maximum inclination will be 110°.
* If the panel strikes a car part during calibration within a range of 70° inclination, the maximum downward inclination will be 70°.

Adjusting the angle of the liquid crystal panel

The angle of the liquid crystal panel can be adjusted depending on the mounting angle of the unit or light coming into the car.

1. Turn the power on. When the liquid crystal panel is closed, press the **[O]** (OPEN) button.
2. Press the **[ADJ]** button, touch the **[MONITOR]** key, and then touch **[↕]** key to display the following screen:



3. Repeat touching the **[O]** key to adjust the angle of the liquid crystal panel. Every touching the **[O]** key tilts the liquid crystal panel forward or backward. The adjusted angle is stored in memory.
 - * Adjustment is possible within the range 70° to 110°.
 - * There are 5 adjustable angle available.

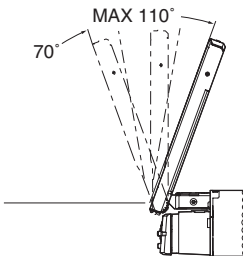

Housing the liquid crystal panel

1. Press the **[O]** (OPEN) button. The liquid crystal panel is housed automatically.

Note:

- When leaving this unit unused for a long period of time or leaving your car, be sure to house the liquid crystal panel.

Turning the liquid crystal panel horizontal (Air conditioner operation mode)

When the way the liquid crystal panel is mounted hinders the operation of the air conditioner, the position of the panel can be turned horizontal temporarily.

1. Keep pressing the **[O]** (OPEN) button more than 2 seconds when the liquid crystal panel is open. A beep sounds and the liquid crystal panel turns horizontal.
 - * Press the **[O]** (OPEN) button again for the panel to return to the original position.
 - * The unit can be set so that the panel returns to the original position after a set time in the horizontal position (See page 29).

Adjusting the AUDIO

Note:

- When the optional 5.1 ch Surround Decoder (DVH940) is used, the following tone adjustments cannot be made. To adjust the tone, refer to the section "5.1 ch Surround Decoder Operations".

1. Press the **[ADJ]** button, then touch the **[AUDIO]** key.

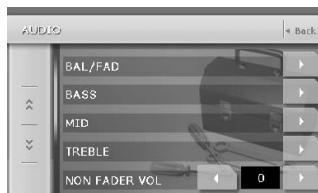

2. Touch the item key to adjust.
3. Perform the adjustment. See the following sections for detail.
4. Touch the **[Back]** key to return to the previous screen.
 - * In the following sections, only the details regarding adjustments are described, procedures to select items are skipped.

Basic Operations

Adjusting the balance/fader

- 2-1. Touch the [▶] key of the **BAL/FAD** item.
- 3-1. Touch the [▲] or [▼] key to adjust to the fader level.
- * The factory default setting is "0". (Adjustment range: front 12 to rear 12)

[▲] :
Emphasized the sound from the front speakers.

[▼] :
Emphasized the sound from the rear speakers.

- 3-2. Touch the [◀] or [▶] key to adjust to the balance level.
- * The factory default setting is "0". (Adjustment range: left 13 to right 13)

[◀] :
Emphasized the sound from the left speakers.

[▶] :
Emphasized the sound from the right speakers.

Adjusting the BASS

The bass gain, bass frequency (center frequency) and bass Q can be adjusted as follows.

- 2-1. Touch the [▶] key of the BASS item.
- 3-1. When the AUDIO BASS screen is displayed, touch the [◀] or [▶] key for the desirable type to adjust to a desirable level.

GAIN :
-6 to 8 (The factory default setting is "0".)

FREQ. :
50Hz, 80Hz, 120Hz (The factory default setting is "50Hz".)

Q :
1, 1.25, 1.5, 2 (The factory default setting is "1".)

Adjusting the MID

The MID gain, MID frequency (center frequency) and MID Q can be adjusted as follows.

- 2-1. Touch the [▶] key of the MID item.
- 3-1. When the AUDIO MID screen is displayed, touch the [◀] or [▶] key for the desirable type to adjust to a desirable level.

GAIN :
-6 to 6 (The factory default setting is "0".)

FREQ. :
700Hz, 1kHz, 2kHz (The factory default setting is "1kHz".)

Q :
1.5, 2 (The factory default setting is "2".)

Adjusting the TREBLE

The treble gain and treble frequency (center frequency) can be adjusted as follows.

- 2-1. Touch the [▶] key of the TREBLE item.
- 3-1. When the AUDIO TREBLE screen is displayed, touch the [◀] or [▶] key for the desirable type to adjust to a desirable level.

GAIN :
-6 to 6 (The factory default setting is "0".)

FREQ. :
8kHz, 12kHz (The factory default setting is "12kHz".)

Adjusting the non fader output volume

You can adjust the volume output from the unit's non fader output terminal.

- 2-1/ Touch the [◀] or [▶] key of the NON FADER
- 3-1. VOL item to adjust to desirable level.

Setting range :
-6 to 6 (The factory default setting is "0".)

Turning on/off the MAGNA BASS EXTEND

The Magna Bass Extend does not adjust the low sound area like the normal sound adjustment function, but emphasizes the deep bass sound area to provide you with a dynamic sound.

- 2-1. Touch the [↵] key to display the next menu screen.
- 3-1. Touch [ON] or [OFF] of the [M-B EX] item to turn the Magna Bass Extend effect on or off (The factory default setting is "OFF").

Adjusting the MONITOR

1. Press the [ADJ] button, then touch the [MONITOR] key.

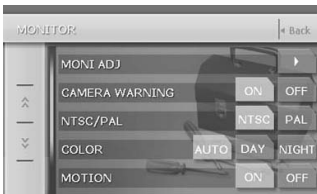

2. Perform the adjustment for the desired item. See the following sections for detail.
3. Touch the [Back] key to return to the previous screen.

* In the following sections, only the details regarding adjustments are described, procedures to select items are skipped.

Adjusting the brightness, color, hue and dimmer level

Note:

- This function is not available when the liquid crystal panel is closed.
- The Color and Hue settings can be adjusted only in the DVD video, Video CD, TV/VTR, VISUAL and DVD changer modes, and only when the car is stopped and the parking brake is applied.
- The Hue setting can be adjusted only when the NTSC mode is selected.

- 2-1. Touch the [▶] key of the MONI ADJ item to display the MONI ADJ screen.
* This screen can also be displayed directly by pressing the [MONI] button.

- 2-2. Touch the [Bright] key repeatedly to select the adjustment type. Every pressing it changes adjustment type as follows:
[Bright] → [Color] → [Hue] → [Dimmer] → [Bright] ...

"Bright" :
Adjusts the brightness of the display.

"Color" :
Adjusts the color saturation.

"Hue" :
Adjusts the tone of color (red is emphasized or green is emphasized).

"Dimmer" :
Adjusts the panel brightness when the car lights are ON/OFF.

The factory default setting is :
When the car light is off: brightest setting (58 steps)

When the car light is on :
medium brightness (29 steps)

- 2-3. Touch [◀] or [▶] key to adjust a level.

"Bright"
[▶] : Press to make image brighter.
[◀] : Press to make image dimmer.

"Color"
[▶] : Press to increase color depth.
[◀] : Press to decrease color depth.

"Hue"
[▶] : Press to make image brighter.
[◀] : Press to make image dimmer.

"Dimmer"
[▶] : Press to make image brighter.
[◀] : Press to make image dimmer.

Basic Operations

Warning display when CCD camera is installed

When a TV tuner (optional) is installed together with optional CCD camera, the following warning message is displayed during use of the CCD camera: **"Make sure of safety around your vehicle"**.

- 2-1. Touch the **[ON]** or **[OFF]** key of the CAMERA WARNING item to turn this function on or off (The factory default setting is **"ON"**).

Switching the VTR system between NTSC and PAL

Note:

- This function is enabled only when the panel is open.
- This setting is applied only to the VISUAL/VTR input mode.

- 2-1. Touch the **[NTSC]** or **[PAL]** key of the NTSC/PAL item to set the VTR system. The factory default setting is:
 - **"NTSC"** for the Korea/Taiwan model
 - **"PAL"** for the models for other countries

Changing the color of the title and command bars in the screen

- 2-1. Touch the **[AUTO]**, **[DAY]** or **[NIGHT]** key of the COLOR item to set the color mode (The factory default setting is **"AUTO"**).

"AUTO" :

The color is changed according to the status of the car light:

- When the car light is off: light gray color
- When the car light is on: dark gray color

"DAY" :

Set to the light gray color.

"NIGHT" :

Set to the dark gray color.

Turning on/off the motion of the background picture

- 2-1. Touch the **[ON]** or **[OFF]** key of the MOTION item to set the function (The factory default setting is **"ON"**).

Front monitor lock

When an external device is connected to the Visual terminal, lock the front monitor to show the visual input source.

1. Keep pressing the **[ADJ]** button more than 1 second to set the monitor lock. The front monitor screen is locked to show the visual input source.
2. To cancel the monitor lock, press the **[ADJ]** button. The screen returns to show the image of the selected mode.

Adjusting the GENERAL

1. Press the **[ADJ]** button, then touch the **[GENERAL]** key.

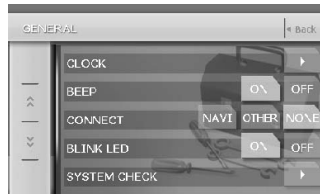

2. Perform the adjustment for the desired item. See the following sections for detail.
3. Touch the **[Back]** key to return to the previous screen.
 - * In the following sections, only the details regarding adjustments are described, procedures to select items are skipped.

Clock Adjustment

- 2-1. Touch the **[▶]** key of the CLOCK item.
- 2-2. Touch the **[▲]** and **[▼]** keys under the Hour, Minute and a.m./p.m. box to adjust the time, then touch the **[SET]** key (The factory default setting is **"1:00 a.m."**).
 - * The time is displayed in 12-hour format.

Setting the BEEP

The sound heard when you make operations is called **"beep"**. The unit can be set up so that it does not produce this beep sound.

- * The factory default setting is **"BEEP ON"**.

- 2-1. Touch the **[ON]** or **[OFF]** key of the BEEP item to turn the function on or off.

Switching CONNECT (connect)

Make the following settings when an external device is connected to the Visual terminal.

NAVI :

when a navigation system is connected.

- * When the navigation system is connected, use the monitor lock function. Locking the monitor locks the screen size in F.WIDE mode (full wide) and the VTR system to NTSC.

OTHER :

for external devices other than a navigation system.

NONE :

when no external device is connected.

- * The factory default setting is "NONE".

- 2-1. Touch the [NAVI], [OTHER] or [NONE] key of the CONNECT item to set the function to "NAVI", "OTHER" or "NONE".

Setting the Blink LED

You can set the unit to blink the LED indication when the DCP (Detachable Control Panel) is removed.

- 2-1. Touch the [ON] or [OFF] key of the BLINK LED item to turn the function on or off (The factory default setting is "OFF").

Performing the system check

- 2-1. Touch the [▶] key of the SYSTEM CHECK item.
The available operation mode is listed in white letters.
- 2-2. Touch [Check] key at the top right of the screen to perform the system check manually.
The system will be restarted after performing the system check.

Setting the Auto Panel

When you remove or attach the DCP (Detachable Control Panel), you can set the liquid crystal panel automatically housing or opening.

- * The factory default setting is "ON".

- 2-1. Touch the [✔] key to display the next menu screen.
- 2-2. Touch the [ON], [OFF] or [CLOSE] key of the AUTO PANEL item to set to "ON", "OFF" or "CLOSE".

ON :

The liquid crystal panel houses automatically after removing the DCP. And the liquid crystal panel opens automatically after attaching the DCP.

OFF :

Normal operation.

CLOSE :

The liquid crystal panel houses automatically after removing the DCP.

Setting the time of air conditioner operation mode

This setting can be used to adjust the time the panel stays in the horizontal position when in the air conditioner operation mode.

- * The factory default setting is 10 seconds.

- 2-1. Touch the [✔] key to display the next menu screen.
- 2-2. Touch the [5s], [10s] or [30s] key of the HVAC MODE item to set the time to "5 seconds", "10 seconds" or "30 seconds".

Basic Operations

2-ZONE Function

About the 2-ZONE function

The 2-ZONE function is a function that outputs separate sounds/images from the MAIN zone and SUB zone (such as the optional rear monitor) by simultaneously operating two sources in the one center unit. Thereby, plural listeners are allowed to enjoy separate audio/visual sources. The 2-ZONE function allows internal sources (TUNER, DVD, VISUAL, iPod) and external sources via CeNET connection (CD changer, TV/VTR, etc.) to be played on MAIN zone and SUB zone. Controlling sources of MAIN zone and SUB zone can be made from the main unit and from the remote control unit.

The source sounds of the MAIN zone are played back from the speakers of the vehicle side, and those of the SUB zone are from the headphone systems (WH104).

Sound volume control on the SUB zone is performed by the headphone system (WH104).

Note:

- Radio stations cannot be selected when the SUB zone is selected.
- The external different equipments connected via CeNET cannot simultaneously be used in the MAIN and SUB zones. Though the same equipment can be specified simultaneously.
- If the 5.1 channel surround decoder (DVC940) is connected, this function is disabled.
- When an external equipment is specified for the SUB zone, the 2-ZONE function is turned off if the function of audio mute for cellular phone is turned on or off.
- The SUB zone cannot be controlled when the function of audio mute for cellular phone is turned on.
- When the 2-ZONE function is turned on, the VTR mode cannot be specified for both of the MAIN and SUB zones simultaneously.

Setting the 2-ZONE function

- * The factory default setting is "OFF".
1. Press the [SRC] button to display the Source menu.
 2. Touch and hold the [2 ZONE] key more than 1 second to turn the 2-ZONE function on. The 2-ZONE indication is displayed at the top left of the screen.
- * The function can also be switched by using the optional remote control unit. See the chapter "6. REMOTE CONTROL" for details.



2-ZONE indication

Displayed when 2-ZONE function is turned on.

- [MAIN]:MAIN zone is selected.
- [SUB]:SUB zone is selected.

3. Touch the [SUB] key on the Source menu to switch to the SUB zone. You can control the operation modes for the SUB zone.
4. Press the [SRC] button, and touch the [MAIN] key to return to the MAIN zone.
5. To turn the 2-ZONE function off, touch the [2 ZONE] key on the Source menu.

Monitor image and sound with 2-ZONE ON/OFF

● With 2-ZONE function OFF

	Front monitor lock ON		Front monitor lock OFF	
	Visual connection [OTHER] (*1)	Visual connection [NAVI] (*1)	Visual connection [OTHER] (*1)	Visual connection [NAVI] (*1)
Front monitor (liquid crystal panel)	Displays image of device connected to the Visual terminal. (*3)	Displays image of device connected to the Visual terminal.	Displays image of mode selected from the Source menu.	
Rear monitor (optional)	Displays image of mode selected from the Source menu. (*2)			
Audio output	Sound from mode selected from the Source menu is output from 4ch speaker, NON-FADER, and AUDIO-OUT.			

● With 2-ZONE function ON

	Front monitor lock ON		Front monitor lock OFF	
	Visual connection [OTHER] (*1)	Visual connection [NAVI] (*1)	Visual connection [OTHER] (*1)	Visual connection [NAVI] (*1)
Front monitor (liquid crystal panel)	Displays image of device connected to the Visual terminal. (*3)	Displays image of device connected to the Visual terminal.	Displays image of mode selected from the Source menu in the MAIN zone mode.	
Rear monitor (optional)	Displays image of mode selected from the Source menu in the SUB zone mode. (*2)			
Audio output	<ul style="list-style-type: none"> • Sound from mode selected in the MAIN zone mode is output from 4ch speaker, NON-FADER and AUDIO-OUT. • Sound from mode selected in the SUB zone mode is output from SUB-OUT. 			

*1: A device connected to the Visual terminal should be set up as described in the section “**Switching CONNECT(connect)**”.

*2: No image is displayed on the rear monitor when a non-image mode such as CD changer mode, etc. is selected.

*3: For safety reasons, this image is not displayed when the vehicle is moving. The picture can be watched only when the vehicle is stopped and the parking brake is applied.

Radio Operations

Listening to the radio

1. Press the [SRC] button, and touch the [TUNER] key.
The TUNER mode screen is displayed.



2. Press the [BAND] button or touch the [Band] key to select the radio band. Each time the button is pressed, the radio reception band changes in the following order:
FM1 → FM2 → FM3 → AM → FM1...
3. Press the [◀] or [▶] button to tune in the previous or next preset station.

Seek tuning

1. Press the [BAND] button or touch the [Band] key to select the desired band (FM or AM).
2. If "MANU" is displayed at the bottom of the display, keep pressing the [BAND] button more than 1 second.
"MANU" in the display goes off, and seek tuning is now available.
* The same operation is available by using the [Band] key.
3. Touch the [◀] or [▶] key to automatically seek a station.
 - When touching the [▶] key, the station is sought in the direction of higher frequencies.
 - When touching the [◀] key, the station is sought in the direction of lower frequencies.

Selecting stations by entering frequency

This function displays the Key Pad on the screen allowing you to tune by entering a frequency.

1. Press the [BAND] button or touch the [Band] key to select the desired band (FM or AM).
2. Touch the [Search] key to display the Key Pad screen.



3. Touch the [0]~[9] key corresponding with the frequency you desired. When you input the wrong number, touch the [CLR] key to delete the last input number.
4. Touch the [ENT] key to tune in to the entered frequency.
5. Touch the [Back] key.

Manual tuning

There are 2 ways available: Quick tuning and step tuning.

When you are in the step tuning mode, the frequency changes one step at a time. In quick tuning mode, you can quickly tune the desired frequency.

1. Press the [BAND] button or touch the [Band] key to select the desired band (FM or AM).
2. If "MANU" is not displayed at the bottom of the display, keep pressing the [BAND] button more than 1 second.
"MANU" appears in the display, and manual tuning is now available.
* The same operation is available by using the [Band] key.

3. Tune into a station.

Quick tuning :

Touch and hold the [◀] or [▶] key for more than 1 second to tune in a station.

Step tuning:

Touch the [◀] or [▶] key to manually tune in a station.

Recalling a preset station

There are total of 24 preset positions (6-FM1, 6-FM2, 6-FM3, 6-AM) to store individual radio stations in memory.

There are 2 ways available to recall the preset station.

● Using the [◀◀] or [▶▶] button

1. Press the [BAND] button to select the desired band (FM or AM).
2. Press the [◀◀] or [▶▶] button to recall the previous or next stored station.

● Using the Preset List screen

1. Touch the [List] key.



2. Touch the corresponding Preset key to recall the stored station.

* You can select the desired band by touching the [Band] key.

* Touching and holding the desired Preset key for more than 2 seconds will store the current station to the preset memory.

3. Touch the [List] key to return to the previous screen.

Manual memory

1. Touch the [Band] key to select the desired band. (FM or AM)
2. Select the desired station with seek tuning, manual tuning, or preset tuning.
3. Touch the [List] key.
4. Touch and hold one of the Preset key for more than 2 seconds to store the current station into the preset memory.

Auto store

Auto store is a function for storing up to 6 stations that are automatically tuned in sequentially. If 6 receivable stations cannot be received, a previously stored station remains unoverwritten at the memory position.

1. Touch the [Band] key to select the desired band. (FM or AM)
2. Touch the [List] key.
3. Touch and hold the [AS] key for more than 2 seconds.

A beep sounds and the stations with good reception are stored automatically to the preset channels.

Preset scan

Preset scan receives the stations stored in preset memory in order. This function is useful when searching for desired station in memory.

1. Touch the [List] key.
2. Touch the [PS] key to start preset scan. The unit starts scanning each station for 7 seconds sequentially.
3. When the desired station is tuned in, touch the [PS] key again to continue receiving that station.

Instant station recall (ISR)

Instant station recall is a special radio preset that instantly accesses a favorite radio station at a touch of a button. The ISR function even operates with the unit in other modes.

● ISR memory

1. Select the station that you wish to store in ISR memory.
2. Keep pressing the [ISR] button more than 2 seconds to store the current station into the ISR memory.

● Recalling a station with ISR

1. In any mode, press the [ISR] button to switch to the TUNER mode and tune the selected radio station. "ISR" appears in the display. Press the [ISR] button again to return to the previous mode.

* The [ISR] button is disabled when SUB zone is selected in the 2-ZONE mode.

DVD Video Player Operations

Changing DVD System Settings

Note:

- If the Setup operation is performed in the middle of DVD video play, the disc will restart from beginning.
- The settings on the DVD SETUP menu cannot be set with the remote control unit.

Selecting the DVD SETUP menu

1. Press the [SRC] button, and touch the [DVD PLAYER] key.
The DVD PLAYER mode screen is displayed.
2. Touch the [Option] key to display the Option menu.
3. Touch the [Setup] key to display the DVD SETUP menu.



Touch the [✓] key to display the next menu.
Touch the [↶] key to return to the previous menu.



4. Perform setting for the desired setting items.
See the following sections for detail.
5. Touch the [Back] key.
 - * In the following sections, only the details regarding settings are described, the procedures to select items are skipped.

Setting up the screen size

Set up the screen size according to the rear view monitor which is connected to this unit.

- 4-1. Touch the [WIDE], [N PS] or [N LB] key of the TV DISPLAY item to change the screen size to "WIDE", "N PS" or "N LB".
 - * The factory default setting is "WIDE".

● When watching through a conventional type of the rear view monitor (4:3)

N PS :

The leftmost and rightmost areas of the screen are cut off.

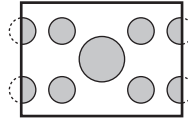

This function allows displaying the important part of image fully on the screen. In some cases, image is displayed while being panned (scrolled).

N LB :

A black zone is created in the top and bottom areas of the screen.

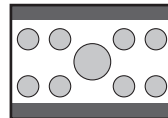

This method displays Cinema Scope and Vista Vision images without cutting them off by creating a black zone on the top and bottom gaps.

● When watching through a wide type of the rear view monitor (16:9)

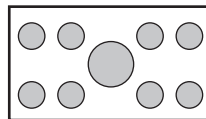

Setting up the angle mark display

You can set up so that the angle mark appears on scenes where the angles can be switched.

- 4-1. Touch the [ON] or [OFF] key of the ANGLE item to turn the Angle function "ON" or "OFF".
 - * The factory default setting is "OFF".

Setting up the disc menu language

- 4-1. Touch the [▶] key of MENU LANGUAGE item.
The MENU LANGUAGE menu is displayed.
- 4-2. Touch the key to select a desired language to set it.
* The factory default setting is "ENGLISH".

Setting up the audio language

- 4-1. Touch the [▶] key of AUDIO LANGUAGE item.
The AUDIO LANGUAGE menu is displayed.
- 4-2. Touch the key to select a desired language to set it.
* The factory default setting is "ENGLISH".

Setting up the subtitle language

- 4-1. Touch the [▶] key of SUBTITLE LANGUAGE item.
The SUBTITLE LANGUAGE menu is displayed.
- 4-2. Touch the key to select a desired language to set it.
* The factory default setting is "ENGLISH".

Setting up the password for setting up of the parental level

- 4-1. Touch the [▶] key of PASSWORD item.
The PASSWORD screen is displayed.
- 4-2. Touch the ten-key (0 to 9) to input a 4-digit password.
 - Input the old password, and touch the [ENT] key.
* The factory default setting is "0000".
 - * Input "4356" to return password to "0000".
 - Input a new password, and touch the [ENT] key.

Note:

- When a disc with view restrictions is inserted, you will be prompted to input a password. The disc will not be viewable until the correct password is entered.

Setting up the country code

Set up the country number for setting up of the parental level.

- 4-1. Touch the [▶] key of PARENTAL LOCALE item.
The PARENTAL LOCALE screen is displayed.
- 4-2. Touch the ten-key (0 to 9) to input a 4-digit country code.
* The factory default setting is "8583" (U.S.A.).

Country code list

Country	Input code
Region number 3	
BRUNEI DARUSSALAM	6678
Kingdom of Cambodia	7572
INDONESIA	7368
KOREA, DEMOCRATIC PEOPLE'S REPUBLIC OF	7580
KOREA, REPUBLIC OF	7582
LAO PEOPLE'S DEMOCRATIC REPUBLIC	7665
MALAYSIA	7789
MYANMAR	7777
PHILIPPINES	8072
SINGAPORE	8371
THAILAND	8472
VIET NAM	8678
EAST TIMOR	8480
HONG KONG	7275
MACAU	7779
TAIWAN, PROVINCE OF CHINA	8487
Region number 4	
ANTIGUA AND BARBUDA	6571
ARGENTINA	6582
AUSTRALIA	6585
BAHAMAS	6683
BARBADOS	6666
BELIZE	6690
BOLIVIA	6679

Country	Input code
BRAZIL	6682
CHILE	6776
COLOMBIA	6779
COSTA RICA	6782
CUBA	6785
DOMINICA	6877
DOMINICAN REPUBLIC	6879
ECUADOR	6967
EL SALVADOR	8386
FIJI	7074
GRENADA	7168
GUATEMALA	7184
GUYANA	7189
HAITI	7284
HONDURAS	7278
JAMAICA	7477
KIRIBATI	7573
MARSHALL ISLANDS	7772
MEXICO	7788
MICRONESIA, FEDERATED STATES OF	7077
NAURU	7882
NEW ZEALAND	7890
NICARAGUA	7873
PALAU	8087
PANAMA	8065
PAPUA NEW GUINEA	8071
PARAGUAY	8089
PERU	8069
SAINT KITTS AND NEVIS	7578
SAINT LUCIA	7667
SAINT VINCENT AND THE GRENADINES	8667
SAMOA	8783
SOLOMON ISLANDS	8366
SURINAME	8382

Country	Input code
TONGA	8479
TRINIDAD AND TOBAGO	8484
TUVALU	8486
URUGUAY	8589
VANUATU	8689
VENEZUELA	8669
ANGUILLA	6573
ARUBA	6587
VIRGIN ISLANDS (BRITISH)	8671
CAYMAN ISLAND	7589
CHRISTMAS ISLAND	6789
COCOS (KEELING) ISLANDS	6767
COOK ISLANDS	6775
FALKLAND ISLANDS (MALVINAS)	7075
FRENCH GUIANA	7170
FRENCH POLYNESIA	8070
GAUDELOUPE	7180
GUAM	7185
MARTINIQUE	7781
MONTSERRAT	7783
NETHERLANDS ANTILLES	6578
NEW CALEDONIA	7867
NIUE	7885
NORFOLK ISLAND	7870
NORTHERN MARIANA ISLANDS	7780
PITCAIRN	8078
TOKELAU	8475
TURKS AND CAICOS ISLANDS	8467
WALLIS AND FUTUNA ISLANDS	8770

4-3. Touch the [ENT] key.

Setting up the parental level

You can change the level of parental lock (audio-visual restriction).

This function allows cutting scenes that are unfavorable for children or replacing them automatically with other scenes prepared in advance. For example, by replacing scenes of radical violence or portrayals of sex with safe scenes, you can make a trouble-free story as if it were so from the beginning.

4-1. Touch the [◀] or [▶] key of PARENTAL LEVEL item.

When you touch the [◀] or [▶] key, PASSWORD input screen is displayed.

4-2. Touch the ten-key (0 to 9) to input a 4-digit password, and touch the [ENT] key.

* The factory default setting of the password is "0000".

4-3. Touch the [◀] or [▶] key to select level 1 to 8, or 0 (no parental).

* The factory default setting is "8".

The relationship between DVD video category codes and parental level are shown in the table below. Use this table when setting the parental level.

LEVEL7	NC-17 (NO ONE 17 AND UNDER ADMITTED)
LEVEL6	R (RESTRICTED)
LEVEL4	PG-13 (PARENTS STRONGLY CAUTIONED)
LEVEL3	PG (PARENTAL GUIDANCE SUGGESTED)
LEVEL1	G (GENERAL AUDIENCES)

- The contents that the parental level restricts vary with the country code.

Basic Operations

Loading a disc

1. Insert a disc into the center of the insertion slot with the label side facing up. The disc plays automatically after loading.

Note:

- Never insert foreign objects into the disc insertion slot.
- If the disc is not inserted easily, there may be another disc in the mechanism or the unit may require service.
- 8 cm (single play) discs cannot be used.

⚠ CAUTION

With the screen open, a driver may not be able to see the disc insertion slot. For your safety, insert a disc with the screen closed.

Watching/Listening to a disc already inserted

1. Press the [SRC] button, and touch the [DVD PLAYER] key to select the DVD PLAYER mode.

Play starts automatically.

If no disc is loaded in the unit, "NO DISC" appears in the display.

⚠ WARNING

- Some videos may be recorded at higher than desired volume levels. Increase the volume gradually from the minimal setting after the video has started.
- For your safety, the driver should not watch the video or operate the controls while driving. Please note that watching and operating the video while driving are prohibited by law in some countries.

Note:

- For your safety, the VRX766VD has a safety function which turns off the picture when the car is moving, so only the audio can be heard. The picture can only be watched when the car is stopped and the parking brake is applied.

DVD Video Player Operations

Pausing play

1. Press the [▶/⏏] button or touch the [▶/⏏] key to pause play.
"PAUSE" appears in the display.
2. To resume disc play, press the [▶/⏏] button again.

Ejecting a disc

1. Press the [▲] (EJECT) button to eject disc.
"EJECT" appears in the display. The play mode then switches to the TUNER mode.
 - * If a disc is left in the ejected position for 15 seconds, the disc is automatically reloaded (Auto reload). In this case, however, the play mode will remain set to the TUNER mode.

Note:

- If you force a disc into before auto reloading, this can damage the disc.

DVD Video Operations

Watching a DVD-Video

After disc loading, the play mode is automatically engaged.

- When playback is not started, press the [▶/⏏] button or touch the [▶/⏏] key.
- Button operation may differ depending on the story of the disc.

● After the menu screen is displayed

For normal DVD-Video discs, the DVD menu screen appears.

After the DVD menu screen is displayed, select an item in the following operations and play it back.

Showing the DVD PLAYER mode screen

The DVD PLAYER mode screen is used to control the playback mode from the screen.

1. Touch the screen.
The DVD PLAYER mode screen is displayed. If you do not touch the screen for 7 seconds, the display will return to the playback screen.

Showing the DVD menu

1. Press the [MENU] button during playback.
The DVD menu appears.
 - * The displayed contents may differ depending on the DVD software.
 - The same operation can be performed by touching the [Menu] key from the DVD PLAYER mode screen.
 - Example showing DVD menu display



Operating the DVD menu

You can select the button items displayed in the DVD menu by directly touching it.

If the button items are hard to select correctly, you can also operate them by displaying Key Pad on the screen.

* When the Key Pad is displayed, direct operation of the button items is disabled.

* Direct operation of the button items is enabled only when the screen size is set to "WIDE" (see page 34).

1. Press the [CONT.] button.
The "Cross-Key" (▲▼◀▶) is displayed.
 - Repeat pressing the [CONT.] button changes the mode as follows: Cross-Key mode → Ten-Key mode → Direct operation mode → Cross-Key mode ...
2. Select the DVD menu button items use either the "Cross-Key" or the "Ten-Key" according to the disc contents menu.
3. Touch the [ENT] key to specify the selected button item.

Switching Key Pad position

When the Key Pad becomes difficult to view in the menu display, you can move it to the other side of the screen.

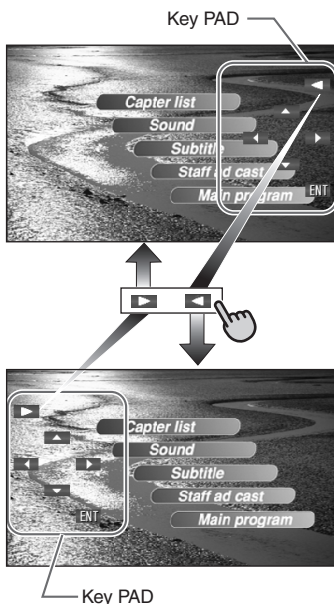

Stopping playback

1. Showing the DVD PLAYER mode screen, touch and hold the [▶/■] key for more than 1 second during playback. Playback is stopped.
2. To resume playback, touch the [▶/■] key. Playback resumes from the scene where playback is stopped.

Pausing playback

1. Press the [▶/■] button or touch the [▶/■] key during playback. Playback pauses.
2. To resume playback, press the [▶/■] button again. Playback resumes.

Slow playback

1. Press the [▶/■] button or touch the [▶/■] key, then press and hold the [▶▶] button. While pressing the button, slow playback continues at the speed 1/3 times the normal playback. Releasing the button resumes to the normal playback.
 - Slow playback cannot be performed in the backward direction. In addition, audio cannot be reproduced during slow playback.

DVD Video Player Operations

Skipping a chapter (searching)

About chapter

Chapter means a small segment to divide the data area of the disc.

1. Press the [◀◀] or [▶▶] button during playback.
Chapters are skipped, as many as the times the button is pressed, and playback starts.

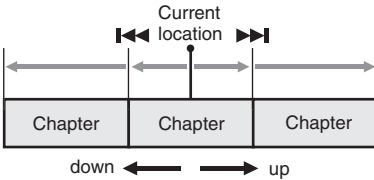

- Pressing the [▶▶] button starts playback from the beginning of the next chapter.
- Pressing the [◀◀] button starts playback from the beginning of the current chapter. When this button is pressed again within about 2 seconds, playback starts from the beginning of the previous chapter.
- The unit may return to the DVD PLAYER mode screen when the [▶▶] or [◀◀] button is pressed.

Fast forward and fast backward

1. Press and hold the [◀◀] or [▶▶] button during playback.
The playback speed becomes 5-time faster first and then 20-time faster 3 seconds later.
 - No audio is reproduced during fast forward and fast backward operation.
 - The fast forward and fast backward speed may differ depending on the disc.
 - The DVD PLAYER mode screen may appear when the [◀◀] or [▶▶] button is pressed.

Searching with a chapter/title number

You can locate the beginning of a scene using the chapter numbers or title numbers recorded on the DVD-Video disc.

1. Showing the DVD PLAYER mode screen, touch the [Search] key.
The Key Pad screen appears with the chapter number input mode. Touching the [Title] key turns the Key Pad to the title number input mode.
 - **Title**
A large segment to divide the data area of the disc.
 - **Chapter**
A small segment to divide the data area of the disc.
2. Input the number of the title/chapter that you want to play back with the [0] to [9] key.
3. Touch the [ENT] key.
Playback starts from the scene of the input title number or chapter number.
 - If the input title/chapter number does not exist or searching with a title/chapter number is not allowed, the screen image will not change.
4. Touch the [Back] key.

Scan playback

Scans and plays back all chapters recorded on the DVD-Video, the first 10 seconds for each.

1. Showing the DVD PLAYER mode screen, touch the [Option] key.
2. Touch the [CHAPTER SCAN] key, then touch the [Back] key.
The message "C.SCN" will be displayed. After scan playback of all chapters on the disc, chapter scanning through the same disc is performed again.
Depending on the disc, the menu may appear again after scan playback of all chapters within the title.
3. Press the [◀◀] button to turn off the scan playback.

Repeat playback

This operation plays back chapters recorded on the DVD-Video repeatedly.

1. Showing the DVD PLAYER mode screen, touch the **[Option]** key.
2. Touch the **[CHAPTER REPEAT]** key, then touch the **[Back]** key.
The message "C.RPT" will be displayed.
3. Perform the same operation to turn off the repeat playback.

TOP function

The TOP function resets the DVD player to the first chapter of the track.

1. Press the **[BAND]** button to playback the first chapter (chapter No. 1).

Using the title menu

On DVD discs containing two or more titles, you can select from the title menu for playback.

1. Showing the DVD PLAYER mode screen, touch the **[Top Menu]** key during playback. The title menu screen appears.
 - Depending on the disc, the title menu cannot be called.
 - The same operation can be performed by pressing and holding the **[MENU]** button for more than 1 second.
2. Select the button items displayed in the title menu screen by the same way of the DVD menu operation.
 - Depending on the disc, items cannot be selected with the ten-key buttons.

Switching among languages

On discs in which two or more audios or audio languages have been recorded, you can switch among the audio languages during playback.

1. Showing the DVD PLAYER mode screen, touch the **[Option]** key.
2. Touch the **[Audio]** key during playback.
 - Each time you touch the key, you can switch among audio languages.
 - Depending on the disc, up to 8 audios may be recorded. For details, see the mark of the disc (Ⓢ): Indicates that 8 audios have been recorded).
 - When the power is turned on and when the disc is changed to a new one, the language set as the factory default is selected. If that language has not been recorded, the language specified on the disc.
 - Depending on the disc, switching may be completely impossible or impossible on some scenes.
 - It may take time to switch among audios.
3. Touch the **[Back]** key to return to the previous screen.

Switching subtitles

On DVD discs in which two or more subtitle languages have been recorded, you can switch among the subtitle languages during playback.

1. Showing the DVD PLAYER mode screen, touch the **[Option]** key.
2. Touch the **[Sub Title]** key during playback. Each time you touch the key, you can switch among subtitles.
 - Depending on the disc, up to 32 kinds of subtitles may be recorded. For details, see the mark of the disc (Ⓢ): Indicates that 8 kinds of subtitles have been recorded).
 - Depending on the disc, switching may be completely impossible or impossible on some scenes.
 - It may take time to switch among subtitles.
3. Touch the **[Back]** key to return to the previous screen.

To turn off subtitles

1. Repeat touching the **[Sub Title]** key until "Sub Title: OFF" is displayed on the screen. Subtitles are turned off.

Switching angles

On DVD discs in which video images have been recorded in two or more angles, you can switch among the angles during playback.

This operation can be performed when the “**Setting up the angle mark display**” function (see page 34) is set to “ON”.

1. Touch the [**ANGLE**] (Angle) key during playback. Each time you touch the key, you can switch among angles.
 - Depending on the disc, up to 9 angles may be recorded. For details, see the mark of the disc ( : Indicates multi-angle).
 - Depending on the disc, angles may switch smoothly or switch with a momentary still image.
 - When the power is turned on and when the disc is changed to a new one, the language set at the time of factory shipment is selected. If that language has not been recorded, the language specified on the disc.
 - Depending on the disc, switching may be completely impossible or impossible on some scenes.
 - It may take time to switch among angles.
 - Depending on the disc, scenes recorded in two or more angles may be played back.

Displaying the playback status

1. Showing the DVD PLAYER mode screen, touch the [**Option**] key.
2. Touch the [**P.Time**] key during playback.
3. Touch the [**Back**] key to return to the previous screen. Playback status is displayed on the screen.

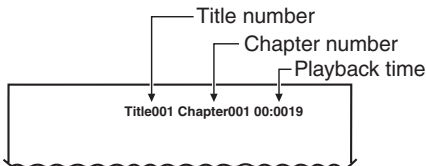

Watching a video CD

After disc loading, the play mode is automatically engaged.

- Button operation may differ depending on the story of the disc.

After the menu screen is displayed

For Video CD discs equipped with the PBC (Play Back Control) function, the menu screen appears. After the menu screen is displayed, select an item in the following operations and play it back.

Showing the V-CD menu (for Video CD discs with PBC)

* This key does not function on some discs.

1. Touch the screen to display the VIDEO CD mode screen, then touch the [**Menu**] key during playback. The Video CD menu appears. The displayed contents may differ, depending on the Video CD software.
 - Example showing menu display



2. To operate the Video CD menu items, press the [**CONT.**] button and use either the “**Cross-Key Pad**” or the “**Ten-Key Pad**” according to the disc contents menu.
 - You can also operate the Video CD menu by directly touching the menu items.

Pausing playback

1. Press the [**PAUSE**] button. Playback stops.
2. To resume playback, press the [**PAUSE**] button again. Playback resumes from the scene where playback is paused.

Slow playback

1. Press the **[▶/⏮]** button then press and hold the **[▶▶]** button.
While pressing the button, slow playback continues at the speed 1/3 times the normal playback.
 - Slow playback cannot be performed in the backward direction. In addition, audio cannot be reproduced during slow playback.

Skipping a track (searching)

1. Press the **[⏮]** or **[▶▶]** button during playback.
The track is skipped and playback starts.

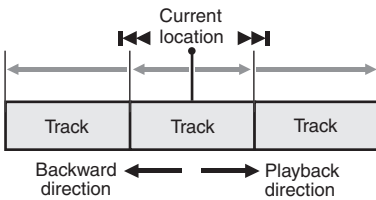

- Pressing the **[▶▶]** button starts playback from the beginning of the next track.
- Pressing the **[⏮]** button starts playback from the beginning of the current track. When this button is pressed again within about 2 seconds, playback starts from the beginning of the previous track.
- In the case of some discs furnished with PBC function, when PBC is set to "ON", this operation will cause the menu screen to be displayed.

Fast forward and fast backward

1. Press and hold the **[⏮]** or **[▶▶]** button during playback.
The playback speed becomes 5-time faster first and then 20-time faster 3 seconds later. Releasing the button resumes to the normal speed playback.
 - No audio is reproduced during fast forward and fast backward operation.
 - The unit may return to the menu screen when the button is pressed.

Searching with a track number

This operation allows searching with the track numbers recorded on the video CDs.

1. Touch the screen to display the VIDEO CD mode screen.
2. Touch the **[Search]** key.
3. Input the track number that you want to play back with **[0]** to **[9]** key.
4. Touch the **[ENT]** key.
Playback starts from the scene of the input track number.
 - If the input track number does not exist or searching with a track number is not allowed, the screen image will not change.
 - * If you are playing a disc with PBC and the PBC function is engaged, this operation may not be performed.
5. Touch the **[Back]** key.

Changing audio output

You can change the audio output method.

1. Touch the screen to display the VIDEO CD mode screen.
2. Touch the **[Audio]** key during playback.
Each time you touch the key, the audio output method is switched as follows:



Displaying the playback status

1. Touch the screen to display the VIDEO CD mode screen.
2. Touch the **[P.Time]** key during playback.
The screen will automatically return to the playback screen in about 7 seconds, and the playback status will be displayed on the playback screen.

DVD Video Player Operations

On/Off of Playback Control

On Video CDs equipped with Play Back Control function, you can turn it on/off.

* The factory default setting is "ON".

1. Touch the screen to display the VIDEO CD mode screen.
2. Each time you touch the [PBC] key, you can switch between on and off.
When the PBC is turned on or off, the disc plays from the beginning.

● Playback control (PBC)

This control signal is recorded on a Video CD for version 2.0 and used to control playback. Using pre-recorded menu screens in the Video CD with PBC, you can enjoy playback of software with a simplified dialog function or software with search function. You can also enjoy a still picture at high or standard resolution.

Listening to a CD

This unit is a CD TEXT compatible model, and supports the display of the DISC TITLE, TRACK TITLE and ARTIST of the CD TEXT.

After disc loading, the play mode is automatically engaged.

- When playback is not started, press the [▶/■] button or touch the [▶/■] key.

Note:

- *This unit supports only CD TEXT in English. Also, some character data may not be reproduced properly on the display.*

Pausing playback

1. Press the [▶/■] button or touch the [▶/■] key during playback.
Playback pauses.
2. To resume playback, press the [▶/■] button or touch the [▶/■] key.
Playback resumes.

Skipping a track (searching)

1. Press the [◀◀] or [▶▶] button during playback.
Tracks are skipped, as many as the times the button is pressed, and playback starts.
 - Pressing the [▶▶] button starts playback from the beginning of the next track.
 - Pressing the [◀◀] button starts playback from the beginning of the current track.
When this button is pressed again within about 2 seconds, playback starts from the beginning of the previous track.

TOP function

The TOP function resets the DVD player to the first track of the disc.

1. Press the [BAND] button to playback the first track (track No. 1).

Fast forward and fast backward

1. Press and hold the [◀◀] or [▶▶] button during playback.
The playback speed becomes 5-time faster first and then 20-time faster 3 seconds later.
Releasing the button resumes to the normal speed playback.

Searching with a track number

This operation allows searching using the track numbers recorded on the CDs.

1. Touch the [Search] key.
2. Input the track number that you want to playback with [0] to [9] key.
3. Touch the [ENT] key.
Playback starts from the track of the input track number.
 - If the input track number does not exist or searching with a track number is not allowed, the screen image will not change.
4. Touch the [Back] key.

Selecting a track on the Track List screen

This function allows you to select tracks from a displayed list.

1. Touch the **[List]** key.
The Track List screen is displayed.
2. When the desired track is not displayed, touch the **[<]** or **[>]** key to scroll the track list.
3. Touch the desired track title key.
The corresponding track is started playback.
4. Press the **[Back]** key to return to the previous screen.

Other various play functions

1. Touch the **[Option]** key.



2. Touch the touch key of the function you want to play.

[Track Scan] : track scan playback

This operation scans and plays back all tracks recorded on the disc, the first 10 seconds for each.

* **"T.SCN"** is displayed on the screen.

[Track Repeat] : track repeat playback

This operation plays back tracks recorded on the CD repeatedly.

* **"T.RPT"** is displayed on the screen.

[Track Random] : track random playback

This operation plays back all tracks on the disc in no particular order.

* **"T.RDM"** is displayed on the screen.

3. To cancel the play, touch the key of the function to cancel.
4. Touch the **[Back]** key to return to the previous screen.

Displaying CD titles

This unit can display title data for CD-text CDs.

1. Touch the **[Title]** key.
2. Touch the **[<<]** key of the Disc, Artist, or Track item to cause the respective display to scroll once.

Listening to an MP3/WMA

This unit is an ID3 Tag compatible model.

This unit supports the title, artist and album display of the ID3 Tag versions 1 and 1.1.

After disc loading, the play mode is automatically engaged.

What is MP3/WMA?

MP3 is an audio compression method and classified into audio layer 3 of MPEG standards.

WMA is an audio compression method developed by Microsoft Corporation.

These audio compression methods have penetrated into PC users and become a standard format.

These features compress the original audio data to about 10 percent of its initial size with a high sound quality. This means that about 10 music CDs can be recorded on a CD-R disc or CD-RW disc to allow a long listening time without having to change CDs.

Note:

- Some CDs recorded on CD-R/RW mode may not be usable.

Displaying MP3/WMA ID3-TAG titles

ID3 information such as title, artist and album title can be displayed for an MP3/WMA file containing ID3 Tag information.

DVD Video Player Operations

Precautions when creating an MP3 disc

● File extensions

1. Always add a file extension “.MP3” or “.mp3” to an MP3 file, and “.WMA” or “.wma” to a WMA file by using single byte letters. If you add a file extension other than specified or forget to add these file extension, the file cannot be played. In addition, if you use upper case and lower case letters (capital and small letters) mixedly for file extensions, normal play may not be possible.
2. Files other than MP3/WMA data cannot be played.

● Logical format (File system)

1. When writing an MP3/WMA file on a disc, please select “**ISO9660 level 1 or level 2 (without including expansion format)**” as the writing software format. Normal playback may not be possible if the disc is recorded on another format.
2. The folder name and filename can be displayed as the title during MP3/WMA play but the title must be within 31 single byte alphabetical letters and numerals for the folder name and file name (including an extension). Entering more letters or numerals than specified may cause an incorrect display.

● Folder structure

1. A disc with a folder having more than 8 hierarchical levels will conflict with the ISO9660 and playback will be impossible.

● Number of files or folders

1. The maximum allowable number of folders is 255 (including root directory); the maximum allowable number of files is 512 (max. 255 per folder). This represents the maximum number of tracks that can be played back.
2. Tracks are played in the order that they were recorded onto a disc. (Tracks might not always be played in the order displayed on the PC.)
 - Some noise may occur depending on the type of encoder software used while recording.

- In case of a track recorded at VBR (variable bit rate), the display for the play time of the track may be slightly different from the actual play time. Also, the recommended value of VBR ranges from 64 kbps to 320 kbps.
- Depending on the damage conditions of a file, it may occur that the file is not played and the next file is played instead. Also, if the damage is in a severe condition, play stops showing the “**ERROR 3**” display.
- After disc selection, the play mode is automatically engaged.

Note:

- If ID3 Tag information was entered with 2-byte characters, it may occur that the characters are not reproduced properly on the display.
- MP3/WMA files that the DRM (Digital Rights Management) function is set cannot be played.

Regarding MP3/WMA folder creation

Up to 8 folder levels (including the root directory) can be created for MP3/WMA files (items ① – in the illustration). However, on this unit, folders created above the third level will be converted to 2 levels.

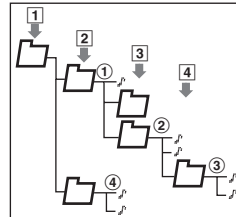

- Folders containing no MP3/WMA files are not recognized.
- Only folders containing tracks (① to ④ in illustration) are given numbers and displayed on the list.

Pausing playback

1. Press the [▶/⏏] button or touch the [▶/⏏] key during playback.
Playback pauses.
2. To resume playback, press the [▶/⏏] button or touch the [▶/⏏] key again.
Playback resumes.

Skipping a track (searching)

1. Press the [⏮] or [⏭] button during playback.
Tracks are skipped, as many as the times the button is pressed, and playback starts.
 - Press the [⏭] button starts playback from the beginning of the next track.
 - Press the [⏮] button starts playback from the beginning of the current track. When this button is pressed again within about 2 seconds, playback starts from the beginning of the previous track.
- * This operation skips the track over the folder.

Fast forward and fast backward

1. Press and hold the [⏮] or [⏭] button during playback.
The playback speed becomes 5-time faster first and then 20-time faster 3 seconds later. Releasing the button resumes to the normal speed playback.

Skipping the current folder

1. Press the [BAND] button during playback.
The tracks of the current folder are skipped and playback starts from the first track of the next folder.

Selecting a folder/track on the LIST screen

1. Touch the [List] key during playback.
Folder List screen is displayed.
2. When the desired folder is not displayed, touch the [⏴] or [⏵] key to scroll the list.
3. Touch the desired folder name key.
The Track List screen appears.
4. Touch the [⏴] or [⏵] key to scroll the list, and touch the desired track name key.
The corresponding track is started playback.
 - Touch the [◀] or [▶] key to display the Track List of the previous or next folder.
 - Touch the [Back] key to return to the Folder List screen.
5. Touch the [Back] key.

Playback by selecting a folder and track (Direct select mode)

This operation allows searching using the folder and track numbers recorded on the MP3/WMA disc.

1. Touch the [Search] key.
The Key Pad screen appears with the track number input mode.
Touching the [Folder] key turns the Key Pad to the folder number input mode.
2. Input the number for the track or folder that you want to play back with [0] to [9] key.
3. Touch the [ENT] key.
When you select the folder number, playback starts from track 1 of the input folder number.
4. Touch the [Back] key.

DVD Video Player Operations

Other various play functions

1. Touch the **[Option]** key.



2. Touch the touch key of the function you want to play.

[Track Scan] : track scan playback

This operation scans and plays back all tracks recorded on the disc, the first 10 seconds for each.

* **"T.SCN"** is displayed on the screen.

[Folder Scan] : folder scan playback

This operation plays back the first tracks of all folder on the MP3/WMA disc, the first 10 seconds for each.

* **"F.SCN"** is displayed on the screen.

[Track Repeat] : track repeat playback

This operation plays back the tracks currently being played back repeatedly.

* **"T.RPT"** is displayed on the screen.

[Folder Repeat] : folder repeat playback

This operation plays back tracks in an MP3/WMA folder repeatedly.

* **"F.RPT"** is displayed on the screen.

[Track Random] : track random playback

This operation plays the tracks in the folder in a random order.

* **"T.RDM"** is displayed on the screen.

[Folder Random] : folder random playback

This operation plays back tracks recorded on the disc in no particular order.

* **"F.RDM"** is displayed on the screen.

3. To cancel the play, touch the key of the function to cancel.
4. Touch the **[Back]** key to return to the previous screen.

Displaying CD titles

1. Touch the **[Title]** key.
2. Touch the **[<<]** key of the Folder, Track, Album, Artist or Title item to cause the respective display to scroll once.

Other Functions

Entering titles

Titles up to 10 characters long can be stored in memory and displayed for Radio stations, CD, TV stations, and CDs in the CD changer. The numbers of titles that can be entered for each mode are as follows.

Mode	Number of titles
TUNER mode	30 titles
CD mode	50 titles
TV mode	15 titles

CD changer mode	Number of titles
CDC655Tz connected	100 titles
DCZ625 connected	100 titles

* You cannot enter titles with the unit in Seek, Preset Scan, Auto store (TUNER or TV) mode. Cancel each of those operations before entering titles.

1. Press the **[SRC]** button to select the mode you want to enter a title (TUNER, CD, CD changer or TV).
2. Select and play a CD in the CD changer or a CD track or tune in to a Radio station or a TV station for which you want to enter the title.
3. Touch the screen (TV mode only).
4. Touch the **[List]** key to display the LIST screen.
To enter a CD title, touch the **[Title]** key.
5. Touch the **[Edit]** key.
The title input mode display appears.
6. Touch keys of the characters, symbols, etc. shown in the display to input titles.

“**+**” : Centering

“**Back Space**” : Backspace

“**□**” : Space

“**Memo**” : Memory

“**∨**” : Scroll

Note:

- Up to 10 characters can be input.
 - To switch the character types, touch the scroll key (∨) at the left of the screen.
7. Repeat the step 6 to enter the complete title.
 8. Touch and hold the **[Memo]** key for more than 2 seconds to store the title into memory. The display returns to the original mode screen.

Title list play

You can display a list of titles, then select the CD track, disc or broadcast station to listen to from that list.

* You cannot display a title list with the unit in Seek, Preset Scan, Auto store (Tuner or TV) mode. Cancel those operation modes before displaying a title list.

1. Touch the screen (TV mode only).
2. Touch the **[List]** key to display the LIST screen.

The following titles can be changed in a title list screen.

TUNER :

A title of a station stored for the presets 1 to 6 or frequency is displayed.

CD-changer :

DISC titles for discs 1 to 6 are displayed.

When there is not any disc in the changer, “**NO DISC**” is displayed.

TV :

A title of a channel stored for the presets 1 to 6 or a channel number is displayed.

3. Touch the desired title key (1 to 6) to select. The selected broadcast station or disc is played.
4. Touch the **[Back]** key to return to the previous screen.

Other Functions

Changing over monitor display size

* This function is available only when the panel is open.

Note:

- This function is not available while you are driving.
- Switch to the DVD PLAYER (DVD video or video CD)/VISUAL/DVD changer/TV mode you see.

1. Touch the screen to display the mode menu, then touch "**Display size**" key ([**F.WIDE**], etc.) at the top right of the screen.
The screen changes to the SCREEN MODE menu.

2. Touch the [**F.WIDE**], [**WIDE**], [**CINEMA**], or [**NORMAL**] key to select the desired monitor display size.

"**F. WIDE**" : (full wide mode)

The whole image elongates horizontally.

"**WIDE**" : (wide mode)

The image at right and left ends in a display elongates horizontally.

"**CINEMA**" : (cinema mode)

The image at both top and bottom in a display disappears.

"**NORMAL**" : (normal display)

There is a black area at both right and left ends of a display. In case of normal TV broadcasting (4:3), the image can be shown without being cut or deformed.

Note:

- When a 4:3 scale image (non-wide screen image) is displayed, part of the image may be out of view or the image may be distorted when in wide mode or full-wide mode. Please use normal mode for viewing such images with the proper aspect ratio.
- During superimposed display, it becomes a full-wide mode.

Internal amplifier cancel function

This function is used to disable the internal amplifier when an external amplifier is connected.

* The factory default setting is "**OFF**".

1. Press the [**ADJ**] button.
2. Touch the [**AUDIO EXT.**] key.
3. Touch the [**ON**] or [**OFF**] of the AMP CANCEL item to turn the internal amplifier on or off.
4. Touch the [**Back**] key to return to the previous screen.

Triggered audio mute for cellular telephones

This unit requires special wiring to mute the audio signal automatically when a cellular telephone rings in the car.

This function is not compatible with all cellular telephones. Contact your local authorized Clarion dealer for information on proper installation and compatibility.

iPod Operations

This unit can be used to control a connected Apple iPod (third generation version 2.2 or higher, iPod Mini, fourth generation, iPod nano, iPod with video).

Note:

- Note that iPod versions higher than those noted above may not be playable.
- The unit will not operate, or may operate improperly with unsupported versions.
- First and second generation iPod and iPod shuffle cannot be used.

Notes regarding use of Apple iPod

- When using an iPod, after connecting the iPod to the connector, select the iPod mode by pressing the [iPod] button, or touching the [iPod] key on the Source menu.
- After the iPod has been connected to this unit, the iPod's buttons are disabled for operation.
- When the iPod mode has been selected, a special iPod control screen is displayed different from the main screens for other modes.
- When the iPod mode has been selected, the screen image input from the VISUAL terminal is output to the rear monitor.
- The remote control unit cannot be used to perform scan, repeat or random play.
- This unit can display the Podcast titles*, Artist names, Album titles, Song titles, Genre names, Playlist titles, Composer names and Audio Book titles* registered on the iPod. When no data is present, the title display will remain blank.
- * Whether these functions are available or not depends on the iPod version.
- The iPod is used with the equalizer function turned OFF.

● Precautions regarding battery consumption:

When the iPod's internal battery becomes depleted, the recharge warning indicator will appear in the iPod's display. In this condition, the iPod cannot be played even if attached to the VRX766VD. Also, the VRX766VD's recharging function cannot be used to recharge the iPod. As a result, when the iPod's battery becomes depleted, use the dedicated charger provided with it to recharge the battery.

Controlling the iPod

● Selecting the iPod mode

1. Connect the iPod to the connector.
2. Press the [iPod] button.
The iPod mode can also be selected by touching the [iPod] key on the Source menu.

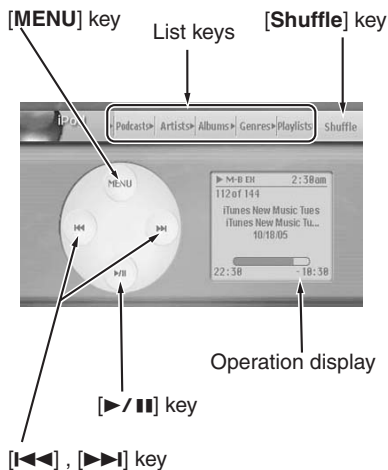

● iPod menu screen operation keys

[MENU] key

- Displays the Option menu screen.

List keys

- Displays the corresponding list screen. [Podcasts], [Artists], [Albums], [Genres] and [Playlists] are available from the iPod menu screen. [Audio Books], [Composers] and [Songs] are only available from the Option menu screen.

[Shuffle] key

- Use to switch the shuffle mode, in the order: → Song Shuffle → Album Shuffle → Shuffle OFF.
The default value is Shuffle OFF.
When enabled, this function performs playback of tracks in random order, regardless of the order in which they are recorded.

[▶/||] key

- Use to control playback and pause.

[◀◀], [▶▶] keys

- Use to perform track selection. Touch and hold to enable fast-forward or fast-backward.

iPod Operations

Note:

- The title display (*) shows, from top level down, the SONG title, ARTIST name, and ALBUM title. Press the operation display to scroll the SONG title.

● Operation display

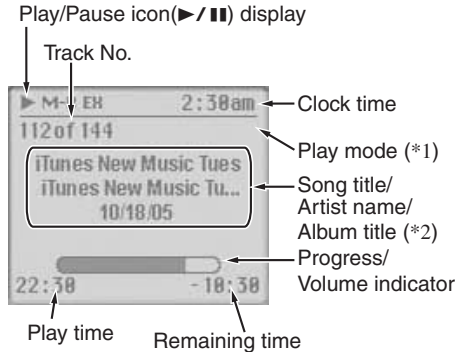

Note:

- *1 Displays status of Repeat, Shuffle play.
 - 1 ↻ : 1-track Repeat
 - A ↻ : All Repeat
 - S ↻ : Song Shuffle
 - A ↻ : Album Shuffle
- *2 When a Podcast or Audio Book which has two or more chapters is played back, the chapter title and chapter number are displayed.

● Option menu screen operation keys

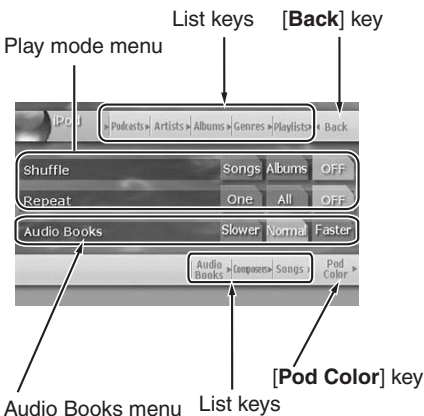

Play mode menu

- Uses to switch the shuffle mode and repeat mode.

List keys

- Displays the corresponding list screen. [Podcasts], [Artists], [Albums], [Genres], [Playlists], [Audio Books], [Composers] and [Songs] are available.

[Back] key

- Uses to return to the iPod menu screen.

Audio Books menu

- Uses to change the playback speed during playing Audio Books.

[Pod Color] key

- Changes the background color of the iPod menu screen.
 - [Pod Color]: changed to the color of the connected iPod.
 - [Normal Color]: changed to light blue.

Pausing playback

- Press the [▶/⏸] button or touch the [▶/⏸] key during playback. Playback pauses.
- To resume playback, press the [▶/⏸] button or touch the [▶/⏸] key again. Playback resumes.

Skipping a track (searching)

- Press the [⏮] or [⏭] button during playback. Tracks are skipped, as many as the times the button is pressed, and playback starts.
 - Pressing the [⏭] button starts playback from the beginning of the next track.
 - Pressing the [⏮] button starts playback from the beginning of the current track. When this button is pressed again within about 2 seconds, playback starts from the beginning of the previous track.

- * When a Podcast or Audio Book which has two or more chapters is played back, pressing the [⏮] or [⏭] button during pausing moves the current location to the beginning of the previous or next chapter.

Fast forward and fast backward

1. Press and hold the [◀◀] or [▶▶] button during playback.
The playback speed becomes 5-time faster first and then 20-time faster 3 seconds later. Releasing the button resumes to the normal speed playback.

TOP function

The TOP function resets the player to the first track of the tracks to play.

1. Press the [BAND] button to playback the first track of the current list.
 - * To playback all of the tracks in the Songs list from the first track, keep pressing the [BAND] button more than 1 second.

Selecting a list item from a list screen

1. Touch the desired List key from the iPod menu screen or the Option menu screen to display the corresponding list screen.
2. Touch a desired list item on the screen to display the corresponding list of tracks.
 - Use the [↕] and [↔] keys to scroll the list.
 - * Skip this operation for the Podcasts, Audio Books and Songs list.
3. Touch the desired track name on the list to playback.
 - Use the [↕] and [↔] keys to scroll the list.

Viewing video data in the iPod (only for the iPod with video features)

When you connect an iPod with video features by using the optional connector cable for iPod with video (released soon), you can enjoy the video data and slideshow data stored in the iPod showing them on the liquid crystal panel of this unit (and the rear monitor if connected).

Note:

- Do not connect the iPod to this unit when a Video Playlists item is selected on the iPod.
1. Touch and hold the [MENU] key on the iPod menu screen for more than 1 second. The screen will be changed to a black screen. In this condition, the iPod cannot be controlled from this unit. The iPod is turned into the normal operation mode, and you can control the iPod using the original controls of the iPod (iPod operation mode).
 2. Play back your desired video data or slideshow data from the iPod.
The specified image data will be displayed on the liquid crystal panel (and the rear monitor if connected).
 3. To return to the iPod menu screen, touch the screen.
 - * When you touch the screen during playing back image data, the playback is terminated and the first track of the first playlist will be played back.

Note:

- Image data may not be played back according to the status of the iPod.
- If you turn off the power of this unit or change the operation mode during the iPod operation mode, the iPod will be turned off. When it resumes to the iPod mode, the iPod will be turned on and resumed to the last playback mode.

VISUAL Operations

This function is available when a VTR, etc. is connected to the visual terminal.

⚠ WARNING

For your safety, the driver should not watch the VTR, etc. or operate the controls while driving. Please note that watching and operating the VTR, etc. while driving are prohibited by law in some countries.

Switching to the VISUAL mode

Note:

- For your safety, the VRX766VD has a safety function which turns off the picture when the car is moving, so only the audio can be heard. The picture can only be watched when the car is stopped and the parking brake is applied.
1. Press the [SRC] button, and touch the [VISUAL] key.

CD Changer Operations

Note:

- When an optional CD (DVD) changer is connected through the CeNET cable, this unit controls all CD (DVD) changer functions. This unit can control up to 2 changers (CD and/or DVD).

CD changer functions

Press the [SRC] button and touch the [CD CHANGER] key to change to the CD changer mode. Playback automatically starts.

- * If 2 CD changers are connected, the [CD CHANGER 1] and [CD CHANGER 2] keys will display in the Source menu.
- * If "NO MAGAZINE" appears in the display, insert the magazine into the CD changer. "DISC CHECKING" appears in the display while the player loads (checks) the magazine.
- * If "NO DISC" appears in the display, eject the magazine and insert discs into each slot. Then, reinsert the magazine back into the CD changer.

Pausing play

1. Press the [▶/||] button or touch the [▶/||] key during playback.
Playback pauses and "PAUSE" appears in the screen.
2. To resume playback, press the [▶/||] button or touch the [▶/||] key.
Playback resumes.

Changing the audio input level

The visual terminal can be used to change the input audio level.

* The factory default setting is "HIGH".

1. Touch the screen to display the menu, then repeat touching the [SENS] key to select the level.
HIGH: 16.25 dB
MID: 3.75 dB
LOW: 0 dB

Displaying the CD TEXT titles

This operation is only possible when this unit is connected with a CD TEXT compatible CD changer.

1. Touch the [Title] key.
2. Touch the [◀◀] key of the Disc, Artist, or Track item to cause the respective display to scroll once.

Selecting a CD and track from the list

1. Touch the [List] key.
2. Touch the corresponding Disc key (1 to 6) to select the desired disc.
The Track List screen appears.
* When the touching and holding a Disc key for more than 1 second, the title will scroll.
3. When the desired track is not displayed, touch the [⤴] or [⤵] key to scroll the track list.
4. Touch the desired Track key.
The corresponding track is started playback.
* When the touching and holding a Track key for more than 1 second, the title will scroll.
5. Touch the [Back] key to return to the Disc List screen.
Touch the [Back] key again to return to the CD CHANGER mode screen.

Switching to a next disc. (Disc Up function)

The disc up function plays from the first track (track No.1) of the next disc.

1. Press the **[BAND]** button.
The disc changes to the next disc.

Searching with a track number

* This function is available only for the current disc.

1. Touch the **[Search]** key.
2. Input the track number that you want to play back with **[0]** to **[9]** key.
3. Touch the **[ENT]** key.
Playback starts from the track of the input track number.
 - If the input track number does not exist or searching with a track number is not allowed, the screen image will not change.
4. Touch the **[Back]** key.

Skipping a track (searching)

* This function is available only for the current disc.

1. Press the **[◀◀]** or **[▶▶]** button during playback.
Tracks are skipped, as many as the times the button is pressed, and playback starts.
 - Pressing the **[▶▶]** button starts playback from the beginning of the next track.
 - Pressing the **[◀◀]** button starts playback from the beginning of the current track.
When this button is pressed again within about 2 seconds, playback starts from the beginning of the previous track.

Fast forward and fast backward

1. Press and hold the **[◀◀]** or **[▶▶]** button during playback.
The playback speed becomes 5-time faster first and then 20-time faster 3 seconds later. Releasing the button resumes to the normal speed playback.

Other various play functions

1. Touch the **[Option]** key.



2. Touch the touch key of the function you want to play.
 - [Track Scan]** : (track scan playback)
This scan play locates and plays the first 10 seconds of each track on a disc automatically.
 - [Disc Scan]** : (disc scan playback)
This scan play locates and plays the first 10 seconds of the first track on each disc in the currently selected CD changer.
 - [Track Repeat]** : (track repeat playback)
The repeat play continuously plays the current track.
 - [Disc Repeat]** : (disc repeat playback)
After all tracks in the current disc have been played, the disc repeat play automatically replays the current disc over from the first track.
 - [Track Random]** : (track random playback)
The random play selects and plays individual tracks on the disc in no particular order.
 - [Disc Random]** : (disc random playback)
The disc random play selects and plays individual tracks or discs automatically in no particular order.
3. To cancel the play, touch the key of the function to cancel.
4. Touch the **[Back]** key to return to the previous screen.

DVD Changer Operations

Only basic operations of DVD changer can be performed from the unit. Use the remote control unit to perform the following functions.

- Scan, Repeat, Random functions
- Video CD Playback function ON/OFF
- DVD Setup function, Audio, Subtitle, Angle setting function

For details on operations other than those described below, see the pages of "DVD Video Player Operations".

For details on DVD changer precautions, refer to the supplied owner's manual.

Note:

- When the DVD changer (VCZ625) is connected via optical cable, no sound will be output if AUDIO OUT is switched to ANALOG on the changer's "GENERAL SETUP" menu.
- Set the "TV TYPE" of the DVD changer's "GENERAL SETUP" menu to the same setting as that set in the "Switching the VTR system between NTSC and PAL" of this unit.

TV Operations

TV functions

To watch TV, requires a TV tuner. When an optional TV tuner is connected through the CeNET cable, this unit controls all TV tuner functions.

⚠ WARNING

For your safety, the driver should not watch the TV or operate the controls while driving. Please note that watching and operating the TV while driving are prohibited by law in some countries.

Watching TV

Note:

- For your safety, the VRX766VD has a safety function which turns off the picture when the car is moving, so only the audio can be heard. The picture can only be watched when the car is stopped and the parking brake is applied.
1. Press the [SRC] button, and touch the [TV/VTR] key.
 2. Press the [BAND] button or touch the [Band] key to select the desired TV band (TV1 or TV2).
Every pressing the button toggles the TV band between TV1 and TV2.
 3. Press the [◀◀] or [▶▶] button to tune in the previous or next preset TV station.

Selecting a disc from the list

1. Touch the [List] key.
2. Touch the corresponding Disc key (1 to 6) to select the desired disc.
The disc changes to the specified disc.

Switching to a next disc (Disc Up function)

1. The disc up function plays from the first track (track No.1) of the next disc.
Press the [BAND] button.
Each time you press the [BAND] button, the disc changes to the next disc.

Watching a video

The TV tuner has a VTR input terminal to which 1 external device can be connected. Connect a 12V video cassette player (VCP) or video cassette recorder (VCR) to the TV tuner input terminal.

1. Touch the screen to display the TV/VTR mode menu, then touch the [Option] key.
2. Touch the [VTR] key to change to the VTR mode.
 - To return to the TV broadcast, perform the same operation again.

Note:

- When the 2-ZONE function is turned on, the VTR mode cannot be specified for both of the MAIN and SUB zones simultaneously.

Seek tuning

1. Press the [BAND] button or touch the [Band] key to select the desired TV band (TV1 or TV2).
 - * If "MANU" is displayed in the display, press and hold the [BAND] button for more than 1 second. "MANU" in the display goes off.
2. Touch the [◀◀] or [▶▶] key to automatically seek a station.
 - Touching the [▶▶] key to tune up the channel to the next available TV station, and the [◀◀] key to tune down.

Selecting with a channel number

1. Touch the screen to display the TV/VTR mode menu, then touch the [**Search**] key.
2. Enter the channel number corresponding with the station you desired by touching the [0] to [9] key.
 - If you touch the wrong number ([0] to [9] key), you can delete it to touch the [**CLR**] key.
3. Touch [**ENT**] key. The TV station you required would be tuned.
4. Touch the [**Back**] key.

Manual tuning

There are 2 ways available: Quick tuning and step tuning. When you are in the step tuning mode, the channel changes one step at a time. In quick tuning mode, you can quickly tune the desired frequency.

1. Press the [**BAND**] button or touch the [**Band**] key to select the desired band. (TV1 or TV2)
 - * If "**MANU**" is not displayed in the display, keep pressing the [**BAND**] button more than 1 second. "**MANU**" appears and manual tuning is now available.
2. Tune into a station.

Quick tuning:

Touch and hold the [<<] or [>>] key for more than 1 second to tune in a station.

Step tuning:

Touch the [<<] or [>>] key to manually tune in a station.

Note:

- Manual tuning is cancelled if you do not operate the unit for 7 seconds.

Recalling a preset station

A total of 12 TV stations can be stored (6-TV1 and 6-TV2).

There are 2 ways available to recall the preset station.

● Using the [◀◀] or [▶▶] button

1. Press the [**BAND**] button or touch the [**Band**] key to select the desired TV band. (TV1 or TV2)
2. Press the [◀◀] or [▶▶] button to recall a stored TV station.

● Using the Preset List screen

1. Touch the screen to display the menu, then touch the [**List**] key.
2. Touch the corresponding Preset key to recall the stored station.
 - * You can select the desired band by touching the [**Band**] key.
 - * Touching and holding the desired Preset key for more than 2 seconds will store the current station into the preset memory.
3. Touch the [**List**] key again to return to the previous screen.

Manual memory

1. Touch the [**Band**] key to select the desired TV band. (TV1 or TV2)
2. Tune in the desired TV station to be stored.
3. Touch the [**List**] key.
4. Touch and hold one of the Preset key for more than 2 seconds to store the current station into the preset memory.

TV Operations

Auto store

Auto store selects 6 TV stations automatically and stores each one into a preset memory. If 6 stations cannot be received with good reception, previously stored station remain and only the strong stations are stored into memory.

1. Touch the **[Band]** key to select the desired TV band. (TV1 or TV2)
2. Touch the **[List]** key.
3. Touch and hold the **[AS]** key for more than 2 seconds.
A beep sounds and the stations with good reception are stored automatically to the preset channels.

Preset scan

Preset scan shows each preset channel before it automatically advances to the next preset. This function is useful for searching for desired TV station in memory.

1. Touch the screen to display the TV/VTR menu, then touch **[List]** key.
2. Touch the **[PS]** key to start preset scan. The unit starts scanning each station for 7 seconds sequentially.
3. When the desired channel is received, touch the **[PS]** key again.

Setting the TV diver

You can change the reception setting for the TV antenna connected to the TV tuner.

* Normally use the TV diver with the "ON" position.

1. Touch the screen to display the TV/VTR menu, then touch **[Option]** key.
2. Touch the **[ON]** or **[OFF]** key of the TV DIVER item to turn this function on and off.
[ON] :
Sets reception emphasizing the visual.
[OFF] :
Sets the diver setting to OFF.
3. Touch the **[Back]** key to return to the previous mode.

Setting the TV area

When you select the TV area (TV reception area), the TV tuner area setting changes.

1. Touch the screen to display the menu, then touch the **[Option]** key.
2. Touch the **[TV AREA]** key to display a list of country name.
3. Touch the **[▲]** or **[▼]** key to scroll the list.
4. Touch the desired Country Name key to select a country.
5. Touch the **[Back]** key to return the previous mode.

5.1 ch Surround Decoder Operations

This function is available when an optional 5.1 ch Surround Decoder (DVH940) is connected. When the 5.1 ch Surround Decoder is connected through the CeNET cable, the 5.1 ch Surround Decoder Control unit (DVC940, optional) cannot be used.

5.1 ch Surround Decoder control function

This section describes operation procedures of setting functions.

For details on each functions, refer to the owner's manual supplied with the 5.1 ch Surround Decoder.

* Requires an optional amplifier.

Note:

- The 2-ZONE mode is disabled when the DVH940 is connected.

1. Press the **[ADJ]** button to display the ADJUST menu.

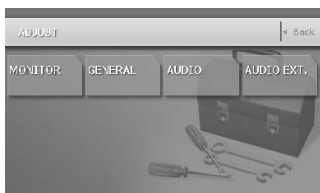

2. Touch the **[AUDIO EXT.]** key.

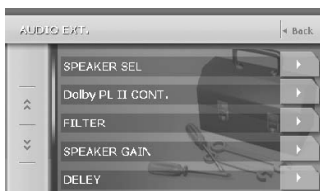

3. Perform setting for the desired item. See the following sections for details.
4. Touch the **[Back]** key to return to the previous screen.

* In the following sections, only the details regarding settings are described, procedures to select setting items are skipped.

●SPEAKER SEL (speaker selection)

This function determines center speaker, surround speaker and sub woofer connection.

- 3-1. Touch the **[▶]** key of the SPEAKER SEL item to show the submenu.
- 3-2. Touch the **[ON]** or **[OFF]** key of the CENTER SP, SURROUND SP or SUB WOOFER item to turn speakers on or off, depending on what speakers are connected.
 - The factory default setting is "ON"
 - The phase of the "SUB WOOFER" is reversed in the "ON-" setting. The default value is "ON+".

●Dolby PL II CONTROL

* This function is available only when the MUSIC MODE is selected for Dolby PL II. For setup details, see "Selecting the Dolby PL II (Dolby Pro Logic II) type".

- 3-1. Touch the **[▶]** key of the Dolby PL II CONT. item to show the submenu.
- 3-2. Perform setting for the PANORAMA, DIMENSION or CENTER WIDTH item.

[PANORAMA]:

Touch the **[ON]** or **[OFF]** key to select. "OFF" is the default value.

[DIMENSION]:

Touch the **[◀]** or **[▶]** key to adjust the level between 0 and 6. The default level is "3".

[CENTER WIDTH]:

Touch the **[◀]** or **[▶]** key to adjust the level between 0 and 7. The default level is "3".

5.1 ch Surround Decoder Operations

● FILTER

This function is used to select filter frequencies that suit the speakers that are used.

* This function is not available for speakers whose SPEAKER SEL setting is set to "OFF".

- 3-1. Touch the [▶] key of the FILTER item to show the submenu.
- 3-2. Touch the [◀] or [▶] key of the FRONT HPF, CENTER HPF, SURROUND HPF or SUB WOOFER LPF item to adjust.

[FRONT HPF]:

This function can be set to the following four settings: 50 Hz, 80 Hz, 120 Hz or THRGH (through). "THRGH" is the default value.

[CENTER HPF]:

This function can be set to the following three settings: 50 Hz, 80 Hz and 120 Hz. "120 Hz" is the default value.

[SURROUND HPF]:

This function can be set to the following four settings: 50 Hz, 80 Hz, 120 Hz or THRGH (through). "THRGH" is the default value.

[SUB WOOFER LPF]:

This function can be set to the following three settings: 50 Hz, 80 Hz and 120 Hz. "120 Hz" is the default value.

● SPEAKER GAIN

This function sets speaker output level.

* This function is not available for speakers whose SPEAKER SEL setting is set to "OFF".

- 3-1. Touch the [▶] key of the SPEAKER GAIN item to show the submenu.
- 3-2. Touch the [◀] or [▶] key of the FRONT L, CENTER, FRONT R, SURROUND R, SURROUND L or SUB WOOFER item to adjust.
Each item is adjustable in the range -10 dB to +10 dB in 1 dB step increments. The default value is "0 dB".

● DELAY

This function adjusts the timing of the speakers so that they are synchronized with front speaker output.

* This function is not available for speakers whose SPEAKER SEL setting is set to "OFF".

- 3-1. Touch the [▶] key of the DELAY item to show the submenu.
- 3-2. Touch the [◀] or [▶] key of the CENTER SP or SURROUND SP item to adjust.

[CENTER SP]:

Adjustments are made in the range from 0 ms to 5 ms. The default value is "0 ms".

[SURROUND SP]:

Adjustments are made in the range from 0 ms to 15 ms. The default value is "0 ms".

● DRC

This function sets the dynamic range compression.

- 3-1. Touch the [↕] key to display the next menu screen.
- 3-2. Touch the [MAX], [STD] or [MIN] key of the DRC item to select respective item.
* The default value is "MAX".

5.1 ch Surround Decoder Operations

DSF mode

DSF effect ON/OFF

* The factory default setting is "OFF".

1. Press the [ADJ] button, and touch the [AUDIO] key.



2. Touch the [▶] key of the STATUS item.
3. Touch the [ON] or [OFF] key of the DSF item to set the function ON or OFF.
4. Touch the [Back] key to return to the previous screen.

Note:

- If the DSF effect is set to OFF, the adjustment made in "DSF" is not reflected in the music source.

Selecting the DSF type

1. Press the [ADJ] button, and touch the [AUDIO] key.
2. Touch the [▶] key of the DSF item.
3. Touch the key for the desirable type to select.
4. Touch the [Back] key to return to the previous screen.

P.EQ mode

P.EQ effect ON/OFF

* The factory default setting is "OFF".

1. Press the [ADJ] button, and touch the [AUDIO] key.
2. Touch the [▶] key of the STATUS item.
3. Touch the [ON] or [OFF] key of the P.EQ item to set the function ON or OFF.
4. Touch the [Back] key to return to the previous screen.

Note:

- If the P.EQ effect is set to OFF, the adjustment made in "P.EQ" is not reflected in the music source.

Setting and storing P.EQ Properties

1. Press the [ADJ] button, and touch the [AUDIO] key.
2. Touch the [▶] key of the P.EQ item to display the submenu.
3. Touch the key for the desirable type to select. The P.EQ adjustment contents are as follows:
 - [SIGNAL]: This function selects "MUSIC" or "P. NOISE".
 - * The factory default setting is "P.NOISE".

[SPEAKER SELECT]:

This function selects "FRONT", "CENTER" or "SURROUND".

- * The factory default setting is "FRONT".

- * This setting is disabled when both the CENTER SP and SURROUND SP items of the SPEAKER SEL setting are set to "OFF".

- * This function is not available for speakers whose SPEAKER SEL setting is set to "OFF".

[BAND]:

Select the channel to be compensated ("BAND1", "BAND2", "BAND3").

- * The factory default setting is "BAND1".

[FREQUENCY]:

Select the center frequency that you want to compensate from the range of 18 Hz to 20 kHz. (1/3 octave step, 31 points)

- * The factory default setting is "1 kHz".

[Q]:

Set the sharpness of the Q-curve to one of the parameters: 1, 3, 5, 7 and 20.

- * The factory default setting is "1".

[GAIN]:

Adjust the gain (output level) in the range of -6 dB to +6 dB. (1 dB step, 13 points)

- * The factory default setting is "0".

4. Touch the [Back] key to return to the previous screen.

5.1 ch Surround Decoder Operations

Selecting the Dolby PL II (Dolby Pro Logic II) type

* The factory default setting is "OFF".

* This setting is disabled when both the CENTER SP and SURROUND SP items of the SPEAKER SEL setting are set to "OFF".

1. Press the [ADJ] button, and touch the [AUDIO] key.
2. Touch the [▶] key of the Dolby PL II item.
3. Touch the key for the desirable type to select.
4. Touch the [Back] key to return to the previous screen.

Output adjustment of subwoofer volume, center volume and balance/fader

1. Press the [ADJ] button, and touch the [AUDIO] key.
2. Touch the [▶] key of the DETAIL item to display the submenu.
3. Perform the following adjustments:

● Subwoofer volume adjustment

- 3-1. Touch the [◀] or [▶] key of the SUBWOOFER VOL item to adjust to desirable level (Setting range : -6 to 3).
 - * The factory default setting is "0".

● Center volume adjustment

- 3-1. Touch the [◀] or [▶] key of the CENTER VOL item to adjust to desirable level (Setting range : -6 to 0).
 - * The factory default is "0".

● Balance/Fader adjustment

- 3-1. Touch the [▶] key of the BAL/FAD item. Touch the [▲] or [▼] key to adjust the fader level.
 - [▲] key : emphasized the sound from the front speakers.
 - [▼] key : emphasized the sound from the rear speakers.
- 3-2. Touch the [◀] or [▶] key to adjust the balance level.
 - [◀] key : emphasized the sound from the left speakers.
 - [▶] key : emphasized the sound from the right speakers.
4. Touch the [Back] key to return to the previous screen.

12. IN CASE OF DIFFICULTY

GENERAL

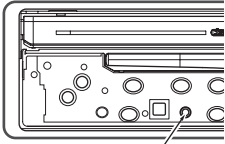
Problem	Cause	Measure
Power does not turn on. (No sound is produced.)	Fuse is blown.	Replace with a fuse of the same amperage. If the fuse blows again, consult your store of purchase.
	Incorrect wiring.	Consult your store of purchase.
Nothing happens when buttons are pressed. Display is not accurate.	The microprocessor has malfunctioned due to noise, etc.	Turn off the power and remove the DCP. Press the reset button for about 2 seconds with a thin rod. Note: When the Reset button is pressed, turn off the ACC power.  The Reset button—
The remote control does not work.	Direct rays of the sun fall on the light-receptive part of the remote control.	When direct rays of the sun fall on the light-receptive part of the remote control, it may not work.
	The batteries of the remote control are dead or there is no battery in the remote control.	Check the batteries of the remote control.

DVD Player

Problem	Cause	Measure
Disc cannot be loaded.	Another disc is already loaded.	Eject the disc before loading the new one.
	There is a foreign matter already in place.	Eject the foreign matter forcibly.
Sound skips or is noisy.	Compact disc is dirty.	Clean the compact disc with a soft cloth.
	Compact disc is heavily scratched or warped.	Replace with a compact disc with no scratches.
Sound is bad directly after power is turned on.	Water droplets may form on the internal lens when the car is parked in a humid place.	Let dry for about 1 hour with the power on.
The image is not displayed.	The parking brake is not engaged.	Check that the parking brake is engaged.
Disc cannot play with the display "PARENTAL VIOLATION" shown.	The view is limited.	Release the view limitation or change the parental level. See the subsection "Setting up the parental level".

TV/VTR(When connecting an optional TV tuner, etc.)

Problem	Cause	Measure
The image is not displayed.	The parking brake is not engaged.	Check that the parking brake is engaged.
The display is dark.	The brightness control is too low.	Adjust the brightness properly.
	The operating condition is not good.	The temperature inside the vehicle may be 0°C or lower. Set to an appropriate temperature (25°C or so) and check it again.
	The headlight of the vehicle is lit.	The display is made dark at night to prevent the glare (When the headlight of the vehicle is lit in the daytime, the display gets dark).
The color of the display is light or a shade of color is not good.	The color is not adjusted adequately.	Check that Color and Hue are adjusted properly.
When the VTR is connected, the image is disturbed.	Improper NTSC/PAL setting	Set the NTSC/PAL properly according to the VTR.
When the TV tuner is connected, the image gets unclear.	Bad receiving condition	A radio wave may not reach sufficiently due to obstruction of mountains or buildings. Check it again at a place where a radio wave can be received properly.
The TV tuner has a double or triple image.	Bad receiving condition	It may be under the influence of radio wave reflected by mountains or buildings. Check it again after changing place or direction.
The TV tuner has spots or stripes in the image.	Presence of jamming	It may be under the influence from automobiles, streetcar, power cable, neon sign, and so forth. Check it again after changing place.
There are red, green, and blue points in the display.	_____	This is not a failure, but a phenomenon peculiar to a liquid crystal panel (The liquid crystal panel is produced according to technology with very high precision. Note that, though there are effective pixels of 99.99% or more, pixel missing or normally lit pixels account for 0.01%).

13. ERROR DISPLAYS

If an error occurs, one of the following displays is displayed.
Take the measures described below to solve the problem.

DVD PLAYER

Display	Cause	Measure
ERROR 2	A CD is caught inside the CD deck and is not ejected.	This is a failure of CD deck's mechanism and consult your store of purchase.
ERROR 3	A CD cannot be played due to scratches, etc.	Replace with a non-scratched, non-warped disc.
ERROR 6	A CD is loaded upside-down inside the CD deck and does not play.	Eject the disc then reload it properly.

CD CHANGER

Display	Cause	Measure
ERROR 2	A CD inside the CD changer is not loaded.	This is a failure of CD changer's mechanism and consult your store of purchase.
ERROR 3	A CD inside the CD changer cannot be played due to scratches, etc.	Replace with a non-scratched, nonwarped disc.
ERROR 6	A CD inside the CD changer cannot be played because it is loaded upside-down.	Eject the disc then reload it properly.

For the DVD changer, refer to the Owner's Manual provided with the DVD changer.

If an error display other than the ones described above appears, press the Reset button. If the problem persists, turn off the power and consult your store of purchase.

* When the reset button is pressed, frequencies of TV/radio stations, titles, etc. stored in memory are cleared.

14. SPECIFICATIONS

FM Tuner

Frequency Range: 87.00 MHz to 108.00 MHz
 Usable Sensitivity: 9 dBf
 50dB Quieting Sensitivity: 15 dBf
 Alternate Channel Selectivity: 70 dB
 Stereo Separation (1 kHz): 35 dB
 Frequency Response (± 3 dB): 30 Hz to 15 kHz

AM Tuner

Frequency Range: 531 kHz to 1629 kHz
 Usable Sensitivity: 28 dB μ V

DVD Player

System:
 Digital Versatile Disc System with CDDA capable
 Usable discs: DVD video disc, Compact disc
 Frequency Response:
 20 Hz to 20 kHz (CD) (± 1 dB)
 Signal to Noise Ratio: 100 dB (1 kHz)
 Dynamic Range: 100 dB (1 kHz)
 Distortion: 0.01%

Audio Amplifier

Maximum power output:
 200 W (50 W \times 4)
 Rate Power Output:
 14 W \times 4 (20 Hz to 20 kHz, 1%, 4 Ω)
 Speaker impedance: 4 Ω (4 to 8 Ω)

Input

Audio input:
 130 ± 60 mVrms (High)
 600 ± 80 mVrms (Mid)
 840 ± 100 mVrms (Low)
 (input impedance 10 k Ω or greater)
 Video input:
 1.0 ± 0.2 Vp-p (input impedance 75 Ω)

Video Output

Video output:
 1.0 ± 0.2 Vp-p (output impedance 75 Ω)

LCD Monitor

Screen Size: 7-inch wide type
 152 mm Width \times 85 mm Height
 Display method:
 Transmission type TN liquid crystal display
 Drive method: TFT (thin-film transistor)
 active matrix driving
 Pixels: 336,960 (1440 \times 234)

General

Power source voltage:
 14.4 V DC (10.8 to 15.6 V allowable)
 Ground: Negative
 Current consumption: 4.0 A (1 W)
 Auto Antenna Rated Current: 500 mA less
 Dimensions of the Main Unit:
 178 mm Width \times 50 mm Height \times 165 mm
 Depth
 Weight of the Main Unit: 2.4 kg
 Dimensions of the Remote Control Unit:
 54 mm Width \times 28.8 mm Height \times 155 mm
 Depth
 Weight of the Remote Control Unit:
 100 g (including battery)

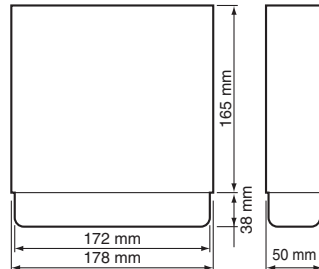

Note:

- Specifications comply with JEITA Standards.
- Specifications and design are subject to change without notice for further improvement.

INSTALLATION AND WIRE CONNECTION MANUAL

1. BEFORE STARTING

1. This set is exclusively for use in cars with a negative ground 12 V power supply.
2. Read these instructions carefully.
3. Be sure to disconnect the battery “-” terminal before starting. This is to prevent short circuits during installation. (Figure 1)

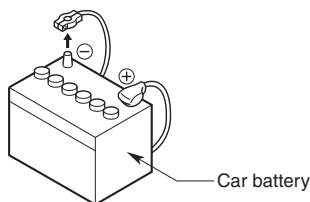

Figure 1

2. PACKAGE CONTENTS

① Main unit	
② Manuals	
Owner's manual & Installation manual	
Warranty card	
③ Power supply lead	
④ Rca pin cord	
⑤ Bag for accessories (No. 1)	
Flat head screw (M5 × 8)	4
Sems hexagonal bolt (M5 × 8)	5
Electro tap	
Machine screw (M4 × 3)	4
⑥ Bag for accessories (No. 2)	
Hook plate	2
Cord clamp	
⑦ Bag for accessories (NO. 3)	
Rca cap	12
⑧ Universal mounting bracket	
⑨ Remote control unit	
⑩ Battery	
(for remote control unit)	
⑪ Outer Escutcheon	
⑫ DCP Case	

3. GENERAL CAUTIONS

1. Do not open the case. There are no user-serviceable parts inside. If you drop anything into the unit during installation, consult your dealer or an authorized Clarion service center.
2. Use a soft, dry cloth to clean the case. Never use a rough cloth, thinner, benzine, or alcohol, etc. For tough dirt, apply a little cold or warm water to a soft cloth and wipe off the dirt gently.

4. CAUTIONS ON INSTALLATION

1. Prepare all articles necessary for installing the main unit before starting.
2. This model features a liquid crystal panel that slides forward (shell loading system). On some types of cars, the liquid crystal panel may make contact with the dashboard or shift lever, in which cause it cannot be installed. Before installing, check that the unit will not hamper operation of the shift lever or obstruct your view before selecting the installation location. (Figure 2)

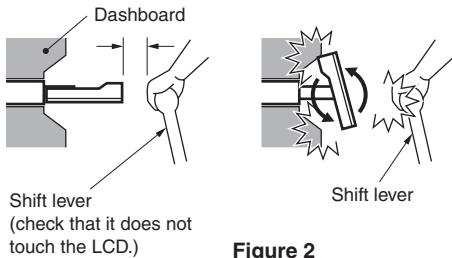

Figure 2

3. Install the unit within 30° of the horizontal plane. (Figure 3)

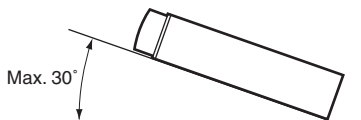

Figure 3

4. If you have to do any modification on the car body, such as drilling holes, consult your car dealer beforehand.

5. Use the included screws for installation. Using other screws can cause damage. (Figure 4)

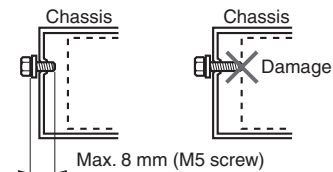

Figure 4

6. The source unit has mounting screw holes for NISSAN (N marks) and TOYOTA (T marks) vehicles.

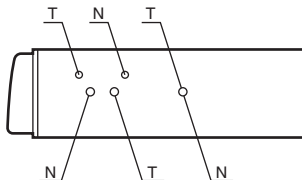

Figure 5

5. INSTALLING THE MAIN UNIT

Universal Mount

1. Place the universal mounting bracket into the instrument panel, use a screwdriver to bend each stopper of the universal mounting bracket inward, then secure the stopper as shown in Figure 6.
2. Wire as shown in Section 8.
3. Insert the main unit into the universal mounting bracket until it locks.
4. Mount the outer escutcheon so that all the hooks are locked.

Note:

- *1 Some car models require special mounting kits for proper installation. Consult your Clarion dealer for details.
- *2 Fasten the front stopper securely to prevent the main unit from coming loose.

• Console opening dimensions

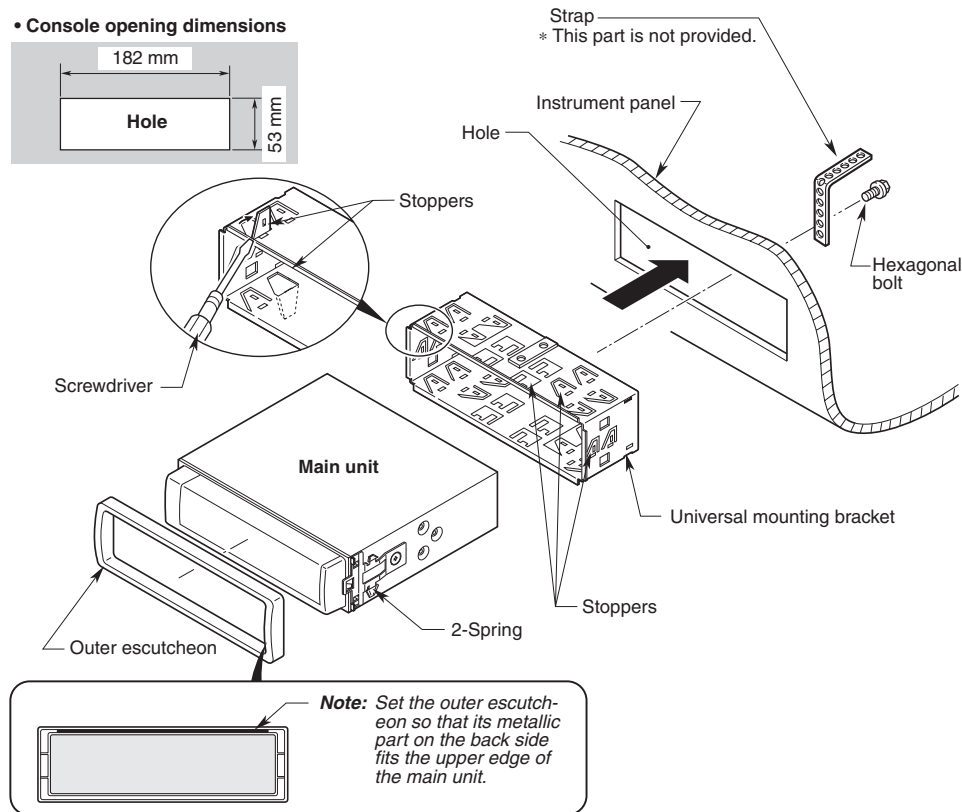
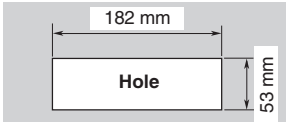

Figure 6

Fixed Mount (TOYOTA, NISSAN and other ISO/DIN equipped vehicles)

This unit is designed for fixed installation in the dashboard.

If the vehicle is equipped with a factory-installed radio, install the main unit with the parts and screws marked (*). (Figure 8)

If the vehicle is not equipped with a factory-installed radio, obtain an installation kit to install the main unit in the following procedure.

1. Remove the screws from both side of the main unit. Then, at either side, lift the leaf spring until the engaging claws are released from the holes, and slide the spring to the direction of arrow to remove it. Repeat the same for the other side to remove the springs from the both sides. (Figure 7)

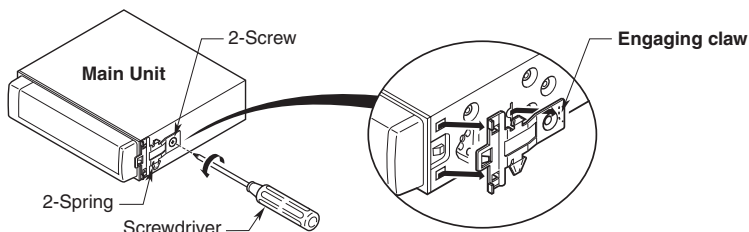
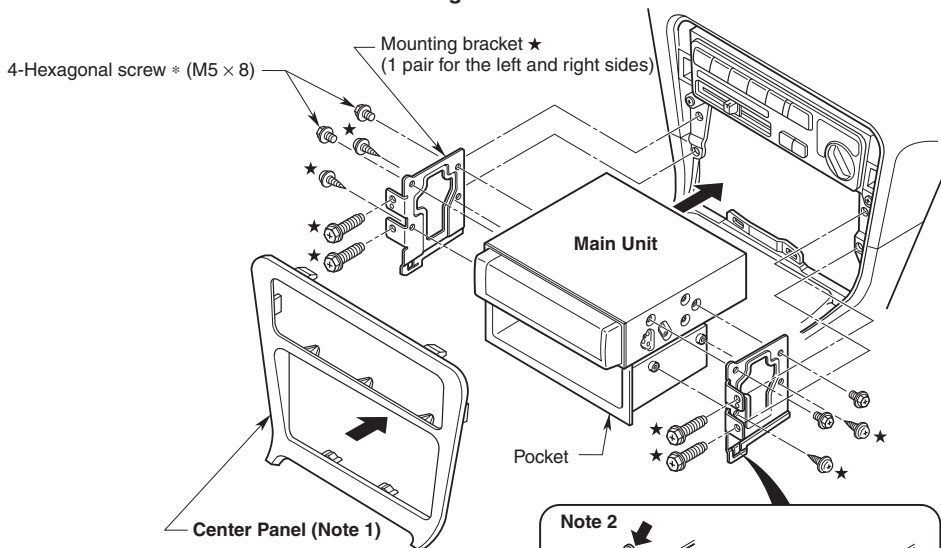

Figure 7



*: The screws with this mark are enclosed in this set.

★: The parts and screws with this mark are used to install radio or included in the installation kit.

Note 2

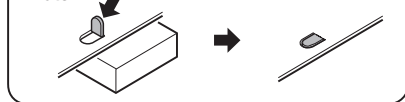

Figure 8

Note 1: In some cases, the center panel may require some modification (trimming, filling, etc.).

Note 2: If the hook on the installation bracket interferes with the unit, bend and flatten it with a nipper or a similar tool.

6. REMOVING THE MAIN UNIT

1. When the rear of the main unit has been secured with the method shown in Figure 6 unfasten the special screw.
2. Remove the outer escutcheon.
3. Insert the hook plate between the spring and the universal mounting bracket, fit tab (B) of the spring into hole (A) of the hook plate, then pull the main unit out by the hook plate. (Insert both the right and left edges of the hook plate.) (Figure 9)

Note:

- Keep the hook plate. You cannot remove the main unit without disengaging the hook plate.

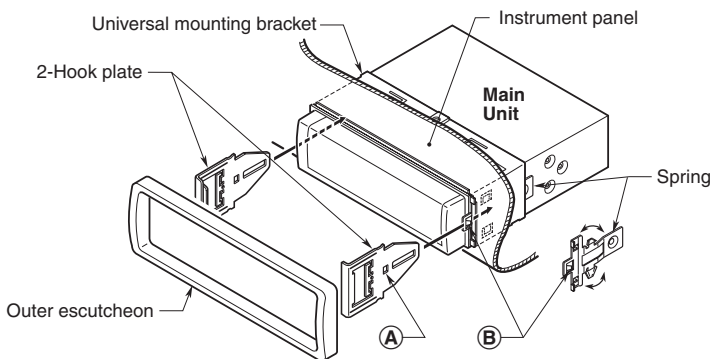

Figure 9

7. CAUTIONS ON WIRING

1. Be sure to turn the power off before wiring.
2. Be particularly careful where you route the wires.
Keep them well away from the engine, and exhaust pipe, etc. Heat may damage the wires.
3. If the fuse should blow, check to see if the wiring is correct.
If a fuse is blown, replace it with a new one of the same amperage rating as the original (15A FUSE).
4. To replace the fuse, remove the old fuse of the power supply lead and insert the new one. (Figure10)

Note:

- There are various types of fuse holder. Do not let the battery side touch other metal parts.

⚠ CAUTION

After the connection, fix the lead by a clamp or insulation tape for protection.

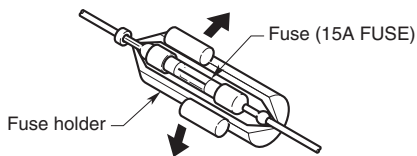
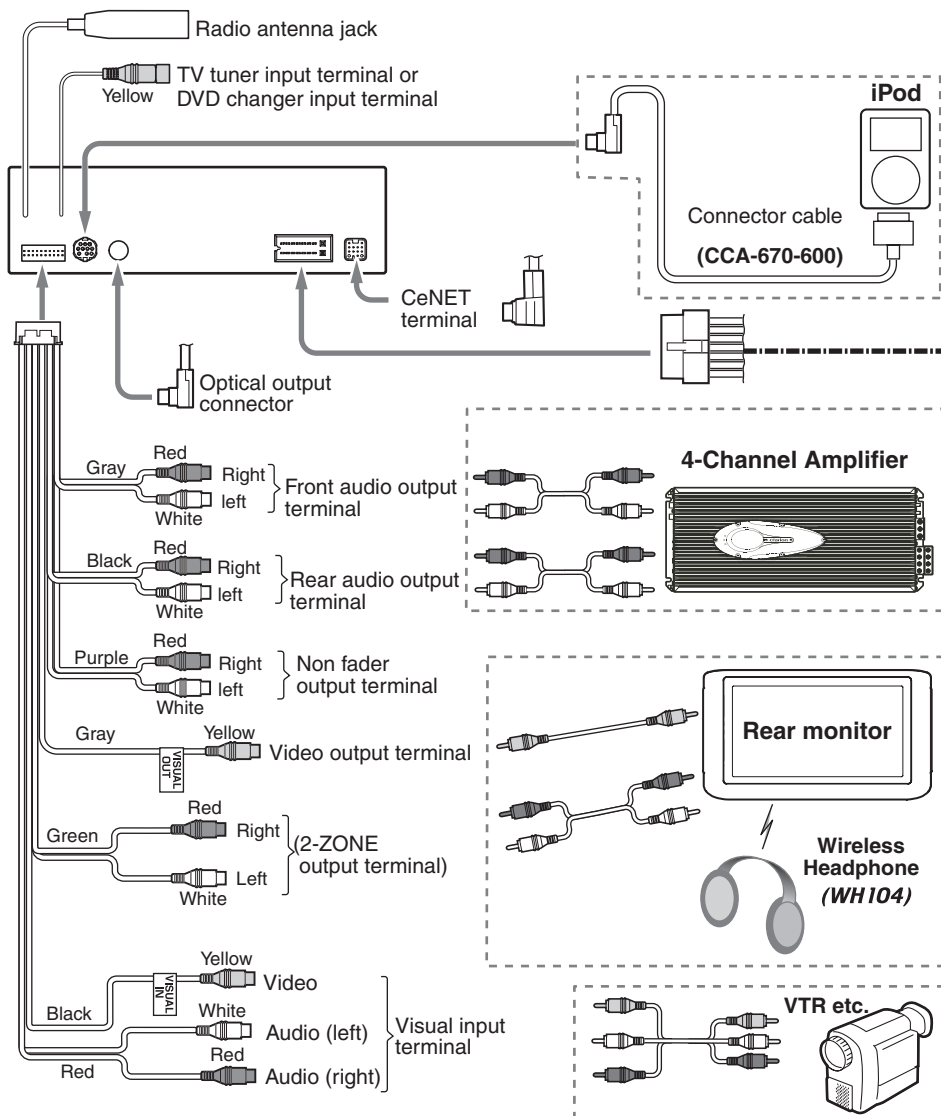

Figure 10

8. WIRE CONNECTION

Note:

- Before installing, be sure to disconnect the negative ⊖ cable of the car battery.
- In the optional devices, the RCA Pin and the Connector cable are separately-sold items.



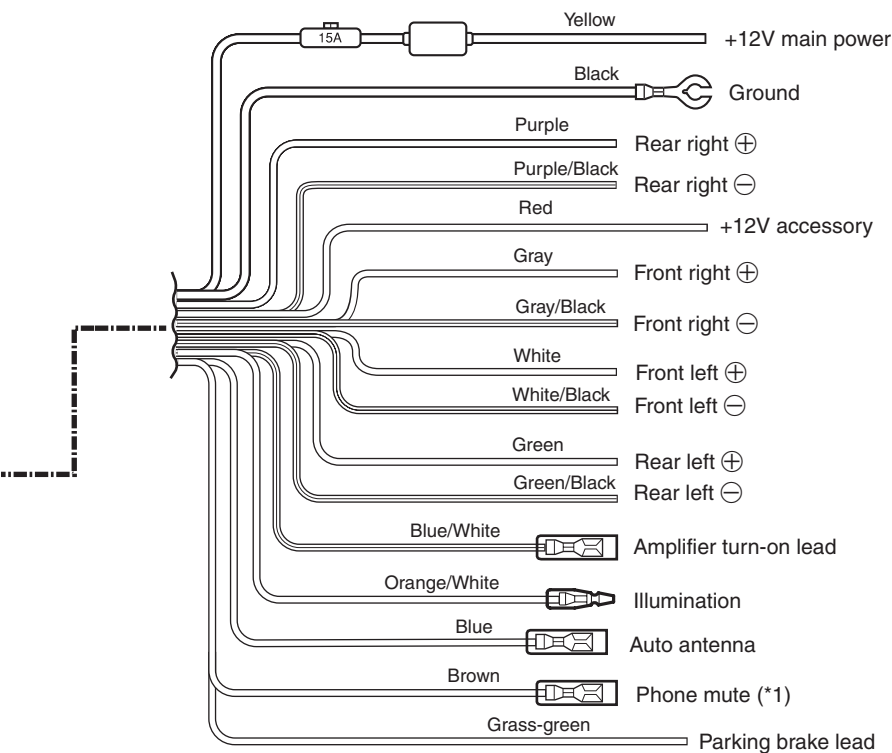

*1 Connecting the PHONE MUTE terminal
The lead included with the unit must be connected to the specified position of the vehicle's connector in order to use the **"Triggered audio mute for cellular telephones"** function.

● Connecting the parking brake lead

Connect the lead to parking brake lamp ground in the meter panel.

Note:

- Connecting the parking brake lead to lamp ground allows you to watch TV/VTR/DVD video/video CD when the parking brake is engaged.
- When the parking brake lead is not connected, the monitor will not turn on.

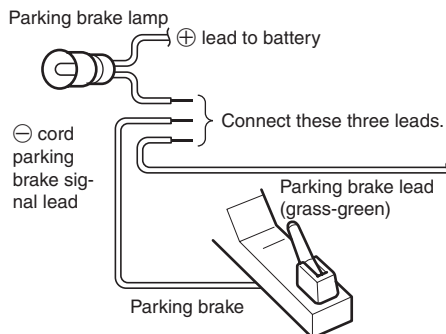

Connecting the Accessories

● Connection to the external amplifier

The external amplifier can be connected unless the 5.1ch Surround Decoder is connected. For detailed information, refer to the instruction manual of the 5.1ch Surround Decoder.

● Connection to the CCD camera for vehicle

The CCD camera for vehicle can be connected to CCD terminal on the TV tuner. For detailed information, refer to the instruction sheet or manual for the CCD camera.

Note:

- A power supply box (sold separately) is required for connection of the main unit and the CCD camera.
- The power supply box for the camera CAA147 cannot be used. Please use the CAA188 instead.

● If the specified lead of the cellular phone is connected to the phone mute lead of the source unit, the audio mute is available when the cellular phone is used.

● TV Tuner

When the TV tuner is to be connected, connect the CeNET connector and RCA PIN (yellow). For detailed information, refer to the instruction manual of the TV tuner.

● DVD Changer

To connect the TV tuner and the DVD changer simultaneously, use a commercial video selector purchasing separately.

● iPod

When you connect the iPod with video features by using the connector cable CCA-670-600, the video data stored in the iPod cannot be displayed on the liquid crystal panel of this unit. Use the Clarion's new connector cable which is released soon.

9. SAMPLE SYSTEM

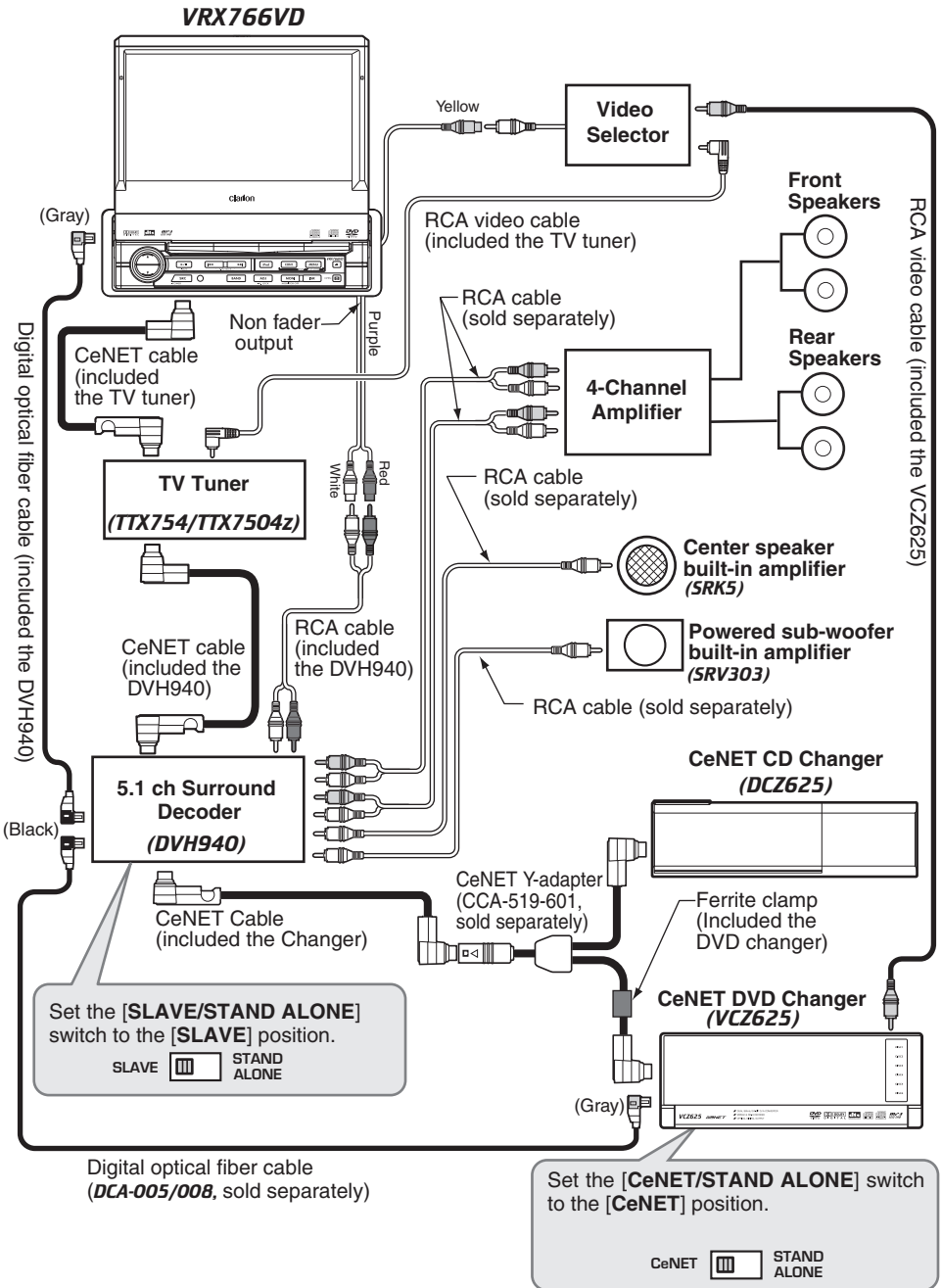

Clarion Co., Ltd.

All Rights Reserved. Copyright © 2006: Clarion Co., Ltd.

Printed in Japan / 在日本印刷 / 일본에서 인쇄하였음

พิมพ์ในประเทศไทยญี่ปุ่น / Dicetak di Jepang

2006/2 (Y-Y1)

QC-6823K
280-8375-00

Download from Www.Somanuals.com. All Manuals Search And Download.

Free Manuals Download Website

<http://myh66.com>

<http://usermanuals.us>

<http://www.somanuals.com>

<http://www.4manuals.cc>

<http://www.manual-lib.com>

<http://www.404manual.com>

<http://www.luxmanual.com>

<http://aubethermostatmanual.com>

Golf course search by state

<http://golfingnear.com>

Email search by domain

<http://emailbydomain.com>

Auto manuals search

<http://auto.somanuals.com>

TV manuals search

<http://tv.somanuals.com>