

Pro Security



MODEL MS8200 / MS8300
PRO SECURITY SYSTEM
INSTALLATION MANUAL

Table of Contents

| | | |
|-----|--|-----------|
| 1. | Before You Begin | Page 1 |
| 2. | Installation Tips | Page 2 |
| 3. | Mounting Components | |
| | Main Unit | Page 3 |
| | Siren | Page 3 |
| | Antenna | Page 3 |
| | Logic Sensor II | Page 4 |
| | Override Switch | Page 5 |
| | LED Status Indicator | Page 5 |
| | Space Shield III (MS8300) | Page 6 |
| 4. | Wiring Diagram | Page 7 |
| 5. | Wiring Description | Page 8 |
| 6. | Jumper and Switch Settings | |
| | Jumper Selections | Page 12 |
| | Programming Switches | Page 12 |
| | Accessing the Jumpers and Switches | Page 13 |
| | Setting the Jumpers and Switches | Page 13 |
| 7. | Remote Transmitters | |
| | Using the Remote Transmitters | Page 14 |
| | Two Car Operation | Page 15 |
| | Adding a New Transmitter | Page 16 |
| | Deleting Transmitters | Page 16 |
| 8. | Programming | |
| | System Initialization and Default Reset | Page 17 |
| | Arming Mode Selection (Active or Passive Arming) | Page 17 |
| | Entering System Programming | Page 17 |
| | Programmable System Parameters | |
| | 1. Ignition Controlled Door Locking / Unlocking | Page 18 |
| | 2. Warn Away Level - Logic Sensor II | Page 18 |
| | 3. Logic Sensor II Defeat by Remote | Page 18 |
| | 4. Audible Tamper Alert Report | Page 19 |
| | 5. Door Unlock Pulse - Single / Double | Page 19 |
| | 6. Siren Duration - Instant triggers | Page 19 |
| | 7. Siren Duration - Sensors | Page 19 |
| | 8. Radar Sensor - Warn Away Trigger | Page 19 |
| | 9. Full Time System Diagnostics Delay | Page 19 |
| | 10. Auxiliary Function 2 - Momentary / Latched / Timed | Page 20 |
| | 11. Auxiliary Function 3 - Momentary / Latched / Timed | Page 20 |
| 9. | Logic Sensor II | |
| | Adjustment | Page 21 |
| | Warn Away Sensitivity | Page 22 |
| 10. | Space Shield III | |
| | Operation | Page 22 |
| | Adjustment | Page 22 |
| 11. | Real Time Installation Verification | Page 24 |
| 12. | Seven Event Trigger History | Page 26 |
| 13. | Door Lock Diagrams | Page 27 |
| 14. | Wiring Diagram | Back Page |

Before You Begin

1. Be sure to read the manual thoroughly before beginning the installation to ensure a proper understanding of the MS8200 / MS8300 and its functions.
2. Verify system contents:
 - Main Unit
 - Two 3-Button Remote Transmitters
 - Siren
 - Logic Sensor II
 - Harnesses
 - 18-Pin main harness
 - 4-Pin optional sensor harness
 - 2-Pin Status LED harness
 - 2-Pin Override Switch harness
 - 3-Pin door lock harness
 - Pre-wired starter kill relay socket with relay
 - Window Mount Antenna **(MS8300 only)**
 - Space Shield III radar sensor **(MS8300 only)**
3. Discuss the location of the status LED and the Emergency Override Switch with the vehicle's owner.
4. Discuss the optional features of the MS8200 / MS8300 and the features that must be programmed during installation, with the vehicle's owner.
5. Check all of the vehicle's operating systems before and after the installation.

Installation Tips

1. Use a Volt / Ohm meter to test all wires. **Do not** use a test light.
2. Good power and ground connections are essential for proper operation.
3. Route all wires from the engine compartment to the interior of the vehicle through a grommet and use electrical tape and split loom tubing for protection.
4. When adding optional accessories such as door locks, window modules, etc., be sure to fuse each additional accessory power lead separately from the main power source. This will insure that the security system power is retained in the event that an accessory malfunctions.
5. Avoid extending the system's wires, the supplied wiring harnesses provide sufficient length to connect to the required vehicle circuits. If a wire must be extended, be sure to use the appropriate gauge wire in order to avoid a drop in current.
6. **Never** bypass the fuses included in the MS8200 / MS8300 wiring harness. They are necessary safety items designed to protect both the system and the vehicle.
7. Be sure to perform a full function test of all of the systems components to verify proper operation. Also, be sure to check all of the vehicle's operating systems before and after the installation.
8. For maximum security, disguise all system wires with black electrical tape and split loom tubing to prevent a thief from being able to identify the system wiring.

Mounting Components

Main Unit

The main unit should be mounted in the interior of the vehicle. *Do not* mount the main unit in the engine compartment. For maximum security, avoid mounting the main unit where it will be easily accessible to a thief.

If you are mounting the unit under the dash board, be sure to mount the unit as high as possible and in a location where it will not interfere with the operation of the pedals.

Be sure to extend the antenna as high as possible so that optimum range can be achieved.

Before securing the unit, be sure that you have made all of the necessary switch and jumper selections and perform a thorough function test of the system.

The case of the MS8200 / MS8300 is designed to be mounted using screws, or secured using wire ties through the wire tie mounting tabs on the bottom of the unit as shown below.

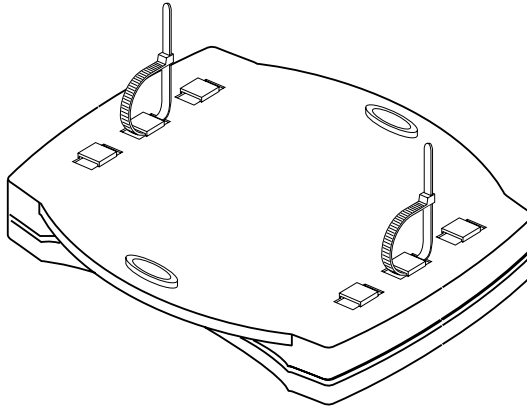

Siren

Mount the siren facing downward and away from sources of heat and face the opening downward to prevent water from collecting inside the housing. Be sure that the wires are not easily accessible from underneath the vehicle.

For maximum security, it is best to disguise all under hood system wires with factory style split loom tubing so that they cannot be easily identified by a thief.

Run all wires from the engine compartment into the interior of the vehicle through a grommet.

Antenna (MS8200)

Run the antenna as high as possible in the vehicle. Best operation range will be achieved when the antenna is run vertically, pointing upward. Avoid running the antenna along any existing wire harnesses and route away from metal surfaces.

Extended Range Antenna (MS8300)

Mount the extended range antenna to the front windshield behind the rear view mirror for best operation. Be sure that this area is clean and free of any metallic window tint film. In certain vehicles such as those equipped with a heated windshield or a built-in windshield defroster, the antenna should be mounted on a rear or side window. Mount the antenna at least 2 inches below the roof line.

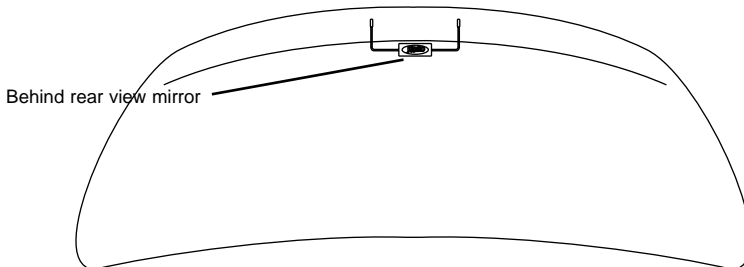

Logic Sensor II

The Logic Sensor II, included with the system, is designed to be mounted in the interior of the vehicle using a tie wrap or double sided tape. Be sure to avoid mounting the sensor to sources of strong electrical interference such as cellular phone transceivers or the vehicle's engine computer.

Suggested mounting locations are an air conditioning duct, or a dashboard or center console support brace.

Shock and Motion

When mounted horizontally, the Logic Sensor II will detect both shock and motion. The Logic Sensor II's motion detection is most effective on the axis on which it is mounted, which means that careful selection of the mounting location of the sensor will help to insure it's effectiveness.

Shock Only

When mounted vertically, the Logic Sensor will detect shock or impacts to the vehicle only and will be unaffected by slow rocking movements of the vehicle. This is especially useful in vehicles that are normally parked in areas subject to high wind or parked in tall parking structures that tend to move or sway.

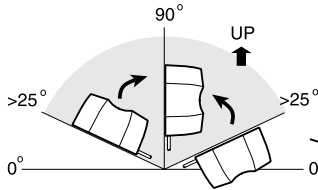

Mounting For Shock Sensitivity Only

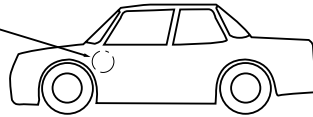

Mounting For Shock and Motion Sensitivity

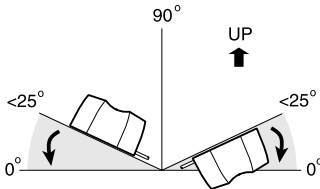

| Motion Sensitivity | | Position |
|--------------------|--------------|----------|
| Front/Rear | Side to Side | |
| Least | Best | |
| Good | Good | |
| Good | Good | |
| Best | Least | |

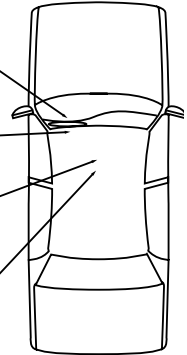

Override Switch

Mount the Override Switch in a location near the driver where it is easily accessible but not plainly visible. Plug the blue override switch connector into the blue 2-pin socket on the main unit.

Be sure that the switch cannot accidentally be pressed or damaged by movement of passengers or contents within the vehicle.

LED Status Indicator

Mount the status LED so that it is visible from both sides of the vehicle. Plug the white LED connector into white 2-pin socket on the Main Unit

Space Shield III (MS8300)

Mount the Space Shield III facing upward in a central location within the vehicle. For optimum performance, avoid mounting the sensor under or facing metal objects or support structures as they will alter the shape of the sensor's protection zones.

Also, be sure to mount the sensor in a location where items such as coins or coffee cups cannot be placed on top of the sensor. Mount the sensor securely so that it will not move or shift when the vehicle is in motion.

Suggested mounting locations are in the center of the vehicle, under the center console, or under the back seat.

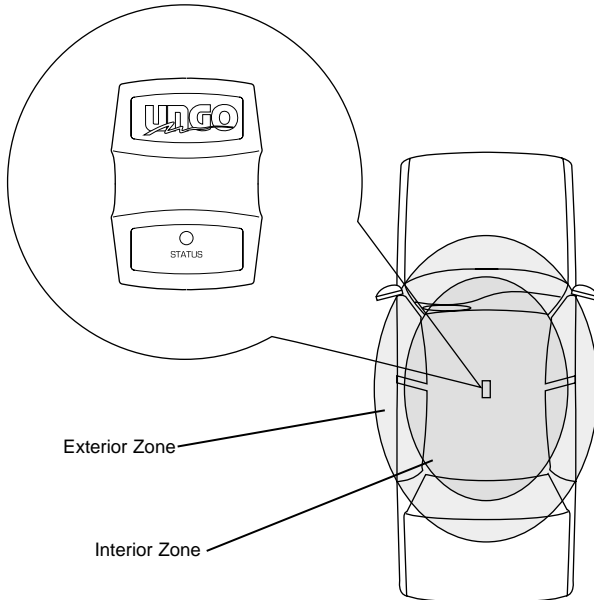

Wiring Diagram

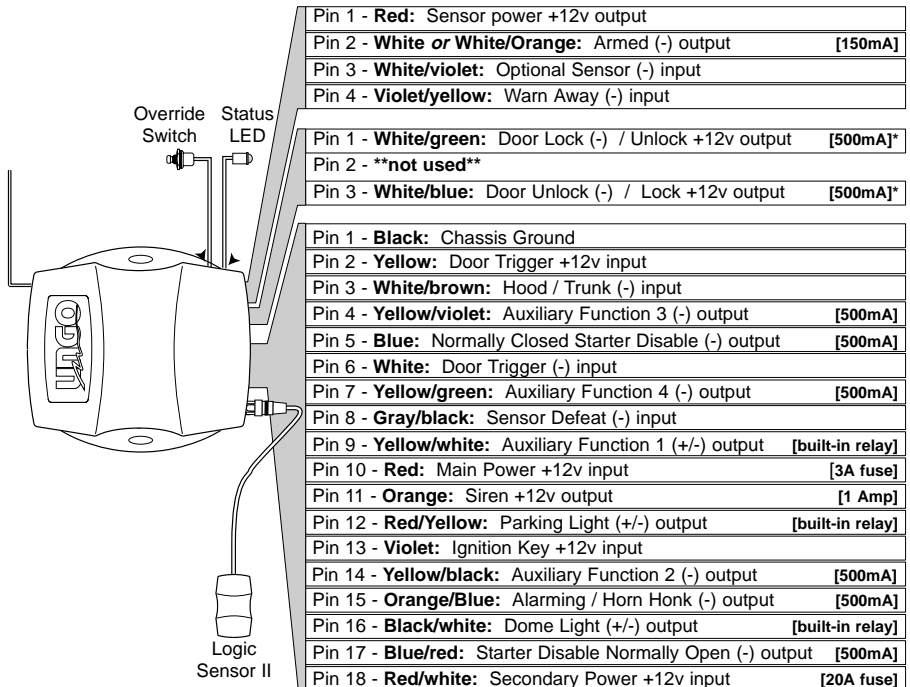

*for positive (+12v) polarity locking and unlocking max current is 150mA

Extended Range Antenna (MS8300)

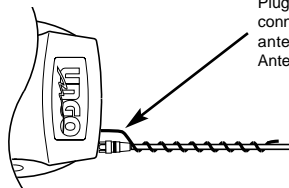

Plug the Extended Range Antenna into the connector at the top of the Main unit and wrap antenna wire around Extended Range Antenna cable to prevent interference.

Wiring Description

18-Pin Main Harness

Pin 1 - BLACK: Ground.

Connect to a solid chassis ground. Be sure to use a ring connector of proper size. Scrape away the paint at the grounding point.

Pin 2 - YELLOW: Door Trigger (+12v) input

Connect to positive door switch circuit. This circuit, commonly found in Ford vehicles, will show +12v when the door is open.

Pin 3 - WHITE/brown: Hood/Trunk Trigger (-) input

Connect to negative output from hood and/or trunk switches.

Pin 4 - YELLOW/violet: Auxiliary Function 3 (-) output

Provides a negative output to activate a relay. The output of this wire can be programmed to operate in one of three operating modes. See **Programming**.

- Momentary** - provides output for as long as the transmitter button is pressed.
- Latched** - provides an output that stays active until the transmitter button is pressed again.
- Timed** - provides an output that stays active for 30 seconds when the transmitter button is pressed. If the transmitter button is pressed again during the 30 seconds, the output will turn off.

Possible uses of the latched and timed outputs include: audio system valet, auxiliary lighting control, timed headlight operation, etc.

Pin 5 - BLUE: Starter Defeat Normally Closed (-) output

Provides a negative output while the alarm is Armed and during alarming to disable the vehicle's starter circuits. Connect to the provided Starter Kill Relay socket as shown.

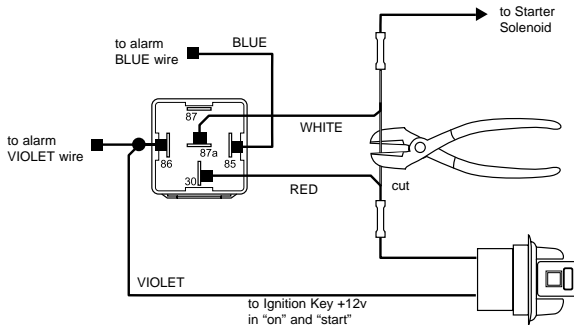

In this configuration, the vehicle's starter will be disabled only when the system is armed and alarming. If power to the system is lost or the system becomes disconnected, the vehicle will be able to start.

Pin 6 - WHITE: Door Trigger (-) input

Connect to negative door switch circuit. This circuit will show ground (-) when the door is open.

Pin 7 - YELLOW/green: Auxiliary Function 4 (-) output

Provides a negative output to activate a relay. The wire provides output for as long as the transmitter button is pressed.

Pin 8 - GRAY/black: Sensor Defeat (-) input

When this wire is grounded, the system will ignore the Logic Sensor II as well as any additional sensors connected to the system's Optional Sensor and Warn Away inputs. The Sensor Defeat wire is normally used for defeating the sensors when an optional Remote Car Starter is connected. When the car is started by remote, the Logic Sensor, ignition trigger, and optional sensor inputs are ignored until after the remote starter is shut down.

Pin 9 - YELLOW/white: Auxiliary Function 1 (+/-) output [on-board relay]

Provides selectable positive (+12v) or negative (-) output capable of activating a trunk release solenoid. Output will stay on for as long as the Button is pressed.

Pin 10 - RED: Main Power (+12v) input [3A fuse]

Connect to constant +12v. A clean source of power is essential. This connection can be made at either the battery or at the constant power supply wire to the ignition switch. Be sure to install a fuse near the connection. **Do not** remove or bypass the fuse holder included on the wire harness.

Pin 11 - ORANGE: Siren (+12v) output

Provides +12v to drive the siren. Connect to the Red siren wire. Connect the Black siren wire to chassis ground.

Pin 12 - RED/yellow: Parking Light (+/-) output [on-board relay]

Provides +12v or ground (-) to flash the parking lights. Do not connect this wire to parking light circuits that exceed 10 amps. For vehicles that have independent left and right parking light circuits, the parking light wires must be connected using diodes to keep the circuits separate. See **Jumper Selections** to select polarity.

Pin 13 - VIOLET: Ignition input (+12v) input.

Connect to a source that maintains +12v when the ignition key is in both the "on" and "start" positions.

Pin 14 - YELLOW/black: Auxiliary Function 2 (-) output. (resets with arm and disarm)

Provides a negative output to activate a relay. The output of this wire can be programmed to operate in one of three operating modes. See **Programming**.

Momentary - provides output for as long as the transmitter button is pressed.

Latched - provides an output that stays active until the transmitter button is pressed again.

Timed - provides an output that stays active for 30 seconds when the transmitter button is pressed. If the transmitter button is pressed again during the 30 seconds, the output will turn off.

Possible uses of the latched and timed outputs include: audio system valet, auxiliary lighting control, timed headlight operation, etc.

When latched or timed operation is selected, the output will reset (turn off) each time the system is armed or disarmed.

Pin 15 - ORANGE/blue: Alarming / Horn Honk (-) output

Provides a negative output when the system is triggered to activate a relay. The output is selectable for continuous or pulsed operation. See **Programming Switches**.

This wire can be connected to a relay to honk the vehicle's horn, or activate an auxiliary siren or air horns when the system is triggered.

Pin 16 - BLACK/white: Dome Light (+/-) output [on-board relay]

Illuminated Entry/Exit output. Provides a selectable positive (+12v) or negative (-) output to turn on the vehicle's dome light when the system is disarmed and when the ignition key is turned off. Normally, this wire can be connected directly to the door switch circuit. Be sure to set the polarity of this output. See **Jumper and Switch Settings**.

Pin 17 - BLUE/red: Starter Defeat Normally Open (-) output

Provides a negative output while the system is Disarmed to enable the starter circuits. Connect to the provided Starter Kill Relay socket as shown.

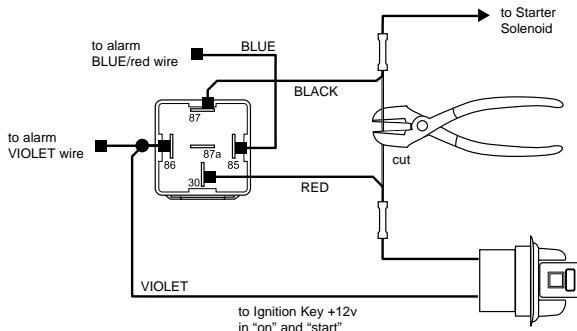

In this configuration, the vehicle will only start when the system is both connected and disarmed.

Pin 18 - RED/white: Secondary Power (+12v) input [20A fuse]

Connect to a fused +12v source. This wire is the source of power for all of the system's on-board relays, so a source of power capable of maintaining the necessary current is essential. Be sure to install a fuse near the connection. **Do not** remove or bypass the fuse holder included on the wire harness.

3-Pin Door Lock Harness

Pin 1 - WHITE/green: Door Lock (-) / Door Unlock (+)

Pin 2 - **not used**

Pin 3 - WHITE/blue: Door Unlock (-) / Door Lock (+)

These wires can be directly connected to negative and positive triggered door lock systems. For Voltage Reversal systems and After-market actuators, add relays. For further information, see **Door Lock Diagrams**. For selection of Double Pulse output, Comfort Closure, and 4-second pulse, see **Programming and Jumper and Switch Settings**.

4-Pin Optional Sensor Harness

Pin 1 - RED: +12v output.

Provides +12v to power optional sensor. Do not connect this wire to anything other than an optional sensor or the Space Shield III, included with the MS8300.

Pin 2 - WHITE or WHITE/orange: Armed (-) output.

Provides ground to turn on the optional sensor only when the system is Armed.

Pin 3 - WHITE/violet: Optional Sensor (-) trigger input.

Connect to the negative trigger output from an optional sensor.

Pin 4 - VIOLET/ yellow: Warn Away (-) input.

Connect to the negative Warn Away output from an optional sensor.

Other Harnesses

For details on the Status LED and Override Switch, see **Mounting Components**.

Extra LEDs

Up to 3 extra LEDs can be added. Cut the Red LED wire and connect in series as shown.

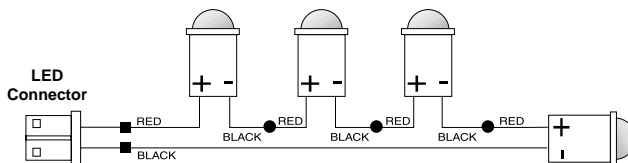

Jumper and Switch Settings

Jumper Selections

Cancel Auto Rearm. Disables the Automatic Rearm Feature.

On = Auto Rearm Disabled

Off = Auto Rearm Enabled

Parking Light Polarity. Selects the polarity (+/-) for the output of the on-board Parking Light relay.

Pin 1 + Pin 2 = positive

Pin 2 + Pin 3 = negative

Dome Light Polarity. Selects the polarity (+/-) for the output of the on-board Illuminated Entry/Exit relay.

Pin 1 + Pin 2 = positive

Pin 2 + Pin 3 = negative

Auxiliary Function 1 Polarity. Selects the polarity (+/-) for the output of the on-board Auxiliary Function 1 relay.

Pin 1 + Pin 2 = positive

Pin 2 + Pin 3 = negative

Programming Switches

1. **Door Lock Pulse Width.** Selects between a 1-second and a 4-second output for door locking and unlocking. Set to 4 seconds when interfacing into vehicles equipped with vacuum door locking systems.
2. **Passive Locking.** When the switch is on, the system will automatically lock the doors with Auto Rearm and Passive Arming.
3. **Ignore Delayed Domelight.** For use with vehicles equipped with a timed dome light circuit that stays on after door has been closed. When the switch is **on**, the system will ignore the dome light circuit during arming to prevent the system from responding with an open zone indication each time the system is armed.
4. **Horn Honk / Arming Output.** Selects between pulsed or constant output for the Orange/blue wire.
5. **Comfort Closure.** Sets the system to provide a 40 second output on the door lock wire (White/green (-) or White/blue (+12v)) when the system is Armed to activate the Comfort Closure feature found on many late model European vehicles. Vehicles equipped with this feature will normally close the windows and sunroof automatically when the door key is held to the lock position.
6. **Remote Space Shield III Adjustment.** Enables remote sensitivity adjustment of the Space Shield III (included with the MS8300) when connected to the 4-pin Optional Sensor harness.

Accessing the Jumpers and Switches

Using a flathead screwdriver, carefully press in on the access tabs on the sides of the case until the hooks release.

Take care not to push the tabs in too far or they may break.

Once you have made your selections, close the case by aligning the top and bottom halves of the case, making sure that the tabs are over their mounting holes.

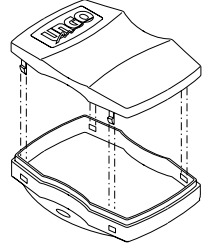
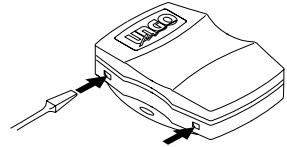

Setting the Jumpers and Switches

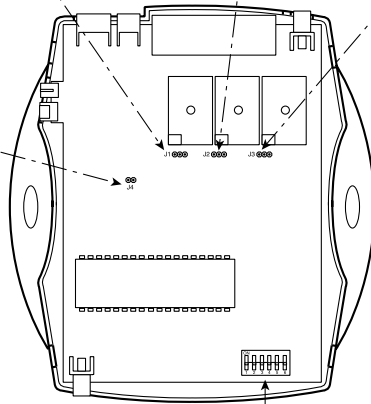
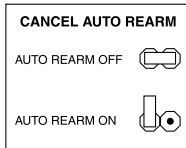
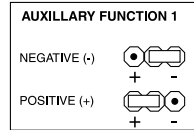
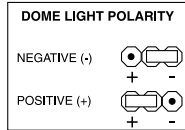
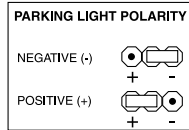

| # | Function | OFF | ON |
|---|--------------------------------|----------|------------|
| 1 | Door Lock/Unlock Pulse Width | 1 second | 4 Seconds |
| 2 | Passive Door Locking | OFF | ON |
| 3 | Ignore Dome Light Delay | OFF | ON |
| 4 | Alarming Output | Pulsing | Continuous |
| 5 | Comfort Closure | OFF | ON |
| 6 | Remote Space Shield III Adjust | YES | NO |

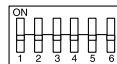

Remote Transmitters

Using the Remote Transmitters

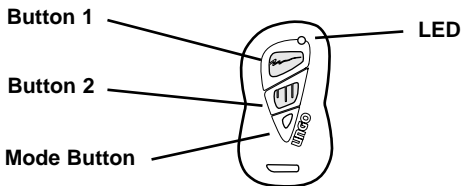

Each system comes with 2 Remote Transmitters, pre-programmed to Arm and Disarm the system *with* chirp confirmation using Button 1.

The Mode Button will change function of both Button 1 and Button 2 each time it is pressed.

When the Arm/Disarm Button is pressed together with any other Transmitter Button, the systems Chirp confirmation setting will be reversed.

If the system was programmed to arm the system *with* chirp, Pressing Buttons 1 and 2 together will arm the system *without* chirp.

If the system was programmed to arm the system *without* chirp, pressing Buttons 1 and 2 together will arm the system *with* chirp.

Note also that the LED on the transmitter changes color each time the Mode Button is pressed to indicate the current function of Buttons 1 and 2. The LED will stay on for 5 seconds, then turn off, returning Buttons 1 and 2 to their off settings.

The default setting of the Remote Transmitter is as pictured, where Button 1 is used to arm and disarm the system, Button 2 operates Auxiliary Function 1, Mode + 1 operates Auxiliary Function 2, etc.

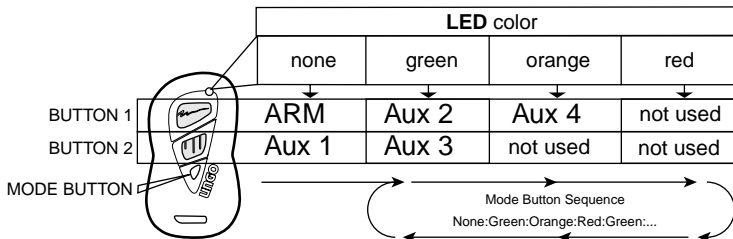

However, it is possible to set individual Remote Transmitters to arm and disarm the system using any of the Transmitters function Buttons, which is extremely useful when a Transmitter is used to control multiple system. See **Adding a Remote Transmitter into the System**.

The Button Assignment of Arming and Disarming will not affect the operation of the Remote

during Programming, Logic Sensor II Adjustment, Space Shield III Adjustment, Real Time System Verification or any other system set-up function.

The Buttons used to control those features will remain as they are described in this manual, regardless of how the Transmitter is set up to arm and disarm the system.

Two Car Operation

To use a single transmitter to operate multiple vehicles, the Transmitter can be set to arm Car #1 with Button 1 and arm Car #2 with the first available Button not being used by Car #1, which will be Mode, Mode, 1 if Car #1 is using Auxiliary functions 1 through 3.

The Auxiliary functions for Car #2 will follow the arm/disarm button in sequential order.

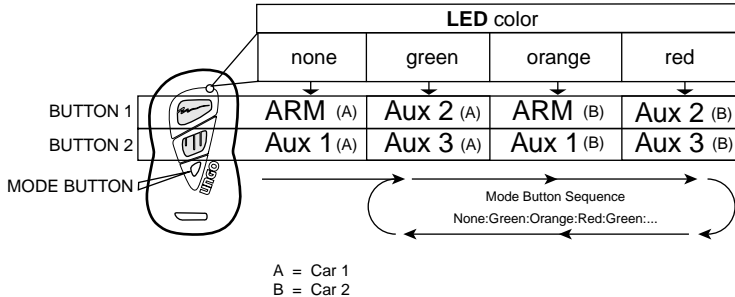

As stated, the Programming and set-up functions of Car #2's system *will not* be affected by this Transmitter configuration and will operate exactly as described described in this manual.

Adding a New Transmitter into the System

1. Turn on the ignition.
2. Press and hold the Override switch.
 - The status LED will turn on red.
3. Within 5 seconds:

*Continue holding the Override switch and Press Transmitter Button 1**

For remote arming **with** chirp confirmation.

--- or ---

*Release the Override switch and Press Transmitter Button 1**

For remote arming **without** chirp confirmation.

- The status LED will flash once quickly to confirm that the new Remote Transmitter has been added.
4. Turn off the ignition.

Deleting Transmitters (Adding a Remote Transmitter and Erasing All Other Remote Transmitters From the System)

1. Turn on the ignition.
2. Press and hold the Override switch.
 - The status LED will turn on red.Continue to hold the override switch.

• After 5 seconds, the status LED will flash 4 times, then turn on red again.

3. Within 5 seconds:

*Continue holding the Override switch and Press Transmitter Button 1**

For remote arming **with** chirp confirmation.

--- or ---

*Release the Override switch and Press Transmitter Button 1**

For remote arming **without** chirp confirmation.

- The status LED will flash once quickly to confirm that the new Remote Transmitter has been added.
4. Turn off the ignition.

* The Button that is pressed will be the Arm/Disarm Button on that Remote Transmitter. You may program any of the Transmitter's buttons to arm and disarm the system at this point.

Programming

System Initialization and Default Reset

Following this procedure will set all System Programming Parameters to factory default settings.

1. Turn on ignition.
2. After 4 seconds, press and hold Buttons 1 and 2 together for 5 seconds.
The siren will emit one long chirp, indicating that the reset signal was received.
3. Turn ignition off.
 - All System Programming parameters are now set to factory default settings.
 - The Arming Mode is set to Remote Arming only.
 - The Valet Mode is off.
 - The Logic Sensor II shock sensitivity is set to Level 6.
 - The Logic Sensor II motion sensitivity is set to Level 4.

Arming Mode Selection (Passive or Active Arming)

Using the Remote Transmitter, you may select Passive Arming with chirp confirmation, Passive Arming without chirp confirmation, or Active Arming (Remote only).

To set the Arming Mode:

1. Turn the ignition on.
2. Within 4 seconds, press Transmitter Buttons 1 and 2 together.

| | | | |
|--------------|--------------|---|---------------------------|
| First push: | one chirp | = | Passive Arming with chirp |
| Second push: | two chirps | = | Active Arming |
| Third push: | three chirps | = | Passive without chirp |
3. Turn off the ignition key to save your selection.

Entering System Programming

To enter System Programming:

1. Turn the ignition on.
2. Within 4 seconds, press Transmitter Button 2.
 - The siren will emit one short chirp, indicating that you have entered Programming Step 1.
 - The status LED will show the current setting of Step 1 (solid or flashing).
3. You can now make changes to the Programmable System Parameters.

Press Button 1 to change the setting.
Press Button 2 to move to the next step.
4. When you are finished, turn the ignition key off to save your changes. You can turn the key off at any time during programming. When the key is turned off, the changes that you have made will be saved.

Programmable System Parameters

| | | Status LED | | |
|------|---|--------------|----------------------------------|-------------------|
| | | Button 1 → | | |
| Step | Function | solid* | flashing (quickly) | flashing (slowly) |
| | | 1 | Ignition Controlled Door Locking | ON |
| 2 | Logic Sensor II Warn Away Level | High | Low | |
| 3 | Logic Sensor II Defeat by Remote | ON | OFF | |
| 4 | Audible Tamper Alert report | audible | LED only | |
| 5 | Door Unlock Pulse | single pulse | double pulse | |
| 6 | Siren Duration - Instant Triggers (door, hood, trunk, ignition) | 40 seconds | 20 seconds | |
| 7 | Siren Duration - Sensors (Logic Sensor II, optional sensor) | 20 seconds | 40 seconds | |
| 8 | Radar Sensor Warn Away Trigger | warn only | trigger | |
| 9 | Full Time System Diagnostic Delay | 20 seconds | no delay | |
| 10 | Auxiliary Function 2 output | momentary | latched | 30 seconds |
| 11 | Auxiliary Function 3 output | momentary | latched | 30 seconds |

* default setting

- 1. Ignition Controlled Door Locking / Unlocking.** Selects whether or not the system automatically locks the doors when the ignition is turned on. When selected, the Ignition Controlled Door Locking feature will automatically lock the doors 10 seconds after the ignition key is turned on and automatically unlock the doors when the ignition key is turned off.

To prevent the keys from being locked inside the vehicle when Ignition Controlled Door Locking is on:

- The system will not lock the doors if any door is open when the ignition is turned on.
- The system will not lock the doors if any door is opened during the 10 second countdown.

- 2. Logic Sensor II - Warn Away Level.** Allows you to set the level of the Logic Sensor II's Warn Away sensitivity. When **High** is selected, a lighter impact will produce a warning chirp, while the **Low** setting requires a stronger impact.
- 3. Logic Sensor II Defeat by Remote.** When selected, this feature will allow the user to temporarily disable the Logic Sensor II using the Remote Transmitter.

To turn off the Logic Sensor II by remote:

1. Press the Mode button 3 times, holding it down on the third press.
 - The LED on the Transmitter will glow red.
2. Continue holding the Mode Button.

- After 5 seconds, the Transmitter's LED will begin to flash rapidly, indicating the signal to turn off the Logic Sensor II is being transmitted.
- The siren will emit three chirps confirming the signal has been received and will ignore the Logic Sensor II until next time the system is armed.

4. **Audible Tamper Alert Report.** When Audible Tamper Alert is selected, the siren will chirp to indicate which zone had triggered the system, upon disarming.

If the system was triggered, the siren will emit one long chirp, followed by a series of short chirps indicating the violated zone.

- 1 chirp = door
- 2 chirps = Logic Sensor II (shock)
- 3 chirps = Space Shield III or Optional sensor
- 4 chirps = hood/trunk
- 5 chirps = Logic Sensor II (motion)

When Audible Tamper Alert report is turned off, the siren will emit a long chirp on disarming to indicate the system was triggered, but the zone indication will be from the status LED only.

5. **Door Unlock Pulse - Single/Double.** Selects between a *single* pulse or a *double* pulse door unlock output.

On many late model Nissan vehicles, as well as some European makes, the factory door locking system requires two pulses on the proper wire to unlock the vehicle's doors. By programming the system for double pulse door unlocking, these systems can be interfaced directly without the use of relays or any additional circuitry.

6. **Siren Duration - Instant Triggers.** Selects between a 20 second and a 40 second siren duration when the system is triggered by the instant trigger inputs (doors, hood/trunk, ignition).
7. **Siren Duration - Sensors.** Selects between a 20 second and a 40 second siren duration when the system is triggered by the sensors (Logic Sensor II or optional sensors).
8. **Radar Sensor - Warn Away Trigger.** When selected, this feature will set the system to trigger if it senses 3 violations on the Radar Sensor Warn Away input (Violet/yellow) within 15 seconds.

When this feature is turned off, the Warn Away input will only cause the siren to chirp and will not trigger the system.

9. **Full Time System Diagnostics Delay - 0 or 20 seconds.** Ungo's Full Time System Diagnostics continuously monitors the protected zones, even when the system is disarmed, and warns the user of an open door, hood, or trunk switch by emitting two chirps.

When set for 20 seconds, the delay will only allow the system to emit the warning chirps if a protected zone has been open or defective for at least 20 seconds.

This feature is useful for people who are in the habit of opening the vehicle's door before turning off the ignition key and do not want the warning chirps unless a zone has been open for a least 20 seconds.

10. **Auxiliary Function 2 - Momentary / Latched / Timed Operation. (resets with arm and disarm)** Selects between Momentary, Latched, or Timed output for Aux. 2.

When **Momentary** operation is selected, the system will provide an output for as long as the Transmitter button is held.

When **Latched** operation is selected, the system will provide an output that turns on when the transmitter button is pressed and turns off when the transmitter button is pressed again.

When **Timed** operation is selected, the system will provide an output that turns on for 30 seconds each time the transmitter button is pressed. If the button is pressed again during the 30 seconds, the output will turn off.

When the Latched or Timed outputs are activated:

- Arming the system will turn **off** the Aux. 2 output if it was turned **on** while the system was disarmed.
- Disarming the system will turn **off** the Aux. 2 output if it was turned **on** while the system was armed.

11. **Auxiliary Function 3 - Momentary / Latched / Timed Operation.** Selects between Momentary, Latched, or Timed output for Aux. 3.

When **Momentary** operation is selected, the system will provide an output for as long as the Transmitter button is held.

When **Latched** operation is selected, the system will provide an output that turns on when the transmitter button is pressed and turns off when the transmitter button is pressed again.

When **Timed** operation is selected, the system will provide an output that turns on for 30 seconds each time the transmitter button is pressed. If the button is pressed again during the 30 seconds, the output will turn off.

The operation of Aux. 3 is *not* affected by arming and disarming.

Logic Sensor II



Because of its advanced design, the Logic Sensor II can be set for Shock and Motion detection or Shock detection only, simply by the way the sensor is mounted. See **Mounting Components**.

Adjustment

The shock and motion sensitivity of the Logic Sensor II are set independently, using the Remote Transmitter. For shock, there are 12 levels of sensitivity. For motion, there are 8 levels of sensitivity. Level 1 is off for both shock and motion.

- If the motion sensitivity is set to Level 1, the Logic Sensor II will not detect motion, only shock.
- If the shock sensitivity is set to Level 1, the Logic Sensor II will not detect shock, only motion.
- If *both* shock and motion are set to Level 1, the Logic Sensor II will be completely off.

When both shock and motion sensitivity are set to Level 1, the siren will emit 1 chirp, followed by 3 chirps each time the system is Armed to indicate that the Logic Sensor II is off.

| Logic Sensor II Sensitivity | |
|-----------------------------|--|
| Shock Level | 1 off 2 lowest  12 highest |
| Motion Level | 1 off 2 lowest  8 highest |

To Adjust the sensitivity:

1. Turn the ignition key on.
2. Within 4 seconds, press Transmitter Button 1.
 - The siren will chirp (1 through 12) to indicate the current **shock** sensitivity level. The default shock sensitivity setting is 6.
3. Test the sensitivity. The siren will respond with a **short chirp** when shock is detected and a **long chirp** when motion is detected.
 - The Logic Sensor II has 8 levels of sensitivity for motion. The default motion sensitivity setting is 4.

Be sure that the Logic Sensor II is mounted horizontally if motion detection is desired.
4. To make adjustments:
 - Press Button 1 to increase the **shock** sensitivity.
 - Press Button 2 to decrease the **shock** sensitivity.
 - Press the Mode Button, then Button 1 to increase the **motion** sensitivity.
 - Press the Mode Button, then Button 2 to decrease the **motion** sensitivity.
 - The siren will chirp to indicate the sensitivity level each time the Button is pressed.
5. When you are satisfied with the sensitivity, turn off the ignition.

Warn Away Sensitivity

The sensitivity of the Logic Sensor II's Light Impact Response can also be adjusted. There are two settings for Warn Away, **High** and **Low**. The default setting is **High**. To change the setting, see **Programming**.

Space Shield III

The Space Shield III is a dual zone proximity sensor that uses high frequency radar signals to detect the presence of moving objects within a defined area. For more information, see **Mounting Components**.

Operation

While the system is armed, each time the Space Shield III detects movement in the Exterior zone, the siren will emit a warning chirp. When movement is detected in the Interior zone, the system will trigger.

The Space Shield III can be set to operate in one of two ways: with and without Perimeter Alarm. To select the Operating Mode of the Space Shield III, see **Programming - Step 8, Radar Sensor Warn Away Trigger**.

With Perimeter Alarm

When movement is detected in the Exterior zone 3 times, within 15 seconds, the system will trigger.

Without Perimeter Alarm

Detected movement in the Exterior zone will cause the siren to emit a warning chirp. Only movement in the Interior zone will trigger the system.

Adjustment

To Enter Space Shield III Adjustment,

1. Turn on the ignition.
2. Within 4 seconds, press the Mode Button twice, then Button 1.
 - The siren will emit one chirp.
 - The radar sensor will turn on and perform a system check. (This will take approximately 15 seconds.)
 - When the sensor is ready, the siren will chirp 3 times and the **Interior** zone can be adjusted.
3. Test the Interior zone sensitivity.
 - Each time the sensor detects movement, the siren will chirp 1 time and the LED on the sensor will light red.
4. To make adjustments:
 - Press Button 1 to increase the sensitivity.
 - Press Button 2 to decrease the sensitivity.
 - The siren will emit one long chirp when the sensitivity is *increased* and two long chirps when the sensitivity is *decreased*.

When the minimum or maximum sensitivity levels have been reached, the siren will emit 4 quick chirps.

5. Once you are satisfied with the Interior zone sensitivity setting, press the Mode Button, then Button 2 to begin adjusting the **Exterior** zone.
 - The siren will chirp 4 times, the Exterior zone can be adjusted.
6. Test the Exterior zone sensitivity.
 - Each time the sensor detects movement, the siren will chirp 2 times and the LED on the sensor will light green.
7. To make adjustments:

Press Button 1 to increase the sensitivity.

Press Button 2 to decrease the sensitivity.

- The siren will emit one long chirp when the sensitivity is *increased* and two long chirps when the sensitivity is *decreased*.

When the minimum or maximum sensitivity levels have been reached, the siren will emit 4 quick chirps.

You may return to Interior zone adjustment at any time by pressing the Mode Button, then Button 1.

- The siren will chirp 3 times to indicate the **Interior** zone can be adjusted.
8. Once you are satisfied with the sensitivity, turn the ignition key off.

Real Time Installation Verification

This feature allows the installer to quickly and effectively check all aspects of the installation.

To enter Real Time System Verification:

1. Enter the vehicle.
2. Close the vehicle doors, hood, and trunk.
3. Turn on the ignition.
4. Within 4 seconds, press the Mode button then press and hold Button 1 for 5 seconds.
 - The siren will emit one long chirp.
 - The Starter Kill and the Armed outputs will activate.
5. You can now test the system.

I. Input Test

Test the starter kill by turning the ignition key to the start position.

- The car should not start.

Test the door input. (Open the door)

- The siren will chirp once.

With the door open:

Test the override switch.

- The status LED will flash while the override switch is held.

Test the Sensor Defeat input wire (Gray/black).

- The status LED will turn on solid while the Sensor Defeat input is grounded.

Test the Hood / Trunk input.

- The siren will chirp 4 times when the hood or trunk is opened.

Close the door.

With the door closed:

Test the Optional Sensor (White/violet) and Warn Away (Violet/yellow) inputs.

- When the system detects a signal on the Warn Away input, the siren will emit 2 short chirps.
- When the system detects a signal on the Optional Sensor input, the siren will will emit 3 short chirps.

II. Output Test

To test the system's outputs, press the Transmitter Button corresponding to the function that you want to test.

| | | |
|------------------------|---|--------------------|
| Button 1 | = | parking lights |
| Button 2 | = | dome light |
| mode + 2 | = | door lock output |
| mode + mode + 1 | = | door unlock output |
| mode + mode + 2 | = | horn |
| mode + mode + mode + 1 | = | siren |

- During output testing, each function will stay active for as long as the transmitter button is held.

After you have finished testing, turn off the ignition key to exit Real Time Installation Verification.

| Input Test | | | |
|--------------------|-----------------------|----------------------------|------------------------|
| | Function | To Test | Response |
| Door Open | Starter Defeat | Turn Key To Start Position | Vehicle will not start |
| | Override Switch | Press Override Switch | LED Flashing |
| | Sensor Kill Wire | Ground Gray/black wire | LED Solid |
| | Hood/Trunk Input | Open Hood/Trunk | 4 Chirps |
| | Door | Open Door | 1 Chirp |
| Door Closed | Optional Sensor Input | Trigger Optional Sensor | 3 Quick Chirps |
| | Warn Away Input | Trigger Warn Away input | 2 Quick Chirps |

| Output Test | | |
|--------------------|-----------------|---------------------|
| | Function | To Test |
| Any Time | Parking Lights | Button 1 |
| | Dome Light | Button 2 |
| | Door lock | Mode, 2 |
| | Door unlock | Mode, Mode, 1 |
| | Horn | Mode, Mode, 2 |
| | Siren | Mode, Mode, Mode, 1 |

Seven Event Trigger History

This feature allows you to recall, from the system's memory, the events (zones) that have triggered the system during the last *seven times* the system was armed. This is especially useful in diagnosing sensors that are causing the system to trigger and need adjustment.

To enter Trigger History:

1. Turn on the ignition.
2. Open the door.
3. After 4 seconds, press Button 1 on the Remote Transmitter.
 - The siren will chirp once.
 - The LED will flash to indicate the zones that last triggered the system.

1 flash = door
2 flashes = Logic Sensor II (shock)
3 flashes = Space Shield III or optional sensor
4 flashes = hood/trunk
5 flashes = Logic Sensor II (motion)

The LED will continue to flash for 60 seconds or until the Transmitter Button is pressed again.

4. To view the next previous triggering event, press Button 1 again.
 - The siren will chirp once and the LED will flash to show the next previous event.
 - If there are no other events in the system's memory, the siren will chirp two times.
5. To clear the Trigger History, press Button 2.
 - The siren will chirp 5 times and erase all Trigger History data.

If the Trigger History is not cleared before the ignition is turned off, the Trigger History data will be retained in the system's memory for further use.

6. To exit, turn the ignition off.

Door Lock Diagrams

White/green = (-) Lock / +12v Unlock

White/blue = +12v Lock / (-) Unlock

Negative Trigger

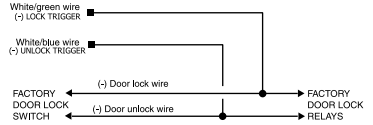

Positive Trigger

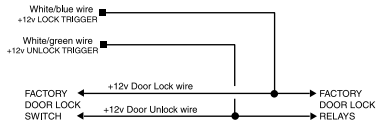

Voltage Reversal

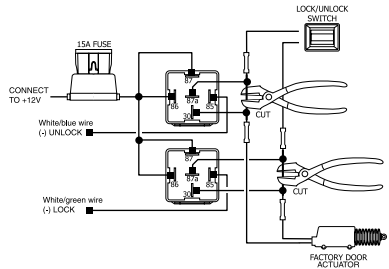

Aftermarket Actuators

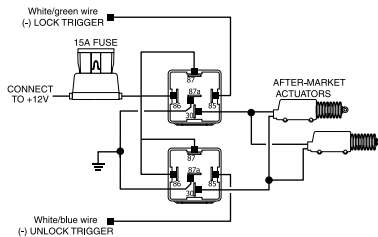

Vacuum Lock System

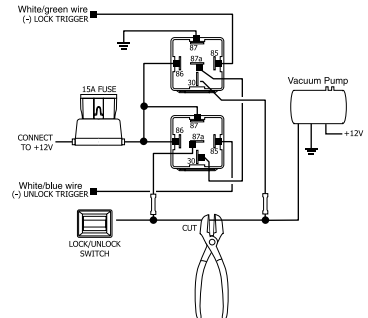

MS8200 / MS 8300 Wiring Diagram

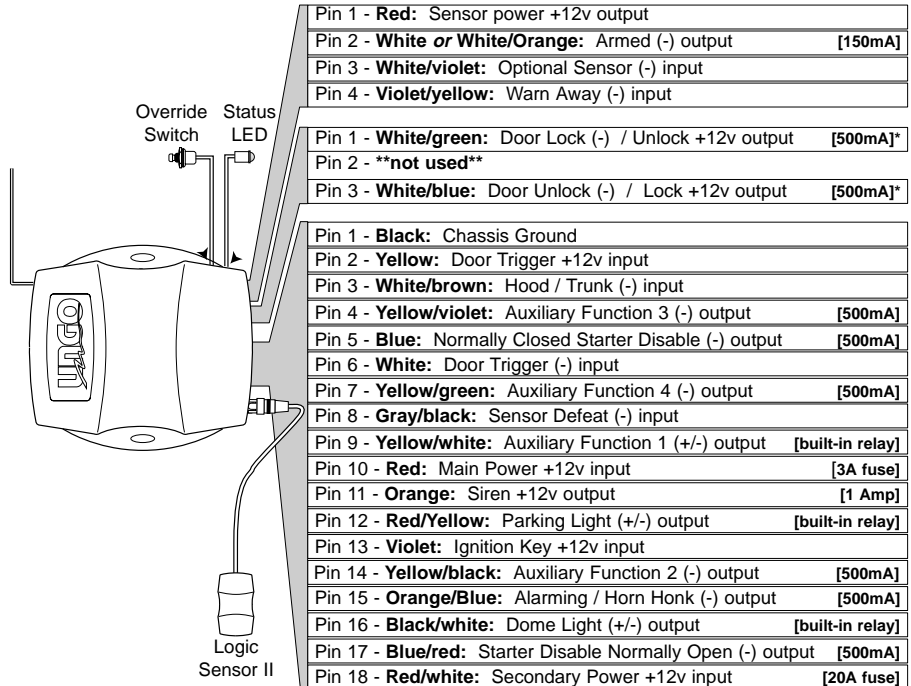

*for positive (+12v) polarity locking and unlocking max current is 150mA

Ungo Security Corporation

A Clarion Company
 661 West Redondo Beach Blvd.
 Gardena, CA 90247
 800-Go-Clarion
 www.clarionmultimedia

Free Manuals Download Website

<http://myh66.com>

<http://usermanuals.us>

<http://www.somanuals.com>

<http://www.4manuals.cc>

<http://www.manual-lib.com>

<http://www.404manual.com>

<http://www.luxmanual.com>

<http://aubethermostatmanual.com>

Golf course search by state

<http://golfingnear.com>

Email search by domain

<http://emailbydomain.com>

Auto manuals search

<http://auto.somanuals.com>

TV manuals search

<http://tv.somanuals.com>