

Clarion

*Owner's manual / Mode d'emploi
Bedienungsanleitung / Istruzioni per l'uso
Gebruiksaanwijzing / Manual de instrucciones
Bruksanvisning / Manual de instruções*

DXZ548RMP

**RDS-EON FM / MW / LW RADIO CD / MP3 / WMA
COMBINATION**

**COMBINE RADIO FM/PO/GO RDS-EON-LECTEUR DE CD/
MP3/WMA**

**RDS-EON UKW/MW/LW RADIO CD/MP3/WMA
KOMBINATION**

**COMBINAZIONE DI RADIO RDS-EON FM/MW/LW E
LETTORE CD/MP3/WMA**

RDS-EON FM/MW/LW RADIO CD/MP3/WMA COMBINATIE

**COMBINACIÓN DE RADIO RDS-EON DE FM/MW/LW Y
REPRODUCTOR DE CD/MP3/WMA**

**KOMBINERAD FM/MV/LV-RADIO MED RDS-EON OCH CD/
MP3/WMA-SPELARE**

**COMBINAÇÃO DE CD/MP3/WMA COM RÁDIO FM/MW/LW
RDS-EON**

CaNET

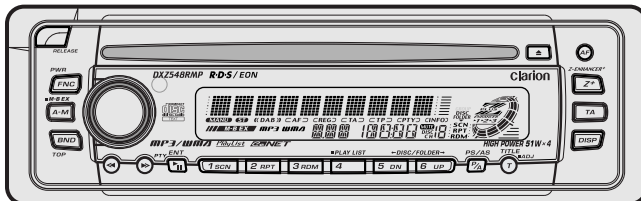

Thank you for purchasing this **Clarion** product.

- * Please read this owner's manual in its entirety before operating this equipment.
- * After reading this manual, be sure to keep it in a handy place (e.g., glove compartment).
- * Check the contents of the enclosed warranty card and keep it carefully with this manual.
- * This manual includes the operating procedures of the CD changer, DVD changer, DAB and TV tuner connected via the CeNET cable. The CD changer, DVD changer and TV tuner have their own manuals, but no explanations for operating them are described.

CAUTIONS:

This appliance contains a laser system and is classified as a "CLASS 1 LASER PRODUCT". To use this model properly, read this Owner's Manual carefully and keep this manual for your future reference. In case of any trouble with this player, please contact your nearest "AUTHORIZED service station". To prevent direct exposure to the laser beam, do not try to open the enclosure.

!CAUTION

USE OF CONTROLS OR ADJUSTMENTS OR PERFORMANCE OF PROCEDURES OTHER THAN THOSE SPECIFIED IN THE OWNER'S MANUAL MAY RESULT IN HAZARDOUS RADIATION EXPOSURE.

ADVARSEL.

Denne mærking er anbragt udvendigt på apparatet og indikerer, at apparatet arbejder med laserstråler af klasse 1, hvilket betyder, at der anvendes laserstråler af svageste klasse, og at man ikke på apparatets yderside kan blive udsat for utilsladelig kraftig stråling.

APPARATET BØR KUN ÅBNES AF FAGFOLK MED SÆRLIGT KENDSKAB TIL APPARATER MED LASERSTRÅLER!

Indvendigt i apparatet er anbragt den her gengivne advarselmærkning, som advarer imod at foretage sådanne indgreb i apparatet, at man kan komme til at udsætte sig for laserstråling.

OBS!

Apparatet innehåller laserkomponenten som avger laserstrålning överstigande gränsen för laserklass 1.

VAROITUS

Suojakoteloä si saa avata. Laite sisältää laseriodin, joka lähettää näkymätöntä silmille vaarallista lasersäteilyä.

MODEL		clarion
12V \ominus GROUND		
LW	153-279kHz	
MW	531-1602kHz	
FM(UKW)	87.5-108MHz	
This unit is designed for on-road vehicle purpose		
CLASS 1 LASER PRODUCT		
This product includes technology owned by Microsoft Corporation and cannot be used or distributed without a license from MSLGP.		
		PEL <input type="checkbox"/> 2004 <input type="checkbox"/> Clarion Co., Ltd. MADE IN <input type="checkbox"/>

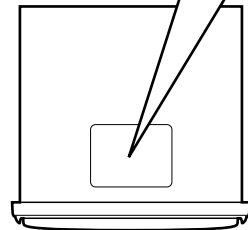

- MANU** : Manual indication
- ST** : Stereo indication for DAB
- ((DAB))** : DAB indication
- CAF** : Alternative frequency indication
- CREG** : Regional indication
- CTA** : Traffic announcement indication
- CTP** : Traffic programme indication
- CPTY** : Programme type indication
- CINFO** : Information indication for DAB

Operation status indication
Titles, PS names, CT(clock),
etc. are displays.

Z-Enhancer Plus indication

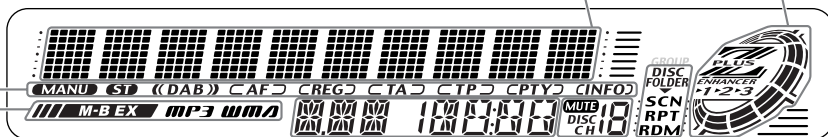

Function mode indication
The names of modes being
selected, etc. are displayed.

MUTE : Mute indication
Preset channel indication (1 to 6)
Disc number indication (1 to 12)

DISC FOLDER : Disc folder indication
SCN : Scan indication
RPT : Repeat indication
RDM : Random indication

M-B EX : MAGNA BASS EXTEND indication
MP3 : MP3 indication
WMA : WMA indication

Contents

1. PRECAUTIONS	3
Handling Compact Discs	4
2. CONTROLS	5
3. NOMENCLATURE	6
Names of the Buttons and Their Functions	6
Major Button Operations When External Equipment is Connected to This Unit	7
Display Items	8
LCD Screen	8
4. DCP	9
5. REMOTE CONTROL (Optional)	10
Inserting the Batteries	10
Functions of Remote Control Unit Buttons	11
6. OPERATIONS	12
Basic Operations	12
Radio Operations	14
RDS Operations	16
CD/MP3/WMA Operations	19
Operations Common to Each Mode	24
7. OPERATIONS OF ACCESSORIES	27
CD Changer Operations	27
TV Operations	29
Digital Radio/DAB Operations	30
8. IN CASE OF DIFFICULTY	34
9. ERROR DISPLAYS	36
10. SPECIFICATIONS	37

1. PRECAUTIONS

1. This unit is applicable for on-road 4 wheel vehicle purpose only. Use for tractor, fork truck, bulldozer, off road vehicle, 2 or 3 wheel motor bicycle, marine boat or other special purpose vehicle is not appropriate.
2. When the inside of the car is very cold and the player is used soon after switching on the heater moisture may form on the disc or the optical parts of the player and proper playback may not be possible. If moisture forms on the disc, wipe it off with a soft cloth. If moisture forms on the optical parts of the player, do not use the player for about one hour. The condensation will disappear naturally allowing normal operation.
3. Driving on extremely bumpy roads which cause severe vibration may cause the sound to skip.

INFORMATION FOR USERS:

CHANGES OR MODIFICATIONS TO THIS PRODUCT NOT APPROVED BY THE MANUFACTURER WILL VOID THE WARRANTY.

Handling Compact Discs

Use only compact discs bearing the or mark.

Do not play heart-shaped, octagonal, or other specially shaped compact discs.

Some CDs recorded in CD-R/CD-RW mode may not be usable.

Handling

- Compared to ordinary music CDs, CD-R and CD-RW discs are both easily affected by high temperature and humidity and some of CD-R and CD-RW discs may not be played. Therefore, do not leave them for a long time in the car.
- New discs may have some roughness around the edges. If such discs are used, the player may not work or the sound may skip. Use a ball-point pen or the like to remove any roughness from the edge of the disc.

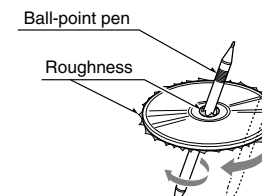

- Never stick labels on the surface of the compact disc or mark the surface with a pencil or pen.
- Never play a compact disc with any cellophane tape or other glue on it or with peeling off marks. If you try to play such a compact disc, you may not be able to get it back out of the CD player or it may damage the CD player.
- Do not use compact discs that have large scratches, are misshapen, cracked, etc. Use of such discs may cause misoperation or damage.
- To remove a compact disc from its storage case, press down on the center of the case and lift the disc out, holding it carefully by the edges.

- Do not use commercially available CD protection sheets or discs equipped with stabilizers, etc. These may damage the disc or cause breakdown of the internal mechanism.

Storage

- Do not expose compact discs to direct sunlight or any heat source.
- Do not expose compact discs to excess humidity or dust.
- Do not expose compact discs to direct heat from heaters.

Cleaning

- To remove fingermarks and dust, use a soft cloth and wipe in a straight line from the center of the compact disc to the circumference.
- Do not use any solvents, such as commercially available cleaners, anti-static spray, or thinner to clean compact discs.
- After using special compact disc cleaner, let the compact disc dry off well before playing it.

LCD Screen

In extreme cold, the screen movement may slow down and the screen may darken, but this is normal. The screen will recover when it returns to normal temperature.

*Be sure to unfold and read the next page. / Veuillez déplier et vous référer à la page suivante.
Bitte ausbreiten und die nächste Seite lesen. / Assicurarsi di aprire e leggere la pagina successiva.
Volgende pagina uitvouwen en doorlezen a.u.b. / Cerciórese de desplegar y de leer la página siguiente.
Glöm inte att vika ut och läsa nästa sida. / Não deixe de abrir e ler a próxima página.*

2. CONTROLS / LES COMMANDES / REGLER / CONTROLLI REGELAARS / CONTROLES / KONTROLLER / CONTROLOS

Main unit / Appareil principal / Hauptgerät / Apparecchio principale
Hoofdtoestel / Unidad principal / Huvudenhhet / Unidade principal

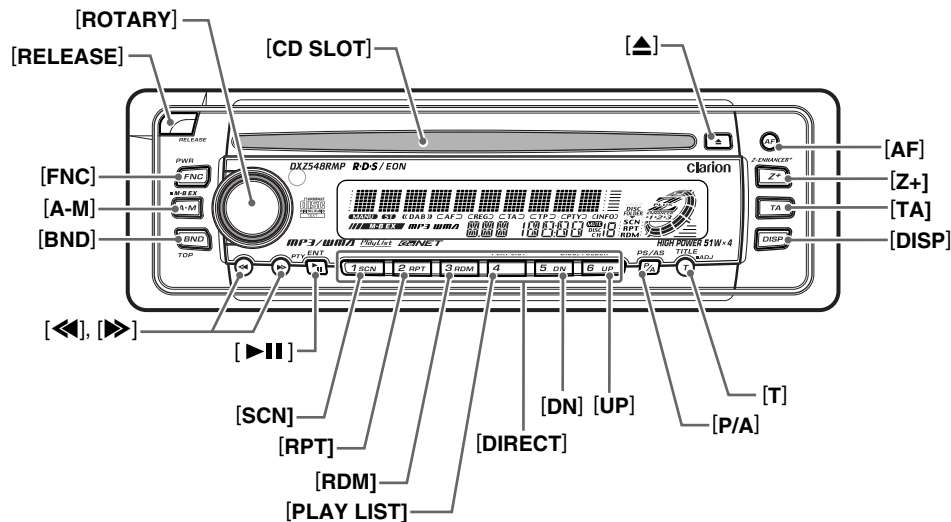

Note: Be sure to unfold this page and refer to the front diagrams as you read each chapter.

Remarque: Veuillez déplier cette page et vous référer aux schémas quand vous lisez chaque chapitre.

Hinweis: Bitte diese Seite ausfallen und beim Lesen der einzelnen Kapitel die Frontdiagramme beachten.

Nota: Assicurarsi di aprire questa pagina e fare riferimento a questi diagrammi quando si legge ciascun capitolo.

Opmerking: Vouw deze pagina uit en zie tevens de afbeeldingen van het voorpaneel tijdens het doorlezen van de volgende hoofdstukken.

Nota: Cuando lea los capítulos, despliegue esta página y consulte los diagramas.

Observera: Vik ut denna sida för att kunna se figurena över bilstereons framsida medan du läser de olika kapitlen.

Nota: Certifique-se de abrir esta página e consulte os diagramas frontais conforme realiza a leitura de cada capítulo.

3. NOMENCLATURE

Note:

- Be sure to read this chapter referring to the front diagrams of chapter "2. CONTROLS" on page 5 (unfold).

Names of the Buttons and Their Functions

[RELEASE] button

- Deeply push in [RELEASE] button to unlock the DCP.

[ROTARY] knob

- Adjust the volume by turning the knob clockwise or counterclockwise.
- Use the knob to perform various settings.

[CD SLOT]

- CD insertion slot.

[▲] button

- Eject a CD when it is loaded into the unit.

[AF] button

- Press the button to turn on or off the AF (Alternative Frequency) function.
- When the button is pressed and held, Regional function can select ON or OFF.

[Z+] button

- Use the button to select one of the 4 types of sound characteristics already stored in memory.

[TA] button

- Use the button to set the TA (Traffic Announcement) standby mode.

[DISP] button

- Switch the display indication (Main display, Clock display).

[T] button

- Use the button to input a title in the CD mode.
- Press and hold the button for 1 second or longer to enter the adjust mode.

[P/A] button

- Perform preset scan while in the radio mode.
- When the button is pressed and held, auto store is performed.

[UP], [DN] buttons

- Select the Folder. (MP3/WMA disc only)

[DIRECT] buttons

- Store a station into memory or recall it directly while in the radio mode.

[PLAY LIST] button

- Press and hold for 1 second or longer to turn on or off the play list mode. (MP3/WMA disc only)

[RDM] button

- Perform random play while in the CD mode.
- Press and hold the button for 1 second or longer to perform folder random play while in the MP3/WMA mode.

[RPT] button

- Repeat play while in the CD mode.
- Press and hold the button for 1 second or longer to perform folder repeat play while in the MP3/WMA mode.

[SCN] button

- Perform scan play for 10 seconds of each track while in the CD mode.
- Press and hold the button for 1 second or longer to perform folder scan play while in the MP3/WMA mode.

[▶||] button

- Use the button to set the PTY (Programme Type) standby mode or PTY items.
- Play or pause a CD while in the CD mode.

[◀], [▶] buttons

- Select a station while in the radio mode or select a track when listening to a CD. These buttons are used to make various settings.
- Press and hold the button for 1 second or longer to switch the fast-forward/fast-backward.

[BND] button

- Switch the band, or seek tuning or manual tuning while in the radio mode.
- Play a first track while in the CD mode.
- Play a first track of a current folder in the MP3/WMA mode.

[A-M] button

- Use the button to switch to the audio mode (bass/treble, balance/fader Z-Enhancer Plus, Magna Bass Extended adjustment)
- Press and hold for 1 second or longer to turn on or off the M-B EX mode.

Names of the Buttons and Their Functions

[FNC] button

- Press the button to turn on the power.
- Press and hold the button for 1second or longer to turn off the power.

- Switch the operation mode among the Radio mode, etc.

Major Button Operations When External Equipment is Connected to This Unit

● When the CD/DVD changer is connected

- * For details, see the section "CD changer operations". For the DVD changer, refer to the Owner's Manual provided with the DVD changer.

[DISP] button

- When the button is pressed and held, switches the user titles or track titles, etc. while in the CD changer mode.

[T] button

- Use the button to input a title in the CD changer mode.
- Use the button to scroll the title during CD-text play.

[UP], [DN] buttons

- Select the disc.

[RDM] button

- Perform random play. Also perform disc random play when the button is pressed and held.

[RPT] button

- Perform repeat play. When this button is pressed and held, disc repeat play is performed.

[SCN] button

- Perform scan play for 10 seconds of each track. Disc scan play is performed when the button is pressed and held.

[▶||] button

- Play or pause a CD or DVD.

[◀], [▶] buttons

- Select a track when listening to a disc.
- Press and hold the button for 1 second or longer to switch the fast-forward/fast-backward.

[BND] button

- Move the next disc in increasing order.

● When the TV/DAB is connected

- * For details, see the section "TV operations" or "DAB operations".

[AF] button

- Press the button to turn on or off the AF (Alternative Frequency) function in the DAB mode. (This function is only DAB tuner.)
- Press and hold for 1 second or longer to turn on or off the REG mode. (This function is only DAB tuner.)

[TA] button

- Use the button to set the TA (Traffic Announcement) standby mode in the DAB and TV tuner mode.
- Press and hold for 1 second or longer to turn on or off the INFO mode. (This function is only DAB tuner.)

[P/A] button

- Perform preset scan while in the TV mode.
- When the button is pressed and held, auto store is performed. (This function is only TV tuner.)
- Perform service scan while in the DAB mode.

[DIRECT] buttons

- Store a station into memory or recall it directly.

[▶||] button

- Use the button to set the PTY (Programme Type) standby mode or PTY items in the DAB mode.
- Switch the TV picture mode or VTR (external) picture mode.

[◀], [▶] buttons

- Select a station.

[BND] button

- Switch the band.
- When the button is pressed and held, switch seek tuning or manual mode.

4. DCP

The control panel can be detached to prevent theft. When detaching the control panel, store it in the DCP (DETACHABLE CONTROL PANEL) case to prevent scratches.

We recommend taking the DCP with you when leaving the car.

Removing the DCP

1. Press the [FNC] button for 1 second or longer to switch off the power.
2. Press in the [RELEASE] button.

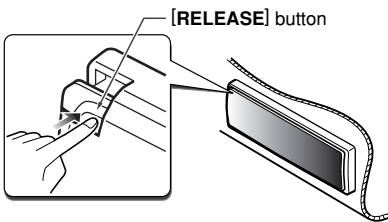

* The DCP is unlocked

3. Remove the DCP.

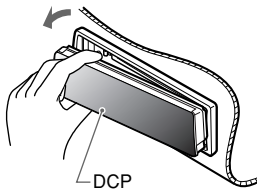

Attaching the DCP

1. Insert the right side of the DCP into the main unit.
2. Insert the left side of the DCP into the main unit.

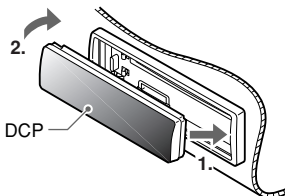

Storing the DCP in the DCP Case

Hold the DCP, in the orientation as shown in the figure below, and put it into the supplied DCP case. (Ensure the DCP is in the correct orientation.)

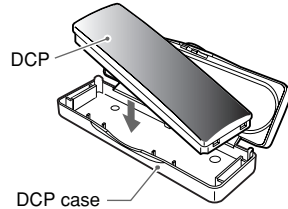

⚠ CAUTION

- The DCP can easily be damaged by shocks. After removing it, be careful not to drop it or subject it to strong shocks.
- When the Release button is pressed and the DCP is unlocked, the car's vibrations may cause it to fall. To prevent damage to the DCP, always store it in its case after detaching it. (see figure below.)
- The connector connecting the main unit and the DCP is an extremely important part. Be careful not to damage it by pressing on it with fingernails, screwdrivers, etc.

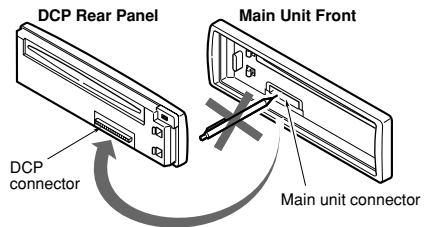

Note:

- If the DCP is dirty, wipe off the dirt with a soft, dry cloth only.

5. REMOTE CONTROL (Optional)

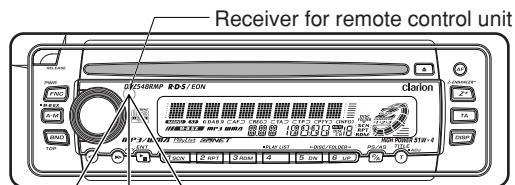

Receiver for remote control unit

If you buy the RCB-164 sold separately, you can enjoy the use of the Remote Control function.

Operating range: 30° in all directions

Signal transmitter

Remote control unit

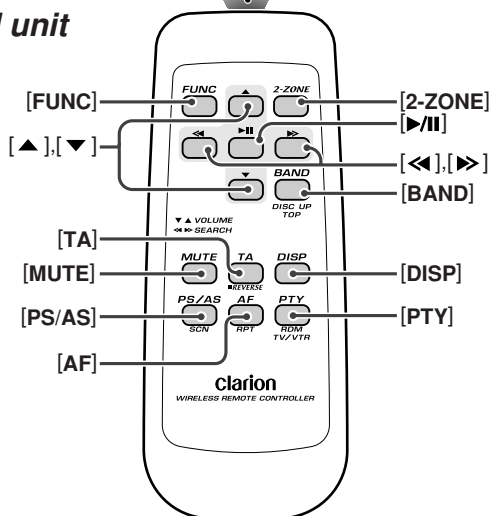

Inserting the Batteries

1. Turn the remote control unit over, then slide the rear cover in the direction of the arrow.
2. Insert the AA (SUM-3, IECR-6/1.5V) batteries that came with the remote control unit facing in the directions shown in the figure, then close the rear cover.

Notes:

Using batteries improperly can cause them to explode. Take note of the following points:

- When replacing batteries, replace both batteries with new ones.
- Do not short-circuit, disassemble or heat batteries.
- Do not dispose of batteries into fire or flames.
- Dispose of spent batteries properly.

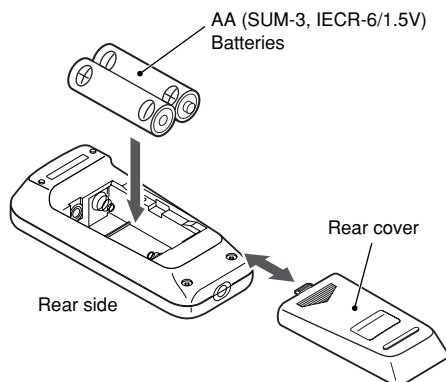

Functions of Remote Control Unit Buttons

Mode Button	Radio (RDS) /DAB	CD/MP3/WMA	CD changer DVD changer	TV
[FUNC]	Switches among radio, DAB, CD/MP3/WMA, CD changer, DVD changer, TV.			
[BAND]	Switches reception band.	Plays the first track while in the CD mode. Top play. Plays the first track of a current folder in the MP3/WMA mode.	Moves the next disc in increasing order.	Switches reception band.
[▲], [▼]	Increases and decreases volume (in all modes).			
[◀], [▶]	Moves preset channels up and down.	Moves tracks up and down. When pressed and held for 1 second or longer: Fast-forward/fast-backward.		Moves preset channels up and down.
[▶/II]	No function.	Switches between playback and pause.		No function.
[MUTE]	Turns mute on and off.			
[TA]	TA on and off.			
[DISP]	Switches among main display, clock (CT) display.			
[PS/AS]	Preset scan. When pressed and held for 2 seconds or longer: Auto store.	Scan play. Press and hold the button for 1 second or longer to perform folder scan play while in the MP3/WMA mode.	Scan play. When pressed and held for 1 second or longer: Disc scan play.	Preset scan. When pressed and held for 2 seconds or longer: Auto store.
[AF]	AF function on and off. When pressed and held for 1 second or longer: REG function on and off	Repeat play. Press and hold the button for 1 second or longer to perform folder repeat play while in the MP3/WMA mode.	Repeat play. When pressed and held for 1 second or longer: Disc repeat play.	No function.
[PTY]	PTY mode on and off.	Random play. Press and hold the button for 1 second or longer to perform folder random play while in the MP3/WMA mode.	Random play. When pressed and held for 1 second or longer: Disc random play.	Switches between TV and VTR.

- * Some of the corresponding buttons on the main unit and remote control unit have different functions.
- * [2-ZONE] button is not available.

6. OPERATIONS

Basic Operations

Note: Be sure to read this chapter referring to the front diagrams of chapter "2. CONTROLS" on page 5 (unfold).

⚠ CAUTION

Be sure to lower the volume before switching off the unit power or the ignition key. The unit remembers its last volume setting. If you switch the power off with the volume up, when you switch the power back on, the sudden loud volume may hurt your hearing and damage the unit.

Turning on/off the power

Note:

• Be careful about using this unit for a long time without running the engine. If you drain the car's battery too far, you may not be able to start the engine and this can reduce the service life of the battery.

1. Press the [FNC] button.
2. The illumination and display on the unit light up. The unit automatically remembers its last operation mode and will automatically switch to display that mode.
3. Press and hold the [FNC] button for 1 second or longer to turn off the power for the unit.

Note:

• System check

The first time this unit is turned on after the wire connections are completed, it must be checked what equipment is connected. When the power is turned on, "SYSTEM CHK" and "Push POWER" appear in the display alternately, so press the [FNC] button. The system check starts within the unit. When the system check is complete, press the [FNC] button again.

Selecting a mode

1. Press the [FNC] button to change the operation mode.
2. Each time you press the [FNC] button, the operation mode changes in the following order:
Radio mode → DAB mode → CD/MP3/WMA mode → CD changer mode → DVD changer mode → TV mode → Radio mode...
* External equipment not connected with CeNET is not displayed.

Adjusting the volume

Turning the [ROTARY] knob clockwise increases the volume; turning it counterclockwise decreases the volume.

* The volume level is from 0 (minimum) to 33 (maximum).

Switching the display

Press the [DISP] button to select the desired display.

Each time you press the [DISP] button, the display switches in the following order:

Main display → Clock (CT) display → Main display

- * Once selected, the preferred display becomes the display default. When a function adjustment such as volume is made, the screen will momentarily switch to that function's display, then revert back to the preferred display several seconds after the adjustment.
- * For information on how to enter a title, refer to the subsection "Entering titles" in section "Operations Common to Each Mode".
- * When CT data is not received, "CT—:—" appears in the display.

Setting the Z-Enhancer Plus

This unit are provided with 4 types of sound tone effects stored in memory. Select the one you prefer.

* The factory default setting is "Z+ OFF".

Each time you press the [Z+] button, the tone effect changes in the following order:

"Z+ OFF" → "BASS BOOST" → "IMPACT" → "EXCITE" → "CUSTOM" → "Z+ OFF" ...

- BASS BOOST : bass emphasized
- IMPACT : bass and treble emphasized
- EXCITE : bass and treble emphasized mid de-emphasized
- CUSTOM : user custom
- Z+ OFF : no sound effect

Adjusting the tone

Press the [A-M] button and select the item to adjust. Each time you press the [A-M] button, the item changes as following order:

- When “BASS BOOST” is set
“B-BOOST 0” → “BAL 0” → “FADER 0” → Last function mode.
- When “IMPACT” is set
“IMPACT 0” → “BAL 0” → “FADER 0” → Last function mode.
- When “EXCITE” is set
“EXCITE 0” → “BAL 0” → “FADER 0” → Last function mode.
- When “CUSTOM” is set
“BASS” → “TREBLE” → “BAL 0” → “FADER 0” → Last function mode.
- When “Z+ OFF” is set
“BAL 0” → “FADER 0” → Last function mode.

Adjusting the bass (Gain, Frequency, Q-curve)

This adjustment can be performed when the Z-Enhancer Plus is set to “CUSTOM”.

1. Press the [A-M] button and select “BASS”.
2. Turning the [ROTARY] knob clockwise emphasizes the bass; turning it counterclockwise attenuates the bass.
* The factory default setting is “B◀GAIN 0”. (Adjustment range: -6 to +8)
3. Press the [◀◀] or [▶▶] button to select “B◀FREQ 50”.
Turning the [ROTARY] knob clockwise or counterclockwise to select the frequency.
* The factory default setting is “B◀FREQ 50”. (Adjustment 50/80/120 Hz)
4. Press the [◀◀] or [▶▶] button to select “B◀Q 1”.
Turning the [ROTARY] knob clockwise or counterclockwise to select the Q-curve.
* The factory default setting is “B◀Q 1”. (Adjustment 1/1.25/1.5/2)
5. When the adjustment is complete, press the [A-M] button several times until the function mode is reached.

Adjusting the treble (Gain, Frequency)

This adjustment can be performed when the Z-Enhancer Plus is set to “CUSTOM”.

1. Press the [A-M] button and select “TREBLE”.
2. Turning the [ROTARY] knob clockwise emphasizes the treble; turning it counterclockwise attenuates the treble.
* The factory default setting is “T◀GAIN 0”. (Adjustment range: -6 to +6)
3. Press the [◀◀] or [▶▶] button to select “T◀FREQ 12k”.
Turning the [ROTARY] knob clockwise or counterclockwise to select the frequency.
* The factory default setting is “T◀FREQ 12k”. (Adjustment 8 kHz/12 kHz)
4. When the adjustment is complete, press the [A-M] button several times until the function mode is reached.

Adjusting the balance

1. Press the [A-M] button and select “BAL 0”.
2. Turning the [ROTARY] knob clockwise emphasizes the sound from the right speaker; turning it counterclockwise emphasizes the sound from the left speaker.
* The factory default setting is “BAL 0”. (Adjustment range: L13 to R13)
3. When the adjustment is complete, press the [A-M] button several times until the function mode is reached.

Adjusting the fader

1. Press the [A-M] button and select “FADER 0”.
2. Turning the [ROTARY] knob clockwise emphasizes the sound from the front speakers; turning it counterclockwise emphasizes the sound from the rear speakers.
* The factory default setting is “FADER 0”. (Adjustment range: F12 to R12)
3. When the adjustment is complete, press the [A-M] button several times until the function mode is reached.

Basic Operations

Adjusting the Z-Enhancer Plus

1. Press the **[Z+]** button and select the Z-Enhancer Plus mode to adjust.
 2. Press the **[A-M]** button and turning the **[ROTARY]** knob clockwise adjusts in the + direction; tuning it counterclockwise adjusts in the - direction.
 - When "**B-BOOST 0**" selected, you can adjust the bass in the range of -3 to 3.
 - When "**IMPACT 0**" selected, you can adjust the bass and treble in the range of -3 to 3.
 - When "**EXCITE 0**" selected, you can adjust the bass and treble in the range of -3 to 3.
- * When Z-Enhancer Plus is selected, press and hold the **[Z+]** button for 1 seconds or longer to change to the "**CUSTOM**" mode.
- Bass/treble characteristics become flat and the indication "**Z+ FLAT**" is shown in the display.
- Press the **[Z+]** button again to change to the "**Z+ OFF**" mode.

Adjusting MAGNA BASS EXTEND

The MAGNA BASS EXTEND does not adjust the low sound area like the normal sound adjustment function, but emphasizes the deep bass sound area to provide you with a dynamic sound.

1. Press and hold the **[A-M]** button for 1 second or longer to turn on the MAGNA BASS EXTEND effect. "**M-B EX**" lights in the display.
2. Press and hold the **[A-M]** button for 1 second or longer to turn off the MAGNA BASS EXTEND effect. "**M-B EX**" goes off in the display.
 - * The factory default setting is off.

CT (Clock Time) function

The CT function receives CT data sent from an RDS station and displays the time. Press the **[DISP]** button to switch to the CT display.

* If a CT data is not being received, "**CT—:—**" appears in the display.

Note:

• CT data is not transmitted in some countries and by some broadcast stations. Also, in some areas, the CT may not display accurately.

Radio Operations

Listening to the radio

1. Press the **[FNC]** button and select the radio mode. The frequency or PS appears in the display.
 - * PS: Programme service name
2. Press the **[BND]** button and select the radio band. Each time the button is pressed, the radio reception band changes in the following order:
FM1 → FM2 → FM3 → AM (MW/LW) → FM1...
3. Press the **[◀]** or **[▶]** button to tune in the desired station.

Tuning

There are 3 types of tuning mode available, seek tuning, manual tuning and preset tuning.

Seek tuning

There are 2 types of seek tuning: DX SEEK and LOCAL SEEK.

DX SEEK can automatically tune in to receivable broadcast stations; LOCAL SEEK can tune in to only broadcast stations with a good reception sensitivity.

1. Press the **[BND]** button and select the desired band (FM or AM (MW, LW)).
2. Tune into a station.
 - * If "**MANU**" is lit in the display, press and hold the **[BND]** button for 1 second or longer. "**MANU**" in the display goes off and seek tuning is now available.
 - * If "**TA**" is lit in the display, TP stations are automatically sought.

● DX SEEK

Press the **[◀]** or **[▶]** button to automatically seek a station.

When the **[▶]** button is pressed, the station is sought in the direction of higher frequencies; if the **[◀]** button is pressed, the station is sought in the direction of lower frequencies.

* When seek tuning starts, "**DX SEEK**" appears in the display.

● LOCAL SEEK

If you press and hold the **[◀]** or **[▶]** button for 1 second or longer, local seek tuning is carried out. Broadcast stations with good reception sensitivity are selected.

* When local seeking starts, "**LO SEEK**" appears in the display.

Manual tuning

There are 2 ways available: Quick tuning and step tuning.

When you are in the step tuning mode, the frequency changes one step at a time. In the quick tuning mode, you can quickly tune the desired frequency.

1. Press the **[BND]** button and select the desired band (FM or AM (MW/LW)).
 - * If "MANU" is not lit in the display, press and hold the **[BND]** button for 1 second or longer. "MANU" is lit in the display and manual tuning is now available.
2. Tune into a station.

● Quick tuning:

Press and hold the **[◀◀]** or **[▶▶]** button for 1 second or longer to tune in a station.

● Step tuning:

Press the **[◀◀]** or **[▶▶]** button to manually tune in a station.

- * If no operation is performed for more than 7 seconds, manual tuning is cancelled and the display returns to the previous mode.

Recalling a preset station

A total of 24 preset positions (6-FM1, 6-FM2, 6-FM3, 6-AM) exists to store individual radio stations in memory. Pressing the corresponding **[DIRECT]** button recalls the stored radio frequency automatically.

1. Press the **[BND]** button and select the desired band (FM or AM (MW/LW)).
2. Press the corresponding **[DIRECT]** button to recall the stored station.
 - * Press and hold one of the **[DIRECT]** buttons for 2 seconds or longer to store that station into preset memory.

Manual memory

1. Select the desired station with seek tuning, manual tuning or preset tuning.
2. Press and hold one of the **[DIRECT]** buttons for 2 seconds or longer to store the current station into preset memory.

Auto store

Auto store is a function for storing up to 6 stations that are automatically tuned in sequentially. If 6 receivable stations cannot be received, a previously stored station remains unoverwritten at the memory position.

1. Press the **[BND]** button and select the desired band (FM or AM (MW/LW)).
2. Press and hold the **[P/A]** button for 2 seconds or longer. The stations with good reception are stored automatically to the preset channels.
 - * If auto store is performed in the FM bands, the stations are stored in FM3 even if FM1 or FM2 was chosen for storing stations.

Preset scan

Preset scan receives the stations stored in preset memory in order. This function is useful when searching for a desired station in memory.

1. Press the **[P/A]** button.
2. When a desired station is tuned in, press the **[P/A]** button again to continue receiving that station.

Note:

- Be careful not to press and hold the **[P/A]** button for 2 seconds or longer, otherwise the auto store function is engaged and the unit starts storing stations.

RDS Operations

RDS (Radio Data System)

This unit has a built-in RDS decoder system that supports broadcast stations transmitting RDS data.

This system can display the name of the broadcast station being received (PS) and can automatically switch to the broadcast station with the best reception as you move long distances (AF switching).

Also, if a traffic announcement or programme type is broadcast from an RDS station, no matter what mode you are in, this broadcast is received.

Additionally, if EON information is received, this information enables automatic switching of other preset stations on the same network and interruption of the station being received with traffic information from other stations (TP). This function is not available in some areas.

When using the RDS function, always set the radio to FM mode.

- AF : Alternative Frequency
 - PS : Programme Service Name
 - PTY : Programme Type
 - EON : Enhanced Other Network
 - TP : Traffic Programme
- * RDS interrupt does not function during AM radio reception or in TV mode.
- * When set receives RDS signal, and can read PS data, PS appears in the display.

AF function

The AF function switches to a different frequency on the same network in order to maintain optimum reception.

* The factory default setting is "ON".

● Switching OFF the AF function

Press the [AF] button. "AF" in the display goes off and the AF function turns off.

● Switching ON the AF function

Press the [AF] button. "AF" in the display lights and the AF function turns on.

* If the reception of the current broadcast station deteriorates, "PI SEARCH" appears in the display and the radio searches for the same programme on another frequency.

● AF function between RDS and DAB

When the same programme is broadcasted by both RDS and DAB, and this function is ON, the unit switches to receive the broadcast with the better reception automatically.

- * This function only operates when the DAH923, DAH913 DAB unit, sold separately, is connected.
- * This factory default setting is "ON".

1. Press and hold the [T] button for 1 second or longer to switch to the adjustment selection display.
2. Turning the [◀] or [▶] button to select "LINK ACT".
3. Turn the [ROTARY] knob clockwise for "LNK -ACT ON" or counterclockwise for "LNK -ACT OFF".
 - ON: AF switching between DAB and RDS enabled.
 - OFF: AF switching between DAB and RDS disabled.
4. Press the [T] button to return to the previous mode.

REG (Regional programme) function

When the REG function is ON, the optimum regional station can be received. When this function is OFF, if the regional station area switches as you drive, a regional station for that region is received.

* The factory default setting is "OFF".

Notes:

- This function is disabled when a national station such as BBC R2 is being received.
- The REG function ON/OFF setting is valid when the AF function is ON.

● Switching the REG function ON

Press and hold the [AF] button for 1 second or longer.

"REG" in the display lights and the REG function turns on.

● Switching the REG function OFF

Press and hold the [AF] button for 1 second or longer.

"REG" in the display goes off and the REG function turns off.

Manually tuning a regional station in the same network

1. This function is valid when the AF function is ON and the REG function is OFF.

Note:

- This function can be used when a regional broadcast of the same network is received.
2. Press any one of the [DIRECT] buttons to call out the regional station.
 3. If the reception condition of the called out station is bad, press the [DIRECT] button of the same number. The unit receives a local station on the same network.

TA (Traffic Announcement)

In the TA standby mode, when a traffic announcement broadcast starts, the traffic announcement broadcast is received as top priority regardless of the function mode so you can listen to it. Traffic programme (TP) automatic tuning is also possible.

* This function can only be used when "TP" is lit in the display. When "TP" is lit, this means that the RDS broadcast station being received has traffic announcement programmes.

● Setting the TA standby mode

If you press the [TA] button when only "TP" is lit in the display, "TP" and "TA" light in the display and the unit is set into the TA standby mode until a traffic announcement is broadcast. When a traffic announcement broadcast starts, "TRA INFO" appears in the display. If you press the [TA] button while a traffic announcement broadcast is being received, the traffic announcement broadcast reception is cancelled and the unit goes into the TA standby mode.

● Cancelling the TA standby mode

As "TP" and "TA" lit in the display, press the [TA] button. The "TA" in the display goes off and the TA standby mode is cancelled.

* If "TP" is not lit, pressing the [TA] button searches for a TP station.

● Searching for a TP station

When "TP" is not lit, if you press the [TA] button, "TA" in the display lights and the unit automatically receives a TP station.

Note:

• If a TP station is not received, the unit continues the search operation. Pressing [TA] button again goes off "TA" in the display and stops TP station searching.

Auto store function for TP stations

You can automatically store up to 6 TP stations into preset memory. If the number of TP can be received less than 6, broadcast stations already stored in memory and left without being overwritten.

As "TA" lit in the display, press and hold the [P/A] button for 2 seconds or longer. The TP stations with the good reception sensitivity are stored into preset memory.

* Even if you select FM1 or FM2, a TP station is stored into memory for FM3.

PTY

This function enables you to listen to a broadcast of the selected programme type even if the unit is on a function mode other than radio.

- * Some countries do not yet have PTY broadcast.
- * In the TA standby mode, a TP station has priority over a PTY broadcast station.

● Setting the PTY standby mode

When you press the [▶||] button, "PTY" lights in the display and the PTY standby mode is turned on. When the selected PTY broadcast starts, the PTY item name appears in the display.

● Cancelling the PTY standby mode

When you press and hold the [▶||] button for 1 second or longer, "PTY" goes off in the display and PTY standby mode is cancelled.

● Cancelling a PTY interrupt broadcast

Press the [▶||] button during the PTY interrupt broadcast, the PTY interrupt is cancelled and the unit returns to PTY standby mode.

Selecting PTY

1. When you press the [▶||] button, the unit goes into PTY select mode.
2. Press any one of the [DIRECT] buttons. Alternatively, turning the [ROTARY] knob clockwise or counterclockwise to select the desired PTY.

* Below are the factory default settings stored for the [DIRECT] buttons.

Preset number	PTY item	
	ENGLISH	Contents
1	News	News
2	Info	Information
3	Pop M	Pop Music
4	Sport	Sport
5	Classics	Serious Classical Music
6	Easy M	Easy Listening Music

3. The PTY select mode is cancelled automatically 7 seconds after a PTY is selected.

PTY seek

1. When you press the [▶||] button, the PTY select mode is turned on.
2. Select PTY.
3. Press the [◀] or [▶] button. If you press the [▶] button, the unit seeks a PTY broadcast moving up the frequencies; if you press the [◀] button, it seeks moving down the frequencies.

* If no station with the selected PTY broadcast can be received, the unit returns to the previous mode.

PTY preset memory

1. When you press the [▶|||] button, the PTY select mode is turned on.
2. Turning the [ROTARY] knob clockwise or counterclockwise to select the desired PTY.

The 29 types of PTY below can be selected.

3. If you press and hold any one of the [DIRECT] buttons for 2 seconds or longer, the selected PTY is stored into that preset channel memory.

PTY item				
ENGLISH	DEUTSCH	SVENSKA	FRANCAIS	Contents
News	Nachricht	Nyheter	Infos	News
Affairs	Aktuell	Aktuellt	Magazine	Today's events
Info	Service	Info	Services	Information
Sport	Sport	Sport	Sport	Sports
Educate	Bildung	Utbildn	Educatif	Education
Drama	Hör + Lit	Teater	Fiction	Drama
Culture	Kultur	Kultur	Culture	Culture
Science	Wissen	Vetenskap	Sciences	Science
Varied	Unterh	Underh	Divers	Variety
Pop M	Pop	Pop	M Pop	Pop music
Rock M	Rock	Rock	M Rock	Rock music
Easy M	U-Musik	Lättylss	Chansons	Easy music
Light M	L-Musik	L klass	M Cl Lég	Light music
Classics	E-Musik	Klassisk	Classiq	Classics
Other M	- - Musik	Övrig m	Autre M	Other music
Weather	Wetter	Väder	Météo	Weather
Finance	Wirtsch	Ekonomi	Economie	Finance
Children	Kinder	För barn	Enfants	For children
Social	Soziales	Socialt	Société	Social
Religion	Religion	Andligt	Religion	Religion
Phone In	Anruf	Telefon	Forum	Phone in
Travel	Reise	Resor	Voyages	Travel
Leisure	Freizeit	Fritid	Loisirs	Leisure
Jazz	Jazz	Jazz	Jazz	Jazz
Country	Country	Country	Country	Country
Nation M	Landes M	Nation m	Ch pays	Nation music
Oldies	Oldies	Oldies	Rétro	Oldies
Folk M	Folklore	Folk m	Folklore	Folk music
Document	Feature	Dokument	Document	Documentaries

Emergency broadcast

If an emergency broadcast is received, all the function mode operations are stopped. "ALARM" appears in the display and the emergency broadcast can be heard.

● Cancelling an emergency broadcast

If you press the [AF] button, emergency broadcast reception is cancelled.

Switching the PTY display language

You can select one of 4 languages (English, German, Swedish or French) for the PTY displayed in the display.

* The factory default setting is "ENGLISH".

1. Press and hold the [T] button for 1 second or longer to switch to the adjustment selection display.
2. Press the [◀◀] or [▶▶] button and select "LANGUAGE .
3. Press the [▶▶] button
4. Turning the [ROTARY] knob clockwise or counterclockwise to select the desired language.
5. Press the [▶▶] button
6. Press the [T] button to return to the previous mode.

Volume setting of TA, emergency broadcast (ALARM) and PTY

The volume for TA, ALARM and PTY interrupts can be set during TA, ALARM or PTY interrupt.

* The factory default setting is "15".

During a TA, ALARM or PTY interrupt, turning the [ROTARY] knob clockwise or counterclockwise to set the volume to the desired level (0 to 33).

* When the TA, ALARM or PTY interrupt ends, the volume returns to the level it had before the interrupt.

MP3/WMA

What is MP3?

MP3 is an audio compression method and classified into audio layer 3 of MPEG standards. This audio compression method has penetrated into PC users and become a standard format.

This MP3 features the original audio data compression to about 10 percent of its initial size with a high sound quality. This means that about 10 music CDs can be recorded on a CD-R disc or CD-RW disc to allow a long listening time without having to change CDs.

What is WMA?

WMA is the abbreviation of Windows Media Audio, an audio file format developed by Microsoft Corporation.

Notes:

- If you play a file with DRM (Digital Rights Management) for WMA remaining ON, no audio is output. (The WMA indicator blinks.)
- Windows Media™, and the Windows® logo are trademarks, or registered trademarks of Microsoft Corporation in the United States and/or other countries.

● To disable DRM (Digital Rights Management):

1. When using Windows Media Player 8, click on TOOLS → OPTIONS → COPY MUSIC tab, then under COPY SETTINGS, unclick the check box for PROTECT CONTENT. Then, reconstruct files.
2. When using Windows Media Player 9, click on TOOL → OPTIONS → MUSIC RECORD tab, then under Recording settings, unclick the Check box for RECORD PROTECTED MUSIC. Then, reconstruct files.
Personally constructed WMA files are used at your own responsibility.

Precautions when creating MP3/WMA disc

● Usable sampling rates and bit rates:

1. MP3: Sampling rate 11.025k Hz-48 kHz,
Bit rate: 8 kbps-320 kbps / VBR
2. WMA: Bit rate 48 kbps-192 kbps

● File extensions

1. Always add a file extension ".MP3" or ".WMA" to MP3 or WMA file by using single byte letters. If you add a file extension other than specified or forget to add the file extension, the file cannot be played.

CD/MP3/WMA Operations

- Files without MP3/WMA data will not play. The indication “—:—” appears in the play time display if you attempt to play files without MP3/WMA data.

● Logical format (File system)

- When writing MP3/WMA file on a CD-R disc or CD-RW disc, please select “ISO9660 level 1, 2 or JOLIET or Romeo” as the writing software format. Normal play may not be possible if the disc is recorded on another format.
- The folder name and file name can be displayed as the title during MP3/WMA play but the title must be within 128 single byte alphabetical letters and numerals (including an extension).
- Do not affix a name to a file inside a folder having the same name.

● Folder structure

- A disc with a folder having more than 8 hierarchical levels will be impossible.

● Number of files or folders

- Up to 255 files can be recognized per folder. Up to 500 files can be played.
- Tracks are played in the order that they were recorded onto a disc. (Tracks might not always be played in the order displayed on the PC.)
- Some noise may occur depending on the type of encoder software used while recording.

Multisession function

When a disc contains both normal CD type tracks and MP3/WMA type tracks mixedly, you can select which type of the recorded tracks to play.

● Default value is “CD”.

Each time you press and hold the [BND] button for 1 second or longer, the mixed mode is switched between CD type or MP3/WMA type. The following indication appears in the title display when switching the track type to be played.

● Display when CD type track is selected:

M-SESS CD



● Display when MP3/WMA type track is selected:

M-SESS MP3

- Types of recording that can be played are as follows.

Disc \ Setting	Set to CD	Set to MP3/WMA
Mixed with CD and MP3/WMA type tracks	Play CD	Play MP3/WMA
CD type track only	Play CD	Play CD
MP3/WMA type track only	Play MP3/WMA	Play MP3/WMA

- After making these settings, remove the disc and then reinsert it.
- When a mixed mode CD is loaded and CD is set, the track to be played first is MP3/WMA file data and no sound is heard.

Notes:

- When playing a CCCD (Copy Control CD), set the setting to CD type. When this is set to MP3/WMA type, the CD cannot be played normally in some cases.

Backup Eject function

Just pressing the [▲] button ejects the disc even if the power to the unit was not turned on.

- Press the [▲] button. Remove the disc after it is ejected.

Notes:

- If you force a CD into before auto reloading, this can damage the CD.
- If a CD (12 cm) is left in the ejected position for 15 seconds, the CD is automatically reloaded. (Auto reload).
- 8 cm CDs are not auto reloaded. Be sure to remove it when ejected.

Listening to a disc already loaded in the unit

Press the [FNC] button to select the CD/MP3/WMA mode.

When the unit enters the CD/MP3/WMA mode, play starts automatically.

If there is no disc loaded, the indication “NO DISC” appears in the title display.

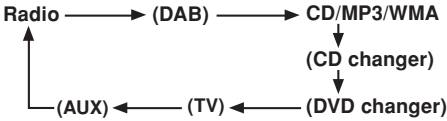

* The mode changes each time the [FNC] button is pressed. (Modes are not displayed for equipment that is not connected.)



Loading a CD

1. Insert a CD into the center of the CD SLOT with the labeled side facing up. The CD plays automatically after loading.

Notes:

- Never insert foreign objects into the CD SLOT.
- If the CD is not inserted easily, there may be another CD in the mechanism or the unit may require service.
- Discs not bearing the  or  mark and CD-ROMs cannot be played by this unit.
- Some CDs recorded in CD-R/CD-RW mode may not be usable.

Loading 8 cm compact discs

- * No adapter is required to play an 8 cm CD.
- * Insert the 8 cm CD into the center of the insertion slot.

Pausing play

1. Press the [▶||] button to pause play. "PAUSE" appears in the display.
2. To resume CD play, press the [▶||] button again.

Displaying CD titles

This unit can display title data for CD-text/MP3/WMA disc and user titles input with this unit.

1. Press the [DISP] button to display the title.
2. Each time you press and hold the [DISP] button for 1 second or longer, the title display changes in the following order:

● CD-TEXT disc

User title (disc) → CD-text title (disc) → Artist name → CD-text title (track) → User title (disc)...

● MP3/WMA disc

Folder → File → Album TAG → Artist TAG → Title TAG → Folder...

Note:

- If the CD playing is not a CD-text CD or no user title has been input, "NO TITLE" appears in the display.
- If MP3/WMA disc is not input TAG, "NO TAG" appears in the display.
- For MP3, supports ID3 Tags V2.3 / 2.2 / 1.1 / 1.0.
- Tag displays give priority to V2.3 / 2.2.
- In the case of album Tags for WMA, the information written into the extension header is displayed.
- Only ASCII characters can be displayed in Tags.

Selecting a track

● Track-up

1. Press the [▶▶] button to move ahead to the beginning of the next track.
2. Each time you press the [▶▶] button, the track advances ahead to the beginning of the next track.

● Track-down

1. Press the [◀◀] button to move back to the beginning of the current track.
2. Press the [◀◀] button twice to move to the beginning of the previous track.

Fast-forward/fast-backward

● Fast-forward

Press and hold the [▶▶] button for 1 second or longer.

● Fast-backward

Press and hold the [◀◀] button for 1 second or longer.

- * For MP3/WMA discs, it takes some time until the start of searching and between tracks. In addition, the playing time may have a margin of error.

CD/MP3/WMA Operations

Folder Select

This function allows you to select a folder containing MP3/WMA files and start playing from the first track in the folder.

1. Press the **[DN]** or **[UP]** button.

Press the **[DN]** button move to the previous play list.

Press the **[UP]** button move to the next play list.

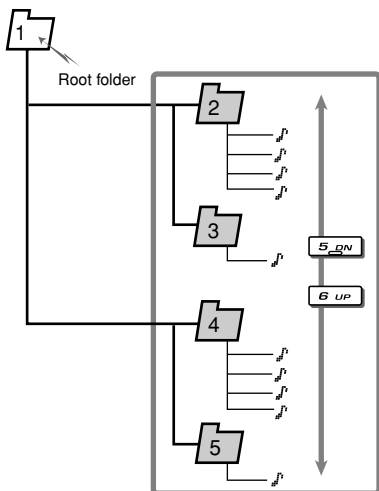

* Press the **[UP]** button while in the final folder to shift to the first folder.

* Folder without an MP3/WMA file is not selectable.

2. To select a track, press the **[◀◀]** or **[▶▶]** of button.

Top function

The top function resets the CD player to the first track of the disc. Press the **[BND]** button to play the first track (track No. 1) on the disc.

* In case of MP3/WMA, the first track of a folder being played will be returned.

Scan play

This function allows you to locate and play the first 10 seconds of all the tracks recorded on a disc.

1. Press the **[SCN]** button to perform scan play.

The indication “**SCN**” lights up in the display, and “**TRK SCAN**” (or “**J-SCAN**” when searching for a track in the MP3/WMA file) appears in the title display for about 2 seconds, then scan play starts.

* Scan play starts from the next track after the track currently being played.

2. To cancel scan play, press the **[SCN]** button again.

The play status indication such as “**SCN**” disappears from the display and the current track continues to play.

Folder scan play

This function allows you to locate and play the first 10 seconds of the first track of all the folders on an MP3/WMA disc.

1. Press and hold the **[SCN]** button for 1 second or longer to perform folder scan play.

The indications “**FOLDER**” and “**SCN**” light up in the display and “**■-SCAN**” appears for about 2 seconds in the title display, and then folder scan play starts.

* Folder scan play starts from the next track after the track currently being played.

2. To cancel folder scan play, press the **[SCN]** button again.

The play status indications such as “**FOLDER**” and “**SCN**” disappear from the display and the current track continues to play.

Repeat play

This function allows you to play the current track repeatedly.

1. Press the **[RPT]** button to perform repeat play.

The indication “**RPT**” lights up in the display and “**TRK REPEAT**” (or “**J-REPEAT**” when performing repeated play for a track in the MP3/WMA file) appears for about 2 seconds in the title display, and then repeat play starts.

2. To cancel repeat play, press the **[RPT]** button again.

The play status display such as “**RPT**” disappears from the display and normal play resumes from the track currently being played.

Folder repeat play

This function allows you to play a track currently being played in the MP3/WMA folder repeatedly.

1. Press and hold the [RPT] button for 1 second or longer to perform folder repeat play.

The indications "FOLDER" and "RPT" light up in the display and "■-REPEAT" appears for about 2 seconds in the title display, and then folder repeat play starts.

2. To cancel folder repeat play, press the [RPT] button again.

The play status indications such "FOLDER" and "RPT" disappear from the display and normal play resumes from the track currently being played.

Random play

This function allows you to play all tracks recorded on a disc in a random order.

1. Press the [RDM] button to perform random play.

The indication "RDM" lights up in the display and "TRK RANDOM" (or "■-RANDOM" when performing random play for tracks on a MP3/WMA disc) appears in the title display for about 2 seconds, and then random play starts. The tracks on the disc are then played in a random order.

2. To cancel random play, press the [RDM] button again.

The play status indication such as "RDM" disappears from the display and normal play resumes from the track currently being played.

Folder random play

This function allows you to play all the tracks of all the folders recorded on an MP3/WMA disc in a random order.

1. Press and hold the [RDM] button for 1 second or longer to perform folder random play.

The indications "FOLDER" and "RDM" light up in the display and "■-RANDOM" appear in the title display for about 2 seconds, and then folder random play starts.

2. To cancel folder random play, press the [RDM] button again.

The play status indications such as "FOLDER" and "RDM" disappear from the display and normal play resumes from the track currently being played.

Play list mode

This function allows you to play tracks, up to latest 5 time stamps, by reading the play list information written on the disc.

1. Press and hold the [PLAY LIST] button for 1 second or longer to turn on or off the play list mode.

- * Play list play is possible only when there is a file whose extension is ".M3U" on the CD-R/RW.

- * Up to 5 play lists can be recognized, and up to 255 files can be recognized per play list.

2. Press the [◀] or [▶] button to change the track.

3. Press the [DN] button to move to the previous play list.

Press the [UP] button to move to the next play list.

Notes:

- The SCN/RPT/RDM functions cannot be used while in the play list mode.
- The title display changes from folder name to play list name.

Making a play list

1. Write desired tracks to a CD-R/RW, etc. Be sure to use alphanumeric/ASCII characters for all file names.
2. Make a play list by using a multimedia player, etc. and save the data. The file format must be M3U.
3. Again, write this play list to the CD-R/RW, etc.

Notes:

- When writing to a CD-R/RW, etc., be sure to use alphanumeric/ASCII characters.
- Up to 5 layers can be recognized as a list. For written play lists, latest 5 lists are recognized in the order in which they are written.
- When writing to a CD-R/RW, etc., turn off the Disc At Once function.
- When adding a play list, it is recommended to write it in the "Root" folder.

Operations Common to Each Mode

Turning the screen saver function on or off

This unit is provided with the screen saver function which allows you to show various kinds of patterns and characters in the Operation Status indication area of the display in a random order. You can turn on and off this function.

If the button operation is performed with the screen saver function on, the operation display corresponding to the button operation is shown for about 30 seconds and the display returns to the screen saver display.

* The factory default setting is "SS ON".

1. Press and hold the [T] button for 1 second or longer to switch to the adjustment selection display.
2. Press the [◀] or [▶] button and select "SCRN SVR .
3. Press the [▶||] button and turning the [ROTARY] knob clockwise or counterclockwise to select the setting. Each time you turn the [ROTARY] knob, the setting changes in the following order:
SS OFF → SS ON → SS MESSAGE.
4. Press the [▶||] button to store the setting.
5. Press the [T] button to return to the previous mode.

Entering MESSAGE INFORMATION

Message up to 30 characters long can be stored in memory and displayed as a type of screen saver setting.

* The factory default setting is "Welcome to Clarion".

1. Press and hold the [T] button for 1 second or longer to switch to the adjustment selection display.
2. Press the [◀] or [▶] button and select "MSG INPUT .
3. Press the [▶||] button.
4. Press the [◀] or [▶] button to move the cursor.
5. Press the [DISP] button to select a character. Each time you press the [DISP] button, the character changes in the following orders:
Capital letters → Small letters → Numbers/ Symbols → Umlaut → Capital letters...
6. Turning the [ROTARY] knob to select the desired character.

7. Repeat step 4 to 6 to enter up to 30 characters for message.
8. Press and hold the [▶||] button for 2 seconds or longer to store the message in memory and cancel input message mode.
 - * Press the [BND] button can cancel the input message. Then press and hold the [▶||] button for 2 seconds or longer to store the message and the message return to default setting.
9. Press the [T] button to return to the previous mode.

Message display

When the unit is powered on or off, a message is displayed. The user can turn this message display ON or OFF.

* The factory default setting is "MESSAGE ON".

1. Press and hold the [T] button for 1 second or longer to switch to the adjustment selection display.
2. Press the [◀] or [▶] button to select "MESSAGE".
3. Turning the [ROTARY] knob clockwise or counterclockwise to set the message display ON or OFF.
4. Press the [T] button to return to the previous mode.

Setting the method for title scroll

Set how to scroll in CD-TEXT, MP3/WMA TITLE.

* The factory default setting is "SCROLL ON".

1. Press and hold the [T] button for 1 second or longer to switch to the adjustment selection display.
2. Press the [◀] or [▶] button and select "AUTO SCRL".
3. Turn the [ROTARY] knob clockwise or counterclockwise and select "SCROLL ON" or "SCROLL OFF".
 - **SCROLL ON:**
To scroll automatically.
 - **SCROLL OFF:**
To scroll just 1 time when the title was changed or the title key was pressed.
4. Press the [T] button to return to the previous mode.

Dimmer control

You can setting the dimmer control "DIMMER ON" or "DIMMER OFF".

* The factory default setting is "DIMMER ON".

1. Press and hold the [T] button for 1 second or longer to switch to the adjustment selection display.
2. Press the [◀] or [▶] button to select "DIMMER".
3. Turning the [ROTARY] knob clockwise or counterclockwise and select "DIMMER ON" or "DIMMER OFF".
4. Press the [T] button to return to the previous mode.

Selecting the CONTRAST mode

* The factory default setting is "CONTRAST 8".

1. Press and hold the button [T] for 1 second or longer to switch to the adjustment selection display.
2. Press the [◀] or [▶] button to select "CONTRAST".
3. Turning the [ROTARY] knob to select from 1-16.
4. Press the [T] button to return to the previous mode.

Setting the car speaker output for the cellular phone (Optional TEL-002)

* The factory default setting is "T-SP RIGHT".

* To output the telephone calls, set the cellular phone interrupt to ON.

1. Press and hold the [T] button for 1 second or longer to switch to the adjustment selection display.
2. Press the [◀] or [▶] button to select "TEL-SP".
3. Turning the [ROTARY] knob clockwise to select "T-SP RIGHT" or counterclockwise to select "T-SP LEFT".

● T-SP RIGHT:

Telephone calls can be heard on the front right speaker connected to this unit.

● T-SP LEFT:

Telephone calls can be heard on the front left speaker connected to this unit.

4. Press the [T] button to return to the previous mode.

Cellular phone interrupt setting

If you connect this unit and your cellular phone with a separately sold unit (TEL-002), you can listen to your telephone calls on your car speakers.

* The factory default setting is "T-SW OFF".

1. Press and hold the [T] button for 1 second or longer to switch to the adjustment selection display.
2. Press the [◀] or [▶] button to select "TEL-SWITCH".
3. Turning the [ROTARY] knob clockwise or counterclockwise to select the setting. Each time you turning the [ROTARY] knob, the setting changes in the following order:

T-SW OFF → T-SW ON → T-SW MUTE → T-SW OFF...

● T-SW OFF:

This unit continues normal operation even when the cellular phone is used.

Note:

• If connecting a hands-free kit, please ensure the setting is ON to receive the telephone audio through the system.

● T-SW ON:

You can listen to your telephone calls from the speakers connected to this unit.

* When listening to your calls on your car speakers, you can adjust the volume by turning the [ROTARY] knob.

● T-SW MUTE:

The sound from this unit is muted during telephone calls.

4. Press the [T] button to return to the previous mode.

Operations Common to Each Mode

Entering titles

Titles up to 10 characters long can be stored in memory and displayed for CD, CD changer and TV stations. The number of titles that can be entered for each mode are as follows.

Mode	Number of titles
CD mode	50 titles
TV mode	20 titles

CD changer mode	Number of titles
DCZ628 connected	100 titles
CDC655Tz connected	100 titles
CDC1255z connected	50 titles

1. Press the **[FNC]** button to select the mode you want to enter a title (CD, CD changer or TV).
2. Select and play a CD in the CD changer or tune in to a TV station for which you want to enter the title.
3. Press the **[DISP]** button and display the main.
4. Press the **[T]** button.
5. Press the **[◀◀]** or **[▶▶]** button to move the cursor.
6. Press the **[DISP]** button to select a character. Each time you press the **[DISP]** button, the character changes in the following order:
Capital letters → Small letters → Numbers/
Symbols → Umlaut → Capital letters...
7. Turning the **[ROTARY]** knob to select the desired character.
8. Repeat steps 5 to 7 to enter up to 10 characters for the title.
9. Press and hold the **[▶▶▶]** button for 2 seconds or longer to store the title into memory and cancel title input mode.

Clearing titles

1. Select and play a CD in the CD changer or tune in to a TV station for which you want to clear the title.
2. Press the **[DISP]** button and display the main.
3. Press the **[T]** button and switch the display to the title input display.
4. Press the **[BND]** button.
5. Press and hold the **[▶▶▶]** button for 2 seconds or longer to clear the title and cancel title input mode.

7. OPERATIONS OF ACCESSORIES

CD Changer Operations

CD changer functions

When an optional CD changer is connected through the CeNET cable, this unit controls all CD changer functions. This unit can control a total of 2 changers.

Press the **[FNC]** button and select the CD changer mode to start play. If 2 CD changers are connected, press the **[FNC]** button to select the CD changer for play.

* If **"NO MAG"** appears in the display, insert the magazine into the CD changer. **"DISC CHECK"** appears in the display while the player loads (checks) the magazine.

* If **"NO DISC"** appears in the display, eject the magazine and insert discs into each slot. Then, reinsert the magazine back into the CD changer.

Note:

• Some CDs recorded in CD-R/CD-RW mode may not be usable.

⚠ CAUTION

CD-ROM discs cannot be played from every CD changer, it's depended on the model.

Pausing play

1. Press the **[▶||]** button to pause play. **"PAUSE"** appears in the display.
2. To resume play, press the **[▶||]** button again.

Displaying CD titles

This unit can display title data for CD-text CDs and user titles input with this unit.

* Title data for CD-text CDs can be displayed with this unit only when it is connected to CDC655Tz.

● When connected to DCZ628 or CDC1255z.

Press the **[DISP]** button to display the title.

● When connected to CDC655Tz

1. Press the **[DISP]** button to display the title.
2. Each time you press and hold the **[DISP]** button for 1 second or longer, the title display changes in the following order:
User title (disc) → CD-text title (disc) → Artist name → CD-text title (track) → User title (disc)...

Notes:

- If the CD playing is not a CD-text CD or no user title has been input, **"NO TITLE"** appears in the display.
- If a CD-text CD is not input its disc title or a track title, **"NO TITLE"** appears in the display.

Procedure to scroll a title

Set **"SCROLL"** to **"ON"** or **"OFF"**.

(The factory default setting is **"ON"**. Refer to the subsection **"Turning the screen saver function on or off"** in section **"Operation common to each mode"**.)

● When set to "ON"

The title is automatically kept scrolling.

● When set to "OFF"

To scroll just 1 time when the title was changed or the **[T]** button was pressed.

Selecting a CD

Press the **[DN]** or the **[UP]** button to select the desired disc.

* If a CD is not loaded in a slot of magazine, pressing the **[UP]** or the **[DN]** button cannot work.

Selecting a track

● Track-up

1. Press the **[▶▶]** button to move ahead to the beginning of the next track.
2. Each time you press the **[▶▶]** button, the track advances ahead to the beginning of the next track.

● Track-down

1. Press the **[◀◀]** button to move back to the beginning of the current track.
2. Press the **[◀◀]** button twice to move to the beginning of the previous track.

Fast-forward/fast-backward

● Fast-forward

Press and hold the **[▶▶]** button for 1 second or longer.

● Fast-backward

Press and hold the **[◀◀]** button for 1 second or longer.

CD Changer Operations

Scan play

Scan play locates and plays the first 10 seconds of each track on a disc automatically. This function continues on the disc until it is cancelled.

* The scan play is useful when you want to select a desired track.

1. Press the **[SCN]** button to start track scanning. "SCN" lights in the display.
2. To cancel the scan play, press the **[SCN]** button again. "SCN" goes off from the display and the current track continues to play.

Disc scan play

Disc scan play locates and plays the first 10 seconds of the first track on each disc in the currently selected CD changer. This function continues automatically until it is cancelled.

* Disc scan play is useful when you want to select a desired CD.

1. Press and hold the **[SCN]** button for 1 second or longer. "DISC" and "SCN" light in the display and disc scan play starts.
2. To cancel disc scan play, press the **[SCN]** button again. "DISC" and "SCN" go off from the display and the current track continues to play.

Repeat play

Repeat play continuously plays the current track. This function continues automatically until it is cancelled.

1. Press the **[RPT]** button. "RPT" lights in the display and the current track is repeated.
2. To cancel repeat play, press the **[RPT]** button again. "RPT" goes off from the display and normal play resumes.

Disc repeat play

After all the tracks on the current disc have been played, disc repeat play automatically replays the current disc over from the first track. This function continues automatically until it is cancelled.

1. Press and hold the **[RPT]** button for 1 second or longer. "DISC" and "RPT" light in the display and disc repeat play starts.
2. To cancel disc repeat play, press the **[RPT]** button again. "DISC" and "RPT" go off from the display and normal play resumes on the current track.

Random play

Random play selects and plays individual tracks on the disc in no particular order. This function continues automatically until it is cancelled.

1. Press the **[RDM]** button. "RDM" lights in the display and random play begins.
2. To cancel random play, press the **[RDM]** button again. "RDM" goes off from the display and normal play resumes.

Disc random play

The disc random play selects and plays individual tracks or discs automatically in no particular order. This function continues automatically until it is cancelled.

1. Press and hold the **[RDM]** button for 1 second or longer. "DISC" and "RDM" light in the display and disc random play starts.
2. To cancel disc random play, press the **[RDM]** button again. "DISC" and "RDM" go off from the display and normal play resumes from the current track.

TV Operations

TV tuner functions

When an optional TV tuner is connected through the CeNET cable, this unit controls all TV tuner functions. To watch TV requires a TV tuner and monitor.

Watching a TV

1. Press the **[FNC]** button and select the TV mode.
2. Press the **[BND]** button to select the desired TV band (TV1 or TV2). Each time the button is pressed, the input selection toggles between TV1 and TV2.
3. Press the **[◀▶]** or **[▶▶]** button to tune in the desired TV station.

Watching a video

The TV tuner has a VTR input terminal to which 1 external device can be connected. Connect a 12 V video cassette player (VCP) or video cassette recorder (VCR) to the TV tuner input terminal.

1. Press the **[▶|||]** button to select VTR.
2. To return to the TV broadcast, press the **[▶|||]** button.

Tuning

There are 3 types of tuning mode available, Seek tuning, manual tuning and preset tuning.

Seek tuning

1. Press the **[BND]** button and select the desired TV band (TV1 or TV2).
 - * If "MANU" is lit in the display, press and hold the **[BND]** button for 1 second or longer. "MANU" in the display goes off and seek tuning is now available.
2. Press the **[◀▶]** or **[▶▶]** button to automatically seek a station. Press the **[▶▶]** button to automatically tune up the frequency band to the next available TV station; press the **[◀▶]** button to automatically tune down.

Manual tuning

There are 2 ways available: Quick tuning and step tuning.

When you are in the step tuning mode, the frequency changes one step at a time. In the quick tuning mode, you can quickly tune the desired frequency.

1. Press the **[BND]** button and select the desired band (TV1 or TV2).
 - * If "MANU" is not lit in the display, press and hold the **[BND]** button for 1 second or longer. "MANU" lights in the display and manual tuning is now available.

2. Tune into a station.

● Quick tuning:

Press and hold the **[◀▶]** or **[▶▶]** button for 1 second or longer to tune in a station.

● Step tuning:

Press the **[◀▶]** or **[▶▶]** button to manually tune in a station.

* If no operation is performed for more than 7 seconds, manual tuning is cancelled and the display returns to the previous mode.

Recalling a preset station

A total of 12 TV stations can be stored (6-TV1 and 6-TV2). This allows you to select your favorite TV stations and store them in memory for later recall.

1. Press the **[BND]** button and select the desired TV band (TV1 or TV2).
2. To recall a stored TV station, press the desired **[DIRECT]** button to select that station.
 - * Press and hold one of the **[DIRECT]** buttons for 2 seconds or longer to store the current station into preset memory.

Manual memory

1. Select the desired station with seek tuning, manual tuning or preset tuning.
2. Press and hold one of **[DIRECT]** buttons for 2 seconds or longer to store the current station into preset memory.

Auto store

Auto store selects 6 TV stations automatically and stores each one into preset memory.

If there are not 6 stations with good reception, stations previously stored in memory remain and only the strong stations are stored into memory.

1. Press the **[BND]** button and select the desired TV band (TV1 or TV2).

TV Operations

- Press and hold the [P/A] button for 2 seconds or longer. The stations with good reception are stored automatically to the preset channels.

Preset scan

Preset scan allows the user to view each preset position before it automatically advances to the next preset. This function is useful for searching for a desired TV station in memory.

- Press the [P/A] button.
- When the desired station is found, press the [P/A] button again to remain tuned to that station.

Note:

- Do not press and hold the [P/A] button for 2 seconds or longer. Doing so will trigger the auto store function and start storing stations into memory.

Setting the TV area

When you select the TV area (TV reception area), the TV tuner area setting changes.

- Press and hold the [T] button for 1 second or longer to switch to the adjustment selection display.
- Press the [◀] or [▶] button to select "TV AREA .
- Press the [▶||] button.
- Turning the [ROTARY] knob clockwise or counterclockwise to select the reception area.
- Press the [▶||] button.
- Press the [T] button to return to the previous mode.

Setting the TV diver

You can change the reception setting for the TV antenna connected to the TV tuner.

- Press and hold the [T] button for 1 second or longer to switch to the adjustment selection display.
- Press the [◀] or [▶] button to select "TV DIVER".
- Turning the [ROTARY] knob clockwise to set to "DIVER ON" or counterclockwise to set to "DIVER OFF".

● DIVER OFF:

Sets the diver setting to OFF.

● DIVER ON:

Sets the diver setting to ON.

- Press the [T] button to return to the previous mode.

Digital Radio / DAB Operations

DAB control function

When a CeNET cable is used to connect a DAB (DAH913 or DAH923) (sold separately), all functions can be operated.

Listening to the DAB station

- Press the [FNC] button to select the DAB mode.
- When the unit receives a DAB station, the display changes in the following order:
Frequency channel → service label

Switching displays

- Press the [DISP] button to select the desired display.
- Each time you press the [DISP] button, the display switches in the following order:
S-LABL ↔ PTY

Notes:

- The display shown in the normal reception mode and the preset reception mode is the same when a DAB station is received.
- The number of programmes and broadcasting times depend on the DAB stations.
- When the strength of DAB signals is weak, audio output is muted.

Seek tuning

- Press the [FNC] button to select the DAB mode.
- Press and hold the [◀] or [▶] button for 1 second or longer.

"DAB" lights up in the display when the main unit receives a DAB station.

- The main unit stops the seek tuning when it cannot find a DAB station. The display returns to the previous mode.

Manual tuning

- Press the [FNC] button to select the DAB mode.
- Press and hold the [BND] button for 1 second or longer. "MANU" lights up in the display.
- Press the [◀] or [▶] button to select a station.

- If no operation is performed for more than 7 seconds, manual tuning is cancelled and the display returns to the previous mode.

Switching programmes

1. Press the **[FNC]** button to receive a DAB station.
2. Press the **[◀]** or **[▶]** button to switch programmes in the DAB station.

Note:

- The programme name may be the same depending on DAB programmes.

Programme scan

This function scans through each receivable programme in a DAB station being received for 10 seconds sequentially. This is useful when you want to search for a desired programme.

1. Press the **[FNC]** button to receive a DAB station.
2. Perform the following operation depending on the connected model.
Press the **[P/A]** button. “**SERVICE SC**” lights up and the unit starts scanning each programme for 10 seconds sequentially. Each time the main unit scans, the programme name is shown in the display.
3. To stop programme scan when a desired programme is tuned in.
Press the **[P/A]** button.

Manual memory

The main unit has a manual memory function for DAB programmes. Up to 18 programmes (6 programmes each) can be preset in the preset buttons.

[M1], [M2] and [M3]

1. Press the **[FNC]** button to select the DAB mode.
2. Press the **[BND]** button to select any one shown above.
3. Press the **[◀]** or **[▶]** button to select a desired programme.
4. Press and hold one of the **[DIRECT]** buttons (1 to 6) for 2 seconds or longer to store the programme.

Note:

- The interrupt programme (PTY or INFO) cannot be written into a manual memory.

Recalling a preset programme

1. Press the **[FNC]** button to select the DAB mode.
2. Press the **[BND]** button. Each time you press the **[BND]** button, the display changes in the following order:
[M1] → [M2] → [M3] → [M1]...
3. Press one of the **[DIRECT]** buttons to recall a preset programme.

Note:

- Press and hold the **[DIRECT]** button for 2 seconds or longer to store the programme currently being received. (Manual memory)

AF function

The AF function switches to a different frequency on the same network in order to maintain optimum reception.

- * The factory default setting is “**ON**”
- * If the reception of the current broadcast station deteriorates, “**Sld SEARCH**” appears in the display and the radio searches for the same programme on another frequency.
- * For details on “**AF function**”, refer to the section “**RDS operation**” of each owner’s manual.

● Switching OFF the AF function

● Switching ON the AF function

● AF function between RDS and DAB

When the same programme is broadcast by both RDS and DAB, and this function is ON, the main unit switches to receiving the broadcast with the better reception automatically.

TA (Traffic Announcement)

In the TA standby mode, when a traffic announcement broadcast starts, the traffic announcement broadcast is received as top priority regardless of the function mode. Traffic programme (TP) automatic tuning is also possible.

- * This function can only be used when “**TP**” is lit in the display. When “**TP**” is lit, this means that the DAB or RDS broadcast station being received has traffic announcement programmes.
- * For details on “**TA**”, refer to the section “**RDS operation**” of each owner’s manual.

● Setting the TA standby mode

● Cancelling the TA standby mode

● Searching for a TP station

Notes:

- If a TP station is not received, the main unit stops the search operation.
- "TP" may be lit in the display when a TP broadcast is transmitted from an RDS station. In this case, press the [TA] button to perform TP seek tuning. Press the [TA] button again to return to the previous mode.

INFO (Announcement)

In the INFO standby mode, when the selected announcement programme starts, the main unit switches to the selected announcement programme automatically.

● Setting the INFO standby mode

If you press and hold the [TA] button for 1 second or longer, "INFO" lights in the display and the main unit is set into the INFO standby mode until the selected announcement is broadcast. When the selected announcement broadcast starts, the announcement item appears in the display. If you press and hold the [TA] button for 1 second or longer while the selected announcement broadcast is being received, the selected announcement broadcast reception is cancelled and the main unit goes into the INFO standby mode.

● Cancelling INFO standby mode

To cancel the INFO standby mode, press and hold the [TA] button for 1 second or longer.

● Information select

This is a function for selecting INFORMATION ON or OFF in the Information interrupt mode. You can set ON up to 6 information items.

You can select any of the 6 items below:

INFORMATION item	
ENGLISH	Contents
Travel	Transport flash
Warning	Warning / Service
News	News flash
Weather	Area weather flash
Event	Event announcement
Special	Special event

1. Perform the following operation depending on the connected model.
Press and hold the [T] button for 1 second or longer.
2. Press the [◀] or [▶] button to select "INFO SEL E", then press the [▶] button to enter "INFO SEL E" mode.
3. Press the [◀] or [▶] button to select an information item. You can select any of 6 items:
Travel → Warning → News → Weather → Event → Special → Travel → ...
4. Turning the [ROTARY] knob clockwise or counterclockwise to set the information item for ON or OFF.
5. Press the [▶] button to store the setting.
6. Press the [T] button to return to the previous display.

PTY

This function enables you to listen to the selected programme type, irrespective of the function mode.

- * One common PTY can be selected for DAB or RDS.
- * Of DAB PTY and RDS PTY, the PTY which is received earlier takes priority over the other.
- * PTY broadcasts are not yet available in all countries.
- * In the INFO standby mode, INFO stations have priority over PTY stations.
- * In the TA standby mode, TP stations have priority over PTY stations.
- * For details on "PTY", refer to the section "RDS operation" of each owner's manual.

● Setting the PTY standby mode**● Cancelling the PTY standby mode****● Cancelling a PTY interrupt broadcast****● Selecting PTY****● PTY seek****● PTY preset memory****Emergency broadcast**

When an emergency broadcast is received, all the function mode operations are stopped. "ALARM" appears in the display and the emergency broadcast can be heard.

- * For details on "Emergency broadcast", refer to the section "RDS operation" of each owner's manual.

● Cancelling an emergency broadcast

Switching the PTY and INFO display language

You can select one of 4 languages (English, German, Swedish or French) for the PTY and INFO shown in the display.

- * The factory default setting is "ENGLISH".
- * For details on "Switching the PTY display language", refer to the section "RDS operation" of each owner's manual.

Volume setting of TA, INFO, emergency broadcast (ALARM) and PTY

The volume for TA, INFO, ALARM and PTY interrupts can be set during TA, INFO, ALARM and PTY interrupt. Perform the following operation depending on the connected model.

- * The factory default setting is "15".

During a TA, INFO, ALARM or PTY interrupt, turning the [ROTARY] knob clockwise or counterclockwise to set the volume to a desired level (0 to 33).

- * When the TA, INFO, ALARM or PTY interrupt ends, the volume returns to the level it had before the interrupt.

8. IN CASE OF DIFFICULTY

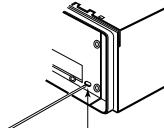
	Problem	Cause	Measure
General	Power does not turn on. (No sound is produced.)	Fuse is blown.	Replace with a fuse of the same amperage. If the fuse blows again, consult your store of purchase.
		Incorrect wiring.	Consult your store of purchase.
	No sound output when operating the unit with amplifiers or power antenna attached.	Power antenna lead is shorted to ground or excessive current is required for remote-on the amplifiers or power antenna.	<ol style="list-style-type: none"> 1. Turn the unit off. 2. Remove all wires attached to the power antenna lead. Check each wire for a possible short to ground using an ohm meter. 3. Turn the unit back on. 4. Reconnect each amplifier remote wire to the power antenna lead one by one. If the amplifiers turn off before all wires are attached, use an external relay to provide remote-on voltage (excessive current required).
	Nothing happens when buttons are pressed. Display is not accurate.	The microprocessor has malfunctioned due to noise, etc.	Turn off the power, then press the [RELEASE] button and remove the DCP. Press the reset button for about 2 seconds with a thin rod. <div style="text-align: right;">  <p>Reset button</p> </div>
		DCP or main unit connectors are dirty.	Wipe the dirt off with a soft cloth moistened with cleaning alcohol.
No sound heard.	The speaker protection circuit is operating.	<ol style="list-style-type: none"> 1. Turn down sound volume. Function can also be restored by turning the power off and on again. (Speaker volume is reduced automatically when the speaker protection circuit operates). 2. If the sound is muted again, consult our service department. 	
CD/MP3/WMA	No sound heard.	MP3/WMA files are absent in a disc.	Write MP3/WMA files onto the disc properly.
		Files are not recognized as an MP3/WMA file.	Use MP3/WMA files encoded properly.
		File system is not correct.	Use ISO9660 level 1, 2 or JOLIET or Romeo file system.
	Sound skips or is noisy.	Disc is dirty.	Clean the disc with a soft cloth.
		Disc is heavily scratched or warped.	Replace with a disc with no scratches.
Sound is cut or skipped. Noise is generated or noise is mixed with sound.	MP3/WMA files are not encoded properly.	Use MP3/WMA files encoded properly.	

	Problem	Cause	Measure
CD/MP3/WMA	Sound is bad directly after power is turned on.	Water droplets may form on the internal lens when the car is parked in a humid place.	Let dry for about 1 hour with the power on.
	Wrong filename	File system is not correct.	Use ISO9660 level 1, 2 or JOLIET or Romeo file system.
	Play list play is not performed.	File name or extension is not correct.	Use alphanumeric/ASCII characters for MP3/WMA file name. Use ".M3U" for the file extension of a play list.

9. ERROR DISPLAYS

If an error occurs, one of the following displays is displayed.
Take the measures described below to eliminate the problem.

	Error Display	Cause	Measure
CD/MP3/WMA	ERROR 2	A DISC is caught inside the CD deck and is not ejected.	This is a failure of CD deck's mechanism and consult your store of purchase.
	ERROR 3	A DISC cannot be played due to scratches, etc.	Replace with a non-scratched, non-warped-disc.
	ERROR 6	A DISC is loaded upside-down inside the CD deck and does not play.	Eject the disc then reload it properly.
CD changer	ERROR 2	A CD inside the CD changer is not loaded.	This is a failure of CD changer's mechanism and consult your store of purchase.
	ERROR 3	A CD inside the CD changer cannot be played due to scratches, etc.	Replace with a non-scratched, non-warped disc.
	ERROR 6	A CD inside the CD changer cannot be played because it is loaded upside-down.	Eject the disc then reload it properly.
DVD changer	ERROR 2	A DISC inside the DVD changer cannot be played.	This is a failure of DVD mechanism and consult your store of purchase.
	ERROR 3	A DISC cannot be played due to scratches, etc.	Retry or replace with a non-scratched, non-warped-disc.
	ERROR 6	A DISC inside the DVD changer cannot be played because it is loaded upside-down.	Eject the disc then reload it properly
	ERROR P	Parental level error.	Set the correct Parental level.
	ERROR R	Region code error.	Eject the disc and replace correct region code disc.
General	AMP GUARD	The speaker protection circuit is operating. During this operation, if any volume operation is performed, the display shows "AMP GUARD".	<ol style="list-style-type: none"> 1. Turn down sound volume. Function can also be restored by turning the power off and on again. (Speaker volume is reduced automatically when the speaker protection circuit operates). 2. If the sound is muted again, consult our service department.

If an error display other than the ones described above appears, press the reset button. If the problem persists, turn off the power and consult your store of purchase.

10. SPECIFICATIONS

Radio section

Tuning System: PLL synthesizer tuner

Receiving Frequencies:

FM : 87.5 to 108 MHz (0.05 MHz steps)

MW : 531 to 1602 kHz (9 kHz steps)

LW : 153 to 279 kHz (3 kHz steps)

CD player section

System: Compact disc digital audio system

Frequency Response: 5 Hz to 20 kHz (± 1 dB)

Signal to Noise Ratio: 100 dB (1 kHz)

Dynamic Range: 95 dB (1 kHz)

Distortion: 0.01%

General

Output Power: 4×27 W (DIN 45324, +B=14.4V)

Power Supply Voltage:

14.4 V DC (10.8 to 15.6 V allowable),
negative ground

Power Consumption: Less than 15 A

Speaker Impedance: 4Ω (4 to 8Ω allowable)

Auto Antenna Rated Current: 500 mA or less

Weight:

Main unit: 1.3 kg

Dimensions:

Main unit :

178 (W) \times 50 (H) \times 155 (D) mm

Note:

- *Specifications and design are subject to change without notice for further improvement.*

Free Manuals Download Website

<http://myh66.com>

<http://usermanuals.us>

<http://www.somanuals.com>

<http://www.4manuals.cc>

<http://www.manual-lib.com>

<http://www.404manual.com>

<http://www.luxmanual.com>

<http://aubethermostatmanual.com>

Golf course search by state

<http://golfingnear.com>

Email search by domain

<http://emailbydomain.com>

Auto manuals search

<http://auto.somanuals.com>

TV manuals search

<http://tv.somanuals.com>