



52" VideoWall
Digital Light Processing™
Display
WN-5230-S

User's
Guide
070-0037-00

© 1999 by Clarity Visual Systems[®], Inc.
All Rights Reserved.

Contents of this publication may not be reproduced in any form without permission of Clarity Visual Systems, Inc.

Trademark Credits

Macintosh is a registered trademark of Apple Computer Corp.

IBM is a registered trademark of International Business Machines, Inc.

BlackScreen[™] is a trademark of Jenmar Visual Systems.

Windows is a trademark of Microsoft Corp.

Digital Light Processing[™] (DLP[™]) by Texas Instruments

All other names are trademarks or registered trademarks of their respective companies.

Disclaimer

The information contained in this document is subject to change without notice.

Clarity Visual Systems Company makes no warranty of any kind with regard to this material. While every precaution has been taken in the preparation of this manual, Clarity Visual Systems shall not be liable for errors or omissions contained herein or for incidental or consequential damages in connection with the furnishing, performance, or use of this material.

LIMITED WARRANTY. Clarity warrants to Buyer that the WN-5230-S (the "Product"), if properly used and serviced, will perform substantially in accordance with the product data sheet and users manual, and will be free from defects in material and workmanship for 1 year following date of shipment. This warranty does not apply to lamps (see following section for lamp warranty) and other consumable parts.

The main illumination lamp is considered a consumable and is warranted against failure for 30 days from the date of installation or first day of rental. The replacement of other consumable parts are the Buyer's responsibility.

If any Product fails to conform to the written warranty, Clarity's exclusive liability and Buyer's exclusive remedy will be, at Clarity's option, to repair, replace or credit Buyer's account with an amount equal to the price paid for any such defective Product returned by Buyer during the warranty period, provided that: (a) Buyer promptly notifies Clarity in writing that such Product failed to conform, furnishes an explanation of any alleged deficiency and obtains from Clarity a return authorization; and (b) Clarity is satisfied that claimed deficiencies actually exist and were not caused by accident, misuse, neglect, alteration, improper installation, repair or improper testing. Clarity will have a reasonable time to make repairs, to replace Products or to credit Buyer's account.

LIMITATIONS. ANY WRITTEN WARRANTY OFFERED BY CLARITY IS IN LIEU OF ALL OTHER WARRANTIES, EXPRESS OR IMPLIED. CLARITY NEITHER ASSUMES NOR AUTHORIZES ANY OTHER PERSON TO ASSUME ANY OTHER LIABILITIES IN CONNECTION WITH THE SALES OR USE OF ANY PRODUCT WITHOUT LIMITATION. CLARITY DISCLAIMS ALL OTHER WARRANTIES, EXPRESS OR IMPLIED, INCLUDING ANY WARRANTY OF MERCHANTABILITY OR FITNESS FOR A PARTICULAR.

IN NO EVENT WILL CLARITY BE LIABLE TO BUYER OR ANY OTHER PARTY FOR PROCUREMENT COSTS, LOSS OF PROFITS, LOSS OF USE, OR FOR ANY OTHER INCIDENTAL, CONSEQUENTIAL, INDIRECT OR SPECIAL DAMAGES OR FOR CONTRIBUTION OR INDEMNITY CLAIMS, HOWEVER CAUSED. CLARITY'S LIABILITY SHALL BE LIMITED TO ACTUAL DIRECT DAMAGES NOT IN EXCESS OF THE AMOUNTS PAID TO CLARITY BY BUYER FOR THE PRODUCT. THESE LIMITATIONS WILL APPLY TO ALL CLAIMS, INCLUDING, WITHOUT LIMITATION, WARRANTY, CONTRACT, INDEMNITY, TORT (INCLUDING NEGLIGENCE), STRICT LIABILITY OR OTHERWISE.

Table of Contents

PRODUCT INTRODUCTION	1
INTRODUCTION	1
FEATURES	1
OPTIONS AND ACCESSORIES	2
SAFETY	3
QUICK START	8
SITE PREPARATION	10
POWER	10
Power Consumption	11
Voltage Range	11
TEMPERATURE AND HUMIDITY	12
FLOORING	12
CLEARANCE	12
CABLES AND SIGNALS	13
OPTICAL ALIGNMENT	14
ADJUSTING THE IMAGE	17
Keystone, top wider	18
Keystone, bottom wider	18
Keystone, left side wider	18
Keystone, right side wider	18
Rotation, clockwise	18
Rotation, counterclockwise	18
Size	19
Up, down, right, left	19
ADJUSTMENT SUMMARY	20
Rotation	20
Keystone	20
Size –	20
(Retighten LD1 and LD2.)	20
Final Position –	20
MECHANICAL SETUP	22
MECHANICAL SETUP, STANDARD SCREEN	22
MECHANICAL SETUP, ULTRA-THIN MULLION OR BLACKSCREEN	24
Basic Steps for Alignment	25
Alignment Procedure in Detail	25
OPERATION	32
STEP 1 – POWER-ON	32
STEP 2 - ADJUST THE INPUT SIGNAL SETTINGS	33
INPUT LEVEL	35

Adjust the Black Input Level - PC, MAC or RGBS Data.....	36
Adjust the White Input Level - PC, MAC or RGBS Data.....	37
Comp Video/S-Video Level Adjustment.....	38
Set the Sharpness.....	41
Adjust the Frequency.....	42
Adjust the Phase.....	43
Position the Image.....	44
Zoom.....	45
STEP 3 - ADJUST THE COLORS.....	46
STEP 4 – SAVE, RECALL, OR RESET THE SETTINGS.....	50
TURNING OFF THE SYSTEM.....	52
Turning off the Display, Entering Standby Mode.....	52
Turning off the Main Power Switch.....	52
CLARITY'S BIG PICTURE™	54
LOOP-THRU OF SOURCE VIDEO.....	57
INSTALLING BIG PICTURE OPTION KEY.....	59
OTHER FEATURES AND ADJUSTMENTS	60
CURTAIN.....	60
MONITOR SELECT.....	61
ID.....	61
MISCELLANEOUS CONTROLS.....	62
Reset Lamp Hours.....	64
ABOUT.....	65
CLEANING AND MAINTENANCE	66
LAMP.....	66
LAMP REPLACEMENT, FRONT, STANDARD MULLION SCREENS.....	67
Removing a Standard Screen Using the Screen Removal Tool.....	68
LAMP REPLACEMENT, REAR ACCESS, ANY SCREEN TYPE.....	69
AIR FILTER.....	70
Air Filter Replacement, Front Access.....	70
Air Filter Replacement, Rear Access.....	71
CLEANING THE SCREEN AND MIRRORS.....	71
TROUBLESHOOTING	72
POWER AND START-UP PROBLEMS.....	72
IMAGE PROBLEMS.....	76
TECHNICAL SUPPORT	78
CONNECTOR PINOUTS	80
RGBS.....	80
MAC.....	81
PC & LOOP-THRU.....	81
RS-232 IN.....	82
RS-232 OUT.....	82
S-VIDEO.....	83
INTERFACE AND CONTROLS	84
REAR PANEL INDICATORS, CONNECTORS AND CONTROLS.....	84
Rear Panel Indicators.....	84
Rear Panel Connectors.....	86
Rear Panel Controls.....	87
REMOTE-CONTROL.....	87
Remote Control Functions.....	87
ON-SCREEN MENUS AND MESSAGES.....	89
MENUS.....	91

RS-232 CONTROL	98
RS-232 CONTROL ITEMS	101
SPECIFICATIONS	106
OPTICAL.....	106
MECHANICAL	107
ENVIRONMENTAL	108
PICTURE CONTROL.....	108
ELECTRICAL	109
REGULATORY INFORMATION.....	110
DECLARATION OF CONFORMITY	110
FCC REGULATIONS	111
OTHER CERTIFICATIONS.....	111
INDEX	112

Product Introduction

Introduction

The WN-5230-S is a 52-inch (132 cm) diagonal 800 x 600 (SVGA) resolution rear-projection display system designed around Texas Instruments' proprietary Digital Light Processing™ (DLP)™ technology. The display features low power consumption, long lamp life and excellent focus and geometry with a sharp true-to-life color spectrum.

The display utilizes the same modular form factor as the company's other award winning, VideoWall display products, while providing the benefits of DLP technology. The WN-5230-S offers consistent color and brightness uniformity across the high-contrast screen, and doesn't have the color drift, image retention, or convergence problems associated with CRT based rear-projection systems.

The WN-5230-S provides the same high image quality, reliability, light weight and brightness levels typical of Clarity display products.

Features

- optical resolution of 800x600 pixels
- low 160 watt power consumption
- long 8,000 hour average lamp life
- superior image quality (even in high ambient light conditions)
- light weight – 120 pounds (55 kg)
- thin – 30.6 inches (77.7 cm)
- improved brightness uniformity (no “hot spots”)
- consistent colors displayed on adjacent modules
- no color drifting
- no convergence problems

Options and Accessories

Clarity's display products can be upgraded with several accessories. See your reseller or visit www.ClarityVisual.com for a current listing of available options.

- ❖ **Ultra-Thin Mullion Screen** – There are three screen options:
 - The standard screen has a mullion 1/8" (3 mm) wide. The mullion is a strip of sheet metal surrounding the screen which holds it in place.
 - The Ultra-Thin Mullion Screen, or mullionless screen, does not have the 1/8" (3 mm) strip of sheet metal around the screen. The edge of the screen goes right to the edge of the display unit, which makes the lines between display units almost invisible in the finished video wall.
 - BlackScreen™, a mullionless screen as above, but with a higher contrast ratio.
- ❖ **S/300 - Video Input Module**
This adds three new inputs – composite and S-video in NTSC, PAL, and SECAM – and a 15.75 kHz line-doubling capability for RGBS.
- ❖ **Clarity's Big Picture™**
Big Picture spreads a single video source over an entire video wall, eliminating the need for an external processor. (All display units in the video wall must have this option.) The S/300 option, above, is included with Big Picture.
- ❖ **SRT-100 Screen Removal Tool**
This tool makes it easy to remove the normal mullion screens when the displays are used in video walls, where units are placed directly adjacent to each other. The SRT-100 minimizes the chance of damaging the screen and the screen's latches. (Used with standard mullion screens only.)
- ❖ **SAT-500 Screen Alignment Tool**
This tool is essential to properly position the display units with the Ultra-Thin Mullion Screen in a video wall. It assures the correct spacing between adjacent screens in the assembled video wall. (Used with Ultra-Thin Mullion screens only.)
- ❖ **BAS-520 Base for the WN-5230-S**
The BAS-520 provides a permanent attachment to flooring.

Safety

Please read this chapter carefully before attempting to install, use, service, or repair the WN-5230-S VideoWall.

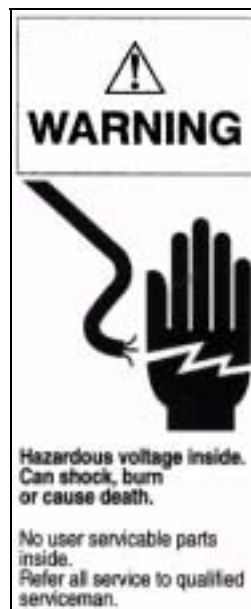

Hazardous voltage inside. Can shock, burn, or cause death. No user serviceable parts inside. Refer all service to qualified serviceman.

WARNUNG

Im Innern des Monitors liegt gefährliche Hochspannung an. Falls Sie unter Hochspannung stehende Teile berühren, können Sie einen elektrischen Schlag erhalten bzw. Verbrennungen oder sogar den Tod erleiden. Im Innern befinden sich keine Teile, die von einem Laien gewartet oder repariert werden könnten. Überlassen Sie alle Wartungs- und Reparaturarbeiten einem qualifizierten Techniker.

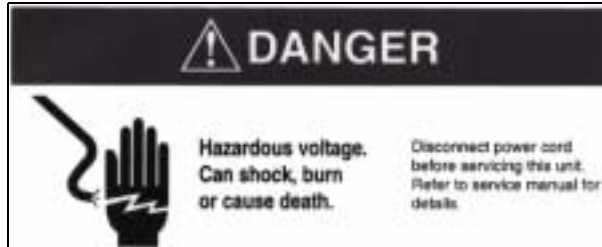

Hazardous voltage. Can shock, burn or cause death. Disconnect power cord before servicing this unit. Refer to service manual for details.

GEFAHR

Im Innern des Monitors liegt gefährliche Hochspannung an. Falls Sie unter Hochspannung stehende Teile berühren, können Sie einen elektrischen Schlag erhalten bzw. Verbrennungen oder sogar den Tod erleiden. Bevor Sie mit der Wartung dieser Einheit anfangen, sollten Sie den Netzstecker ziehen. Einzelheiten finden Sie im Wartungshandbuch.



Explosion hazard. Hot bulb under high pressure. Wait more than 5 minutes before changing lamp. Handle lamp assembly carefully; do not touch bulb. See instructions for changing lamp assembly.

GEFAHR

Explosionsgefahr. Heiße, unter hohem Druck stehende Glühbirne. Warten Sie mindestens 5 Minuten, bevor Sie die Glühbirne auswechseln. Die Glühbirne vorsichtig behandeln; nicht mit den Händen berühren. Lesen Sie die entsprechenden Anweisungen für das Auswechseln der Glühbirne durch.



Hot surface near lamp. Skin burn hazard. Wait more than 5 minutes for lamp housing to cool before replacing lamp assembly. See instruction manual.

WARNUNG

Oberflächen in der Nähe der Lampe sind heiß! Verbrennungsgefahr! Geben Sie dem Lampengehäuse wenigstens 5 Minuten Zeit zum Abkühlen, bevor Sie versuchen, die Lampe zu ersetzen. Lesen Sie die Anweisungen im Benutzerhandbuch durch.



UV radiation from unprotected, operating bulb. Eye damage injury. Do not disturb light path shielding from the bulb.

WARNUNG

Die nicht abgeschirmte Glühbirne gibt während des Betriebs UV-Strahlen ab. Diese ist extrem schädlich für die Augen. Daher sollte die Abschirmung des von der Glühbirne ausgehenden Strahlengangs in keiner Weise verändert werden.



WARNING

Only the WN-5230-S lamp and air filter are user serviceable. Always turn off and disconnect power before servicing these items. Refer all other service to a qualified service center. Failure to do so could result in electrical shock, ultraviolet radiation burns, contact heat burns, serious injury, or irreparable damage to the WN-5230-S and may void your factory warranty.



WARNUNG Nur die WN-5230-S Lampe, der Luftfilter und die Sicherung können vom Benutzer selbst ausgetauscht werden. Alle anderen Wartungs- und Reparaturarbeiten sollten einem qualifizierten Kundendienst überlassen werden. Nichtbefolgung kann zu elektrischen Schlägen, Verbrennungen durch UV-Strahlen und direkten Kontakt mit heißen Flächen, schweren Verletzungen oder nichtreparablen Schäden beim WN-5230-S führen.



WARNING The area around the projection lamp and the projection lamp assembly become extremely hot during and after use. Use extreme caution and let the WN-5230-S's lamp assembly cool for 5 minutes before touching or replacing the lamp assembly.



WARNUNG Während und nach der Benutzung der Projektorlampe ist die nähere Umgebung der Projektorlampe extrem heiß. Seien Sie äußerst vorsichtig und lassen Sie die Lampe des WN-5230-S für 5 Minuten abkühlen, bevor Sie die Lampe berühren bzw. ersetzen.



WARNING The WN-5230-S contains electrical interlocks that prevent operation of the display when the front screen is removed. Do not bypass these interlocks, except for servicing. Never operate the WN-5230-S with any access panels or the front screen removed from the unit, except for servicing. Operating the WN-5230-S with access panels or the front screen removed can expose service or operating personnel to ultraviolet burns and high electrical voltages. Always wear ultraviolet-blocking eyewear with side guards when servicing the WN-5230-S.



WARNUNG Der WN-5230-S enthält elektrische Sicherheitssperren, die den Betrieb des WN-5230-S unmöglich machen, solange die Frontscheibe abgenommen ist. Außer bei Reparaturen durch einen Fachmann sollten diese Sicherheitssperren nicht überbrückt werden. Außer bei Reparaturen den WN-5230-S niemals mit abgenommenen Abdeckplatten oder abgenommener Frontscheibe betreiben. Der Betrieb des WN-5230-S mit abgenommener Frontscheibe oder abgenommenen Abdeckplatten kann das Reparatur- bzw. Betriebspersonal der Verbrennungsgefahr durch UV-Strahlen sowie elektrischen Hochspannungen aussetzen. Bei der Wartung des WN-5230-S sollten immer UV-Licht- undurchlässige Augengläser mit Seitenschutz getragen werden.



WARNING The WN-5230-S uses a high-intensity projection-lamp module. Do not attempt to replace the projection lamp module with any alternative light source. Doing so can cause overheating or unacceptable image quality. Replacement lamp modules may be ordered from Clarity Visual Systems, Inc. Use only the projection lamp module specified by Clarity Visual Systems, Inc. or an authorized Clarity Visual Systems, Inc. Service center. Use of any other lamp voids the warranty.



WARNUNG Der WN-5230-S benutzt ein Projektionslampenmodul von hoher Intensität. Versuchen Sie nicht, das Projektionslampenmodul mit irgendeiner alternativen Lichtquelle zu ersetzen. Dies könnte zu Überhitzung oder nicht akzeptabler Bildqualität führen. Ersatzlampenmodule können von Clarity Visual Systems, Inc., bestellt werden. Verwenden Sie nur Projektionslampenmodule, die von Clarity Visual Systems, Inc., oder einem von Clarity Visual Systems, Inc., autorisierten Kundendienstzentrum speziell für den WN-5230-S empfohlen werden.



WARNING Do not block the WN-5230-S cooling fan or free air movement under, over, or around the WN-5230-S. Loose papers or other objects should not be nearer to the WN-5230-S than 6 inches on any side.



CAUTION Air handling ducts can discharge unwanted dust or high-temperature air directly on the display. Do not operate the WN-5230-S in dusty or high-temperature conditions.



CAUTION Where several WN-5230-S displays are combined vertically, installation requires a minimum of 12 inches of clearance above the top row, if the top units will be installed from the front.



CAUTION Some types of environmental lighting, such as incandescent, or high-intensity discharge lamps such as metal halide or mercury vapor lamps create high temperatures. This can cause excessive heating of the WN-5230-S VideoWall. The WN-5230-S VideoWall installation should be positioned away from lighting to prevent heat buildup.



CAUTION The front screen of the WN-5230-S VideoWall can be easily scratched and the optical quality degraded by fingerprints. Install the WN-5230-S VideoWall in such a way that it is not exposed to touching or possible scratching by hard objects.



CAUTION The Ultra-Thin Mullion screen units are not serviceable from the front.

Quick Start

This is a brief sequence of actions that must be followed to properly setup the WN-5230-S. Complete instructions and explanations of the steps are contained in the following chapters.

1	Remove the screens and build the wall starting with the lower row. Bolt the displays together side-to-side. If you have Ultra-Thin Mullion screens, align the displays and their adapter plates. Replace the screens.
2	Attach the power cable and video/data cables to the rear connector panel.
3	Connect the video/data cables to the source.
4	Plug the power cable into the wall outlet or other suitable power source. Remember that each display can draw as much as 1.7 amps at 115 volts (0.9 amps at 230V).
5	Turn on the display's main AC power switch and wait for the 30 second standby-delay to elapse. The lighted power switch indicates when AC power is applied and the switch is on.
6	After the 30 second standby-delay has elapsed, press the remote control's ON button to turn-on the display.
7	Select the SOURCE in the menu.
8	Use LEVEL ADJUST to calibrate the display to the source. Always adjust black before white! Display a black image from the source and auto-adjust the BLACK LEVEL . Display a white image from the source and auto-adjust the WHITE LEVEL .

9	Select (or deselect) SHARPNESS in the Misc Control menu.
10	Display a checkerboard pattern (alternating black and white pixels) from the data/video source and adjust the FREQUENCY . This step is most applicable to computer sources.
11	Adjust the PHASE using the checkerboard pattern from the source. This step is most applicable to computer sources.
12	POSITION the image.
13	COLOR BALANCE the displays to each other, if necessary.
14	Save the settings in the SAVE CONFIG menu.

Site Preparation

Read the chapter on safety precautions before installing and operating the WN-5230-S VideoWall.

The following table shows the installation specifications for a variety of common video wall configurations.

Height X Width -	1X1 Single	1X2 2 displays	2x2 4 displays	2X3 6 displays	3X3 9 displays	3X4 12 displays	4X4 16 displays
Screen Height, inches	31.3	31.3	62.6	62.6	93.9	93.9	125.2
centimeters	79.5	79.5	159.0	159.0	238.5	238.5	318.0
Screen Width, inches	41.7	83.4	83.4	125.1	125.1	166.8	166.8
centimeters	105.9	211.8	211.8	317.8	317.8	423.7	423.7
Weight, pounds	120	240	480	720	1080	1440	1920
kilograms	54.4	108.9	217.7	326.6	489.9	653.2	870.9
115 Volts A/C Input							
Current, amps - max	1.7	3.4	7.0	10.4	15.7	20.9	27.8
Power, watts - typical	160	320	640	960	1440	1920	2560
Heat, BTU/hr - typical	546	1092	2184	3276	4914	6551	8735
Air Cond., tons - typical	.05	.09	.18	.27	.41	.55	.73
230 Volts A/C Input							
Current, amps - max	.9	1.7	3.4	5.2	7.9	10.5	13.9
Power, watts - typical	160	320	640	960	1440	1920	2560
Heat, BTU/hr - typical	546	1092	2184	3276	4914	6551	8735
Air Cond., tons - typical	.05	.09	.18	.27	.41	.55	.73

Table 1

Power

Make sure that any power cord substituted for the power cord originally supplied with the display is compatible with the nominal power source used with the WN-5230-S.

Power Consumption

Typical power consumption of the WN-5230-S is 160 Watts, but the maximum potential of 200 Watts should be used for calculating the load on the power source. At 200 Watts the current draw is approximately 1.7 Amps at 115 VAC (0.9 Amps at 230 VAC).

Voltage Range

The WN-5230-S will operate between 100 and 240 volts AC at 50/60Hz. Since the power module is auto ranging, there is no manual selector switch.

The main power switch on the power module also acts a circuit breaker. If power to the display is lost, check the power/breaker switch by turning it off and then back on.

The power switch is a lighted switch. When it is lit, it indicates that the AC power is applied and the power switch is on.



WARNING Displays that are intended for 240V configuration must have a properly rated power supply cord and attachment plug supplied by the installer.



WARNING If extension cords are used for power, ensure that only 3-prong grounded cords sized to handle system power requirements are used. Using the wrong-size extension cord can cause a fire-safety hazard and can reduce the voltage available to the WN-5230-S. If the extension cord is warm to the touch it is too small and should be immediately removed from operation.



WARNUNG Falls für die Stromversorgung Verlängerungskabel benutzt werden, achten Sie bitte darauf, daß nur geerdete, dreipolige und für die vorgesehene Leistungsaufnahme ausgelegte Netzkabel benutzt werden. Die Verwendung eines unterdimensionierten Verlängerungskabels stellt eine potentielle Feuergefahr dar und kann dazu führen, daß die für den WN-5230-S Video-Monitor verfügbare Spannung zu gering ist. Falls das Verlängerungskabel sich fühlbar erwärmt, heißt das, daß das Verlängerungskabel unterdimensioniert ist. Es muß dann sofort aus dem Verkehr gezogen werden.



WARNING Hazardous voltages inside the display and power module can shock, burn and cause death. Only the WN-5230-S lamp and air filter are user serviceable. Always turn off and disconnect power before servicing these items. Refer all other service to a qualified service center. Failure to do so could result in electrical shock, ultraviolet radiation burns, contact heat burns, serious injury, or irreparable damage to the WN-5230-S and may void your factory warranty.



WARNUNG Im Innern des Monitors liegt gefährliche Hochspannung an. Falls Sie unter Hochspannung stehende Teile berühren, können Sie einen elektrischen Schlag erhalten bzw. Verbrennungen oder sogar den Tod erleiden. Im Innern befinden sich keine Teile, die von einem Laien gewartet oder repariert werden könnten. Überlassen Sie alle Wartungs- und Reparaturarbeiten einem qualifizierten Techniker.

Temperature and Humidity

The WN-5230-S is designed to operate over an ambient temperature range of 0° to 35° C (32° to 95° F) and between humidity of 20 to 80 % R.H. non-condensing.

The air that cools the display and the warm exhaust air is passed through the back of the WN-5230-S. This area should not be blocked. If the display becomes overheated, permanent damage to the product may result.

Some types of environmental lighting, such as incandescent, or high intensity discharge lamps such as metal halide or mercury vapor lamps, create high temperatures and this can cause excessive heating of the WN-5230-S. The displays should be positioned far enough away from high-temperature lights to prevent heat buildup.

Nearby heat sources can cause high operating temperatures in the WN-5230-S. Minimize the display's exposure to heating ducts, radiators, or other external heat sources.

Flooring

A typical WN-5230-S weights approximately 120 lbs. (55 kg). Before installing the WN-5230-S, determine the structural integrity of the flooring where it will be used. The floor should be level and strong enough to support the combined weight of the number of displays and other equipment used in the installation. Take special care when installing a WN-5230-S in a wall configuration on a temporary structure such as a stage floor, where the flooring could bend or collapse under the weight of the installation. The maximum number of WN-5230-S's stacked vertically in a wall configuration resting on a temporary floor should be no more than 4.

Clearance

Normal maintenance, such as lamp and air filter replacement, can be performed from either the front or rear of the WN-5230-S. However, the units with Ultra-Thin Mullion screens are serviceable only from the rear. A minimum of 4 feet of clearance is recommended for easy front access and for easy rear access a minimum of 3 feet is recommended.

To allow proper cooling, the minimum required clearance to the rear of the Unit is 4 inches.

If installed in a video wall configuration, a minimum of 12 inches to the ceiling from the top of the highest display is needed if the units are installed from the front.

Cables and Signals

Video connections from the signal source to the display depend on the type of signal supplied by the source. The compatible data inputs are: PC 800x600 (SVGA), PC 640x480 (VGA), MAC 800X600 or 640X480, 31.5 kHz and 15.75 kHz (progressive scan) RGBS video, composite video, and S-video.

The Loop-Thru video output uses a standard 15 pin VGA type connector for output to an external computer monitor or to another WN-5230-S. The format of the Loop-Thru video is same as the source video.

The video cables used should be high quality and shielded to insure the best image quality when displayed. VGA and MAC will have RGB with separate H-Sync and V-Sync. RGBS video will come out RGBS with the composite sync on the connector's H-Sync pin. RGB Sync on Green sources will loop-thru RGBS-Sync on Green. Displays with the VIM-300 option also have Composite Video and S-Video loop-thru connectors.

Using poor quality cables can lead to picture noise, jitter and crosstalk. Even good quality cables that are longer than 10 feet may produce noise and jitter in the image if the source signals are not amplified.

Control data enters the display via the RS-232 In connection, and is supplied to an adjacent display (if used) via the RS-232 Out connector. High quality shielded cables designed for RS-232 communication should be used to ensure proper data transmission and control. The wiring of the RS-232 cables must be straight through (pin 1 to pin 1, pin 2 to pin 2, etc...) and not wired for "null modem".

Optical Alignment

Tools Required: 3/32 inch Allen-hex driver
 3/8 inch socket driver

Optical Alignment means to the adjust the size and position of the image and to correct for keystoneing and rotation. Before installing a display, check it to verify that the image is optically aligned.

When thinking about the optical calibration process, here are some things to remember:

- The critical dimension during calibration is the distance from the projection lens to each corner of the screen. If these distances are equal, from lens to mirror to screen, the image will be a rectangle.
- The light path from lens to screen is expanding. If the path of one corner is a little longer, that part of the image will expand more; if shorter, that part will be smaller.
- Work on one thing at a time and in this order:
 1. Make the image rectangular. Don't worry at first about size or placement. Just make it have four square corners.
 2. Adjust rotation, so that the edges of the image are parallel with the edges of the screen.
 3. Adjust size, making the image fill the screen. In standard mullion screens, this means hiding three pixels behind each mullion. With Ultra-Thin Mullion screens, hide one pixel at each edge.
 4. Adjust position, left and right, up and down.
- In most cases, only slight adjustments are required, usually just position. Don't try to adjust anything that doesn't need it.

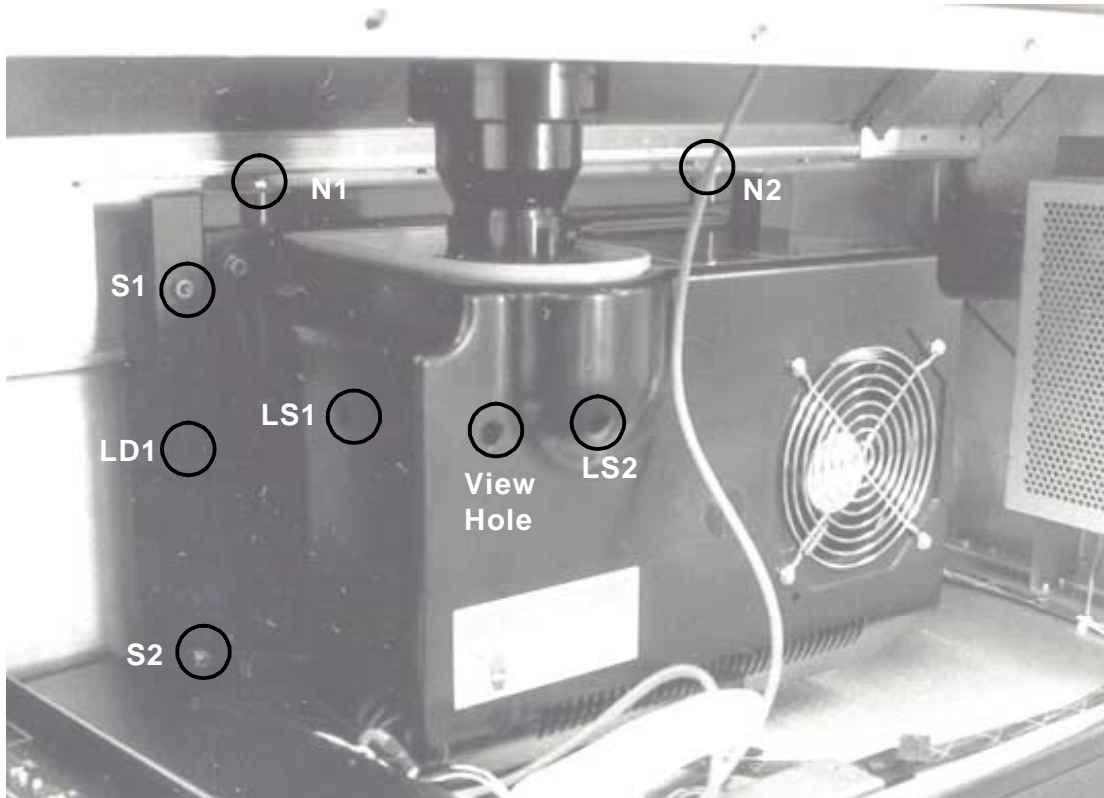

Figure 1. Optical Engine, left side. The addition hole between LS1 and LS2 which lets you see the LS screws more easily.

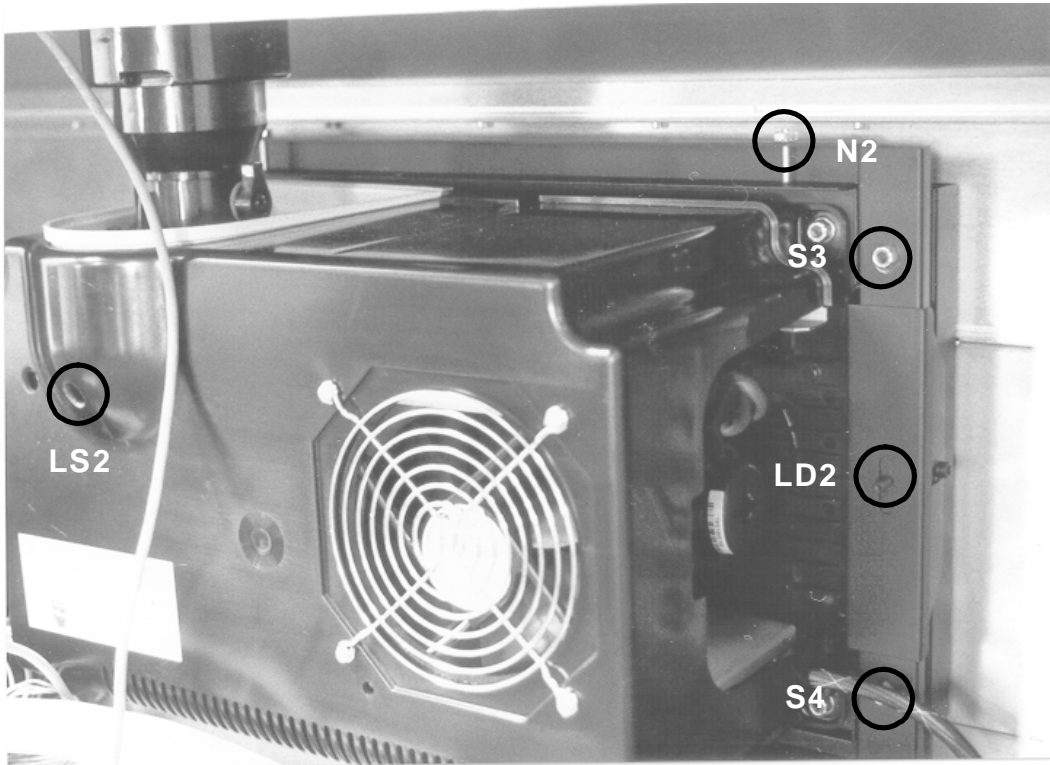

Figure 2. Optical Engine, right side.

For an image that is way out of alignment and that needs *major* adjustment, start with everything in a “normal” position:

- If the screen is Ultra-Thin Mullion, remove the screen and check that all the pointed alignment bolts are at the same distance. Put the shipping shim behind each bolt and tighten the bolt to it. (Later, when building a wall, make sure that the main chassis of the cubes are aligned. It is a mistake to move the screens in and out a great distance with the pointed alignment bolts to compensate for main chassis that are not even with each other. Moving these bolts a lot will change the image size, because the lens-to-screen distance changes.)
- Each corner of the optical engine mount should start at the same distance out. Factory default is 3 cm, but any distance near this amount will do a good job. Make a block of wood that is 3 cm thick and use it as a gauge at the four corners of the metal engine mount. Then adjust S1, 2, 3, and 4 to make the engine mount just touch the block.
- Adjust the lens screws, LS1 and LS2, so they are part way in. As these screws turn out, eventually they reach a point where the spring no longer pushes the lens toward the screw. Have the lens in a middle position, so that the spring is pressed some, but not as much as half way.

Adjusting the Image

There are four nuts on the engine mounting plate, S1, S2, S3, and S4. Adjust these in **pairs** and turn them **equal amounts**.

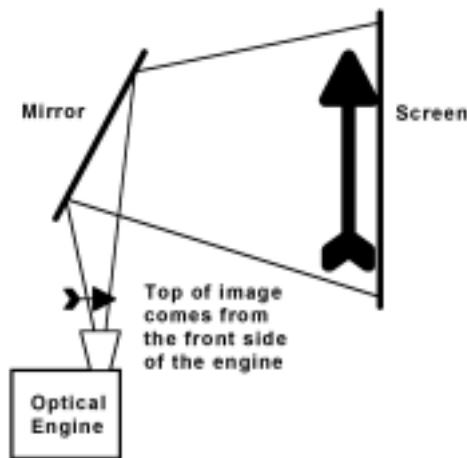

Figure 2. Diagram of optical engine, mirror and screen as seen from the side.

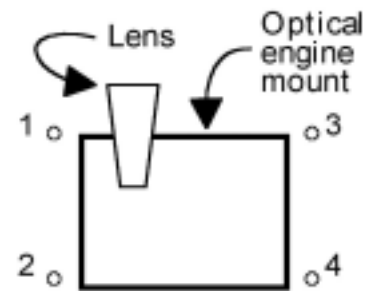
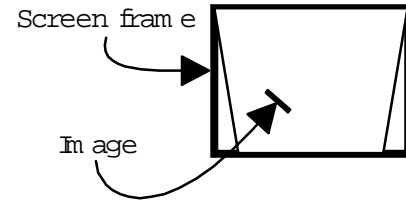

Figure 1. Optical engine, seen from rear, showing location of four “S” adjustment screws.

Keystone, top wider

To fix this, loosen nuts S1 and S3 in equal amounts to make the top smaller. This will lower the image on the mirror, shortening the distance to the screen for the top, thus making it smaller. The whole image will be lowered, but you can fix this later with the lens adjustment.



Keystone, bottom wider

To fix this, tighten nuts S1 and S3 equal amounts to make the top larger. This will also raise the image, so you will have to use the lens adjustment later to lower it.

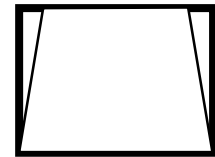

Keystone, left side wider

To fix this, loosen the lock down nuts, LD1 and LD2. Then loosen N1 or tighten N2. Retighten LD1 and LD2.

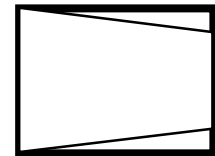

Keystone, right side wider

Loosen the lock down nuts, LD1 and LD2. Then tighten N1 or loosen N2. Retighten LD1 and LD2.

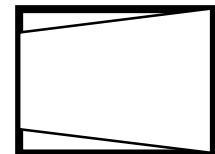

Rotation, clockwise

Loosen S3 and S4, or tighten S1 and S2, equal amounts to rotate the left side of the image down.

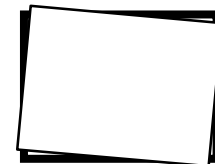

Rotation, counterclockwise

Tighten S3 and S4, or loosen S1 and S2, equal amounts to rotate the left side up.



Size

To increase image size, loosen N1 and N2 together.
To make the image smaller, tighten them both.
Before adjusting N1 and N2, loosen the locking nuts
LD1 and LD2 (lock down nuts).

Up, down, right, left

Use LS1 and LS2 to move the image vertically or
horizontally.

When you think you are finished, check again the size and overall geometry to
make sure the picture is still within specifications: ± 1 pixel. Then make sure you
lock the engine in place by tightening LD1 and LD2.

Adjustment Summary
(Viewed from the front)

Rotation

Adjustment Hardware	Direction	Effect On Image
S1 and S2 together	Tighten	Right side up
S1 and S2 together	Loosen	Right side down
S3 and S4 together	Tighten	Left side up
S3 and S4 together	Loosen	Left side down

Keystone

Adjustment Hardware	Direction	Effect On Image
S1 and S3 together	Tighten	Top wider, Image up
S1 and S3 together	Loosen	Top narrower, Image down
S2 and S4 together	Tighten	Bottom wider, Image down
S2 and S4 together	Loosen	Bottom narrower, Image up

Size –

(LD1 and LD2 must be loosened before adjusting N1 and N2.)

Adjustment Hardware	Direction	Effect On Image
N1 and N2 together	Tighten	Smaller
N1 and N2 together	Loosen	Bigger

(Retighten LD1 and LD2.)

Final Position –

Up/Down/Left/Right

Adjustment Hardware	Direction	Effect On Image
LS1	Tighten	Moves left
LS1	Loosen	Moves right
LS2	Tighten	Moves up
LS2	Loosen	Moves down

Mechanical Setup

The mechanical setup is broken down into three processes - the physical assembly of the wall, the attachment of cables to each display and the setting of each display's number, or address, in the wall. The WN-5230-S comes with either a standard screen, an Ultra-Thin Mullion Screen, or a Blackscreen™. (Blackscreen has the same dimensions as the Ultra-Thin Mullion.)

- The **standard screen** has a mullion about 1/8th inch (3 mm) wide. The mullion is a strip of sheet metal surrounding the screen and holds it in place.
- The **Ultra-Thin Mullion Screen**, or mullionless screen, does not have the 1/8th inch strip of metal around the screen. The edge of the screen goes right to the edge of the display unit. This makes the lines between display units much less apparent in the finished video wall.
- **BlackScreen™**, a mullionless screen as above, but with a higher contrast ratio.

Mechanical Setup, Standard Screen

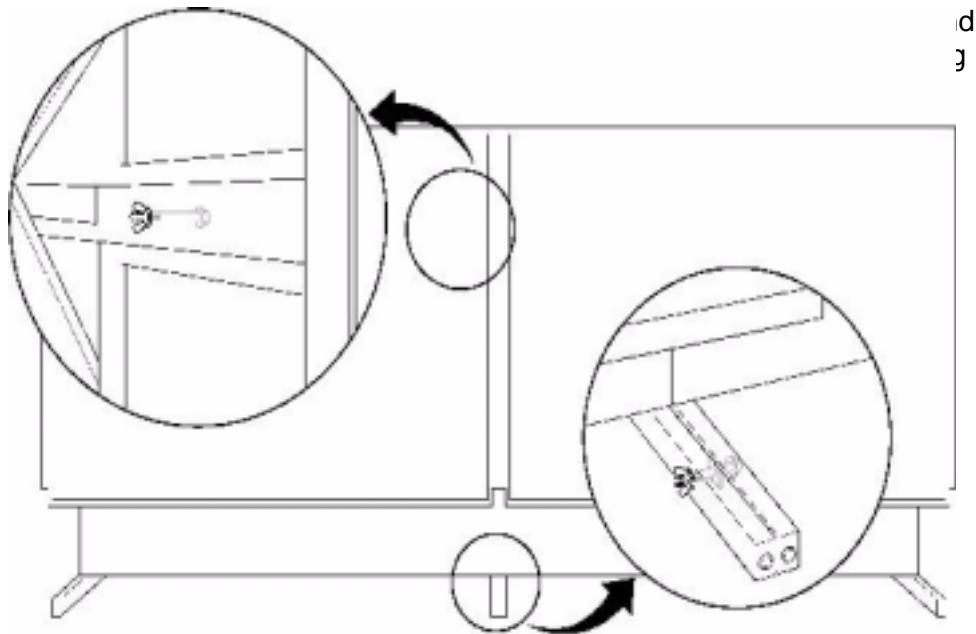

Figure 3 Connecting display units

To setup the WN-5230-S display in a video wall configuration, follow these steps:

<p>1. Grasp the screen on each side at the bottom</p>	<p>The "screen" you are removing is 5 inches thick. Pull out at the bottom first, to separate the latch-hooks from the latches. It comes out with a "pop." The screen should now be loose at the bottom, but still attached at the top.</p>
<p>2. Slip fingers between the screen frame</p>	<p>Slip fingers between the screen frame and the display chassis, as close to the top latches as possible and pull the top of the screen from the latches.</p>
<p>3. Using both hands...</p>	<p>Carefully remove the screen and set it aside.</p>
<p>4. Assemble the lower row first.</p>	<p>Line up the legs for the bottom row as straight as possible.</p> <p>Insert a ¼" X 2 ½" bolt through the holes as shown at the bottom of Figure 1. Tighten a nut securely on this bolt, but take care not to bend the legs.</p> <p>Secure the legs to the floor. Use the tapped 5/16-18 holes in the front and rear of the legs. You can put an eye-bolt in this hole and secure it to the floor with a lag screw. Or use angle bracket, screwed to the floor and bolted to this hole in front and rear. Or use the optional BAS-520 base, securing it to the floor and putting the lower row of displays on it.</p> <p>Before going to the next higher rows, see that the bottom row is straight. From one end of the line, look along the front of the displays. The line should be straight and flat. Level is not as important as straight and flat.</p>
<p>5. Stack the next higher row.</p>	<p>Slide the legs of each display into the mating sockets of the display in the first (lower) row. Check it for "straight and flat."</p>
<p>6. Insert a bolt (supplied).</p>	<p>Insert a bolt through the hole in side wall of the lower unit into each leg of the unit above.</p> <p>Tighten a nut on this bolt to lock the units together. See Figure 1, above.</p>
<p>7. Continue with subsequent rows of displays</p>	<p>Lock each display to the adjacent displays after the row above it (if any) has been installed. Bolt the top row together, even though there are no legs from a higher row.</p>
<p>8. For added stability...</p>	<p>Use the rear-tapped holes in the legs of the upper units to fasten to a solid support, such as a structural wall.</p> <p>The threaded inserts in each leg are female 5/16-18 UNC.</p>
<p>9. Check</p>	<p>Check that all displays in the video wall are locked together. Look again down the line from one end to see that each row is straight and flat.</p>

10. Reinstall screens

Reinstall each display's screen.

Mechanical Setup, Ultra-Thin Mullion or Blackscreen

CAUTION The displays with Ultra-Thin Mullion screens are *not* serviceable from the front. Service should be performed through the rear access cover. Instructions for BlackScreen are the same as for Ultra-Thin Mullion screen.

You will need these tools:

- a large, flat blade screwdriver
- an SAT-500 Screen Alignment Tool (two of these tools makes installing a video wall even easier.)
- black cloth tape
- a tape measure (inches or centimeters)
- 1/2" open-end wrench, a 1/2" deep-well socket, or an adjustable wrench
- 5/64" Allen hex wrench

The thin mullion display screens consist of two basic parts. There is the screen itself and the frame it is held in, an assembly which is about 3" (7 cm) thick. The screen attaches to the second part, an adapter plate which is about 2" (5 cm) thick. The adapter plate is mounted on the front of the display unit.

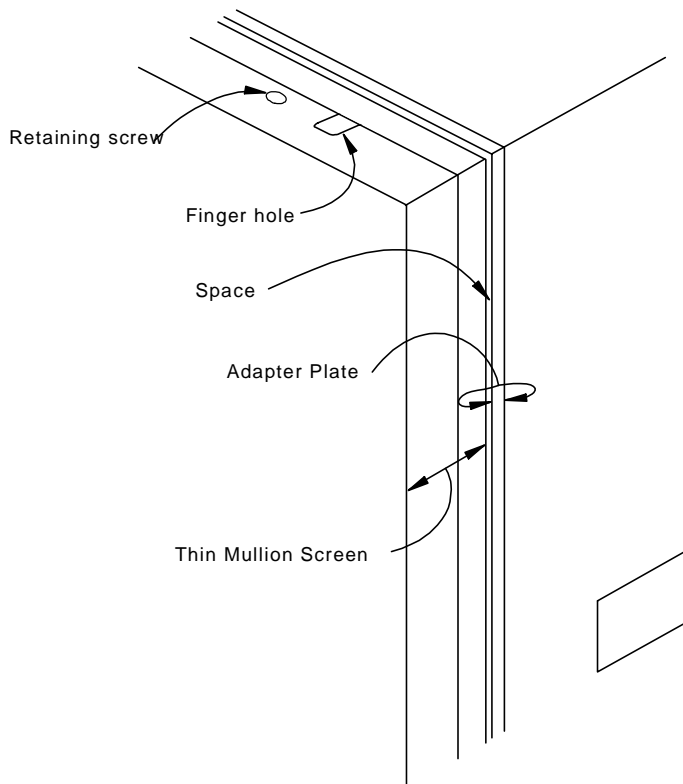

During the alignment process, you remove the screen from the adapter plate, then adjust the adapter plate to make its corners square and align correctly with its neighbors. Then the screen is re-installed and adjusted in or out.

Installing a video wall with Ultra-Thin Mullion Screens is a little more complex than installing the wall with standard mullion screens. Mechanical alignment is more critical, and the larger the video wall, the more precisely each unit must be aligned to produce a good looking image. The outcome of this alignment process is partly dependent on how flat the floor is, but it is mostly dependent on how tightly the displays are fitted to each other.

Figure 4 Ultra-Thin Mullion Screen

Basic Steps for Alignment

This is a summary of the steps necessary to build a video wall thin mullion displays and align their screens. This is a *summary* only. The details on how to perform each step follow the summary.



1. Remove the screens from all the display units.
2. Build the video wall.
3. Start with the display unit in the center of the bottom row. Square its adapter plate.
4. Using the Alignment Tool, working along the bottom row in both directions from the squared adapter plate and align each of the other Adapter Plates to its neighbor.
5. Align the adapter plates on the rest of the rows, working upward, to the adapter plates in the bottom row.
6. Hang the screens on the bottom row and adjust them in or out so the front surfaces (the screen faces) are flat with each other. Then do the rows above.
7. Put retaining screws in the top row and cover any holes and seams with black tape to prevent light leaks.

Alignment Procedure in Detail

Read through all the detailed parts of each numbered step before starting it.

1. Remove the screens from all the display units.	<p>A. Look down on the top of the screen and locate the two retaining screws. Remove these screws, using the 5/64-inch Allen hex wrench, and set them aside.</p> <p>B. Grab the sides of the screen, or use the finger holes, and lift it up about half an inch (1 cm), and remove it from the adapter plate. Set it aside.</p>
2. Build the video wall.	<p>A. Assemble the lower row first. Line up the legs for the bottom row as straight as possible. Insert a 1/4" x 2 1/2" bolt through the holes as shown in Figure 1. Tighten a nut securely on this bolt, but not so tight as to bend the legs. From one end of the bottom row, look along the row to see that all the units are aligned, that the line of the front of the display units does not curve forward or backward, up or down. The straighter the first row, the better the finished wall will be. And the easier it will be to keep it straight as you build.</p> <p>B. Secure the legs to the floor. Use the tapped 5/16-18 holes in the front and rear of the legs. You can put an eye-bolt in this hole and secure it to the floor with a lag screw. Or use angle bracket, screwed to the floor and bolted to this hole in front and rear. Or use the optional BAS-520 base, securing it to the floor and putting the lower row of</p>

	<p>displays on it. (If the BAS-520 is used with Ultra-Thin Mullion screens, remove the adapter plate before you put the unit on the base.) Stack the next higher row. Sliding the legs of each display into the mating sockets of the display in the first (lower) row.</p> <p>C. Insert a bolt (supplied). Insert a bolt through the hole in side wall of the lower unit and into each leg of the unit above. Tighten a nut on this bolt to lock the units together. See Figure 1 above. Tighten all the bolts after you have checked for straightness, as in Step A above.</p> <p>D. Continue with higher rows of displays. Lock each display to the adjacent displays after the row above it (if any) has been installed. Check for straightness on each row.</p> <p>E. For added stability, use the tapped holes in the rear of the legs of the upper units to fasten to a solid support, such as a structural wall. The threaded inserts in each leg are female 5/16-18 UNC.</p> <p>F. Check that all displays in the video wall are locked together. And straight.</p>
<p>3. Start with the display unit in the center of the bottom row. This will be the Base Unit. Align the Base Unit's adapter plate. (If the bottom row has an even number of display units, choose either middle one. This step can be done before the wall is built, if necessary.)</p>	<p>A. Look at the sides of the Adapter Frame. (See Figure 3, below.) Starting at the top edge and moving down you will see a large Locking Screw, a pointed Alignment Bolt, and an Alignment Hole. Near the middle of each side is a threaded hole for the Alignment Tool's spring-loaded screws. (Do not attach the Alignment Tool yet.) At the bottom of the side notice the Alignment Hole, the Alignment Bolt, and the Locking Screw.</p> <p>B. Look at all the Alignment Bolts of all units. They should all be the same distance out. The factory ships the display with a "shipping shim" behind this bolt. If you have to adjust these bolts, you should remove this shim. Save it. Use it later, if you need to ship the units. When you ship Ultra-Thin Mullion screen displays, always have the Alignment Bolt either tighten onto the shipping shim, or tighten down completely.</p> <p>C. Check to see that the Adapter Frame of the Base Unit is centered on the chassis. If the frame is not centered on the chassis opening, for instance, if it is offset to the left, then all the other frames will have to be offset in this same direction. It is best if this first frame is nicely centered on its chassis opening.</p> <p>D. Check to see that all the Locking Screws are tight.</p> <p>E. Measure the opening diagonally, from corner to corner in both directions, and compare the results. Be sure to measure from exactly the same points each time. An accuracy of 1/32nd inch (0.8 mm) is necessary for most applications, but the more accurately you can do this, particularly in the bottom center unit, the better the video wall will be aligned and the better the</p>

	<p>picture will look.</p> <p>F. If the two measurements are the same, you have a rectangle with perfectly square corners,  and you may go on to Step 4.</p> <p>G. If the two measurements are not the same, within 1/32nd inch (0.8 mm), the frame is not a rectangle with perfectly square corners, it is a  parallelogram. Loosen the top Locking Screws on each side. Move the adapter plate left or right a bit and tighten the screws. Measure the diagonals again. Repeat this process until you are satisfied that the two diagonals are the same. This means the adapter plate is a perfect rectangle with square corners.</p>									
<p>4. Working along the bottom row in both directions, align each of the adapter plates, using the Alignment Tool.</p>	<p>A. Now that the center unit adapter plate is squared, align one of its neighbors in the bottom row.</p> <table border="1" data-bbox="922 766 1442 1159"> <tr> <td style="text-align: center;">8</td> <td style="text-align: center;">5</td> <td style="text-align: center;">9</td> </tr> <tr> <td style="text-align: center;">6</td> <td style="text-align: center;">4</td> <td style="text-align: center;">7</td> </tr> <tr> <td style="text-align: center;">2</td> <td style="text-align: center;">1</td> <td style="text-align: center;">3</td> </tr> </table> <p>B. The diagram above shows the order in which you should align the displays in a typical video wall. (Note: This is not the same as the Unit ID address of the display units.)</p> <p>C. The Alignment Tool fits over the seam of two adjacent adapter plates. The Tool has six guide screws, three on each side, and four spring-loaded screws, two on each side. (Only two of the spring-loaded screws, one on each side, will be used at a time.)</p> <p>D. Position the Alignment Tool between the two displays. One of these (#1) is already square and the other (#2) is about to be aligned. Fit the tool into display #1 first and attach it with the lower spring-loaded screw. The guide pins should go into the Alignment Holes in display #1.</p> <p>E. Loosen the two Locking Screws in #2 on its right side under the Alignment Tool and move the adapter plate of display #2 until the guide pins go in the Alignment Holes. Secure the Alignment Tool to #2 with the spring-loaded screw. Tighten the two Locking Screws on #2 under the Alignment Tool. (Do not be concerned about the</p>	8	5	9	6	4	7	2	1	3
8	5	9								
6	4	7								
2	1	3								

	<p>units in the row above at this time.)</p> <p>F. With the Alignment Tool still in place, check display #2 for squareness by measuring the diagonals. Loosen the Locking Screws on #2 that are on the other side from the Alignment Tool, and adjust adapter plate #2 until it is square-cornered rectangle.</p> <p>G. When you are satisfied that display #2 is aligned to display #1 and it has perfectly square corners, remove the Alignment Tool. (If you have two Alignment Tools, leave this first one in place, and put the second on the other side.)</p> <p>H. Go to the display on the other side of the center display (#3) and align it to the center display, following the steps 4.C through 4.G.</p>
<p>5. Align the adapter plates on the units above the Base Unit, working upward.</p>	<p>A. Start with the display above the Base Unit. Align display #4 to display #1. Put the Alignment Tools on either side of the Base Unit, #1. The upper guide pin should now fit the bottom Alignment Hole of #4. Loosen the bottom Locking Screw in #4 and make it fit. Do the same on the other side, moving the Alignment Tool, if you have only one.</p> <p>B. Measure the diagonals of #4. Loosen the top two Locking Screws and make its corners square, then tighten the screws.</p> <p>C. Continue with display #5, working your way up the video wall to the top.</p> <p>D. When you have completed the inverted-T, use these as a frame and align the other units to it, working from the lower rows upward. For each display, you should be sure it is the correct distance vertically and horizontally from all its neighbors and that each unit's diagonals are equal.</p>
<p>6. Hang the screens on the bottom row and adjust them in or out so their front surfaces are flat with each other.</p>	<p>A. Hang the screens on the bottom row. Be sure the finger holes are on the top of each screen. When each screen is seated, pull on it slightly to make sure it is secure at both the top and bottom.</p> <p>B. Notice the seams. Are the two screens flush at each seam? If not, note how much you will have to adjust one of the screens to make it flat and flush with its neighbor. Measure this amount, but be careful not to scratch the screens. Also, sight along the row from the end. Look down the groove on the top of the screens. This helps to prevent</p>  <p>where the corners match, but the screens are not flat. Make a diagram of the video wall and note how far to move each corner of each unit in or out. Try to get the wall flat within 1/32" inch (0.8 mm)</p> <p>C. Remove the screens again.</p> <p>D. Working from your notes, adjust the pointed Alignment Bolts with the 1/2-inch wrench. Looking at the display from the front, each complete turn of the bolt CW (clockwise) pulls the corner of the</p>

	<p>screen IN (away from you) by 1/32nd of an inch (0.8 mm).</p> <p>E. Hang the screens again and check your work.</p> <p>F. With the screens in place on the bottom row, put the screens on the next row above. "Flatten" this row in the same way, paying attention to how these fit with the bottom row as well as with their neighbors to the left and right.</p>
<p>7. Put retaining screws in the top row and cover holes and seams with black tape to prevent light leaks.</p>	<p>A. When all the screens are aligned with each other to make a flat, square video wall, put the screws in the top row of screens to hold them in place.</p> <p>B. The finger holes and the space between the screen and the adapter plate can be a source of light leaks, allowing stray light to hit the back of the screen and wash out some of the picture. To prevent this, cover the finger holes in the top row of displays with black cloth tape. "Gaffer" tape does a nice job of this. Masking tape is sometimes difficult to remove cleanly. You can check for light leaks during the video setup process. Select "Curtain" from the main menu and verify that the whole screen is black. It is best to do this in the actual lighting that will be on when the wall is used.</p>

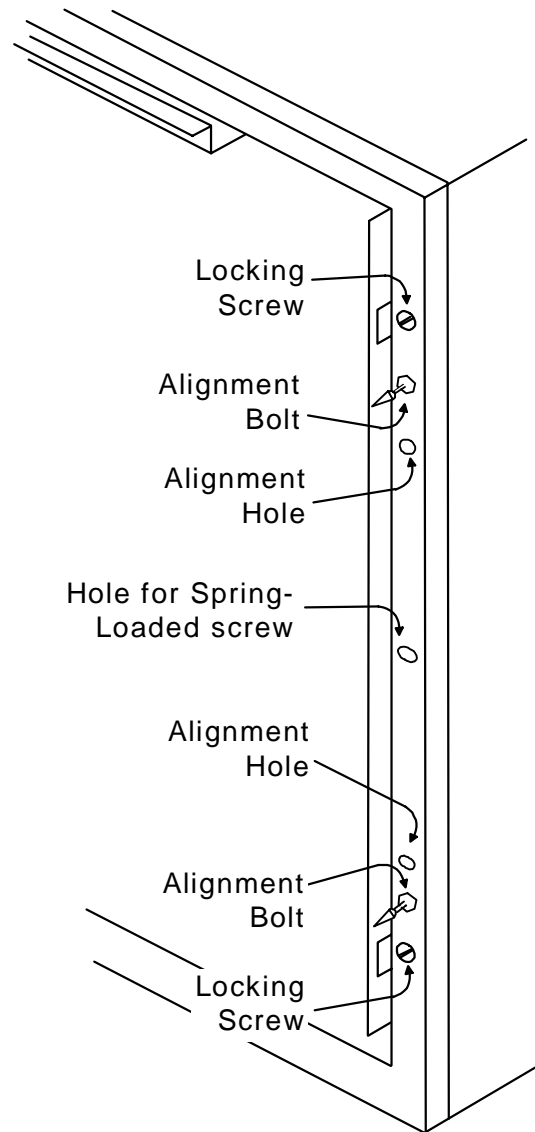

Operation

After the displays are installed, use these procedures:

Step 1 - Power-On

Step 2 - Adjust the Input Signal Settings

Step 3 - Adjust the Colors

Step 4 - Save the Settings

Step 1 – Power-On

<p>1. Turn the main power switch on the power supply to the ON position</p>	<p>The Standby LED flashes, indicating the power up cycle has begun. Wait approximately 30 seconds until the Standby LED is on and not flashing.</p>
<p>2. Press the remote control ON button to power up each Display</p>	<p>You will hear a ‘beep.’ The lamp will come on, but it will require a few minutes to fully warm up. There is a built-in delay from when you press the remote’s ON button to when the lamp starts to ignite. The extent of the delay depends on the position of the Unit switch on the rear panel.</p> <p>GROUP ID numbers are 0-9 and A-F for a total of 16 different settings. Each number is equal to that number times 16. A setting of 3 is equal to 48.</p> <p>UNIT ID numbers are 0-9 and A-F for a total of 16 different settings. Each number is equal to that number times one. A setting of C equals 12.</p> <p>The Monitor ID number is the combination of the Group ID plus the Unit ID. A Group ID number of 2 and a Unit ID number of 5 equals a Monitor ID of 37 decimal, 25 hexadecimal.</p> <p>The delay time between an “on” command to the display and the ignition of the lamp is approximately 1 seconds times the <u>Unit ID</u> number.</p>
<p>3. Check for normal</p>	<p>Observe the LED on the rear of each unit. When the</p>

operation	electronics "thinks" the lamp is on, the STBY LED is off, and the fan and lamp LEDs are on. However, the electronics does not know whether the lamp is actually lit. A faint glow from the lamp exhaust vent in the rear of the unit indicates the lamp is on.
-----------	--

Step 2 - Adjust the Input Signal Settings

Select the Source (The menu with the S/300 option installed is pictured here.)

Source Select
Frequency
Phase
Input Level
Position
Zoom
Wall Processor
Color Balance
Curtain
Hours
Save Config
Recall Config
Reset Config
Misc Control
About

Source Select	Source
<input checked="" type="radio"/> PC	• PC
<input type="radio"/> 800x600	MAC
<input type="radio"/> Auto	9-PIN
<input type="radio"/> Sync On Green	BNC
<input type="radio"/> Interlace	C-Video
	S-Video
H Freq: 00000	
Lines: 000	
V Rate: 00	

Source Select	Mode
<input type="radio"/> PC	640x480
<input checked="" type="radio"/> 800x600	• 800x600
<input type="radio"/> Auto	
<input type="radio"/> Sync On Green	
<input type="radio"/> Interlace	
H Freq: 00000	
Lines: 000	
V Freq: 00	

After the displays are turned on, use this procedure to select the correct source. This must be done with *each* unit in a video wall.

1. On the remote control, press SOURCE	The Source Select menu is displayed.
2. Press the Up/Down arrow keys and highlight the upper pair of arrows ← →	Notice the menu choices of "Source" on the right. The current selection is shown next to the arrows and is marked with a bullet in the right hand list. Use the left/right keys to make this selection. (Depending on options, your unit may not display all these choices.)
3. Auto	<p>If you have selected a good Source in Step 2, "Auto" can set Mode automatically. Highlight the [] next to Auto and press ENTER. Auto takes information from H Freq, Lines, and V Freq, shown at the bottom of the menu, and sets the image size and refresh rate. Auto does this just once. The X will appear in Auto for a very brief moment. For computer sources, always use Auto rather than selecting the Mode manually.</p> <p>Note: PCs sometimes produce a 400 line video signal. This happens when Windows boots up or when the PC has a fault and shows a fault message. During this time, the display will roll, because it does not recognize 400-line video and can't sync to it. If this happens, and you have no other way to see the video output of the computer, press Source on the remote control. Then highlight Auto and press Enter. The display will now recognize and show the 400-line video image. (This mode cannot be saved in memory.) After the PC's problem is fixed, use Auto again to reset the input mode.</p>
4. Sync on Green	If the Source is RGBS or MAC and the source has sync on the green channel, press ENTER to put an X in this box. However, Auto (See Auto above) takes care of this, and much more, for you.
5. Interlace	This displays whether or not Interlace is present in the signal; you can't change it.
H Freq:	Shows the horizontal frequency of the displayed signal. You can't change this value.
Lines:	Shows the number of horizontal lines in the displayed signal. You can't change this value.
V Freq:	Shows the frame rate of the displayed signal. You can't change this value.

Input Level

When the black and white levels are correctly set, the display will know what the absolute minimum and maximum signal amplitude is that the source is sending to it. The procedure for Input Level adjustment, and the menus for it, are different for computer sources and video sources.

You must adjust input level for *each* source that is connected to the display. Even if two similar sources are being used, such as two different SVGA sources, the input levels must be adjusted for the source that is connected at this time. When the other SVGA source is connected, the levels must be readjusted to match the new source. If the sources are connected to different inputs (SVGA, MAC, RGBS) then each source's Level can be set and saved separately in memory, because there is a different memory for each source-mode combination.

For all sources except composite and S-video, the input Black Level must be adjusted to match the source before adjusting the input White Level.

Note: Do not use Black Level Adjust and White Level Adjust to color balance the displays. Matching the displays so they all produce the same colors is done in a later step called Color Balance. Color Balance and Level Adjust are entirely independent of each other. Level Adjust **must** be done with external video signals. Color Balance should be done with internally generated patterns.

Adjust the Black Input Level - PC, MAC or RGBS Data

(This does not apply to Composite or S-Video sources – see Comp Video/S-Video Level Adjustment on page 38.)

Source Select
Frequency
Phase
Input Level
Position
Zoom
Wall Processor
Color Balance
Curtain
Hours
Save Config
Recall Config
Reset Config
Misc Control
About

Input Level
Black Level
White Level

Black Level		
(Requires black field)		
Auto	[]	
All	← →	
	Level	Sample
Red	126	000
Green	125	001
Blue	129	000

1. Display an all-black image from the signal source	Examples of all-black sources are a black PC Paint screen or frame 50882 on Reference Recordings, "A Video Standard" test disk. Note: It is not necessary for the entire screen to be black. The area of interest is within 100 pixels of the upper left corner of the Black Level menu.
2. Press the remote control LEVEL button	The Input Level menu is displayed.
3. Select Black Level	Press the Up/Down arrow keys to highlight Black Level. Press the ENTER button to display the Black Level menu.

4. Select Auto	Press the Up/Down arrow buttons to highlight Auto. Press ENTER to automatically set the display's black level point.
5. Exit from the Black Level menu	Press the PREV MENU button to exit out of the menus.

Adjust the White Input Level - PC, MAC or RGBS Data

(This does not apply to Composite or S-Video sources – see Comp Video/S-Video Level Adjustment page .)

Source Select
Frequency
Phase
Input Level
Position
Zoom
Wall Processor
Color Balance
Curtain
Hours
Save Config
Recall Config
Reset Config
Misc Control
About

Input Level
Black Level
White Level

White Level (Requires white field)		
Auto	[]	
All	← →	
	Level	Sample
Red	128	255
Green	128	255
Blue	128	255

1. Display an all-white image from the signal source	Examples of all-white sources are a white PC Paint screen or frame 50823 on Reference Recordings, "A Video Standard" test disk. It is not necessary for the entire screen to be white. The area of interest is within 100 pixels of the upper left corner of the White Level menu.
--	--

2. Press the remote control LEVEL button	The Input Level menu is displayed.
3. Select White Level	Press the Up/Down arrow keys to highlight White Level. Press the ENTER button to display the White Level menu.
4. Select Auto	Press the Up/Down arrow buttons to highlight the Auto feature. Press the ENTER button to automatically set the display's white level point.
5. Exit from the White Level menu	Press the PREV MENU button to exit out of the menus.

Comp Video/S-Video Level Adjustment

Source Select
Frequency
Phase
Input Level
Position
Zoom
Color Balance
Curtain
Hours
Save Config
Recall Config
Reset Config
Misc Control
About

Video Controls	
Brightness	128
Contrast	128
Saturation	128
Hue	128
Blue Only	[]
Sample	
R:010	G:008 B:149

This menu selection is only available when the source selected is Comp Video or S-Video in units with the VIM-300 option installed. It is not available when PC, MAC or RGBS sources are selected.

Brightness: This adjusts the overall lightness and darkness of the image.

Contrast: Increases the difference between light and dark parts of the image.

Saturation: Adjusts the amount of color the image has.

Hue: Changes the tint of images to be more green or more magenta colored.

1. Press the remote control LEVEL button	Brings up the Video Controls menu (must have Comp Video or S-Video selected as a source).
2. Display an all-black image from the source (not from the built-in test patterns)	Frame 50882 on Reference Recordings, "A Video Standard" test disk is an all-black image.
3. Adjust Brightness	<p>Set the Sample values for R, G and B as close to 001 as possible while keeping the Brightness number as high as possible.</p> <p>If all the initial Sample values (R, G, & B) are greater than 001, then reduce the Brightness number until the first Sample value reaches 001.</p> <p>If the initial Sample values are showing 001, then increase the Brightness number until all Sample values are 002 or greater. Stop adjusting when the last Sample value goes from 001 to 002.</p> <p>If Brightness is decreased while the Sample values are at 001, the color range for the displayed image will be decreased.</p>
4. Display an all-white image from the source	Frame 50823 on Reference Recordings, "A Video Standard" test disk is an all-white image.
5. Adjust Contrast	<p>Set the Sample values for R, G and B as close to 254 as possible while keeping the Contrast number as low as possible.</p> <p>If all the initial Sample values are less than 254 then increase the Contrast number until the first Sample value reaches 254.</p> <p>If the initial Sample values are showing 254 then decrease the Contrast number until all Sample values are 253 or less. Stop adjusting when the last Sample value goes from 254 to 253.</p> <p>If Contrast is increased while the Sample values are at 254, the color range for the displayed image will be decreased.</p> <p>Contrast and Brightness interact, so you may want to go back to check Brightness</p>
6. Display a standard SMPTE Color Bar pattern	A SMPTE Color Bar pattern is available at frame 17177 on Reference Recordings, "A Video Standard" test disk.
7. Enable the Blue Only function	Select the Blue Only option with the up/down arrows and press ENTER to enable it. At this point the screen will show only shades of blue.

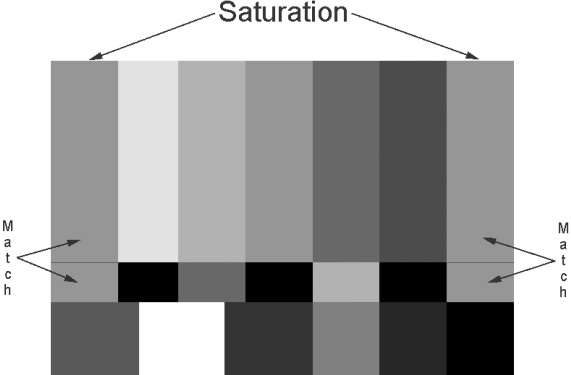
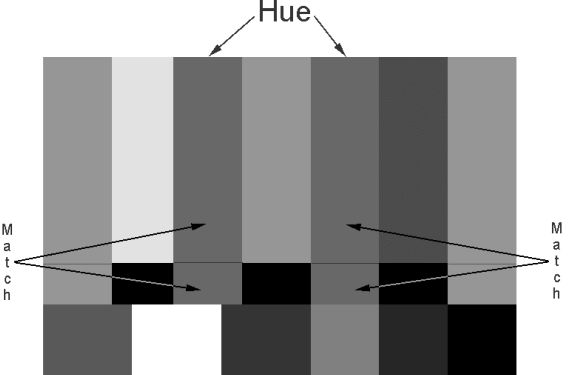
<p>8. Adjust Saturation</p>	<p>Adjust Saturation up or down until the large color bars at the each end of the pattern (white and blue) match the smaller color bars beneath them.</p> <p style="text-align: center;">Saturation</p> 
<p>9. Adjust Hue</p>	<p>Adjust Hue up or down until the two central color bars (cyan and magenta) match the smaller color bars beneath them.</p> <p style="text-align: center;">Hue</p> 
<p>10. Exit the Video Controls menu</p>	<p>Press the PREV MENU button on the remote. This will exit the menu and de-select Blue Only at the same time.</p>

Note: When using Video Controls, the Phase control does not affect the image at all.

Set the Sharpness

Source Select
Frequency
Phase
Input Level
Position
Zoom
Wall Processor
Color Balance
Curtain
Hours
Save Config
Recall Config
Reset Config
Misc Control
About

Misc Control
<input checked="" type="checkbox"/> Sharpness
<input checked="" type="checkbox"/> Buzzer Enable
<input type="checkbox"/> Flip Horz
<input type="checkbox"/> Flip Vert
<input type="checkbox"/> Auto Lamp On
<input type="checkbox"/> Test Patterns

Use the Sharpness menu to toggle Sharpness On/Off. The sharpness controls an internal electronic filter that reduces some types of video noise. It will soften the image when it is not checked and allows the video to pass unaffected (not softened) when the box is checked. In general, the sharpness should be off (no X) for composite and S-video sources, and on (with X) for PC, MAC, or RGBS sources.

1. Press the remote control MENU button	Displays the main menu.
2. Go to the Misc Control menu	Use the Up/Down arrow buttons to scroll down to the Misc Control item and then press the ENTER button to open it.
3. Select or de-select Sharpness	With the Sharpness option selected, the ENTER button will toggle Sharpness on and off. On for PC, MAC, RGBS. Sharpness has no effect on Composite or S-video.
4. Exit the menu	Pressing the PREV MENU button will exit the menu.

Adjust the Frequency

(This control has different effects with computer and video sources.)

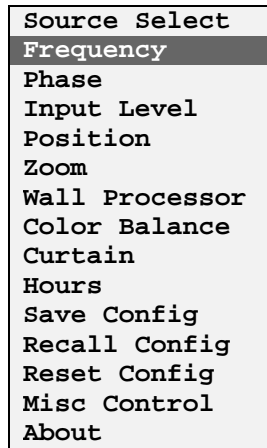

For RGBS, Composite, and S-video sources –

Use the **FREQ** function to adjust the image's horizontal width.

1. Press the remote control FREQ button	Displays the Frequency Select menu. Observe the horizontal width of the image.
2. Press the Left/Right arrow keys	Expand or contract the image horizontally. With standard mullion screens, hide 3 pixels behind the mullion at left and right. For Ultra-Thin Mullion screens, hide 1 pixel on each side, left and right.

For Computer (PC or MAC) sources –

Use the **FREQ** function to match the internal sampling clock of the display to the incoming video data.

1. Turn Sharpness on	In the main menu, highlight Misc Control and press Enter. If there is <i>not</i> an X for Sharpness, highlight Sharpness and press Enter.
----------------------	---

<p>2. Display an image containing many on/off (black/white) transitions</p>	<p>A fine-grain checkerboard pattern works best. One of the "fill" patterns in Windows 95 Paint has this. Start the Paint program found under Accessories. Select Image, Attributes, Black and White, OK, Yes. Select View and see that Color Box is checked. Choose the Fill tool (paint jar spilling over). In the bottom row of black/white shades, click the 9th box from the left. Click in the drawing area. Choose View, View Bitmap to fill the computer screen with this pattern.</p> <p>With MAC OS 8.0, look for a checkerboard pattern in File, Control Panel, Desktop Patterns.</p> <p>With Sharpness on (X), you will see vertical bands in the pattern, if the FREQ setting is not correct and does not match the input source,.</p>
<p>3. Press the remote control FREQ button</p>	<p>The FREQ adjustment menu is displayed.</p>
<p>4. Press the left/right arrow keys</p>	<p>The vertical bands will disappear when the frequency matches the incoming signal. For most computer inputs, this will be when the FREQ number is either 064 or 096. However, it is important to get rid of the vertical bands; the number is not important.</p>
<p>5. Press PREV MENU</p>	<p>Exit the FREQ menu.</p>

Adjust the Phase

Source Select
Frequency
Phase
Input Level
Position
Zoom
Wall Processor
Color Balance
Curtain
Hours
Save Config
Recall Config
Reset Config
Misc Control
About

Phase Select
028

Use the PHASE button to adjust the phase of the internal sampling clock relative to the incoming data. Phase noise is usually seen as fine, horizontal lines moving through the image or as flickering edges on the displayed text.

Note: For video inputs, the Phase control does not affect the image.

<p>1. Display an image containing many on/off transitions</p>	<p>A large checkerboard pattern works best. (See Adjust the Frequency, Computer Sources, Step 2 on page 43 to make one in Paint.) With Sharpness on (X), if the PHASE setting is not correct, the image will have thin horizontal lines running or "dancing" through it.</p>
<p>2. Press the remote control PHASE button</p>	<p>The PHASE adjustment menu is displayed.</p>
<p>3. Adjust the phase setting</p>	<p>Use the Left/Right arrow button to adjust for the best image quality with the least amount of noise. There may be two places in the Phase number where this happens. If there is a large range of numbers where you see no noise, find the "ends" of the clean range and set the Phase number between these two.</p>
<p>4. Exit the PHASE menu</p>	<p>Press the PREV MENU button to exit the menu.</p>

Position the Image

Source Select
Frequency
Phase
Input Level
Position
Zoom
Wall Processor
Color Balance
Curtain
Hours
Save Config
Recall Config
Reset Config
Misc Control
About

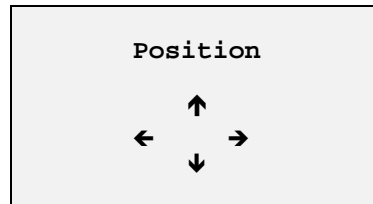

Use the arrow keys to adjust the position of the image on each display.

1. Press the MENU button on the remote control	Displays the main menu.
2. Go to the Misc Control menu	Use the Up/Down arrow buttons to scroll down to the Position item and then press the ENTER button to open it.
2. Position the image	Use the Up/Down/Left/Right remote buttons to move the image on the screen.
4. Exit the PHASE menu	Press the PREV MENU button to exit the menu.

Zoom

Source Select
Frequency
Phase
Input Level
Position
Zoom
Wall Processor
Color Balance
Curtain
Hours
Save Config
Recall Config
Reset Config
Misc Control
About

Zoom Factor			
	-	+	
Left	←	→	W:0640
Right	←	→	
Top	←	→	H:0480
Bottom	←	→	
[] Lock			
[] Default			

Use the arrow keys to adjust the size of the image on each VideoWall.

1. Press the MENU button on the remote control	Displays the main menu.
--	-------------------------

2. Press the Up/Down arrow keys	Move the cursor to the Zoom selection.
3. Press ENTER	Displays the Zoom Factor menu.
4. Scale the image	<p>Select an edge of the image that needs to be expanded or compressed (Left, Right, Up or Down). It is easiest to see the effect of Zoom when the image is a some form of geometry pattern, one that exactly defines the edges of the image. Note: The <i>internal</i> test pattern "Geometry" cannot be used for this purpose.</p> <p>With Clarity's Big Picture™, the zoom range is very large. Without Big Picture, the zoom is limited to ±10%.</p> <p>Selecting the Lock feature causes the image to scale the same amount in the opposite direction. If you scale the Right, the Left will scale by the same amount. Similarly, Up and Down</p> <p>The Default feature scales the image back to 800x600 or 640x480 pixels, depending on the source, or to some other values, depending on the Big Picture scaling.</p>

Step 3 - Adjust the Colors

Note: It is a good idea to read this whole section before you start color balancing.

Source Select
Frequency
Phase
Input Level
Position
Zoom
Wall Processor
Color Balance
Curtain
Hours
Save Config
Recall Config
Reset Config
Misc Control
About

Color Balance		
	Wht	Gry
All	↔	↔
Red	031	007
Green	031	007
Blue	031	007

Color balancing compensates for the differences in brightness of all display units in a video wall. You only need to do this once, as color

balance is the same for all sources. The color balance information is saved in memory in only one location, not for each source. However, when a lamp is changed, you should color balance again.

The goal of color balancing the displays is to match the brightness and white "color" of all the displays in video wall to each other, and then match the intermediate gray shade. Therefore, color balancing is accomplished with all displays turned on in the finished video wall. (If you have only one unit, color balancing is not very important.) Do not start color balancing until all lamps have been on for at least five minutes.

The color balance menu provides control over the individual RED, GREEN, and BLUE settings to balance the white color, as well as an ALL adjustment to control the overall luminance by changing all three colors together. Similar control for the RED, GREEN, and BLUE settings is provided to adjust the balance of the gray shades without affecting the white balance.

The down arrow key moves the cursor from All to Red, Green, and Blue in the White column, then to All, Red, Green, and Blue in the Gray column, then back to All in the White column again. The left/right arrow keys increase and decrease the brightness number. It is a common mistake to use the left-right arrow buttons to try to move the cursor between columns. Doing this simply changes the currently selected value.

For white balancing, the individual RED, GREEN, and BLUE color selections have a number between 0 and 31. Zero is the darkest and 031 the brightest.

For gray balancing, the individual RED, GREEN, and BLUE balance settings have a number associated with them between 0 and 7. Zero is the darkest and 007 the brightest.

The following chart shows the relationship of the menu item adjustments.

Color	Increase will:	Decrease will:
All	Increase the overall luminance (brightness)	Decrease the overall luminance (brightness)
Red	Change white toward red	Change white toward cyan
Green	Change white toward green	Change white toward magenta
Blue	Change white toward blue	Change white toward yellow
Note: If one color needs to be increased, but that color is already as high as it can go, then the other two colors can be decreased.		

Use the White and 50% Gray internal Test Patterns from the **Misc Control** menu, not an external pattern.

1. Display an all-white image	On each display in the video wall, open the Misc Control menu, select Test Pattern and choose White.
2. Open the COLOR menu	Press the Color button on the remote control, or choose Color Balance from the main menu and press Enter.
3. Maximize <i>all</i> settings	Adjust the WHT setting of <i>all</i> the displays to 031; adjust the GRY setting of <i>all</i> displays to 007.
4. Identify the least-bright display in the system	The least bright display is already as bright as it can be. This display will serve as a baseline to which the other displays will be adjusted. Note: The baseline display does not have to be the middle one. It should be the darkest one, wherever it is in the wall. The darkest display is called the “baseline” display.
5. Luminance match the displays	Select one of the displays next to the baseline display. This will be called the “variable” display. Turn off the Color Balance menu to all displays except the variable display. In the Color Balance menu on the variable display, highlight the arrows under the Wht . Use the left arrow to reduce the brightness until the variable display is the same brightness as the baseline display.
6. Color balance the displays – white mode	On the variable display, adjust the amounts of RED, GREEN, and BLUE in the white (Wht) column to achieve the best match in color and luminance to the baseline display. If a color needs to be increased, but that color is already as high as it can go, then the other two colors can be reduced. For instance, if you need the white to be have more red, but red is already at 031, reduce the green and blue. This will make the display look more red.
7. Adjust the next display	When the variable unit matches the baseline, it can serve as a new baseline unit for its neighbors. Continue to work outward from the original baseline display, one cube at a time. Do not go to the next step of adjusting for Gray until you are satisfied that all the displays look the same for a white image. It is not important to obtain <i>pure</i> white; it is only important that all the displays look the same.
8. Display a 50% gray image	On each display in the video wall, open the Misc Control menu, select Test Pattern and choose 50% Gray.
9. Identify the least bright unit again	Find the unit that looks the darkest. This may not be the same one that was the darkest one with a White test pattern. This is the baseline unit for Gray.
10. Color balance the displays – 50% gray mode	Using the same technique of adjusting a variable display to the baseline display, match the color and brightness of all cubes, working with one cube at a time and working outward.

A helpful technique to use when adjusting the colors and gray shades is to “overshoot” as you adjust to emphasize the effect that the current adjustment

is having to the overall image. Then back off to fine tune. This helps to give an intuitive feel for the color balance process.

It is often helpful to switch between the internal white and gray patterns and actual video images to fine tune the system. Avoid making major changes when adjusting to the video images because this can throw off the white or gray balance. Remember also that the Input Level adjustment has a large effect on color. If Input Level adjustments have not been made, color balance for live video will be difficult. However, you may adjust Color Balance *before* or *after* you do the Input Level adjustment. They do not affect each other – that is, an adjustment in Color Balance does not affect the Input Level adjustment, and vice versa – but they must both be adjusted properly for the screens in the cube to match in color, luminance and black level.

Do *not* adjust Color Balance with Red, Green and Blue test patterns. This is a method sometimes used with CRT displays, and it will not work with these Clarity displays. The primary colors have been matched at the factory. If you get the whites and grays to be the same over a whole wall, all the other colors will be the same, too.

After you have color balanced all the units, save the settings for each unit. It does not matter which source-mode combination you save, because color balance data is saved once for all sources and modes. You should not have to color balance the displays again until you change a lamp. However, lamps near the end of their life may begin to change color, so it is a good idea to check color balance occasionally.

Note: Setting the Gray color balance levels near 004 or 003 will often give improved performance when the primary program source is composite or S-video. To try this, reduce the overall brightness of the gray baseline cube to these levels in the Gry column. Adjust this baseline cube to have the least amount of color in the 50% gray field. Then balance the other cubes to this one.

Step 4 – Save, Recall, or Reset the Settings

After all adjustments have been made, Save the settings. There is a separate Save location for each source in each mode – PC at 800x600, PC at 640x480, RGBS at 31.5 MHz, RGBS at 15.75 MHz, etc. After you have adjusted the displays for one source, save these settings before going to the next source and adjusting it.

The Save, Recall, and Reset menus look alike and operate in the same way, so the explanation for Save will tell you how the Recall and Reset menus operate. (Resetting does *not* overwrite the memory where settings are saved. See Figure 4 later in this section.)

Source Select
Frequency
Phase
Input Level
Position
Zoom
Wall Processor
Color Balance
Curtain
Hours
Save Config
Recall Config
Reset Config
Misc Control
About

<p>Save Configuration</p> <p>← → ALL</p> <p>← → ALL</p> <p>Save</p>	<p>Source</p> <ul style="list-style-type: none"> • All PC MAC 9-PIN BNC C-Video S-Video
---	--

<p>Save Configuration</p> <p>← → PC</p> <p>← → ALL</p> <p>Save</p>	<p>Mode</p> <ul style="list-style-type: none"> • All 640x480 800x600
--	---

1. Press the remote control MENU button	The Main menu is displayed.
2. Press the Up/Down arrow keys	Move the cursor to the Save Config (or Recall Config or Reset Config) selection.
3. Press ENTER	The Save Config (or Recall Config or Reset Config) menu is displayed.
4. Press the Up/Down arrow keys to highlight the <i>upper</i> pair of arrows ← →	This is the Source selection area. The list of sources is shown in the right column, with the current selection preceded by a bullet • and stated next to the arrow symbols.
5. Press the Left/Right arrow keys	Use the left/right buttons to choose the Source you want to Save/Recall/Reset.
6. Press the Up/Down arrow keys to highlight the <i>lower</i> pair of arrows ← →	This is the Mode selection area, where you will choose the modes that will be Saved/Recalled/Reset for the previously selected Source. There is a separate memory for <i>each</i> source in <i>each</i> mode.
7. Press the Left/Right arrow keys	Use the left/right buttons to choose the Mode you want to Save/Recall/Reset. (If the Source is "ALL," the only choice for Mode is also "ALL.")
8. Press the Up/Down arrow keys to highlight Save (or Recall or Reset)	Press ENTER. A new menu appears as shown below.

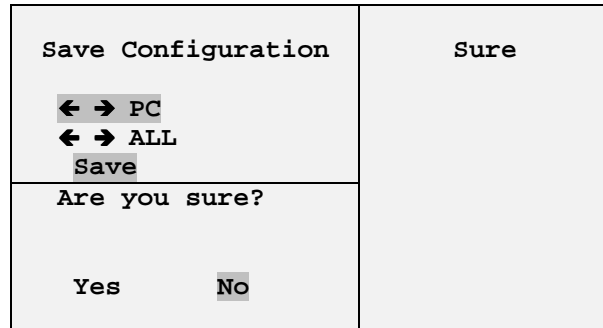

9. Press the Left/Right arrow keys to highlight Yes	Press ENTER. The settings will be saved/recalled/reset for the Sources and Modes you chose.
---	---

Shortcut: Unless you have made changes to a source or mode that you *do not* want to save, it is easiest and safest to Save All sources, All modes.

Note: Resetting to factory default settings does *not* destroy the saved settings in memory until you Save them.

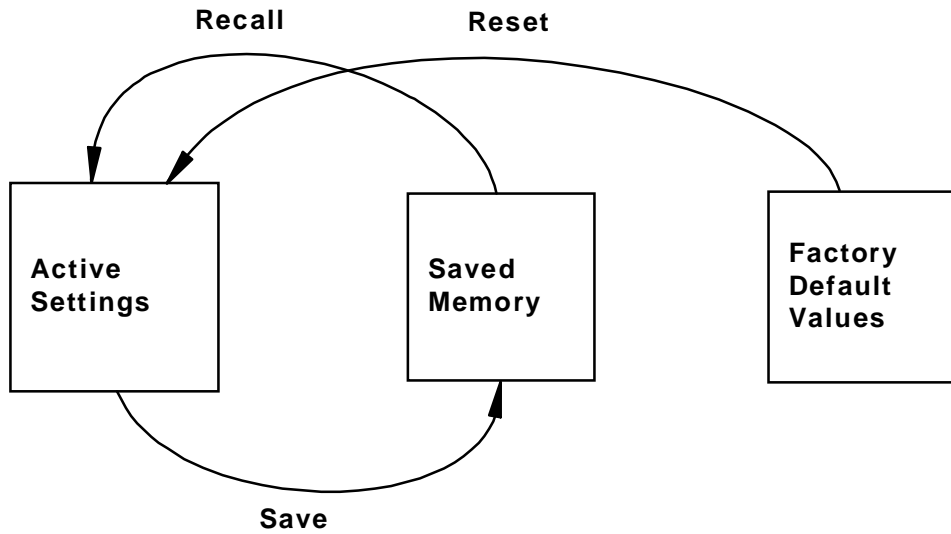

Figure 5 Block diagram of memory system

Turning off the System

Turning off the Display, Entering Standby Mode

When the OFF button on the remote is pressed, the display will power down and, after about 5 seconds, the STANDBY LED will turn on. When the STANDBY LED is on, the display is in the standby mode and is ready to be turned on again.

Turning off the Main Power Switch

Turn off the main power switch only for servicing or moving the display or if the display will not be used for an extended period of time.

The main power switch on the power module also acts a circuit breaker. If power to the display is lost, check the power/breaker switch by turning it off and then back on.

The power switch is a lighted switch. When it is lit, it indicates that the AC power is applied and the power switch is on.

Clarity's Big Picture™

Wall Processor Setup Instructions

These are the basic steps to follow to display a single image over an entire wall of displays. Big Picture can be setup and saved for each video source, so you can switch between sources while maintaining the specific magnification and position settings for each source.

<p>1. Build the wall</p>	<p>Install the wall and attach source and power cables as described in earlier sections.</p> <p>Use an amplifier/splitter device (distribution amplifier) from the source or, if you are using loop-thru, use short, shielded cables to minimize noise and image jitter.</p>
<p>2. Select the Source and Mode</p>	<p>In the menu for <i>each</i> display, select the source that will use Big Picture. If this is a computer source, use Auto for Mode selection.</p>
<p>3. Adjust the image settings</p>	<p>As described in Step 2, Step 3, and Step 4 in earlier sections, adjust black and white levels for each display; set phase and frequency; color balance the wall.</p>
<p>4. Disable wall mode</p>	<p>Open the Wall Processor menu and make sure that the <u>Wall mode</u> feature at the bottom of the menu is <i>not</i> checked. Do this for <i>each</i> display.</p>
<p>5. Reset Zoom</p>	<p>Set Zoom in the menu to the default width and height of 800x600 or 640x480, depending on the Source and Mode.</p>
<p>6. Center the image</p>	<p>Find the edges of the image using the arrow buttons in the Position menu to move the image.</p> <p>For standard mullions, each mullion covers 3 pixels of the image and each button press in the Position menu moves the image one line or pixel at a time. Move the image so that 3 pixels on each side of the image are behind their respective mullions. For Ultra-Thin Mullion screens, one pixel should hide behind each mullion.</p> <p>When you move the standard size (not zoomed) image, if you find that more or fewer than 3 pixels (or one pixel) are hidden, then the optical image size needs to be adjusted. Do not Zoom the image to accomplish this.</p>

<p>7. Set each display's address (See note below for walls larger than 4x4.)</p>	<p>Assign each display a unique address using the Unit ID knob. Both the Group and Unit ID numbers are used</p> <p>The address of the display in the upper left corner (as seen from the front) <i>must</i> be zero. The addresses of the other displays must increase left to right, top bottom, increasing by one for each display. Therefore, the display in the lower right corner (as seen from the front) <i>always</i> has the highest address.</p> <p>2x2 example →</p> <table border="1" data-bbox="1000 548 1367 779"> <tr> <td>00</td> <td>01</td> </tr> <tr> <td>02</td> <td>03</td> </tr> </table> <p>(Seen from the front)</p> <p>3x3 example →</p> <table border="1" data-bbox="1000 789 1367 1083"> <tr> <td>0</td> <td>1</td> <td>2</td> </tr> <tr> <td>3</td> <td>4</td> <td>5</td> </tr> <tr> <td>6</td> <td>7</td> <td>8</td> </tr> </table>	00	01	02	03	0	1	2	3	4	5	6	7	8
00	01													
02	03													
0	1	2												
3	4	5												
6	7	8												
<p>8. Set the Wall Size on each display</p>	<p>Open the Wall Processor menu. Enter the horizontal and vertical wall size. Each display's menu should show the same horizontal and vertical wall size.</p> <p>Each display should show a different Current Unit value. This value represents its location in the wall.</p>													

Note: Clarity's Big Picture handles up to a 6x6 video wall. Because the Unit knob only has 16 positions, the Group knob must be used for all walls that have more than 16 displays. A 6x6 wall would be numbered like this (top number is Group; bottom number is Unit):

00	01	02	03	04	05
06	07	08	09	0A	0B
0C	0D	0E	0F	10	11
12	13	14	15	16	17
18	19	1A	1B	1C	1D
1E	1F	20	21	22	23

```

Source Select
Frequency
Phase
Input Level
Position
Zoom
Wall Processor
Color Balance
Curtain
Hours
Save Config
Recall Config
Reset Config
Misc Control
About
    
```

If the display has Big Picture, you will see a menu like this:

```

Wall Processor

Wall Size:
Horizontal: 002
Vertical: 002
Current Unit: 01

Misc:
[ ] Calc wall pos
[ ] Wall mode
    
```

If this unit does **not** have Big Picture, you will see a menu like this:

```

The Big Picture option is not
installed. Please see the
About menu for contact
information on purchasing
the Big Picture option.
    
```

<p>9. Put each display into Wall Mode</p>	<p>Move the menu cursor to the <u>Calc wall pos</u> line and press the ENTER button. This calculates the position of the selected display within the image and puts the display into Wall Mode. Each display will now show only its segment of the overall image.</p> <p>Do this with each display in the wall and exit the Wall Processor menu.</p>
<p>10. Fine tune the wall image</p>	<p>If the previous steps were done correctly, the image in each display should not need to be adjusted by more than two lines or pixels in any direction.</p> <p>If an adjustment to the image must be made, use the Zoom menu to move only the edge that needs adjustment.</p>

11. Save the settings

Open the Save Config menu and save the settings for the current Source and Mode on each display, as described above in *Step 4 – Save, Recall, or Reset the Settings* on page 50.

If there are other video sources on different input connectors that will use Big Picture, go through the previous process for each video source. Then save these settings.

Loop-Thru of Source Video

Loop-thru works in different ways depending on the type of source.

If the source video is PC or MAC, the same signal is output from the LOOP-THRU connector, which can be connected to the next unit's PC input.

If the source is RGB with separate composite sync at 31.5 kHz (progressive scan), it will come out the LOOP-THRU connector as RGB with the composite sync on the connector's H-Sync pin and separated V-Sync on the V-Sync pin. Feed this to the next unit's RGBS connector. It might also work to feed this to the next unit's PC connector.

If the source is RGB Sync on Green at 31.5 kHz (progressive), it will come out the LOOP-THRU connector as RGB-Sync on Green, plus composite sync on the H-Sync output pin, and separated V-Sync on the V-Sync pin. Feed this to the next unit's RGBS connector. It might also work to feed this to the next unit's PC connector.

If the source is RGBS at 15.75 kHz (interlaced), the output from the LOOP-THRU connector will also be 15.75 kHz. *It will not work* to loop this output to the next display's PC input, because the PC input is expecting 31.5 kHz. To loop RGBS at 15.75 to the next display, make an adapter to go from 15-pin to 9-pin using the wiring diagram below. Standard 15-pin-to-9-pin adapters may also be available from some computer stores. Connect the first display's LOOP-THRU output to the next display's 9-pin RGBS input. Alternatively, use a 15-pin to 4-BNC adapter cable. These are also usually available from electronics or computer stores.

Composite and S-video inputs have their own separate loop-thru connectors. These are buffered. The inputs are terminated in 75 ohms. Using video loop-thru slightly degrades signal quality as the signal goes through each cube. The amount of degradation depends on cable quality, source video, and the number of loops. If this degradation becomes a problem, use a signal splitter or distribution amplifier to directly drive each cube or to at least reduce the number of loops.

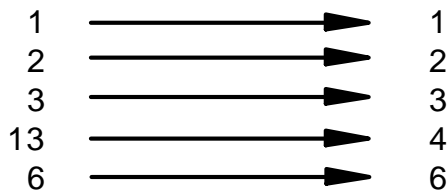
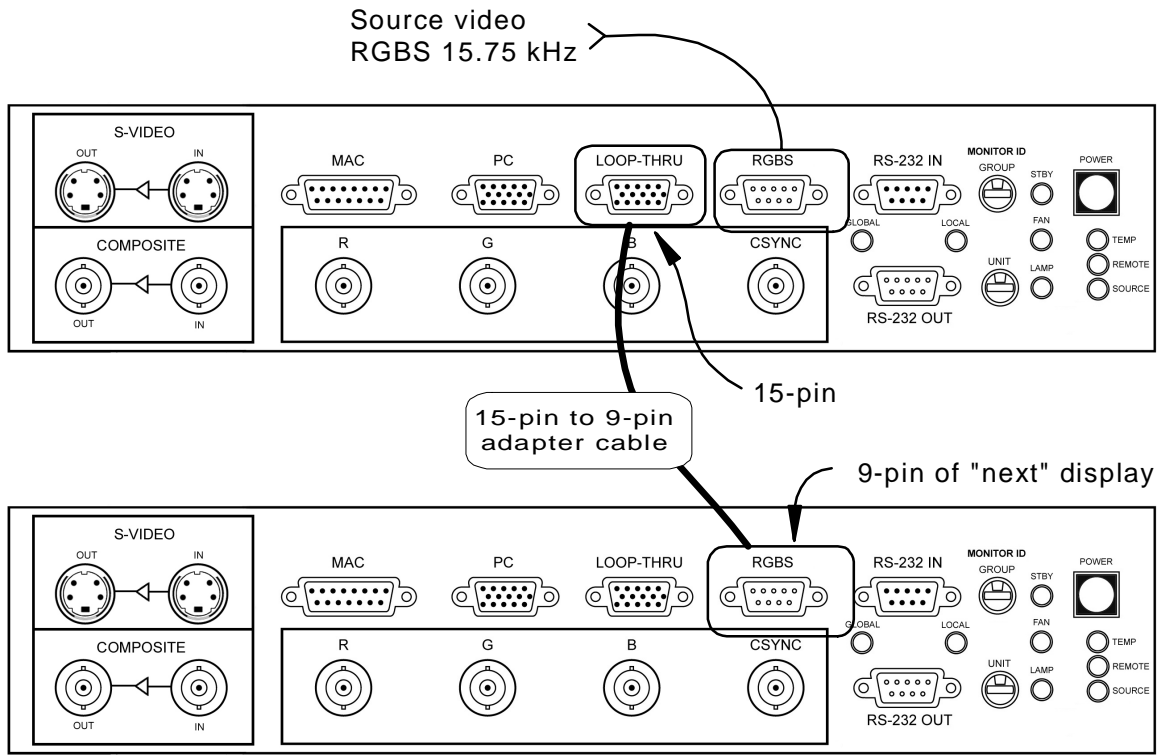

Installing Big Picture Option Key

The Big Picture Option Key enables the functions and features associated with Clarity's Big Picture™. The Option Key consists of an integrated printed circuit board assembly and a cable harness. Included as part of the Printed Circuit Board Assembly are two adhesive-backed, nylon, PC board mounts. To install it, follow these steps.

1. Turn off the power	If the display is on, turn it off with the remote control (or by pressing the button on the rear panel). Wait for the fans to stop (30 seconds). Turn off the power with the switch at the power supply input and remove the power cord.
2. Remove cover	Remove the rear access cover.
3. Plug in the connector	Plug the connector of the Big Picture Option Key into the 2x7 connector on the Electronics Module.
4. Mount the circuit board	Remove the protective backing from the PCB mounts. Apply the mounts and board assembly to floor of the chassis to the left of the electronics module.
5. Turn on power	Connect the power cord and start the display as usual. Note: The Big Picture Option Key can be installed without turning off the power. However, the Electronics Module must be re-started from a no-power state to recognize the presence of the key.

Other Features and Adjustments

The following features and adjustments are available via the remote.

Curtain

Source Select
Frequency
Phase
Input Level
Position
Zoom
Wall Processor
Color Balance
Curtain
Hours
Save Config
Recall Config
Reset Config
Misc Control
About

Curtain Select
[] Curtain On

The Curtain feature causes the screen to turn black even if source video is present. There are two different methods of turning the curtain on.

1. Press CURTAIN on the remote	Displays the Curtain Select menu.
2. Enable CURTAIN	Press ENTER to toggle Curtain on. Screen is black.

To show program material again, repeat steps 1 and 2.

Monitor Select

Disables most remote functions on the display to prevent the unit from unintended adjustment via the remote control.

1. Press MON SEL on the remote	The Monitor Select menu is displayed.
2. Enable Monitor Select	Press the ENTER button to enable the Monitor Select feature.

To restore full remote functionality, follow steps 1 and 2 again to disable the Monitor Select feature. Monitor Select is not available on the main menu.

ID

This menu item displays the current Monitor ID address of the WN-5230-S. The Monitor ID is set with the 2 Monitor ID knobs on the back of the display. The Monitor ID menu displays the address as the Group and Unit which corresponds with the knob settings on the back of the display. ID is not available on the main menu.

1. Press ID on the Remote	Displays the Monitor ID position as selected by the Monitor ID switch in the rear of the unit.
---------------------------	--

Miscellaneous Controls

The Misc Control menu contains:

- Sharpness
- Buzzer Enable
- Horizontal Flip
- Vertical Flip
- Auto Lamp On
- Test Patterns

```
Source Select
Frequency
Phase
Input Level
Position
Zoom
Wall Processor
Color Balance
Curtain
Hours
Save Config
Recall Config
Reset Config
Misc Control
About
```

```
Misc Control

[X] Sharpness
[X] Buzzer Enable
[ ] Flip Horz
[ ] Flip Vert
[ ] Auto Lamp On
[ ] Test Patterns
```

The Misc Control menu contains several features that are enabled when an X is in the box. To put an X in a particular feature's box, or to remove it, press the ENTER button when that item is highlighted.

Sharpness - When this feature is disabled, the computer video will be smoothed. This is done to reduce video noise and other artifacts that are present when the source resolution is expanded to fit the WN-5230-S or when the quality of the source signal is not very good. Phase and Frequency have little or no effect on the image with Sharpness disabled. With Sharpness enabled, it is very important to correctly set the Frequency and Phase of the display. In general, Sharpness should be ON for computer sources, OFF for composite and S-video sources.

Buzzer Enable - When this feature is enabled, a buzzer will sound whenever the display detects a valid command from the remote. If disabled, commands are received silently.

Flip Horz – Reverses the image horizontally.

Flip Vert – Reverses the image vertically.

Auto Lamp On - When AC power is applied to the power module, the display will automatically turn on after the 30 second standby-delay time has elapsed (plus the Monitor ID delay time), if Auto Lamp On has an X. Use this when it is important to have the displays on whenever power is available. If this feature is enabled and the AC power to the system is lost, when the power returns later, the display will automatically come back on.

Test Patterns – Brings up a menu of internally generated test patterns.

```

Test Patterns
[ ] Off
[ ] White
[ ] Black
[ ] 50% Gray
[ ] Red
[ ] Green
[ ] Blue
[X] Geometry (red)
[ ] Geometry (cyan)
[ ] Geometry (black)

```

Most of these patterns are self explanatory. Here are a few that deserve a description.

Off - Disables the internal patterns and allows the source data/video to be displayed

Geometry - Displays a white background with a red, cyan or black grid pattern depending on which one is selected.

The White and Black test patterns cannot be used when adjusting Input Levels. The internal White and 50% Gray patterns are used to Color Balance the displays.

Reset Lamp Hours

After you change the lamp, use this menu to reset the lamp hour timer to zero. Lamp hours count up whenever the VideoWall is running (FAN and LAMP LEDs are on). The system hour timer displays the total hours that power has been applied to the VideoWall with the power supply switch on. The system hour timer cannot be reset.

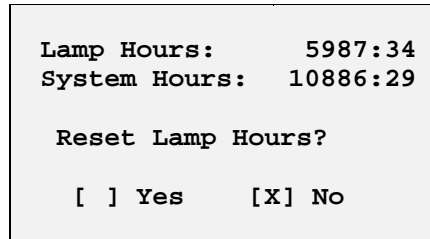
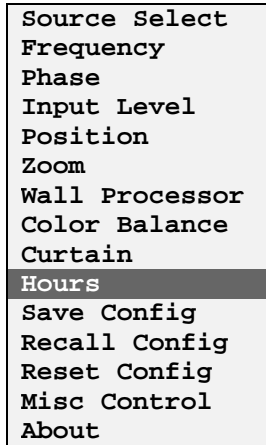

1. Press the MAIN MENU button on the remote	The Main menu is displayed.
2. Press the up/down arrow keys	Move the cursor to the Hours selection.
3. Press ENTER	The Lamp Hours menu displays the current number of lamp operating hours. Replace the lamp at 8,000 hours. This menu also shows total system hours.
4. Press left/right arrow keys	Use the left or right arrow keys to highlight the Yes selection.
5. Press ENTER	Press the ENTER button to proceed in resetting the lamp hours to zero.
6. Press left/right arrow keys	At this point a warning will prompt 'Did You Replace The Lamp?' If the lamp was replaced, use the left or right arrow keys to highlight the Yes selection.
7. Press ENTER	Press the ENTER button to proceed in resetting the lamp hours to zero.

About

This displays the Clarity Visual Systems contact information. It also displays the version of firmware being used. (The Project and Build information is of concern only to manufacturing.)

```
Source Select
Frequency
Phase
Input Level
Position
Zoom
Wall Processor
Color Balance
Curtain
Hours
Save Config
Recall Config
Reset Config
Misc Control
About
```

```
Clarity Visual Systems
9025 SW Hillman Court
Suite 3122
Wilsonville, OR 97070
USA

Tel(503) 570-0700
Web www.ClarityVisual.com

Project: 573-0650-00
Version: Rev A
Config: C1A5P3N6
Build: 0036
Date: Fri, Mar 12, 1999
```

Cleaning and Maintenance

Once the WN-5230-S is set up and adjusted, periodic maintenance will consist of cleaning the display and replacing consumable parts such as the lamp and filter. Use the procedures in this section to remove and replace WN-5230-S modules as needed to maintain trouble-free operation.

Lamp

Before you remove the lamp, switch off the WN-5230-S with the remote control, or press the black POWER button on the electronics module, and allow the lamp cooling cycle to finish (30 seconds). Then switch off the power at the rear panel AC switch.



CAUTION

The lamp is *very* close to its cooling fan. This fan *does not* stop when the lamp turns off or after the cooling period. It is always running, unless power is removed from the whole unit. When you remove the lamp, your fingers may go into the moving fan. Whether you replace the lamp from the front or from the rear, remove the power cord or switch off the power at the power input on the rear panel, before removing the lamp.

The WN-5230-S has three screen options:

- The **standard screen** has a mullion about 1/8th inch (3 mm) wide. The mullion is a strip of sheet metal surrounding the screen which holds it in place.
- The **Ultra-Thin Mullion Screen**, or mullionless screen, does not have the 1/8th inch strip of sheet metal around the screen. The viewing area of the screen goes right to the edge of the display unit. This makes the lines between display units much less apparent in the finished video wall.
- **Blackscreen**, like the Ultra-Thin Mullion screen, but looks black when no signal is applied.

With standard screens, electrical interlocks prevent operation when the front screen is removed. Do not operate the display with any access

panels or the front screen removed from the unit, except when required for servicing. Operating the display with access panels or the front screen removed can expose service or operating personnel to ultraviolet burns and high electrical voltages. Always wear ultraviolet-blocking eyewear with side guards when servicing the display.

For Standard Screens, removing the screen provides service access to other replaceable modules from the front of the display. Service access for units with Ultra-Thin Mullion Screens is from the rear only.

Lamp Replacement, Front, Standard Mullion Screens



CAUTION For the standard screens, with the wider mullion, the screen may be removed by hand from stand-alone displays without damaging the screen. Where screen edges are adjacent to each other in a video wall, removing the screen without a screen removal tool may damage the female part of the screen latch. In video wall configurations, use the SRT-100 Screen Removal Tool (see instructions below and Options on page 2) to prevent damage to the screen.

Follow these steps to remove the **standard, wider mullion** screen and replace the lamp, if the display unit is *not* built into a video wall. Read all the steps before starting.

1. Turn off the power	Switch off the WN-5230-S using the remote and allow the cooling cycle to complete (30 seconds) before switching off the AC power at the rear-panel switch.
2. Unplug power cord	Important: Remove the AC power cord from the display.
3. Grasp the screen on each side at the bottom	The "screen" you are removing is 5 inches thick. Pull out at the bottom first, to separate the latch-hooks from the latches. It comes out with a "pop." The screen should now be loose at the bottom, but still attached at the top. If the display unit is part of a video wall, see Note below about screen removal tool.
4. Slip fingers between the screen frame	Slip fingers between the screen frame and the display chassis, as close to the top latches as possible and pull the top of the screen from the latches.
5. Using both hands...	Carefully remove the screen and set it aside.
6. Open the projector compartment hood	There are two spring latches on the projector compartment hood. Pull these latches towards each other and pull the hood towards the front of the display to open it.
7. Remove the lamp access door	On the left side of the optical engine is the lamp access door. Pinch the latch to open and remove the door.

8. Detach the lamp cable	<p>Using your thumb and middle finger to unlock the lamp cable connector, use your index finger to pull the connector away from the lamp.</p> <p>The lamp cable will remain connected to the optical engine.</p>
9. Remove the lamp	<p>Push the lamp to the right (into the optical engine) while turning counterclockwise. The lamp will rotate about an eighth of a turn, and then it can be pulled to the left (out) and removed.</p>
10. Install the new lamp and reassemble the display	<p>Reinsert a UHP 100W lamp in the same orientation. Push the lamp in and rotate the lamp clockwise until it locks into place.</p> <p>When attaching the lamp cable, pinch the connector clamp together while inserting the connector. The connector is keyed so it will only go on one way.</p> <p>Replace the lamp access door on the optical engine.</p> <p>Close and latch the projector compartment hood.</p>
11. Reinstall	<p>Reinstall the screen by lining up the latches and pressing the screen inward. It will go in with a distinct "pop." Give it a slight pull to see that it is securely in place.</p>

Removing a Standard Screen Using the Screen Removal Tool

1. Find the bumps on the side mullions	<p>On both sides of the screen, near the top and bottom, the mullion is slightly lifted from the screen material, forming a little bump. The removal tool fits here.</p>
2. Insert the removal tool	<p>The small hook on the removal tool slips under the bump in the mullion. The other side of the tool should press against the mullion of the neighboring screen. Use care when using the tool so it doesn't scratch the screen material.</p>
3. Squeeze the handle of the SRT-100	<p>Squeezing the handle of the removal tool pulls one screen out far enough to let it "pop" out at that corner. The tool uses the neighboring screen for leverage.</p>
4. Repeat for all four corners	<p>Remove the screen carefully and set it aside.</p>

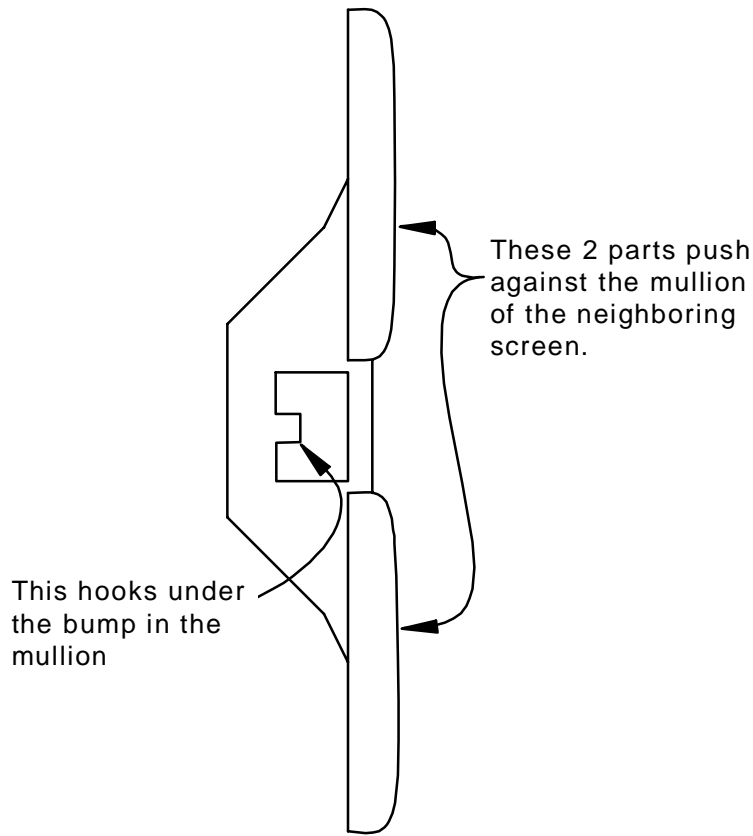

Figure 6 SRT-100, Screen Removal Tool

Lamp Replacement, Rear Access, Any Screen Type

1. Turn off the power	Switch off the WN-5230-S using the remote and allow the cooling cycle to complete (30 seconds) before switching off the AC power at the rear-panel switch.
2. Unplug power cord	Remove the AC power cord from the display.
3. Remove the rear access cover	Unfasten the 9 quarter-turn screws on the rear access cover and remove the cover.
4. Remove the lamp access door	On the right side of the optical engine is the lamp access door. Pull on the latch to open and remove the door.
5. Detach the lamp cable	Using two fingers to unlock the lamp cable connector clamp, use a third finger to pull the connector away from the lamp. The lamp cable will remain connected to the optical engine.

<p>6. Remove the lamp</p>	<p>Push the lamp to the left (into the optical engine) while turning counterclockwise. The lamp will rotate about an eighth of a turn before it can be pulled to the right and removed.</p>
<p>7. Install the new lamp and reassemble the display</p>	<p>Reinsert a UHP 100W lamp in the same orientation. Push the lamp in (to the left) and rotate the lamp clockwise until it locks into place.</p> <p>When attaching the lamp cable, pinch the connector clamp together while inserting the connector. The connector is keyed so it will only go on one way.</p> <p>Replace the lamp access door on the optical engine.</p> <p>Replace the rear access cover.</p>

Air Filter

Length of time between air filter replacements depends on the environment in which the WN-5230-S is operated. Check the air filter periodically and replace it when it is dirty, but don't use it for more than 8,000 hours. An excessively dirty air filter can block air flow to the optical assembly and cause excessive heat buildup inside the WN-5230-S. The air filter is most easily accessed from the rear of the WN-5230-S by first removing the rear access cover.

Air Filter Replacement, Front Access

<p>1. Turn off the power</p>	<p>Switch off the WN-5230-S using the remote and allow the cooling cycle to complete (30 seconds) before switching off the AC power at the rear-panel switch.</p>
<p>2. Unplug power cord</p>	<p>Remove the AC power cord from the display.</p>
<p>3. Follow appropriate steps for screen removal</p>	<p>Follow the steps outlined for Lamp Replacement to remove the Standard Screen. If the screen is Ultra-Thin Mullion or Blackscreen, the air filter must be replaced from the rear.</p>
<p>4. Open the projector compartment hood</p>	<p>There are two spring latches on the projector compartment hood. Pull these latches towards each other and pull the hood towards the front of the display to open it.</p>
<p>5. Replace the air filter</p>	<p>The air filter is located behind the two cooling fans on the right. Use a flat blade screwdriver to pry the filter to the left. When the filter has cleared the bracket, carefully (to avoid dropping dust) remove it from the display.</p>

Air Filter Replacement, Rear Access

1. Turn off the power	Switch off the WN-5230-S using the remote and allow the cooling cycle to complete (30 seconds) before switching off the AC power at the rear-panel switch.
2. Unplug power cord	Remove the AC power cord from the display.
3. Remove the rear access cover	Unfasten the 9 quarter-turn screws on the rear access cover and remove the cover.
4. Replace the air filter	The air filter is on the left side of the display. To remove it, pull it to the right.

Cleaning the Screen and Mirrors

The best way to clean screens and mirrors is with clean, dry, compressed air and try to blow off the debris. If this does not work (a finger print, for instance) use a good quality optical cleaning solution and lint-free paper wipes or cheesecloth. **Note:** Apply the liquid cleaning agent to the tissue first; don't spray it directly on the mirror or screen. This will sometimes appear to leave a light residue, but it will buff off, leaving a streak-free mirror. Because the mirrors are front-surface mirrors, use care when cleaning them.

Some representative cleaning products are:

- **Zero Charge Screen & Keyboard Cleaner**, made by Tech Spray, Amarillo, Texas; (803) 372-8523
- **Klear Screen Laptop & Computer Screen Cleaner**, by Merridrew Enterprises, Danville, California; (510) 838-8774
- **Sparkle**, made by Paulson and Roles, Portland, Oregon; (503) 282-3289

The inside of the screen is harder to clean; usually the problem on the inside is finger prints. Do not use cleaning products on the inside of the screen. Instead, use a little isopropyl alcohol on a piece of cheese cloth, and don't press hard. Don't buff it off. Let the alcohol evaporate.



CAUTION The screen is a laminate of two pieces. If excess liquid runs down the screen and collects at the bottom, it can wick up between the two parts. This is nearly impossible to correct.

Troubleshooting

This section provides tips and strategies for resolving problems or issues you may encounter, either during installation or in normal use of the WN-5230-S. Many problems can be rectified without the need for service by following the troubleshooting steps below.

If you are unable to resolve the problem by following the suggestions listed under the Failure Symptoms column, you will need to contact your service provider.

Power and Start-Up Problems

When AC power is applied to the unit by turning on the main AC power switch, the display enters a 30 second standby-delay period to prevent ignition of a hot lamp. During this time, the display will not accept commands from the remote control.

The unit enters the Standby mode when the 30 second standby-delay sequence is complete. The display is ready to accept an "ON" command when the Standby LED comes on.

This is the sequence of events that must occur for a WN-5230-S to power-up and display an image.

Normal Power-Up Sequence	Sequence Note	Failure Symptoms At This Part Of The Sequence
1. Attach acceptable AC power to the display	The power module is auto ranging – no voltage selection is necessary	
2. Turn on main power switch	<p>The main power switch is located on the back of the WN-5230-S, next to the connector that the AC power cord plugs into</p> <p>The switch also acts as a circuit breaker in case of power overload</p> <p>The switch light indicates when AC power is applied and the switch is on</p>	
3. Electronics go into standby-delay mode	<p>Standby LED flashes for 30 seconds</p> <p>The status LEDs are located on the rear connector panel</p>	<p>Standby LED does not come on at all</p> <ul style="list-style-type: none"> • Check the voltage at the wall outlet • Check circuit breaker switch on power supply • Contact your service provider
4. Display is in a ready state waiting for an ON command	<p>STBY LED stays on solid</p> <p>LAMP and FAN LEDs are off</p> <p>If Auto On is enabled in the Misc Control menu, the display will attempt to turn on automatically after the 30 seconds have elapsed</p>	
5. When the display receives an ON command the fans turn on and the lamp ignites	<p>Buzzer will beep once</p> <p>Fan turns on</p> <p>FAN and LAMP LEDs light</p> <p>STBY LED goes off</p> <p>The time that it takes for the lamp to start after receipt of an ON command is about 2 seconds times the Monitor Unit ID setting on the rear connector panel.</p>	<p>Electronics go back into standby-delay mode (the fans will run and the FAN LED will stay on while in this standby mode)</p> <ul style="list-style-type: none"> • Verify that the interlock switches are fully closing - both are on the chassis - there is one located behind the screen on the left side and one behind the right edge of the rear access cover • Contact your service provider <p>The lamp doesn't ignite</p> <ul style="list-style-type: none"> • Verify that the lamp power connector is plugged in • Replace the lamp. • Contact your service provider

Normal Power-Up Sequence	Sequence Note	Failure Symptoms At This Part Of The Sequence
--------------------------	---------------	---

<p>6. The electronics turn on the DLP engine and start sending data to it</p>	<p>If there is video present on the selected source (see Source Select in menu), the video image will be displayed</p> <p>If there is no video present, the message "SOURCE ABSENT" will be displayed. Menus can be accessed and settings saved and changed</p>	<p>Menu can be selected, but no video is present</p> <ul style="list-style-type: none">• Make sure that the correct source is selected in the menu• Verify that the Curtain option in the menu is not on• Check the video cable connections• Contact your service provider <p>SOURCE ABSENT message is displayed</p> <ul style="list-style-type: none">• Select the correct source in the SOURCE SELECT menu• Verify that the video cables are plugged in• Verify that the source and cable are outputting a video signal using the same cable and source on another display• Contact your service provider <p>No menu or video can be displayed</p> <ul style="list-style-type: none">• Replace the remote batteries and/or remote• Check the lamp• Contact your service provider
---	---	--

Much of the preliminary diagnostics can be done by observing the 3 LEDs on the rear connector panel. Table 2 shows the LED combinations for the most likely failure modes if the WN-5230-S is not operating correctly.

Standby LED	Fan LED	Lamp LED	Indication
Flashing slowly	Off	Off	Normal operation after AC power is initially applied
Flashing slowly	On	Off	Normal operation or Interlocks open. See Note 1 on the next page
Flashing fast	On	On	An "on" command has just turned the display on and the optical engine is being initialized. This should not take more than 10 seconds.
Off	On	On	Normal operation or lamp problem. See Note 2 on the next page
On	Off	Off	Display is in Standby mode

Table 2

Note 1 If the STBY LED is flashing and the Lamp LED is off, one of two conditions exist. Either the display was just shut down normally with the On/Off button or the unit has shut itself down and the likely cause is that the interlock circuit is open. The interlock circuit consists of switches behind the front screen and rear access panel. These prevent accidental exposure to hazardous voltages when the display is turned on. Verify that the screen and rear access cover are in place. If the problem persists, contact your service provider.

Note 2 If the STBY LED is off, the Lamp LED is on, the Fan LED is on and the lamp is not lit, the electronics module is operating and the likely problem is with the lamp or it's power system. If replacing the lamp and restarting the WN-5230-S does not resolve the problem, contact your service provider.

Image Problems

<u>Symptom</u>	Follow these steps in order. Check the operation of the display after each step.
<p>Image is dim</p>	<ol style="list-style-type: none"> 1. Verify that the input signal is good 2. Adjust the Black Level via the menu while displaying a black video image and the White Level while displaying a white video image 3. Set each of the colors in the Color Balance menu to 31 (white) and 7 (gray)
<p>Color problem</p> <ul style="list-style-type: none"> • Screen is all black or all white • Image has an abnormally strong hue of a single color 	<ol style="list-style-type: none"> 1. Verify that the correct source is selected in the Source Select menu 2. Make sure that all of the video cables are plugged into the source and the display. Verify that the cables are good. 3. If the image has a strong green hue, verify that the input signal is not setup as sync-on-green. If it is, you will need to select the Sync on Green option in the Source select menu. 4. Verify that Curtain in the menu is off by pressing the Curtain button on the remote. There should be no X. 5. Adjust the White Level and Black Level in the menu 6. Verify that the Test Patterns in the Misc Control menu are set to Off. 7. Contact your service provider
<p>Displayed image is too small or too large</p>	<ol style="list-style-type: none"> 1. If the source is a computer source, Select Source again and choose Auto, instead of manually selecting the mode. 2. Make sure that the image is positioned correctly on the screen using the Position function in the menu. 3. Check Ultra-Thin Mullion screens. Adjusting the screen way in or way out has an effect on image size. 4. Adjust optical engine mount using internal cyan test pattern. 5. Use the zoom feature to scale the image. 6. Contact your service provider.
<p>Active area of the image is not fully on the screen</p>	<ol style="list-style-type: none"> 1. Adjust image position using the Position function in the menu. 2. Adjust lens screws LS1 and LS2 using internal cyan test pattern. 3. Use the zoom feature to scale the image. 4. Contact your service provider

Technical Support

Many of the technicians who install Clarity displays have been factory trained by Clarity to diagnose and repair the display. If technical support is required, call the installer first. In addition to their understanding of Clarity's products, they have specific knowledge of the installation and may be best able to provide assistance in determining the cause of the problem and resolving it.

Clarity's Technical Support is available Monday through Friday, 8 AM to 5 PM Pacific Standard Time through the following:

Phone: (503) 570-0700

Fax: (503) 682-9441

Email: support@clarityvisual.com

Email: manuals@clarityvisual.com to comment about manuals

When contacting Clarity for technical support, please provide the information listed in the form on the next page. This information will help to speed diagnosis and gives the technician a better understanding of other factors that may be attributing to the problem.

Technical Support Request

Company:	Date:
Reseller/Installer:	Unit Serial Number:
Contact Name:	Phone or E-mail:
Description of the Failure:	
Did the failure occur during start-up or was the display in operation when the failure occurred?	
Lamp Hours of the display (if accessible):	System Hours of the display (if accessible):
Ambient air temperature:	Temperature at the intake air filter:
Describe the installation and how the displays are mounted.	
If the display will not come on or stay on, describe what the status lights on the back of the display are doing.	
Are there any sounds coming from the display?	
What have you done to verify the problem?	

Connector Pinouts

RGBS

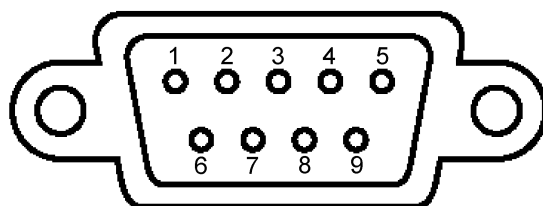

1. Red Video
2. Green Video
3. Blue Video
4. Composite Sync
5. Ground
6. Ground
7. Ground
8. Ground
9. Ground

MAC

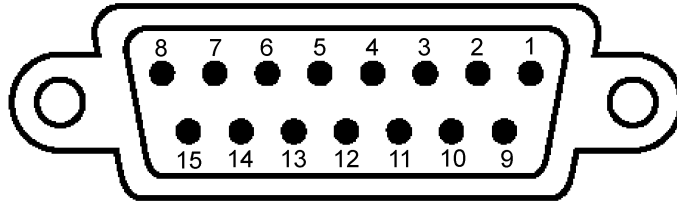

- | | |
|--------------------|-------------------|
| 1. Ground | 9. Blue Video |
| 2. Red Video | 10. No Connect |
| 3. Horizontal Sync | 11. Ground |
| 4. Ground | 12. Vertical Sync |
| 5. Green Video | 13. Ground |
| 6. Ground | 14. Ground |
| 7. No Connect | 15. No Connect |
| 8. No Connect | |

PC & LOOP-THRU

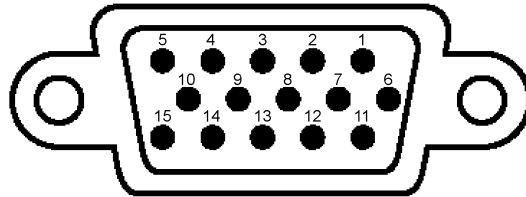

- | | |
|----------------|---------------------|
| 1. Red Video | 9. No Connect |
| 2. Green Video | 10. Ground |
| 3. Blue Video | 11. No Connect |
| 4. No Connect | 12. No Connect |
| 5. No Connect | 13. Horizontal Sync |
| 6. Ground | 14. Vertical Sync |
| 7. Ground | 15. No Connect |
| 8. Ground | |

RS-232 IN

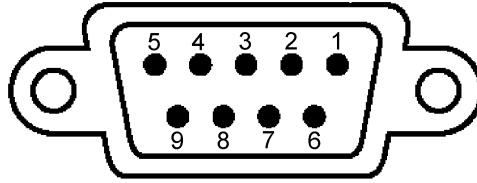

1. No Connect
 2. Transmit Data (TXD)
 3. Receive Data (RXD)
 4. Connected to pins 6 and 8 in the display
 5. Ground
 6. Connected to pins 4 and 8 in the display
 7. No Connect
 8. Connected to pins 4 and 6 in the display
 9. No Connect
-

RS-232 OUT

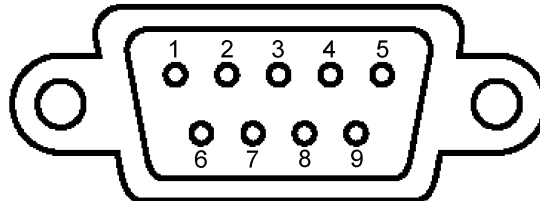

1. No Connect
2. Receive Data (RXD)
3. Transmit Data (TXD)
4. Connected to pins 6 and 8 in the display
5. Ground
6. Connected to pins 4 and 8 in the display
7. No Connect
8. Connected to pins 4 and 6 in the display
9. No Connect

S-VIDEO

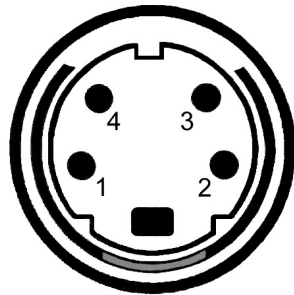

1. Ground
2. Ground
3. Y (Luma)
4. C (Chroma)

Interface and Controls

Rear Panel Indicators, Connectors and Controls

The rear panel of the WN-5230-S VideoWall display is depicted below. The S-Video and Composite Video inputs are part of the VIM-300 option. If your units do not have this option, these connector ports will be empty.

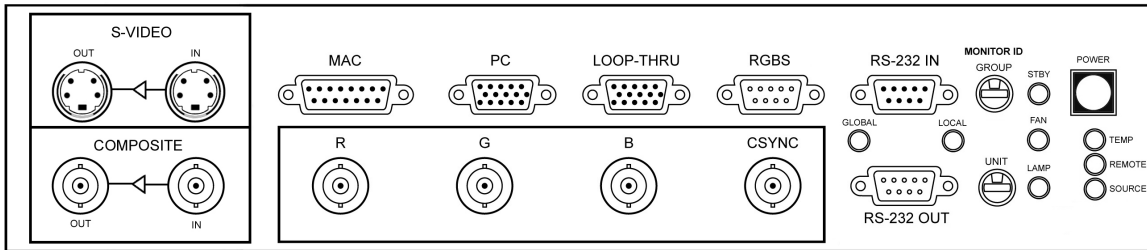

Rear Panel Indicators

Indicator	Description
STBY	The green STBY light emitting diode (LED) is on steady when unit is in Standby mode and main electrical power is switched on. This LED blinks for 30 seconds when the main power is initially switched on or when the lamp is switched off to enter Standby mode. When it is blinking, the power on button for the lamp is inhibited. This LED will blink at a faster rate when the lamp is being ignited.
FAN	This is a green LED that is on when the cooling fan is running. It remains on for the 30 second cool-down cycle after the lamp is switched off. It is on during the initial 30-second period after AC power is applied.
LAMP	This is also a green LED. It is on when the display electronics has turned on the projection lamp.
TEMP	(Not functional in the WN-5230-S)
REMOTE	Indicates activity of the IR sensor. Stray Infrared radiation causes a faint glow and flicker. A signal from the Remote Control causes a 1/10th second flash.

SOURCE	On = valid source detected on the selected input. If this is off, either the wrong source is selected, or the source has no signal in it.
GLOBAL	This LED glows whenever data activity is detected at the RS-232 connector. It does not matter whether the packet was addressed to <i>this</i> unit or not, or even whether this is a command formatted for Clarity display use. It tells you there is a good connection to the controlling computer. The brightness of the LED is proportional to the density of the incoming data.
LOCAL	This LED glows very briefly whenever a valid packet of data is detected at the RS-232 connector <i>and</i> the packet is meant for <i>this</i> unit. It may be a global command, or a command addressed specifically to this unit. This display unit will try to execute this command. It will return an acknowledgement (ACK) only if the command was addressed to <i>this</i> unit exclusively.

Rear Panel Connectors

Connector	Description
MAC	Macintosh II data signal input, 800x600 or 640x480 pixels. 15-pin D-Sub, female.
PC	IBM-compatible SVGA or VGA signal input, 800x600 or 640x480 pixels. 15-pin high-density D-Sub, female.
LOOP THRU	The selected input is output to this 15-pin high-density D-Sub, female connector (but see exception below). The format of the Loop-thru data is same as the source data. PC and MAC will have RGB with separate H-Sync and V-Sync. RGBS with separate composite sync will come out RGBS with the composite sync on the connector's H-Sync pin and separated V-Sync on the V-Sync pin. RGB sync-on-green sources will loop-thru as RGB-sync-on-green, plus composite sync on the H-Sync output pin and separated V-Sync on the V-Sync pin. If the selected input is Composite or S-Video, the Loop-thru connector has no output. Composite and S-Video have their own separate loop-thru connectors.
RGBS (9-pin D-Sub, male)	Data input from a 31.5 kHz device (such as scan-doubled NTSC video). 9-pin D-Sub, male input. This input is separate from the BNC RGBS input. Data can be cabled to both the 9-pin D-Sub and the BNC connectors and selected in the Source menu. With some options this port will also accept component 15.75 kHz video. Sync can be composite sync or sync on green.
RGBS (R, G, B, Sync; 4 BNC connectors)	Data input from a 31.5 kHz device (such as scan-doubled NTSC video). BNC, female connectors. This input is separate from the BNC RGBS input. Data can be cabled to both the 9-pin D-Sub and the BNC connectors and selected in the Source menu. With some options this port will also accept component 15.75 kHz video. Sync can be composite sync or sync on green.
S-VIDEO	IN = NTSC, PAL or SECAM S-Video OUT = buffered output of the input signal
COMPOSITE	IN = NTSC, PAL or SECAM composite video OUT = buffered output of the input signal
RS-232 IN	RS-232 control input from a direct computer link or looped from the RS-232 OUT of another display, when controlling multiple displays from one computer. 9-pin D-Sub, female.
RS-232 OUT	RS-232 control output connects to the RS-232 IN on another display, when controlling multiple displays from one computer. 9-pin D-Sub, male.

Rear Panel Controls

Control	Description
MONITOR ID	<p>16-position rotary switches select a unique Monitor ID number for each unit in a video wall configuration. The two switches have a total number of 256 individual Monitor ID settings.</p> <p>GROUP - ID numbers are 0 – 9 and A – F for a total of 16 different settings. Each number is equal to that number times 16. A setting of 3 is equal to 48.</p> <p>UNIT - ID numbers are 0 – 9 and A – F for a total of 16 different settings. Each number is equal to that number times one. A setting of 3 equals 3, a setting of B equals 11.</p> <p>The Monitor ID number is the combination of the Group ID plus the Unit ID. A Group ID number of 2 and a Unit ID number of 5 equals a Monitor ID of 37.</p> <p>This setting also delays the time between an “on” command to the VideoWall and the ignition of the lamp. The delay is approximately 2 seconds times the Monitor Unit ID number.</p>
POWER	<p>Power On/STBY push-button switch. Controls power to the lamp and fans by toggling unit between ON and STBY modes.</p>
Power On/Off	<p>Rocker switch near the A/C power input connector. Main AC power switch.</p>

Remote-Control

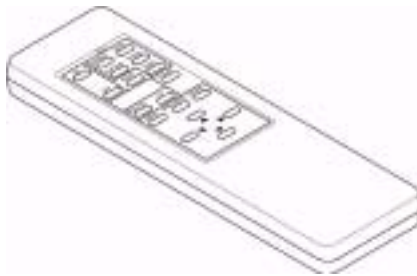

Use the remote control or RS-232 input for all setup and control functions. The remote must be pointed directly at the display for the VideoWall to “see” the remote’s commands. The most reliable position for remote control of the display is on an axis perpendicular to the front of the screen.

The farther away that the remote control is from the display, the weaker the signal will be when it reaches the screen. The weaker the signal, the less reliable the control of the display will be. The remote is powered by two 1.5 volt AAA batteries.

Remote Control Functions

Some on-screen sub-menus can be accessed directly by pressing the specific menu item’s associated button on the remote control.

Remote Button	Description
On	Switches the display on when the Standby LED is on steady.
Off	Switches the display off. The display will enter a 30 second standby-delay mode, after which the display can be turned back on.
Source	Displays the Source Select menu, from which the type of input source, SVGA, MAC or RGBS is selected. Also available from Menu list.
Curtain	Displays a black screen instead of the source video. Also available from Menu list.
Level	Displays the Input Level menu, where a black and a white image from the source are used to calibrate the display to the source. It sets what the display will recognize as the minimum and maximum video voltage level that the source is capable of sending to the display. Also available from Menu list.
Phase	Displays the Phase Select menu, for synchronizing the WN-5230-S internal clock to the clock phase of the incoming signal. Also available from Menu list.
Freq	Displays the Frequency Select menu, for matching the display's internal clock to the source. Also available from Menu list.
Color	Displays the Color Balance menu, to allow color and luminance matching among multiple displays. Also available from Menu list.
Reset	Resets all of the display's settings to the factory defaults. Also available from Menu list.
Mon Sel	The Monitor Select allows you to disable or enable the remote control. This is useful when configuring multiple displays that are adjacent to each other, to prevent remote adjustments on specific units while allowing adjustments to others.
ID	Displays the current setting of the Monitor ID switches. Group numbers are 0-9, A-F (0 – 15) and Unit numbers are also 0-9,A-F (0 – 15), giving a total addressable range of 256.
Menu	Displays the main menu, from which all other functions may be selected and set by navigating with the arrow keys.
Prev Menu	Closes the current menu.
Enter	Used to accept menu selections.
Arrow keys	Used for navigation when menus are displayed or for changing settings in an adjustment menu. The left-right arrows are used to change values; the up-down arrows generally move through the menu list. The left-right arrows move between Yes-No responses in some menus.

On-Screen Menus and Messages

Source Select
Frequency
Phase
Input Level
Position
Zoom
Wall Processor
Color Balance
Curtain
Hours
Save Config
Recall Config
Reset Config
Misc Control
About

The main menu can be accessed by pressing the MENU button. Each sub-menu can be selected by scrolling to it with the Up/Down arrow keys and pressing the ENTER button.

<i>Menu Selection</i>	<i>Description</i>
Source Select	Selects the type of input source, SVGA , MAC or RGBS, composite video or S-video
Frequency	Sets the display's video clock frequency to match the source. Sets the displayed number of pixels per line of video.
Phase	Used to synchronize the WN-5230-S internal system clock to the clock phase of the incoming signal.
Input Level	Displays the Input Level menu, where a black and a white image from the source are used to calibrate the display to the source. It sets the minimum and maximum video voltage level that the source is capable of sending to the display. Note – The Black Level must be set before the White Level is calibrated!
Position	Adjusts the horizontal and vertical position of the displayed image.
Zoom	Changes the image size at all four sides, changing one side at a time, or both opposite sides together.
Wall Processor	If Big Picture option is installed, this opens a menu to turn Wall Mode on or off. Also set the horizontal and vertical size of the wall and force display to calculate its position.
Color Balance	Displays the Color Balance menu, to allow color and luminance matching among multiple WN-5230-S's.
Curtain	Displays a black screen instead of the source video.
Hours	Displays the Lamp Hours and System Hours menu.
Save Config	Saves the configuration for each video-input source. After saving, the WN-5230-S may be power cycled without losing the settings.

Menu Selection	Description
	WN-5230-S may be power cycled without losing the settings.
Recall Config	Recalls previous user-saved configuration settings.
Reset Config	Resets all of the display's settings to the factory defaults.

Menu Selection	Description
Misc Control	<p>Sharpness: When unchecked, a low pass filter is present in the signal path. When checked, the low pass filter is bypassed.</p> <p>Buzzer Enable: Turns on or off the function-indicator buzzer.</p> <p>Flip Horz: Flips the image from right to left.</p> <p>Flip Vert: Flips the image from top to bottom.</p> <p>Auto Lamp On: As soon as AC power is applied to the WN-5230-S, the display will automatically turn on after the 30 second standby-delay has elapsed (plus the Monitor ID delay time) if this box is checked.</p> <p>Test Patterns: Opens a menu with internally generated test patterns. Note: These patterns <i>cannot</i> be used to do Input Level adjust.</p>
About	Clarity Visual Systems (or OEM) address and phone number; firmware version

SOURCE ABSENT

This screen message is displayed when no signal is detected on the source that is presently selected. If this message is displayed, verify that the source is outputting a video signal and verify that the video cable is plugged in.

Menus

Notes for menu descriptions:

- * This command is also available from a special button on the remote control.
- † In the Color Balance menu, the up-down arrows move the highlight through the two columns. The left-right arrows change the highlighted value.
- ‡ This command is available *only* from a special button on the remote control.
- § The numbers in this menu are for reference only; they are not measurements.

Main Menu

Source*	Opens the Source Select menu
Frequency*	Opens the Frequency adjust window
Phase*	Opens the Phase adjust window
Input Level*	Opens Input Level menu (when PC, MAC or RGBS is the selected source) or Video Controls menu (when Composite or S-video is the selected source)
Position	Opens the Position window
Zoom	Opens the Zoom menu
Wall Processor	Opens the Wall Processor menu
Color Balance*	Opens the Color Balance menu
Curtain*	Opens Curtain menu
Hours	Opens Hours menu
Save Config	Opens Save Config(uration) menu
Recall Config	Opens Recall Config(uration) menu
Reset Config*	Opens Reset Config(uration) menu
Misc Control	Opens Misc(ellaneous) Control menu
About	Opens About menu

Source Select	
← → [source]	[source] is one of the following: PC MAC 9-pin (RGBS) BNC (RGBS) C-Video S-Video
← → [mode]	[mode] is one of the following: 640x480 800x600 525/60Hz 625/50Hz
[] Auto	Detects and sets the mode parameters for a selected source
[] Sync on Green	Forces Sync on Green for RGBS, in case auto detection does not find this correctly
[] Interlace	Indicates that the source video is interlaced; cannot be changed manually.
H Freq: 00000	Shows H rate in Hertz of selected source
Lines: 000	Shows total number of horizontal lines in the selected source
V Freq: 00	Shows frame rate in Hertz of selected source

Frequency Select	
000	Adjust frequency; number shown does not directly correlate to freq. §

Phase Select	
000	Adjust phase; number shown does not directly correlate to phase. §

Input Level (This menu shown only when selected source is PC, MAC or RGBS)	
Black Level	Opens Black Level menu
White Level	Opens White Level menu

Video Controls (This menu shown only when selected source is composite or S-video)	
Brightness 000	Adjusts brightness of a video signal; numbers are arbitrary
Contrast 000	Adjusts contrast of a video signal
Saturation 000	Adjusts saturation of a video signal
Hue 000	Adjusts hue (tint) of a video signal
Blue Only []	For composite and S-video signals, turns Blue "gun" on; Red and Blue "guns" off; used for adjusting saturation and hue of displayed colors
Sample R: xxx G: xxx B: xxx	

Black Level (Requires Black field)													
Auto []	Automatically adjusts display to Black Level of incoming PC, MAC, or RGBS signal												
All ← →	Raises or lowers all three (RGB) levels together												
<table border="0"> <tr> <td></td> <td>Level</td> <td>Sample</td> </tr> <tr> <td>Red</td> <td>127</td> <td>004</td> </tr> <tr> <td>Green</td> <td>125</td> <td>001</td> </tr> <tr> <td>Blue</td> <td>129</td> <td>000</td> </tr> </table>		Level	Sample	Red	127	004	Green	125	001	Blue	129	000	Level shows the current (internal) setting of R, G, and B. § Sample shows the levels (in bits) detected in the incoming signal; 000 is black, 255 is white.
	Level	Sample											
Red	127	004											
Green	125	001											
Blue	129	000											

White Level (Requires White field)													
Auto []	Automatically adjusts display to Black Level of incoming computer signal												
All ← →	Raises or lowers all three (RGB) levels together												
<table border="0"> <tr> <td></td> <td>Level</td> <td>Sample</td> </tr> <tr> <td>Red</td> <td>127</td> <td>254</td> </tr> <tr> <td>Green</td> <td>125</td> <td>255</td> </tr> <tr> <td>Blue</td> <td>129</td> <td>255</td> </tr> </table>		Level	Sample	Red	127	254	Green	125	255	Blue	129	255	Level shows the current (internal) setting of R, G, and B. § Sample shows the levels (in bits) detected in the incoming signal; 000 is black, 255 is white.
	Level	Sample											
Red	127	254											
Green	125	255											
Blue	129	255											

Position	
	Moves image left / right / up / down

Zoom Factor	
- +	
Left ← → W:xxx	Zooms the left side of the image; W: xxx shows width in pixels
Right ← →	Zooms the right side of the image
Top ← → H:xxx	Zooms the top side of the image; H: xxx shows height in pixels
Bottom ← →	Zooms the bottom side of the image
[] Lock	Locks left-right and top-bottom together, so zooming in one direction also zooms in the opposite direction. Zooming occurs from the middle.
[] Default	Reverts to default zoom for the currently selected Source and Wall Mode

Color Balance † *		
Wht	Gry	Wht (white) values 000 – 031; Gry (gray) values 000-007
Red	031 007	Left-right arrows change Red values of White or Gray Color Balance
Green	031 007	Left-right arrows change Green values of White or Gray Color Balance
Blue	031 007	Left-right arrows change Blue values of White or Gray Color Balance

Curtain Select	
<input type="checkbox"/> Curtain On	Enter turns Curtain on and off. X means Curtain is on and no video will be displayed.

Lamp Hours: xxxx:xx	Shows hours:minutes lamp was on since last Lamp Hours Reset
System Hours: xxxx:xx	Shows hours:minutes system (Electronics Module) has been used
Reset Lamp hours <input type="checkbox"/> Yes <input type="checkbox"/> No	To reset lamp hours, use left-right arrows to highlight <input type="checkbox"/> Yes, then press Enter . New menu (below) asks for confirmation.

Was Lamp Changed?	
<input type="checkbox"/> Yes <input type="checkbox"/> No	To confirm lamp hours reset, use left-right arrows to highlight <input type="checkbox"/> Yes, then press Enter .

ID †	
Group 0	Shows Group ID of this display unit; hexadecimal number
Unit 2	Shows Unit ID number of this display unit; hexadecimal number. Unit number times 2 equals lamp turn-on delay time in seconds. Group and Unit numbers are both used for Wall Processor calculations.

Misc Control	
<input type="checkbox"/> Sharpness	Turns Sharpness on and off (should be on for PC and MAC)
<input type="checkbox"/> Buzzer Enable	Turns Buzzer (at each press of a remote control button) on (X) and off
<input type="checkbox"/> Flip Horz	Reverses image left-right
<input type="checkbox"/> Flip Vert	Reverses image up-down
<input type="checkbox"/> Auto Lamp On	When X is present, lamp tries to turn on after the standby delay has elapsed.
<input type="checkbox"/> Test Patterns	Opens Test Patterns menu; patterns are internally generated.

Test Patterns	
<input type="checkbox"/> Off	No test pattern; external video passes through to screen
<input type="checkbox"/> White	Internal White field
<input type="checkbox"/> Black	Internal Black field
<input type="checkbox"/> 50% Gray	Internal Gray (50% white) pattern
<input type="checkbox"/> Red	Internal Red field
<input type="checkbox"/> Green	Internal Green field
<input type="checkbox"/> Blue	Internal Blue field
<input type="checkbox"/> Red Geometry	Internal red on white pattern
<input type="checkbox"/> Cyan Geometry	Internal cyan on white pattern
<input type="checkbox"/> Black Geometry	Internal black on white pattern
<input type="checkbox"/> Gray Scale	Internal pattern ranging from black to white (left to right)

Monitor Select †	
<input type="checkbox"/> IR Disabled	Prevents stray infra-red radiation from disturbing Electronics Module. Also used to turn off IR reception in some units so remote control does not change them. When X is present, only ID button on remote control will affect the unit.

Wall Processor	
Wall Size: Horizontal: xxx Vertical: xxx Current Unit: xx	Enter number of units in video wall horizontally Enter number of unit is video wall vertically Number of current unit, taken from Group and Unit knobs
Misc: [] Calc Wall Pos [] Wall Mode	Select and press Enter to automatically calculate wall position of this unit and turn on Wall Mode Select and press Enter to turn Wall Mode on and off.

Save Config																	
← → [source]	Left-right arrows select source to save: All PC MAC 9-pin (RGSB) BNC (RGSB) C-video S-video																
← → [mode]	Left-right arrows select mode to save: <table border="0"> <tr> <td>Source</td> <td>Mode</td> </tr> <tr> <td>All</td> <td>All [modes are saved for all sources]</td> </tr> <tr> <td>PC</td> <td>All [PC modes are saved] 640x480 800x600</td> </tr> <tr> <td>MAC</td> <td>All [MAC modes are saved] 640x480 800x600 832x624</td> </tr> <tr> <td>RGSB 9-pin</td> <td>All [RGSB 9-pin modes are saved] 640x480 800x600 525/60Hz 625/50Hz</td> </tr> <tr> <td>RGSB BNC</td> <td>All [RGSB BNC modes are saved] 640x480 800x600 525/60Hz 625/50Hz</td> </tr> <tr> <td>Composite</td> <td>All [Composite modes are saved] NTSC PAL SECAM</td> </tr> <tr> <td>S-Video</td> <td>All [S-Video modes are saved] NTSC PAL SECAM</td> </tr> </table>	Source	Mode	All	All [modes are saved for all sources]	PC	All [PC modes are saved] 640x480 800x600	MAC	All [MAC modes are saved] 640x480 800x600 832x624	RGSB 9-pin	All [RGSB 9-pin modes are saved] 640x480 800x600 525/60Hz 625/50Hz	RGSB BNC	All [RGSB BNC modes are saved] 640x480 800x600 525/60Hz 625/50Hz	Composite	All [Composite modes are saved] NTSC PAL SECAM	S-Video	All [S-Video modes are saved] NTSC PAL SECAM
Source	Mode																
All	All [modes are saved for all sources]																
PC	All [PC modes are saved] 640x480 800x600																
MAC	All [MAC modes are saved] 640x480 800x600 832x624																
RGSB 9-pin	All [RGSB 9-pin modes are saved] 640x480 800x600 525/60Hz 625/50Hz																
RGSB BNC	All [RGSB BNC modes are saved] 640x480 800x600 525/60Hz 625/50Hz																
Composite	All [Composite modes are saved] NTSC PAL SECAM																
S-Video	All [S-Video modes are saved] NTSC PAL SECAM																

Recall Config																	
← → [source]	Left-right arrows select source to recall: All PC MAC 9-pin (RGSB) BNC (RGSB) C-video S-video																
← → [mode]	Left-right arrows select mode to recall: <table border="0"> <thead> <tr> <th style="text-align: left;">Source</th> <th style="text-align: left;">Mode</th> </tr> </thead> <tbody> <tr> <td>All</td> <td>All [modes are recalled for all sources]</td> </tr> <tr> <td>PC</td> <td>All [PC modes are recalled] 640x480 800x600</td> </tr> <tr> <td>MAC</td> <td>All [MAC modes are recalled] 640x480 800x600 832x624</td> </tr> <tr> <td>RGSB 9-pin</td> <td>All [RGSB 9-pin modes are recalled] 640x480 800x600 525/60Hz 625/50Hz</td> </tr> <tr> <td>RGSB BNC</td> <td>All [RGSB BNC modes are recalled] 640x480 800x600 525/60Hz 625/50Hz</td> </tr> <tr> <td>Composite</td> <td>All [Composite modes are recalled] NTSC PAL SECAM</td> </tr> <tr> <td>S-Video</td> <td>All [S-Video modes are recalled] NTSC PAL SECAM</td> </tr> </tbody> </table>	Source	Mode	All	All [modes are recalled for all sources]	PC	All [PC modes are recalled] 640x480 800x600	MAC	All [MAC modes are recalled] 640x480 800x600 832x624	RGSB 9-pin	All [RGSB 9-pin modes are recalled] 640x480 800x600 525/60Hz 625/50Hz	RGSB BNC	All [RGSB BNC modes are recalled] 640x480 800x600 525/60Hz 625/50Hz	Composite	All [Composite modes are recalled] NTSC PAL SECAM	S-Video	All [S-Video modes are recalled] NTSC PAL SECAM
Source	Mode																
All	All [modes are recalled for all sources]																
PC	All [PC modes are recalled] 640x480 800x600																
MAC	All [MAC modes are recalled] 640x480 800x600 832x624																
RGSB 9-pin	All [RGSB 9-pin modes are recalled] 640x480 800x600 525/60Hz 625/50Hz																
RGSB BNC	All [RGSB BNC modes are recalled] 640x480 800x600 525/60Hz 625/50Hz																
Composite	All [Composite modes are recalled] NTSC PAL SECAM																
S-Video	All [S-Video modes are recalled] NTSC PAL SECAM																

Reset Config																	
← → [source]	Left-right arrows select source to reset: All PC MAC 9-pin (RGSB) BNC (RGSB) C-video S-video																
← → [mode]	Left-right arrows select mode to reset: <table border="0"> <thead> <tr> <th>Source</th> <th>Mode</th> </tr> </thead> <tbody> <tr> <td>All</td> <td>All [modes are reset for all sources]</td> </tr> <tr> <td>PC</td> <td>All [PC modes are reset] 640x480 800x600</td> </tr> <tr> <td>MAC</td> <td>All [MAC modes are reset] 640x480 800x600 832x624</td> </tr> <tr> <td>RGSB 9-pin</td> <td>All [RGSB 9-pin modes are reset] 640x480 800x600 525/60Hz 625/50Hz</td> </tr> <tr> <td>RGSB BNC</td> <td>All [RGSB BNC modes are reset] 640x480 800x600 525/60Hz 625/50Hz</td> </tr> <tr> <td>Composite</td> <td>All [Composite modes are reset] NTSC PAL SECAM</td> </tr> <tr> <td>S-Video</td> <td>All [S-Video modes are reset] NTSC PAL SECAM</td> </tr> </tbody> </table>	Source	Mode	All	All [modes are reset for all sources]	PC	All [PC modes are reset] 640x480 800x600	MAC	All [MAC modes are reset] 640x480 800x600 832x624	RGSB 9-pin	All [RGSB 9-pin modes are reset] 640x480 800x600 525/60Hz 625/50Hz	RGSB BNC	All [RGSB BNC modes are reset] 640x480 800x600 525/60Hz 625/50Hz	Composite	All [Composite modes are reset] NTSC PAL SECAM	S-Video	All [S-Video modes are reset] NTSC PAL SECAM
Source	Mode																
All	All [modes are reset for all sources]																
PC	All [PC modes are reset] 640x480 800x600																
MAC	All [MAC modes are reset] 640x480 800x600 832x624																
RGSB 9-pin	All [RGSB 9-pin modes are reset] 640x480 800x600 525/60Hz 625/50Hz																
RGSB BNC	All [RGSB BNC modes are reset] 640x480 800x600 525/60Hz 625/50Hz																
Composite	All [Composite modes are reset] NTSC PAL SECAM																
S-Video	All [S-Video modes are reset] NTSC PAL SECAM																

RS-232 Control

Transmission Speed	19200 BAUD
Transmission Data	Data Length: 8, Stop Bit: 1, Parity Bit: None

No standard hardware or software pacing is used such as DTR/RTS or XON/XOFF. Commands should be paced using the ACK, NAK, UNK, or ERR responses from the display.

Standard RS-232 levels, +/- 12V, are used. Some laptop PC's use ground and +5V and are not always successful in communicating with the display.

The display's RS-232 port is always active except during the boot process which is the first 10 seconds after power is applied to the display electronics.

In single address mode (not when global commands are being used) the host machine should wait for an ACK, NAK, UNK or ERR response from the display before sending the next command to avoid overrunning the input buffer. When global commands are sent, the displays will not return a response, so a delay of ½ second should be maintained between commands to avoid possible errors.

The protocol for communication to the display consists of a 7 byte command line as described below.

STX(1 byte) **IDT**(2 byte) **CMD**(3 byte) **ETX**(1 byte)

Where;

ASCII STX - Start of transmission character, = 02h

Description	Abbreviation	Hex	Decimal	Character	Control
Start of Text	STX	02	2	☺	Ctrl- B

IDT – IDT is a 2-byte ID character string. Monitor ID bytes are used to identify which display will receive the RS-232 command. This is a 2 byte address that is set by the Group and Unit Monitor ID knobs on the display's connector panel. Each knob has 16 possible settings with the Group setting the high byte and the Unit setting the low byte. The address consists of the ASCII Alphanumeric characters (0-9, A-F for the Group setting and 0-9, A-F for the Unit setting) providing the means to control up to 256 combinations (00 to FF).

Multiple units can be controlled simultaneously by using the ASCII character for the asterisk (*) in place of either or both of the IDT monitor ID bytes. The (*) is a wild card character and provides a means to control multiple units simultaneously. There are four types of addressing that are supported.

1. Single address mode – the entire address is specified: 00, 01, 02, A2, AA, FF are valid examples. Only the single display that matches this address attempts to execute this command. An acknowledgement is sent in this mode.
Note: Do not set several displays to the same Unit and Group address. If two displays have the same Group and Unit ID, and a Single Address Mode command is sent to that address, both units will send an acknowledgement at the same time, causing some confusion in the data on the RS-232 line.
2. Group address mode – the group part of the address is specified, while the unit part of the address is not: 1*, 9*, A*, F* are valid examples. All displays that match the group number attempt to execute this command. No acknowledgement is sent in this mode.
3. Unit address mode – the unit part of the address is specified, while the group part of the address is set as global: *2, *9, *F are valid examples. All displays that match the unit number attempt to execute this command. No acknowledgement is sent in this mode.
4. Broadcast mode – both group and unit are “*”, so the IDT part of the packet is “***”. All displays attempt to execute this command. No acknowledgement is sent in this mode.

All addressing is done in hex.

CMD - CMD is a 3-byte command character string. These command strings are shown in the table listing the RS-232 command codes.

ASCII ETX - End of transmission character, = 03h

Description	Abbreviation	Hex	Decimal	Character	Control
End of Text	ETX	03	3	♥	Ctrl- C

For example, to turn on a display with an address of 06, it would need to receive the following command:



Note: For a data packet to be valid, it must start with STX and end with ETX, and the time from STX to ETX must be less than one second.

RS-232 Control Items

Notes:

* Indicates an ASCII character is returned from the cube in this location.

\$ Indicates 8-bit data is returned from the cube in this location

Indicates 8-bit data is transmitted to the cube in this location

1 ACK or NCK will be transmitted following the video cube receiving a non-global instruction. For commands which request data transmitted back the transmitted response will be the acknowledge.

“1” is the numeral; “I” is the letter

Function	RS-232 COMMANDS		RS-232 DATA		Comments
	Inc	Dec	Get	Set	
System Controls					
Power / Stand by	PON	POF	PO*		Run state PON Standby state POF Lockout state POX Any unknown state PO? PO* returns PON, POF, POX
Frequency Adjust	FRU	FRD	FR\$	FW#	\$ and # = 0 - 126
Phase Adjust	PHU	PHD	PR\$	PW#	\$ and # = 0 - 31
V-Position Up / Down	VPU	VPD	VR\$	VW#	
H-Position Left/Right	HPL	HPR	HR\$	HW#	
V-Image Control Normal/Reversed	VF0	VF1	VF*		0 = normal, 1 = reversed
H-Image Control Normal/Reversed	HF0	HF1	HF*		0 = normal, 1 = reversed
Curtain	CON	COF	CO*		CON = on, COF = off
Sharpness	SON	SOF	SO*		SON = on, SOF = off
Buzzer	BON	BOF	BO*		N = on, F = off
IR Remote Enable/Disable	ION	IOF	IO*		N = on, F = off
Startup Delay	ST1	ST0	ST*		0=3minutes / 1=90seconds
Monitor ID Menu Display	MID				Display monitor ID dialog box
Hours Menu Display	LHR				Display the hours dialog box
Read Lamp Hours (high byte)			LH\$		
Read Lamp Hours (low byte)			LL\$		
Lamp Hours Reset	LRS				Reset Lamp hours to zero
Read System Hours (high byte)			TH\$		
Read System Hours (low byte)			TL\$		
Clear Display Menus	CLM				Clears all menus with one command
Source Controls					
Select VGA Input			IN*	IN1	
Select MAC Input			IN*	IN2	
Select RGBS 9-pin Input			IN*	IN3	
Select RGBS BNC Input			IN*	IN4	
Select Composite Video Input			IN*	IN5	
Select S-Video Input			IN*	IN6	
Auto-select the mode of the source	ATO				
Select mode 0			IM1		
Select Mode 1			IM2		
Select Mode 2			IM3		
Select Mode 3			IM4		
Read Input Mode			IM*		
Save All Settings				SAA	
Save VGA Settings				SA1	
Save MAC Settings				SA2	
Save RGBS 9-pin Settings				SA3	
Save RGBS BNC Settings				SA4	
Save Composite Video Settings				SA5	
Save S-video Settings				SA6	

Function	RS-232 COMMANDS		RS-232 DATA		Comments
	Inc	Dec	Get	Set	
Recall All Settings				RCA	
Recall VGA Settings				RC1	
Recall MAC Settings				RC2	
Recall RGBS 9-pin Settings				RC3	
Recall RGBS BNC Settings				RC4	
Recall Composite Video Settings				RC5	
Recall S-video Settings				RC6	
Reset All Settings				RSA	
Reset VGA Settings				RS1	
Reset MAC Settings				RS2	
Reset RGBS 9-pin Settings				RS3	
Reset RGBS BNC Settings				RS4	
Reset Composite Video Settings				RS5	
Reset S-video Settings				RS6	
Input Level / Offset Controls					
Display Input Level White Menu	LVW				
Auto-adjust White Input Level	AWL				
Input White Level Adjust ALL	LAU	LAD		IA#	# = 0 - 255
Input White Level Adjust Red	LRU	LRD	LR\$	IR#	\$ and # = 0 = 255
Input White Level Adjust Green	LGU	LGD	LG\$	IG#	\$ and # = 0 = 255
Input White Level Adjust Blue	LBU	LBD	LB\$	IB#	\$ and # = 0 = 255
Display Input Level Black Menu	LVB				
Auto-adjust Black Input Level	ABL				
Input Black Offset Adjust ALL	OAU	OAD		QA#	# = 0 - 255
Input Black Offset Adjust Red	ORU	ORD	OR\$	QR#	\$ and # = 0 = 255
Input Black Offset Adjust Green	OGU	OGD	OG\$	QG#	\$ and # = 0 = 255
Input Black Offset Adjust Blue	OBU	OBD	OB\$	QB#	\$ and # = 0 = 255
Input Level Data Red			DR\$		Read back red sample in FPGA
Input Level Data Green			DG\$		Read back green sample in FPGA
Input Level Data Blue			DB\$		Read back blue sample in FPGA
Color Controls					
Display Color Balance Menu	BAL				
Red Color Balance Adjust (white)	BRU	BRD	BR\$	CR#	\$ and # = 0 - 31
Green Color Balance Adjust (white)	BGU	BGD	BG\$	CG#	\$ and # = 0 - 31
Blue Color Balance Adjust (white)	BBU	BBD	BB\$	CB#	\$ and # = 0 - 31
Red Color Balance Adjust (gray)	GRU	GRD	GR\$	RR#	\$ and # = 0 - 7
Green Color Balance Adjust (gray)	GGU	GGD	GG\$	RG#	\$ and # = 0 - 7
Blue Color Balance Adjust (gray)	GBU	GBD	GB\$	RB#	\$ and # = 0 - 7
Gamma Control	GON	GOF	GO*		1 = on, 0 = off
ZOOM Controls					
Left Edge	ZLU	ZLD	Z0\$ Z1\$	X0# X1#	Even = high byte Odd = low byte
Right Edge	ZRU	ZRD	Z2\$ Z3\$	X2# X3#	0 - 255
Top Edge	ZTU	ZTD	Z4\$ Z5\$	X4# X5#	
Bottom Edge	ZBU	ZBD	Z6\$ Z7\$	X6# X7#	
Decoder Controls					
Brightness	D1U	D1D	D1\$	E1#	0 - 255
Contrast	D2U	D2D	D2\$	E2#	
Saturation	D3U	D3D	D3\$	E3#	
Hue	D4U	D4D	D4\$	E4#	

Function	RS-232 COMMANDS		RS-232 DATA		Comments
	Inc	Dec	Get	Set	
Auto re-strike Controls					
System status request			S0\$		Bit 7: Lamp status (1=on; 0=off) Bit 6: Lamp failure (1=fail; 0=OK) Bit 5: Not used Bit 4: Not used Bit 3: System state: bit 3 Bit 2: System state: bit 2 Bit 1: System state: bit 1 Bit 0: System state: bit 0 The system state can have the following values 0000 – Lockout state 0001 – Standby state 0010 – Run state 0011 – Force on ignition state 0100 – Manual ignition state 0101 – Ignition state 0110 – Re-strike state All others are not used.
Enable / Disable Auto re-strike	LF1	LF0	LF*		LF1 – auto re-strike active LF0 – auto re-strike inactive
Test Signal Controls					
Test Signal Disable (Pass Video)	TSD		TS*		TSD removes test signal and allows video to show. 0 = off, 1 = White, 2 = Black, 3 = Gray, 4 = Red, 5 = Green, 6 = Blue, 7 = Geometry red, 8 = Gmtry cyan, 9 = Gmtry black, 10 = Gray Ramp
Test Signal - White Field	WHT				
Test Signal - Black Field	BLK				
Test Signal - 50% Gray Field	GRY				
Test Signal - Red Field	RED				
Test Signal - Green Field	GRN				
Test Signal - Blue Field	BLU				
Test Signal - Geometry red	GE1				
Test Signal - Geometry cyan	GE2				
Test Signal - Geometry black	GE3				
Test Signal - Gray ramp	GE4				
Test Signal -			TS*		0 = off, 1 = on
Test Signal - Data Red				TR#	Set test signal red level 0-255
Test Signal - Data Green				TG#	Set test signal green level 0-255
Test Signal - Data Blue				TB#	Set test signal blue level 0-255
System Monitor					
Ping			PNG		Verifies that a cube is at an address
Product ID			P00		Gets the product ID (hex) In the About menu, the project number is 573-xyy-zz. The xx value is returned as a hex number.
Version ID			VER		Get software version ID 0x01 – Rev A 0x02 – Rev B 0x03 – Rev C etc.
Big Picture Controls					
Wall Horizontal Size			WXn	WX\$	n=1..4
Wall Vertical Size			Wyn	WY\$	n=1..4
Wall Mode Calculate	WMC				
Wall Mode On/Off	WM1	WM0	WM*		WM* returns WM1 or WM0
Protocol Control (1)					
Received Valid Command	ACK				Command successfully executed.
Received Invalid Command	NAK				Command error on execution.
Unknown command	UNK				Unknown command.

Clarity Visual Systems

Function	RS-232 COMMANDS		RS-232 DATA		Comments
	Inc	Dec	Get	Set	
Parameter error	ERR				Parameter error.

Specifications

Optical

Specification	Units	Maximum	Minimum	Typical	Notes
Viewable screen size Diagonal Width Height	Inches			51.68 41.36 30.95	
Image position	Pixels	-1	+1	0	Deviation of center pixel
Rotation	Pixels	-1	+1	0	Slope displacement over image length
Pincushion/Barrel	Pixels	-2	+2	0	Deviation at center of edges
Keystoning	Pixels	-2	+2	0	Slope displacement over image length
Screen Type UCS standard Gain				3.8	Two-part composite screen, front vertical black stripe lenticular and a main element fresnel lens. ±10% nominal
Brightness ANSI white Center to edge non-uniformity	fL. Percent		125	150	Using ANSI 9 point avg. at optimum viewing angle Using ANSI 9 point (1-[min./max.])
Viewing angle Horizontal half-gain Vertical half-gain	Degrees		∇24.3 ∇7.4	∇27 ∇8.2	Optimum viewing angle at normal axis
Contrast ratio (full screen)	Ratio		150:1		Dark room measurement
Color Temperature	Deg. K			9700	

White color matching	CIE xy x y			± 0.005 ± 0.005	Relative to any other WN-5230-S
Primary color matching R, G, or B	CIE xy x y			± 0.005 ± 0.005	Relative to any other WN-5230-S
Luminance matching	Percent	10			Relative to any other WN-5230-S after calibration
Gamma (user selectable)				1.8-2.5	
Resolution Horizontal Vertical	Color Pixels			800 600	
Color				16 million	
Bright dots		0			Green/red/blue dots appear bright in a dark field. No adjacent defects
Black dots		4			Dots appear black in a white field. No adjacent defects.
Lamp life	Hours			8,000	

Mechanical

Specification	Units	Maximum	Minimum	Typical	Notes
Outside dimensions Width Height Depth	Inches	41.74 40.66 30.66	41.62 40.54 30.54	41.68 40.60 30.60	± 0.0625 ± 0.0625 ± 0.0625
Weight	Lbs.			120	
Shipping weight	Lbs.			180	
Stacking	Units	4			Vertical plane, stabilization required when stacked 3 or more.
Chassis color				Black	
Ventilation	Inches		4		To the rear of the cube
Screen size Diagonal Width Height	Inches			52.11 41.68 31.27	Including mullion
Mullion (standard)	Inches	0.188			From edge of viewing area to edge of cube.

Environmental

Specification	Units	Maximum	Minimum	Typical	Notes
Temperature (operating)	Deg. C	35	0		All performance specifications are maintained within this temperature range
Non operating	Deg. C	60	-10		
Shock	G's	10			
Shipping					ASTM Qualified
Altitude	Feet	10,000			
Humidity	% R.H.	80	20		≤40°C Non-condensing

Picture Control

Specification	Units	Maximum	Minimum	Typical	Notes
User controls Input gain RGB Gain	# of levels	2x	0.5x	±64	For white color balance. Each level individually gamma corrected.
Position	# of pixels			±64	
Fan timeout in standby	Seconds			30	
Lamp restart time	Seconds			30	
Lamp start incremental delay	Seconds			Monitor ID # x2	Sequential start to avoid power sag
IR remote				Infrared	Allows control over all user adjustments
Serial I/O					RS-232 control for all user adjustments

Electrical

Specification	Units	Maximum	Minimum	Typical	Notes
Video input amplitude Separate RGB analog Composite sync	V p-p	1.4 5.0	0.35	0.7 0.3	75Ω termination 75Ω termination
Input connectors BNC (row of 4 connectors) 9-pin D-Sub (female) HD D-Sub 15 female D-Sub 15 Female 9-pin D-Sub (female)					38/15.75 kHz video input, RGBS 38/15.75 kHz video input, RGBS Computer input, (PC, SVGA / VGA) Computer input, (MAC II) RS-232 input
Optional Decoder Input Connectors BNC 4-Pin Mini DIN					Composite Video In S-Video In
Output connectors 9-pin D-sub (male) 15-pin HD D-sub, female					RS-232 output Video loop through
Optional Decoder Output Connectors BNC 4-Pin Mini DIN					Composite Video Out S-Video Out
Frequency Dot clock Horizontal frequency Vertical frequency Sync lock	MHz kHz Hz	50 48 85*	15 50	38 60	*75Hz max in 800x600 Will not lose sync lock with signal inputs within stated frequency range.
Maximum input DC offset	Volts	±2			
Total pixels per line	Pixels	1120	768		800 displayed
Active vertical lines	# of HS	860	500		600 displayed
Low-pass bandwidth filter	MHz			10	Selectable via remote control
AC requirements Line input (Range 1) Line input (Range 2) Total power requirements	Volts Watts	130 260 200	90 180	160	@ 50/60Hz auto ranging @ 50/60Hz auto ranging

Regulatory Information

Declaration of Conformity

Manufacturer's Name: Clarity Visual Systems
Manufacturer's Address: 9025 SW Hillman Court, Suite 3122
Wilsonville, Oregon 97070

declares that the product

Model Number: WN-5230-S (DLP projector)
Product Options: All

conforms to the following Product Specifications:

Safety: EN 60950 — Safety of IT Equipment
EMC: EN 55022 — Emissions from IT Equipment
EN 55082-1 — General Immunity Standard,
including: IEC 801-2 ESD
IEC 801-3 Radiated E Field
IEC 801-4 Fast transients

FCC Regulations

This equipment has been tested and found to comply with the limits for a Class A digital device, pursuant to Part 15 of the FCC rules. These limits are designed to provide reasonable protection against harmful interference in an installation. This equipment generates, uses and can radiate radio frequency energy, and if not installed and used in accordance with the instructions, may cause harmful interference to radio communications. However, there is no guarantee that interference will not occur in a particular installation. If this equipment does cause harmful interference to radio or television reception, which can be determined by turning the equipment off and on, the user is encouraged to try to correct the interference by one or more of the following measures:

- Reorient or relocate receiving antenna.
- Increase separation between equipment and receiver.
- Connect equipment to an outlet on a circuit different from that to which the receiver is connected.
- Consult your dealer or an experienced radio/TV technician.

Note: Any changes or modifications to the display not expressly approved by Clarity Visual could void the user's authority to operate this equipment.

Use of a shielded interface cable is required to comply with the Class A limits of Part 15 of FCC rules.

Other Certifications

UL, CUL, TÜV, CE

Index

1	
15.75K Video	58
3	
31.5K Video	58, 87
A	
About	66, 91
Accessories	2
ACK	99
Adjust the Colors	47
Adjust the Input Signal Settings	34
air filter	5, 13
Air Filter	71
Air handling ducts	7
alignment, thin mullion screen	26
Arrow Keys	89
Auto	35, 37
Auto Lamp On	64, 91
B	
BAS-520	2
Big Picture	47, 55
Black Level	36
Black Level menu	93
Brightness	39
Buzzer Enable	63, 64, 91
C	
Cables	14
Calc Wall Pos	95
Certifications	111
safety	112
Clarity's Big Picture	55
Cleaning	67
Cleaning, screen, mirrors	72
Clearance	14
Clearance for Maintenance	14
Clearance for Operation	14
Color	47, 89, 90
Color Balance menu	94
Comp Video	39
COMPOSITE	87
Connector	87
Connector Pinouts	81
Contrast	39
Controls	85, 88
Curtain	61, 89, 90
Curtain Select menu	94
D	
diagonals, measuring	27
E	
Electrical Specifications	110
Enter Button	89
Environmental Lighting	13
Environmental Specifications	109
ERR	99
Extension Cords	12
F	
Fan	85
Fan LED	76
FCC regulations	112
Features	1
Flip Horz	64, 91
Flip Vert	64, 91
Flooring	13
Freq	89
Frequency	43, 89, 90
Frequency Select menu	93
G	
Geometry	64
global	86, 99, 102
H	
Hours	65
Hue	40
Humidity	13
I	
ID 62, 88, 89	
ID menu	94
Image Problems	77
Input Level	36
Input Level menu	93
IR Disabled	94
L	
lamp	4, 5, 6, 7, 13, 65, 88
Lamp	63, 65, 67, 85, 89
Lamp Hours	90
Lamp Hours menu	94
Lamp LED	76
LED Status Table	76
Level	37, 39, 43, 89, 90
Lighting, Environment	13
Limited Warranty	iii

local.....	86	recall settings.....	51
Loop Thru	87	Regulatory Information.....	111
of source video.....	58	Remote Button.....	89
loop-thru connector.....	82	Remote Control Functions	88
M		Remote-Control.....	88
MAC Connector	82	removing screens	
MAC II	87	standard screen.....	24
main menu.....	92	thin mullion screen.....	26
Main Power Switch	53	Reset	65, 89, 91
Maintenance.....	67	Reset Config menu	97
Maintenance Clearance	14	Reset Lamp hours.....	94
measuring diagonals.....	27	Reset Lamp Hours.....	65
mechanical setup		reset settings	51
standard screen	23	RGBS	43, 58
Thin mullion screen	25	RGBS connector.....	81
Mechanical Setup.....	15, 23	RS-232.....	14, 87, 99, 100, 102, 110
Mechanical Specifications	108	RS-232 Command Codes.....	100
Menu Button	89	RS-232 Control	99
MENU Button.....	90	RS-232 Control Items	102
menus	92	RS-232 IN Connector.....	83
Menus.....	90	RS-232 OUT Connector.....	83
Minimum Clearance.....	14	S	
Mirrors, cleaning	72	Safety	3
Misc Control	42, 63, 91	Safety Certifications	112
Misc Control menu.....	94	Saturation	40
Miscellaneous Controls.....	63	Save Config menu	95
mode	95, 96, 97	Save Configuration.....	51, 52, 91
Mon Sel	89	save settings.....	51
Monitor ID.....	62, 88	Scale the image	46
Monitor Select.....	62	screen removal tool.....	68, 69
Monitor Select menu.....	94	Screen Removal Tool.....	2
N		Screen, cleaning	72
NAK.....	99	screen, removing	
O		standard screen.....	24
Off	64, 89	thin mullion screen.....	26
On	89	settings	
Operating Temperature	13	save, recall, reset	51
Operation.....	33	Setup	
Optical Alignment	15	standard screen.....	23
Optical Specifications	107	Thin mullion screen	25
Options.....	2	Sharpness.....	42, 63, 91
P		Site Preparation	11
PC connector.....	82	SMPTE Color Bar	40
Phase	44, 89, 90	source.....	95, 96, 97
Phase Select menu	93	Source	34, 35, 89, 90
Picture Control Specifications.....	109	SOURCE ABSENT Message.....	75, 91
Position	45, 90	Source Select menu.....	92
Position menu.....	93	Specifications.....	107
Power	12	SRT-100	2, 68
Power and Start-Up Problems	73, 79	standard screen	23
Power Consumption	12	Start-Up Problems	73, 79
Power On/Off.....	88	Status Table, LED.....	76
Power Switch.....	53	STBY	85, 88
Prev Menu Button.....	89	STBY LED	76
Q		S-Video.....	39
Quick Start.....	9	S-VIDEO.....	87
R		System Hours menu	94
Rear Panel Connectors	85, 87	T	
Rear Panel Indicators	85	Temperature	13
Recall	91	Temperature, Operating.....	13
Recall Config menu	96	Test Patterns menu.....	94
Recall Config	91	Thin Mullion Screen	25
		Troubleshooting	73
		U	
		unit ID menu	94
		UNK.....	99

Clarity Visual Systems

V

VGA.....	14, 87, 110
Video Controls menu.....	93
Video Input Module.....	2
Video Wall Clearance.....	14
Voltage.....	12
Voltage Range.....	12

W

Wall Mode.....	95
----------------	----

wall processor.....	55
Wall Processor menu.....	95
<u>Warranty</u>	iii
White Level menu.....	93

Z

Zoom.....	46, 47
Zoom Factor menu.....	93

Free Manuals Download Website

<http://myh66.com>

<http://usermanuals.us>

<http://www.somanuals.com>

<http://www.4manuals.cc>

<http://www.manual-lib.com>

<http://www.404manual.com>

<http://www.luxmanual.com>

<http://aubethermostatmanual.com>

Golf course search by state

<http://golfingnear.com>

Email search by domain

<http://emailbydomain.com>

Auto manuals search

<http://auto.somanuals.com>

TV manuals search

<http://tv.somanuals.com>