

CLASSE

Owner's Manual
SSP-800
Surround Sound Processor

NOTICE

All of us at Classé take extreme care to ensure that your purchase will remain a prized investment. We are proud to inform you that all Classé components have been officially approved for the European Community (CE) mark.

This means that your Classé product was subjected to the most rigorous manufacturing and safety tests in the world. The CE mark certifies that your purchase meets or exceeds all European Community requirements for manufacturing consistency and consumer safety.

This equipment has been tested and found to comply with the limits for a Class B digital device, pursuant to Part 15 of the FCC Rules. Operation is subject to the following two conditions: (1) This device may not cause harmful interference, and (2) This device must accept any interference received, including interference that may cause undesired operation. These limits are designed to provide reasonable protection against harmful interference in a residential installation. This equipment generates, uses and can radiate radio frequency energy and, if not installed and used in accordance with the instructions, may cause harmful interference to radio communications. However, there is no guarantee that interference will not occur in a particular installation. If this equipment does cause interference to radio or television reception, which can be determined by turning the equipment on and off, the user is encouraged to try to correct the interference by one or more of the following measures:

- Reorient or relocate the receiving antenna;
- Increase the separation between the equipment and the receiver;
- Connect the equipment into an outlet on a circuit different from that to which the receiver is connected;
- Consult the dealer or an experienced radio/TV technician for help.

CAUTION: Changes or modifications to this equipment not expressly approved by the manufacturer could void the user's authority to operate the equipment.

This product incorporates copyright protection technology that is protected by U.S. patents and other intellectual property rights. Use of this copyright protection technology must be authorized by Macrovision, and is intended for home and other limited viewing uses otherwise authorized by Macrovision. Reverse engineering or disassembly is prohibited.

The information contained in the manual is subject to change without notice. The most current version of this manual will be posted on our web site at <http://www.classeaudio.com>.



Classé marks the "CE" symbol indicating compliance of this device with the EMC (Electromagnetic Compatibility) and LVD (Low Voltage Directive) standards of the European Community.



Classé complies with the European Parliament and Council Directive 2002/96/EC concerning Waste Electrical and Electronic Equipment (WEEE). This product must be appropriately recycled or processed in accordance with these directives. Consult your local waste disposal authority for guidance.



Classé products are designed and manufactured to comply with the Restriction of Hazardous Substances (RoHS) as stated in the European Parliament and Council Directive 2002/95/EC.

Important Safety Instructions

1. Read these instructions.
2. Keep these instructions.
3. Heed all warnings.
4. Follow all instructions.
5. Do not use this apparatus near water.
6. Clean only with dry cloth.
7. Do not block any ventilation openings. Install in accordance with the manufacturer's instructions.
8. Do not install near any heat sources such as radiators, heat registers, stoves, or other apparatus (including amplifiers) that produce heat.
9. Do not defeat the safety purpose of the polarized or grounding-type plug. A polarized plug has two blades with one wider than the other. A grounding type plug has two blades and a third grounding prong. The wide blade or the third prong are provided for your safety. If the provided plug does not fit into your outlet, consult an electrician for replacement of the obsolete outlet.
10. Protect the power cord from being walked on or pinched particularly at plugs, convenience receptacles, and the point where they exit from the apparatus.
11. Only use attachments/accessories specified by the manufacturer.
12.  Use only with the cart, stand, tripod, bracket, or table specified by the manufacturer, or sold with the apparatus. When a cart is used, use caution when moving the cart/apparatus combination to avoid injury from tip-over.
13. Unplug this apparatus during lightning storms or when unused for long periods of time.
14. Refer all servicing to qualified service personnel. Servicing is required when the apparatus has been damaged in any way, such as power-supply cord or plug is damaged, liquid has been spilled or objects have fallen into the apparatus, the apparatus has been exposed to rain or moisture, does not operate normally, or has been dropped.
15. Do not expose this apparatus to dripping or splashing and ensure that no objects filled with liquids, such as vases, are placed on the apparatus.
16. To completely disconnect this apparatus from the AC Mains, disconnect the power supply cord plug from the AC receptacle.
17. The mains plug of the power supply cord shall remain readily operable.
18. Do not expose batteries to excessive heat such as sunshine, fire or the like.

**WARNING: TO REDUCE THE RISK OF FIRE OR ELECTRIC SHOCK,
DO NOT EXPOSE THIS APPLIANCE TO RAIN OR MOISTURE.**

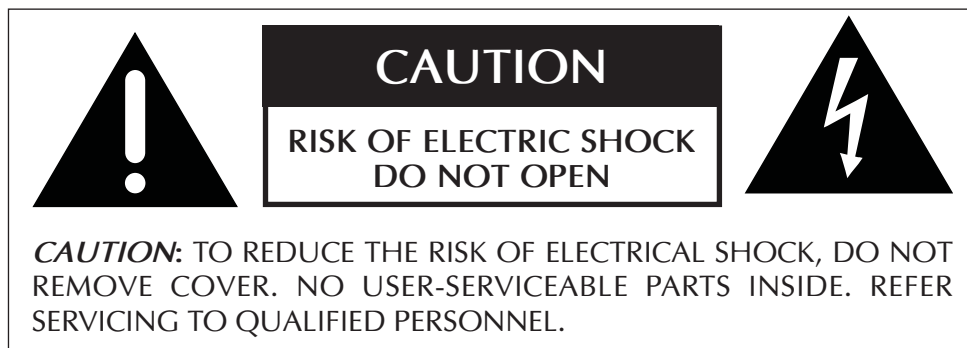

The lightning flash with arrowhead symbol within an equilateral triangle is intended to alert the user to the presence of uninsulated "dangerous voltage" within the product's enclosure that may be of sufficient magnitude to constitute a risk of electric shock to persons.



The exclamation point within an equilateral triangle is intended to alert the user to the presence of important operating and maintenance (servicing) instructions in the literature accompanying the product.

Contents

Introduction	6
Exceptional Design Features	7
versatile connectivity	7
upgradable DSP	7
superior performance	7
clean, dedicated power	7
high fidelity audio	7
professional grade video	7
room equalization and speaker control	8
flexible GUI	8
video preview	8
refined circuit design	8
extensive listening tests	8
extraordinary longevity	8
Unpacking and Placement	9
unpacking your SSP-800	9
placement considerations	10
warm-up/break-in period	10
operating voltage	11
voltage protection	12
Front Panel	13
Rear Panel	15
serial number	15
The Remote Control	22
Initial Setup	24
step 1: AC	24
step 2: cables	24
step 3: sources	25
step 4: amplifiers	25
step 5: loudspeakers	26
step 6: power up	27
Understanding Surround Sound	28
how many channels?	28
matrix or discrete?	28
post processing	30
Using the SSP-800	31
source selection	31
mode selection	32
video preview	33
controls	34
system trims	34
configuration select	35
The Menu System	36
system setup	37
volume setup	37
max volume	38
startup volume	38
IR setup	38
automation	39
mute setup	39
input setup	40
name	40
audio	41

configuration.....	41
in use	42
video	42
next input.....	42
triggers	42
profiles	43
room EQ	44
configuration.....	44
name.....	45
distances	45
levels.....	46
in use	46
speakers	46
auxiliary channels	48
black level.....	49
teach IR.....	49
display setup	50
brightness.....	50
timeout.....	50
language	51
OSD.....	51
colors	51
volume.....	51
Dolby/DTS	52
Dolby Pro Logic IIx	52
DTS Neo:6	52
remote Fkeys.....	53
important note on Fkey use	53
status.....	54
version info	54
sensors	54
CAN-Bus.....	54
features	54
hardware setup.....	55
using CAN-Bus.....	56
CAN-Bus shared features.....	57
configuration.....	57
operate	57
AC status	57
status	57
CAN-Bus model specific features	58
playlink	58
amp info.....	59
event log	59
Troubleshooting	60
Care & Maintenance	63
Specifications.....	64
Dimensions.....	65
Installation Worksheet.....	66

Introduction

Welcome to the Classé family!

Congratulations on your purchase of the Classé SSP-800 Surround Sound Processor, a next generation processor with reference-quality performance. We are sure that you will enjoy it for many years to come.

Classe values the relationships with our customers and intend on supplying the highest level of support along with our product. Registering your product will allow us to keep in touch and will ensure that you are notified regarding any future updates or options which become available. Furthermore, in the unlikely event that your product needs service support, a product that is already registered doesn't need your original sales slip for proof of warranty.

You can register online at www.classeaudio.com or complete and mail the registration card located in the separate warranty booklet.

Please take a few moments now to register your new Classé processor and record your serial number here for future reference.

Serial #: _____

Exceptional Design Features

The SSP-800 is a next-generation surround sound preamp/processor, conceived with pure performance as its raison d'être. It seamlessly unites a multitude of disparate audio and video signal formats to faithfully reproduce your music and movies as the artist intended.

versatile connectivity

The SSP-800 is a ten-channel preamp/processor with both balanced and single-ended connections for all channels.

upgradable DSP

A Texas Instruments DSP with double-precision 64-bit architecture processes all audio data. Floating point capability insures the most accurate results possible. All bass management filters, gains, and parametric filters benefit from the added precision. The DSP and critical support circuitry occupy a replaceable module for precision upgrading when necessary.

superior performance

Advanced circuit topologies, component parts, and circuit layout techniques combine for superior audio performance. Opto-couplers and low voltage differential signal (LVDS) pathways thoroughly isolate audio circuits, video circuits, and control circuits.

clean, dedicated power

Analog audio circuits benefit from a dedicated linear power supply based on a low noise toroidal transformer. Digital and control circuits draw from a separate low-noise, high current switching supply.

high fidelity audio

Custom-configured digital-to-analog converters and output stage components ensure exceptional dynamic range and resolution.

professional grade video

The SSP-800 incorporates professional grade video circuitry that has extraordinary bandwidth and dynamic range. Due to this, it can handle even the most demanding video signals specified in the HDTV standard. Whether the video is carried on HDMI, high definition component, or standard definition cables, it is decoded and made available for display and preview. Reference quality circuitry is used throughout the video path, delivering uncompromised picture quality.

room equalization and speaker control

All home theater sound systems are affected by room characteristics. Sound reflections and sound absorption can create dramatic variations in the performance of your system, particularly in the lower frequencies. The SSP-800 features a system of filters which can correct many room effects and provide the best possible sound.

flexible GUI

The front panel's LCD touchscreen supports an extremely flexible and versatile graphical user interface (GUI) while maintaining a clean, uncluttered appearance. The SSP-800 provides a range of controls that might otherwise require dozens of buttons and knobs on the front panel. Despite this power and flexibility, it remains simple to operate in day-to-day use.

video preview

The SSP-800's front panel touchscreen lets you view any selected video source in your system. The source's resolution can be down-converted for the LCD panel, giving you total flexibility to view any video source regardless of its resolution.

refined circuit design

Only the top performing audio components were designed into your SSP-800. The converter chips, passive components, op-amps, and analog power supply are all best-in-class parts. Furthermore, the PCB (printed circuit board), and pad material has been specifically chosen to provide the best performance. Even the routing of the traces is optimized to get the best performance out of the circuit. Every detail is tested, every possibility exhausted, until we are content with the results.

extensive listening tests

Our experience has shown that great measurements alone do not guarantee superb audio or video performance. For this reason, all Classé products are laboriously fine-tuned during the development process by carefully controlled usage tests. Every individual stage is evaluated and adjusted before the product is released for production. As in the case with measured performance, actual performance of every unit is verified as part of our production standard.

extraordinary longevity

Because Classé has developed highly refined circuits over many years, we have vast experience in what works well over the long term. Using this knowledge base, along with quantitative results derived from highly accelerated life testing (H.A.L.T.) allows us to select only the most reliable parts. This attention to detail and design allows us to manufacture products which stand the ultimate test. Time.

Just as past Classé products have done for their owners, we are certain that your new Surround Sound Processor will give you many years of continuous enjoyment.

Unpacking and Placement

We have taken all precautions, and made every effort to make the SSP-800 simple and straightforward to install and use. Still, we recommend that you take a few minutes to review this manual. Even if you are having the processor professionally installed, you will want to know how to efficiently operate it to full potential.

The SSP-800 menu system includes features that provide you with a great deal of fine-tuning. Still, we have no way to evaluate outside variables such as the acoustical characteristics of your listening space and the associated equipment of your home theater system. Therefore, it is up to you to make the final audio adjustments for the optimum performance of your system.

For this reason, we strongly encourage you to have your processor installed and calibrated by your dealer. The experience, training, and specialized equipment they have can make a profound difference in the final performance of your system.

unpacking your SSP-800

Carefully unpack the SSP-800 Surround Sound Processor according to the supplied instruction sheet. *Do not forget to remove all accessories from the carton.*



Important!

Keep all packing materials. Transporting the SSP-800 without using the packaging specifically designed for it may result in damage that is not covered under the warranty.

placement considerations

Before installing your SSP-800 into the system, be sure to read the following placement suggestions.

- Do not place the SSP-800 directly on the top surface of a power amplifier or any other heat source. Also keep the processor out of direct sunlight.
- Place the SSP-800 so that the IR window on the front panel is clearly visible and not blocked.
- Position the SSP-800 in a central and convenient location for both visibility and use. The processor is the hub for all other component connections and generally your primary interaction point. In addition, by placing the processor close to the other system components, you're minimizing the cable lengths and hence reducing the amount of noise that's introduced into the system through the cabling.
- Leave adequate clearance behind the SSP-800 for the AC cord and connecting cables. We suggest eight inches (20 cm) of free space to allow cables sufficient room to bend without crimping or undue strain.
- Allow at least three inches (7.5 cm) of clearance above and to each side of the processor for ventilation. Do not obstruct the area around the processor so that excess heat can dissipate through normal air circulation. Avoid placing the processor on a soft surface, such as plush carpeting, that may restrict airflow.



Important!

Obey all placement considerations. Not obeying the placement considerations may result in damage that is not covered under the warranty.

warm-up/break-in period

Your new Classé processor delivers outstanding performance immediately. However, you can expect to hear subtle improvements as it reaches normal operating temperatures and various components, especially capacitors, “break-in”.

In our experience, you can expect the greatest changes within the first 300 hours. After initial break-in, you'll enjoy consistent performance levels for years to come.

The only exception is if the unit is unplugged for an extended period of time, during which the processor will cool down. Depending on the degree of cooling involved, you should expect a brief warm-up period before the Surround Sound Processor's sound quality is at its best.

operating voltage

The operating voltage of your SSP-800 has been factory configured to 100V, 120V, 220V, 230V, or 240V AC, depending on the country in which you purchased it (in European Union countries, CE regulations specify 230V).

*This voltage setting is **not** user selectable. Ensure that the voltage rating on the rear panel of the SSP-800 Surround Sound Processor matches the AC voltage rating of your electrical outlet. If the AC voltage is incorrect, please contact your local authorized Classé dealer or distributor.*



Important!

Attempting to operate your SSP-800 from an incorrect AC voltage rating may cause irreparable damage to your processor, which may not be covered by your warranty.

If you are not planning to use the Surround Sound Processor for an extended period of time, for example due to vacation or other travel, we suggest that you disconnect it from AC power.

*Make certain that the Surround Sound Processor is in **Standby** prior to disconnecting it.*

Physically disconnect any and all valuable electronics from AC power during electrical storms. A lightning strike anywhere near your home can generate a tremendous surge on the AC mains that can jump across a simple power switch. A surge from a lightning strike, which may be many thousands of volts, can cause serious damage to any piece of electronics, no matter how well designed and protected.

voltage protection

The SSP-800 Surround Sound Processor contains protection features that prevent the processor from operating at dangerously high or low voltages. These features are incorporated to help protect the processor from dangerous power surges and other power irregularities that could cause extensive damage to the processor. This circuitry guards against the following irregular supplied power conditions.

- **Startup Voltage:** If the AC mains voltage is NOT within a range of approximately -15% to $+10\%$ of its nominal value at startup, the SSP-800 does not turn on. For example, a 120V AC service generally requires the AC mains voltage to be no lower than 95V and no higher than 135V in order for the processor to turn on and operate normally.
- **Over-voltage Condition during Operation:** If the AC mains voltage surges by roughly 10% or more during operation, the Surround Sound Processor enters a protection mode and shuts down. The Standby LED flashes to indicate that the protection mode has been engaged. An error message also displays on the LCD touch screen.
- **Under-voltage Condition during Operation:** If the AC mains voltage sags by 15% or more, the Surround Sound Processor does continue to play since the voltage irregularity won't harm the processor, but the sound quality may be degraded due to the compromised power conditions. The Standby LED flashes to indicate an irregular power condition exists.

In such cases, normal operation can only resume when the following conditions are met:

- The irregularity in the power input is no longer present.
- The SSP-800 is power cycled, to clear the protection mode.

Refer to the *Troubleshooting* section found later in this manual for more information.

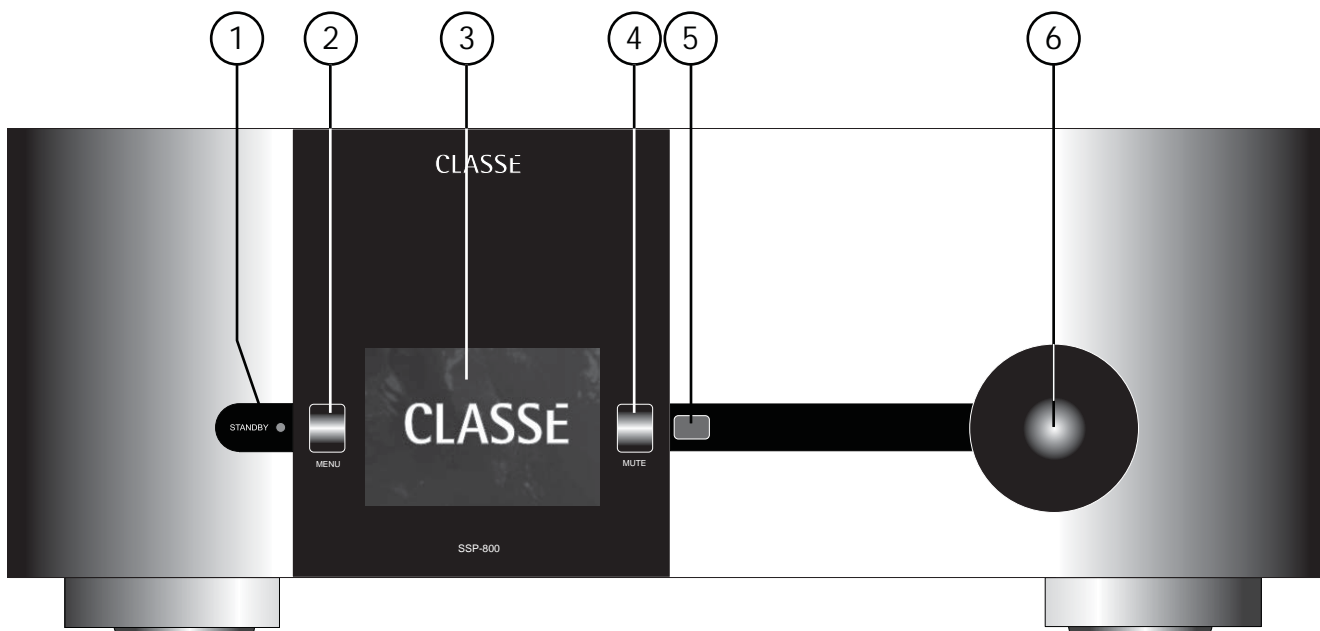

Front Panel

The front panel of the SSP-800 is shown above. The numbers in the drawing refer to the descriptions that follow.

1 Standby/On Switch

Pressing the **Standby** button puts the SSP-800 into *standby* mode – a low-power state which leaves the Surround Sound Processor and outputs inactive but still allows the processor to respond to system commands via any of the supported control protocols (IR input, CAN-Bus, RS-232, or triggers).

If the processor is already in Standby mode, pressing the Standby button fully powers up the SSP-800.

- LED On – the SSP-800 is in Standby mode, or the display has timed out due to a display setting.
- LED flashes (at power-up) – the SSP-800 is in the process of power-up initialization.
- LED Off – the SSP-800 is powered on, fully operational, and the display active.
- LED flashes rapidly (after power-up) – the AC mains voltage is out of range.

2 Menu On/Off Switch

Press once to call up the main page of the menu system, which replaces the normal front page or Home page of the Touchscreen and OSD (On-Screen Display). Press the **Menu** button again to revert to the Home page.

The menu system gives you control over operational details including: system setup options, various display options (including the *language* used by the menu system), and custom installation capabilities so that the SSP-800 integrates smoothly into the most complex systems. For more information, see *The Menu System* later in this manual.

3 Touchscreen

The front panel touchscreen has two main functions:

- Navigation of the SSP-800 menus and controls by simply touching the screen to make your selections.
- Viewing incoming video from the selected source.

4 Audio Mute Control

The **Mute** button reduces the SSP-800's volume by a pre-determined amount. Pressing it a second time restores the volume to its previous level. This behavior can be easily customized for very specific user requirements. (See the section on *Volume Setup* for more information.)

*NOTE: If you increase the volume using either the front panel volume knob or the remote control while **Mute** is engaged, the mute control disengages, and audio adjustments are executed starting from the muted level. This is a safety measure to prevent accidentally restoring the volume at unexpectedly high levels.*

5 IR window

The location of the IR (infrared) sensor for the remote control is behind this window. In most cases, there must be a clear path between the IR window and the remote control in order for the SSP-800 to acknowledge the remote control commands.

If the IR window is not in view, for example if it's placed in a cabinet or closet, then the rear panel IR input can be utilized for remote control use. For more details about this option, see the IR input description in the *Rear Panel* section found later in this manual.

In addition to receiving IR commands, the SSP-800 can also transmit IR commands to third-party learning remote controls. For more details about this option, refer to the *Teach IR* description in the *Menu Tree* section found later in this manual.

6 Volume Control Knob

The large rotary knob on the right side of the front panel controls the system volume level.

The **volume** knob increases and decreases volume in precise 0.5dB increments throughout most of the volume range. At extremely low volume, the step size is increased somewhat to facilitate moving between extremely low and normal listening levels. The volume range is from -99.0dB to +14.0dB.

You can also change the volume control display to suit your preferences. For more information, refer to the *Volume* description in the *Display Setup* section found later in this manual.

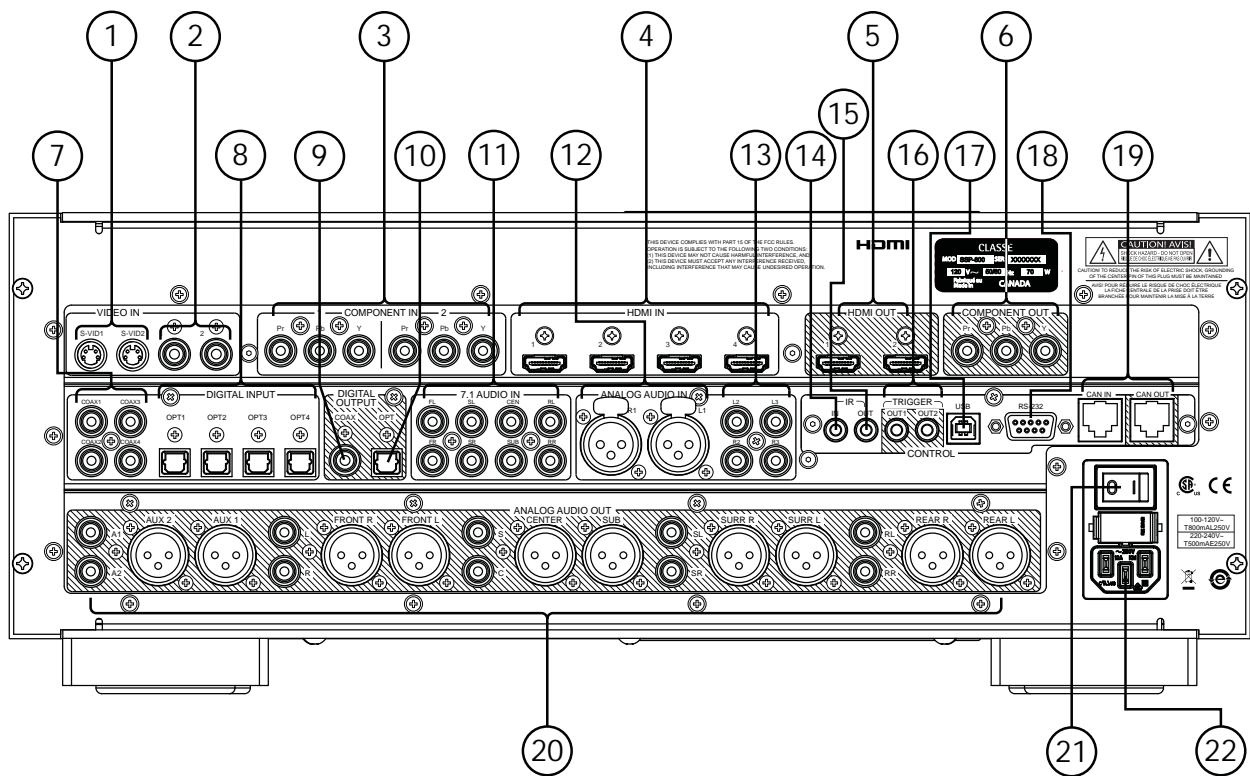

Rear Panel

The rear panel of the SSP-800 is shown above. The numbers in the drawing refer to the descriptions in this section.

serial number

You'll find your processor's serial number on the top right edge of the rear panel, as shown in the graphic above (the black label). Please record this number on the *Introduction Page* (page 6) of this manual for future reference.

And since you have found the serial number, please use it to register your purchase, if you haven't done so yet. As we've said, your registration is our way of keeping in touch with you. We will use the information to advise you of any updates or other items of interest. Registration is simple, so please register online at www.classeaudio.com or fill out the registration card and drop it in the mail.

1 S-Video Inputs

The SSP-800 supports two S-Video inputs, labeled S-VID1 and S-VID2. Use these inputs when the output of your source component is S-Video.

S-Video (also called Super-Video or Y/C video) is an analog video format in which the black and white (luminance or Y) and color (chrominance or C) portions of the video signal are transmitted separately and recombined by the receiving device. S-Video transmission produces less color bleeding and better edge definition than a standard composite video connection.

2 Composite Video Inputs

The SSP-800 supports two composite video inputs, with RCA connectors labeled 1 and 2. Use these inputs when the output of your source component is composite.

A composite video signal (also called “baseband video” or “NTSC video”) combines the black & white and the color components of a video signal and transmits them over a single cable. Composite video transmission always generates interference between luminance and chrominance portions of the signal and, for that reason, is usually inferior in quality to the S-Video format.

3 Component Video Inputs

The SSP-800 supports two component video inputs, each with three RCA connectors labeled 1 and 2 – the component video format requires three separate cables labeled Pr, Pb, and Y. Use these inputs when the output of your source is component.

Although still analog, a component video signal provides a much sharper image than S-Video or composite formats. The component video delivers color video signals by maintaining the three YUV signal segments in three separate channels. YUV is a video format definition which defines the “color space”, a mathematical model of the color within an image, of a video signal. Y stands for luma (brightness), U for a color difference signal (blue minus luma or B-Y), and V for second color difference signal (red minus luma or R-Y). Therefore, the three sections of the component signal are Y (luminance – the black & white portion of the video), Pb (Blue Color Difference), and Pr (Red Color Difference).

To connect the source component video output cables to the SSP-800 component video input rear panel connectors:

- Use the red cable for the Pr (Red Color Difference) connectors.
- Use the blue cable for the Pb (Blue Color Difference) connectors.
- Use the green cable for the Y (Luminance) connectors.

The SSP-800 accepts component video at either standard definition (SD) or high definition (HD) video rates. Component video is NOT accepted at 1080p via analog component connections.

NOTE: Although the SSP-800 component inputs support all resolutions except 1080p, some source material will be restricted to 480p at the source.

4 HDMI Inputs

The SSP-800 supports four HDMI inputs, labeled 1 to 4. Whenever possible, we recommend the use of HDMI for all audio and video source input connections. The SSP-800 is HDMI v.1.3b enabled, supporting Deep Color, 1080p @ 24/50/60 fps, and x.v.Color(xvYCC).

The HDMI (High Definition Multimedia Interface) format is the only available single-cable digital pathway for both video and audio signals, providing higher performance levels and simplifying component-to-component connections. HDMI is backwards compatible with the earlier video-only DVI (Digital Video Interface) standard. Adaptors to convert a DVI cable connector to HDMI and vice-versa are readily

available. The HDMI standard also incorporates HDCP (High Definition Content Protection); a separate content-protection technology to prevent unauthorized distribution or duplication of copyrighted material.

5 HDMI Outputs

The SSP-800 supports two HDMI outputs, labeled 1 and 2. The SSP-800 HDMI outputs support HDMI V.1.3b featuring Deep Colour, x.v.Color(xvYCC), 1080p 24/50/60 fps, and provides a 2 channel SPDIF downmix of the source material.

Non-HDMI source material is encoded for an HDMI display at the source's native video rate. HDMI input signals are NOT converted to analog format, and are only output via HDMI at the incoming resolution. When an analog video input signal is output via HDMI to the display, the video input is converted to digital format and output at its native rate. The two HDMI outputs are NOT independent.

NOTE: HDMI is an interactive format, which can occasionally cause format errors between the source devices and the output display. If you connect the SSP-800 HDMI outputs to two different displays, the HDMI source automatically provides a signal compatible for both displays. In some cases, this response can result in less-than-optimal resolutions for one or both displays.

6 Component Video Output

The SSP-800 is equipped with component video output via 3 RCA connectors labeled Pr, Pb, and Y. Use this connection to connect to non-HDMI displays. The component output does not support output of 1080p signals.

NOTE: Due to HDCP licensing restrictions the component video output will not work with all source material input via HDMI. Depending on the material component output may be restricted to 480p.

7 Digital Audio Inputs - Coaxial

The SSP-800 supports four digital audio inputs, with SPDIF connectors labeled COAX1 to COAX4. These inputs accept PCM data streams up to 24-bits long and up to 192kHz sampling frequency. We recommend using cables that are optimized for digital audio signal transfer and that carry a 75Ω impedance rating. Your Classé dealer can help you with proper cable selections.

8 Digital Audio Inputs - Optical

The SSP-800 supports four digital audio inputs, with optical TOSlink™ connectors labeled OPT1 to OPT4. These inputs accept PCM data streams up to 24-bits long and up to 192kHz sampling frequency. We recommend using cables that are optimized for digital audio signal transfer. Your Classé dealer can help you with proper cable selections.

NOTE: The bandwidth limits of TOSlink™ components are very much strained at a 192kHz sampling frequency. For that reason we recommend keeping the TOSlink™ connections at a maximum rate of 96kHz.

9 Digital Audio Output - Coaxial

The SSP-800 supports one digital audio coaxial output, with SPDIF connector labeled COAX. This output can pass PCM data streams up to 24-bits long and up to 96kHz sampling frequency.

10 Digital Audio Output - Optical

These digital outputs carry only digital audio data, excluding any sub-code information which some recorders might use to extract CD track information.

11 7.1-Channel Analog Audio Inputs

These inputs are designed for any multi-channel source with analog outputs, such as SACD or DVD players, although we highly recommend using the HDMI or digital outputs if possible. When connecting the analog audio inputs, make sure to attach each cable from the source component output to the appropriate SSP-800 input.

Starting from the source, connect the Front Left output to the FL (Front Left) input of the SSP-800, then the source centre output to the CEN (centre) input of the SSP-800, and so on.

These analog audio input signals are passed through the SSP-800 and to the speakers with no processing, to preserve the purity of the original signal. When these inputs are selected, only volume control processing is enabled.

12 2-Channel Balanced Analog Audio Inputs

The SSP-800 was designed with a 2-channel balanced analog audio input, using a pair of balanced XLR connectors labeled R1 and L1. Use this input with any 2-channel analog source component with balanced outputs.

NOTE: This input conforms to the AES (Audio Engineering Society) "pin 2 = hot" convention. The pin assignments of these XLR-type female output connectors are:

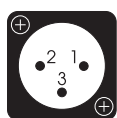

Pin 1: Signal ground

Pin 2: Signal + (non-inverting)

Pin 3: Signal - (inverting)

Connector ground lug: chassis ground

Verify that the source components are compliant with this convention (Classé components are compliant). If not compliant, contact your Classé dealer for assistance.

13 2-Channel Single-Ended Analog Audio Inputs

The SSP-800 was designed with a pair of 2-channel single-ended analog audio inputs using the RCA connectors, labeled L2/R2 and L3/R3. Use these inputs with any 2-channel single-ended analog source component.

NOTE: The Balanced and Single Ended 2-channel analog audio inputs can be set for either bypass mode (no DSP processing) or converted to digital format to allow bass management, surround mode processing, and/or equalization.

14 IR Input

Use the IR input when the front panel IR window does not have a clear line-of-sight with the remote control, for instance, when the SSP-800 is installed in a cabinet or closet. Attach this input to an infrared repeater system to route signals from the remote control to the SSP-800 via a mono mini-jack (3.5mm phono).



The list of available IR command codes can also be used in macros for sophisticated remote control systems, facilitating the control of the SSP-800 in the larger context of the complete system.

15 IR Output

Use the IR output to pass IR commands from an external IR transmitter through the SSP-800 to another component, when necessary. The output uses a mono mini-jack (3.5mm phono) with the same properties as the diagram in the previous section.

16 Trigger Outputs

The SSP-800 supports two trigger outputs, with mono mini-jacks (3.5mm phono) labeled OUT1 and OUT2. Each trigger outputs a 12V DC signal at 100mA and each can be controlled individually. Use these outputs to control other system components such as amplifiers, screens, and window blinds. Refer to the **Triggers** description in the *Menu System* section for more details.



17 USB Port

The USB port is for downloading future system software updates. The latest system software is posted on the Classé website (www.classeaudio.com) and may be downloaded/installed by you or your Classé dealer simply following the step-by-step instructions.

18 RS-232 Port

The primary purpose of the RS-232 port is to support the use of external commands to allow remote control of the SSP-800 by such systems as AMX® and Creston™. For more information about these systems, contact your Classé dealer.

The RS-232 port can also be used to download the operating software for the SSP-800, when updates are released. As in the case of the USB, the latest system software is posted on the Classé website (www.classeaudio.com) and may be downloaded/installed by you or your Classé dealer simply following the step-by-step instructions.

NOTE: The RS-232 connector is inactive when a USB device is connected.

19 CAN-Bus Input and Output

CAN-Bus (Controller Area Network) allows several Classé components to be connected together for simultaneous operation, such as switching from *On* to *Standby*. Using the CAN-Bus Input and Output connectors, the Classé components can be daisy chained together and controlled via the CAN-Bus interface.

NOTE: The final component in the daisy chain MUST have a termination plug inserted into the CAN-Bus output.

For more information, refer to the CAN-Bus section found later in this manual.

20 10-Channel Analog Outputs

The SSP-800 supports ten analog audio outputs, with both balanced (XLR) and single-ended (RCA) connections. Connect the appropriate Front L/R, Sub, Surr L/R, and Rear L/R connectors to the appropriate power amplifiers.

NOTE: The Rear L/R connectors are only active when the SSP-800 output is setup for a 7.1-channel surround system.

The Aux 1 and 2 outputs are programmable and can be used for the following purposes:

- Assigned as a 2-channel down-mix of the selected multi-channel signal for either an analog recorder or a separate listening area.
- Assigned to follow the main Front L/R speakers for use in a bi-amplification arrangement.
- One or both may be assigned as additional subwoofers with the ability to select between mono, and stereo modes.

Refer to the *Menu System* section for more details regarding optional uses for the auxiliary analog output channels.

NOTE: The Balanced (XLR) Output pin assignments adhere to the AES (Audio Engineering Society) "Pin 2 = hot" standard. The XLR male outputs carry the following pin assignments:

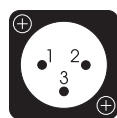

Pin 1: Signal ground

Pin 2: Signal + (non-inverting)

Pin 3: Signal - (inverting)

Connector ground lug: chassis ground

Refer to the operating manuals of your balanced-input power amplifiers to verify that the pin assignments of their input connectors adhere to this standard (Classé power amplifiers are compliant). If your amplifiers are not compliant, ask your Classé dealer for assistance.

21 Main Power On/Off Switch

This switch connects and disconnects the SSP-800 from AC.

*NOTE: Changes to settings are stored whenever the SSP-800 is put into **Standby**. Turning off power to the unit before first entering Standby mode erases any setting changes that have been made since the unit was last placed in Standby mode.*

22 AC Power Cord Input

The detachable three-conductor AC power cord and the socket into which it connects conform to rigorous standards developed by the IEC (International Electrotechnical Commission).



Danger!

Your SSP-800 contains potentially dangerous voltages and current capabilities. Do not attempt to open it! There are no user-serviceable parts inside. All service must be referred to a qualified authorized Classé dealer or distributor.

The Remote Control

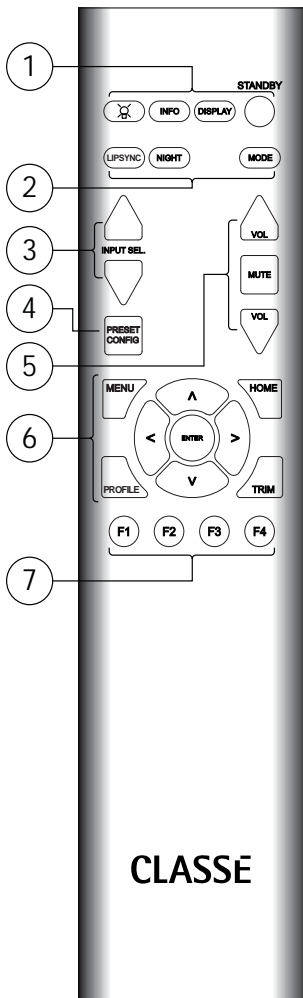

Your SSP-800 Surround Sound Processor includes a versatile remote control for both the processor itself and several aspects of the rest of a Classé-based system. The buttons are arranged in logical groups according to their functions. The remote control of the SSP-800 is shown on the left. The numbers in the drawing refer to the descriptions that follow.

1 Basic Functions

The four buttons along the top of the remote control groups the following basic control functions:

- **Light** turns on the backlighting of the remote control for better visibility under low-light conditions. After a few moments of inactivity, the backlight switches off automatically.
- **Info** opens the Status display on the SSP-800 front panel touchscreen. See the *Menu System* section found later in the manual for details about the Status display.
- **Display** cycles through the three brightness levels of the front panel touchscreen display.
- **Standby** switches the SSP-800 between the *Standby* and *Operate* states.

2 Audio Processing Functions

The next three buttons offer the following processing controls for the audio signal:

- **Lipsync** is an audio-only function that delays the arrival time of the audio portion of an A/V (Audio/Video) source. If the audio and video portions of the source do not reach the speakers and the display simultaneously, the resulting material appears to be out-of-sync. Video processing often delays video signals relative to the audio, with the result being that the audio track is played too early. The Lipsync function allows you to delay the audio until it is correctly synced to the video track. The adjustment range is 0 to 150 ms. Lipsync affects all channels equally.
- **Night** engages or disengages the Night mode for Dolby Digital soundtracks. The Night mode is a dynamic range compressor that reduces peaks and increases low-level passages so you can still enjoy the full range of movie soundtracks but with less chance of disturbing others.
- **Mode** displays the available surround modes on the front panel touchscreen. Press the **navigation** arrow keys to move up and down the list, then press **Enter** to make your selection. For additional information about the surround modes, refer to the *Using the SSP-800* section found later in this manual.

3 Input Sel (Selection) Button

To change inputs, simply use the **Input Selection** arrow buttons to step through the inputs.

You can deactivate unused inputs to keep your input selection list smaller and easier to navigate. Refer to the *Menu System* section found later in the manual for further instructions.

4 Preset Config (Configuration) Button

This button steps through the configurations set to “in use”. If there is already a configuration active (due to being a default) for a particular input it will be overridden until the input is selected again, or the user selects that default configuration.

5 Volume Control & Mute Buttons

The **Volume Up** and **Down** arrow buttons increase or reduce the overall volume level of the audio output. The **Mute** button controls the system volume level. Pressing the Mute button reduces the audio output volume level by a pre-determined amount. You can customize selected features of both the Mute button and volume level. Refer to the *Volume* description in the *Menu System* section found later in the manual for further instructions.

6 Navigation & Menu Buttons

The central section of the remote control contains the navigation buttons and the menu access buttons. This array of buttons is used for navigating the menu system on the SSP-800. Each of the buttons performs the following function(s):

- **Menu** accesses the main screen for the menu system, in the same fashion as the front panel **Menu** button.
- **Home** returns the touchscreen display to the *Home* page, which presents the normal operation options – Source, Mode, Video Preview, and Controls. The **Home** button essentially acts like a “back to start” button – no matter how deeply you’ve navigated into the menu system, a simple button push returns you to the front page.
- **Navigation Arrows** are the **Up** (▲), **Down** (▼), **Left** (◀), and **Right** (▶) arrow buttons, which allow you to select, by highlighting, the different menu options with the menu system.
- **Enter** selects options. Pressing the **Enter** button selects the highlighted menu item in any menu screen.
- **Profile** button accesses the *Profile* page(s). Profiles are customized versions of the system’s *Home* screen. You can name these profiles and pre-program them so you have direct access to frequently used controls. See the *Profiles* description in the *Menu System* section found later in the manual for more details.
- **Trim** button accesses the *System Trims* menu screen, which allows you to make temporary adjustments to speaker levels and the lip sync feature. These temporary trims do not override the settings you made through the *Setup* menu and are discarded when you select a new source. See the *Menu System* section found later in the manual for more details.

7 Function Keys (F1 to F4)

The last four buttons on the remote control are the **Function** buttons, or FKeys, which provide additional flexibility to the SSP-800 remote control. Think of them as “favorite” buttons that provide direct access to a specific function or command not covered by the other buttons. Refer to the **Remote Function** Buttons description in the *Menu System* section found later in the manual for more information.

Initial Setup

Your SSP-800 Surround Sound Processor is delivered with default factory settings to facilitate initial setup. But we highly recommend that you work with your Classé dealer for the final setup of the SSP-800 processor. Your dealer's knowledge and experience with Classé products will ensure that your surround system is optimized for your listening space.

However, if you can't wait to get started, this section is designed to assist you in setting up and becoming familiar with the SSP-800 hardware. Once the initial setup is complete, be sure to read the rest of this manual to familiarize yourself with the daily operation and customizable features of your SSP-800 Surround Sound Processor.

Step 1 **Connect the SSP-800 and all system components to AC power.**



Important!

Make sure everything – especially your power amplifier(s) – is turned off before connecting power!

Connecting all system components to AC power, before making any interconnections between components, ensures that every component has a solid connection to ground. This lessens the chances of a static discharge that may damage delicate electronics or your loudspeakers.

Step 2 **Choose the appropriate cables.**

Before you start connecting components together, let's take a minute to discuss the cables you will be using. The audio outputs available on the rear panel include both balanced XLR connectors and unbalanced, or single-ended, RCA connectors.

Single-ended RCA audio connections are the most popular means of transmitting audio in consumer electronics. As long as you use high quality, low capacitance cables, single-ended connections provide very satisfactory results.

However, balanced audio connections between components provide the best analog signal connection because they effectively double the signal strength. More importantly, as compared to single-ended connections, they significantly improve resistance to common noise, therefore enhancing audio transparency, detail, and dynamics.

Please consult your local Classé dealer for advice on which cables are best suited for your system.

Step 3 **Connect all source components to the SSP-800 rear panel.**

Source devices that you may want to integrate into your surround system might include audio and video devices, such as CD and DVD players, and your main display, such as a flat-panel display or projection system. If necessary, refer to the *Rear Panel* section in this manual for a detailed description of each connector found on the rear panel. Your local Classé dealer can also provide useful suggestions for what source components you should add to your system and guidance in setting them up.

Make sure you keep a detailed record of the rear panel connectors that you used while connecting the source components!

To help keep track of the different sources, we recommend keeping a pencil-and-paper record while you set-up the surround system. You'll need to know what connectors each source is attached to when you enter the setup menus. An *Installation Worksheet* is included at the end of this manual to assist you.

NOTE: In the SSP-800 default settings, each rear panel input is associated with an input selection within the Setup menu. A complete list of the factory default input settings is available at the end of this manual.

Step 4 **Connect the power amplifiers to the SSP-800 rear panel.**

Important!



Verify that the power amplifier(s) is plugged in but powered OFF before connecting to the SSP-800!

We recommend using high quality cables with XLR connectors. Connect the cables to the *Main Analog Audio* outputs on the SSP-800 rear panel, using the balanced XLR connection options.

NOTE: These pin assignments are consistent with the standards adopted by the Audio Engineering Society. Refer to the operating manuals of your balanced-input power amplifiers to verify that the pin assignments of their input connectors correspond to the SSP-800. If you are using Classé amplifiers, this note does not apply.

If needed, the pin assignments of the XLR-type male output connectors are:

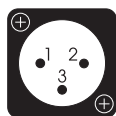

Pin 1: Signal ground

Pin 2: Signal + (non-inverting)

Pin 3: Signal - (inverting)

Connector ground lug: chassis ground

Connect the Main Analog Audio Outputs, either RCA or XLR, from the rear panel of the SSP-800 to the corresponding inputs on your amplifier(s) as follows:

- Connect the SSP-800 Front Left and Front Right outputs to the inputs of the amplifier(s) designated for the Front Left and Front Right speakers, respectively.
- Connect the SSP-800 centre output to the input of the amplifier designated for the centre channel speaker.
- Connect the SSP-800 Left Surround and Right Surround outputs to the inputs of the amplifier(s) designated for the Left Surround and Right Surround speakers, respectively.
- If you are setting up a 7.1-channel system, then also connect the SSP-800 Left Rear and Right Rear outputs to the inputs of the amplifier(s) designated for the Left Rear and Right Rear speakers, respectively.
- If you are using a subwoofer, connect the SSP-800 subwoofer output to the input of the designated amplifier or powered subwoofer.

*NOTE: Make sure connections from the subwoofer output go **only** to an amplifier connected to a subwoofer, as low frequency signals can damage a small full-range speaker not designed for high output bass reproduction.*

Verify that each cable is clearly labeled so that you don't mix them up. When connecting a cable, make sure the cable has a good connection and is firmly attached to the rear panel connectors on both the amplifier and the SSP-800.

The SSP-800 also provides two **Auxiliary** analog audio outputs. See the *Rear Panel* section for more details about the Auxiliary outputs.

Step 5 **Connect the loudspeakers to the amplifiers.**



Important!

Verify that the power amplifier(s) is plugged in but powered OFF before connecting to the SSP-800!

Connect each loudspeaker to its designated amplifier(s) channel. Pay close attention to the phase of the speaker connections – *always connect an amplifier's red (+) terminals to the red (+) terminals of the loudspeaker. Likewise, connect black (-) terminals to black (-) terminals.*

Step 6 **Power up the system!**

Now you are ready to power up your SSP-800 and your surround system.

- Turn the rear panel power switch of the SSP-800 to **ON**.
- The initial power-up cycle of the SSP-800 takes approximately 90 seconds. During this time, the blue LED on the standby button flashes.
- When the power-up cycle is complete, the SSP-800 enters Standby mode. The LED stops flashing but remains illuminated, indicating that the SSP-800 is in Standby mode. Refer to the *Front Panel* section, for more details about Standby mode.
- Press the **Standby** button or the front panel touchscreen to bring the SSP-800 to its fully **ON** mode. The front panel touch screen displays a blue screen with an “initializing” message and then switches to the home page of the menu system. Refer to the *Menu System* section found later in the manual for more information.

The physical setup of the SSP-800 and system components is complete.

Understanding Surround Sound

Today's sophisticated surround sound systems have spawned a bewildering array of technologies and acronyms. In this section, we'll give you a basic understanding of what all that jargon means. As a result, you'll be better equipped to take advantage of the best that home entertainment has to offer.

how many channels?

Today's home entertainment systems reproduce soundtracks that include anything from one to eight separate channels of information. Examples include:

- Watching mono movies, such as *Casablanca* or *The Wizard of Oz*, having only a single channel of audio information in the soundtrack.
- Listening to a musical CD, which is typically stereo or 2-channel sound.
- Watching the original *Star Wars* in the original Dolby Surround Pro Logic format, which is four channels of information derived from two channels.
- Watching a recent movie or T.V. show in a 5.1-channel or 7.1-channel surround format, which identifies that the source material has either five or seven full-range signals for the front, surround, and rear speakers plus the .1 signal for the Low Frequency Effects (LFE), also referred to as the LFE channel, for the subwoofer.

Your SSP-800 handles all of these tasks with ease, switching to an appropriate processing mode automatically upon sensing the nature of the incoming signal.

However, you may still have to select from the available choices. For example, disc-based media often contains multiple soundtracks with varying numbers of channels and even different languages. Because you may have to choose the one you want to hear using the menu of the media itself, you should know what jargon you'll likely see.

matrix or discrete?

When movie-makers first wanted to expand beyond simple stereo (left and right audio channels), they had a problem - the entire infrastructure on which they depended was stereo.

Dolby Laboratories solved that problem with a system called Dolby® Surround that embedded two extra channels of audio sound into the existing stereo pair so that specialized circuitry could retrieve the extra information with reasonable accuracy. This technique, whereby channels are mixed together with the intention of separating them later, is called matrix encoding and decoding.

The disadvantage, as you might expect, is that it is difficult to completely and perfectly separate two channels that have been mixed together.

By contrast, modern soundtracks use discrete channels of information. That is, each speaker has a distinct signal that is completely independent of every other channel. This approach is clearly more desirable, since it gives the movie-makers more creative control over the quality of your experience. Musicians also prefer discrete formats, since it allows them to place their instruments and voices with greater precision, to create the musical effects they desire.

There are many multi-channel formats available. Table 1, below, identifies the most common multi-channel formats to help you sort out some of the possibilities.

Table 1: Common multichannel modes

Name	# Chs	Matrix/Discrete	Comments
analog stereo	2	Discrete	Found on almost all sources, including tape decks, tuners, and CD players.
analog multi-channel input	6-8	Discrete	A multi-channel analog input used mostly for SACD & DVD-Audio.
Dolby Surround Pro Logic	4	Matrix	The original matrix decoding system designed to squeeze four channels into two and then retrieve them.
Dolby Pro Logic II	Up to 5.1	Matrix	An improvement of Dolby's original Pro Logic matrix decoder, Dolby PLII is designed for 5.1 surround systems.
Dolby Pro Logic IIx	Up to 7.1	Matrix	An improvement of Dolby PLII, this version uses the 2ch or 5.1channel source audio to create as many as 7.1 channels (depending on speaker setup) of surround sound.
Dolby Digital (formerly AC-3)	1.0-5.1	Discrete	The most common modern digital source, used in HDTV, DVD, etc.
Dolby Digital EX	6.1	Discrete	A 7th channel of discrete information was recorded during filming and is encoded into the media. This information is used to create a single rear centre, or two mono rear centres depending on the speaker setup (6.1 or 7.1).
DTS	1.0-5.1	Discrete	Similar to Dolby Digital in practice, though it uses a different technology.
DTS-ES Matrix	6.1	Mostly Discrete	The centre rear channel is a matrix channel encoded into the left and right surround channels. The processor reads flags and "unfolds" the centre channel information; all other channels are discrete.
DTS-ES Discrete	6.1	Discrete	All 6.1 channels are discrete
DTS Neo:6	5-6	Matrix	Designed for the playback of film or music sources and can derive 5 or 6 channels with surround and/or rear speakers

Dolby Digital Plus	1.0 - 7.1+	Discrete	Audio codec which allows for higher bitrates, 7.1 channels or more (currently limited by HD DVD, Blu-ray disc™ standards), while still remaining compatible with older 5.1 systems. The codec was designed based on Dolby Digital but provides the necessary versatility going into the future.
Dolby TrueHD	1.0 - 7.1+	Discrete	This is a true next-generation surround mode where the audio is bit-for-bit identical to the high-resolution studio master audio. Similarly to Dolby Digital Plus the track contains a 5.1 core for backwards compatibility.
DTS-HD Master Audio	5.1 - 7.1	Discrete	This is a bit-for-bit identical copy of the studio master track on your media, and therefore produces the best possible reproduction. Master Audio still contains the DTS core to remain backwards compatible with older DTS systems.
DTS-HD High Resolution Audio	5.1 - 7.1	Discrete	This is used when there is not enough space on the disc to hold the complete Master Audio track. Though not a bit-for-bit representation, High Resolution Audio provides increased bitrates while still providing the DTS core for backwards compatibility with older systems.

post-processing

The first thing the SSP-800 Surround Sound Processor does is recover the various channels delivered by your source with accuracy and fidelity. This might be a single-channel mono signal, a Dolby Digital Surround EX soundtrack with 6.1 channels, or anything in between. The signal may have been delivered via satellite receiver, cable set-top box, DVD, or even downloaded from the Internet.

Once the SSP-800 has decoded the selected signal, you can then choose to send it to the output unchanged, or you can add further processing, often called post-processing. This kind of processing is particularly useful for utilizing additional surround speakers with limited audio track sources. For instance, processing a 2-channel stereo source with Dolby Pro Logic IIx generates a 7.1-channel output so that you can enjoy the audio source in full surround sound.

Using the SSP-800

Your SSP-800's versatile touchscreen LCD supports most of your day-to-day operations and provides access to a flexible menu system for setup functions that aren't accessed as often as others. Although using the touchscreen is quite intuitive, the menu system is extensive. This section of the owner's manual outlines the use of this touchscreen in day-to-day operation of the system.

When you bring the SSP-800 out of its *Standby* mode, the touchscreen displays an "initializing" message and then switches to the Home page of the menu system, as shown below.

The **Home** page displays four options – **Source**, **Video Preview**, **Mode**, and **Controls** – on the top half of the screen. The bottom half of the screen displays the active input, surround processing mode, plus the current volume level (in both a graphical bar across the bottom of the screen and as a large numeric decibel value). This is the starting page for all of the day-to-day operations of the SSP-800 and can be quickly accessed at any time by pressing the **Home** button on the remote control.

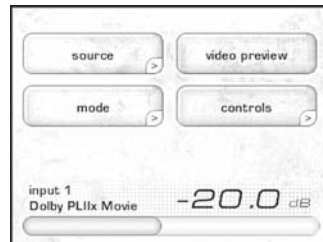

source selection

Touching the **Source** option opens the Source selection menu. The SSP-800 has a total of 20 selectable inputs, which are all interchangeable.

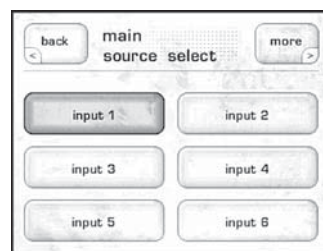

Touch any **input** button on the touchscreen to select it as the current input. If the input you want to activate is not on this screen, press the **More** button for the next page of input options. Or, press the **Back** button to return to the previous page.

Continue to press the **More** button to scroll through the available active inputs. When the screen with the last input is selected, the More button changes to a **Home** button.

If you don't have this many sources in your system, you can deactivate any unused inputs. When an input is deactivated, that input button is removed from the Source selection menu. This can be useful as it reduces the number of input options, making navigation and selection faster. See *The Menu System* for details on deactivating unused inputs.

mode selection

While you can specify default surround processing modes for each input, there are times when you may wish to select a different mode for a particular recording. For example, when watching a classic movie from the 1940s, you may prefer to hear it in mono using only the centre channel speaker.

Touch the **Mode** option on the Home page to open the Mode Select menu, which displays a complete list of processing modes. Modes that are grayed out cannot be applied to the current audio source. For instance, a mode designed for a stereo signal is not available while listening to a multi-channel Dolby Digital audio track.

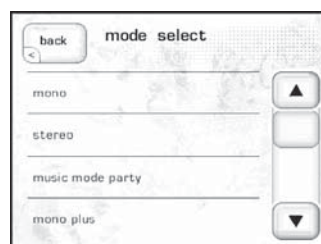

Touching the **up** or **down arrows** scrolls through the list of modes. Touch any mode (that isn't grayed out) to select it. The SSP-800 processing changes to the newly-selected mode. Press the **Back** button to return to the Home page. The available modes are described in Table 2.

Table 2: SSP-800 available surround processing modes

Name	Description
Mono	Outputs sound to the centre channel only. Use it for mono sources such as classic movies, mono TV broadcasts, etc.
Stereo	Outputs to the Front Left and Front Right channels only. This is the preferred mode for music reproduction.
Music Mode Party	Produces mono output at the same level from all available speakers.
Mono Plus	Uses the mono input to output mono signals on the L, R, SR, SL, and RR, RL if they are active.
Movie Plus	Produces stereo output in all available speakers. The output is proportioned with a 60% centre width and a 50/50 front-to-surround distribution. Approximately 15% of the total output is directed to the rear channels (if used).
Music Plus	Produces stereo output in all available speakers with a 25% centre width, a 70/30 front-to-surround distribution and 15% to the rear channels.
Dolby PLII	Provides audio signals for a 5-channel surround sound field from matrix-encoded stereo sources. Spatial qualities vary for non-encoded sources.
Dolby PLIIx Music	An extension of the Dolby Pro Logic mode, Dolby PLIIx expands existing stereo or 5.1-channel matrix-encoded audio signals for 6.1- or 7.1-channel discrete playback. The Music mode features three additional user controls: Centre Width (for adjusting balance to favor the Centre or Left and Right front channels), Panorama (for wrap-around surround effects), and Dimension (to adjust the depth of the surround sound field).

Dolby PLIIx Movie	The Movie mode routes the special effects signals to the surround channels for a fuller, dramatic impact while viewing movies and films.
Dolby PLIIx Matrix	The Matrix mode provides a sound field similar to the Music mode, but does not have the additional adjustment options.
Dolby PLIIx Game	The Game mode also routes the special effects signals to the surround channels.
DTS Neo:6	Expands existing stereo or 5.1-channel audio signals for playback with 6.1- or 7.1-channel systems. Use with matrix-encoded digital stereo sources.
DTS Neo:6 Cinema	The Cinema mode emphasizes front information and processes surround effects to reproduce a very diffuse rear sound field.
DTS Neo:6 Music	Use the Music mode when playing non-encoded stereo audio tracks. Also includes a Centre Width adjustment.
Discrete	Provides a “native” format mode where no processing is performed; the source signal is simply “passed-through” to the output. For example, when HD Audio codecs such as Dolby TrueHD and DTS-HD Master Audio are decoded in a Blu-ray player, they may be transferred as Discrete multi-channel LPCM signals to the SSP-800. <i>Note: In this mode, sound is sent to all active speakers with data in the soundtrack.</i>
DTS Neo:6 Cinema ES	Provides the DTS Neo:6 mode with the addition of discrete- or matrix-encoding to the surround back channels.
DTS Neo:6 Music ES	Provides the DTS Neo:6 mode with the addition of discrete- or matrix-encoding to the surround back channels.
Dolby Surround EX	Derives matrix-encoded rear channel audio signals from 5.1-channel audio signal sources. Only available for input sources flagged with Surround EX encoding.
Dolby Digital EX	A 7th channel of discrete information was recorded during filming and is encoded into the media. This extra channel of information is used to create a single rear centre, or two mono rear centres depending on the speaker setup (6.1 or 7.1).

video preview

The **Video Preview** option allows you to select and view the video source on the front panel touchscreen, so you see what is being output to the main display. This is useful in installations where the SSP-800 is located out of direct line-of-sight to the display. Only the currently active video input can be previewed.

Touch the **Preview** option from the Home page. The touchscreen now displays the selected video source. To return to the home page, simply touch the display again. If the current input has no video source assigned, touching the Preview option displays a message stating that the Preview option is unavailable for the selected input.

controls

Touching the **Controls** option opens a new menu, as shown below. The Controls page allows you to adjust a variety of processor functions, such as audio levels and delays, as well as selecting listening configurations.

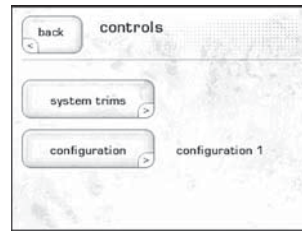

These adjustments are temporary; when a new input is selected, the adjustments are deleted and replaced with the saved values. If you want to recalibrate the audio levels because of an equipment change, use the *Speaker Setup* menu, not the Controls menu. Similarly, use the *Input Setup* menu to save a permanent change to an audio delay or configuration.

system trims

The **System Trims** menu controls several parameters of the SSP-800's operation that may occasionally need adjustment to suit a particular recording. Touching the System Trims option opens the System Trims menu page, as shown below.

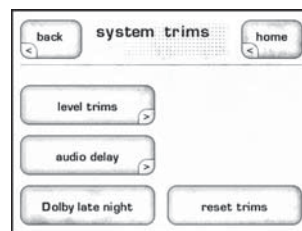

The available adjustments are:

- **level trims** - provides Left/Right Balance, Centre, Surround, Rear, Subwoofer, and Aux1/2 level adjustments. As an example, you might want to raise the level of the Centre channel speaker by 2 or 3 db if the dialog in a particular movie is difficult to understand. In addition to the normal subwoofer trims, two additional buttons (LFE 0dB, and LFE -10dB) offer an extra -10dB of trim. You may find certain older DTS Music discs with the LFE channel recorded 10dB higher than normal. The LFE -10dB button allows you to quickly adjust for this scenario.
- **audio delay** - provides an overall delay, called Lipsync, to adjust for cases where the timing of the video signal seems to trail the audio. You may run into this problem with the occasional DVD, due to inattentive mastering of the disc itself. If you find this problem most of the time, then adjust the delay setting for the input in the Setup menu. Remember that these are only temporary trims, so use this system trim only for the occasional adjustment needed for a specific disc.
- **Dolby late night** - this mode offers intelligent moderation of the dynamic range in Dolby Digital recordings. This is especially useful when you want to watch a movie in the evening, but are concerned about disturbing the neighbors or others in the household who might prefer to be sleeping during your action movie. This feature is specific to Dolby Digital soundtracks and is grayed out, or unavailable, when listening to other surround formats.
- **reset trims** - allows you to reset the system trims back to the values reflected in the Setup menu for that input. *NOTE: This is NOT a factory default command.*

configuration select

Touching the **Configuration** option opens the Configuration Select menu, which allows you to select the current configuration you want to activate.

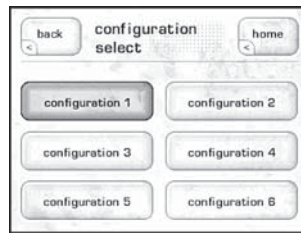

Configurations, which reflect the speaker setup of your system, are defined and may be renamed in the Setup Menu. The Configuration Selection menu allows you to choose from up to six different system configurations.

For example, you might use different configurations that you call stereo and movies for configuring the system for full-range two-channel versus multi-channel with subwoofer(s). Conveniently you may even use configurations to optimize levels and distances for different listening positions.

For more information regarding the Configuration setup, refer to the *Menu System* section.

The Menu System

The comprehensive menu system provides setup and configuration controls for the SSP-800 Surround Sound Processor. These installation-specific features let you customize how the SSP-800 works within the context of your particular system.

Pressing the **Menu** button on the front panel opens the main Menu page, which is divided into six sections as shown below. The menu screens are always shown on the front panel touchscreen and can also be viewed as an OSD (On Screen Display) on the main video display.

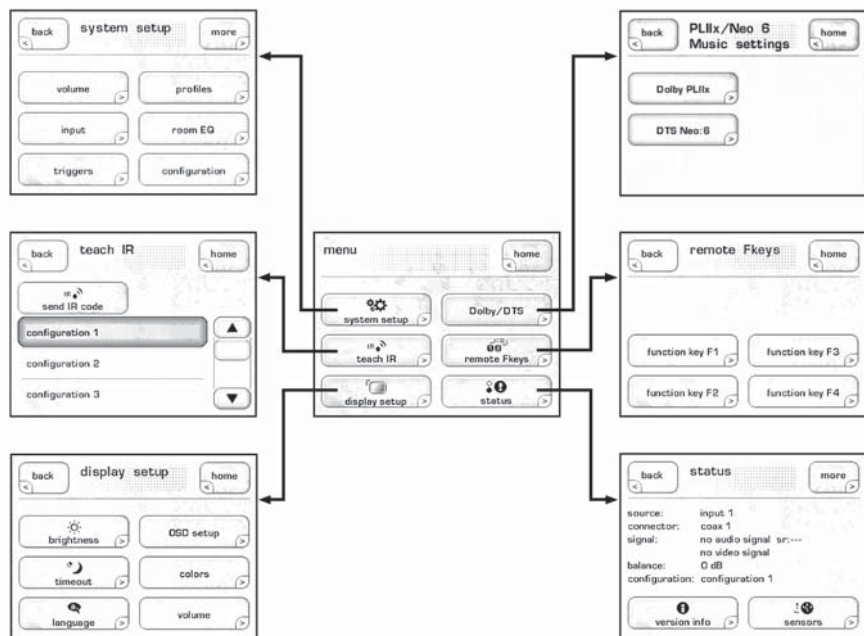

The button on the top right of the menu pages provides a “**More**” button, when additional menu options are available, or a **Home** button for returning to the Home page. Pressing the **Menu** button again either returns to the Home page, or returns to the Main Menu page, depending upon your location in the Menu system.

system setup

Touching the **System Setup** option from the main Menu page opens the System Setup page, which contains six setup options as shown below.

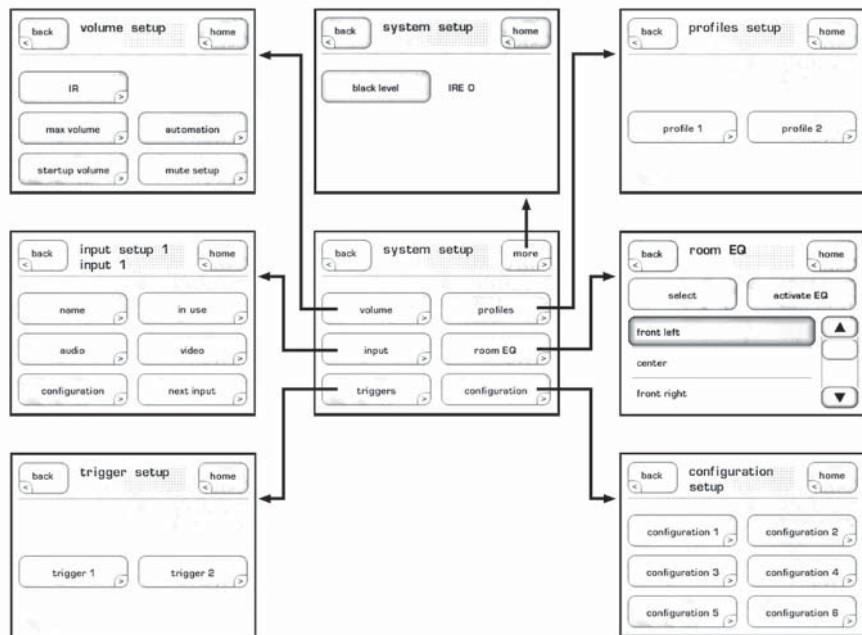

From the System Setup menu, you can:

- tailor your inputs to your particular source components
- configure and calibrate the system to take best advantage of your loudspeakers
- create shortcuts through the “profile function” to access your preferred or most frequently used functions
- program the behavior of the SSP-800’s DC triggers

volume setup

Touching the **Volume** option from the System Setup menu opens the Volume Setup page, as shown below.

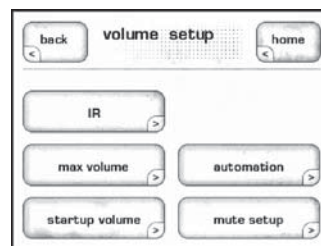

The options on this menu page allow you to:

- set a maximum volume level
- control the volume level of the system when it is turned on
- customize the behavior of the mute control
- adjust IR and automation volume command speeds

max volume

The Max Volume page allows you to establish a maximum volume setting for your system. This scale runs from 0 to 100, with 100 indicating that you do not want any artificial limit placed on the maximum gain your Surround Sound Processor can provide. This setting is interactive. You can set the value to something less than 100, and then adjust the volume to see whether it is appropriate.

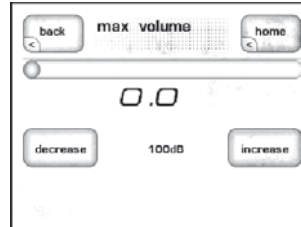

NOTE: The volume knob itself does not set the maximum volume; you must set the maximum volume level in this Max Volume setup menu.

startup volume

Touching the **Startup Volume** option allows you to set up a preferred volume level for when the SSP-800 wakes out of standby. This starting volume level can be configured in two ways:

- the **Last Volume** option sets the starting volume to the last level selected before the unit was powered down. The mute setting is also remembered.
- the **Specific** option allows you to set a specific volume level with the mute control on or off.

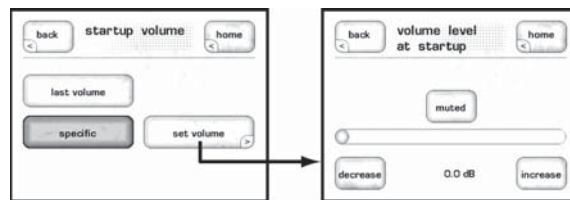

IR setup

Touching the **IR** option displays the IR volume speed setup page, shown below. Similar to the rotary knob setup, the IR volume speed controls the degree at which the volume is stepped through when the remote control volume button is pressed. Three settings are available – **Fast**, **Normal**, and **Slow**. The default setting is Normal.

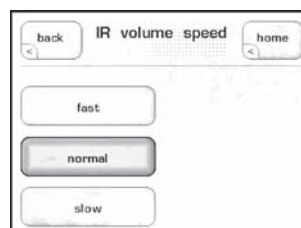

automation

Touching the Automation option displays the Automation volume speed setup page, shown below.

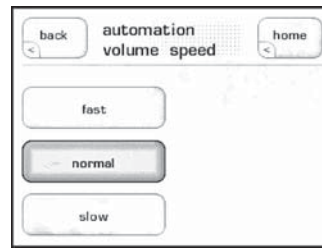

This volume control is specifically for use with automation control systems. Such control systems can vary in how quickly they repeat ramped volume commands. By first selecting a suitable volume control speed on the SSP-800 Surround Sound Processor, the programming required to tailor the speed from the control interface is simplified.

mute setup

The Mute Setup page allows you to choose how the **mute** button functions. The options for mute control are:

- **classic** - completely mutes all audio so that when the Mute button is pressed, no audio is heard.
- **specific** - allows you to select the exact value to which the volume is attenuated. If the current volume is already below that level when muting is engaged, the volume remains unchanged.
- **damping** - reduces the current listening level by a specified amount..

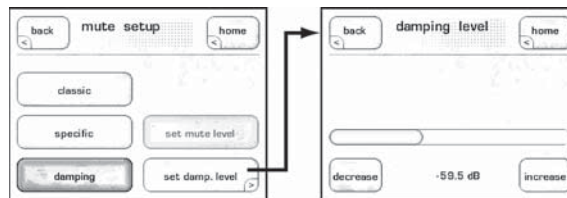

The **Specific** and **Damping** options are especially useful in situations where you still want to hear the audio source but need to reduce the volume level temporarily. For example, let's say you are watching a football game and the phone rings. You need to take the call but would still like to monitor the progress of the game. Pressing the **Mute** button, while it's set for specific and damping, provides a simple solution.

input setup

Each of the 20 inputs supported by your SSP-800 Surround Sound Processor can be customized in several ways to enhance system performance or to simplify controls. The Input Setup menu always opens to the setup page for Input 1. The menu contains six buttons that completely define each input – **Name**, **Audio**, **Configuration**, **In use**, **Video**, and **Next input**, as shown below. The same menu is used to set up each input:

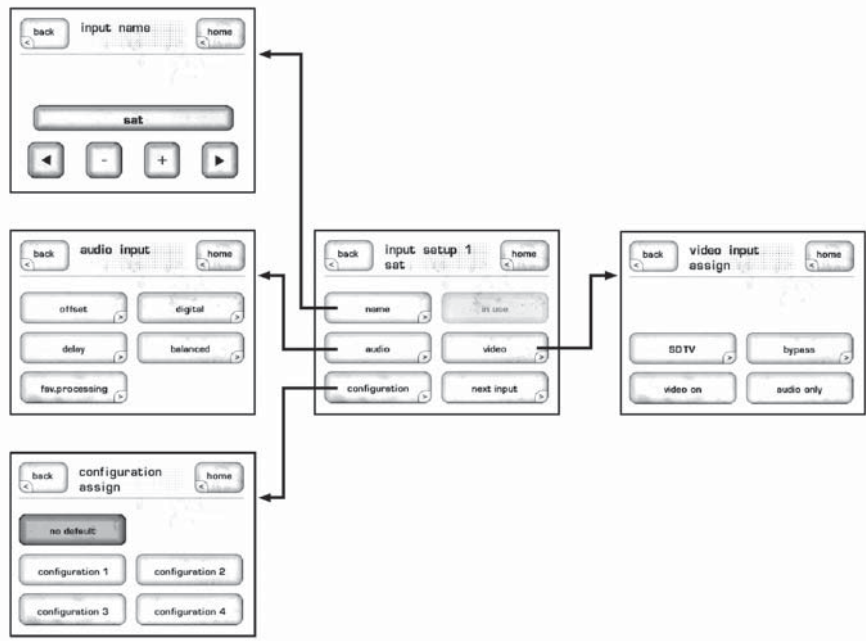

name

The **Name** button provides a way to customize the names of the inputs as displayed on the input selection screens. For example, if you have the Classé DVD transport connected to Input 6, you may want to rename the input to “CDT-300” to make it easier to remember. Each name can be up to 14 characters long.

To change an input name to something more specific to your system, use the four buttons along the bottom of the Input Name menu, shown in the Input Setup diagram above. The buttons provide the following functions:

- The **left arrow** button acts like the backspace key on a computer keyboard. Touch this button to delete characters by moving the cursor to the left.
- The **right arrow** button adds characters by moving the cursor to the right.
- The **+** and **-** buttons allow you to change the current character by scrolling through the available list of characters. This list includes all upper- and lower-case letters of the alphabet, the numbers 0 to 9, and a variety of punctuation.

When you've completed modifying the input name, touch the **Back** button to return to the Input Setup menu.

audio

The Audio Input menu allows you to select the offset, delay, and favorite processing settings, affecting how the audio from this input source is handled.

- **offset** is used to ensure that all analog source playback is at comparable levels. There can be significant differences in output levels among analog sources (this is not a problem with digital sources), which can lead to unexpected changes in volume when switching among multiple sources. The SSP-800 provides an offset adjustment range from -5 to +10 dB.
- **delay** introduces an audio delay to compensate for a delayed video signal. The delay is added to all channels and addresses the “lip sync” problems often found with modern digital televisions using sophisticated video processing.
NOTE: If you see a consistent “lip sync” problem with all materials played by this input source, then adjust the delay parameter to compensate for the issue. However, if you only notice problems with a few specific materials, then leave the input delay at its default value and make temporary adjustments to the System Trims menu, available from the Home page, while playing the problem source materials.
- **favorite processing** determines the default surround mode that the SSP-800 initially uses when it receives either a two channel (“stereo”) or a multi-channel signal from the selected input source. For example, you may want to use Dolby Pro Logic II Music as the default mode for stereo signals from your CD player, while preferring plain two-channel reproduction for the signal from your FM tuner. Touching either the 2-channel or the multi-channel buttons displays a list of the available surround processing modes for the chosen signal type, from which you may select your preferred default setting for this source.
- **connector** identifies which rear panel connection the input should use. Any of the rear panel audio inputs are assignable to any of the input setups.
- **bypass select** determines if the incoming analog signal is converted to digital format or left in an analog format. If the Bypass Select is NOT highlighted then the SSP-800 converts all of the incoming analog signals to digital for further processing. If you prefer to pass your signals through the SSP-800 unaltered, except for volume control, then touch the Bypass Select button to make it active. *NOTE: This option is automatically selected when the Connector parameter is set to 7.1-bypass.*

configuration

The **Configuration** button allows you to assign one of the six configuration options as the default for the input being set up. If you don't want a specific configuration assigned to this input, select the **No Default** option. In this case, the last used configuration is maintained when the input is selected. Configurations are speaker setups, and are discussed in more detail later in this section.

*NOTE: The default Configuration assignment can be temporarily overridden from the **controls** button on the Home page. See the section, Using the SSP-800, for more details.*

in use This button identifies active inputs. If the **In Use** button is highlighted, then the Input is active. If the In Use button is NOT highlighted, then the input is considered inactive and is removed from the source selection list.

Deselecting the **In Use** button for unused inputs is a good way to simplify source selection. The Source menu on the Home page only lists active inputs so, if the **In Use** button is NOT highlighted in the input setup menu, that input does NOT appear in the Source menu.

video The **Video** button should be used when setting up video sources. It opens the Input Video Connector menu which lists the available video connections on the rear panel, allowing you to identify which rear panel connection the input should use. Any of the rear panel video inputs are assignable to any of the input setups.

next input The Next Input button scrolls through the inputs from Input 1 to Input 20. So, once you've completed the Input 1 setup, click the Next Input button to access the Input 2 setup controls, and so on through Input 20.

*NOTE: The **Back** button returns to the previously viewed menu.*

triggers The SSP-800 has two available trigger controls. Each may be programmed to either "logic" (12V) or "inverse logic" (0V) settings. The ability to change the way the trigger operates can solve installation-specific problems that otherwise require external devices that add to both the cost and complexity of your system.

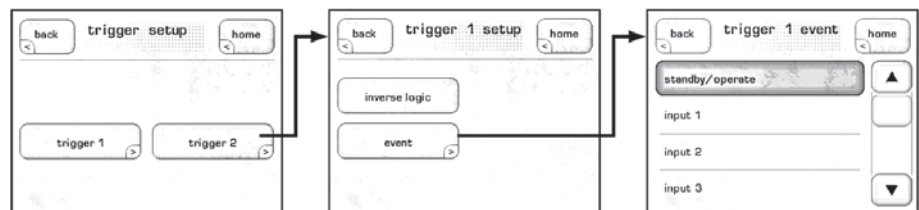

The Event button is used to assign the trigger activation to a specific event. The triggers can be associated with the Standby mode, a specific input, configuration, surround processing mode activation, or even a combination of these. To use the Inverse Logic option, simply highlight the Inverse Logic button on the Triggers setup page.

For more information on the use of DC triggers, we recommend you speak with your authorized Classé dealer.

profiles

A **Profile** allows you to create a number of shortcuts to various functions of your surround sound processor.

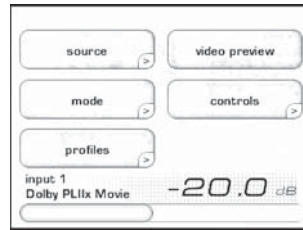

Two separate profiles can be customized with up to six commands each. Any defined profile has a named button available on the home page, as shown above.

NOTE: By default both profiles are inactive, therefore the profiles button does not appear on the home screen.

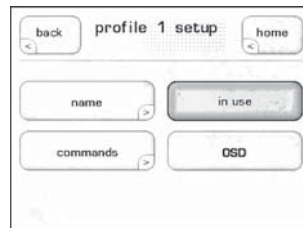

- To modify a profile name touch the **Name** button. A profile name can be up to 14 characters long.
- Touch the **Commands** button to select the functions that are displayed in the profile. Under Commands is a list of up to 6 command buttons. For each button, you may assign a function from the list of operations. Effectively you are creating a customized page of the operations you might use the most.
- Select the **OSD** button to show the profile control page on the video display when that profile is selected. Otherwise, selection of the profile commands is seen only on the front panel LCD.
- Select the **In Use** button to add this profile to the Home page menu.

Profiles give you the ability to directly access functions without having to remember how to navigate to their location in the menu structure. These are especially useful if you frequently find yourself navigating to the same set of commands.

room EQ

The SSP-800 Room EQ capability allows you to build very precise digital audio filters to help correct for fixed sonic irregularities in your room. These filters should be constructed based upon audio measurements made by a well-qualified acoustical engineer. These powerful filters are made available in a completely manual fashion to help your professional installer give you the best listening experience possible.

As many as five filters can be built for each speaker channel, except the Aux channels defined for Bi-Amp or downmix. A Bi-Amp channel assumes the same filters as defined for the Front Left and Right partner channels.

In order to define the Room EQ filters, select **Room EQ** from the Setup Menu. Choose which channel(s) you wish to adjust. Individually select and activate a band, then tune it with the appropriate centre frequency, Q, and gain. Once the appropriate number of bands have been activated and tuned, use the **Activate Group** button to turn the filters on and off as a before/after check on your progress for the channel.

You do not need to have filters defined for every channel. The installer need only make the adjustments to the channels necessary to correct for the room's interaction. *We encourage you to consult with your authorized Classé dealer to properly calibrate the SSP-800 Room EQ function.*

configuration

Your SSP-800 has default settings for each speaker, but these settings should be adjusted to match your system for optimal results. You may want to consult your authorized Classé dealer to precisely adjust the settings to match your room environment. On your own, you can identify each speaker's distance from your seating position, but it's difficult to make speaker level corrections by ear. Your dealer's technician uses an SPL meter or specialized room measurement software to optimize levels and adjust speaker equalization, a powerful tool to help optimize your room's interaction with your speakers.

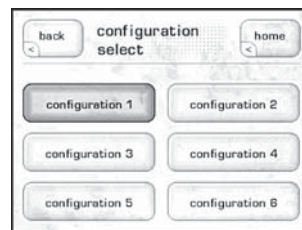

The **Configuration** Setup menu allows you to define up to six different speaker configurations. Touch the button for the specific configuration you want to set up to open the configuration setup menu, shown on the right. The menu contains four buttons that completely define the configuration – **Name**, **Distance**, **Levels**, and **Speakers** – plus a fifth button that activates the configuration. The same menu is used to set up each configuration.

name The **Name** button provides a way to customize the names of the speaker configurations. Each name can be up to 14 characters long.

To change a configuration name to something more specific to your system, use the four buttons along the bottom of the Configuration Name menu. The buttons provide the following functions:

- The **left arrow button** acts like the backspace key on a computer keyboard. Touch this button to delete characters by moving the cursor to the left.
- The **right arrow button** adds characters by moving the cursor to the right.
- The **+** and **-** buttons allow you to change the current character by scrolling through the available list of characters. This list includes all upper- and lower-case letters of the alphabet, the numbers 0 to 9, and a variety of punctuation.

When you've completed modifying the configuration name, touch the **Back** button to return to the Configuration Setup menu.

distances The **Distances** setup page allows you to adjust the speaker distances to accurately reflect the actual placement of your speakers. Touch the speaker location you wish to adjust and then measure the distance between each speaker and the primary listening place with a tape measure or equivalent. You can then enter the resulting distance value into the menu by touching the **decrease** or **increase** buttons, shown below.

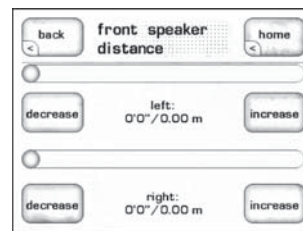

NOTE: You may find that some speaker options are not available for selection. Those speakers do not currently exist in that specific configuration. The speaker selections for each configuration are made on the Speakers page, which will be discussed in the sections which follow.

levels

The **Levels** menu allows you to adjust the output levels of the speakers. An SPL meter should be used from the primary seating position to ensure that each speaker delivers the same sound pressure from a given test noise audio signal. Touch the Noise Seq button to activate the noise generator; the top of the menu now states “Levels Noise: L” – indicating that the test noise is being generated on the front left speaker. The test noise automatically moves to each of the available speakers, as indicated by the menu title, and continues to rotate around the room until the **Noise Seq** button is touched again.

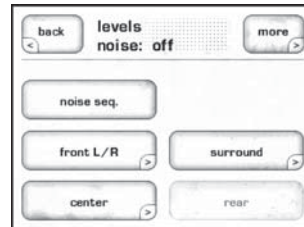

NOTE: You may find that some speaker options are not available for selection. Those speakers do not currently exist in that specific configuration. The speaker selections for each configuration are made on the Speakers page, which hasn't been discussed yet.

To modify the actual levels, touch the speaker you want to update and then adjust the level using the **increase** and **decrease** buttons. Set the SPL meter to “C” weighting and Slow response. Each speaker level should be adjusted until the SPL meter reads 75dB at your main listening position.

in use

This button identifies active configuration. If the **In Use** button is highlighted, then the Configuration is active. If the **In Use** button is NOT highlighted, then the configuration is considered inactive and is not available for selection in the Input Setup menu or in the Home page Control section.

speakers

The Speakers configuration page identifies which speakers are active for each configuration, as well as the crossover level for each speaker. The Auxiliary channels can also be configured through this menu.

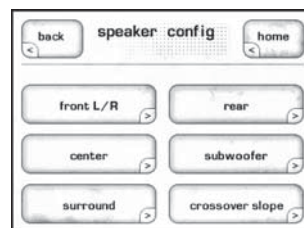

First, touch the **Speaker Config** button to set up the 7.1-channel speaker configurations. Then we will discuss the Auxiliary channel setups.

Each speaker opens the same menu with two buttons – **size** and **crossover**. To modify the crossover for the selected speaker, touch the **Crossover** button and then adjust the setting using the **increase** and **decrease** buttons. The **crossover setting** applies a high pass filter to the speakers set on crossed over, and a low pass filter to route bass information to the sub (if enabled). When the speaker is set to **large**, and **e-bass** is enabled the **crossover** determines which low frequencies will simultaneously get routed to the sub(s).

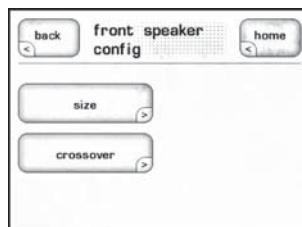

The **Size** option allows you to pick either **Full Range** or **Crossed Over** for each speaker. The **None** option is available on the surround, center, or rears. Selecting None disables the channel(s) output. If None is highlighted then that speaker location is not available for selection in other menus.

NOTE: You cannot disable the Front L/R. If you disable the surround speakers, then the rear speakers are not available for selection.

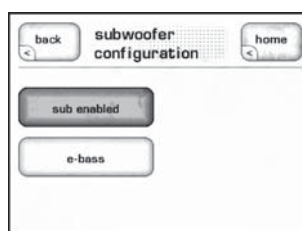

The Subwoofer configuration page, shown above, has two buttons available – **Sub Enabled** and **e-bass**. If the Sub Enabled button is highlighted, then the configuration includes an active subwoofer and the LFE (Low Frequency Effects) information is routed to it as well as any low pass energy from the crossed over channels. If you do not enable a subwoofer for the system, then the LFE information will be routed to any full range speakers in the configuration. When a subwoofer is enabled and the e-bass option selected, the low frequency signals from all speakers (both crossed and full range) are passed to the subwoofer along with the LFE (if available from a discrete stream). This effectively duplicates the bass energy present in full range speakers.

NOTE: If the Sub is not enabled e-bass will be grayed out and not selectable as the LFE is already being distributed to any full range speakers available.

The **Crossover Slope** button enables you to select the preferred crossover slope, either 12dB/octave or a steeper 24dB/octave. Touch the desired value so that it is highlighted.

auxiliary channels

Now that the main speakers have been configured, we'll discuss the Auxiliary Channel configurations. On the Speaker setup page, touch the **Aux Channels** button to open the Auxiliary Channels menu. The SSP-800 has two auxiliary channels that can be utilized as additional subwoofers, assigned as a 2-channel down-mix of a selected multichannel signal, or configured to bi-amped left and right audio.

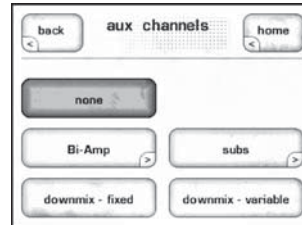

Alternatively, touch the **None** option to disable the auxiliary channels and leave them unused.

Touch the **Subs** button to configure the auxiliary channels as additional subwoofers. Touch the **Mono2** or **Mono3** buttons to put two or three mono subwoofers in your sound system. In this configuration all subwoofers are receiving identical signals. Touch the **Stereo LR** or **Stereo LCR** buttons to make the subwoofers stereo Left and Right channels, or stereo Left, Centre, and Right channels, respectively. Please refer to the table below to determine which rear panel outputs are associated with a particular channel. To avoid inundating the room with bass by adding a second subwoofer (or third), this does not simply double or triple the bass energy in the room. The total bass energy is properly distributed among the subwoofers defined in the system.

Output Connector	LR configuration	LCR configuration
S	L Sub	L Sub
Aux 1	R Sub	R Sub
Aux 2	X	C Sub

Use the **Downmix-fixed** or **Downmix-variable** options to provide a two-channel down-mix of the selected multichannel signal, which then follows the Main Front Left and Right speakers. The Downmix-fixed option sends the stereo output with a fixed volume level. The Downmix-variable option sends the stereo output with a variable volume control that duplicates the main volume settings. The Downmix option is very useful in situations where you want to monitor the main zone audio from another room. For instance, if you are watching the football game and need to leave to make dinner, you can feed the down-mixed audio to the kitchen and keep up with the game while you cook.

Touch the **Bi-Amp** button to configure the auxiliary channels for a bi-amplification mode, where a single speaker is driven by a stereo, or two mono, amplifiers. In this mode, the two auxiliary channels exactly follow the Front Left and Right channels. To use the bi-amplification option, the Bi-Amp button on the Aux Bi-Amp page must be highlighted. This page also provides the level offset controls. Use the **increase** and **decrease** buttons to adjust the offset level.

NOTE: For a Bi-Amp system, the Speaker Level adjustments for the left and right channels also simultaneously affect the Aux Left and Right, since the Bi-Amp channels now operate in tandem.

black level

The **more** button on the System Setup screen accesses the Black Level setting. The “video setup” in North America assumes that black is reproduced at a video level of 7.5 IRE units, while most of the rest of the world assumes that video black is represented by a video level of 0 IRE units. The SSP-800 can operate either way; you should pick the standard common to your area for compatibility with the rest of your video sources.

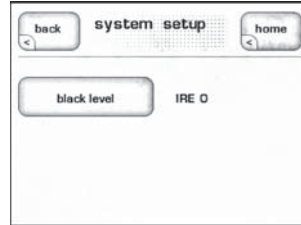

teach IR

The complete list of SSP-800 discrete infrared (IR) command codes extends far beyond what is practical for handheld remote controls. However, many of these functions are critical if you plan to create a customized remote control with macros that take command of your entire system. Without these discrete codes, many of the macros you might want to create simply won't work reliably.

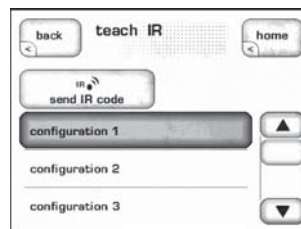

The Teach IR page displays a scrolling list of all the available IR codes in the SSP-800 Surround Sound Processor. Simply scroll to the command you want your macro-capable remote to learn and touch the **Send IR Code** button. The SSP-800 continuously sends the appropriate command code via the front panel - as long as the button is pressed – until your third-party remote control has learned it.

For more information on control systems, we recommend you speak with your authorized Classé dealer.

display setup

The Display Setup menu page, shown below, allows you to configure the brightness, display timeout, and language used in the front panel and menu system. It also determines the format and color of the OSD (on-screen display), and how volume settings are displayed on your system.

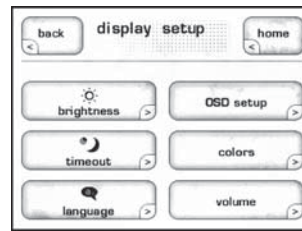

brightness

The **Brightness** setting of the SSP-800 front panel touchscreen has three possible values: *low*, *medium*, and *high*. Select the appropriate setting based on the level of ambient light typically found in your listening room while using the system. A *high* brightness setting usually works best in brightly-lit rooms; you may find that a lower setting is less visually intrusive under more subdued lighting conditions.

timeout

If you prefer listening to music in a dimly-lit or darkened room, you may find even the *low* brightness setting of the display somewhat distracting. You can essentially turn off the touchscreen by reducing the **timeout** value of the backlighting so as to turn it off entirely after a period of inactivity you select. In this context, activity refers to any use of the user interface. This includes hard buttons, the LCD touchscreen, and the remote control.

For example, if you reduce the timeout to its minimum setting, the backlighting illuminates the display as soon as you interact with any of the SSP-800 controls, and remains lit for only three seconds – just long enough for you to check a setting. If you continue to use any of the controls (at least once every three seconds), the display remains lit. After three seconds of inactivity on your part, the backlight extinguishes itself, essentially turning off the touchscreen. Or, if you prefer to have the active source preview, instead of a black screen, you can select the timeout value of the touchscreen and then highlight video on timeout. When the touchscreen timeout value is reached, the active video source is shown on the touchscreen.

If you prefer the display of the SSP-800 to remain on whenever not in *Standby* mode, select the **Never** option. The lamp in the touchscreen display is designed for harsh automotive environments and will give you many years of reliable operation. If you plan to leave the unit on continuously, however, we recommend that you keep the timeout delay set to less than one minute.

NOTE: setting the brightness to a lower setting does not increase the life of the lamp.

language The **Language** menu offers a choice between six different languages supported by the SSP-800. The language selected is then used for all touchscreen and menu system text. Classé has also provided our international distributors with a software tool that makes it possible for them to customize the translations to suit their local customs and terminology. This allows us to be sure operation of the SSP-800 is just as intuitive in countries other than its birthplace, Canada.

OSD (on screen display) The SSP-800 can report changes to its status via the On Screen Display. Selecting **Duration** from the OSD menu allows you to define the amount of time events are displayed, up to a maximum of 5 seconds. The **Events** screen allows you to select which individual events you want displayed. To make your selection, scroll through the list using the **arrow** keys on the right of the screen, then highlight the desired events. The default is for all events in the list to generate an OSD message.

colors The **Colors** menu page gives you the ability to customize the color of the OSD and touchscreen. Besides the default blue, the screen may be shown in silver, red, or green. If a different color is chosen, the change takes place immediately so you can view the colors before leaving the menu page.

volume There are two common ways of displaying the volume information in a multi-channel system: **absolute** and **relative**.

The **absolute** system refers to the notion that most people think of the number 0 as meaning nothing, e.g., no sound at all. In this system, 0 means “sound off” and larger numbers indicate high volumes. While this method is intuitive, there’s really no reference for how loud a particular setting is except through prior experience.

In the **relative** system, there is a calibrated, reference volume referred to as 0dB. This reference volume is the same level at which movies are played in theaters. Regardless of how large or how small the theater, a setting of 0dB is always the same, known volume. Changes from that volume level are shown as either positive (louder) or negative (quieter). People who have spent any time making recordings will recognize that this is similar to the notion of 0dB on a record level meter.

In any event, the SSP-800 offers both systems so that you may choose what makes the most sense to you personally.

Dolby/DTS

The SSP-800 incorporates both Dolby Pro Logic II and DTS Neo:6 technologies for converting a two-channel signal into an enjoyable multi-channel listening experience. The **Dolby/DTS Setup** menu allows you to modify the Dolby PLIIx Music or DTS Neo:6 Music processing settings to best suit your personal preferences.

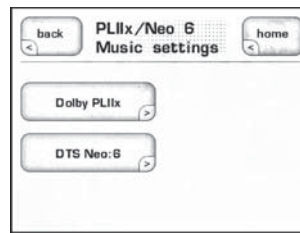

While they differ in the details of their implementation and in the subjective result, on a conceptual level they do the same thing: they analyze the information embedded in two-channel recordings, looking for clues that can indicate how the sound in those recordings might best be redistributed to the various speakers in a multi-channel system, simulating a discrete multi-channel recording.

Dolby Pro Logic IIx

Dolby Pro Logic IIx Music mode has three user-adjustable parameters:

- **Panorama** presents a wider, deeper front soundstage. The effect is somewhat signal-dependant, meaning that it is more pronounced with some recordings and less so with others. With a good recording, however, the effect can be quite dramatic. Panorama is active when the button is highlighted.
- **Centre Width** determines how much of the centre-channel information is allowed to remain in the left and right speakers. A low setting places all of the information that creates a phantom centre image in a normal stereo system into the centre channel speaker instead (*sometimes referred to as a "hard" centre channel*). A high setting leaves this information in the left and right speakers, fading out the centre channel speaker. Intermediate settings provide a great compromise between the seamless spaciousness of a great stereo system and the wide listening area of a multi-channel system, where you don't need to be in the "sweet spot" to hear a centre image.
- **Dimension** shifts the overall balance of the processing towards the back of the room. In very "dry" recordings lacking recorded ambience, a higher dimension setting helps to restore a sense of space to the reproduced sound. In extremely "wet" recordings with lots of ambience, you may want to reduce the dimension setting to avoid excessive or distracting spaciousness.

DTS Neo:6

By contrast, the DTS Neo:6 setting couldn't be simpler. The only user-adjustable parameter for DTS Neo:6 Music mode and ES Music mode is the centre width control. It functions in a similar manner to the centre width control for Dolby Pro Logic IIx.

remote Fkeys

The remote control supplied with the SSP-800 has four **function** keys (**Fkeys**), each of which gives you instant access to a specific system function that might otherwise be buried in the menu system.

For example, if you use the balance control frequently, you may want to consider programming one of the **Fkeys** to directly access the balance control. By saving the **balance control** as an Fkey function, you do not need to access the menus to change the parameter..

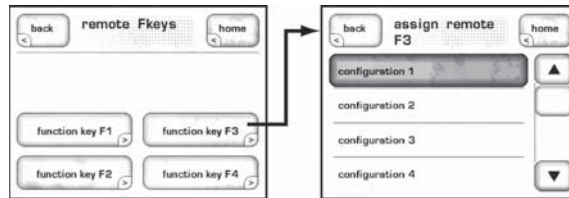

The remote control **F1** to **F4** buttons correspond to the Function Keys displayed on the touchscreen. Select the **Function Key** that you would like to program, Then to select the one you want simply scroll through the list (by touching either the up or down arrows on the right), and then touch the specific function you want that **Fkey** to perform.

important note on Fkey use

All Classé remote controls provide these same four **Fkeys**, so that you need not worry about which remote you happen to pick up. Thus **F1** on the Surround Sound Processor's remote control sends the same infrared signal as **F1** on the CD player's remote control.

While this is intended to minimize confusion amongst different remotes (since this aspect of them will all perform identically), you should take care when assigning different functions on different components to the same **Fkey**. Doing so can result in two components doing two different things at once, in response to a single press of a button on the remote control. This can sometimes be useful. As an example, **F1** could set the Surround Sound Processor to the **CD** input, and also set the CD player to **Play**, both from the press of a single Fkey.

status The Status screen provides several items of information on the currently playing disc, as well as access to information on the software used in and the internal sensors of the SSP-800. While on this page, pressing the **more** key will access the **CAN-Bus** features.

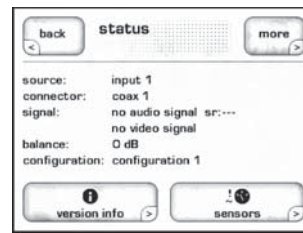

version info The **version info** button on the status screen takes you to the Version Information screen, which displays information on various pieces of software used by your SSP-800. If you ever have occasion to call our technical support people to ask a question not covered in this manual, they may want to know precisely what version of software your unit is running. Having this information available will help enable them to give you the best possible service.

sensors The **sensors** button on the status screen takes you to the Sensors screen, which displays information about several internal sensors within the SSP-800. It is unlikely you might ever need the sensor information, unless directed to do so by a customer service representative at Classé in order to help troubleshoot some unexpected problem.

CAN-Bus Classé's Controller Area Network, or CAN-Bus, opens the way to a new level of interaction between our Delta range of amplifiers, preamps, processors and source components. When the SSP-800 is connected with CAN-Bus, the different elements of a Delta series system are in constant communication, creating a "global" network that delivers system wide status information and shared operational features, all through the touchscreen display.

features CAN-Bus will allow a single Delta series touchscreen to:

- Display status information for every connected unit, including amplifiers which do not have a touchscreen display.
- Create a "PlayLink" that allows an SSP or Preamp to automatically switch to the correct input when a Delta series source component starts playback.
- Adjust the global system brightness.
- Configure the entire system to go in and out of standby at the touch of a button and also bring individual components in and out of standby.
- Mute any connected unit.

1 Classé Delta Series Products

Two or more Classé Delta series products are required, at least one of which must have a touchscreen display.

2 Category 5 Network Cables

These are ordinary network cables, commonly used for broadband Internet connections. They should be typical “straight through” cables not the “crossed over” type, and the total required will be one less than the total number of Delta series components in your system.

3 CAN-Bus Terminator

At minimum, a single CAN-Bus Terminator will be required. It is inserted into the CAN-Bus OUT connector of the last component in the CAN-Bus daisy chain. One is included in the box with your SSP-800. They are also available free of charge from your nearest Classé Customer Support Centre <http://www.Classeaudio.com/support/service.htm>

4 SSP-300 & 600 CAN-Bus Interface Box

Systems that include an SSP-600 or SSP-300 will also require an SSP-300/600 CAN-Bus Interface Box. These are included with the products or available free of charge from your nearest Classé Customer Support Centre <http://www.Classeaudio.com/support/service.htm>

The diagrams below illustrate how to connect the CAN-Bus hardware.

*Any combination of models in any order **without** SSP-300 or SSP-600.*

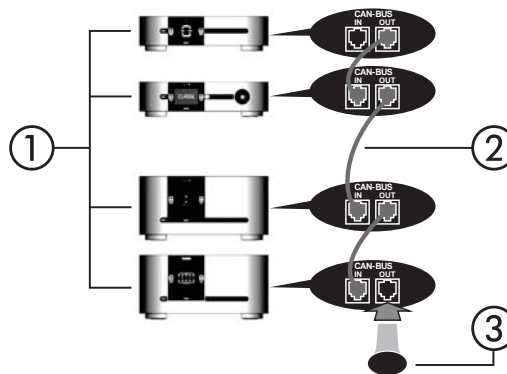

*Any combination of models in any order **with** SSP-300 or SSP-600.*

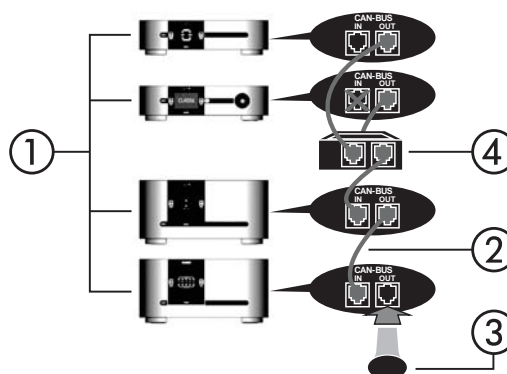

NOTE: Daisy chain must be terminated with CAN-Bus Terminator.

using CAN-Bus

CAN-Bus is controlled via the touchscreen of any Delta series component. There is no master component, so Delta series systems where two or more units have a touchscreen can be controlled through any of the touchscreens. However, it is probably easiest to start using CAN-Bus through just one.

CAN-Bus is accessed by pressing the **menu** button on the face of the unit or remote, then the **status** button, followed by the **more** button.

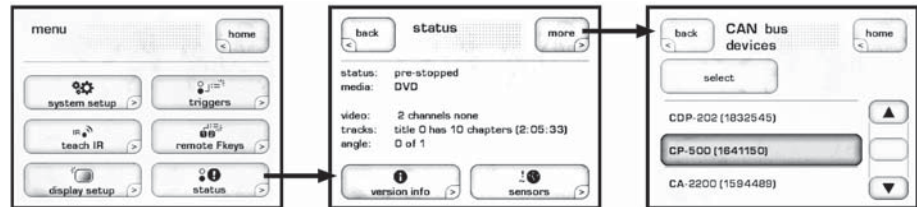

The touchscreen will then display the **CAN-Bus devices** screen, which lists connected Delta series components by model & serial number.

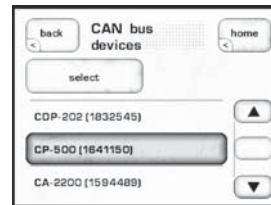

Highlighting a unit on the CAN-Bus devices screen identifies it as the **target unit**. The front panel LEDs of the target unit will start flashing (unless you highlight the unit that you are using to access CAN-Bus).

Once you have chosen the target unit press **select**. The target unit's LEDs will stop flashing and the touch screen will list the CAN-Bus features available to it. Some CAN-Bus features are shared by all models, some are specific to individual models.

CAN-Bus shared features

The following CAN-Bus features are shared by all models.

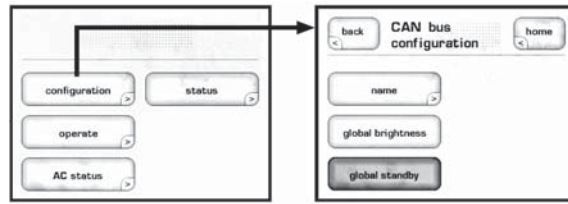

configuration

Selecting **configuration** will present the **CAN-Bus configuration** screen allowing access to name, global brightness, and global standby features..

- **name** enables you to set the name that this component will be listed under in the CAN-Bus devices screen. The name will appear next to the unit model and serial number, and facilitate the identification of units in large systems.
- **global brightness** enables you to adjust the touchscreen and LED brightness of all the components in your system by changing the brightness of a single touchscreen. All CAN-Bus software updates automatically set the updated unit to global brightness. If you want a particular unit to be excluded from global brightness, deselect global brightness for that unit.
- **global standby** enables you to bring your entire system in and out of standby by pressing the standby button of any unit or remote. All CAN-Bus software updates automatically set the updated unit to global standby. If you want a particular unit to be excluded from global standby, deselect global standby for that unit.

operate

The **operate** settings allow you to bring the target unit in and out of standby, or mute. This key will be disabled for the unit whose touchscreen you are using to access CAN-Bus.

AC status

The **AC status** screen displays information from the target unit's electrical supply sensors. Two screens are available, with the second accessed by selecting **more**.

status

The **status** screen is the simplest way to access essential information about the target unit. It displays the target unit's model number, software version, operational status and serial number.

CAN-Bus model specific features

The following CAN-Bus features are model specific.

PlayLink

This feature is exclusive to Delta series disc players and will only function if the disc player is connected to a CAN-Bus enabled preamp or surround sound processor.

When **PlayLink** is active, pressing **play** on the disc player will also automatically switch the preamp/processor to a specified input. This means that you can listen to a CD or watch a DVD literally at the touch of a button.

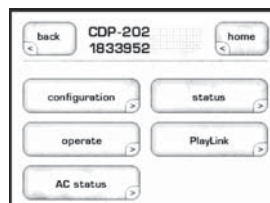

The first step in using PlayLink is to choose the **input** you wish to be selected when play is pressed on the disc player. Press the **PlayLink** icon, then select the correct input from the list.

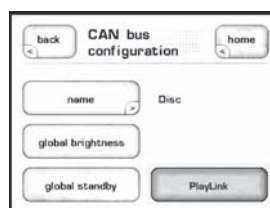

Once you have selected the input press **back**, then select **configuration**. PlayLink is activated and disabled through the PlayLink icon on the CAN-Bus configuration screen.

PlayLink is automatically active after a software update, and the PlayLink icon will only appear on the CAN-Bus configuration screen of a Delta series disc player.

PlayLink can only select a single input per disc player. It is therefore not designed for users who regularly play both CDs and DVDs through different inputs from a single disc player. When PlayLink is active the disc player will default to the same input every time play is pressed, regardless of whether it is playing CD or DVD.

amp info

Available for amplifiers only, this screen displays the data provided by the heatsink and AC Module temperature sensors.

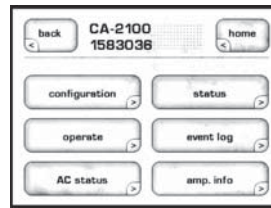

NOTE: This feature is only accessible when the target amplifier is on.

event log

Reserved for amplifiers, this feature is a protection circuitry **event log** which can only be accessed when the target amplifier is in **standby**. The protection circuit shuts down the amplifier or channel if it overheats or if its output could damage your speakers. The event log details the circumstances surrounding the amp going into protection and should be referred to in situations that require the intervention of your dealer or Classé customer support.

The log can report the following events interpreted as follows:

- **+ve slow blo trip & -ve slow blo trip** — The average current has reached the safe operating limit.
- **+ve fast blo trip & -ve fast blo trip** — The peak current has reached the safe operating limit.
- **over temperature trip** — The unit temperature has reached the safe operating limit.
- **DC protection trip** — The DC output level has reached the safe operating limit.
- **Communication failure** — There has been a loss of communication between the amp's system monitoring sensors.
- **AC line trip** — The power supply has reached the limits of the amp's safe operating range.

These events are rare and generally occur due to issues that are external to the amp. They should be interpreted positively. The amp is doing what it's designed to do.

Troubleshooting

Always refer any service problems to your Classé dealer. However, if you run into a problem, we recommend referring to this section first as sometimes an error is not a malfunctioning product, but simply an oversight in the proper setup of the component. This section provides suggested solutions to potential problems.

If none of these solutions work, please consult your Classé dealer for assistance.

There are no user-serviceable parts inside the Surround Sound Processor.



Important!

Verify that the power amplifier(s) connected to the SSP-800 is powered off before checking any cable connections and before power cycling the Surround Sound Processor.

1 Everything appears to be powered on, but there is no sound.

- ✓ Adjust the volume control to a moderate level - audible but not excessive.
- ✓ Make sure that the selected source component is powered on, not in Standby mode, playing an audio track, and not in pause mode.
- ✓ Ensure that the proper input has been selected for the current source.
- ✓ Verify that the Mute control is NOT active.
- ✓ Ensure that the amplifier is powered up and not in *Standby* mode.
- ✓ Check the *Menu* -> *System Status* information to verify an audio signal is being received.
- ✓ Verify that all cables are securely connected to the proper inputs and outputs, with no kinks or stress points.

2 There is no sound and the Standby LED is not lit.

- ✓ Ensure that the SSP-800 is properly connected to the electrical outlet - the AC cord is positioned firmly in the AC mains receptacle in the rear panel and the power switch is in the **On** position.
- ✓ Verify that the power from the electrical outlet is within 15% of its specified line voltage. If the power fluctuates outside of this range, then the SSP-800 has switched to protection mode, which requires a power cycle to reset the Surround Sound Processor to its normal operating mode.
- ✓ If the SSP-800 is properly plugged in and the power from the electrical outlet is at the proper level, try the following: Put the SSP-800 in *Standby* mode, switch off the main power switch on the rear panel, and unplug the Surround Sound Processor for at least thirty seconds. Then plug the cord back in and trying powering up again. Sometimes, a brown-out (short-term power loss) can activate the protection mode, which requires a power cycle to reset the SSP-800 to its normal operating mode.
- ✓ Remove the AC cord from the unit, and open the fuse holder immediately above the AC cord inlet. If the fuse is blown, contact your qualified Classé dealer immediately.

- 3 **Only one speaker seems to be playing.**
 - ✓ If the problem occurs with all inputs, check the interconnecting cables between the preamp and the power amp. Also check the speaker wires for secure connections.
 - ✓ If the problem occurs with only one input, check the input balance control setting of that input: select the problem input, then access the input balance control by touching **Controls** from the Home page of the front panel touchscreen, then select *System Trims* -> *Level Trims*, and then verify the balance control for the speakers. Check the speakers are active on the configuration assigned to this input.
 - ✓ Check that the speakers are active on the configuration assigned to this input.
 - ✓ Check the interconnect cables between the source component and the SSP-800.
- 4 **The IR remote control does not seem to function.**
 - ✓ Ensure that there are no obstacles between the IR remote and the IR sensor, located to the right of the **Mute** button.
 - ✓ Replace the batteries in the remote control.
- 5 **There is a hum coming out of the speakers.**
 - ✓ If you are using single-ended interconnects, make sure they are not placed alongside any AC power cords. Also make sure that they are not too long – long single-ended interconnecting cables have a natural tendency to pick up noise even when shielded.
 - ✓ If any source components are connected to cable TV, try disconnecting the cable television line from the source component. If the hum goes away, you need an isolation device between your cable TV converter and the source component. Your Classé dealer can help you obtain one of these inexpensive devices.
- 6 **There is a hum coming from the SSP-800.**
 - ✓ This symptom suggests that there are a lot of DC offset or other artifacts on your AC mains line. Try connecting to another AC circuit – not merely a different plug, but a completely different outlet.
 - ✓ Check to see if you have any halogen lighting or dimmers on the same AC circuit as the SSP-800 as they can cause the power supply transformers to hum.
- 7 **If there is no video or bad video displayed on an output device.**
 - ✓ Check the *Menu* -> *Status* information on the front panel touchscreen to verify the status of the incoming video. If no video signal is present, recheck the listed video input connection and the video source.
 - ✓ If a valid video signal is present, press the **Preview** button on the Home page. The preview should show the incoming video signal. If the touchscreen is blank, verify the incoming source is in fact transmitting the desired video program.
 - ✓ If the preview image has improper colors from a component source, either the component source is transmitting an RGB signal (unsupported) or the Pr and Pb wires are crossed.

- ✓ If there is a preview image but no output image, check the display connection. Ensure the YPrPb cables are properly connected if using a component video TV. Some display devices may not display the source's output resolution (for example, component 720p going into a standard definition display or an HDMI source which is preset to an unsupported resolution for a particular HDMI display).
- ✓ If the preview image looks good but the colors are wrong on the component video display then check that the component cables are properly connected. *NOTE: Only a non-copy protected YCrCb HDMI source can be viewed on a component display. Other types of HDMI sources show either no picture or improper colors.*

8 Voltage Protection Circuit

When the SSP-800 is connected to AC power, the AC input enters the component through a **Voltage Sensing Circuit**, which checks the voltage level every 25 milliseconds. Power can only reach the component once it has passed the Voltage Sensing Circuit. The circuit verifies that the power is within tolerable operating levels:

- ✓ of $\pm 10\%$ of its AC line voltage setting.
- ✓ between $\pm 11\%$ and 15% of its AC line voltage setting.

The following behavior of the SSP-800 is the result of the Voltage Sensing Circuit:

- ✓ If the external voltage is within the performance range, the product functions normally.
- ✓ If the external voltage enters the range of the safe operating limit, the standby LED flashes every half-second but the product otherwise continues to function normally.
- ✓ If the external voltage exceeds the safe operating limit for 10 consecutive seconds, the protection circuitry engages and an error message appears on the touchscreen.
- ✓ If the external voltage falls below its performance range, the standby LED flashes indefinitely every half-second until the voltage is insufficient to sustain normal operation.
- ✓ You have to cycle power to reset the protection circuitry. If you attempt to reset the SSP-800 while the external power supply remains outside the safe operating limit, the protection circuit re-engages, putting the SSP-800 back into *Standby* mode. We therefore recommend that you wait until the standby LED stops flashing before cycling power and resetting the protection circuitry.

Care & Maintenance

To remove dust from the cabinet of your Surround Sound Processor, use a feather duster or a lint-free soft cloth. To remove dirt and fingerprints, we recommend isopropyl alcohol and a soft cloth.

Dampen the cloth with alcohol first and then lightly clean the surface of the Surround Sound Processor with the cloth. Do not use excessive amounts of alcohol that might drip off the cloth and into the Surround Sound Processor.



Caution!

Power down and remove the AC power cord from the SSP-800 before performing maintenance. At no time should liquid cleaners be applied directly to the Surround Sound Processor, as direct application of liquids may result in damage to electronic components within the unit.

input factory defaults

For your convenience, here are the factory default settings for the SSP-800 Surround Sound Processor.

Input #	Default Audio Connector	Default Video Connector
1	Coaxial Digital 1	None
2	Coaxial Digital 2	None
3	Coaxial Digital 3	None
4	Coaxial Digital 4	None
5	Optical Digital 1	None
6	Optical Digital 2	None
7	Optical Digital 3	None
8	Optical Digital 4	None
9	XLR Analog 1	None
10	RCA Analog 2	None
11	RCA Analog 3	None
12	Coaxial Digital 1	None
13	Coaxial Digital 2	None
14	Coaxial Digital 3	None
15	Optical Digital 1	None
16	Optical Digital 2	None
17	Optical Digital 3	None
18	XLR Analog 1	None
19	RCA Analog 2	None
20	RCA Analog 3	None

Specifications

All specifications are accurate at the time of printing. Classé reserves the right to make improvements without notice.

- **Frequency response** 20Hz - 200kHz < 0.1dB, stereo analog bypass
20Hz - 20kHz < 0.2dB, all other sources
- **Distortion (THD+noise)** 0.001%, digital source/bypassed analog source
.002%, processed analog source
- **Maximum input level (single-ended)** 2Vrms (DSP), 6Vrms (bypass)
- **Maximum input level (balanced)** 4Vrms (DSP), 12Vrms (bypass)
- **Maximum output level (single-ended)** 8Vrms
- **Maximum output level (balanced)** 15Vrms
- **Gain Range** -100dB to +14dB
- **Input impedance** 100kΩ
- **Output impedance (main output)** 56Ω
- **Signal-to-noise ratio (ref. 10Vrms input)** 102dB, bypassed analog source
100dB, processed analog source
105dB, digital source
- **Channel separation** better than 100dB
- **Crosstalk (any input to any output)** better than -120dB @ 1kHz
- **Video input impedance** 75Ω
- **Video output impedance** 75Ω
- **HDMI** v.1.3b supporting Deep Color, 1080p @ 24/50/60 fps,
and x.v.Color(xvYCC).
- **Rated power consumption** 75W
- **Mains voltage** determined by the needs of country for which the unit
was manufactured; cannot be reset by dealer or user
- **Overall dimensions** Width: 17.5" (445mm)
Depth (excluding connectors) : 16.5" (419mm)
Height: 6.75" (172mm)
- **Net weight** 29 lbs (13 kg)
- **Shipping weight** 38 lbs (17 kg)

For more information, see your Classé dealer, or contact:

Classé Audio

5070 François Cusson

Lachine, Quebec

Canada H8T 1B3

Telephone +1 (514) 636-6384

FAX +1 (514) 636-1428

Internet: <http://www.classeaudio.com>

email: cservice@classeaudio.com

Classé and the Classé logo are trademarks of Classé Audio Inc. of Lachine, Canada. All rights reserved.

AMX is a registered trademark of AMX Corporation of Richardson, TX. All rights reserved.

Crestron™ is a trademark of Crestron Electronics, Inc. of Rockleigh, NJ. All rights reserved.

HDMI, the HDMI Logo and High-Definition Multimedia Interface are trademarks or registered trademarks of HDMI Licensing LLC.

Manufactured under license from Dolby Laboratories. Dolby, Pro Logic, and the double-D symbol are trademarks of Dolby Laboratories.

Manufactured under license under U.S. Patent #'s: 5,451,942; 5,956,674; 5,974,380; 5,978,762; 6,226,616; 6,487,535; 7,003,467; 7,212,872 & other U.S. and worldwide patents issued & pending. DTS, DTS Digital Surround, ES, and Neo:6 are registered trademarks and the DTS logos, Symbol and DTS 96/24 are trademarks of DTS, Inc.

© 1996-2008 DTS, Inc. All Rights Reserved.

Dimensions

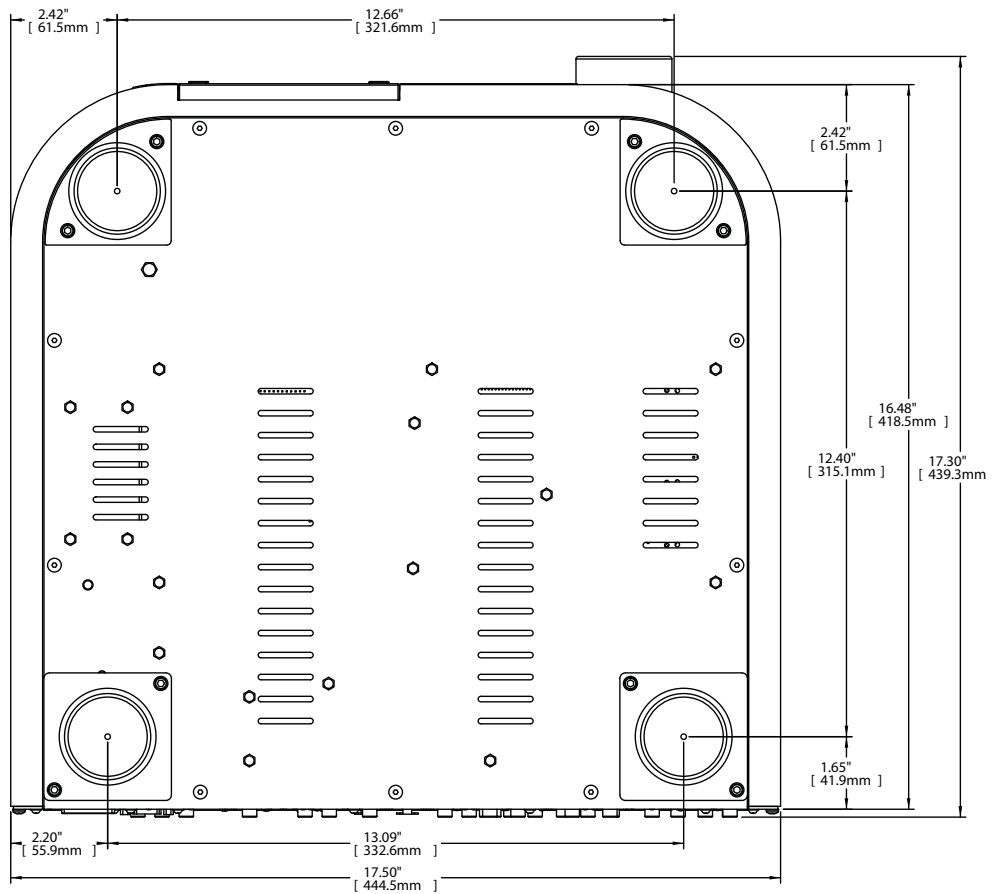
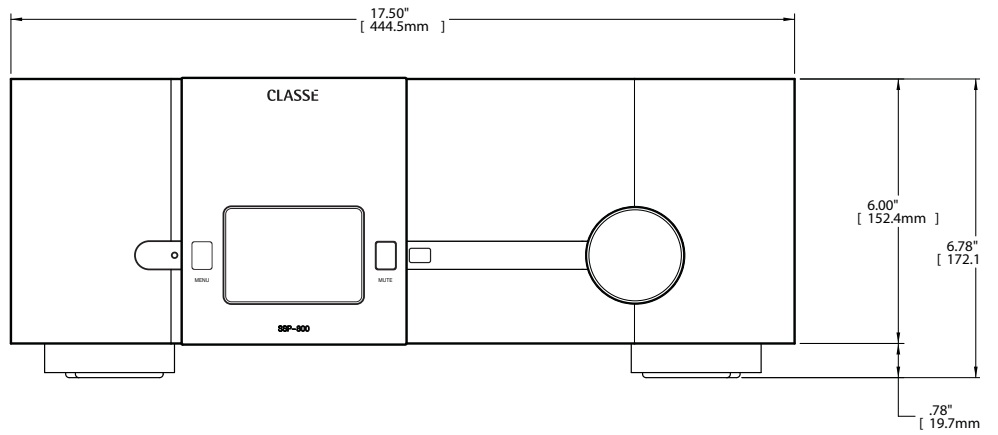

Installation Worksheet

Source: _____

Audio Connector: _____

Video Connector: _____

Input: _____

Source: _____

Audio Connector: _____

Video Connector: _____

Input: _____

Source: _____

Audio Connector: _____

Video Connector: _____

Input: _____

Source: _____

Audio Connector: _____

Video Connector: _____

Input: _____

Source: _____

Audio Connector: _____

Video Connector: _____

Input: _____

Source: _____

Audio Connector: _____

Video Connector: _____

Input: _____

CLASSE

Classé Audio

5070 François Cusson
Lachine, Quebec
Canada H8T 1B3

+1 (514) 636-6384
+1 (514) 636-1428 (fax)

<http://www.classeaudio.com>

email: cservice@classeaudio.com

North America: 1 800 370 3740
email: classe@bwgroupusa.com

Europe: 44 (0) 1903 221 700
email: classe@bwgroup.com

Asia: (852) 2790 8903
email: classe@bwgroup.hk

All Others: +1 514 636 6394
email: cservice@classeaudio.com

Free Manuals Download Website

<http://myh66.com>

<http://usermanuals.us>

<http://www.somanuals.com>

<http://www.4manuals.cc>

<http://www.manual-lib.com>

<http://www.404manual.com>

<http://www.luxmanual.com>

<http://aubethermostatmanual.com>

Golf course search by state

<http://golfingnear.com>

Email search by domain

<http://emailbydomain.com>

Auto manuals search

<http://auto.somanuals.com>

TV manuals search

<http://tv.somanuals.com>