

EXTRACTIVE GAS DETECTOR OPERATION MANUAL

Model PS-7

For Administrators



- Operate this unit only after reading and fully understanding the content of this manual.
- This Operation Manual was written for administrator use. Instructions for the basic operations of this unit are provided separately in the standard Operation Manual. Refer to the Operation Manual when necessary.



NEW COSMOS ELECTRIC CO., LTD.



DOD Technologies, Inc.

Innovative Life Safety Systems & Services

740 McArdle Drive, Unit C – Crystal Lake, IL 60014

815-788-5200 Phone

815-788-5300 Fax

www.dodtec.com

Some of the settings on this unit (alarm settings, etc.) are password protected.

This Operation Manual explains the following items:

- Passwords
- Changing settings

1 Passwords

1-1 Password-protected Settings

- Span adjustment (Refer to 2-1 *Span Adjustment*)
- 21vol% adjustment (Refer to 2-2 *21Vol% Adjustment*)
- The values of various settings (Refer to 2-3 *Changing Setting Values*)
- The values of alarm settings (Refer to 2-4 *Changing the Alarm Settings*)

1-2 Releasing the Password Lock

(1) Press these key switches in the following order.

1. ZERO switch
2. UP switch
3. Special command switch
4. DOWN switch

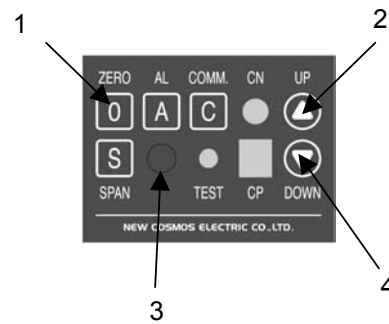

(2) The password lock is released when the POWER lamp (green) blinks once.

POWER lamp (green)
Blinks once



(3) The password lock is automatically reactivated 10 minutes after it has been released.

Warning

Important tasks, such as changing alarm settings, span adjustment, etc., can be carried out once the password lock is released. Take the utmost care regarding confidentiality of the password.

2 Changing Settings

2-1 Span Adjustment

Toxic gas sensor unit : CDS-7
Combustible gas sensor unit : CHS-7

(1) Set to maintenance mode (MNT1 or MNT2).

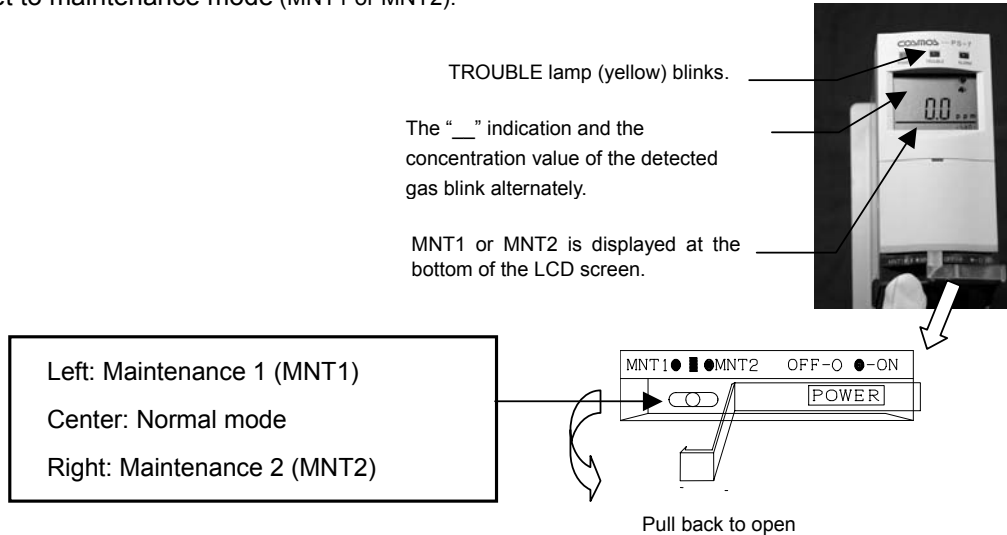

(2) Release the password lock. (Refer to 1-2 Releasing the Password Lock.)

(3) Press the SPAN switch.

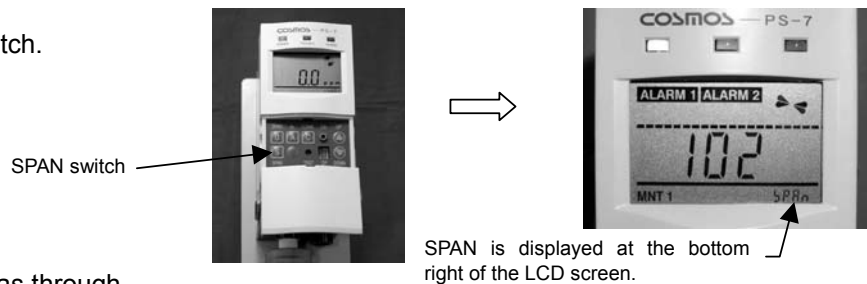

(4) Let the calibration gas through.

(5) Use the UP/DOWN switch to adjust the concentration indication on the screen to that of the calibration gas concentration.

(6) Once adjustments have been done, press the SPAN switch again. The SPAN indication in the bottom right of the LCD screen will go off, and the span adjustment will be completed.

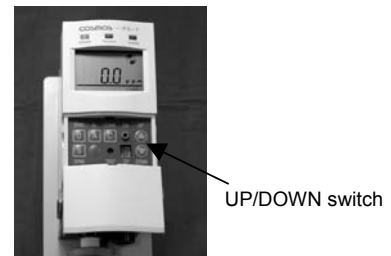

(7) Remove the calibration gas, check that the detected gas concentration is under that of the alarm value, and restore to the normal mode (by switching the maintenance switch to the center).

2-2 21Vol% Adjustment

Oxygen sensor unit: COS-7

- (1) Set to maintenance mode (MNT1 or MNT2).

TRouble lamp(yellow) blinks.

The “_” indication and the concentration value of the Oxygen blink alternately.

MNT1 or MNT2 is displayed at the bottom of the LCD screen.



Left: Maintenance 1 (MNT1)
Center: Normal mode
Right: Maintenance 2 (MNT2)

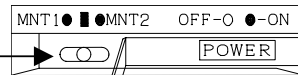

Pull back to open

- (2) Release the password lock. (Refer to 1-2 Releasing the Password Lock.)

- (3) Press the SPAN switch.



SPAN switch



SPAN is displayed at bottom of the LCD screen

- (4) Let the calibration gas through.

- (5) Use the UP/DOWN switch to adjust the concentration indication on the screen to that of the calibration gas concentration.

- (6) When the adjustment is completed, press the SPAN switch again. The SPAN indication in the bottom right corner of the LCD screen will then disappear, and the 21vol% adjustment is complete.

- (7) Remove the calibration gas and confirm that no alarm is displayed (ALARM 1, ALARM 2 is not shown). Then, restore to the normal mode by switching the maintenance switch to the center.

2-3 Changing Setting Values

Some of the setting values of the unit can be changed. Those that can be changed are listed in the table below. The method for changing them is explained here.

(1) Release the password lock. (Refer to *1-2 Releasing the Password Lock.*)

(2) Press the UP/DOWN switch (“△” or “▽”) until the setting you wish to change (“LCD Screen Indication” in the table below) is displayed at the bottom right of the LCD display.

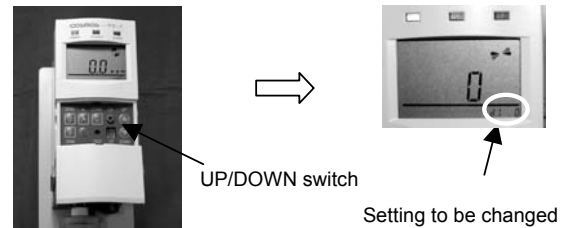

(3) Then press the special command switch, and the setting to be changed (“LCD Screen Indication” in the table below) and “—” will flash alternately.

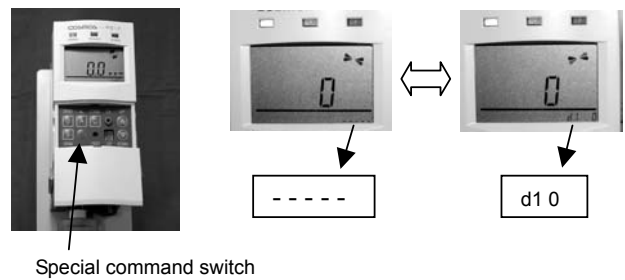

(4) Change the value by using the UP/DOWN switches (“△” or “▽”). When you are done, press the special command switch again, and the alternating display in the bottom right corner of the LCD display will become constant. The process is now finished.

	LCD Screen Indication	The function to be set	Remarks	Default value		Adjustable Range
				Toxic: CDS-7 Combustible : CHS-7	Oxygen: COS-7	
↑ When the DOWN switch is pressed, it will move up one. ↓	d1 **	Time delay 1	Time delay (secs.) of the gas alarm contact (1st level)	d1 0	d1 0	0 to 99 sec
	d2 **	Time delay 2	Time delay (secs.) of the gas alarm contact (2nd level)	d2 0	d2 0	0 to 99 sec
	az	Analog output (base)	(*For our maintenance purposes only)	-	-	-
	as	Analog output (span)	(*For our maintenance purposes only)	-	-	-
	zs *	Zero suppression, or 21vol% suppression	Displays the percentage of the full scale value (rounded to the percent)	zs 5	zs 2	0 to 30%
	H-H L-L H-L	Alarm mode	1st: upper limit, 2nd : upper limit warning 1st : lower limit, 2nd : lower limit warning 1st : upper limit, 2nd: lower limit warning	H-H	L-L	H-H L-L H-L
	Con *	Pyroletic converter failure alarm	0 : Off 1: On	Con 0	Con 0	0 or 1
	CG **	Calibration gas concentration	(*For our maintenance purposes only)	CG 40	CG 84	-
	nEt *	The existence of a DeviceNet unit	0 : Non-existent 1: Existent	nEt 0	nEt 0	0 or 1
	F ***	Display of f value	Calibration gas type in lower right of LCD f value in center of LCD	(Depending on the sensor unit)		
	FL ***	Displays rate of flow	Shows the current rate of flow (mL/min)	(Depending on the rate of flow)		
	P ***	Sensor unit output	(*For our maintenance purposes)	--		
	At *	Auto 21vol% adjustment	0 : Off 1: On	-	A t 1	0 or 1
	xxx		Type of sensor unit (Normal display)	(Depending on the sensor unit)		

2-4 Changing the Alarm Settings

The values of alarm settings on this unit can be changed. The method for changing them is explained here.

(1) Release the password lock. (Refer to 1-2 Releasing the Password Lock.)

(2) Press the AL switch until the alarm setting to be changed is displayed on the LCD display.

(The bottom right of the screen, as in the table below.)

The alarm setting for the actual gas concentration is displayed in the middle of the screen, and the percentage of the full scale value is displayed in the bottom right corner

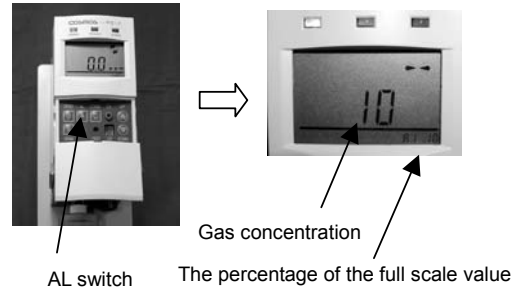

LCD Display Indication (Lower right)	Default value		Explanation of the default value	Adjustable Range
A1 **	Toxic : CDS-7	A1 10	10% F.S.	0 to 100% F.S.
	Comb. : CHS-7	A2 72	72% F.S.	
A2 **	Toxic : CDS-7	A2 20	20% F.S.	0 to 100% F.S.
	Comb. : CHS-7	A2 76	76% F.S.	

* Pressing the AL switch changes to 1st level → 2nd level → Normal display.

* The A2 value should be greater than the A1 value in any case.

(3) Press the special command switch.

The setting to be changed and the “—” indication will then flash alternately.

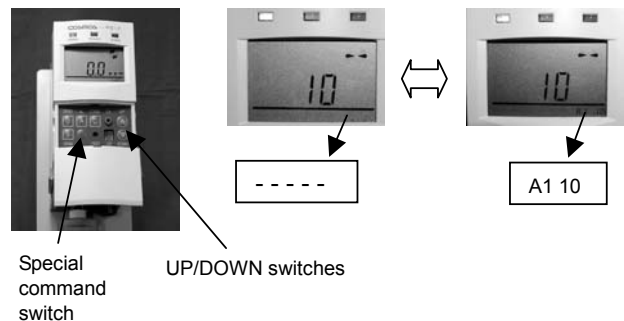

(4) Change the value by using the UP/DOWN key “△” and “▽”.

When you are done, press the special command switch again, and the alternating display in the lower right corner of the LCD display will become constant. The process is now finished.

(5) When this is finished, press the UP/DOWN switches (“△” or “▽”) again to return to the normal display.

Note

The relationship between 1st level and 2nd level alarm values of each alarm mode is as follows:

H – H mode (1st level: Upper limit, 2nd level: Upper limit)

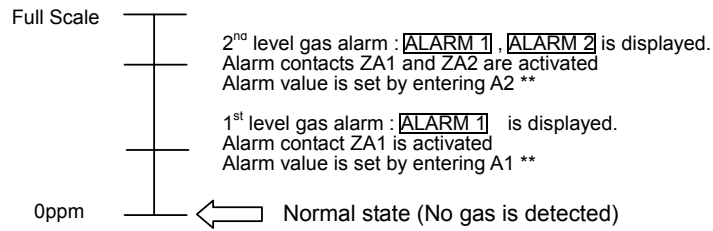

L – L mode (1st level: Lower limit, 2nd level: Lower limit)

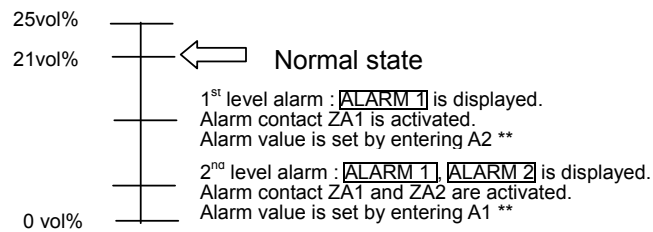

H – L mode (Upper limit, Lower limit)

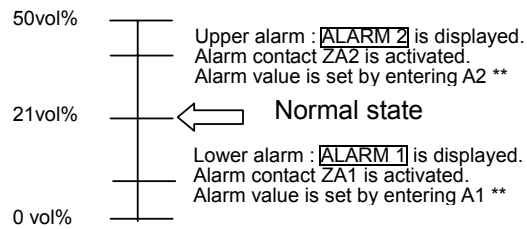

* A2 value should be always greater than A1 value.

Manual Revision History

Edition No.	Date	Revisions
GAE-019	July 2004	

Additional copies of this Operation Manual are available.
Contact the following address for ordering information.

Manufacturer:

New Cosmos Electric Co., Ltd.
2-5-4 Mitsuya-naka
Yodogawa-ku
Osaka 532-0036, Japan
Phone 81-6-6309-1505
Fax 81-6-6309-1514

Distributor:

DOD Technologies, Inc
740 McArdle Drive
Unit C
Crystal Lake, IL 60014
Phone 815-788-5200
Fax 815-788-5200
www.dodtec.com

Free Manuals Download Website

<http://myh66.com>

<http://usermanuals.us>

<http://www.somanuals.com>

<http://www.4manuals.cc>

<http://www.manual-lib.com>

<http://www.404manual.com>

<http://www.luxmanual.com>

<http://aubethermostatmanual.com>

Golf course search by state

<http://golfingnear.com>

Email search by domain

<http://emailbydomain.com>

Auto manuals search

<http://auto.somanuals.com>

TV manuals search

<http://tv.somanuals.com>