

Lenox Sound[®]

MODEL DVD- 2003

DVD VIDEO PLAYER

INSTRUCTION MANUAL



- FULL ON SCREEN DISPLAY
- PLAYS DVD VIDEOS
- PLAYS ALL AUDIO CDS
- PLAYS CD-R & CDRW DISCS
- PLAYS MP3 RECORDED DISCS



PLEASE READ CAREFULLY BEFORE USE

IB-DVD2003-COMPUSA-E-061202

SAFETY INSTRUCTIONS

WARNING

TO PREVENT FIRE OR SHOCK HAZARD, DO NOT USE THE PLUG WITH AN EXTENSION CORD, RECEPTACLE OR OTHER OUTLET UNLESS THE BLADES CAN BE FULLY INSERTED TO PREVENT BLADE EXPOSURE. TO PREVENT FIRE OR SHOCK HAZARD, DO NOT EXPOSE THIS APPLIANCE TO RAIN OR MOISTURE.

 <p>The lightning flash with arrowhead symbol, within an equilateral triangle, is intended to alert the user to the presence of uninsulated "dangerous voltage" within the product's enclosure that may be of sufficient magnitude to constitute a risk of electric shock to persons.</p>	<p>WARNING RISK OF ELECTRIC SHOCK DO NOT OPEN</p> <p>WARNING: TO REDUCE THE RISK OF ELECTRIC SHOCK, DO NOT REMOVE COVER (OR BACK). NO USER SERVICEABLE PARTS INSIDE. REFER SERVICING TO QUALIFIED SERVICE PERSONNEL.</p>	 <p>The exclamation point within an equilateral triangle is intended to alert the user to the presence of important operating and maintenance (servicing) instructions in the literature accompanying the appliance.</p>
----------------------------------------------------------------------------------------------------------------------------------------------------------------------------------------------------------------------------------------------------------------------------------------------------------------------------------------------------------------------------	-------------------------------------------------------------------------------------------------------------------------------------------------------------------------------------------------------------------------------------------------------	-----------------------------------------------------------------------------------------------------------------------------------------------------------------------------------------------------------------------------------------------------------------------------------------------------------

IMPORTANT SAFETY INSTRUCTIONS

1. Read these instructions.
2. Keep these instructions.
3. Heed all warnings.
4. Follow all instructions.
5. Do not use this apparatus near water.
6. Clean only with dry cloth.
7. Do not block any ventilation openings, install in accordance with the manufacturer's instructions.
8. Do not install near any heat sources such as radiators, heat registers, stoves, or other apparatus (including amplifiers) that produce heat.
9. Do not defeat the safety purpose of the polarized or grounding-type plug. A polarized plug has two blades with one wider than the other. A grounding type plug has two blades and a third grounding prong. The wide blade or the third prong are provided for your safety. If the provided plug does not fit into your outlet, consult an electrician for replacement of the obsolete outlet.
10. Protect the power cord from being walked on or pinched particularly at plugs, convenience receptacles, and the point where they exit from the apparatus.
11. Only use attachments/accessories specified by the manufacturer.
12. Unplug this apparatus during lightening storms or when unused for long periods of time.
13. Refer all servicing to qualified service personnel. Servicing is required when the apparatus has been damaged in any way, such as power-supply cord or plug is damaged, liquid has been spilled or objects have fallen into the apparatus, the apparatus has been exposed to rain or moisture, does not operate normally or has been dropped.
14. This appliance shall not be exposed to dripping or splashing water and that no object filled with liquid such as vases shall be placed on the apparatus.

Do not apply oil or petroleum products or solvents to any part of this set.

FCC NOTE

This equipment has been tested and found to comply with the limits for a Class B digital device, pursuant to Part 15 of the FCC rules. These limits are designed to provide reasonable protection against harmful interference in a residential installation. This equipment generates, uses and can radiate radio frequency energy and, if not installed and used in accordance with the instructions, may cause harmful interference to radio communications. However, there is no guarantee that interference will not occur in a particular installation. If this equipment does cause harmful interference to radio or television reception, which can be determined by turning the equipment off and on, the user is encouraged to try to correct the interference by one or more of the following measures.

- Reorient or relocate the receiving antenna.
- Increase the separation between the equipment and receiver.
- Connect this equipment into an outlet on a circuit different from that to which the receiver is connected.
- consult the dealer or an experienced radio/TV technician for help.

CAUTION

FCC Regulations state that unauthorized changes or modifications to this equipment may void the user's authority to operate it.

NOTE

This product incorporates copyright protection technology that is protected by method claims of U.S. patent numbers 4,631,603; 4,577,216; 4,819,098 and 4,907,093, and other intellectual property rights owned by Macrovision Corporation and other rights owners. Use of this copyright protection technology must be authorized by Macrovision Corporation, and is intended for home and other limited viewing uses only, unless otherwise authorized by Macrovision Corporation. Reverse engineering or disassembly is prohibited.

CAUTION

Use of controls or adjustments or performance of procedures other than those specified herein may result in hazardous radiation exposure. Do not open covers and do not repair yourself. Refer servicing to qualified personnel. This DVD VIDEO player is classified as CLASS 1 LASER PRODUCT as stated on the back of the set.

TABLE OF CONTENTS

• Getting Started:

Safety Instructions-----	1
Setup and Connections	
Choose Your Connection-----	3
Cables Needed to Connect Components to Your TV-----	3
DVD Player + TV with Audio/Video Input Jacks-----	4
DVD Player + TV with Audio/Video Input Jacks-----	5
DVD Player + TV + VCR-----	6
DVD Player + TV/VCR-----	7
DVD Player + TV + Dolby Digital Theatre System (Audio/Video Receiver)-----	8
DVD Player + TV + VCR + Satellite Receiver -----	9
Introduction-----	10
Location of Controls-----	10,11
Remote Control Operation -----	12
Notes on Discs -----	13
Precautions-----	14

• Initial Setting:

Finding Your TV's Video Input Channel-----	15
Moving Around the DVD Player's Menu -----	15
Setting Languages (OSD, MENU, AUDIO and SUBTITLE)-----	16
Select TV Screen Type -----	17
Select Screen Saver -----	18
Setting Audio Output -----	18
Custom Setup (parental controls) -----	19
Changing Password -----	19

• Basic Operation:

1. Basic Play-----	20
2. Using the Search & Skip Functions-----	22
3. Pause and Step Play-----	22
4. Repeat Play-----	23
5. Programmed Play-----	24
6. Search for Preferred Play-----	24
7. Zoom Play-----	25
8. Slow-Motion Play-----	25
9. Viewing from a Desired Angle-----	26
10. Selecting Audio Soundtrack Language-----	26
11. Changing Subtitle Language-----	27
12. MP3 CD Operation-----	27

• Trouble Shooting -----29



• Specifications -----32

Manufactured under license from Dolby Laboratories. "Dolby" and the double-D symbol are trademarks of Dolby Laboratories. Confidential Unpublished works. ©1992-1997 Dolby Laboratories, Inc. All rights reserved.

CONNECTIONS

Choose Your Connection

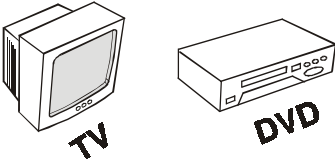
There are several ways to connect your DVD player. Please use the following chart to determine which connection is best for you. Turn to the appropriate page and connect your DVD player.

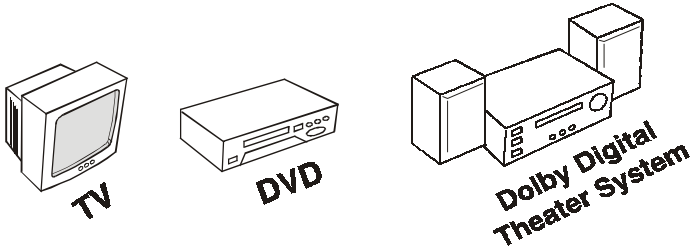
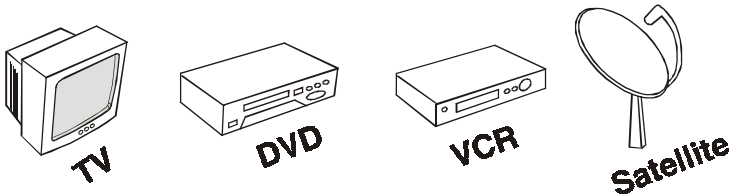
COMPONENTS	CABLES NEEDED		GO TO ...
 <p>TV DVD</p>	<ul style="list-style-type: none"> • Audio/Video (included) • Coaxial (optional) • S-Video (optional) 	TV + DVD	Page 4,5
 <p>TV DVD VCR</p>	<ul style="list-style-type: none"> • Audio/Video (included) • Coaxial (optional) • S-Video (optional) 	TV + DVD + VCR	Page 6,7
 <p>TV DVD Dolby Digital Theater System</p>	<ul style="list-style-type: none"> • Audio/Video (included) • S-Video (optional) • Coaxial (needed but not included) 	TV + DVD + Dolby Digital	Page 8
 <p>TV DVD VCR Satellite</p>	<ul style="list-style-type: none"> • Audio/Video (included) • Coaxial (optional) • S-Video (optional) 	TV + DVD + VCR + Satellite	Page 9

Cables Needed to Connect Components to Your TV

The pictures below show the cables needed for the connections represented in this booklet.

NOTE: Audio/Video cables (A/V cables for short) are usually sold as a bundled set, but the connection pictures in this booklet show each cable separately for better visibility.

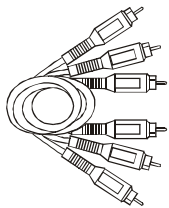

Audio/Video cables
(1 set is included)

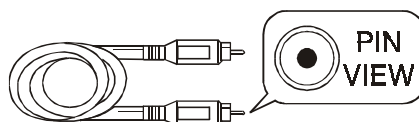

Coaxial cable
(not included)

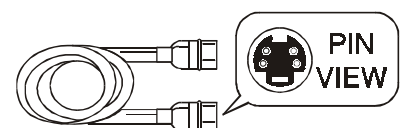

S-Video cable
(not included)

CONNECTIONS

DVD Player + TV *with* Audio/Video Input Jacks

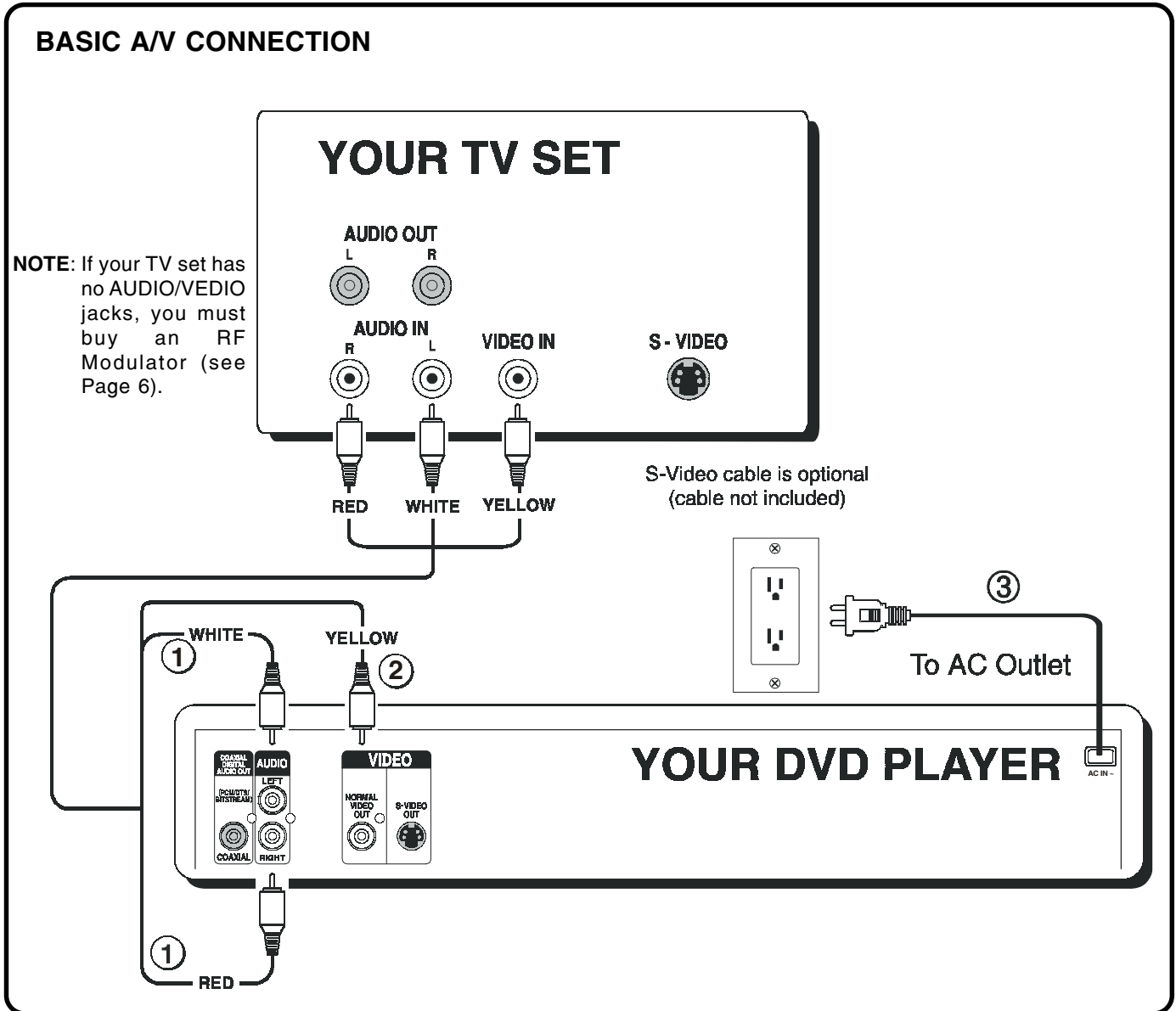

1. Insert the audio cables into the AUDIO OUT L (left=white) and R (right=red) jacks on the back of your DVD player, and into the corresponding AUDIO IN jacks on your TV set.
2. Insert the video cable (yellow) into the VIDEO OUT jack on the back of your DVD Player, and into the VIDEO IN jack on your TV. This connection will allow you to enjoy standard quality video images.
3. Insert the AC power cord into an AC outlet.
4. Go to Page 20 for playing DVDs (discs).

NOTE: Your cable or antenna connection to the television should not be affected by this connection. Connect your antenna cable to your television as you normally would. You may need to consult your television manual for details, but no changes will be made to your current antenna connections.

CONNECTIONS

DVD Player + TV with Audio/Video Input Jacks Using S-Video Cable

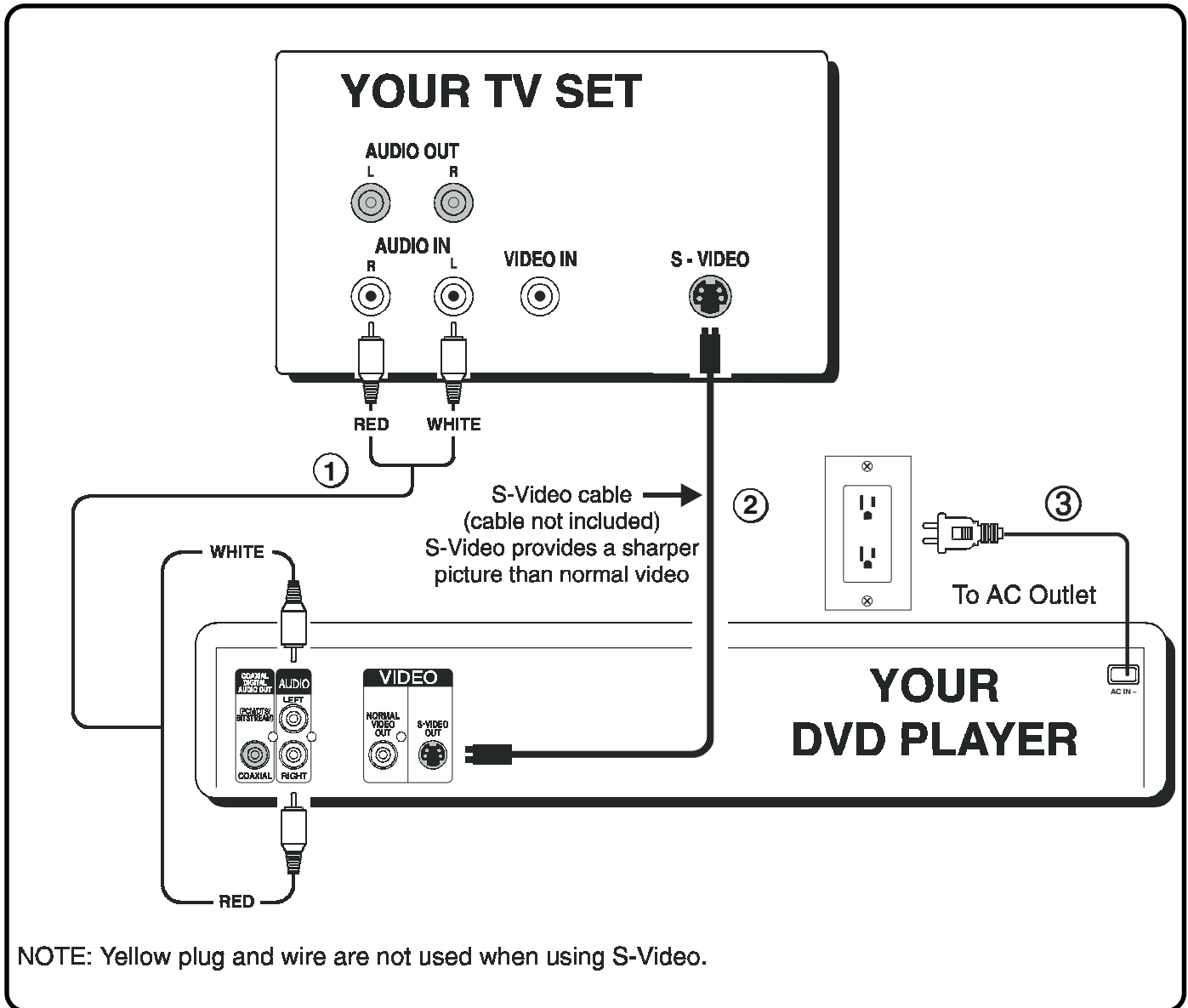

1. Insert the audio cables into the AUDIO OUT **L** (left=white) and **R** (right=red) jacks on the back of your DVD player, and into the corresponding AUDIO IN jacks on your TV.
2. Insert the S-Video cable into the S-VIDEO OUT jack on the back of your DVD player and to the S-VIDEO jack on your TV. This connection will allow you to enjoy higher quality images. If your TV doesn't have S-VIDEO, use the basic video connection listed above on Page 4 (yellow plugs: VIDEO IN or OUT, are not needed for S-Video).
3. Insert the AC power cord into an AC outlet.
4. Go to Page 20 for playing DVDs (discs).

NOTE: Your cable or antenna connection to the television should not be affected by this connection. Connect your antenna cable to your television as you normally would. You may need to consult your television manual for details, but no changes will be made to your current antenna connections.

CONNECTIONS

DVD Player + TV + VCR

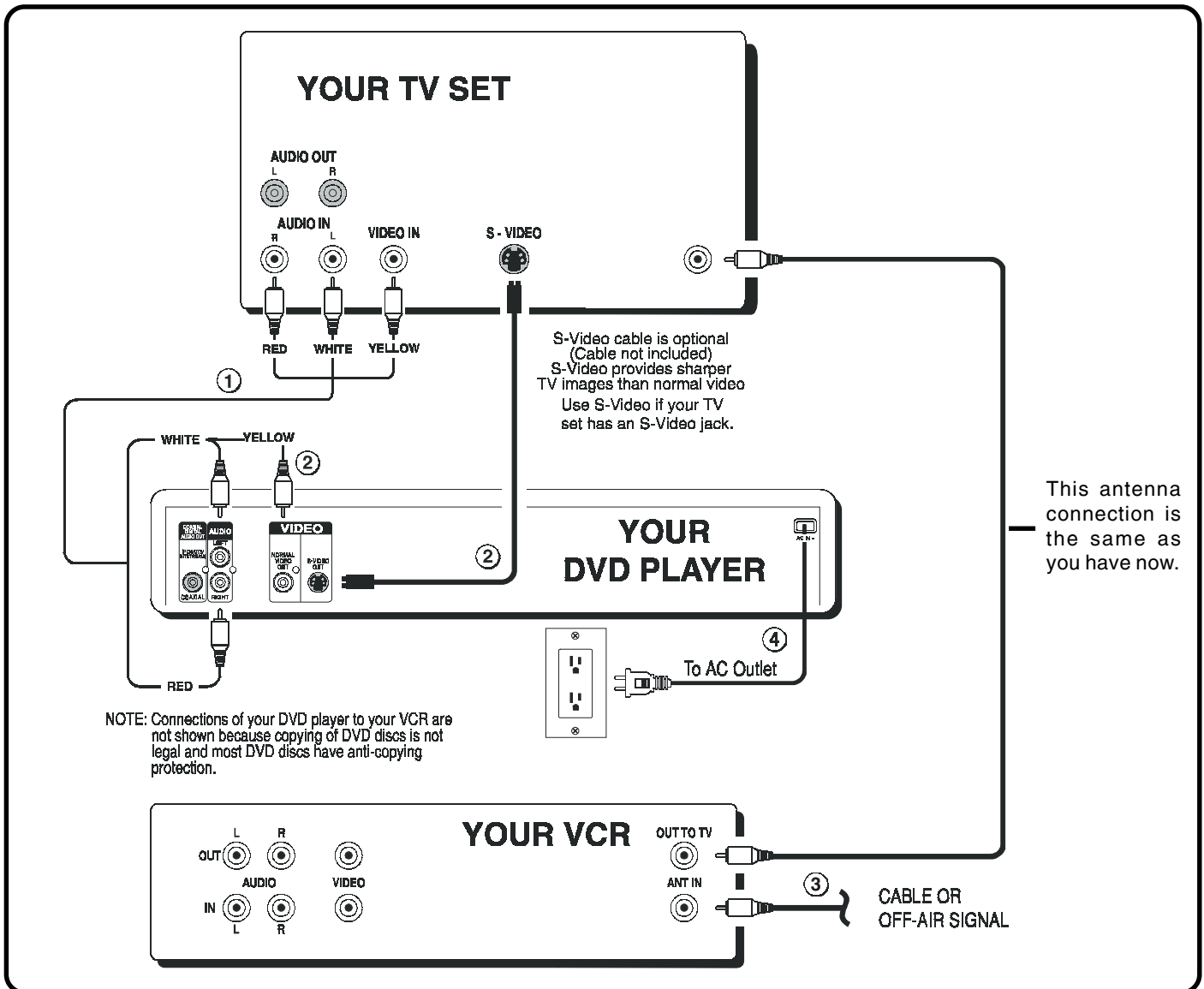

1. Insert the audio cables into the AUDIO OUT L (left=white) and R (right=red) jacks on the back of your DVD Player, and into the corresponding AUDIO IN jacks on your TV.
2. Connect the video cable.
 - **Basic video connection** - Connect the video cable (yellow) to the VIDEO OUT jack on the back of your DVD Player, and to the Video Input jack on your TV.
 - _____ OR _____
 - **S-Video** (optional) - If your TV has an S-Video Input jack, connect the S-Video cable to the S-VIDEO OUT jack on the back of your DVD player (for sharper pictures) and to the S-Video jack on your TV. If your TV doesn't have S-Video, use the basic video connection listed above (yellow plugs: VIDEO IN or OUT, are not needed for S-Video).
3. Connections of your antenna cables are not changed when you add your DVD player.
4. Insert the AC power cord into an AC outlet.
5. Go to Page 20 for playing DVDs (discs).

CONNECTIONS

DVD Player + TV/VCR Combination

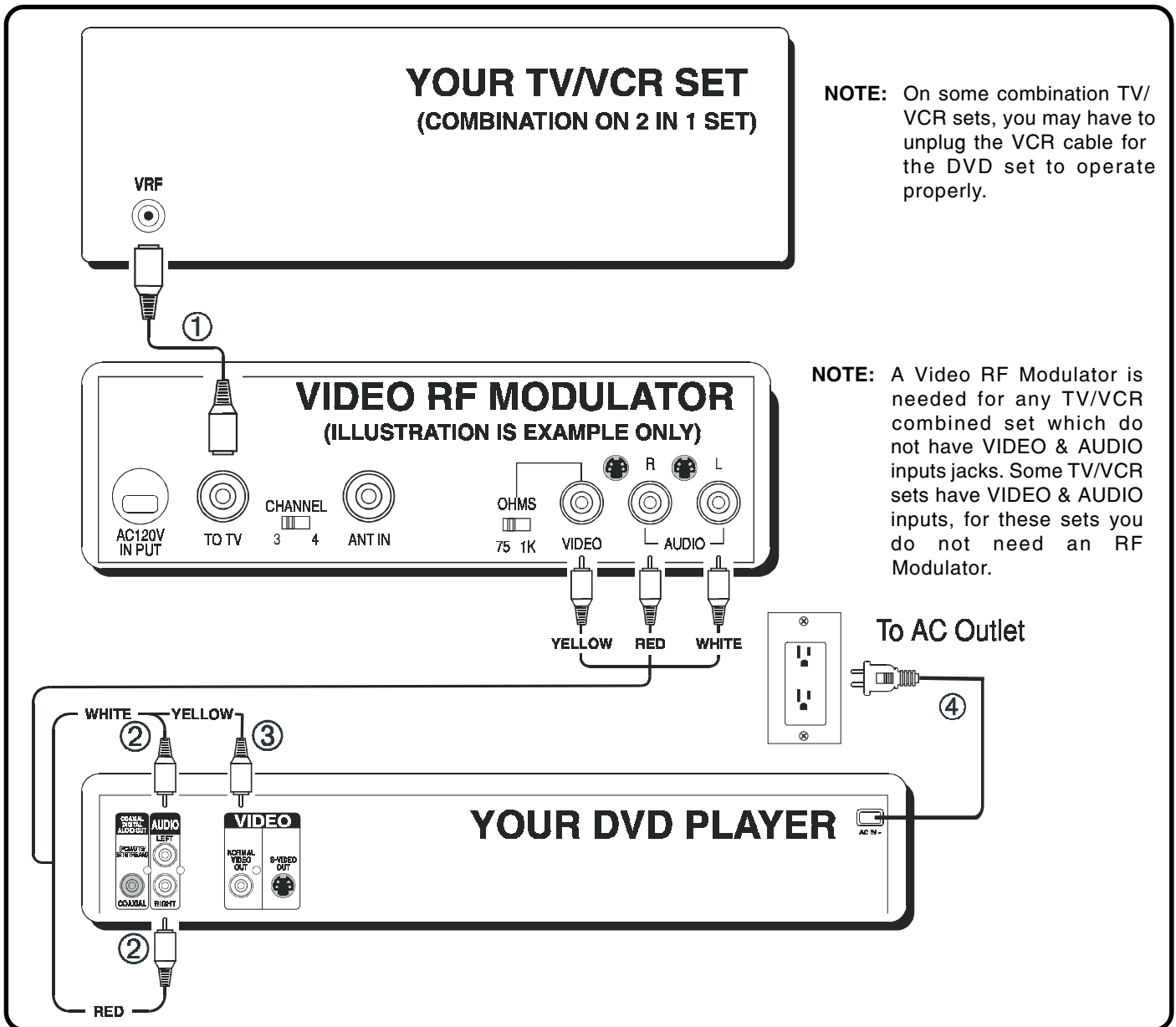

NOTE: On some combination TV/VCR sets, you may have to unplug the VCR cable for the DVD set to operate properly.

NOTE: A Video RF Modulator is needed for any TV/VCR combined set which do not have VIDEO & AUDIO inputs jacks. Some TV/VCR sets have VIDEO & AUDIO inputs, for these sets you do not need an RF Modulator.

1. Insert the audio cables to the AUDIO OUT L (left=white) and R (right=red) jacks on the back of your DVD Player, and into the corresponding AUDIO IN jacks on your VIDEO RF MODULATOR.
2. Connect the video cable (yellow) to the VIDEO OUT jack on the back of your DVD player, and into the Video Input jack on your VIDEO RF MODULATOR.
3. Insert the RF MODULATOR'S antenna cable (not included) into the ANTENNA jack on the back of your TV/VCR player, and to the TV OUT jack of your VIDEO RF MODULATOR.
4. Insert the AC power cord into an AC outlet.
5. Go to Page 20 for playing DVDs (discs).

CONNECTIONS

DVD Player + TV + Dolby Digital Theater System (Audio/Video Receiver/Home Theater)

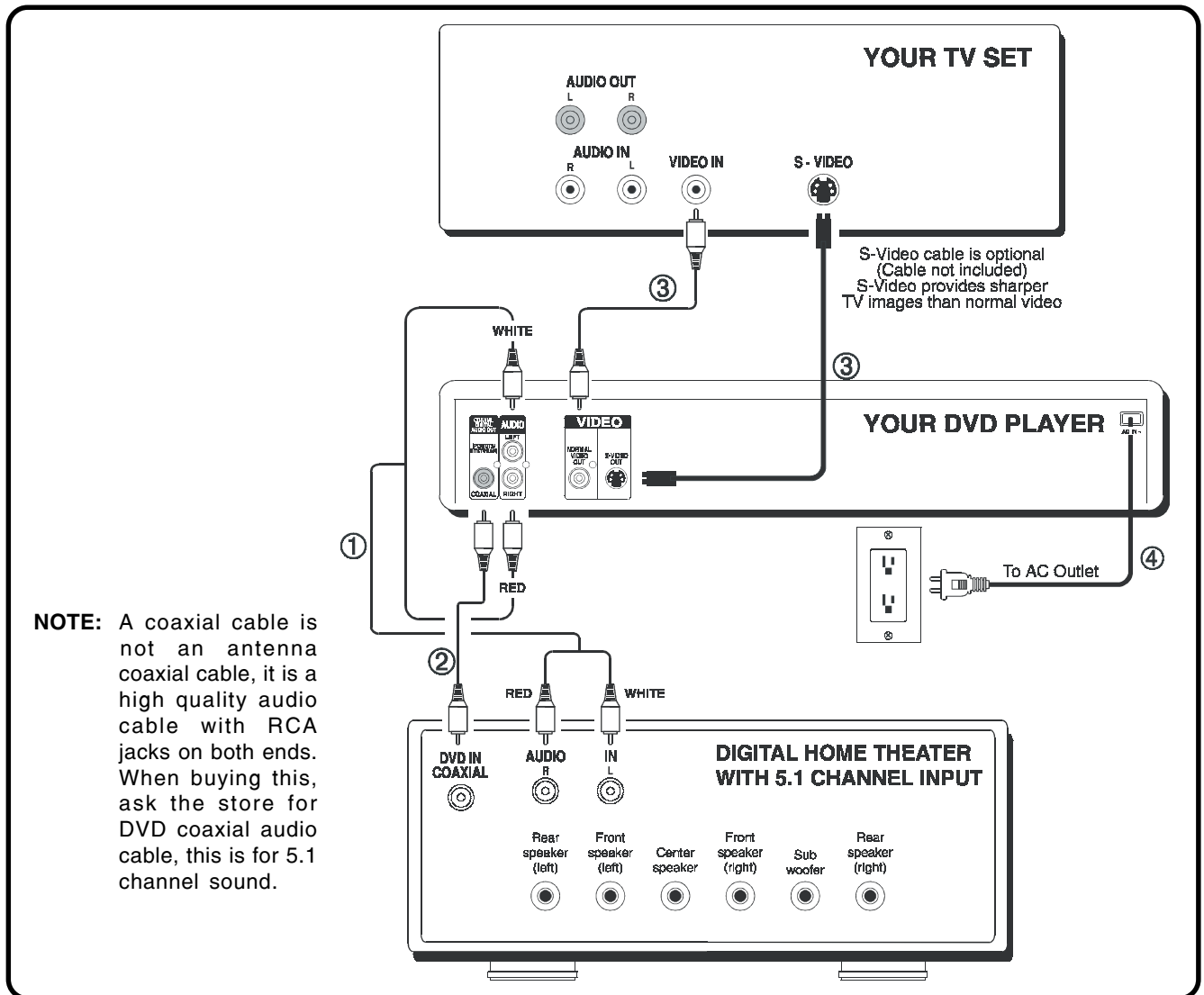

1. Insert the audio cables into the AUDIO OUT L (left -white) and R (right-red) jacks on the back of your DVD Player, and into the corresponding audio input jacks on your audio video receiver.
2. If you have a Dolby Digital or Digital Theatre receiver, insert a coaxial digital cable (not included, see note above) to the DIGITAL AUDIO OUT jack on the DVD player and to the Digital Input jack on the back of the receiver. This connection will allow you to use the Dolby Digital or DTS decoder functions of your AV amplifier (receiver). You must also set the Digital Output setting in the Audio Setup menu (see page 18).
3. Connect the video cable.
 - **Basic video connection** - Insert the video cable (yellow) to the VIDEO OUT jack on the back of your DVD Player, and into the Video Input jack on your TV.
 - OR
 - **S-Video** (optional) - If your TV has an S-Video Input jack, insert the S-Video cable to the S-VIDEO OUT jack on the back of your DVD player and into the S-Video jack on your TV. If your TV doesn't have S-Video, use the basic video connection listed above as on Page 4 (yellow plugs: VIDEO IN or OUT, are not needed for S-Video).
4. Insert the AC power cord into an AC outlet.
5. Go to Page 20 for playing DVDs (discs).

CONNECTIONS

DVD Player + TV + VCR + Satellite Receiver

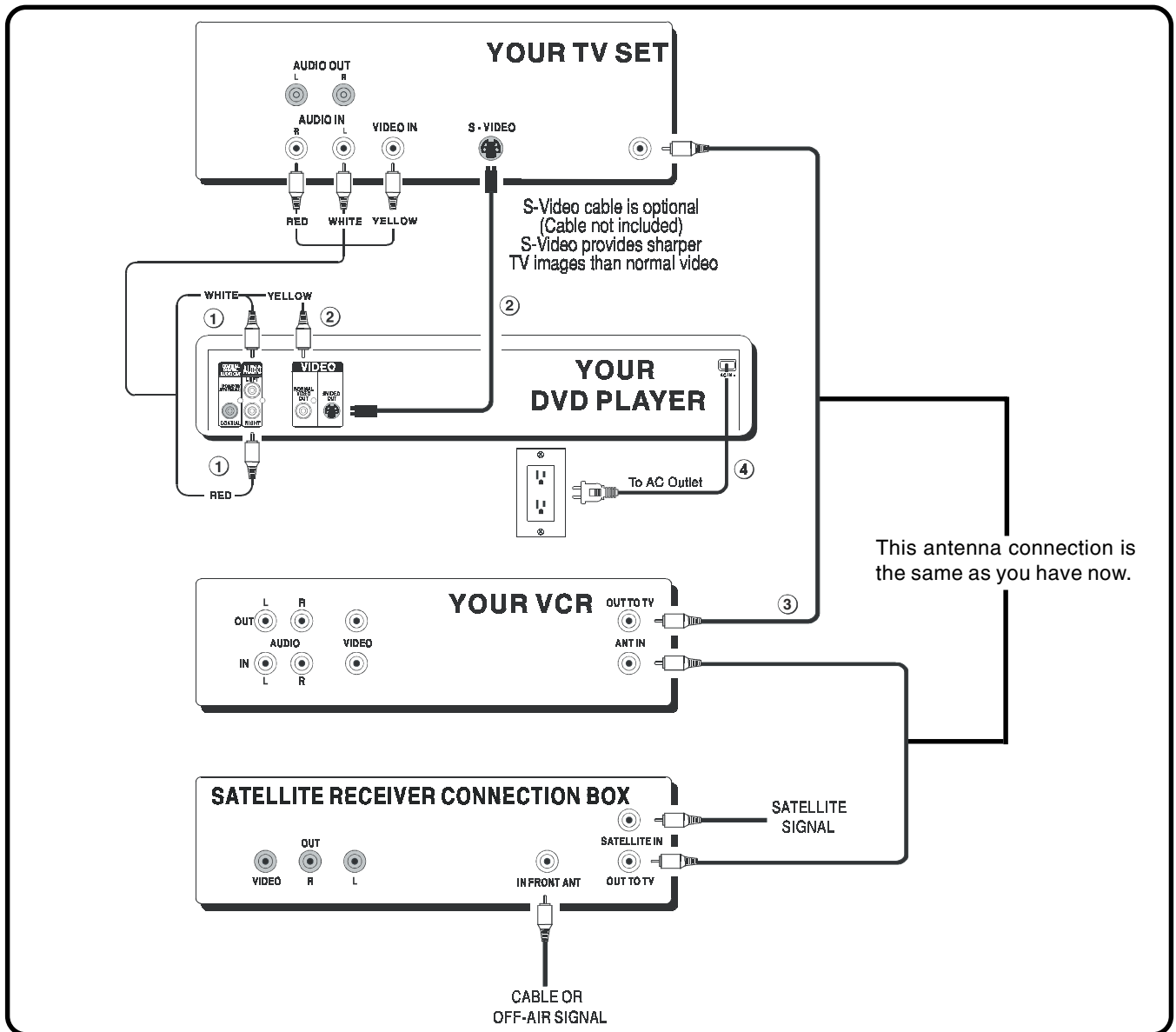

1. Insert the audio cables to the AUDIO OUT L (left -white) and R (right-red) jacks on the back of your DVD Player, and into the corresponding AUDIO IN jacks on your TV.
2. Connect the video cable.
 - **Basic video connection** - Insert the video cable (yellow) into the VIDEO OUT jack on the back of your DVD Player, and into the VIDEO IN jack on your TV.
_____ OR _____
 - **S-Video** (optional) - If your TV has an S-Video Input jack, insert the S-Video cable into the S-VIDEO OUT jack on the back of your DVD player and into the S-Video jack on your TV. If your TV doesn't have S-Video, use the basic video connection listed above as on Page 4 (yellow plugs: VIDEO IN or OUT, are not needed for S-Video).
3. Use an antenna cable to connect the antenna output on the satellite receiver to the antenna input on the VCR the same as you have it connected now. This DVD player does not change any antenna connections.
4. Insert the AC power cord into an AC outlet.
5. Go to Page 20 for playing DVDs (discs).

INTRODUCTION

NOTE: This DVD player will play DVD movies as well as Audio CDs. To simplify, we refer to these as “discs” in this booklet. Your DVD player is equipped with some special features. The following information summarizes some of these features.

The On-Screen Information Display

This menu bar display can display and access certain features while discs are playing (or before play starts-in setup). Icons and words represent the different features supported by your DVD player. By selecting different icons and words, you can access features including REPEAT, AUDIO, SUBTITLES, CAMERA ANGLE and LANGUAGES, etc.

Ratings Limits

Your DVD player allows you to set ratings limits and passwords. For example, you can set the DVD player so that any movie with a PG-13 rating or above requires a password to be entered. There are many levels of ratings to choose from. Since not all discs contain ratings, you can also decide if you want to allow free access or require a password to view unrated discs.

Screen Saver

When the DVD's power is on and the movie finished playing, 5 minutes later, your DVD will change to “Screen Saver” mode automatically (if you set the SCREEN SAVER to ON as explained on Page 18). For example, when playing a CD music disc (no video output), the screen will display the “Screen Saver” moving icon, and you will see a moving ball on the screen. You may exit the “Screen Saver” mode by pressing any of the remote buttons.

LOCATION OF CONTROLS

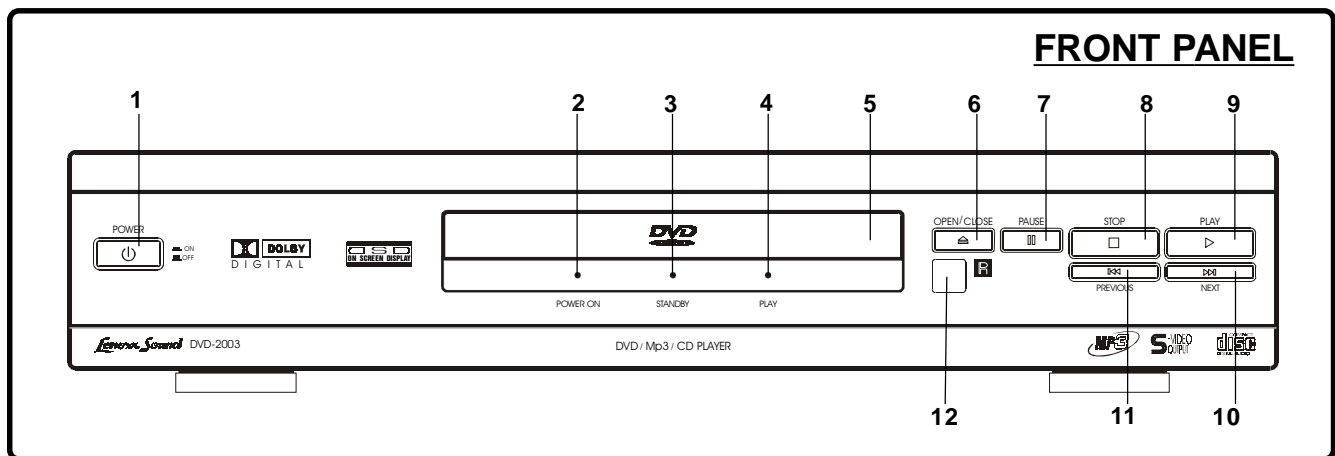

- 1. POWER button** - Press to switch the set on or off.
- 2. POWER ON indicator** - Lights red when POWER is on.
- 3. STANDBY indicator** - When the power is on, press the POWER button on the REMOTE, this indicator lights up in GREEN and the player is off in standby mode.
- 4. PLAY indicator** - During play, this indicator lights up, also when you press any button on the REMOTE, this lamp flashes rapidly to show you the remote's signal was received.
- 5. DISC TRAY** - Set the disc into this tray.
CAUTION: Do not put anything but a disc on the tray.
- 6. OPEN/CLOSE button** - Opens and closes the DISC TRAY.
- 7. PAUSE button** - Press to pause or step the picture.
- 8. STOP button** - Stops playing the disc.
- 9. PLAY button** - Press to start playing the disc.
- 10. NEXT SKIP button** - Skips to next chapter (forwards).
- 11. PREVIOUS SKIP button** - Skips to previous chapter (backwards).
- 12. REMOTE CONTROL SIGNAL sensor** - Receives the signal from the REMOTE CONTROL (Aim the REMOTE towards this sensor).

Free Manuals Download Website

<http://myh66.com>

<http://usermanuals.us>

<http://www.somanuals.com>

<http://www.4manuals.cc>

<http://www.manual-lib.com>

<http://www.404manual.com>

<http://www.luxmanual.com>

<http://aubethermostatmanual.com>

Golf course search by state

<http://golfingnear.com>

Email search by domain

<http://emailbydomain.com>

Auto manuals search

<http://auto.somanuals.com>

TV manuals search

<http://tv.somanuals.com>