

FREE TO CHOOSE INNOVATIONS

XORO[®]

MPEG4 DVD - Player



HSD 401plus



HSD 310 | HSD 415

M a n u a l



::mp4



CONTENTS

FEATURES	57
SAFETY PRECAUTIONS	58
ACCESSORIES	60
OUTPUTS AND CONTROL ELEMENTS HSD 400 plus	61
● DVD-Player	61
Front panel	61
Back panel	61
OUTPUTS AND CONTROL ELEMENTS HSD 310 / HSD 415	62
● DVD-Player	62
Front panel	62
Back panel	62
Remote Control	63
QUICK START	64
● Remote control	64
● Battery advise	64
CONNECTIONS	65
● Connecting to a TV	65
● Connecting to an Audio-System	66
● Connecting to the 5.1 Audio-System (not available on HSD 310)	67
PLAYBACK	68
● Remote control functions	68
● Buttons description	69
● Basic playback	70
FUNCTIONS	71
● Special functions	71
● Karaoke (only model HSD 401 plus)	71
● Special DVD functions	71
● Multimedia playback	72
● JPEG Picture Display	72
● Function setup	73
DISC INFORMATION	75
● Recommendations	75
NOTES ON SERVICE	76
● Troubleshooting	76
● Specification	77



FEATURES

- File formats compatibility list:
 - Video: MPEG1(SVCD, VCD)/MPEG2(DVD)/MPEG4
 - Audio: WMA/CD/MP3
 - JPEG Picture CD
 - Kodak Picture CD
- Media formats compatibility list:
 - CD-RW, DVD-R(W), DVD+R(W)
- Integrated surround-decoder (Dolby Digital/MPEG 5.1)
 - with 5.1 analog outputs (not on model HSD 310)
- High quality picture provided YUV connection with Progressive Scan ability
- PAL/NTSC/Multi
- Wide screen and Pan&Scan options
 - 4:3 Pan & Scan / 4:3 Letterbox for standart TV set
 - 16:9-widescreen
- Full DVD functionality
- Karaoke (only on model HSD 401plus)
- Wide range of connections:
 - Coaxial and optical digital outputs (optical output not on model HSD 310)
 - SCART
 - S-Video
 - VGA (not on model HSD 310)
 - Composite video
 - YUV
 - Dolby Digital/MPEG 5.1 decoded analog output (not on model HSD 310)
 - Analog stereo

NOTES:

- ★ „Dolby“ and Doppel-D-Symbol are the trademarks of Dolby Laboratories.
- ★ Made with licence of Dolby Laboratories.
- © Dolby Laboratories Inc. All rights reserved



SAFETY PRECAUTIONS

Marking of safety

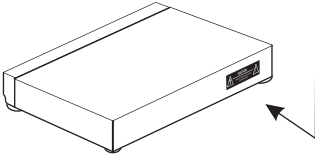

The lightning flash with an arrowhead symbol within an equilateral triangle is intended to alert the user to the presence of uninsulated "dangerous voltage" within the product's enclosure that may be of sufficient magnitude to constitute a risk of electric shock to persons.



The exclamation point within an equilateral triangle is intended to alert the user to the presence of important operating and maintenance (servicing) instructions in the literature accompanying the appliance.

WARNING: DO NOT EXPOSE THIS APPLIANCE TO RAIN OR MOISTURE, DUE TO THE HIGH RISK OF FIRE OR ELECTRIC SHOCK, DO NOT OPEN THE CABINET DANGEROUS HIGH VOLTAGES ARE PRESENT INSIDE THE ENCLOSURE. ONLY QUALIFIED SERVICE PERSONNEL SHOULD ATTEMPT THIS.

CAUTION: This Digital Video Disc Player employs a Laser System. To prevent direct exposure to the laser beam, do not try to open the enclosure. Visible laser radiation when open and interlocks defeated. Use of controls or adjustments or performance of procedures other than those specified herein may result in hazardous radiation exposure.

DO NOT STARE INTO BEAM.

To ensure proper use of this product, please read this owner's manual carefully and retain for future reference. Should the unit require maintenance, contact an authorized service location, or contact us. Only qualified service personnel should remove the cover.

Basic safety requirements

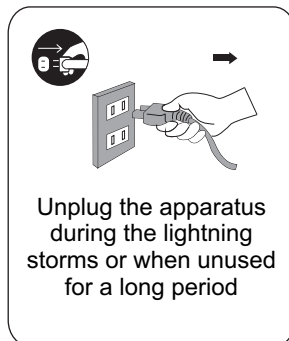
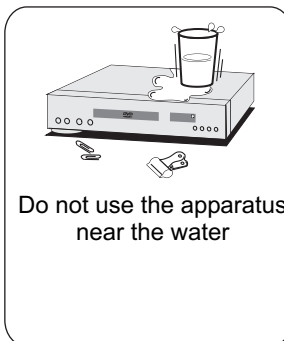

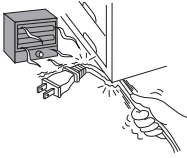

Do not use
defect power cable

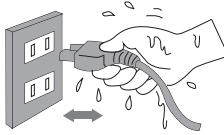

Do not touch
the power cable
with wet hands

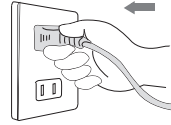

Insert the plug
in the socket firmly

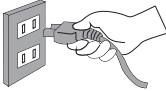

Switch off a player,
if the contacts of the cable
plugwire not completely
in a socket of power point

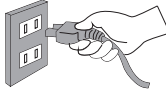

Unplug the apparatus
if the device is wet

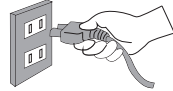

At damage of a player
please disconnect him
from power line



If it is very cold, please
turn on the power for 1min.
Then turn off the power for
1 min. Then you can
turn on and use the unit

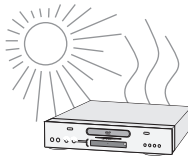

Do not expose the unit
to the direct sunlight
or in subnormal hot place

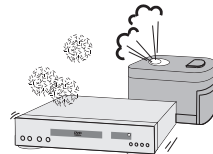

Do not situate this unit
in the moisy place



Place the apparatus on
the stable

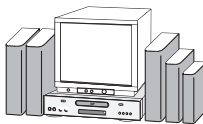

Do not situate the unit
under any heavy object
or in unventilated place

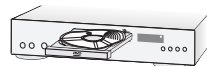

Do not use discs with
scratches and
deformation



ACCESSORIES

Unit of equipment

Open the package of this DVD player, make sure the following accessories attached:

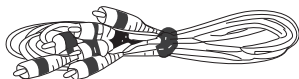

Audio and video cable
(combined Cinch cable)

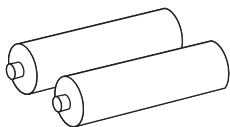

1,5 V batteries

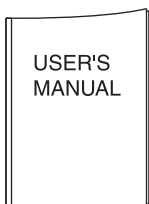

Users's manual

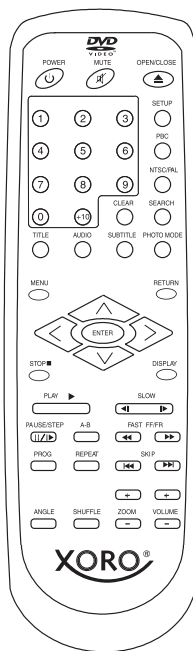

Remote control



OUTPUTS AND CONTROL ELEMENTS HSD 401PLUS

Front panel

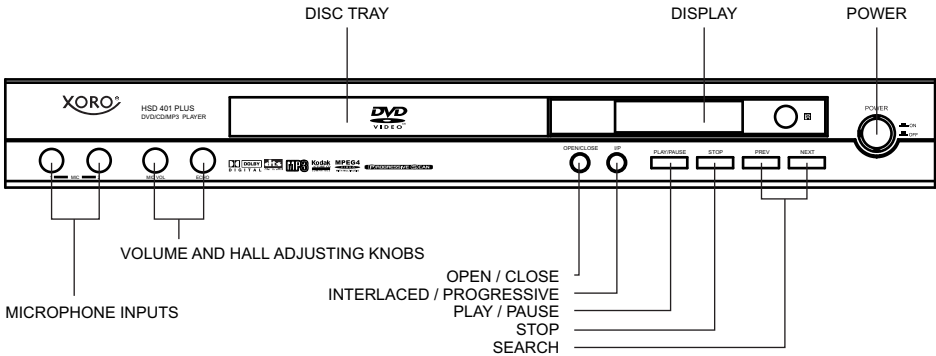

Rear panel

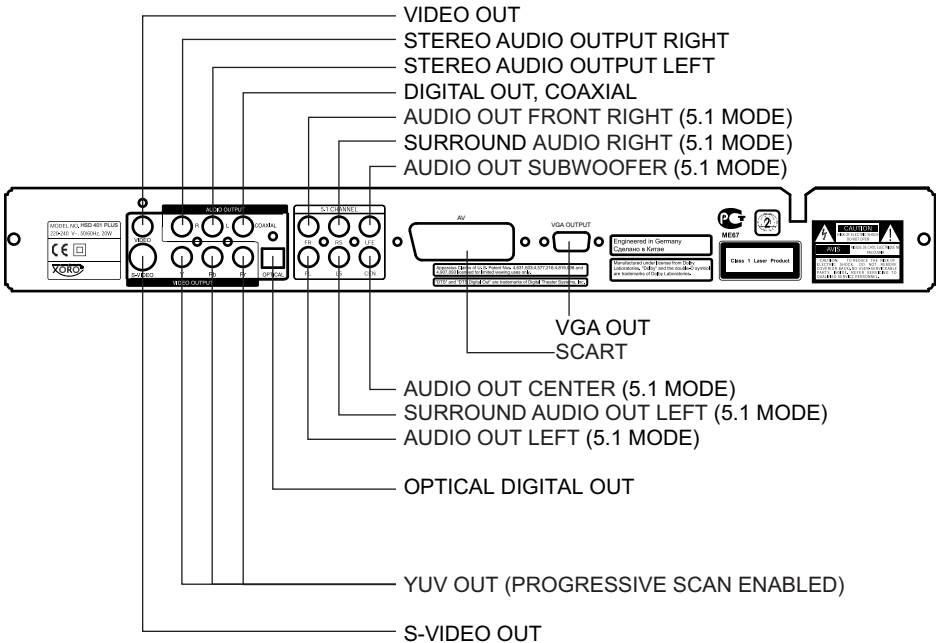



OUTPUTS AND CONTROL ELEMENTS HDS 310 / HSD 415

Front panel

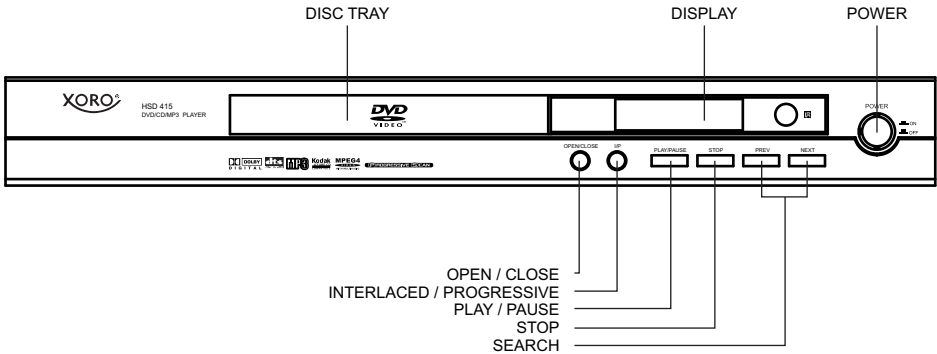

Rear panel

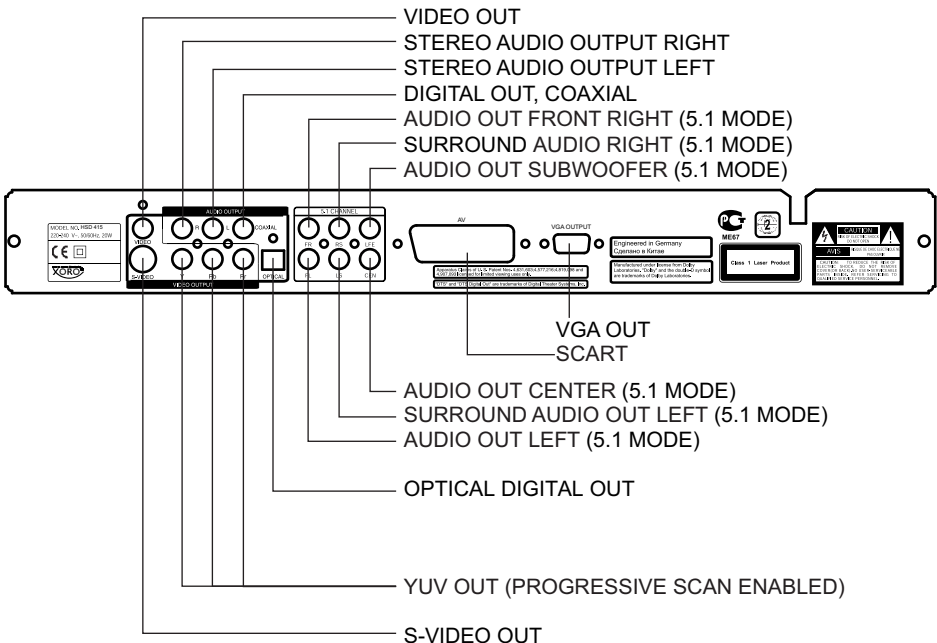

Note: 5.1 connectors not available in model HSD 310.



OUTPUTS AND CONTROL ELEMENTS OF THE DVD-PLAYER

Remote control

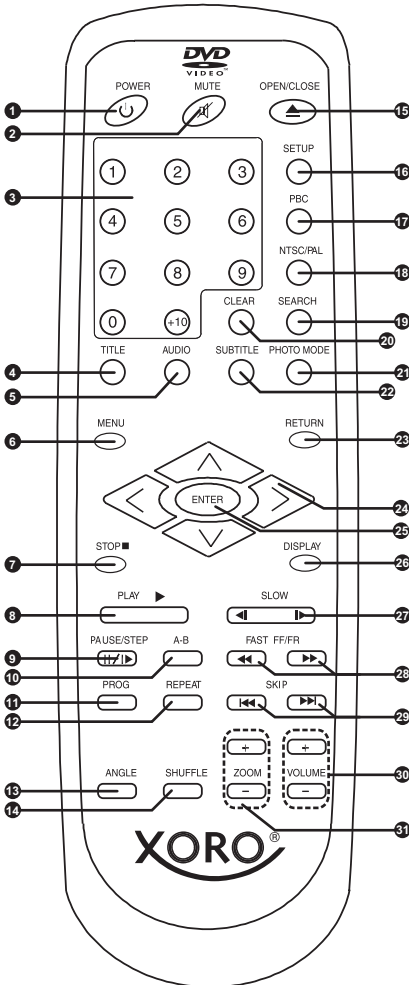

- | | |
|---------------------------------|--|
| 1. POWER | Stand by on/off |
| 2. MUTE | Sound off |
| 3. NUMBER PAD | Number buttons |
| 4. TITLE | Title menu |
| 5. AUDIO | Audiotrack select |
| 6. MENU | Access to the menu of DVD |
| 7. STOP | Stop the playback of disc |
| 8. PLAY | Start the playback of disc |
| 9. PAUSE/STEP | Pause the playback of disc |
| 10. A-B | Select and repeat segment from A point to B |
| 11. PROG | Programm |
| 12. REPEAT | Repeat of the chapter / title / folder |
| 13. ANGLE | Camera angle selection |
| 14. SHUFFLE | Random play |
| 15. OPEN/CLOSE | Open/close the tray |
| 16. SETUP | DVD-player set up menu |
| 17. PBC | Playback control (VCD) |
| 18. NTSC/PAL | TV standart selection |
| 19. SEARCH | Search on time or number of a track |
| 20. CLEAR | Clear number pad input |
| 21. PHOTO MODE | Picture show mode for JPEG, Kodak picture CD |
| 22. SUBTITLE | Subtitle select |
| 23. RETURN | Back in the menu or to PBC |
| 24. LEFT, RIGHT UP, DOWN | Moves the cursor to the selected item |
| 25. ENTER | Choose of selected item |
| 26. DISPLAY | On-screnn display |
| 27. SLOW | Slow play |
| 28. FAST FF/FR | Fast play |
| 29. SKIP | Skip the chapter |
| 30. VOL +/-: | Volume control |
| 31. ZOOM | To zoom video and pictures |



QUICK START REMOTE CONTROL

Remote control

Insert the batteries in the remote control

1 Open the cover

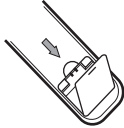

2 Put the batteries

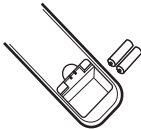

Make sure to match - and +

3 Close the cover

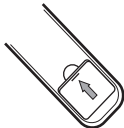

NOTES:

- Direct the remote control at the infrared receiver (IR) of the player
- Do not drop the remote control
- Do not spill water or put anything wet on it
- Do not disassemble the remote control

Operating instructions

Point the remote control at the IR

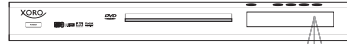

Within about 7 m with angle about 30 grade in the both direction



Remote control

NOTES:

Do not expose the IR of the dvd player to a strong light source or direct sunlight.

NOTES ON BATTERIES:

Improper use may cause battery leakage and corrosion. Please follow the instructions below:

- Do not insert the batteries in the wrong direction
- Do not use different types of batteries together
- If you do not use the remote control for a long time, remove the batteries
- If the remote control operates not correctly, replace the batteries
- If battery leakage occurs, wipe the battery liquid from the battery compartment, then insert new batteries
- Make sure that the used batteries are disposed properly according to you local regulations.



CONNECTIONS

Connecting to a TV

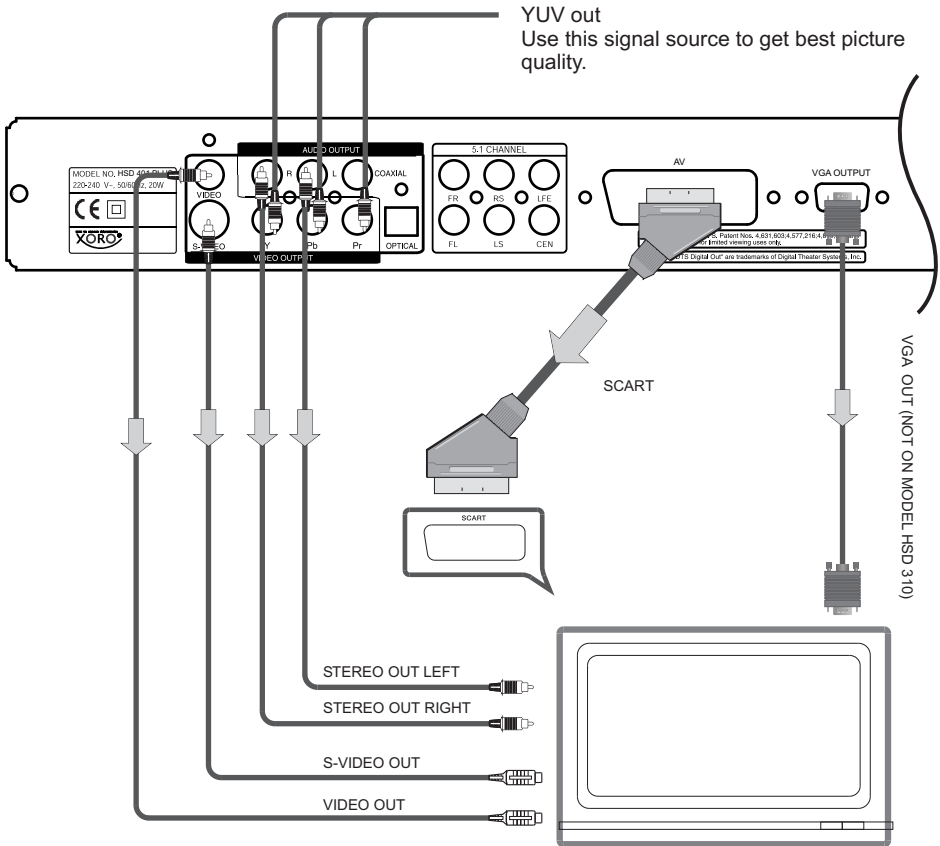

English

NOTES:

- Turn off all devices before connecting.
- Select CVBS, S-Video, SCART, YUV or VGA output according to different TVs.
- Follow the sketch above to connect the devices with selected output.
- Refer to setup instructions on the page 18, 19.



CONNECTIONS

Connecting to an audio system

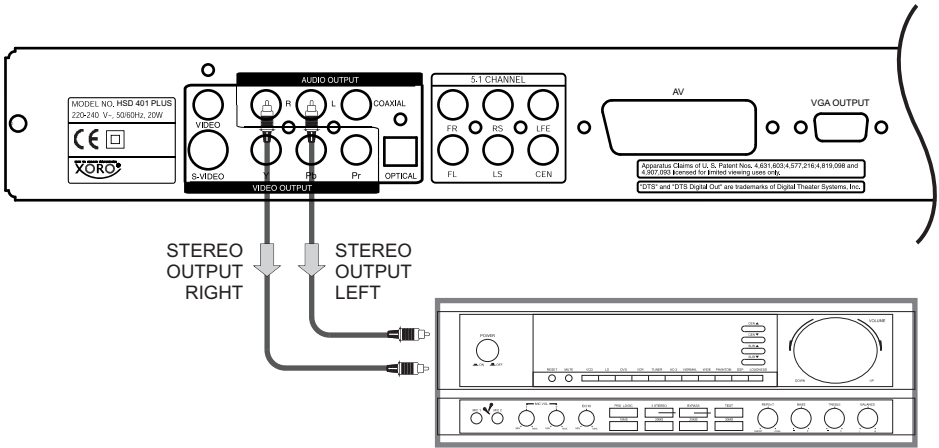

English

NOTES:

- Please refer to the manual of the receiver or amplifier
- Turn off the power of all devices before connecting
- The player output has a wide dynamic range. Be sure to adjust the volume of receiver to a moderate level. Otherwise, a sudden high volume may damage the speakers
- Turn off the audio system before you connect or disconnect power cord of the player
- Refer to the setup instructions of the player on the pages 19



CONNECTIONS

Connecting to the amplifier with 5.1 channel sound output*

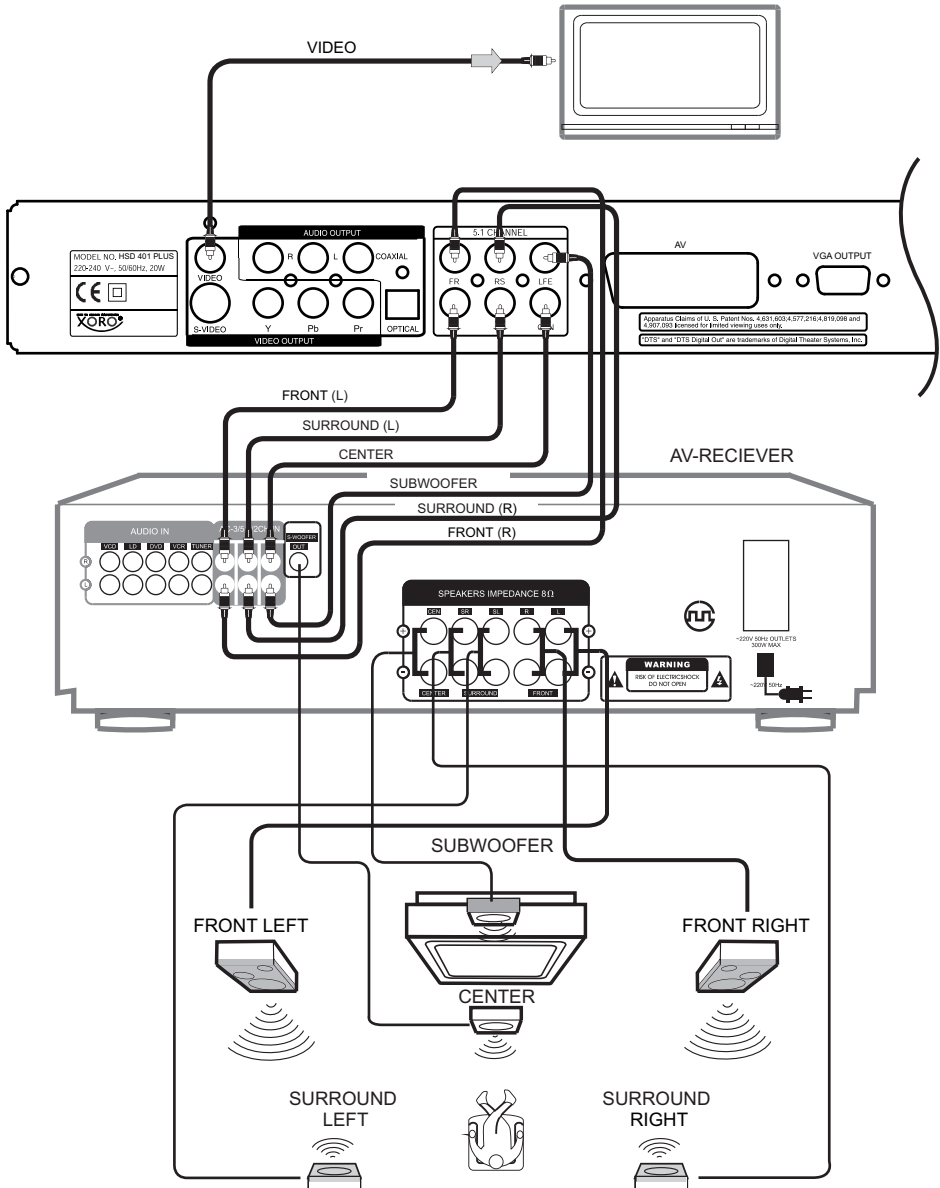

English

See notes on the page 12, see setup instructions on the page 19
* 5.1 connection not available on model HSD 310



PLAYBACK

Remote control functions

Direction buttons (↑↓←→) and ENTER

Press the Direction buttons to move the cursor to the selected item, then press the **ENTER**

● CLEAR button

Press this button to clear the input digits (displays on the screen) when programming

● PLAY button

This button starts the playback of the CD/DVD

● Number pad

When playing a VCD/SVCD disc, press the number buttons directly to play your favorite track in PBC off status. If the track number is from 1 to 9, you can directly press the number. If the track number is more than 9, you should use button **10+** and the other number buttons together to select the track, for example: for track 25, first, press the **10+** button twice, then press button **5**.

● STOP button

When playing a DVD disc, press this button the first time during playback, the DVD player memorizes the location where you stopped (press **PLAY** to resume playback from the memorized point). Press this button again to stop the disc (then press **PLAY** to start playing from the beginning of the disc).

● RETURN button

For SVCD or VCD2.0 discs, in PBC status, press this button to return to the playback

● PAUSE/STEP button

Press this button for the first time to pause, then each time you press the **PAUSE/STEP** button, the picture advances one frame. For CD, MPEG4 or MP3, this button is only used for **PAUSE** function.

● FAST (<</>>) buttons

Press the **FAST** button during playback, the playback speed changes. Press **PLAY** to resume the normal speed.

● SLOW button

For slow motion. Press this button repeatedly to change the speed. Press **PLAY** to resume the normal speed.



PLAYBACK

Buttons description

● SKIP buttons

Press SKIP to select the next (previous) chapter (for DVD) or track (for SVCD / VCD / CD / MP3 / MPEG4).
(▶▶|) or (|◀◀).

● ZOOM button

Press the ZOOM button during normal playback to zoom a picture, press the Direction buttons to shift the zoom point. Press this button repeatedly to change the magnification levels.

For JPG files, this button should be used with the FAST buttons to fulfill the zoom Function.

● A-B button

Press the A-B button at the beginning of the segment (point A) you want to play repeatedly, then press it again at the end of the segment (point B), the selected segment can be played Repeatedly. Press it the third time to resume normal playback. For MP3 and JPG files, the button is invalid.

● REPEAT button

For DVD discs, press this button to repeat the title or chapter. For VCD or SVCD discs, press this button to repeat the track.

● SEARCH button

Use to go to the needed position of the disc.

● DISPLAY button

Press this button to display the current playback information on the screen.

● PROG button

For VCD or SVCD discs, press this button, the program menu appears on the screen, press the number buttons to enter the chapter / track number you want to program, the programmed tracks can be up to 99 tracks. Press the **PLAY** to start the programmed playback. Press the **CLEAR** button to cancel the wrong input digits. If you want to cancel program, then press the **PROG** button again.

● I/P button

I/P button is used for switching between Progressive Scan and Interlaced display. If the player is switched to Progressive Scan by pressing I/P button, the DVD player switches to YUV or VGA output and to Progressive Scan mode. By pressing I/P key in Progressive Scan mode, the player deactivates Progressive Scan playback and switches to the output previously used.

You should use the I/P button only if the DVD player is connected via YUV or VGA to a device.

If the I/P button is pressed by accident and you do not get a picture, press the I/P key until you get a picture on your screen.



PLAYBACK

Basic playback

1. Press the **POWER** button on the front panel of the player
2. Press the **OPEN/CLOSE** button on the player or on the remote control
3. Put a compatible disc in the opened tray
4. Press **OPEN/CLOSE** button again.

ATTENTION: Do not push the tray with the hand. You may damage it!

5. Use playback control buttons on the player to **SKIP** or **PAUSE**. Or use the buttons of the remote control to operate:

- SKIP
- SEARCH
- SLOW MOTION
- ZOOM

See more about on the pages 17, 18, 19, 20.

NOTES:

- Do not move the DVD player during playback
- If you do not use the player for a long time unplug it
- For the PBC for VCD please refer to the following pages



FUNCTIONS

Special functions

● PBC-Playback

For VCD 2.0 or SVCD discs, press this button to set the PBC functions.

In the PBC display of the SVCD / VCD2.0, if the **PLAY** button is pressed, the Player will enter PBC playback status. If the PBC is turned off, the disc will be played as VCD1.0/1.1.

When PBC is set to ON, the menu appears on the screen, press the number buttons to select and play the track you want.

● VOLUME Control

You can change the volume level.

● MUTE

To turn off the sound, press this button. One more time press the button to turn on the sound.

Karaoke*

1. Connect the microphone to MIC jack. Turn on the microphone.
2. Adjust volume with the know VOLUME
3. Select the track

When playing a Karaoke disc, press the number buttons to select the track you want to play, then you can start the Karaoke

* Karaoke only available on model HSD401plus

Special DVD-functions

● MENU button

Press this button to enter the DVD menu. (If it is supported by the discs.)

● TITLE button

For DVD discs, press this button to enter the title menu, then press the **Direction** buttons and **PLAY** button to select and play. (If it is supported by the discs.)

● AUDIO button

This button allows the user to select a preferred audio language from those included on the disc. This button also support language selection for the SVCD discs.

● ANGLE button

Press this button to change the camera angle of the scene you are watching if the scene was recorded from multiple angles.

● SUBTITLE button

This button allows the user to select a preferred language for the subtitle and messages from those included on the disc.



FUNCTIONS

Multimedia playback (MP3 / MPEG4 / JPEG etc.)

● Smart Navi: Playback menu

When a MP3 or MPEG4 disc is being played, the playback menu will appear on the screen, as shown in the following figure:

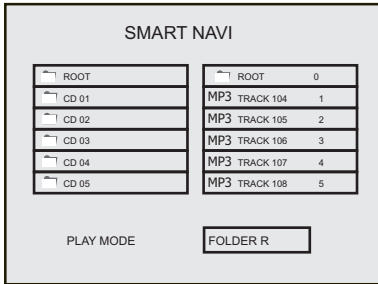

- Use the **↑ / ↓** button to select the previous / next track. Press the **SKIP** buttons to turn the page up / down. Move the cursor to the track you want to play, then press the **PLAY** button to play the track.
- You can use the Number buttons to select and play the track directly.
- Use the **← / →** button to switch between the selection of the playback mode and playback menu. Move the cursor to the playback mode, then press the **↑ / ↓** button to select the playback mode.
- If you choose to cancel the menu in the SMART NAVI (navigation) item in the setup menu, the playback menu will not be displayed on the screen, and the Player will playback the tracks sequentially.

JPEG Picture Display

The playback menu of the JPEG picture is similar to MP3 / MPEG4 playback menu. Please refer to MP3 / MPEG4 Playback.

- When playing the JPG pictures, press the direction buttons to rotate the picture.

WHAT IS MPEG4?

MPEG-4 is an ISO/IEC standard developed by MPEG (Moving Picture Experts Group), the committee that also developed the Emmy Award winning standards known as MPEG-1 and MPEG-2 (DVD adopts this standard for video application).

MPEG-4 is a very efficient digital video compression standard, which can compress MPEG-2 video into about one eighth of its original size. Most video stream medias base on this technology, such as DivX, WMV, and so on. So MPEG-4 is the most popular digital video technology in the video distribution and communication.

HOW TO PLAYBACK YOUR MPEG4 CD?

1. Press **OPEN/CLOSE**. Place the CD on the disc tray, and press it again to close the tray.
2. Select a folder or an AV file contained on the CD. Use the direction keys to navigate among the items.
3. Press **PLAY**. The player will start the playback.

HOW TO CREATE YOUR MPEG-4 DISC?

1. Download the files from Internet or rip from the other video source using the PC/MAC application, and save the MPEG-4 files as many formats, like *.avi, *.asf etc.
2. Place the blank CD-R/-RW disc into PC CD-R/-RW driver or other record devices.
3. Burn your favorite MPEG-4 files into your CD-R/-RW using the CD burn application, like the Nero Burning , Clone CD, etc.
4. Finalize your disc and eject the CD.

DIVX SUBTITLES

Your Xoro DVD player can display DivX subtitles. It supports .sub, .srt and .smi.

Before you start playback, the subtitle file must be activated. As soon as the player has read the CD index, a menu shows the movie and the subtitle files. The subtitle file is displayed with a question mark, this is normal. Navigate with the arrow keys to the desired subtitle file and press **SUBTITLE** key on the remote control. The player prompts "DivX subtitle selected". Now, you can start the movie and the subtitles will be displayed. You can deactivate the subtitle display simply by pressing **SUBTITLE** key on the remote control.

Note:

Subtitles are not supported in all languages. At the time this manual has been printed, English, german and polish subtitles are supported. It may be possible that other languages are supported, too due to an improved firmware. Also, other subtitle formats may be supported by newer firmware.

Please note that some programs create subtitles which are not compatible with this player. This is normal and is no defect of the player.



FUNCTIONS

Function Setup

Press the **SETUP** button, the following figure will appear on the screen:

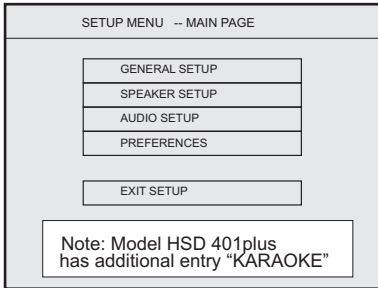

1. Press the **SETUP** menu to enter the setup menu.
2. Use the $\uparrow\downarrow$ button to choose the menu item you want to change, then press **ENTER** to confirm it.
3. Use the \rightarrow button to move the high light icon to the right side item.
4. Use the $\uparrow\downarrow$ button to change the current setup, then press the **ENTER** button to confirm it.
5. Use the \leftarrow button to return to the left side item.
6. Press the **SETUP** button to quit the setup menu.

GENERAL PAGE

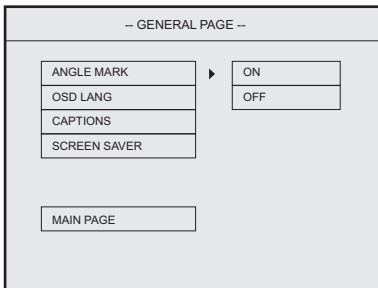

- **ANGLE MARK:**
ON, OFF
- **OSD LANG (language)**
Select your preferred language for OSD display and messages
- **CAPTIONS**
ON, OFF
- **SCREEN SAVER**
ON, OFF

SPEAKER SETUP PAGE

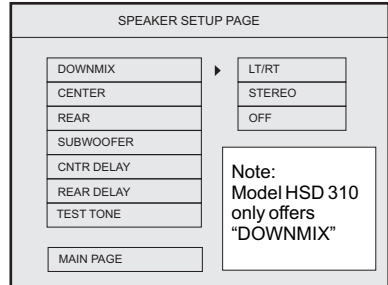

- **DOWNMIX**
LT/RT, STEREO, OFF
- **CENTER**
ON, OFF
- **REAR**
ON, OFF
- **SUBWOOFER**
ON, OFF
- **CNTR DELAY**
The delaying time can be setup as: 0, 1, 2, 3, 4 and 5 MS (milliseconds).
- **REAR DELAY**
The delaying time can be setup as: 0, 3, 6, 9, 12 and 15 MS (milliseconds).

AUDIO SETUP PAGE

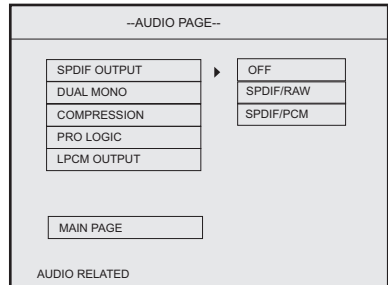

- **SPDIF OUTPUT**
OFF, SPDIF/RAW/SPDIF/PCM
- **DUAL MONO**
STEREO, L-MONO, R-MONO, MIX-MONO
- **COMPRESSION**
OFF, 1/8, 2/8, 3/8, 4/8, 5/8, 6/8, 7/8, FULL
- **PRO LOGIC**
OFF, ON, AUTO
- **LPCM OUTPUT**
LPCM 48K, LPCM 96K

English



FUNCTIONS

Function Setup

PREFERENCES PAGE

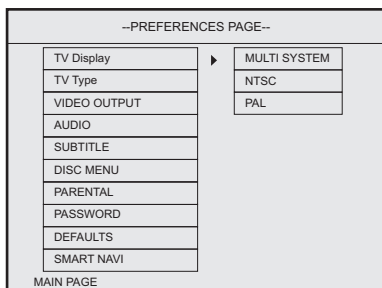

The preferences setup should be done in completely stop status.

- **TV DISPLAY**
NORMAL/PS
- **TV TYPE**
MULTI.SYTEM, NTSC, PAL
- **VIDEO OUTPUT**
S-VIDEO, RGB, VGA (not HSD 310), YCBCR,YPBPR
- **AUDIO (audio language)**
Here you can select the language of the audio stream (if supported by the disc)
- **SUBTITLE Language**
Here you can select the language of the subtitles (if supported by the disc)
- **DISC MENU**
Here you can select the language of the disc menu (If it is supported by the disc)
- **PARENTAL**
1 G, 2, 3 PG, 4 PG 13, 5, 6 PG-R, 7 NC-17, 8 ADULT, NO-PARENTAL

If you want to change the setup of the item, you should enter the password. About the password, please refer to **PASSWORD**. The default password is 3308
- **DEFAULTS:**
Here you can restore the factory default settings
- **SMART NAVI**
Here you can select if the smartrnavi is displayed with or without menu in filemode.

PASSWORD

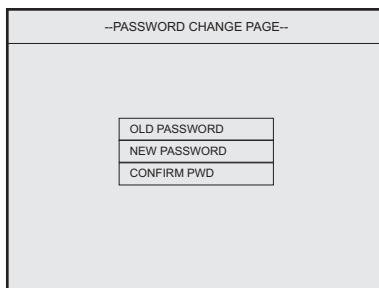

When you select to change the password, **PASSWORD CHANGE PAGE** appears on the screen.

The first line is **OLD PASSWORD**.
The second line is **NEW PASSWORD**.
The third line is **CONFIRM PWD** (password).

When the new password is entered for two times, it means you have successively changed the password.

The factory code (password) is 3308.



DISC INFORMATION

Handling precautions

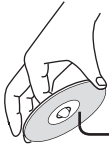

- Do not touch the playback side of the disc.

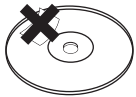

- Do not attach paper or tape to discs.

To clean discs

- Fingerprints and dust on the disc may cause picture and sound deterioration. Wipe the disc from the center outwards with a soft cloth. Always keep the disc clean.



- If you cannot wipe off the dust with a soft cloth, wipe the disc lightly with a slightly moistened soft cloth and finish with a dry cloth.
- Do not use any type of solvent such as thinner, benzene, commercially available cleaners or antistatic spray for vinyl Lps. It may damage the disc.

On storing discs

- Do not store discs in a place subject to direct sunlight or near heat sources.
- Do not store discs in places subject to moisture and dust such as a bathroom or near a humidifier. Store discs vertically in a case. Stacking discs or placing objects on their case may warp the discs.

Copyright notes

- It is forbidden by law to copy, broadcast, show on cable, play in public, and rent copyrighted material without permission.
- DVD video discs are copy protected, and any recordings made from these discs will be distorted.

About this manual

- This user's manual explains the basic instruction of this DVD player. Some DVD video discs are produced in a manner that allows specific or limited operation during playback. As such, the DVD player may not respond to all operating commands.

Discs that can be played

Disc mark	Contents	CD-Size	Maximum playback time
DVD	Audio + Video	12 cm	Approximately 2 hours (single sided single) Approximately 4 hours (single sided double) Approximately 4 hours (double sided single) Approximately 4 hours (double sided double)
SVCD	Audio + Video	12 cm	Approximately 45 minutes
Video CD	Audio + Video	12 cm	Approximately 74 minutes
Audio CD	Audio	12 cm	Approximately 74 minutes
MP3	Audio	12 cm	



NOTES ON SERVICE

Check the following guide for the possible cause of a problem before contacting service.
Technical Support of Xoro/MAS: Tel.: 040/77 11 09 17, Internet: www.xoro.de/support.htm

Symptoms	Cause	Correction
No power	The power plug is disconnected	Connect the power plug into the wall outlet
No picture	The TV is not set to receive DVD signal output	Select the appropriate video input mode on the TV so the picture from the DVD player appears on the TV screen
	The video cable is not connected securely	Connect the video cable into the jacks securely
	The DVD video mode is not matched with the TV	Refer to Connecting to a TV (page 10)
No sound	The audio cable is not connected securely	Connect the audio cable into the jacks
	The power of the equipment connected with the audio cable is turned off	Turn on the equipment connected with the audio cable
	The setting of output sound type is not correct.	Set the audio setting correctly.
The playback picture has occasional	The disc is dirty.	Eject the discs and clean it.
	It is in fast forward or fast reverse playback.	Sometimes a small amount of picture distortion may appear. This is not malfunction.
Brightness is unstable or noises are produced on playback pictures	The copy protection's effect.	Connect the DVD player to the TV directly.
The DVD player does not start playback	No disc is inserted.	Insert a disc.
	An unplayback disc is inserted.	Check the disc type and color system.
	The disc is placed upside down.	Place the disc with the playback side down.
	The disc is not placed within the guide.	Place the disc on the disc tray correctly inside the guide.
	A menu is on the TV screen.	Clean the disc.
	The parental lock function is set.	Press the SETUP button to turn off the menu screen. Cancel the parental lock function or change the parental.
Buttons do not work	Power supply fluctuations or other abnormalities such as static electricity may interrupt correct	Turn the power on or off with the POWER button. Or disconnect the power plug and insert it into the wall outlet again.
The remote control does not work properly	The remote control is not pointed at the remote sensor of the DVD player	Point the remote control at the remote sensor of the DVD player
	The remote control is too far from the DVD player	Operate the remote control within about 7 m
	The batteries in the remote control are exhausted	Replace the batteries with new ones



SPECIFICATIONS

DVD-Player

Power supply	95-240V AC,50/60Hz
Power consumption	20 W
Weight	4 +0.5kg
External dimensions	430 x 50 x 320mm (W/H/D)
Signal system	PAL /NTSC
Laser	Semiconductor laser, wavelength 650 nm,780nm
Frequency range	+3dB (20Hz - 20kHz)
Signal-to noise ratio	>90 dB
Audio dynamic range	>80 dB
Operating conditions	Temperature 0 - 40° C Operation status Horizontal

Outputs

Composite Video output	1.0 +0,2Vp-p, 75Om
Audio output (analog audio)	2.0 +0.2V (rms)

Supplied Accessories

Audio/Video cable (3wire) 1

Remote control 1

Batteries2

User manual 1

- Designs and specifications are subject to change without notice.



XORO by MAS Elektronik AG

Blohmstrasse 16/20
21079 Hamburg, Germany
Tel.: +49 (040) 77 11 09 17
Fax: +49 (040) 76 73 35 15
xoro@mas.de
www.xoro.de

Free Manuals Download Website

<http://myh66.com>

<http://usermanuals.us>

<http://www.somanuals.com>

<http://www.4manuals.cc>

<http://www.manual-lib.com>

<http://www.404manual.com>

<http://www.luxmanual.com>

<http://aubethermostatmanual.com>

Golf course search by state

<http://golfingnear.com>

Email search by domain

<http://emailbydomain.com>

Auto manuals search

<http://auto.somanuals.com>

TV manuals search

<http://tv.somanuals.com>