

OWNER'S MANUAL

LS5000DVD

AM/FM Stereo Receiver with DVD/CD Player

Designed for In-Wall Installation of Recreational Vehicles, Motor Homes and Mobile Housings

Manufactured under license from Dolby Laboratories.
"Dolby" and the double-D symbol are trademarks of
Dolby Laboratories. Confidential Unpublished works.
© 1992-1997 Dolby Laboratories Inc. All rights reserved.

**LINEAR
SERIES**[®]
A Registered Trademark of Magnadyne Corporation

INTRODUCTION

Please take the time to read all of the information in this manual. Familiarity with installation and operation procedures will help you obtain the best possible performance from your new AM/FM Stereo Receiver with DVD/CD Player.

WARNING! To prevent fire or electrical shock hazard, do not expose this product to moisture, or remove cover or bottom screws. No user-serviceable parts inside. Refer servicing to qualified personnel.

CONTROLS AND FUNCTIONS

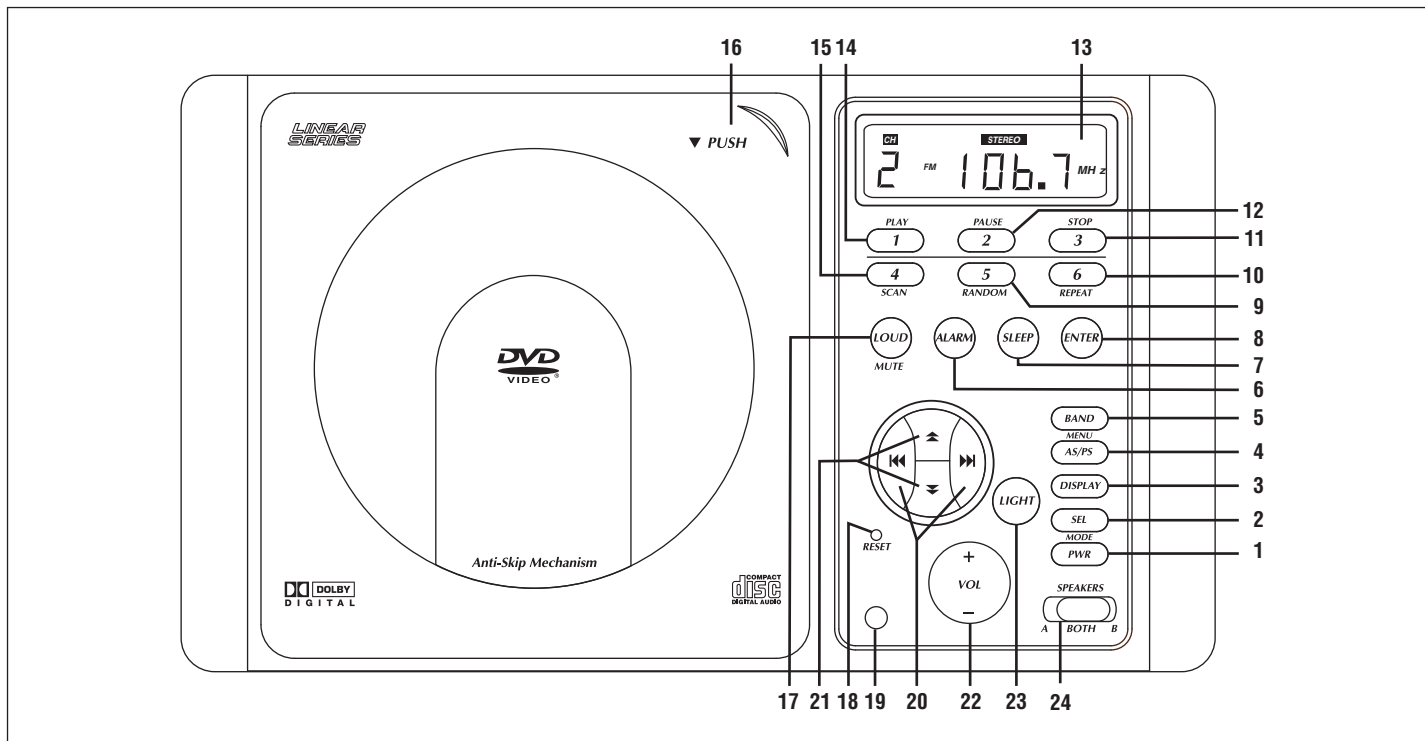

CONTROLS AND FUNCTIONS

- 1. Power / Mode Button (PWR)**
Press and hold to turn the unit On/Off.
Momentarily press to switch modes from Radio to AUX IN to DVD.
- 2. Select Button (SEL)**
Selects the audio mode in the following order:
Volume, Bass, Treble and Balance.
- 3. Display Button**
Press at anytime to display the clock.
- 4. AS/PS / Menu Button**
Radio Mode: Automatic memory storing and preset scanning.
DVD Mode: Enters DVD Menu. Please see "DVD Operation".
- 5. Band**
Selects the band in the following order: FM1, FM2, FM3, AM1, AM2.
- 6. Alarm Button**
Sets the alarm. Please see "Alarm Operation".
- 7. Sleep Button**
Sets the sleep timer. Please see "Setting the Sleep Timer".
- 8. Enter Button**
Radio Mode: Please see "Radio Operation".
DVD Mode: Please see "DVD Operation".
- 9. Preset #5 / Random Button**
Radio Mode: Recalls memorized radio station #5.
DVD Mode: Plays the disc tracks in a random order.
- 10. Preset #6 / Repeat Button**
Radio Mode: Recalls memorized radio station #6.
DVD Mode: Repeats all tracks or a single track.
- 11. Preset #3 / Stop Button**
Radio Mode: Recalls memorized radio station #3.
DVD Mode: Stops disc play.
- 12. Preset #2 / Pause Button**
Radio Mode: Recalls memorized radio station #2.
DVD Mode: Pauses disc play.
- 13. Display Area**
Displays all digital messages.
- 14. Preset #1 / Play Button**
Radio Mode: Recalls memorized radio station #1.
DVD Mode: Starts disc play.
- 15. Preset #4 / Scan Button**
Radio Mode: Recalls memorized radio station #4.
DVD Mode: Plays the first 10 seconds of each track.
- 16. Disc Door**
Allows you to insert a disc.
- 17. Mute / Loud Button**
Short press mutes the audio level.
Long press enhances the high and low frequency sound quality.
- 18. Reset Button**
Resets the Display Area. Please see "General Operations".
- 19. Infrared Sensor**
Receives the signals from the remote control.
- 20. Skip Up / Skip Down Buttons**
Radio Mode: Searches the tuned frequency up/down.
DVD Mode: Skips to the next lower/higher track on the disc.
- 21. Fast Forward / Fast Reverse Buttons**
Radio Mode: Changes the tuned frequency up/down.
DVD Mode: Fast forward/reverse through a track.
- 22. Volume Button**
Increases or decreases the volume.
- 23. Light Button**
Turns the backlight on briefly when the unit is powered off.
- 24. Speakers Switch**
Selects the different sets of speakers installed.

REMOTE CONTROL FUNCTIONS

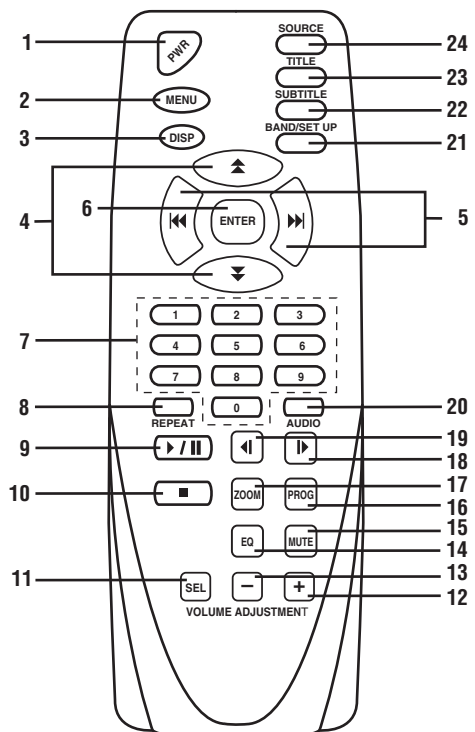

1. Power / Mode Button (PWR)
2. Menu
3. Display Button (DISP)
4. Fast Forward / Fast Reverse Buttons
5. Skip Up / Skip Down Buttons
6. Enter Button
7. Preset / Numerical Buttons
8. Repeat Button
9. Play / Pause Button
10. Stop Button
11. Select Button (SEL)
12. Increase Volume Button
13. Decrease Volume Button
14. Loudness Button (EQ)
15. Mute Button
16. Program Button
17. Zoom Button
18. Slow Forward Button
19. Slow Reverse Button
20. Audio Button
21. Band / Set Up Button
22. Subtitle Button
23. Title Button
24. Source Button

Preparing the Remote Control

- Slide open the battery compartment cover.
- Insert two AAA batteries making sure that the positive and negative terminals are oriented correctly.
- Close the battery compartment cover.
- Point the remote control at the unit's infrared sensor to operate the player.

GENERAL OPERATIONS

Power On/Off

Press and hold the **Power / Mode** button to turn the unit On or Off.

Auxiliary Input Mode

To access auxiliary devices, press the **Power / Mode** button momentarily until "AUX IN" appears in the display.

DVD Mode

To play a CD or DVD, press the **Power / Mode** button momentarily until "DVD ON" appears in the display.

Reset Display

Activate the **Reset** button with either a ballpoint pen tip or paper clip for the following reasons:

- After initial installation of the unit is completed.
- If the function buttons do not operate.
- Error symbol on the display.

Speaker Switch

- To play the "A" set of speakers, slide the switch to the "A" position.
- To play the "B" set of speakers, slide the switch to the "B" position.
- To play both the "A" and "B" speakers simultaneously, slide the switch to the "BOTH" (center) position.

RADIO OPERATION

Radio Operation

1. Press and hold the **Power / Mode** button to turn the unit On.
2. Press the **Power / Mode** button momentarily until the Radio Mode is selected.
3. Press the **Band** button to select either the AM1, AM2, FM1, FM2 or FM3 radio band.
4. Manually tune in the desired radio station by pressing the **Fast Forward / Fast Reverse** button and Auto search to the next station by pressing the **Skip Up / Skip Down** button.
5. Adjust the volume as desired.

FM Stereo Operation

The unit will automatically switch from **FM Mono** to **FM Stereo** when the signal strength increases to a stereo level. If the stereo signal should become weak, the unit will switch back to mono. FM Stereo reception is indicated by the word "STEREO" in the display.

Memorizing Radio Stations (Presets)

1. Press the **Band** button to select either the AM1, AM2, FM1, FM2 or FM3 radio band.
2. Tune in the desired radio station.
3. Press and hold anyone of the six **Preset** buttons to memorize the station until the Preset Number is displayed.

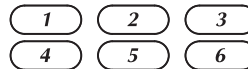

The currently displayed radio station is now memorized. Each band can store up to six preset stations.



RADIO OPERATION

Automatically Store Stations

Select a Band (if needed). Press and hold the **AS/PS** button for more than three seconds. The tuner will search for the six strongest stations and store them in memory. The new stations replace stations that were already stored in the current band.

Preset Scan

Select a Band (if needed). Press the AS/PS button. The tuner scans for preset stations stored in the current band and pauses for five seconds at each station. When a desired station is reached, press the AS/PS button again to stop scanning.

SETTING THE CLOCK

1. Press and hold the **Power / Mode** button to turn the unit On.
2. Press and hold the **Display** button. The clock will start flashing, indicating the unit is in the clock setting mode.
3. Within 5 seconds, continuously press the **Fast Reverse** button until the desired Hour is set. To quickly scroll through the Hours, press and hold the same button. Note the AM or PM indicator in the display.
4. Continuously press the **Fast Forward** button until the desired Minute is set. To quickly scroll through the Minutes, press and hold the same button.
5. The unit will exit the clock setting mode if either button is not pressed within 5 seconds.



Note: To display the clock while in Radio, CD/DVD or AUX mode, press the **Display** button.

SOUND CONTROLS

Audio Mode Selection

Select the desired audio mode by pressing the **SEL** button. The modes will be displayed the following order: Volume, Bass, Treble and Balance.

Volume

Increase the volume by pressing the + button. Decrease the volume by pressing the - button.

Bass

Press **SEL** button two times. Increase the Bass by pressing the + button. Decrease the Bass by pressing the - button.

Treble

Press **SEL** button three times. Increase the Treble by pressing the + button. Decrease the Treble by pressing the - button.

Balance

Press **SEL** button four times. Adjust the Balance by pressing either the + button or the - button.
 R10 = Right speakers only
 00 = Equal sound right and left
 L10 = Left speakers only

Mute

Press and release the **Mute / Loud** button once to mute the audio level. "MUTE" will appear in the display.

Loud

Press and hold the **Mute / Loud** button to enhance the high and low frequency sound quality. "LOUD" will appear in the display.

ALARM OPERATION

The alarm is used to power the unit On at a set time, and to power the unit Off at another set time.

Setting the Alarm Timer

1. Press and hold the **Alarm** button until the display shows "ON A 0:00".
2. Press the **Fast Reverse** button to adjust the Hours, then press the **Fast Forward** button to adjust the Minutes.
3. When the desired time is set, press the **Enter** button to confirm the "Alarm On" time, and the display will show "OFF A 0:00".
4. Repeat the same procedures above to set the "Alarm Off" time and press the **Enter** button to confirm the setting. The display will then show "ALARM", indicating the Alarm Function is activated.
5. To activate the Alarm Timer, power off the unit by pressing and holding the **Power / Mode** button.

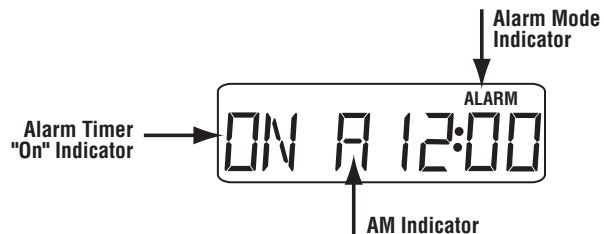

Switching the Alarm Function On/Off

1. Press the **Alarm** button, then press the **Enter** button at anytime to turn the Alarm "On" or "Off".
2. If "ALARM" is showing in the display, the Alarm Function is activated.

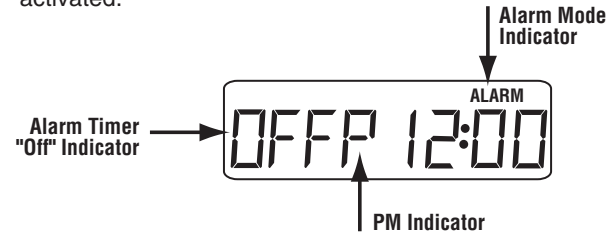

SETTING THE SLEEP TIMER

1. Press and hold the **Sleep** button until "00" is displayed.
2. Within 5 seconds, continuously press the **Fast Forward / Fast Reverse** button until the desired sleep time is set (90, 80, 70, 60, 50, 40, 30, 20, 10 minutes).
3. The unit will exit the Sleep Timer setting mode if either button is not pressed within 5 seconds.



4. After the sleep timer has expired the unit will automatically turn off.
5. To manually turn the sleep timer Off, set the sleep time to "00".

Note: The Sleep Timer function is not programmable into memory. Therefore, it must be reset every time the function is needed.

DISC WARNINGS

Handling a Disc

1. When inserting a disc onto the disc hub, hold it with your thumb, middle finger and index finger. Gently press in the center of the disc until it is securely on the hub.
2. When removing the disc, always pull at the top left edge of the disc until it snaps loose from the hub. There are indentations in the plastic for your fingers at this point.
3. Always keep your discs clean and free from scratches, fingerprints and dirt.

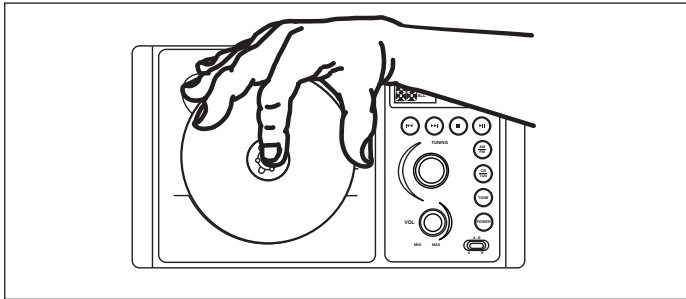

Warning! Never touch the laser eye. Moisture and oils from your fingers can impair proper operation.

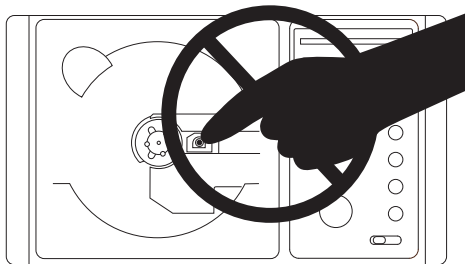

COMPACT DISC OPERATION

General Operations

1. Press and hold the **Power / Mode** button to turn the unit On.
2. Press on the disc door next to the word "PUSH", the door will open slightly. Then gently pull the door fully open.
3. Insert a disc onto the hub until it snaps into place.
4. Close the disc door until it locks into place.
5. Press the **Power / Mode** button until "DVD ON" appears in the display. Disc play will start momentarily after "LOADING" and "CD" appear in the display.

Play Program

The unit can be programmed to play disc titles and chapters in a specified order.

1. At CD stop, press **Prog** button.
2. **Program P00:00** is displayed.
3. Press numeric buttons to select favorite songs, press **Enter** button.
4. To start playing programmed songs, press **Play** button.

To clear the program, select "CLEAR ALL" and press the **Enter** button.

Stopping Play

To stop CD play, press the **Stop** button.

Pausing Play

To pause CD play, press the **Pause** button. To resume CD play, press the **Play** button.

Fast Forward / Fast Reverse

To fast forward through a track during CD play, press and hold the **Fast Forward** button. Release the button to play

COMPACT DISC OPERATION

the disc at that point.

To fast reverse through a track during CD play, press and hold the **Fast Reverse** button. Release the button to play the disc at that point.

Track Search

To search forwards or backwards for a specific track on a disc, press the **Skip Up / Skip Down** buttons until you reach the one that you want to listen to.

Repeating a Single Track

Press the **Repeat** button while a CD is playing until "RPT ONE" will appear in the display. The track that is currently playing will repeat continuously.



Repeating the Entire Disc

Press the **Repeat** button while a CD is playing until "RPT ALL" will then appear in the display. The CD will repeat all tracks on the disc continuously.



Random Feature

The Random Feature plays all the tracks on the disc in random order.

1. Press the **Random** button on the player while the disc is playing. With "RDM ON" displayed, the disc will play tracks in random order.
2. To turn off the Random Feature, press the **Random** button again. The display will return to the normal title and track info.



Track Scan Feature

The Track Scan Feature plays the first 10 seconds each track, allowing the user to quickly preview each song.

1. Press the **Scan** button to play the first 10 seconds of each track. "SCAN ON" will appear in the display.
2. Press the **Scan** button again to stop the Track Scan Feature and listen to a track.



DVD OPERATION

General Operations

1. Press and hold the **Power / Mode** button to turn the unit On.
2. Press on the disc door next to the word "PUSH", the door will open slightly. Then gently pull the door fully open.
3. Insert a disc onto the hub until it snaps into place.
4. Close the disc door until it locks into place.
5. Press the **Power / Mode** button until "DVD ON" appears in the display. Disc play will start momentarily after "LOADING" and "DVD" appear in the display.

Stopping Disc Play

To stop DVD play, press the **Stop** button. To resume play, press the **Play** button.

Pausing Disc Play

To pause DVD play, press the **Pause** button. To resume play, press the **Play** button.

Fast Forward/Fast Reverse Disc Play

Press the **Fast Forward** or **Fast Reverse** button during play. Each time the button is pressed, the speed of fast forward/fast reverse changes in the following order:

2x → 4x → 6x → 8x → PLAY

To resume normal play, press the **Play** button or continue to press **Fast Forward** or **Fast Reverse** until "PLAY" is displayed on the screen.

Skipping Chapters

Press the **Skip Up** button to skip forward through the chapters.

Press the **Skip Down** button to skip backwards through the chapters.

Repeat

Press the **Repeat** button to select a repeat mode in the following order:

Repeat Chapter → Repeat Title → Repeat Off

Slow Motion

Press the **Slow Forward** button to play the DVD in slow motion forward.

Press the **Slow Reverse** button to play the DVD in slow motion reverse.

Each time the button is pressed, the speed of slow forward/slow reverse changes in the following order:

2x → 4x → 8x → PLAY

To resume normal play, press the **Play** button or continue to press **Slow Forward** or **Slow Reverse** until "PLAY" is displayed on the screen.

On-Screen Display Function

1. Press the **Display** button during DVD play to display:

Title → Title Remain → Chapter Elapsed → Chapter Remain → Off

2. Press the **Display** button during CD play to display:

Single Elapsed → Single Remain → Total Elapsed → Total Remain → Off

TITLE 1/40 CHAPTER 005/0028

00:05:17

3. Press the **Display** button a third time during DVD play and the screen will be cleared of all messages.

DVD OPERATION

Menu Function

Press the **Menu** button during disc play and the main disc "Root Menu" will be displayed. Scroll through the menu with either the **Skip Up / Skip Down** buttons or the **Fast Forward / Fast Reverse** buttons. Select a feature by pressing the **Enter** button.

Title Menu Function

If the DVD has multiple titles recorded on the disc, a preferred title can be selected from the title menu to start playback.

1. Press the **Title** button during playback. The title menu is then displayed.
2. Scroll through the menu with the **Skip Up / Skip Down** buttons to select a title. Confirm the title by pressing the **Enter** button.

Zooming the Image

To enlarge the onscreen image during disc play, press the **Zoom** button. Each time the button is pressed, the magnification increment changes in the following order:

ZOOM X 1.5 → ZOOM X 2 → ZOOM X 3 → ZOOM OFF

INITIAL DVD SETUP

Initial Setup

1. Using the remote press the **Stop** button to display RESUME STOP.
2. Press the **Stop** button again to display STOP.
3. Press the **Band / Setup** button to view the SETUP Menu - Main Page.

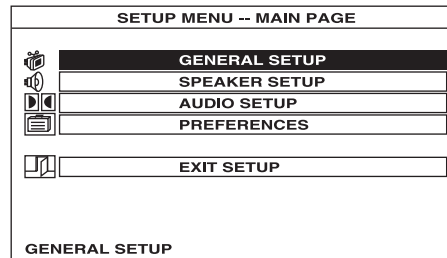

3. The Setup Menu Main Page categories are:
 - General**
 - Speaker Setup**
 - Audio Setup**
 - Preferences**
4. Select one of the four main menu categories by pressing the **Fast Forward / Fast Reverse** buttons.
5. Press the **Enter** button to confirm the selection.

INITIAL DVD SETUP

General Submenu Setup

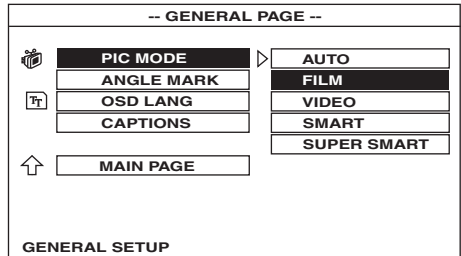

Use the **Skip Up / Skip Down** buttons or the **Fast Forward / Fast Reverse** buttons to scroll between the menu items. Make a selection by pressing the **Enter** button.

General Submenu Options:

PIC mode: Auto / Film / Video / Smart / Super Smart

Angle Mark: On / Off

OSD Lang: English / Chinese

Captions: On / Off

Speaker Setup Submenu

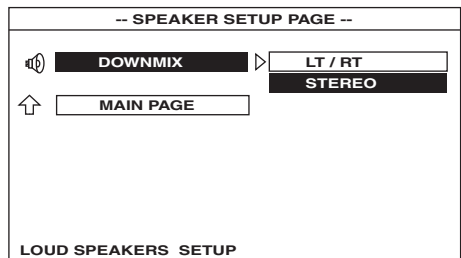

Use the **Skip Up / Skip Down** buttons or the **Fast Forward / Fast Reverse** buttons to scroll between the menu items. Make a selection by pressing the **Enter** button.

Speaker Setup Submenu Options:

Downmix: Lt / Rt or Stereo

Audio Setup Submenu

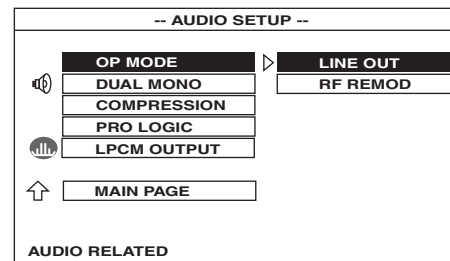

Use the **Skip Up / Skip Down** buttons or the **Fast Forward / Fast Reverse** buttons to scroll between the menu items. Make a selection by pressing the **Enter** button.

Audio Setup Submenu Options:

OP Mode: Line Out / RF Remod

Dual Mode: Stereo, L-Mono / R-Mono / Mix Mono

Compression: Full / 6/8 / 4/8 / 2/8 / Off

Pro Logic: Off / On / Auto

LPCM Output: LPCM 48 K / LPCM 96 K

INITIAL DVD SETUP

Preferences Setup Submenu

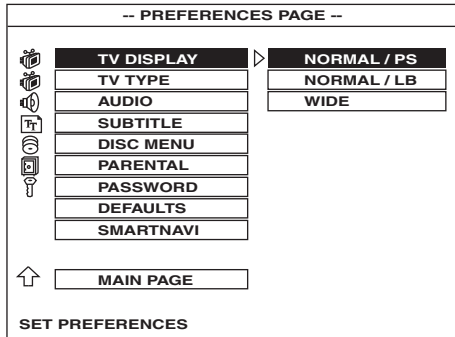

Parental: 1 - G
 2 - Kid
 3 - PG
 4 - PG 13
 5 - R
 6 - PG R
 7 - NC 17
 8 - Adult
 No Parental

Password: Change

Defaults: Reset

SmartNav: No Menu / With Menu

Use the **Skip Up / Skip Down** buttons or the **Fast Forward / Fast Reverse** buttons to scroll between the menu items. Make a selection by pressing the **Enter** button.

Preferences Setup Submenu Options:

TV Display: Normal PS / Normal LB / Wide

TV Type: Multi. System / NTSC / PAL

Audio: English / French / Spanish / Chinese / Japanese

Subtitle: English / French / Spanish / Chinese / Japanese / Off

Disc Menu: English / French / Spanish / Chinese / Japanese / Off

INSTALLATION

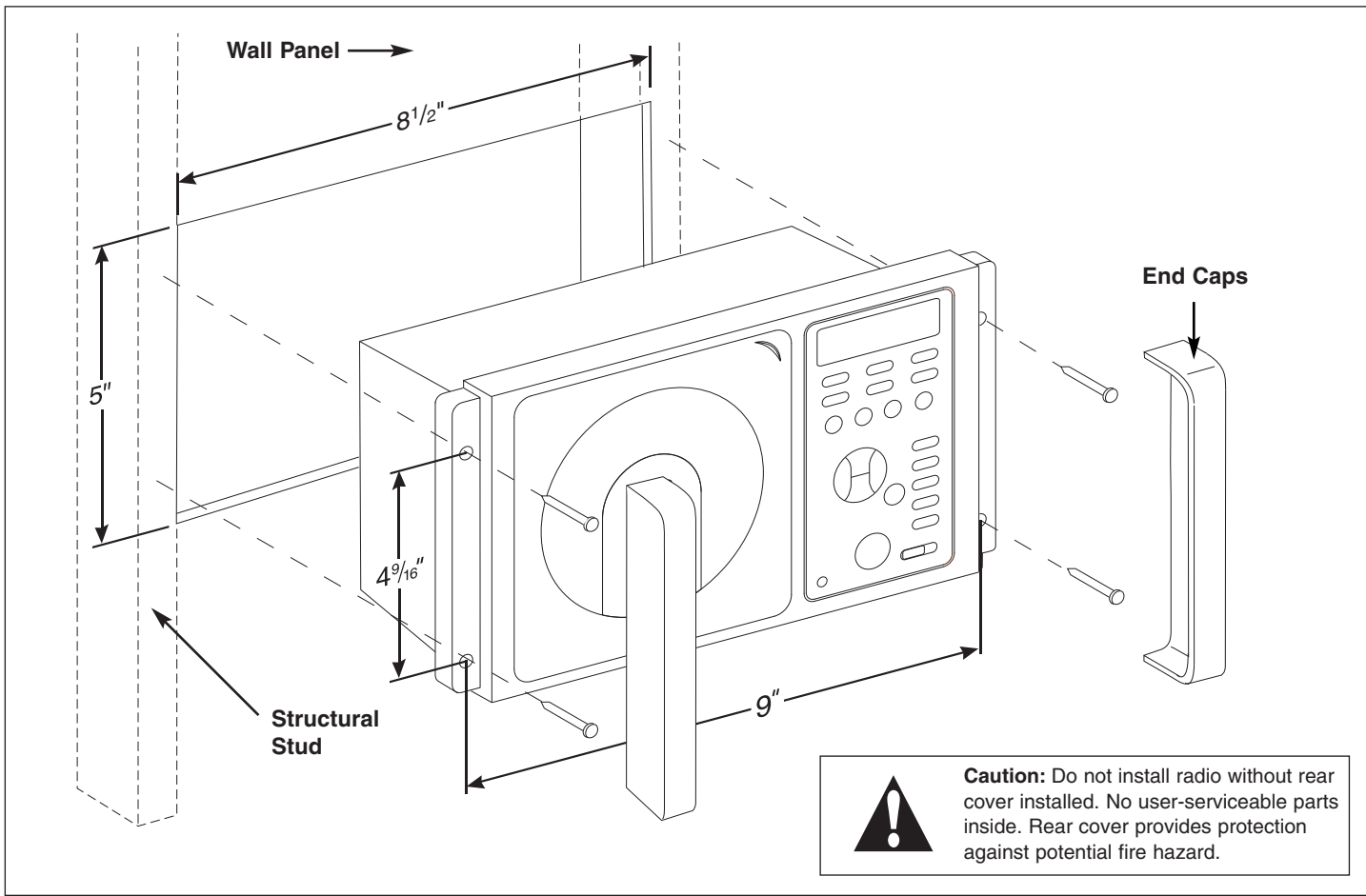

POWER CONNECTIONS

This unit for use only with a 12 Volt DC power source with a negative ground.

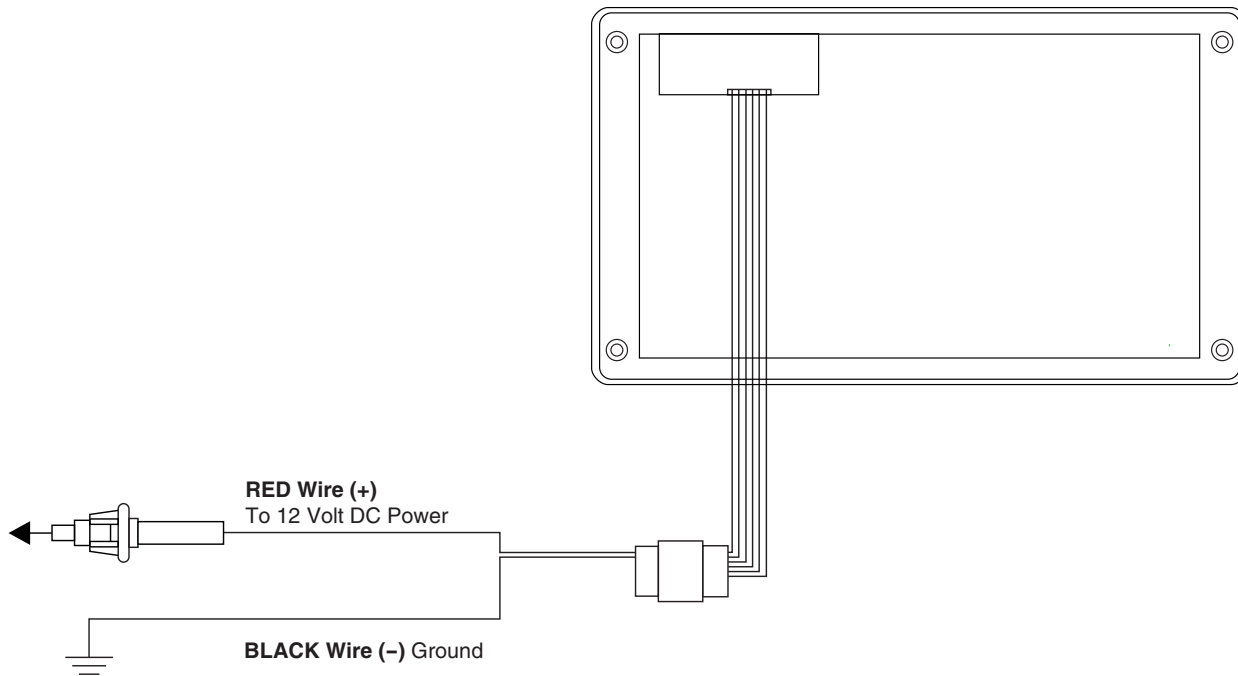

SPEAKER CONNECTIONS

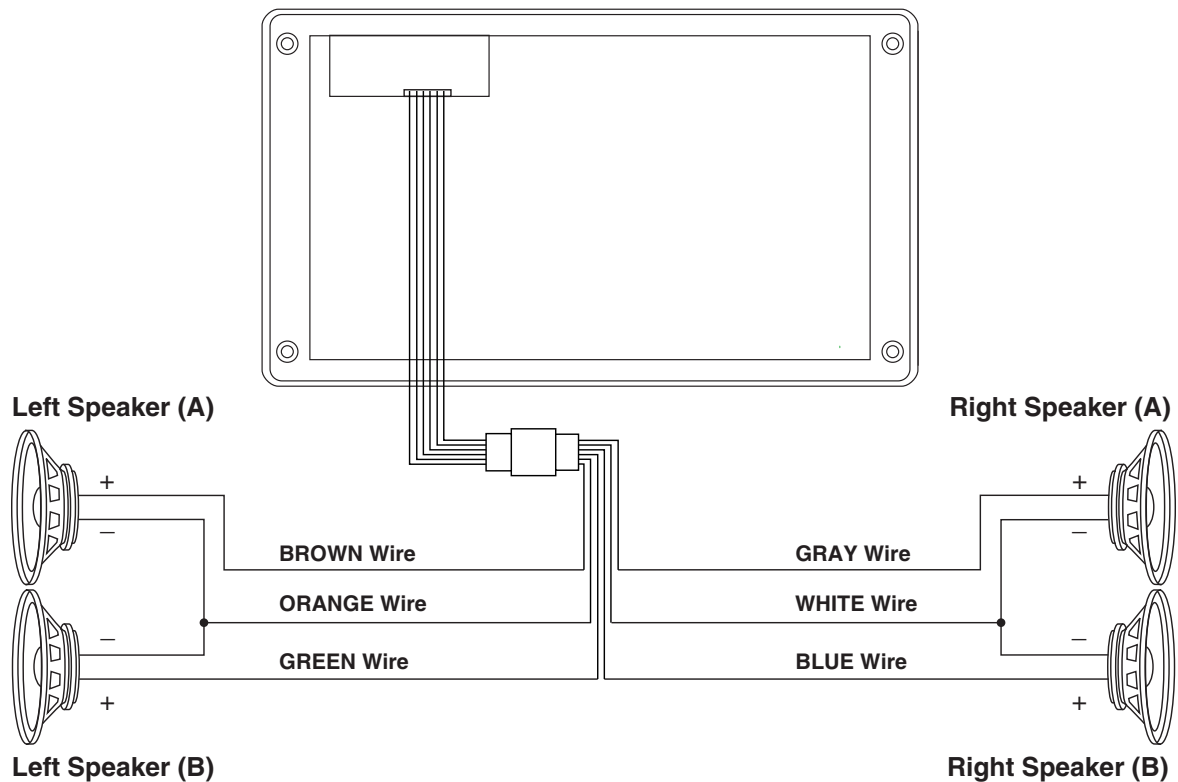

Speaker Connections: Do not confuse the A and B speaker sets.

ANTENNA CONNECTIONS

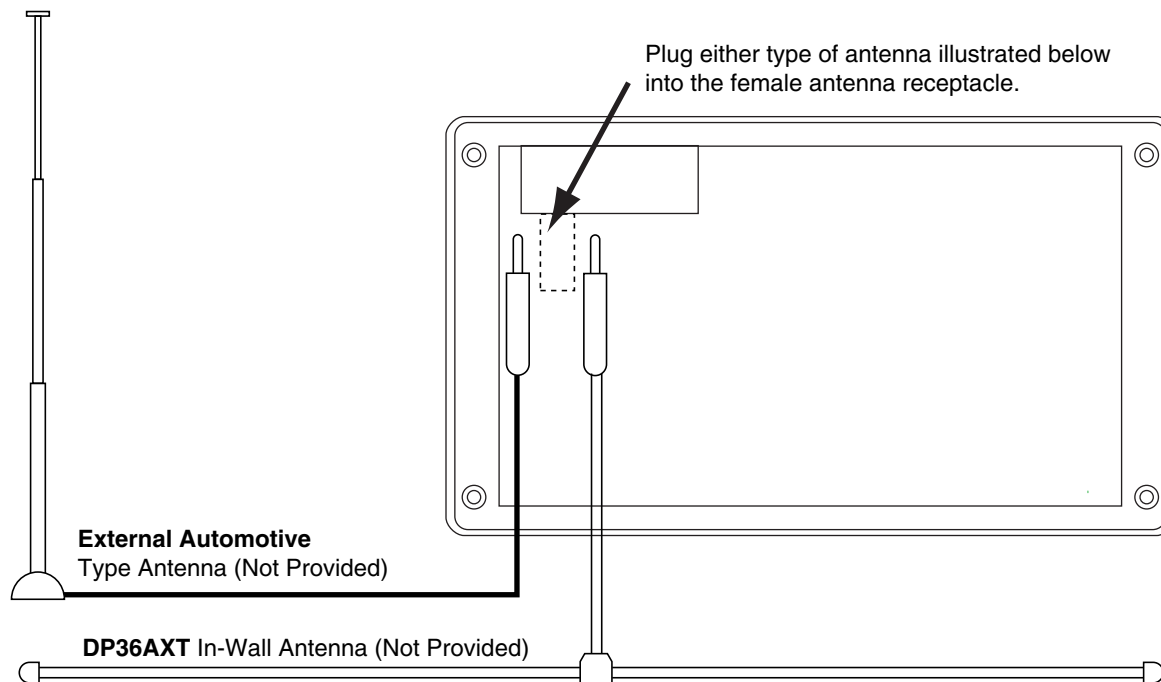

The LS5000DVD have a provision for a standard automotive antenna. If an automotive antenna is used, insert the male plug from the antenna into the female receptacle provided on the unit.

If an automotive antenna is not available or is undesired, we recommend the use of a Magnadyne DP36AXT di-pole antenna substitute. Insert the male plug from the DP36AXT into the female receptacle of the LS5000DVD unit and allow the cable of the antenna to lay inside the wall.

AUXILIARY CONNECTIONS

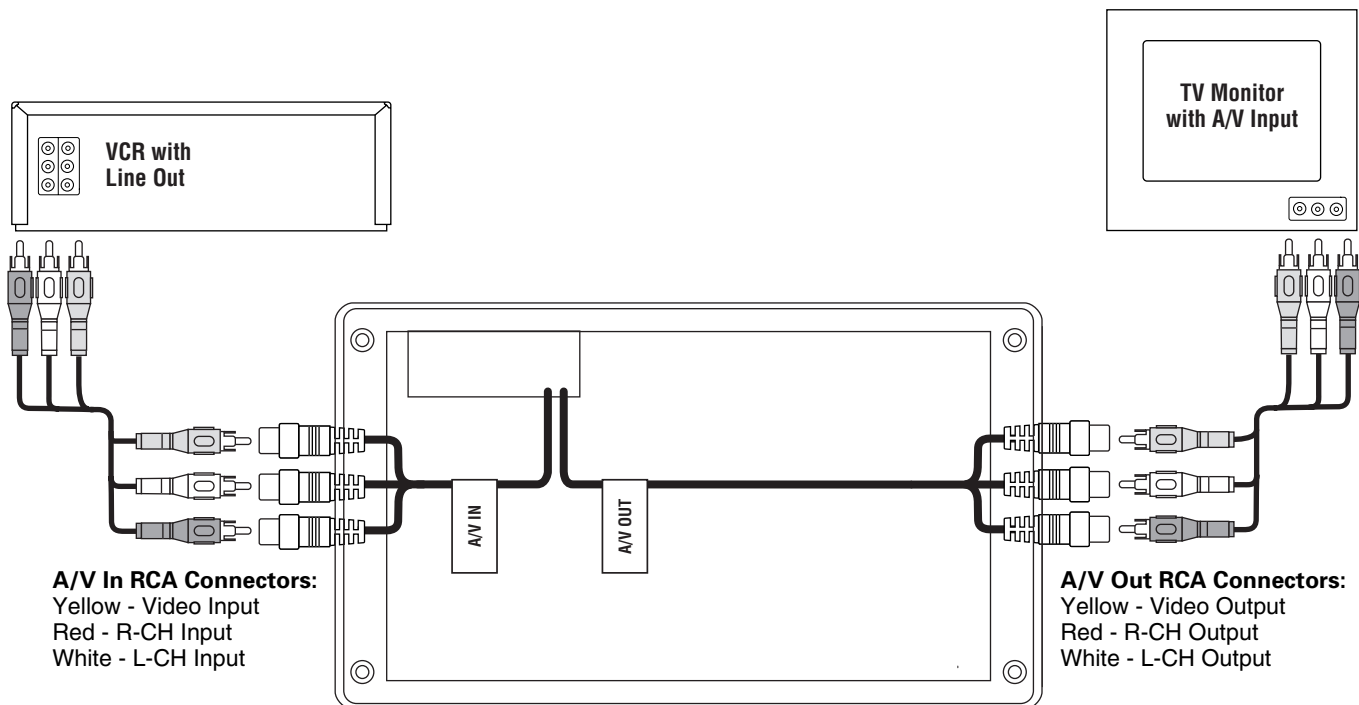

A/V In RCA Connectors:
 Yellow - Video Input
 Red - R-CH Input
 White - L-CH Input

A/V Out RCA Connectors:
 Yellow - Video Output
 Red - R-CH Output
 White - L-CH Output

Aux Audio Input: Left and Right RCA type input jacks are provided on the back panel for connection to a second sound source such as a TV system or component cassette deck. Connect a stereo "male to male" patch cord to the units input jacks and then connect the remaining ends to the second sound sources output jacks.

Note: If the second sound source only has a single mono output jack, it may be necessary to use a "Y" adapter to provide both the left and right inputs.

SAFETY INSTRUCTIONS

Read Instructions: All the safety and operating instructions should be read before the appliance is operated.

Retain Instructions: The safety and operating instructions should be retained for future reference.

Heed Warnings: All warnings on the appliance and in the operating instructions should be adhered to.

Follow Instructions: All operating and use instructions should be followed.

Water and Moisture: The appliance should not be used near water. For example, near a bathtub, washbowl, kitchen sink, laundry tub, in a wet basement, or near a swimming pool, etc.

Wall or Cabinet Mounting: The appliance should be mounted to a wall or cabinet only recommended by the manufacturer.

Heat: The appliance should be situated away from heat sources such as radiators, heat registers, stoves, or other appliances (including amplifiers) that produce heat.

Power Supply: The appliance should be connected to a power supply only of the type described in the operating instructions or as marked on the appliance.

Cleaning: The appliance should be cleaned only as recommended by the manufacturer.

Power Lines: An outdoor antenna should be located away from power lines.

Object and Liquid Entry: Care should be taken so that objects do not fall, and liquids are not spilled into the enclosure through openings.

Outdoor Antenna Grounding: If an outside antenna is connected to the receiver, be sure the antenna system is grounded, so as to provide some protection against voltage surges and built up static charges. Section 810 of the National Electrical Code, ANSI/NFPA No. 70-1983, provides information with respect to proper grounding of the mast and supporting structure, grounding of the lead-in wire to an antenna discharge unit, size of grounding conductors, location of antenna-discharge unit, connection to grounding electrodes, and requirements for the grounding electrode. See illustration below.

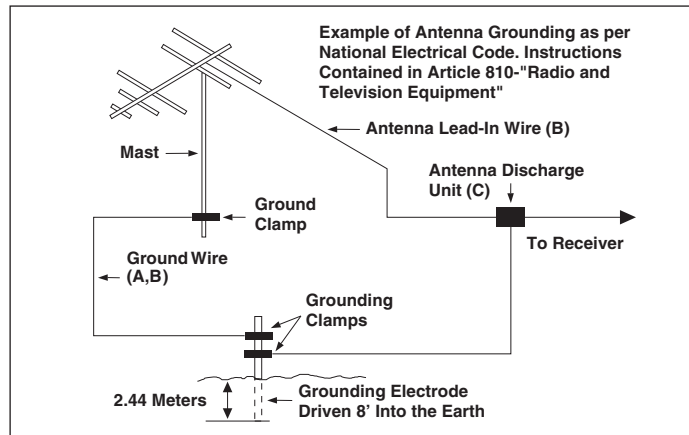

- Use No. 10 AWG (5.3mm²) copper, No. 8 AWG (8.4mm²) aluminum, No. 17 AWG (1.0mm²) copper clad steel or bronze wire, or larger as ground wire.
- Secure antenna lead-in and ground wires to house with stand-off insulators spaced from 4 feet (1.22m) to 6 feet (1.83m) apart.
- Mount antenna discharge unit as close as possible to where lead-in enters house.

OPERATION AND MAINTENANCE

Damage Requiring Service: The appliance should be serviced by qualified personnel when:

- A. Objects have fallen, or liquid has spilled into the appliance; or
- B. The appliance has been exposed to rain; or
- C. The appliance does not appear to operate normally or exhibits a marked change in performance; or
- D. The appliance has been dropped, or the enclosure damaged.

Servicing: The user should not attempt to service the appliance beyond that described in the operating instructions. All other servicing should be referred to qualified personnel.

Caution: Compact disc should be stored in a container or vinyl bag to prevent contamination. Disc should not be placed in locations exposed to sunlight or heat.

WARNINGS



Handle CD's
Properly



Do Not Touch
CD's



Do Not Get Dirt
on CD's



Do Not Write on
CD's



Do Not Scratch
CD's

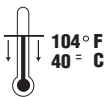

Keep Below 104°
Fahrenheit



Do Not Bend CD's

WARRANTY

ONE (1) YEAR LIMITED WARRANTY

Magnadyne Corporation or its authorized agents will within one year from the date of sale to you, repair, replace or refund the retail sales price of said product or any part thereof, at the option of the Magnadyne Corporation or its authorized agents, if said product or part is found defective in materials or workmanship, when properly connected and operating on the correct power requirements designated for the specific product. This warranty and Magnadyne Corporation or its authorized agents obligations hereunder do not apply where the product was; damaged while in the possession of the consumer, subjected to unreasonable or unintended use, not reasonably maintained, utilized in commercial or industrial operations, or serviced by anyone other than Magnadyne Corporation or its authorized agents, or where the warning seal on the product is broken or the power and/or plugs are detached from the unit. Magnadyne Corporation or any of its authorized agents will not assume any labor costs for the removal and reinstallation of any product found to be defective, or the cost of transportation to Magnadyne Corporation or its authorized agents. Such cost are the sole responsibility of the purchaser. This warranty does not cover the cabinet appearance items or accessories used in connection with this product, or any damage to recording or recording tape, or any damage to the products resulting from improper installation, alteration, accident, misuse, abuse or acts of nature.

MAGNADYNE CORPORATION OR ITS AUTHORIZED AGENTS SHALL NOT BE LIABLE TO ANYONE FOR CONSEQUENTIAL OR INCIDENTAL DAMAGES OR CLAIMS EXCEPT THOSE ACCORDED BY LAW. NO EXPRESSED WARRANTY OR IMPLIED WARRANTY IS GIVEN EXCEPT THOSE SET FORTH HEREIN. NO IMPLIED WARRANTY SHALL EXTEND BEYOND ONE YEAR FROM THE DATE OF SALE.

This warranty extends only to the original purchaser of the product and is not transferable. Some states do not allow limitations on how long an implied warranty lasts, and some states do not allow the exclusion or limitation of incidental or consequential damages, so the above limitations or exclusion may not apply to you. This warranty gives you specific legal rights, and you may have other rights that vary from state to state.

"NOTE: The manufacturer is not responsible for any radio or TV interference caused by unauthorized modifications to this equipment. Such modifications could void the User's authority to operate the equipment."

Defective merchandise should be returned to the original point of purchase or secondly, to Magnadyne Corporation, 1111 W. Victoria Street, Compton CA 90220. Return Authorization must be obtained before sending, or merchandise may be refused.

Free Manuals Download Website

<http://myh66.com>

<http://usermanuals.us>

<http://www.somanuals.com>

<http://www.4manuals.cc>

<http://www.manual-lib.com>

<http://www.404manual.com>

<http://www.luxmanual.com>

<http://aubethermostatmanual.com>

Golf course search by state

<http://golfingnear.com>

Email search by domain

<http://emailbydomain.com>

Auto manuals search

<http://auto.somanuals.com>

TV manuals search

<http://tv.somanuals.com>