

## TABLE OF CONTENTS

1. Important safety instructions .....	2	Changing the settings of a channel .....	16
2. Safety information and useful tips .....	4	Tuning channels automatically.	19
3. Before calling service .....	5	Selecting cable or antenna mode .....	19
4. Basic TV connections .....	8	Selecting a virtual or physical channel .....	20
Antenna connection .....	8	Enabling your current ring ...	20
Mains connection .....	8	Setting options for digital channels.....	20
Switching on the TV .....	8	Selecting and configuring settings and options .....	23
5. Overview of TV connectors and controls .....	9	Change Ambilight settings....	36
6. Optional remote controls	11	11. Appendix A .....	38
RC2888/01 .....	11	12. Definitions, acronyms and abbreviations .....	39
RC2573GR .....	11	13. USA limited warranty ....	42
7. Description of guest remote control .....	12	14. Cleaning and care .....	46
8. Overview of TV menus ...	13	15. Environmental care .....	46
9. Accessing the setup menu	14	16. Index .....	47
10. Installation .....	15	17. Dolby Digital .....	50
Selecting the language.....	15	18. Kensington Security Slot ..	50
Selecting the communication source .....	15		

---

## 1. Important safety instructions

---

### Read Before Operating Equipment

1. For the quickest and most trouble free installation, please consult the quick start guide that came packed in the television or download it from [www.philips.com/hospitality](http://www.philips.com/hospitality).
2. Keep these instructions.
3. Heed all warnings.
4. Follow all instructions.
5. Do not use this TV near water.
6. Clean only with a dry, soft, non-abrasive cloth.
7. Do not block any of the ventilation openings.
8. Install in accordance with the manufacturers instructions.
9. Do not install near any heat sources such as radiators, heat registers, stoves, or other apparatus (including amplifiers) that produce heat.
10. Do not defeat the safety purpose of the polarized or grounding-type plug. A polarized plug has two blades with one wider than the other. A grounding type plug has two blades and third grounding prong. The wide blade or third prong are provided for your safety. When the provided plug does not fit into your outlet, consult an electrician for replacement of the obsolete outlet.
11. Protect the power cord from being walked on or pinched particularly at plugs, convenience receptacles and at the exit point.
12. Only use attachments/accessories specified by the manufacturer.
13.  Use only with a cart, stand, tripod, bracket, or table specified by the manufacturer, or sold with the TV. When a cart is used, use caution when moving the cart/TV combination to avoid injury from tip-over.
14. Unplug this TV during lightning storms or when unused for long periods of time.
15. Refer all servicing to qualified service personnel. Servicing is required when the TV has been damaged in any way, such as power-supply cord or plug is damaged, liquid has been spilled or objects have fallen into apparatus, the TV has been exposed to rain or moisture, does not operate normally, or has been dropped.
16. This product may contain lead and mercury. Disposal of these materials may be regulated due to environmental considerations. For disposal or recycling information, please contact your local authorities or the Electronic Industries Alliance: [www.eiae.org](http://www.eiae.org)
17. Damage Requiring Service - The TV should be serviced by qualified service personnel when:
  - The power supply cord or the plug has been damaged; or
  - Objects have fallen, or liquid has been spilled into the TV; or
  - The TV has been exposed to rain; or
  - The TV does not appear to operate normally or exhibits a marked change in performance; or
  - The TV has been dropped, or the enclosure damaged.

### Know these safety symbols

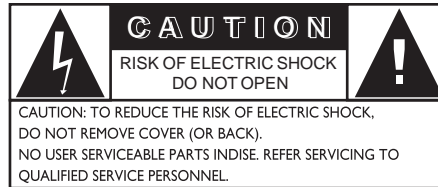

This “bolt of lightning” indicates material not insulated within your unit which may cause an electrical shock.

For the safety of everyone in your property, please do not remove product covering.

The “exclamation point” calls attention to features for which you should read the enclosed literature closely to prevent operating and maintenance problems.

**⚠ WARNING:** To reduce the risk of fire or electric shock, this appliance should not be exposed to rain or moisture and objects filled with liquids, such as vases, should not be placed on this apparatus.

**⚠ CAUTION:** To prevent electric shock, match wide blade of plug to wide slot, and fully insert.

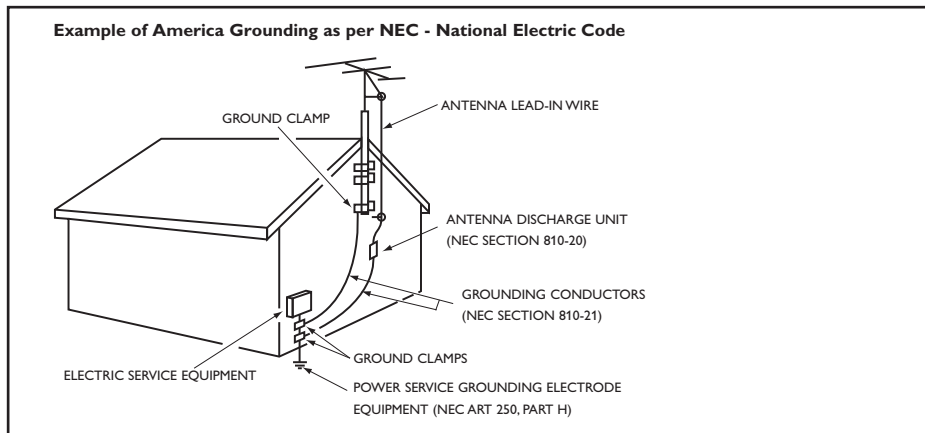

---

## 2. Safety information and useful tips



1. Two people are required to lift and carry a TV that weighs more than 55 lb (25 kg). Improper handling of the TV can cause serious injury.
2. If you place the TV set on a solid surface. Ensure the surface is level and that it can withstand the weight of the TV.
3. Installing the TV on the wall requires special skill that should only be performed by a qualified personnel. You should not attempt to do the work yourself. Philips bears no responsibility for improper mounting or mounting that results in accident or injury. Make sure that the wall mount is being fixed securely enough so that it meets safety standards.
4. This TV is compatible with the VESA wall mounting standard. Please contact your local electronics supplier for a VESA compliant bracket to wall mount this TV. Before you mount your TV on a wall, ensure the wall is suitable to carry the weight of the TV.
5. Do not insert the power plug in the wall socket before all connections are made.
6. Do not touch any part of the TV, power lead, or aerial lead during lightning storms.
7. Do not leave the TV in stand-by mode for an extended period of time. Instead, disconnect the TV from the mains.
8. The TV set is always connected to the mains. Disconnection of the TV set can be done by:
  - unplugging the mains cord located at the back of TV set, or
  - unplugging the mains plug from the mains socket outlet.
9.  **Pull the power lead by the plug - do not pull by the wire.**
9. Ensure the power cord is fully inserted into the TV mains socket and the wall socket.
10. If the TV is mounted on a swivel base or swivel arm, ensure no strain is placed on the power cord when the TV is swivelled. Strain on the power cord can loosen connections and cause arcing or fire.
11. Verify that the mains supply voltage in your location corresponds to the voltage printed on the sticker at the rear of the TV.

### 3. Before calling service

Check this list of symptoms and suggested steps before you request service.

 **Note:** Familiarize yourself with the commercial features described in the TV installation setup. The effects of several of these features, if not thoroughly understood, might appear as faulty operation.

Symptoms		Suggested steps
Installation	TV does not respond to commands of the Setup Remote Control	Check the button on the left hand side of the remote control must be in the <b>SETUP</b> location (see <i>Accessing the setup menu</i> on page 14).
	TV does not respond to the Guest Remote Control	Check if <b>YES</b> is selected in the <b>REMOTE CONTROL LOCK</b> feature (see <i>Specifying the security options</i> on page 24). Select <b>NO</b> if <b>YES</b> is selected.
	Unable to enter Setup menu via Guest Remote Control	Use the Green Remote Control (RC2573GR) to access the Setup menu and reset the SECURITY setting (see <i>Specifying the security options</i> on page 24).
Picture	No picture	Check that the antenna / cable is connected properly at the back of the TV. Check picture adjustments (brightness, contrast, colour, tint). Check Tuning Mode setting (Air / Cable). Possible TV station problem. Try another channel. Ensure <b>VIDEO</b> is not selected in the <b>MUTE</b> feature of the <b>CHANNEL INSTALL</b> menu (see <i>Selecting the Mute Source</i> on page 18).
	Double image / "ghost" image	Check antenna, cable or set-top box.
	Snowy / noisy picture	Check antenna, cable and /or set-top box connections. Ensure that they are properly connected.
Power	No power	Ensure that the TV's AC power cord is plugged into the main socket and to your TV. If there is still no power, disconnect the plug. Wait for 60 seconds and re-attach plug. Switch on the TV again.
	TV switches off by itself	Check <b>ESP</b> (Energy Saving Programmability) setting in TV installation / setup (see <i>Configuring the control options</i> on page 27).
	TV cannot be switched off	Ensure <b>FORCED ON</b> is not selected in the <b>POWER ON</b> feature of the <b>SWITCH ON / OSD</b> menu (see <i>Specifying the configuration when switching on TV</i> on page 23).

Symptoms		Suggested steps
Power	TV cannot be switched on	<p>The POWER  button of the remote control is used to set the TV to stand-by mode. Use the Digit 0-9 or CH + / – buttons to switch on the TV.</p> <p>Check if <b>YES</b> is selected in the <b>REMOTE CONTROL LOCK</b> feature in <b>SECURITY</b> menu (see <i>Specifying the security options</i> on page 24). Select <b>NO</b> to deactivate the lock function.</p> <p>Check if <b>ALL</b> is selected in the <b>KEYBOARD LOCK</b> feature in <b>SECURITY</b> menu. Select <b>NO</b> to deactivate lock function (see <i>Specifying the security options</i> on page 24).</p> <p> <b>Note:</b> If both <b>REMOTE CONTROL LOCK</b> and <b>KEYBOARD LOCK</b> features are on, use the Setup Remote Control to turn off the functions.</p>
Sound	No sound	<p>Check if the volume of the TV is not at the minimum. Try pressing the Volume Up button of the remote control to increase volume.</p> <p>Check that the mute mode is off. If the mute mode is on, press the Mute button  on the remote control to deactivate mute mode.</p> <p>Check <b>AUDIO</b> is not selected in the <b>MUTE</b> feature of the <b>CHANNEL INSTALL</b> menu (see <i>Selecting the Mute Source</i> on page 18).</p> <p>Check that the audio source in the <b>DEFAULT HDMI AUDIO</b> feature is selected correctly (see <i>Configuring the features options and settings</i> on page 29).</p> <p>If the TV is connected via HDMI to a DVD player, check whether the Digital Audio output of the DVD player is set to PCM mode.</p>
	Volume level cannot be increased or decreased beyond a certain value	<p>Check the limit setting for the Minimum and Maximum Volume and specify the setting in the <b>MIN VOLUME</b> / <b>MAX VOLUME</b> features in the <b>CONTROL</b> menu (see <i>Configuring the control options</i> on page 27).</p>

Symptoms		Suggested steps
Remote Control	TV does not respond to Guest Remote Control	<p>Change the batteries.</p> <p>Aim the remote control directly at remote control sensor lens on TV and press any button on the remote control.</p> <p>Check if <b>YES</b> is selected in the <b>REMOTE CONTROL LOCK</b> feature in <b>SECURITY</b> menu (see <i>Specifying the security options</i> on page 24). Select <b>NO</b> to deactivate lock function.</p> <p>Deselect <b>HM - LINK</b> in the <b>COMMUNICATION</b> feature if <b>HM - LINK</b> is selected (see <i>Accessing the setup menu</i> on page 14).</p>

---

## 4. Basic TV connections

---

### 4.1 Antenna connection

Connect the antenna or RF cable signal to the 75  $\Omega$  RF 'F' connector socket located on the TV.

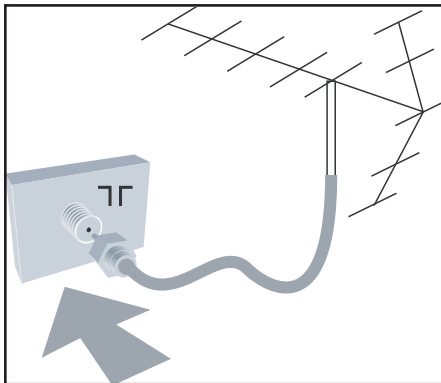

---

### 4.2 Mains connection

Ensure that the mains voltage and frequency are correct. Refer to the product labelling and documentation.

**Note:** The power button  $\text{⏻}$  on the TV does not disconnect the television from the AC mains. It toggles the TV between on and stand-by mode. To completely turn off the TV you must unplug the AC mains plugs from the wall socket.

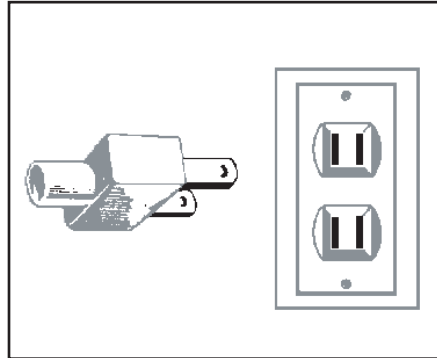

---

### 4.3 Switching on the TV

Press  $\text{⏻}$  on the TV or on one of the optional remote controls to switch the TV set on.

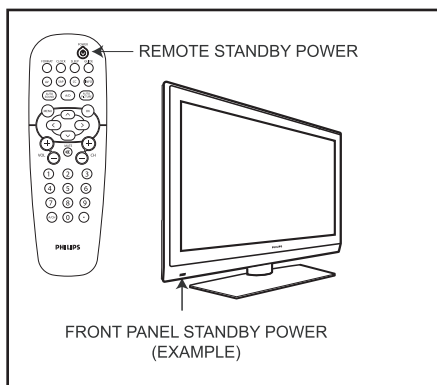



## 5. Overview of TV connectors and controls

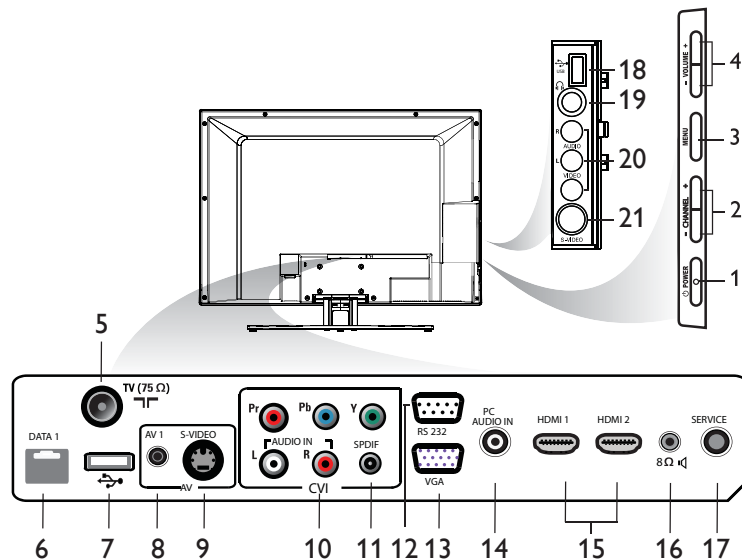

### Warning:

- Risk of electric shock. The rear jack panel must be removed by qualified personnel only.
- Do not connect any telephone cables or equipment to **Data 1**.

#### 1. **POWER**

To switch the TV on and off. To disconnect from the mains, remove the mains cord from the mains socket at the back of the TV or remove the mains plug from the wall socket.

#### 2. **- CHANNEL +**

To select a channel.

#### 3. **MENU**

To display or close menus.

#### 4. **- VOLUME +**

To increase or decrease volume.

#### 5. **TV Aerial**

To connect to the aerial plug.

#### 6. **DATA 1**

For Pay Per View Terminal connection.

#### 7. **USB**

To play media, clone and upgrade software.

#### 8. **AV 1**

A replacement for the standard audio and video cables - red, white and yellow. To connect to video camera or camcorder.

#### 9. **S-Video**

To play video from an external device. The audio is provided by the AV 1 jack.

 **Note:** Switching between AV 1 and S-Video does not occur automatically. Set the input to S-Video (see *Select an input source* on page 17).

#### 10. **Component Video Inputs/Audio Inputs**

To connect to a DVD player or decoder which have the same connectors.

11. **SPDIF**

To connect to a HiFi / Home Theater system.

12. **RS 232**

To use serial communications to an external device.

 **Note:** Serial Xpress must be selected as the communication source (see *Selecting the communication source* on page 15).

13. **VGA In**

For input PC/Lap-top VGA.

14. **PC Audio In**

To play audio from a PC. Only compatible if also connected to an HDMI or VGA input.

15. **HDMI 1/2**

To connect to peripheral equipment, including high-definition equipment.

16. **8 Ω **

To connect to a bathroom speaker. A stereo jack must be used.

17. **Service**

For diagnostic purposes. Should only be used by qualified Philips personnel.

 **Note:** The following connectors are available on certain sets only.

18. **Side USB**

See USB.

19. **Headphones **

To listen to audio via headphones.

20. **Side Audio / Video Inputs**

To connect to a video camera or camcorder.

21. **Side S-Video**

To play video from an external device. The audio is provided by the Side Audio / Video Inputs.

 **Note:** Side Audio / Video Inputs and Side S-Video cannot be used at the same time. Do not connect both.

---

## 6. Optional remote controls

The following remote controls are applicable to TVs from Philips Commercial Solutions. These remote controls can be used for setup and configuration.

---

### 6.1 RC2888/01

Guest Mode Remote Control (optional)



---

### 6.2 RC2573GR

RC2573GR is an optional remote control. It is used for Philips Commercial Solutions features and SmartCard settings. It can be purchased separately.

Slide this button up to enter into **Guest mode**.

or

Slide this button down to enter into **Setup mode**.

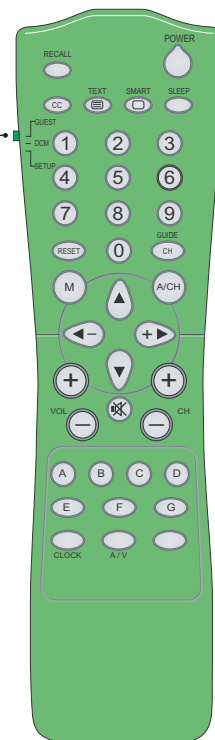

## 7. Description of guest remote control

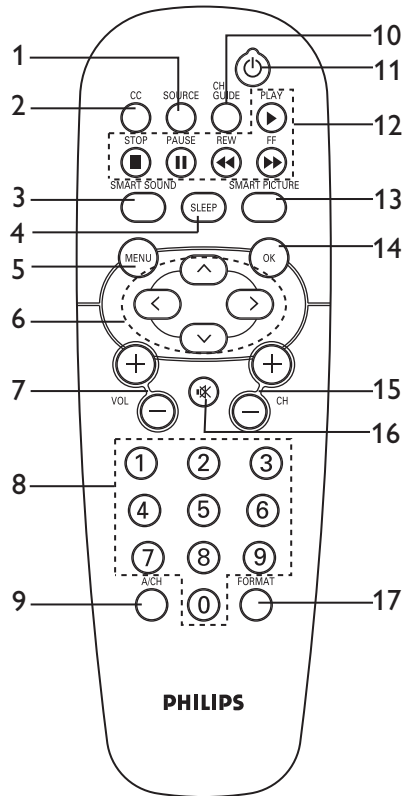

1. **Source Select**  
To toggle between available video sources.
2. **Closed Caption**  
To activate the Closed Caption function.
3. **Smart Sound**  
To select the predefined sound settings.
4. **Sleep**  
To activate the sleep timer. Press the button repeatedly to increase countdown time.
5. **Menu**  
To call up or exit the menus.

12

6. **Navigation cursors**  
To navigate through the menus/ submenus.
7. **Volume + / -**  
To adjust the TV volume.
8. **0 to 9 Digit keys**  
To select a TV channel. For a two digit number, enter the second digit before the dash disappears.
9. **Alternate Channel**  
To toggle between the alternate channels
10. **Channel Guide**  
To activate the channel guide function.
11. **Standby**  
To switch the TV on from standby or back to standby..
12. **DVD keys** (if applicable)
  - To pause DVD play.
  - ▶ To start DVD playback.
  - To pause DVD playback.
  - ◀◀ To rewind DVD playback
  - ▶▶ To fast forward DVD playback.
13. **Smart Sound**  
To select predefined sound settings.
14. **OK**  
To confirm a selection.
15. **Channel + / -**  
To select channels.
16. **Mute**  
To mute or restore sound.
17. **Format**  
To select TV picture formats.

## 8. Overview of TV menus

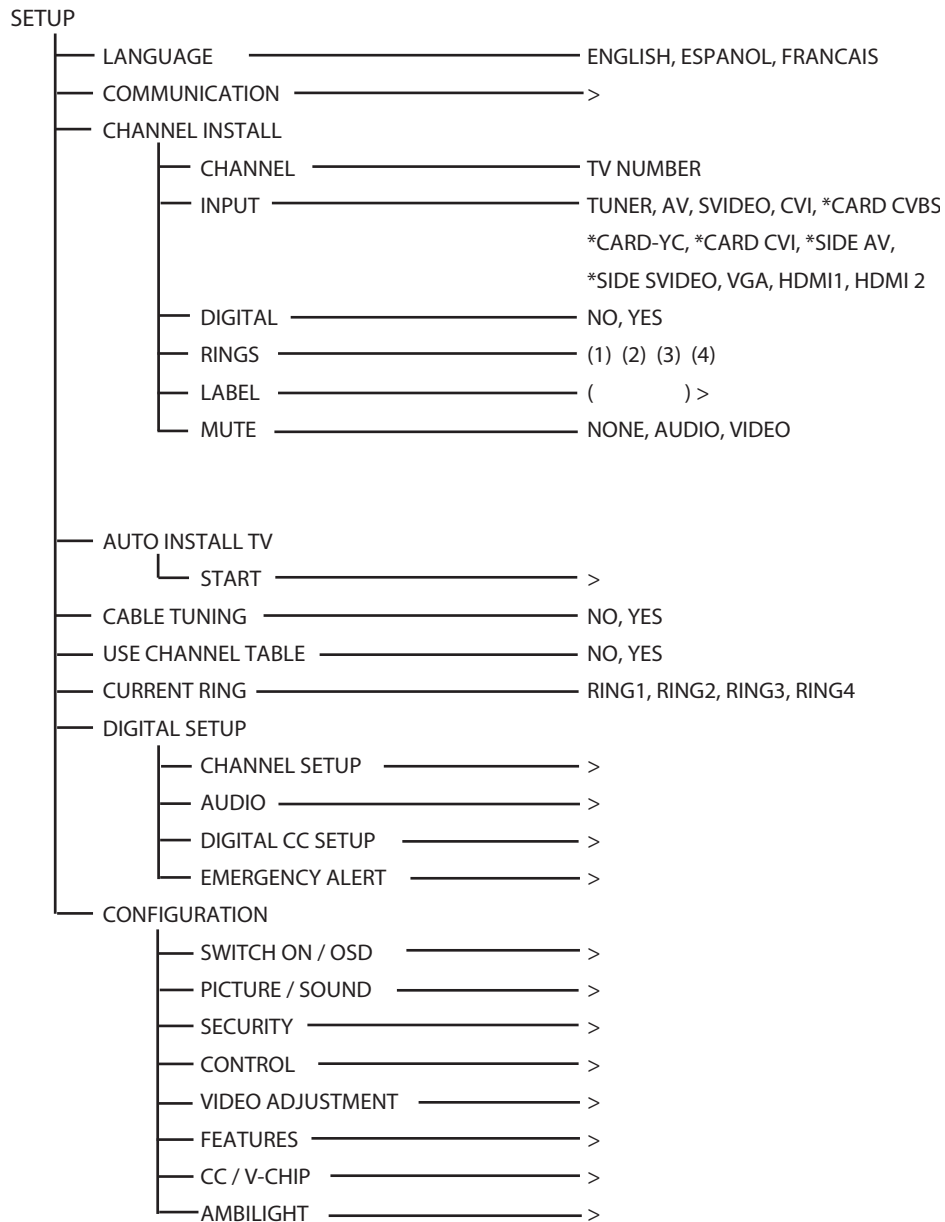

\* CARD CVBS, CARD-YC, CARD CVI, SIDE AV, SIDE SVIDEO are available on certain models only.

## 9. Accessing the setup menu

The following remote control commands apply to Philips Commercial Solutions TV products. These can be used for setup and configuration purposes.

### Accessing TV Setup Menu using the Remote Control (RC2573GR)

1. Slide the button to the **Setup** location.

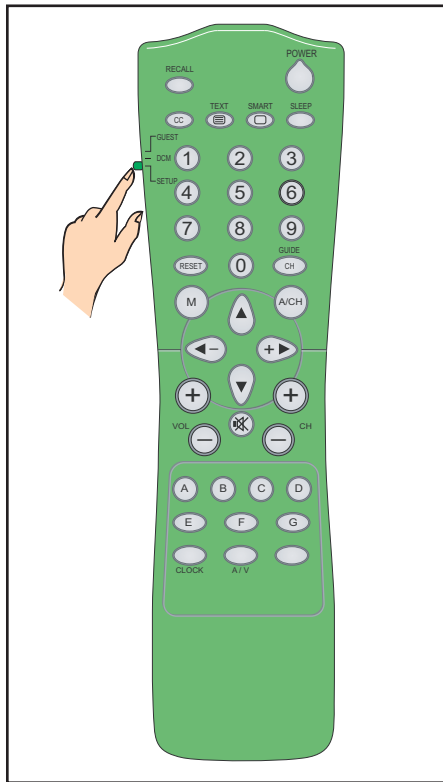

2. Press **M** on the remote control to access the **Setup** Menu.

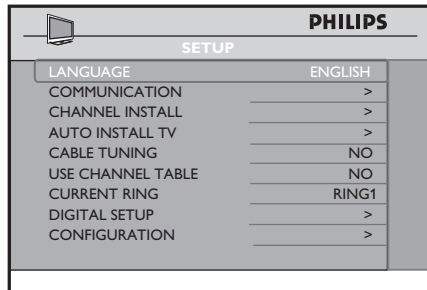

To scroll through the menu:

- Press **▲** or **▼** on the remote control to highlight a menu item.
- Press **▶** to modify the setting of the highlighted menu item.
- Press **M** to exit the setup menu.

## 10. Installation

### 10.1 Selecting the language

You can select **ENGLISH**, **ESPAÑOL** or **FRANCAIS** as your preferred language.

- Press ► repeatedly to select your preferred language.

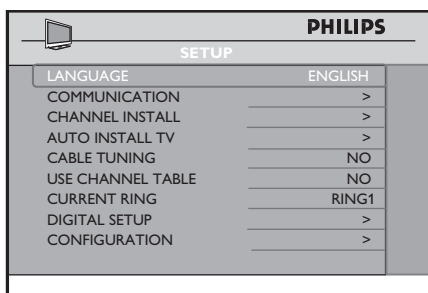

### 10.2 Selecting the communication source

The following options are available in the **COMMUNICATION** menu

- **SP - SPI**
- **SP - I2C**
- **HM - LINK**
- **SERIAL XPRESS**
- **MULTI RC**
- **SMART RC**
- **OFF**

The factory default (SP-SPI) is correct for most systems.

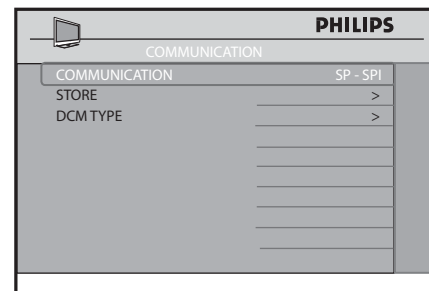
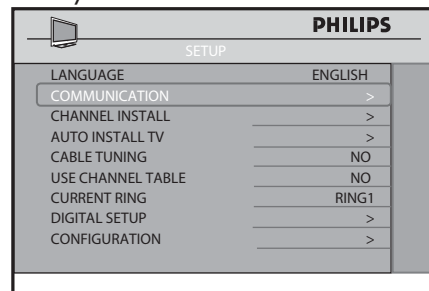

- To identify a connection link between the TV display and the setup box, select **SP - SPI**, **SP - I2C**, **HM - LINK** or **SERIAL XPRESS**.

⊖ For **SP - SPI** and **SP - I2C**: if the set-top box requires a source switch, select **GENERIC** under **DCM TYPE**.

- To use the specified color code to correspond to the remote control select **MULTI RC** (see *Appendix A* on page 38).
- Select **SMART RC** to access the **SMOOVIE™** functionality on this TV set.
- Select **STORE** and store all your selections.

### 10.3 Changing the settings of a channel

This feature allows you to change the settings for a particular channel.

Press ► to enter the **CHANNEL INSTALL** menu.

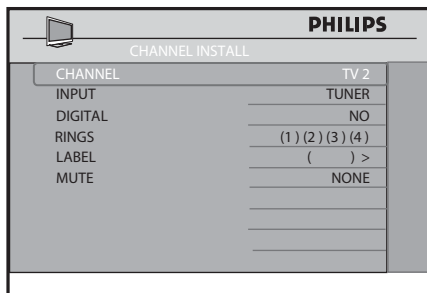
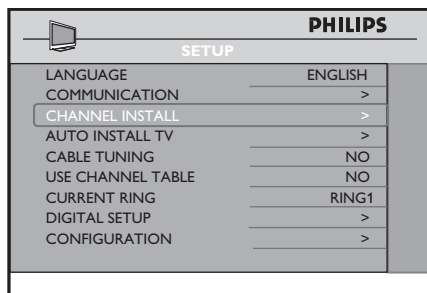

#### Select a Channel

- Press 0 - 9 on the remote control to select a channel.
  - For **Cable** mode, select 01 - 250.
  - For **Antenna** mode, select 02 - 250.

ⓘ **Note:** To input a three digit channel, configure the TV to allow 3-digit channel entry. (see *Configuring the control options* on page 27)



Select an input source

- **TUNER, AV, SVIDEO, CVI, VGA, HDMI1, HDMI2, CARD-CVBS, CARD-YC, CARD CVI, SIDE AV or SIDE SVIDEO**

⊖ **Note: CARD-YC, CARD CVI, CARD-CVBS, SIDE AV and SIDE SVIDEO** are available on certain models only.

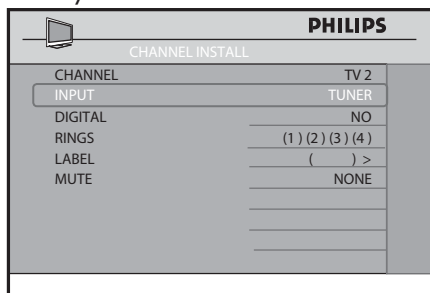

#### Selecting Digital Channel Options

- If the current channel you are mapping is a digital or high definition channel, use ◀ ▶ to select **YES**. Selecting **NO** removes the **DIGITAL CH SCROLL**, **DIGITAL MAJOR CH** and **DIGITAL MINOR CH**. Since the channel is not digital, these options do not appear in the menu.

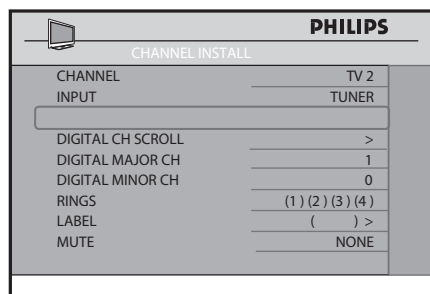

- If **NO** is selected in the **USE CHANNEL TABLE** (see *Selecting a virtual or physical channel* on page 20), the options for **DIGITAL MAJOR CH** and **DIGITAL MINOR CH** are replaced

with the options of **RF CHANNEL NUMBER** and **MPEG PROGRAM NUMBER**.

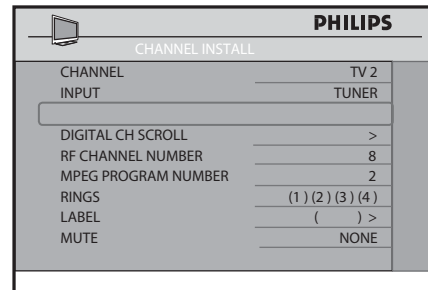
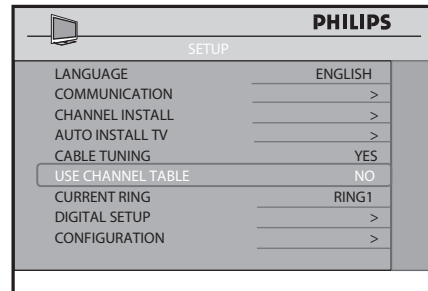

#### Scrolling the Digital Channels

- If **YES** is selected, press ◀ ▶ to go the previous or next digital channel.

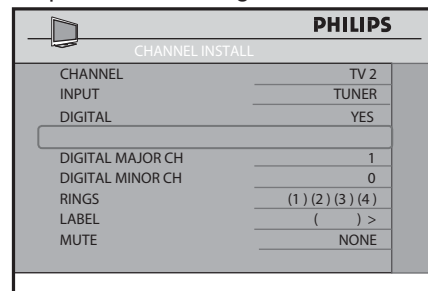

#### Searching the Digital Major Channels / RF Channel Number

- For **DIGITAL MAJOR CH / RF CHANNEL NUMBER**, key in the channel number (1 to 999) using **0 - 9**.

### Searching the Digital Minor Channel / MPEG Program Number

- For **DIGITAL MINOR CH / MPEG PROGRAM NUMBER**, use **0 - 9** to key in the channel number (0 to 999).
- Press **◀** from **Channel 0** to select **NO**.
- If **NO** is selected, go back to **DIGITAL MAJOR CH. / RF CHANNEL NUMBER** to enter one part channel number.
- Press **0 - 9** to key in the channel number (1 to 16383).

### Selecting your Preferred Ring

- There are four groups of rings. Each ring comprises a group of channels.
- Press **◀ ▶** to select preferred ring. A red dash appears beside the selected ring.
- Press **▲ ▼** to confirm selection. An "X" appears beside the ring.
- Press **M** to save and exit ring mode.

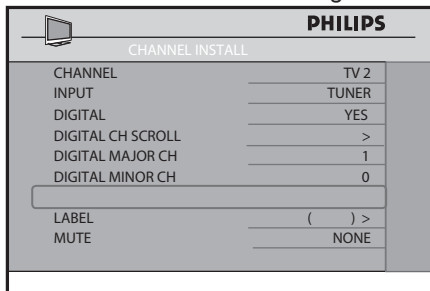

- Press **▲ ▼** to key in the first character.

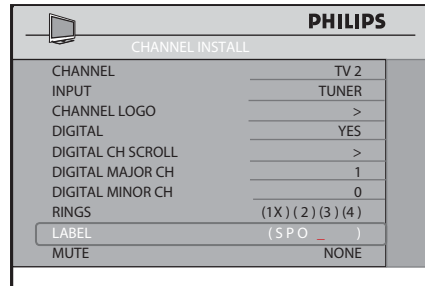

- Press **◀ ▶** to move to the next character slot and continue to key in the next character (maximum of 8 characters).
- Press **M** to save and exit label mode.

### Selecting the Mute Source

You can choose to mute the audio or the video.

- Press **◀ ▶** to select **NONE, AUDIO** or **VIDEO**.

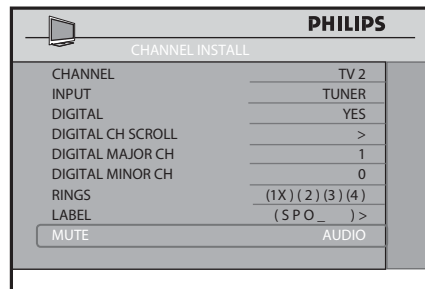

### Naming a channel

- You can assign a name to a channel. Press **◀ ▶** to move to the first character slot. A red dash appears.

## 10.4 Tuning channels automatically

**Note:** This option is only available when **TUNER** is selected at the **INPUT** item of the **CHANNEL INSTALL** menu.

1. Press ► to enter **START** mode.

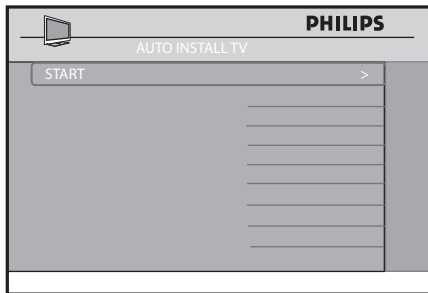
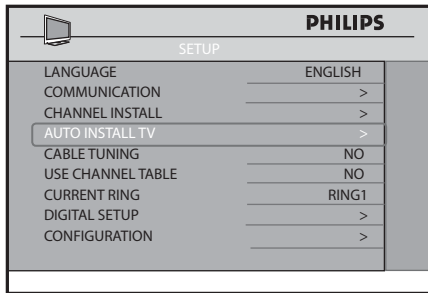

2. Press ► again to start automatic installation of channels.

**Note:** To interrupt automatic installation of channels, press any button on the remote control.

## 10.5 Selecting cable or antenna mode

**Note:** This option is only available when **TUNER** is selected as the **INPUT** item in the **CHANNEL INSTALL** menu.

Select **YES** to use **Cable** mode and **NO** to use **Antenna** mode.

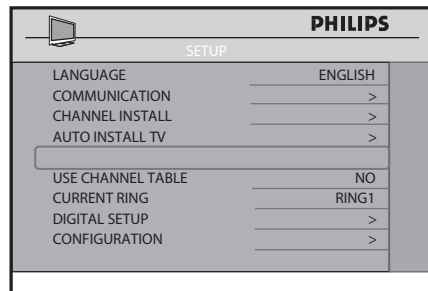
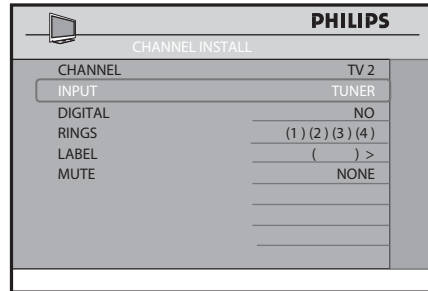

## 10.6 Selecting a virtual or physical channel

**Note:** This option is only available when **TUNER** is selected at the **INPUT** item of the **CHANNEL INSTALL** menu.

The **USE CHANNEL TABLE** option relates to the use of Virtual channels versus Physical channels.

- Select **NO** to use a physical channel number. Most Pay-Per-View systems mandate that the TV uses physical channels.

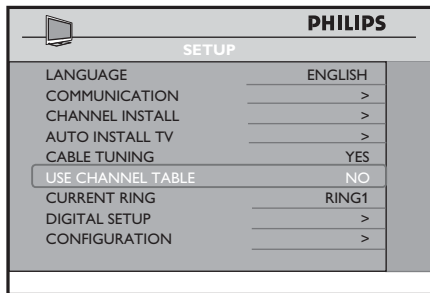

- Select **YES** for a stand alone system where the channels are tuned and ordered by their virtual channel numbers.

Most HD stations are assigned physical channel numbers that differ from their traditional analog channel numbers. So, the channel you know as channel 2 is actually broadcasting its HD signal on a physical channel unrelated to channel 2, say 19.1. Selecting **YES** will cause the HD broadcast of channel 2 to appear as channel 2.1.

## 10.7 Enabling your current ring

A ring is a group of favorite channels.

Four groups of **RING** are available.

- To enable **CURRENT RING**, select from **RING1** to **RING4**.

**Note:** If “**SMART RC**” is selected under **COMMUNICATION** source (see *Selecting the communication source* on page 15), then **RING 4** is not available.

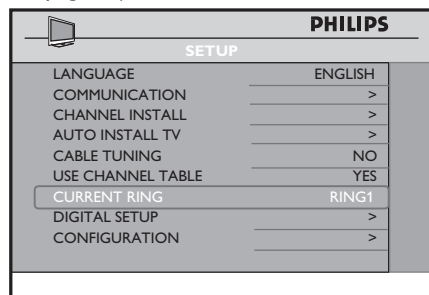

## 10.8 Setting options for digital channels

- Press **▶** to enter the **DIGITAL SETUP** mode.

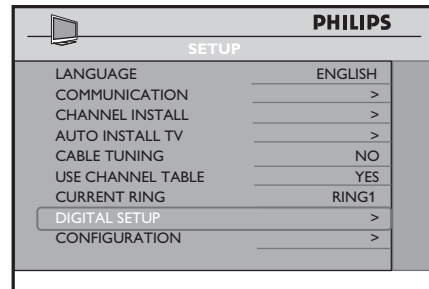

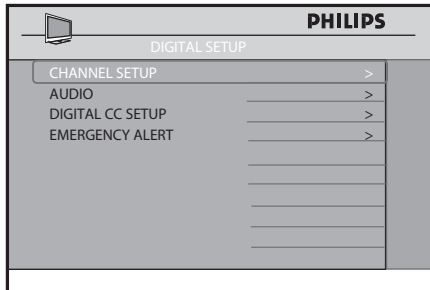

### Setting up the VCHIP / DIGITAL RATING and FACTORY CH RESET

- Press ► to enter the **CHANNEL SETUP** mode.

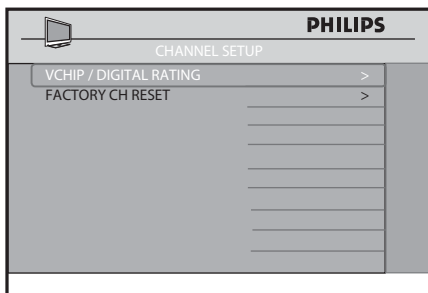

- **VCHIP / DIGITAL RATING** allows you to configure and enable content restrictions on the TV based upon the VCHIP STANDARD (see [www.fcc.gov/vchip/](http://www.fcc.gov/vchip/) for more information on ratings).
- **FACTORY CHANNEL RESET** allows you to clear the digital channel map. **Note:** You need to do an automatic installation after **FACTORY CHANNEL RESET** is confirmed.
  - Press ▲ ▼ to select the item you want to configure.
  - Press ◀ ▶ to select option.

### Selecting the Digital Audio language

- Digital Audio allows you to select your preferred digital audio language (English, Spanish or French).

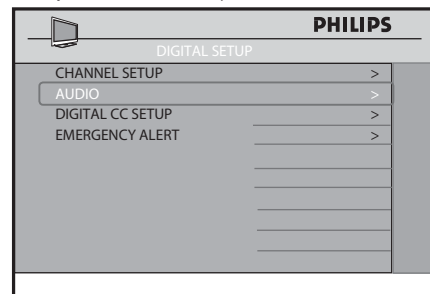

- Press ► to enter the **AUDIO** mode.

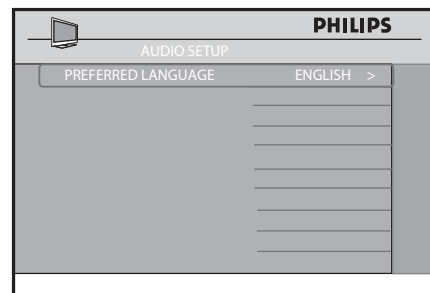

- Press ► to enter the Preferred Language mode and select your preferred language.

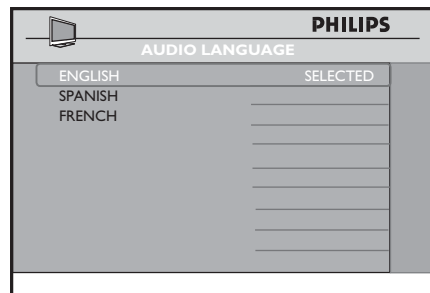

## Selecting the Digital Closed Caption options

### DIGITAL CLOSED CAPTION SETUP

allows you to select the default Closed Captioning option and also configure the digital text / background properties of digital CC.

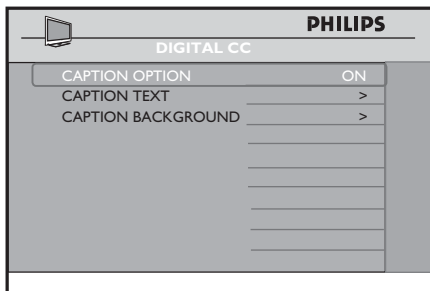
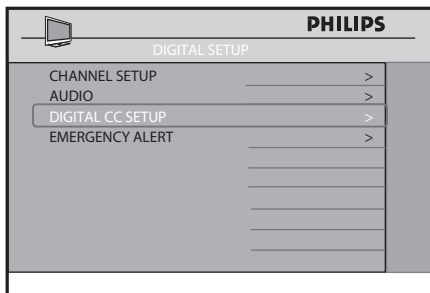

- Press ► to enter the **DIGITAL CC SETUP** menu and select your default Closed Captioning option and also configure the digital text background properties of digital CC.

### Activating the Emergency Alert

Use this option to enable or disable **MEDIUM** to **LOW** alert.

- Press ► to enter the **EMERGENCY ALERT** menu and select **MEDIUM** or **LOW**.

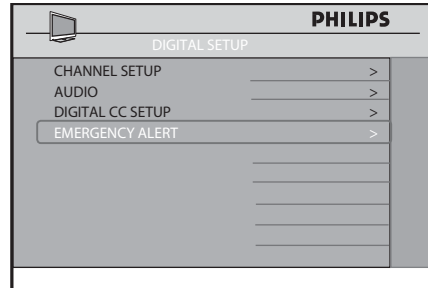

- Press the ▲ ▼ buttons to select **MEDIUM** or **LOW**.
- Press ◀ ▶ to select **ON** or **OFF**.

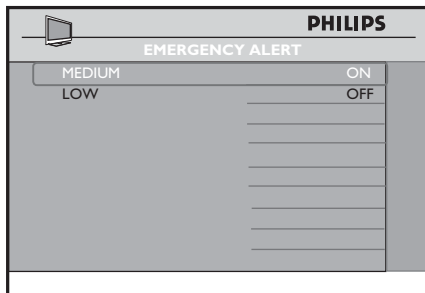

Select **ON** option to enable **EMERGENCY ALERT**.

- ⓘ **Note: HIGH EMERGENCY ALERT** cannot be disabled.

## 10.9 Selecting and configuring settings and options

The **CONFIGURATION** menu allows you to select and configure the settings and options for:

- SWITCH ON / OSD
- PICTURE / SOUND
- SECURITY
- CONTROL
- VIDEO ADJUSTMENTS (only available on certain models)
- FEATURES
- CC / V - CHIP
- AMBILIGHT (only available on certain models)
- Press ► to enter the **CONFIGURATION** menu.

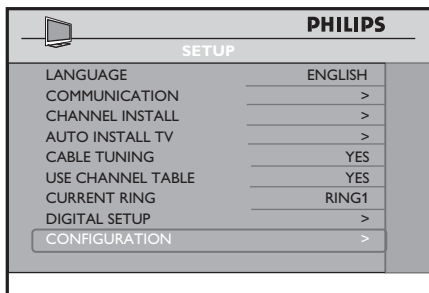

- Press ▲ ▼ to select the item you want to configure.

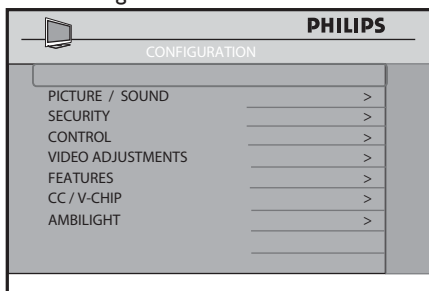

### Specifying the configuration when switching on TV

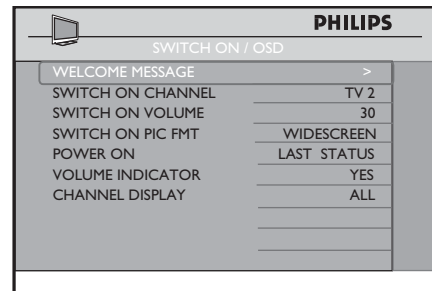

The **SWITCH ON / OSD** menu allows you to select and configure the settings and options for:

- WELCOME MESSAGE
- SWITCH ON CHANNEL
- SWITCH ON VOLUME
- SWITCH ON PICTURE FORMAT
- POWER ON
- VOLUME INDICATOR
- CHANNEL DISPLAY



- Press ▲ or ▼ to select the item you want to configure.
- Press ◀ ▶ or 0 - 9 to make adjustments or select options.
- **WELCOME MESSAGE:** key in a welcome message.
- **SWITCH ON CHANNEL:** set a channel which you want the TV to always tune to at startup.
- **Note:** If **STANDARD** is selected in the **SWITCH ON CHANNEL** feature, the TV will switch to the last viewed channel upon start-up.
- **SWITCH ON VOLUME:** specify the volume setting at startup.
- **SWITCH ON PIC FMT:** select your preferred picture format at startup (**AUTO, 4:3, ZOOM 14:9**,

**ZOOM 16:9, SUBTITLE ZOOM, WIDESCREEN, SUPERWIDE or FULLSCREEN).**

- **POWER ON:** Select the status either **LAST STATUS, ON, STANDBY** or **FORCED ON** on the TV when switched on. If **LAST STATUS** is selected, the last power status will be activated when the TV is switched on.
  - If **ON** is selected, the TV always switches on when the mains cord is connected. The **POWER**  buttons on the Guest Remote Control and the TV are enabled.
  - If **STANDBY** is selected, the TV switches to stand-by when the mains power is switched on.
  - If **FORCED ON** is selected, the TV always switches on when the mains power is turned on. The **POWER**  buttons on the Guest Remote Control and the TV will be disabled.
- **VOLUME INDICATOR:**  
Display the volume indicator.
- **CHANNEL DISPLAY:**  
Display the programme number, label (if any) or both.

**Specifying the configurations for TV PICTURE / SOUND**

In the **CONFIGURATION** menu, the **PICTURE / SOUND** feature allows you to select and configure the settings and options for:

- BRIGHTNESS
- COLOR
- CONTRAST
- SHARPNESS
- TINT
- ACTIVE CONTROL
- TREBLE

- BASS
- BALANCE
- AVL (Auto Volume Leveler)
- Press **▼** to select **PICTURE / SOUND**.

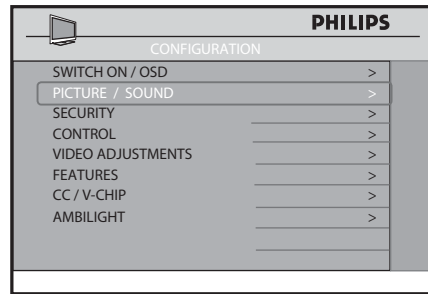

- Press **▶** to enter the **PICTURE / SOUND** menu.

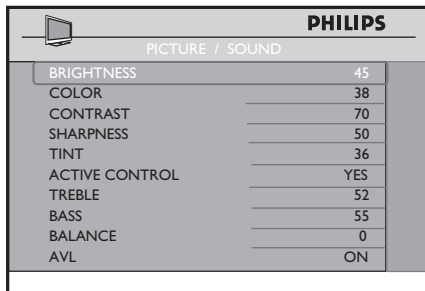

- Press **▲ ▼** to select the item you want to configure.
- Press **◀ ▶** to make adjustments or to select an option.

**Specifying the security options**

In the **CONFIGURATION** menu, the **SECURITY** feature allows you to select an option to enable access to the **SETUP** menu without a RC2573GR setup remote control.

The **SECURITY** feature allows you to select and configure the settings and options for:

- SECURITY



- KEYBOARD LOCK
- REMOTE CONTROL LOCK
- DECRYPTION CONTROL
- VTRACK
- Press ▼ and select **SECURITY**.

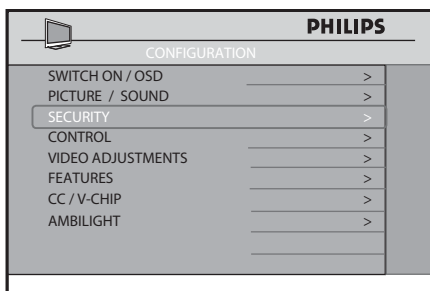

- Press ► to enter the **SECURITY** menu.

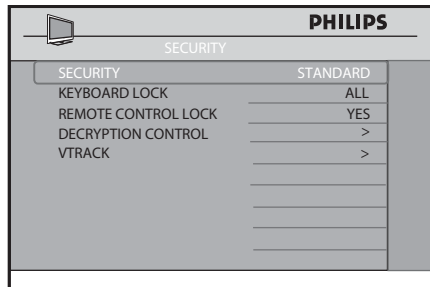

- Press ▲ ▼ to select the item you want to configure.
- If **STANDARD** is selected in the **SECURITY** menu, the **TV SETUP** menu can be accessed by entering a special security code with a guest remote control. Contact the Philips Commercial Solutions Customer Care Center at +1 866 497-4225 should you require further assistance.
- If **HIGH** is selected, the TV setup menu can be accessed only with a RC2573GR setup remote control in setup mode.

ⓘ **Note:** The default security setting is **STANDARD**. When the security setting

is in **STANDARD** mode, it may be vulnerable to unauthorized operations.

- In the **KEYBOARD LOCK** option.
  - Select **YES** to lock the TV keyboard buttons except for the **POWER** button.
  - Select **ALL** to lock all the TV keyboard buttons including the **POWER** button.
  - Select **NO** to unlock all the TV keyboard buttons.

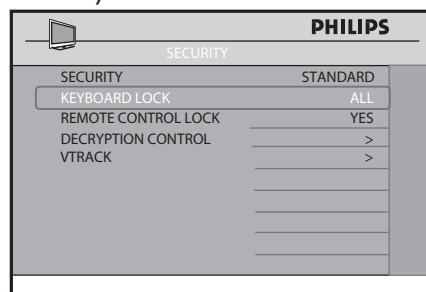

- Press ▼ to select **REMOTE CONTROL LOCK**.

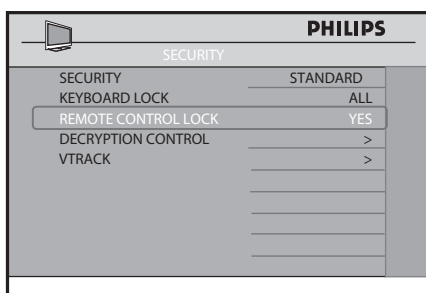

- Press ► to select **YES** to lock all the guest remote control buttons.

### Convert the TV set from a Pay-Per-View mode

The **DECRYPTION CONTROL** option allows you to convert the TV set from a Pay-Per-View content protected mode to a Stand-alone protected mode.

- Press ▼ to select **DECRYPTION CONTROL**

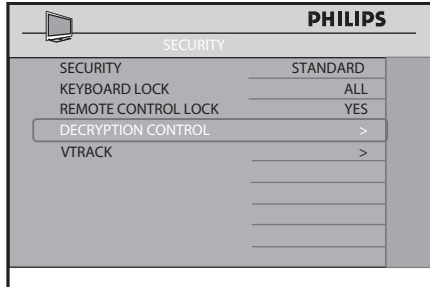

- Press ► to enter the **DECRYPTION CONTROL** menu.

**Note:** The first four items in the **DECRYPTION CONTROL** menu are for your information only.

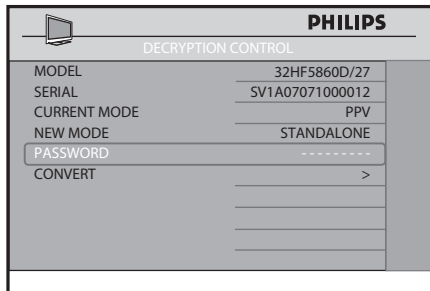

- Key in the password (9 digits). For the password, contact the Philips Commercial Solutions Customer Care Center at +1 866 497-4225 for further assistance.
- **Note:** You are allowed three attempts to key in the correct password.

- Press ▼ to select **CONVERT**.

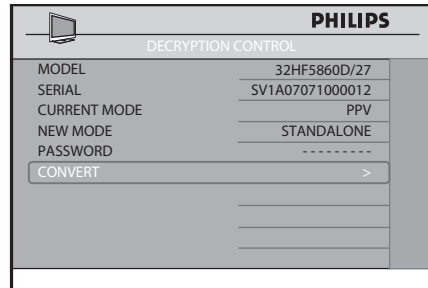

- Press ► to start conversion.

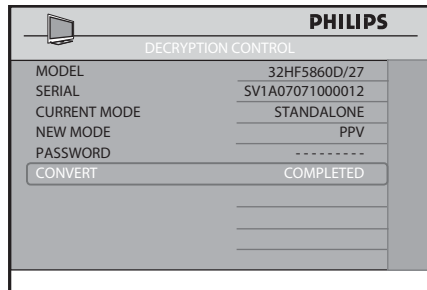

- If the conversion is successful, the **CONVERT** item will show **COMPLETED**. If it shows **FAILED**, go back to **PASSWORD** and key in your password again.
- **CURRENT MODE** will now show **STANDALONE** and **NEW MODE** will show **PPV**.
- If at the third attempt, the password is still incorrect, it will show **LOCKED**. No conversion is done. To unlock, put the TV to stand-by mode. Pull out the mains cord from the mains and re-insert mains cord to the mains.
- To repeat the conversion, you need to enter the **CONFIGURATION** menu and select **SECURITY**. Enter into the **SECURITY** menu and select **DECRYPTION CONTROL** and repeat the steps in the **DECRYPTION CONTROL** section.

### Using V-Track to watermark

**VTRACK** allows you to activate the watermarking functionality of the TV. This prevents the copying of content from the TV.

- Press ► to enter the **VTRACK** menu.

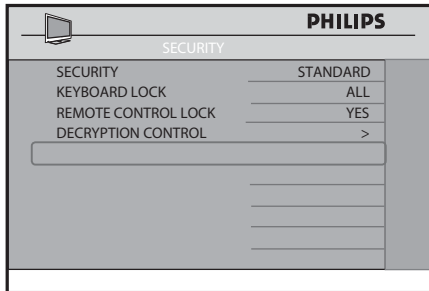

- Press ► to select **YES**, so that watermarking is turned on.

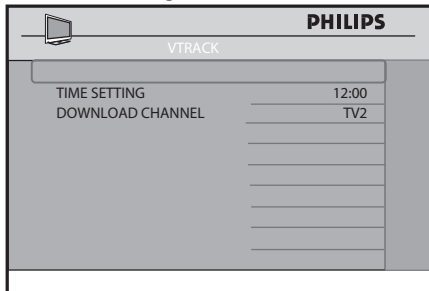

- The **TIME SETTING** option allows you to manually enter the time.

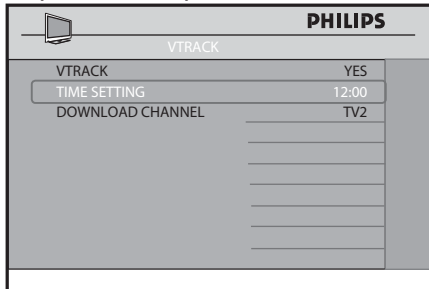

- The **DOWNLOAD CHANNEL** option allows you to select a channel from where the time is retrieved.

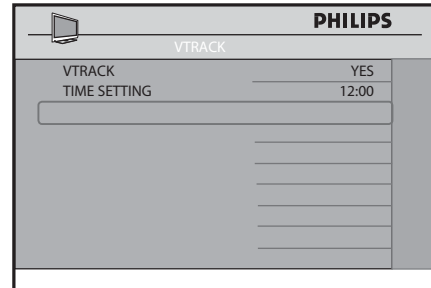

### Configuring the control options

The **CONTROL** menu allows you to select and configure the settings and options for:

- ESP (Energy Saving Programmability)
- DIGIT TIMEOUT
- 3 DIGIT ENTRY
- SOURCE MENU ITEM
- CHANNEL GUIDE
- MIN VOLUME (Minimum volume)
- MAX VOLUME (Maximum volume)
- Press ► to enter the **CONTROL** menu.

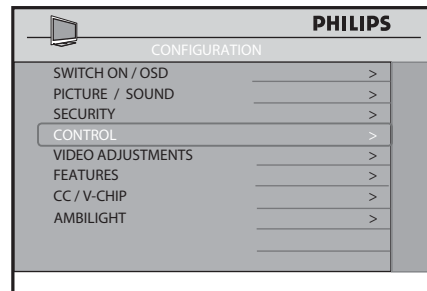

- Press ▲ ▼ to select the item you want to configure.

PHILIPS	
CONTROL	
ESP	OFF
DIGIT TIMEOUT	3.0
3 DIGIT ENTRY	NO
SOURCE MENU ITEM	NO
PIC FMT MENU ITEM	NO
CHANNEL GUIDE	NO
MIN VOLUME	10
MAX VOLUME	35

PHILIPS	
CONTROL	
ESP	2
DIGIT TIMEOUT	3.0
3 DIGIT ENTRY	NO
SOURCE MENU ITEM	NO
PIC FMT MENU ITEM	NO
CHANNEL GUIDE	NO
MIN VOLUME	10
MAX VOLUME	35

- The **ESP** (Energy Saving Programmability) option allows you to select a specified period of time (from 1 HR / 2 HR ..... / 99 HR) to power down your TV automatically. If it does not receive any commands during this period from the remote control or the TV keyboard, this energy saving feature will take effect.

**Note:** If a remote or keyboard command is received before the ESP time period expires, the Timer will reset and begin counting down again.

PHILIPS	
CONTROL	
ESP	2
DIGIT TIMEOUT	3.0
3 DIGIT ENTRY	NO
SOURCE MENU ITEM	NO
PIC FMT MENU ITEM	NO
CHANNEL GUIDE	NO
MIN VOLUME	10
MAX VOLUME	35

- The **DIGIT TIMEOUT** option allows you to specify a time period (from 1 to 9.9 seconds) for the channel to switch to another channel when you key in the channel number. It is advisable not to specify too short a time period especially when you want to key in 2 or 3 digit channel numbers.

**Note:** The recommended and default setting is 3.0 seconds.

- Select **YES** to enable channel selection of 1 to 250 for cable mode and 2 to 250 for antenna mode. Select **NO** to enable channel selection from 1 to 99 for cable mode and 2 to 99 for antenna mode.

PHILIPS	
CONTROL	
ESP	2
DIGIT TIMEOUT	3.0
3 DIGIT ENTRY	YES
SOURCE MENU ITEM	NO
PIC FMT MENU ITEM	NO
CHANNEL GUIDE	NO
MIN VOLUME	10
MAX VOLUME	35

- SOURCE MENU ITEM** allows you to remove Source from the options menu the guest can see. The guest will not have access to any inputs not mapped to a channel in this case.
- If **YES** is selected, Source will appear in the options menu. If you select **NO**, Source will not appear.

PHILIPS	
CONTROL	
ESP	2
DIGIT TIMEOUT	3.0
3 DIGIT ENTRY	NO
SOURCE MENU ITEM	YES
PIC FMT MENU ITEM	NO
CHANNEL GUIDE	NO
MIN VOLUME	10
MAX VOLUME	35

- **PIC FMT MENU ITEM** allows you to remove Picture Format from the options menu the guest can see. The guest will not have access to change the picture formats.
  - If **YES** is selected, Picture Format will appear in the options menu. If you select **NO**, Picture Format will not appear.

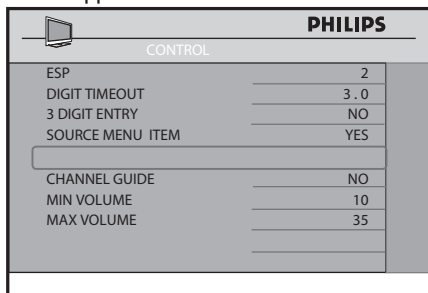

- The **CHANNEL GUIDE** is an on-screen guide of channels that can be used for displaying the channels programmed into the TV. The guide will only function for channels you have labeled (see *Naming a channel* on page 18). This feature is useful for showing your guests where channels or inputs are mapped and is usually not used in a PPV system as the PPV system has its own map and guide.
- In the **CHANNEL GUIDE** option, select **YES** to enable the Channel Guide.

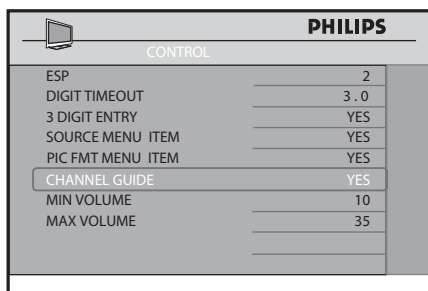

- **MIN** and **MAX VOLUME** options allows you to specify the limit setting for Minimum and Maximum Volume.

### Adjusting the picture horizontally and vertically

The **VIDEO ADJUSTMENT** option allows you to adjust the picture horizontally and vertically. This is useful for configuring channels that have tickers or scrolling banners at the bottom such as news and sports channels.

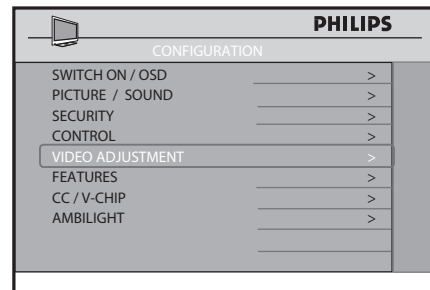

- Press **▶** to enter the **VIDEO ADJUSTMENT** menu.

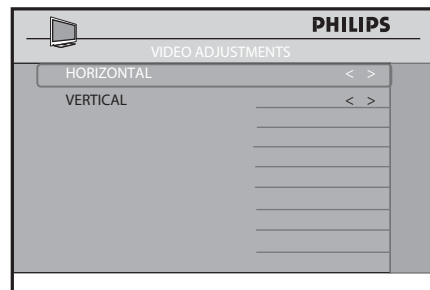

- Press **▲ ▼** to select the item you want to configure.
- Press **◀ ▶** to make adjustments.

### Configuring the features options and settings

- Press **▶** to enter the **FEATURES** menu.

Select and configure the settings and options for:

- SMARTPOWER
- SMART SOUND KEY
- DEFAULT HDMI 1 AUDIO
- DEFAULT HDMI 2 AUDIO
- LOW POWER STANDBY
- LOUD SPEAKER MUTE
- USB BREAK-IN
- SW DOWNLOAD

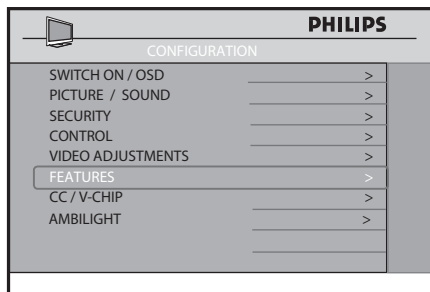

- Press ▲ ▼ to select the item you want to configure.
- Press ◀ ▶ to select options.

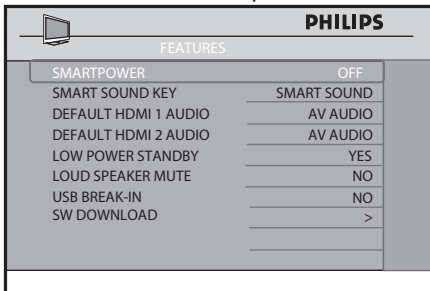

- The **SMARTPOWER** option allows you to put the TV in an energy saving mode which can save up to 30% in energy consumption costs.
- Select from **LOW, MEDIUM** or **HIGH** to activate energy saving mode.

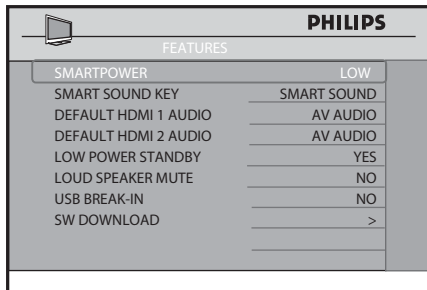

- In the **SMART SOUND KEY** option, select **AUDIO SELECT** to allow you to configure the Smart Sound button on the Guest remote control to toggle the different audio sources and smart sound settings.

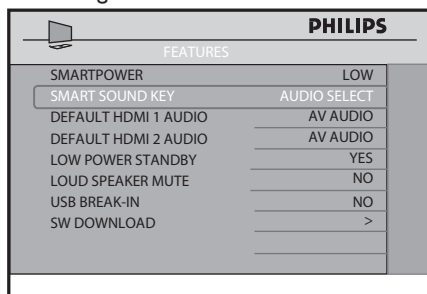

- Select **SMART SOUND** to listen to different **SMART SOUND** modes.

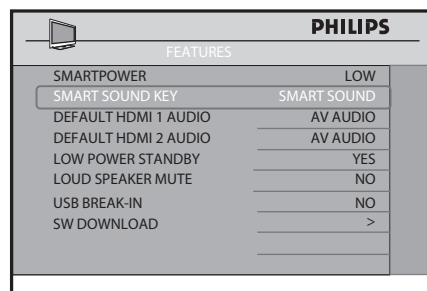

**DEFAULT HDMI AUDIO 1 and 2** allows you to select the HDMI Audio from different Sources. This feature is particularly useful for connecting DVI sources to this television.

DVI Video can convert easily to HDMI with a simple adaptor; but the audio signal is not present and must then be connected to one of the other inputs on the TV. This feature allows you to match the DVI video to the Audio signal you have connected. The ports are distinguished from each other by 1 and 2.

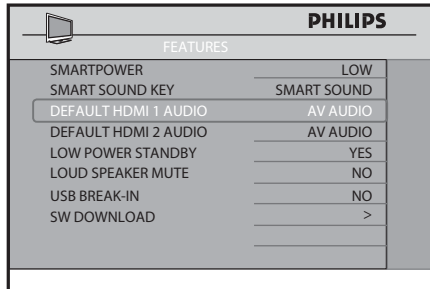

- By default, the **LOW POWER STANDBY** option is set to **YES**. If an interactive SmartCard is used with the TV, set the **LOW POWER STANDBY** option to **NO**.

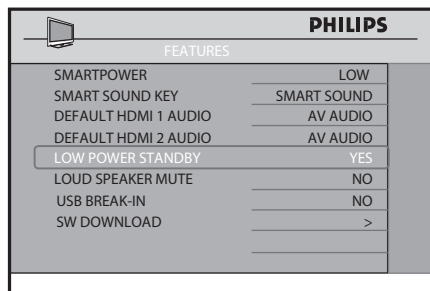

- In the **LOUD SPEAKER MUTE** option, select **YES** to mute the TV speakers permanently.

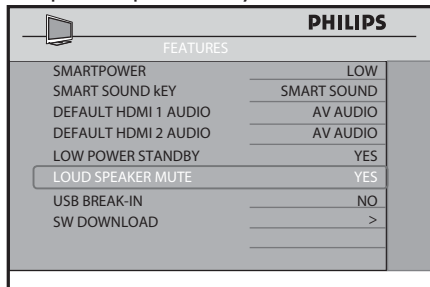

- When inserting a USB device, the channel will be automatically switched to the USB directory using **USB BREAK-IN**. Select **YES** to enable this option.

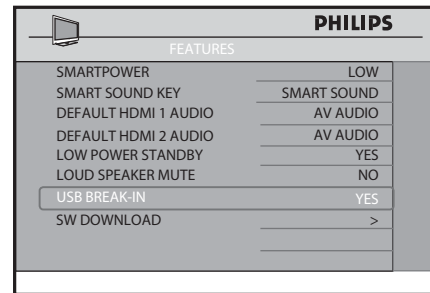

#### Software downloading and cloning

The **SW DOWNLOAD** feature allows you to upload and download the TV software and settings via USB or \*RF. This includes Cloning.

\*Only available on certain models.

- Select **SW DOWNLOAD**.

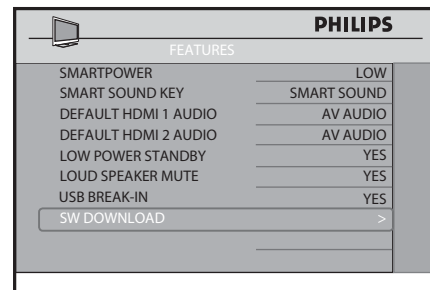

- Press ► to enter **SW DOWNLOAD** menu.
- In the **SOURCE** option, select either **USB** or **RF**. **USB** is the default option.

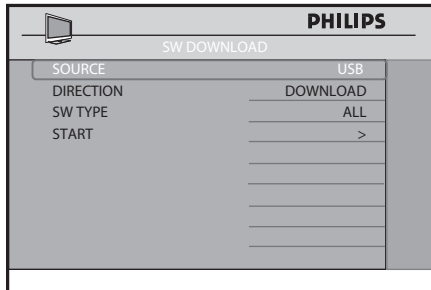

- **IBOARD FIRMWARE** (only download)

- If **ALL** is selected, all the TV software and settings available on the USB device are downloaded.

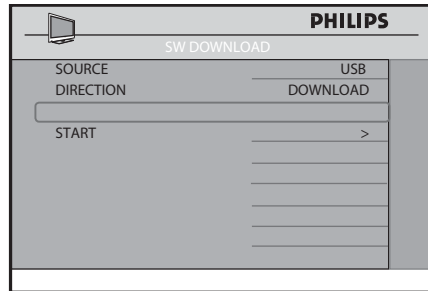

### USB Source

- Select **USB** to upload or download from a USB device.
- In the **DIRECTION** option, select **DOWNLOAD** to download the software from the USB device. Select **UPLOAD** to upload the cloning information to the USB device.

- If **CLONE DATA** is selected, **SSB NVM** and **IBOARD NVM** are updated from the USB Device. These are the components necessary for cloning the setup configurations.

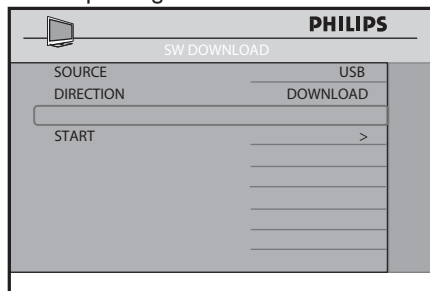
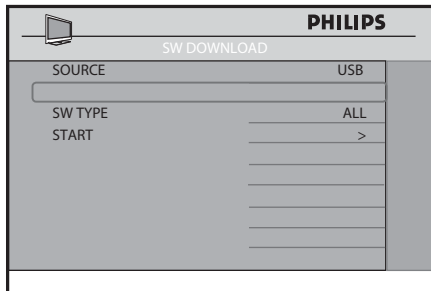

- In the **SW TYPE** option, select the type of software or cloning information to be downloaded. The types of software available are:

- **ALL**
- **CLONE DATA**
- **SSB NVM**
- **SSB FIRMWARE** (only download)
- **STANDBY FIRMWARE** (only download)
- **IBOARD NVM**

- If **SSB NVM** is selected, the **SSB NVM** is updated from the USB device.

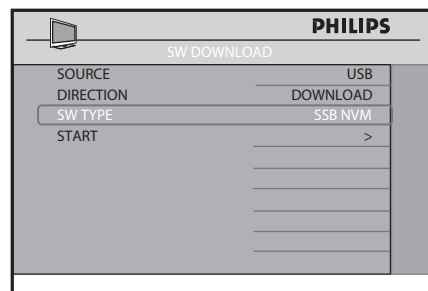



- If **SSB FIRMWARE** is selected, the digital module software, including MPEG 2 and MPEG 4, is updated from the USB device.

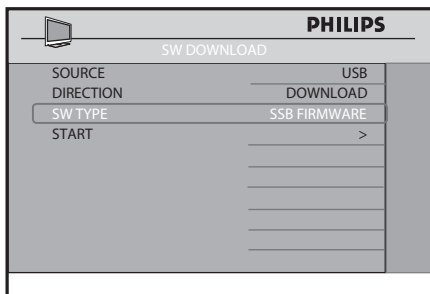

- If **STANDBY FIRMWARE** is selected, the startup data is updated from the USB device.

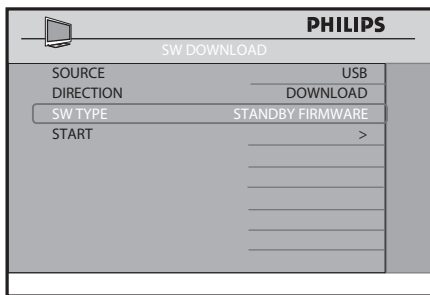

- If **IBOARD NVM** is selected, the TV settings are updated from the USB device.

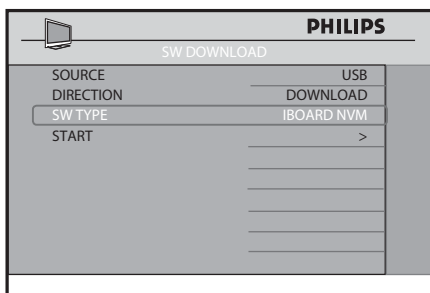

- If **IBOARD FIRMWARE** is selected, the iboard software is updated from the

USB device.

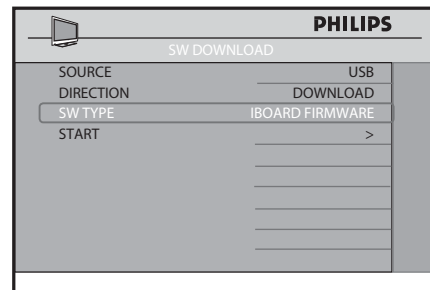

- After all the selections for the **SW DOWNLOAD** have been completed, select **START**.

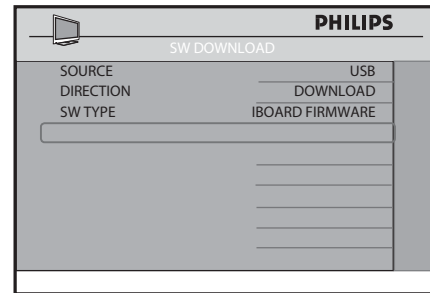

- Press ► to start. The TV will start to perform the SW download. Upon successful downloading, the TV will shut down and re-start automatically.

**Note:** It is strongly recommended in the **SW TYPE** to select **ALL**. This ensures all available software upgrades are installed.

#### RF Source

\*Only available on certain models.

- If **RF** is selected in the **SOURCE** option, only downloading can be performed.

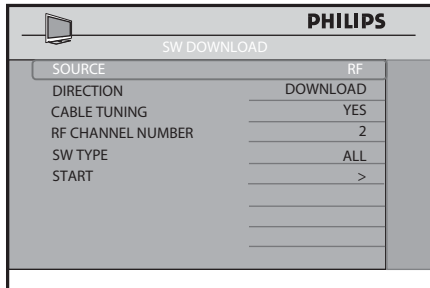

- In the **CABLE TUNING** option, If **YES** is selected, Channels 1 to 135 are available for selection at the **RF CHANNEL NUMBER** option. If **NO** is selected, only Channels 2 to 69 are available for selection.

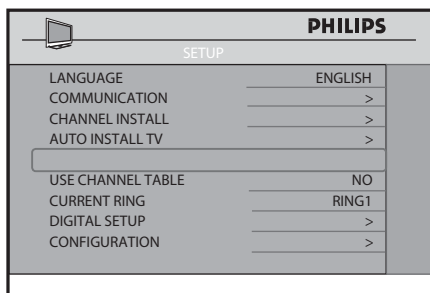

- In the **SW TYPE** option, select the type of software or cloning information to be downloaded. The types of software available are:
  - ALL**
  - SSB NVM**
  - SSB FIRMWARE** (only download)
  - STANDBY FIRMWARE** (only download)
  - IBOARD NVM**
  - IBOARD FIRMWARE** (only download)
- Press ► to start. The TV will start to perform the SW download. Upon successful downloading, the TV will shut down and re-start automatically.

### Configuring the CC (Closed Caption) / V-CHIP options and settings

The **CC / V-CHIP** menu allows you to select and configure the settings and options for:

- SAVE CC
- CC
- SAVED V-CHIP
- V-CHIP MENU ITEM
- V-CHIP SETUP

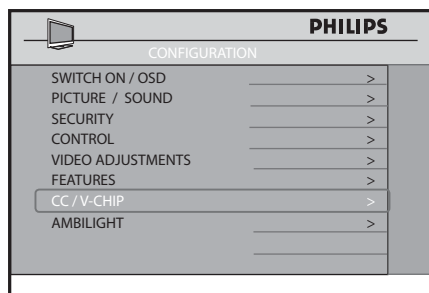

- The **SAVE CC** option allows the TV to remain in whatever CC mode the last guest selected, rather than returning to the default setting you specify in the next step.

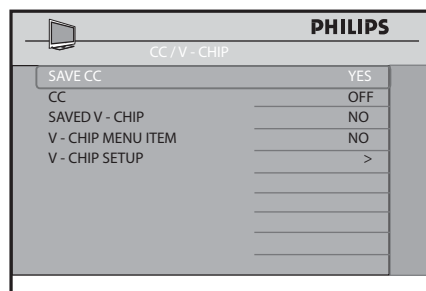

- OFF** is the default CC mode. As long as **SAVE CC** is set to **NO** the TV will always power up with CC in the mode specified here. The options are **ON**,

**OFF and ON MUTE.**

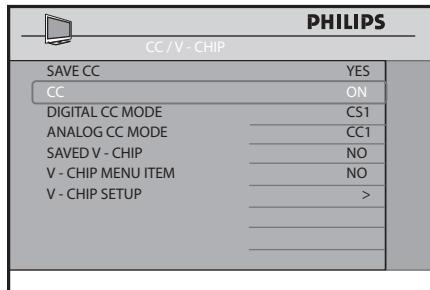

the V-CHIP settings.

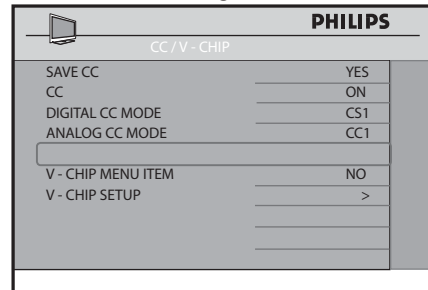

**Note:** CC MODE only appears when CC is ON

- The **DIGITAL CC MODE** option allows you to set your digital CC options from **CS1** to **CS6**. In the **ANALOG CC MODE** option, it allows you to set your analog CC options from **CC 1** to **CC 4** and **TXT 1** to **TXT 4**.

**Note:** If Digital CC option that was selected is not available in the current digital channel, the TV will switch to Analog CC mode.

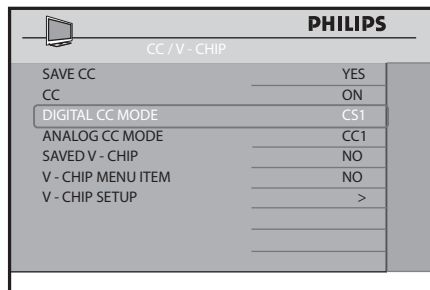

- In the **V-CHIP MENU ITEM** option, select **YES** to allow the guest to change all the V-CHIP settings.

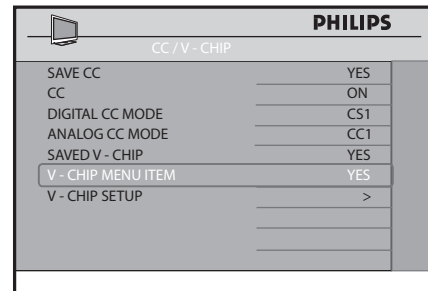

In the **V-CHIP SETUP** option, proceed by pressing ► to change the V-CHIP settings

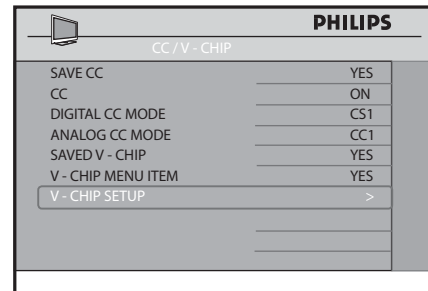

- Go to the **SAVED V-CHIP** option and select **YES** to allow the guest to save all

## 10.10 Change Ambilight settings

**Note:** This feature is only available for certain models.

This section describes how to adjust your Ambilight settings.

### Configure Ambilight

The **AMBILIGHT** menu allows you to select and configure the settings and options for:

- AMBILIGHT
- BRIGHTNESS
- MODE
- COLOR
- CUSTOM COLOR
- SEPARATION
- COLOR BOOST
- BALANCE

1. Press ► to enter the **AMBILIGHT** menu.

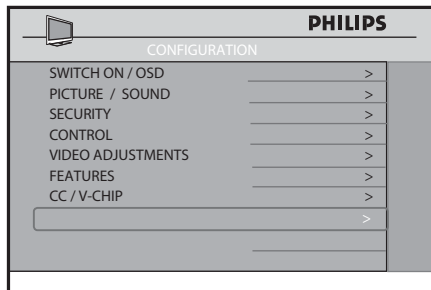

2. Press ► to turn ambilight **ON**.

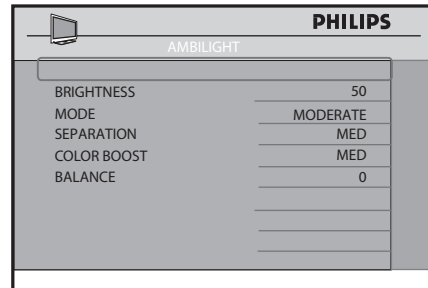

- The **BRIGHTNESS** option allows you to change the brightness of the ambilight. Press ◀ ▶ to make these adjustments.

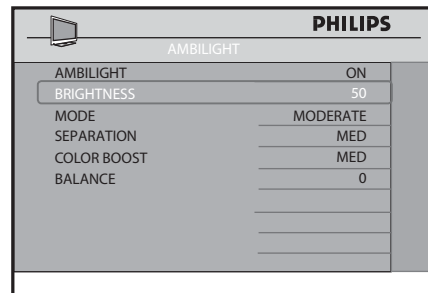

- In the **MODE** option, select between **COLOR, RELAXED, MODERATE, DYNAMIC.**

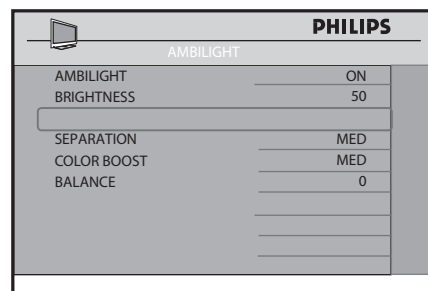

- If **COLOR** is selected, a new menu item, **COLOR**, appears. Choose from **COOL WHITE, WARM WHITE, BLUE** and

### CUSTOM.

PHILIPS	
AMBILIGHT	
AMBILIGHT	ON
BRIGHTNESS	50
MODE	COLOR
[ ]	
SEPARATION	MED
COLOR BOOST	MED
BALANCE	0

### LOW, MED and HIGH.

PHILIPS	
AMBILIGHT	
AMBILIGHT	ON
BRIGHTNESS	50
MODE	COLOR
COLOR	CUSTOM
CUSTOM COLOR	>
[ ]	
COLOR BOOST	MED
BALANCE	0

- If **CUSTOM** is selected, a new menu item, **CUSTOM COLOR**, appears. Press ► to enter the sub menu.

- The **COLOR BOOST** option allows to configure the amount of color boosting to be present. Choose from **LOW**, **MED** and **HIGH**.

PHILIPS	
AMBILIGHT	
AMBILIGHT	ON
BRIGHTNESS	50
MODE	COLOR
COLOR	CUSTOM
[ ]	
SEPARATION	MED
COLOR BOOST	MED
BALANCE	0

PHILIPS	
AMBILIGHT	
AMBILIGHT	ON
BRIGHTNESS	50
MODE	COLOR
COLOR	CUSTOM
CUSTOM COLOR	>
SEPARATION	MED
COLOR BOOST	MED
BALANCE	0

- The **PALETTE** option allows you to choose your color. The **SATURATION** option allows you to select the strength of the color.

- The **BALANCE** option allows you to change the balance between the left and right ambilight bar. 0 is the the default and recommended option.

PHILIPS	
CUSTOM COLOR	
SATURATION	80

PHILIPS	
AMBILIGHT	
AMBILIGHT	ON
BRIGHTNESS	50
MODE	COLOR
COLOR	CUSTOM
CUSTOM COLOR	>
SEPARATION	MED
COLOR BOOST	MED
BALANCE	0

- The **SEPERATION** option allows you to select the maximum amount of seperation between colours. Select from

- Press **M** to exit.

## 11. Appendix A

### Support for multiple remote controls

#### Programming the Multi Remote Controls function

**Multi RC** function supports up to four TV sets operating in one room without any interference from each other remote controls. Each Guest Remote Control must be programmed individually to one of the four color (Blue, Yellow, Green and Red) buttons on the remote control.

1. Press the **(M)** button on the green remote control (RC2573GR) to activate the TV **SETUP** Menu.
2. Press **▼** to select **COMMUNICATION**.

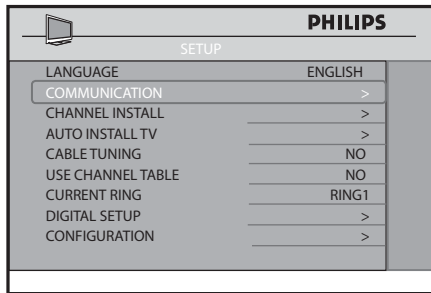

3. Press **▶** to enter the **COMMUNICATION** menu.

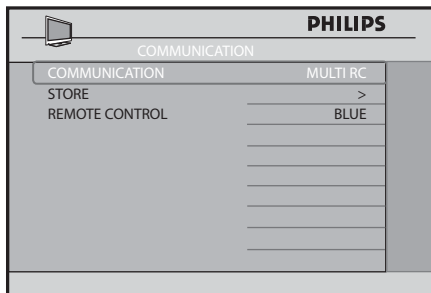

4. Press **▶** repeatedly until **MULTI RC** is selected.

38

5. Press **▼** to select **REMOTE CONTROL**.

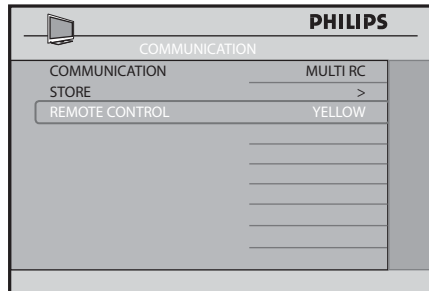

6. Press **▶** repeatedly to toggle through the four colors and select your preferred color.
7. Press **▲** to select **STORE** and press **▶** to store your selection. Press **(M)** to exit menu.
8. Using the Guest Remote Control, press **MENU** and any color key simultaneously to set the remote control to the corresponding color that you have selected in the **REMOTE CONTROL** option. If **BLUE** is selected on the **REMOTE CONTROL** option, correspondingly, you must select **BLUE** on the Guest Remote Control.

You can now use the Guest Remote Control to operate the TV set.

9. To check whether you have programmed the **MULTI RC** function correctly, aim the Guest Remote Control at the TV and press **OK** for five seconds.

Information of the Remote Battery, Remote Color and the TV Color are shown on the screen. If the Remote Color and the TV Color do not match, you need to re-programme and ensure they match to enable the Guest Remote Control to operate the TV.

## 12. Definitions, acronyms and abbreviations

A/V	Audio / video.
Bit Rate	Sometimes written “bitrate”, the frequency at which bits are passing a given (physical or metaphorical) “point”, quantified in terms of bits per second (bit/s).
CVI	Component video input. Sometimes used interchangeably with “YPbPr”.
CVBS	Composite Video Broadcast Standard. Video signal containing combined color, luminance, and synchronization signals. Also often referred to as “AUX” video.
DB-9	Standardized 9-pin connector; typically used for RS-232 asynchronous serial communications.
DB-15	Standardized 15-pin connector; typically used for VGA / computer display signals.
DCM	Data Communications Module. PCS terminology for devices that communicate with Philips Commercial Solutions products by means of the Philips SmartPort protocol.
DFU	Directions For Use. Philips Consumer Electronics term for product instruction documentation.
DHCP	Dynamic Host Configuration Protocol. A protocol used on TCP/IP networks. Allows client configuration (TCP/IP address, default gateway, DNS configuration, etc.) to be sent to clients.
DNS	The network service used in TCP/IP networks that translates host names to IP addresses.
DVI	Digital Visual Interface, a digital interface standard created by the Digital Display Working Group (DDWG) to convert analog signals into digital signals to accommodate both analog and digital monitors.
HTML	Hypertext Markup Language. The set of markup symbols or codes inserted in a file intended for display on a World Wide Web browser page.
IR	Infrared, long-wavelength light energy invisible to the human eye. In this context as applied to wireless remote controls.
MP3	A compressed digital audio format. MPEG (Motion Pictures Experts Group) Layer 3 Audio compression.
NVM	Non-Volatile Memory.
MPEG	Moving Picture Experts Group. General term for a range of audio and video compression, and the name of the standards organization for digital video and digital audio compression. Operates under the auspices of the International Organisation for Standardization (ISO).
NA	Not available, not applicable.
NC	Not connected, no connection.
Off	See “Stand-by”.

On	A state of operation in which the unit (television) is connected to an AC power source, in active use, and capable of responding to queries or commands from a control device (IR remote control) and/or DCM.
OSD	On-Screen Display. The display of alphanumeric text that appears over the video image. Typically generated by a character generator usually integrated into the television chassis control processor.
PCS	Philips Commercial Solutions. A commercial / non-consumer division of Philips Consumer Electronics. Co., formerly known as Philips BDS, Business Display Solutions.
Plug	Connector on a cable that connects to a plug.
PPV	Pay Per View.
RC	Remote control.
RC-5, RC-6	Philips IR remote control communication protocol.
RJ-12	Registered jack 12. Modular telephone-style connector form factor with 6 electrical conductors.
Router	Technically, also known as a Layer 2 Switch. A switching hub that operates at the Data Link Layer (Layer 2), and builds a table of the MAC addresses of all the connected stations.
RTSP	Real-Time Streaming Protocol. Allows control of multimedia streams delivered, for example, via RTP (RFC 3389, Real-time Transport Protocol Payload). Control includes absolute positioning within the media stream, recording and possibly device control.
RTP	Real-time Transport Protocol. Defines a standardized packet format for delivering audio and video over the Internet.
Setup Mode	See System 7. Remote control mode used to configure Philips Institutional Televisions for specialized and/or restricted features such as front panel lockout, volume range, channel list, etc..
SmartPort™	Philips proprietary three-wire synchronous serial communications and control interface.
SmartPlug™	See SmartPort.
Socket	Connector on a cable that connects to socket.
SBB	Set-back box. Used interchangeably with "set-top box". General term for a device that adds functionality to, and / or interfaces a television with, a host content- and/or control- environment.



STB	Set-top box. See SBB.
Stand by	Generally referred to as "off". A state of operation, characterized by relatively low power consumption, in which the unit (television) is connected to an AC power source, but not in active use, and capable of responding to queries or commands from a control device and/or DCM.
System 0	First data word of a Philips RC-5 / RC-6 remote control code for standard television commands. Synonymous with Philips Commercial Solutions "guest" mode.
System 7	First data word of a Philips RC-5 / RC-6 remote control code reserved for specialized commands. Used for Philips Commercial Solutions "setup" mode.
TCP	Transmission Control Protocol / Internet Protocol. De facto standard protocol for Internet communications.
UDP	User Datagram Protocol. A minimal message-oriented transport layer protocol that is currently documented in IETF RFC 768. Used by Philips NetLink to issue device discovery packets.
YPbPr	Component video signals consisting of luminance, and blue and red components.

---

## 13. USA limited warranty

Thank you for purchasing this PHILIPS branded Commercial Television.



All Philips branded commercial televisions are designed and manufactured to high standards and deliver high-quality performance. Within the first year of purchase, this two-year Limited Warranty may entitle you to receive an “Advance Exchange<sup>\*</sup>” model on-site within 72 hours of qualification. Within the second year of purchase, this two-year Limited Warranty may entitle you to receive an “Advance Exchange<sup>\*</sup>” model on-site delivered via Ground Transportation.

### Philips' Commercial Television

For more information on this and more great Philips products visit our web site at:

[HTTP://WWW.PHILIPS.COM/HOSPITALITY](http://www.philips.com/hospitality)

### Philips F1rst Choice Limited Warranty

One Year 72 hour Advance Exchange<sup>\*</sup> / Two Years Advance Exchange<sup>\*</sup>

### WHO IS COVERED?

The original purchaser for end use. You must have a sales receipt or other document showing that you purchased the Product. Please retain and store your Proof of Purchase securely.

### WHAT IS COVERED?

Defects in materials and workmanship if a valid claim is received by Philips within the Warranty Period. When the warranty on the purchased product expires, the warranty on all exchanged products (including their parts and service labor) also expires.

### WHAT IS THE PERIOD OF COVERAGE?

Two (2) years. For two (2) years from the date of purchase, as evidenced by your proof of purchase, Philips will provide an “Advance Exchange” subject to the terms and conditions herein.

## **WHAT WE WILL DO TO CORRECT PROBLEMS?**

\*For the first year, the defective Product will be exchanged with a new Product (or one that has been renewed to original specifications) and delivered within seventy-two hours of qualification. During the second year, the defective product will be exchanged with one that has been renewed to original specifications and delivered via Ground Transportation. In the event of a failure of multiple units at the same location, Philips reserves the right at its sole discretion to send personnel to the location to determine the cause of the failure and determine the most efficient means of resolving the failure.

## **WHAT IS EXCLUDED?**

- unless otherwise provided for herein, shipping charges to return defective products to Philips.
- unless shipped by Philips, damage to or loss of product during shipment.
- labor charges for installation or setup of the product, adjustment of customer controls on the product, and installation or repair of antenna systems outside of the product.
- product repair and/or part replacement because of accident, misuse, unauthorized repair or other cause not within the control of Philips.
- reception problems caused by signal conditions or PPV, cable, or antenna systems outside the unit. o modifications or adaptations to enable a product to operate in any country other than the country for which it was designed, manufactured, approved
- and/or authorized, or repair of products damaged by such modifications or adaptations.
- modifications or adaptations to enable a product to operate with any PPV system other than the PPV systems for which it was designed, manufactured, approved, and/or authorized, or repair of products damaged by such modifications.
- CONSEQUENTIAL, INCIDENTAL, INDIRECT OR SPECIAL DAMAGES RESULTING FROM THE PRODUCT, INCLUDING BUT NOT LIMITED TO DAMAGES FOR LOST DATA, LOST SOFTWARE, OR LOSS OF USE OF THE PRODUCT. (Some states do not allow the exclusion of such damages, so the above exclusion may not apply to you. This provision also excludes such damages for prerecorded material, whether copyrighted or not copyrighted, among all other potential claims.)
- products on which the model, production or serial number has been altered, deleted, removed or made illegible.
- product sold AS IS or Renewed.

## **HOW TO GET WARRANTY SERVICE IN U.S.A., PUERTO RICO OR U.S. VIRGIN ISLANDS? OR WHERE CAN I GET MORE INFORMATION?**

Before requesting service, please check your owner's manual as adjustments of the controls discussed there may save you a service call. Also, please prepare the following details so we can solve your problem quickly.

- Philips type number
- Philips serial number
- Purchase date (copy of receipt of purchase may be required)
- Pay Per View Provider (if any)
- High Definition signals offered at property (if any)
- Your proof of purchase indicating: date of purchase, dealer name, model and product serial number.
- The full address to which the swap model should be delivered.

Then, contact Philips Commercial Solutions Customer Care Center at: (866) 497-4225

**(IN U.S.A., PUERTO RICO AND U.S. VIRGIN ISLANDS, ALL IMPLIED WARRANTIES, INCLUDING IMPLIED WARRANTIES OF MERCHANTABILITY AND FITNESS FOR A PARTICULAR PURPOSE, ARE LIMITED IN DURATION TO THE DURATION OF THIS EXPRESS WARRANTY.** But, because some states do not allow limitations on how long an implied warranty may last, this limitation may not apply to you.)

This Limited Warranty gives you specific legal rights. You may have other rights which vary from state to state.

**WARRANTY SERVICE IN CANADA: While this warranty statement is not valid for Canadian purchases, you may be eligible for warranty service. Please contact Philips Canada at: (888) 292-3430**

### **Just a phone call away**

Philips' customer help desks are located worldwide. Within the U.S. you can contact Philips Customer Care Monday-Friday from 8:00 AM-9:00 PM Eastern Time (ET) and on Saturdays from 10:00 AM-5:00 PM ET by using the USA contact phone number listed above.

- To avoid possible shock hazard, please be sure that the television is unplugged from the electrical outlet before cleaning.
- Do not touch the screen with anything hard as this scratch, mark or damage the screen permanently.
- Do not rub with dust clothes with chemical treatment.
- Do not touch the surface with bare hands or greasy cloth (some cosmetics are detrimental to the screen).
- Unplug the TV before cleaning the screen.
- When the surface becomes dusty, wipe gently with absorbent cotton or other soft materials like chamois soaks. Do not use acetone, toluene and alcohol cleaners because they cause chemical damage.
- Do not use liquid or aerosol cleaners.
- Wipe off saliva or water droplets as soon as possible. Long time contact with the screen causes deformations and color fading.
- This Philips Institutional Television product and its packaging contain materials that can be recycled and re-used. Specialized companies can recycle your product to increase the amount of reusable materials and minimize the amounts which need to be properly disposed.
- This product might also use batteries which should not be thrown away when depleted, but should be handed in and disposed of as small chemical waste.
- Please find out about the local regulations regarding the disposal of the television, batteries, and packaging materials whenever you replace existing equipment.
- This product consumes energy in the stand-by mode. Energy consumption contributes to air and water pollution. It is advisable to switch off your television overnight instead of leaving it in stand-by mode.

---

## 14. Cleaning and care

- Do not touch the screen with anything hard as this may scratch, mark or damage the screen permanently.
- Do not rub with dust clothes containing chemical treatment.
- Do not touch the surface with bare hands or a greasy cloth (some cosmetics are harmful to the screen).
- Unplug the TV before cleaning the screen.
- When the surface becomes dusty, wipe gently with absorbent cotton or other soft materials like chamois soaks. Do not use acetone, toluene and alcohol cleaners because they cause chemical damage.
- Do not use liquid or aerosol cleaners.
- Wipe off saliva or water droplets as soon as possible. Long time contact with the screen causes deformations and color fading.

---

## 15. Environmental care

- This Philips Institutional Television product and its packaging contain materials that can be recycled and re-used. Specialized companies can recycle your product to increase the amount of reusable materials and minimize the amounts which need to be properly disposed.
- This product might also use batteries which should not be thrown away when depleted, but should be handed in and disposed of as small chemical waste.
- Please find out about the local regulations regarding the disposal of the television, batteries, and packaging materials whenever you replace existing equipment.
- This product consumes energy in the stand-by mode. Energy consumption contributes to air and water pollution. It is advisable to switch off your television overnight instead of leaving it in stand-by mode.

---

## 16. Index

---

### A

- Accessing Setup Menu 15
- Ambilight
  - Adjust settings 37
  - Change mode 37
  - Color 37
  - Modes 37
- Analog CC Mode 36
- Antenna connection 9
- Antenna mode 21
- Audio Select 31
- Automatic channel tuning 20

---

### B

- Balance, Ambilight 37
- Before calling service 6
- Brightness
  - Ambilight 37

---

### C

- Cable mode 21
- CC (Closed Caption) 35
- Changing channel settings 17
- Channel Guide 30
- Channel Install 17
- Channel Logo selection 18
- Channel selection 17
- Cleaning and Care 46

- Configuration 25
- Control options 29
- Current Ring 22

---

### D

- Decryption Control 27
- Default HDMI Audio 32
- Definitions, Acronyms and Abbreviations 39
- Digital Audio Language 22
- Digital CC Mode 36
- Digital CC Setup 23
- Digital channel options 18
- Digital channel scroll 19
- Digital closed caption setup 23
- Digital Data Firmware 34
- Digital Data Flash 34
- Digital major channel 18
- Digital minor channel 18
- Digital NVM 34
- Digital setup 22
- Digit timeout 29

---

### E

- Emergency alert 24
- Environmental Care 46
- ESP (Energy Saving Programmability) 29

---

### F

- Factory Channel Reset 22

Features 31

---

## **G**

Guest Remote Control keys 13

---

## **I**

Iboard FIRMWARE 34

Iboard NVM 34

Important Safety Instructions 3

---

## **K**

Keyboard Lock 27

---

## **L**

Loud Speaker Mute 32

Low Power Standby 32

---

## **M**

Mains connection 9

Maximum volume 30

Minimum volume 30

MPEG Program number 18

Multi Remote Controls 38

---

## **N**

Naming a channel 19

---

## **O**

48

Optional Remote Controls 12

Overview of TV Connectors and Controls 10

---

## **P**

Physical Channel 21

Picture Format 26

---

## **R**

Remote Control Lock 27

RF Channel Number 18

RF Download 33

---

## **S**

Safety Information and Useful Tips 5

Security 26

Selecting Input Source 17

Selecting Mute Source 20

Smartpower 31

Smart RC 17

Smart Sound Key 31

Software Type 33, 35

Source Menu Item 30

Switching on the TV 9

Switch On/ OSD 25

---

## **T**

Three Digit Entry 30



---

**U**

U.S.A. Limited Warranty 42

Use Channel Table 18

---

**V**

V-Chip Menu Item 36

V-Chip Setup 36

Video Adjustment 30

Virtual Channel 21

---

## 17. Dolby Digital



Manufactured under license from Dolby Laboratories. 'Dolby' and the double-D symbol are trademarks of Dolby Laboratories.

---

## 18. Kensington Security Slot



Your TV is equipped with a Kensington Security Slot, to prevent it from getting stolen. An anti-theft Kensington lock has to be purchased separately. The Kensington lock is a plastic-coated steel cable with a lock. One end has to be fixed to the opening of the TV and locked with a special key. The other end is attached to a fixed point.

® Kensington and MicroSaver are registered US trademarks of ACCO World Corporation with issued registrations and pending applications in other countries throughout the world. All other registered and unregistered trademarks are the property of their respective owners.

## Free Manuals Download Website

<http://myh66.com>

<http://usermanuals.us>

<http://www.somanuals.com>

<http://www.4manuals.cc>

<http://www.manual-lib.com>

<http://www.404manual.com>

<http://www.luxmanual.com>

<http://aubethermostatmanual.com>

Golf course search by state

<http://golfingnear.com>

Email search by domain

<http://emailbydomain.com>

Auto manuals search

<http://auto.somanuals.com>

TV manuals search

<http://tv.somanuals.com>