

DOMETIC CORPORATION, ENVIRONMENTAL DIVISION
P.O. Box 15299 I Richmond, VA 23227 USA
Phone +804 746 1313 | Fax +804 746 7248
www.dometic.com

For
750000005 (TJ18F)
750000011 (TJ22F)
750000026 (TJ18FP3)

Before initiating troubleshooting, the following equipment is recommended:
Multimeter, 20 gauge (min) wires to use as jumpers, and 12Vdc source.

Before applying power, stand unit upright for a minimum of 1 hour to allow compressor oil to settle.

NOTE: Although, Dometic states on the packaging to always keep unit upright, we cannot control how the carrier handles our boxes. This also applies if the unit has been set on its side to affix any accessories.

If there are any questions, please contact our warranty and service department at 1-800-234-8778 or 804-764-1313.

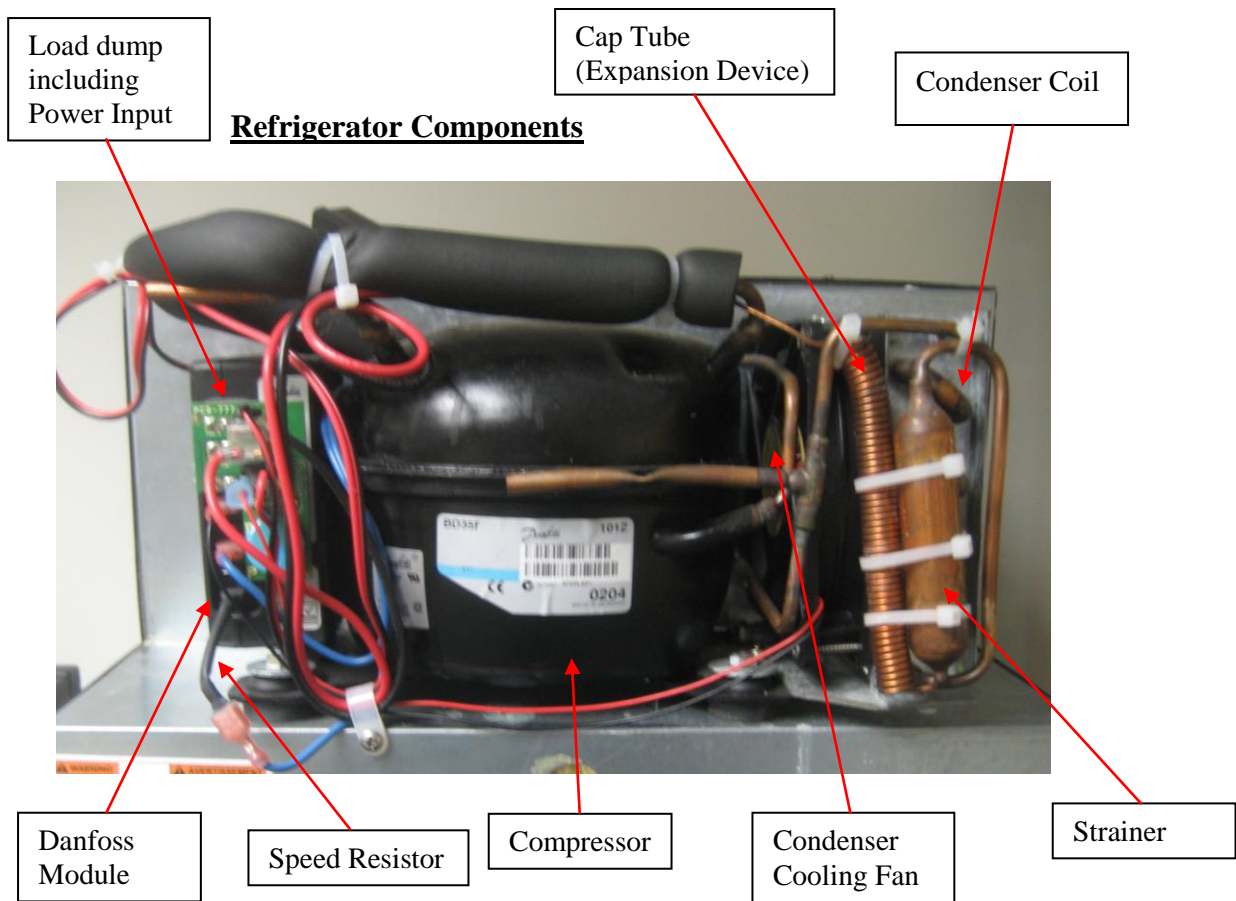

Freightliner Refrigerator Troubleshooting Guide



75000005 (TJ18F)
75000011 (TJ22F)
75000026 (TJ18FP3)

Locating the Dataplate

There are two Dataplates bearing the model number, serial number and technical data. One is located on the right-side panel inside the appliance (fig. 1) and the other is located on the back of the unit (fig 2).



Figure 1

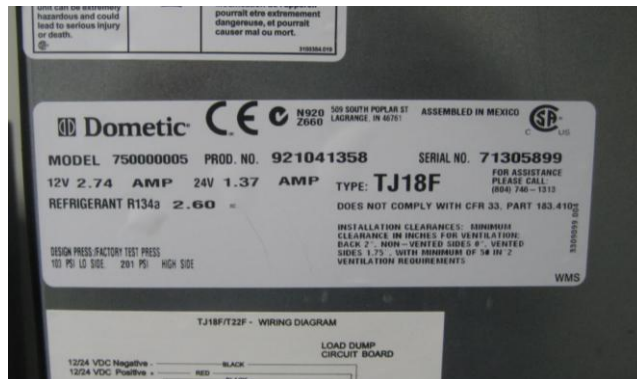

Figure 2

The first three digits of the serial number indicate the Year and Week of manufacture.

Example: the Dataplate above has a serial number of 71305899

7=Year 2007
13=13th week of the year
05899=Sequential Unit Number

TROUBLE-SHOOTING

The guidelines are arranged sequentially and should be followed in order until the problem is solved. Start with “General Trouble-Shooting” sections A and B; then, go to “Specific Trouble-shooting of Electrical Components”, start with section A and work systematically to section D.

Freightliner Refrigerator Troubleshooting Guide



75000005 (TJ18F)
75000011 (TJ22F)
75000026 (TJ18FP3)

General Trouble-Shooting

A: Appliance Does Not Operate. *Check:*

1. The thermostat knob is “ON”, and turned, at least, half way.
2. The electrical system circuit breaker for the refrigerator is “ON”.
3. The fuse between the Danfoss Module electronic control unit and the power source is good.
4. The power supply cable is not faulty, loose or poorly connected.
5. The voltage on the Load Dump module corresponds to that of the battery. If there is a voltage drop of 0.2-0.4v check:



- A. The size of the cable connecting the battery to the Load Dump module corresponds to specifications (see electrical wiring guidelines in this manual).
 - B. All connection points in the power circuit are properly tightened and secure.
 - C. There are no signs of oxidation on the battery poles or contact points and the battery is properly maintained.
6. Insure the LOAD DUMP module is installed properly on the Danfoss Module. The three pins on the LOAD DUMP module must “line up” with the top three pins of the Danfoss Module.

Freightliner Refrigerator Troubleshooting Guide



75000005 (TJ18F)
75000011 (TJ22F)
75000026 (TJ18FP3)

LOAD DUMP
Module

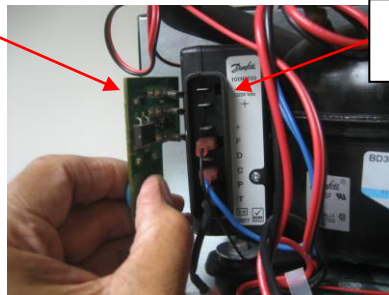

DANFOSS
Module



7. The battery is delivering sufficient power. If the power voltage is less than 10.4VDC, the unit will not operate. Check incoming voltage with multimeter by putting the black lead on the negative terminal of the LOAD DUMP module and the red lead on the positive terminal as shown. Unit must be running to check this function.

Positive Lead
from
Multimeter



Negative lead
from
multimeter

8. If 12 volts are available to the unit as shown in step 7, check to see if the LOAD DUMP module is defective. This module is used as a surge protector for the unit. Removed the module from the unit and remove all wires. Wire the Danfoss module as shown with the wires that were on the LOAD DUMP module.



LOAD DUMP
Module



DANFOSS
Module

See Wiring
Diagram in the
later sections

Freightliner Refrigerator Troubleshooting Guide



75000005 (TJ18F)
75000011 (TJ22F)
75000026 (TJ18FP3)

The LOAD DUMP module is defective if the unit operates while wired to the DANFOSS module. Replace Load Dump module.

9. If LOAD DUMP module is working properly, check the speed resistor. This component is used to control the speed of the compressor and is located on the “T” terminal of the DANFOSS module.

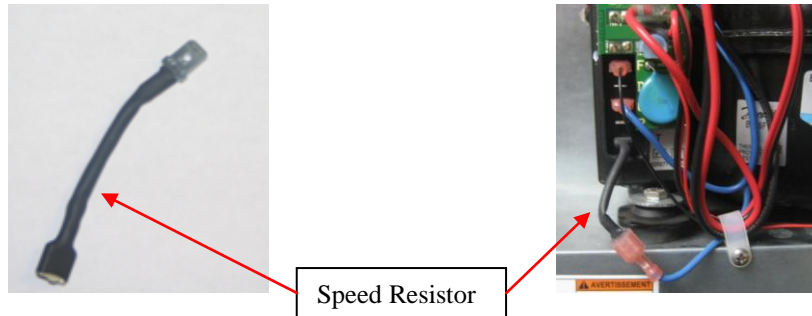

Turn off power and disconnect the speed resistor from the Danfoss module. Remove the speed resistor from the blue wire and connect the blue wire on the Danfoss module terminal “T” where the speed resistor was removed.

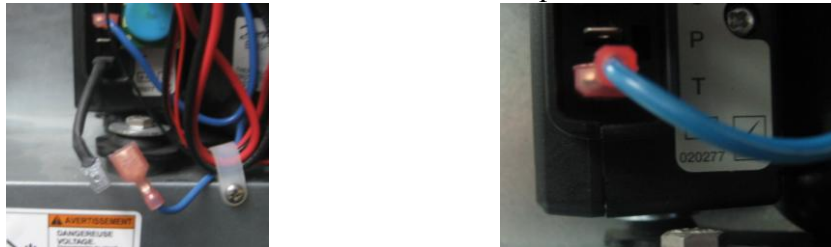

Connect power (12volts) back to the unit. If the unit performs, the speed resistor is faulty. Replace Speed Resistor.

10. Test the Thermostat Circuit. Remove the blue wire that is connected on terminal “C” and remove the (black) Speed resistor (attached to the other blue wire) connected to terminal “T” of the Danfoss module. These two wires represent the thermostat circuit.

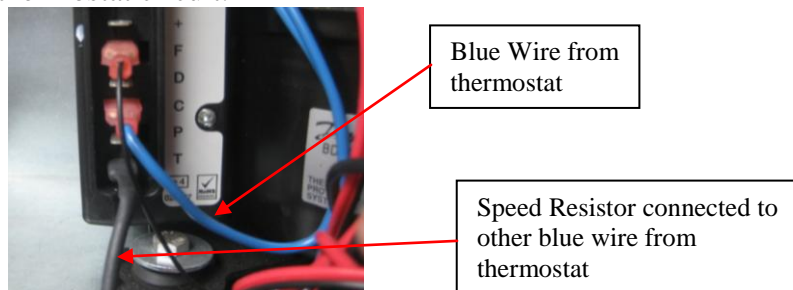

Make sure the thermostat knob is turned on, remove the speed resistor, set multimeter to check continuity and connect meter leads to these wires as shown.

Freightliner Refrigerator Troubleshooting Guide



75000005 (TJ18F)
75000011 (TJ22F)
75000026 (TJ18FP3)



Thermostat knob



lead connections

If the thermostat is working correctly, the multimeter should indicate continuity. In addition, check the speed resistor with the multimeter. This resistor is used to set the compressor motor speed. Connect multimeter leads to either end of resistor assembly and set meter to resistance, Ω . This is a 277-ohm resistor. It should read between 265 and 280 ohms.

11. An additional test to use if a multimeter is not available:

Turn the unit off and disconnect both blue wires that were connected to the Danfoss module terminals "T" and "C". Place the jumper wire across these terminals as illustrated.

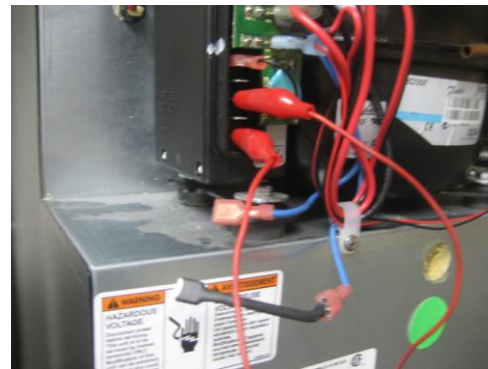
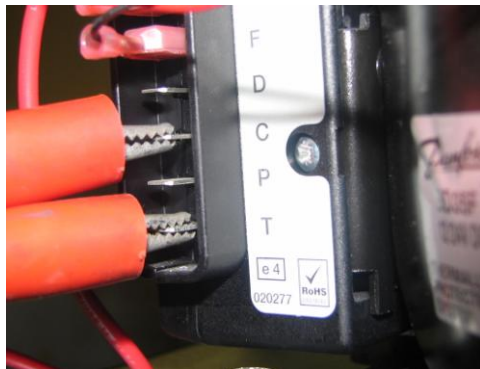

Energize unit and if unit operates, this action indicates the problem may be a bad thermostat. Replace thermostat.

Freightliner Refrigerator Troubleshooting Guide



75000005 (TJ18F)
75000011 (TJ22F)
75000026 (TJ18FP3)

Change DanFoss Module. Isolate unit from its source of energy by disconnecting the power before performing the following procedure:



A. Remove all wires from compressor module and load dump (make note where they are connected).



B. Removed Danfoss module from the compressor by removing the mounting screw and twisting the module to the rear to disconnect it from the compressor.

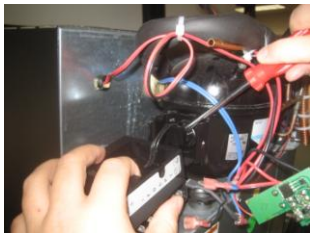

C. Use screw driver to pry connector from compressor terminals. Use caution.

D. If changing the Danfoss module does not fix the problem, this may indicate the compressor is bad.

Freightliner Refrigerator Troubleshooting Guide



75000005 (TJ18F)
75000011 (TJ22F)
75000026 (TJ18FP3)

B: Insufficient Refrigerating Capacity. Check:

1. The door is sealed properly and the refrigerator is not positioned close to heat sources.
2. Ice build up in and on freezer compartment. 1/8" maximum. Defrost Freezer by turning power off and let ice melt. Do not chip ice off freezer compartment because freezer plate can be damaged.
3. The refrigerator is sufficiently ventilated.
4. Dust has not blocked the condenser ventilation sources.
5. The Condenser Cooling Fan rotates freely.
6. The compressor and fan are operating properly. The compressor is very quiet during operation so it may be difficult to ascertain if it is running. A metal tube or a screw driver, position on the compressor and your ear, may help you hear the compressor motor when energized. If fan is running but the compressor kicks on and off, or the compressor is not running, change the Danfoss module (see Section A #12). If problem persists, it may indicate the compressor is bad or a refrigerant leak.
7. The inside temperature needs to be around 34F to 40F. If the temperature starts in this range but increases over time, put the refrigerator on a test bench, start it, let it run for an hour and check the Cap Tube/ Strainer Assembly located in the back of the unit. Look for condensation and/or ice accumulations as illustrated in the following pictures:



Ice accumulation around the cap tube usually indicates blockage.

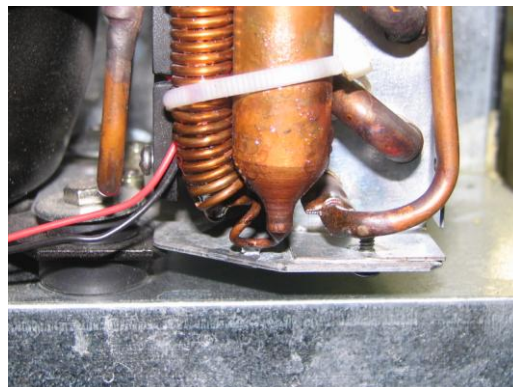

Water condensation around strainer usually indicates moisture in the system.

If condensate or ice accumulates in these areas, replace unit.

Freightliner Refrigerator Troubleshooting Guide



750000005 (TJ18F)
750000011 (TJ22F)
750000026 (TJ18FP3)

Specific Trouble-Shooting of Electrical Components

A: Check incoming voltage

1. Hold multimeter leads to the positive (+) and negative (-) terminals of the load dump module. The red lead from the multimeter is held to the “+” terminal and black lead from the multimeter is held to the “-“ terminal. You should read positive voltage. If the reading is negative, check DC polarity. If it is reversed, correct wire connections.
2. The inrush current must not drop the voltage more than 3% or .36 volts when the compressor is initially energized. Monitor this voltage by using a multimeter at start-up. For 12vdc system, the cutout is around 10.4 volts and the cut-in is 11.7 volts. If there is a drop in current, at start-up, below the cut out voltage, then the compressor will not operate. A drop in voltage will occur if the wire size is too small or poor connection.
3. Verify that voltage at unit is equal to voltage at source. If the voltage is less than at the source then the wire used from source to unit is too small.

B. Checking the Compressor

1. Remove all wires from compressor module (make note where they are connected).
2. Removed Danfoss module from the compressor by removing the mounting screw and twisting the module to the rear to disconnect it from the compressor. See Section A #12 in “General Troubleshooting” Section.
3. Compressor windings can be checked for defects by measuring the resistance on the current lead-in pins. If the measured values between all pins are approximately the same (approximately 2.2-2.5 ohms). The compressor motor is OK.

Freightliner Refrigerator Troubleshooting Guide



750000005 (TJ18F)
750000011 (TJ22F)
750000026 (TJ18FP3)

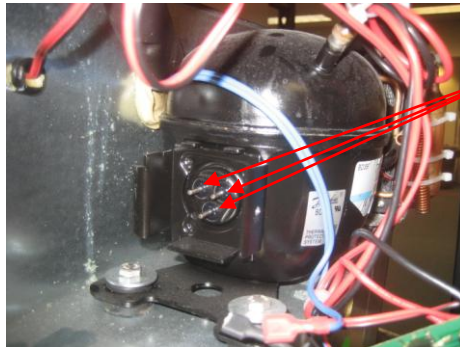

Compressor terminals
(Current lead-in pins)

4. Check each pin (motor winding) for continuity to ground. A multimeter can be used in some cases but an insulation tester by “Meggar” should be used. If there is any continuity to ground then the compressor is internally shorted and will need to be replaced. This is not a field operation.
5. If a problem is not found in the compressor then the Danfoss module needs to be replaced.

C. Checking the Fan

1. The Condenser Cooling Fan should come on after a five second delay once the compressor starts.
2. Visually inspect fan for any blockages and make sure that it can turn freely.
3. If the fan can spin freely and is not working then first check the fan terminals “+” (the lower of the two “+” symbols) and “F” on the module for voltage. The reading should be approximately 12 volts.

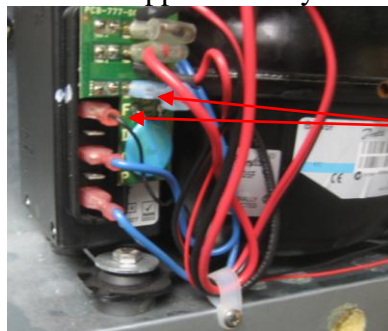

Condenser fan
terminals
(Current lead-in pins)

4. If there is voltage at the module terminals then remove the fan wires from the module and check for continuity through the fan itself by placing meter leads in each fan wire push-on terminal. If there is no continuity through the fan then replace it.

Freightliner Refrigerator Troubleshooting Guide



75000005 (TJ18F)
75000011 (TJ22F)
75000026 (TJ18FP3)

D. The Refrigerant Circuit

1. If the refrigerator seems to be running properly and passes all of the above tests and there is no cooling in the unit then the problem may be a refrigerant leak.
2. Do not attempt to charge unit in field. Contact your service dealer or Dometic Corporation at 804-764-1313 or 1-800-234-8778. Ask for the service department.

ELECTRICAL CONNECTION

Before connecting the appliance to the power supply, check that the line voltage corresponds to the indications on the appliance rating plate and those of the compressor plate. This appliance complies with the EC directive 89/336 governing radio suppression.

DC Wiring

For Direct Current (DC) refrigerators, connect the appliance to the DC distribution center. A circuit breaker of 15 Amps (maximum) must be used if the system is 12VDC. Make sure that proper polarity is maintained at all times. Check that all grounding systems are in good working order. The appliance must be wired and grounded in accordance with the Electrical Wiring Guidelines in this manual.

DANFOSS Compressor Data

Voltage Range

12V systems: From 10.4V to 17V

The electrical unit will calibrate automatically to the applied voltage. This means that if the battery voltage is less than 17V, the electronic unit assumes that it is working in a 12V system. If the voltage is higher than 17V, the electronic unit assumes that it is working in a 24V system. However, the compressor does not run at power supply voltages between 17V and 22.8V, the desired battery protection cut-out voltage for 24V systems.

Protection Systems

The Danfoss compressor protection system facilitates protection against compressor overload and start failure, fan overload and electronic unit overheating as well as destructive battery discharge. When an overload protection is activated, the compressor enters a cycle in which it makes start attempts at approximately 60 second intervals until a successful start is achieved.

Freightliner Refrigerator Troubleshooting Guide



750000005 (TJ18F)
750000011 (TJ22F)
750000026 (TJ18FP3)

Overload Protections

The compressor overload and start protection cuts off power to the compressor if the compressor speed drops below approximately 1,900 rpm, or if this motor speed is not reached during the start sequence. Possible reasons for overload protection activating could be too high refrigeration system pressures during operation or lack of pressure equalizing at start.

The fan overload protection stops the compressor if the fan current exceeds 0.5 A (avg) or 1 A (peak).

An overheating of the electronic unit heat sink will cause the compressor to stop. Restart will occur automatically when a normal temperature has been reached. If a fan is installed, it will continue to run when the compressor stops due to overload or electronic unit overheating.

Voltage Protection

If a voltage outside any concerned range is applied to the electronic unit, the compressor does not start, or it stops if the voltage limit is exceeded during operation. The compressor will restart automatically approximately 1 minute after the supply voltage has reached the reset voltage within the range in question.

Battery protection

The Danfoss electronic unit provides protection as follows:
Standard Battery Protection Settings

12V cut-out	12V cut-in
10.4	11.7

Final Installation Notes

For all appliances, AVOID the use of any electrical adapters or extension cords.

After installation, allow the appliance to sit for at least one hour before starting.

The manufacturer assumes no responsibility for any injuries or damage caused by noncompliance with any of the installation regulations.

Freightliner Refrigerator Troubleshooting Guide



75000005 (TJ18F)
75000011 (TJ22F)
75000026 (TJ18FP3)

TJ18F/TJ22F - WIRING DIAGRAM

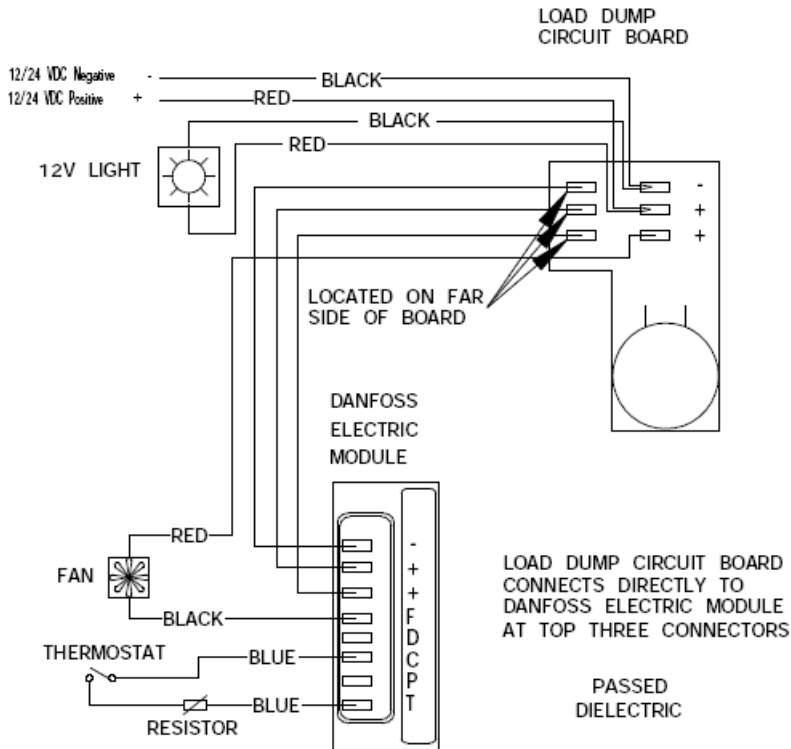

3309070.005

Freightliner Refrigerator Troubleshooting Guide



75000005 (TJ18F)
 75000011 (TJ22F)
 75000026 (TJ18FP3)

Electrical Wiring Guidelines - Direct Current

ABYC Guideline E9 (below) meets or exceeds Trucking Industry Standard SAE J1292
 Conductor Sizes for 3 Percent Drop in Voltage

		Length of Conductor from Source of Current to Device and Back to Source - Feet																		
		10	15	20	25	30	40	50	60	70	80	90	100	110	120	130	140	150	160	170
TOTAL CURRENT ON CIRCUIT IN AMPS.	12 Volts - 3% Drop Wire Sizes (gauge) - Based on Minimum CM Area																			
	5	18	16	14	12	12	10	10	10	8	8	8	6	6	6	6	6	6	6	6
10	14	12	10	10	10	8	6	6	6	6	4	4	4	4	2	2	2	2	2	2
15	12	10	10	8	8	6	6	6	4	4	2	2	2	2	2	1	1	1	1	1
20	10	10	8	6	6	6	4	4	2	2	2	2	2	1	1	0	0	0	0	2/0
25	10	8	6	6	6	4	4	2	2	2	1	1	0	0	0	2/0	2/0	2/0	2/0	3/0
30	10	8	6	6	4	4	2	2	1	1	0	0	0	2/0	2/0	3/0	3/0	3/0	3/0	3/0
40	8	6	6	4	4	2	2	1	0	0	2/0	2/0	3/0	3/0	3/0	4/0	4/0	4/0	4/0	4/0
50	6	6	4	4	2	2	1	0	2/0	2/0	3/0	3/0	4/0	4/0	4/0					
60	6	4	4	2	2	1	0	2/0	3/0	3/0	4/0	4/0	4/0							
70	6	4	2	2	1	0	2/0	3/0	3/0	4/0	4/0									
80	6	4	2	2	1	0	3/0	3/0	4/0	4/0										
90	4	2	2	1	0	2/0	3/0	4/0	4/0											
100	4	2	2	1	0	2/0	3/0	4/0												

		24 Volts - 3% Drop Wire Sizes (gauge) - Based on Minimum CM Area																		
5	18	18	18	16	16	14	12	12	12	10	10	10	10	10	8	8	8	8	8	8
10	18	16	14	12	12	10	10	10	8	8	8	6	6	6	6	6	6	6	6	6
15	16	14	12	12	10	10	8	8	6	6	6	6	6	4	4	4	4	4	4	2
20	14	12	10	10	10	8	6	6	6	6	4	4	4	4	2	2	2	2	2	2
25	12	12	10	10	8	6	6	6	4	4	4	4	2	2	2	2	2	2	2	1
30	12	10	10	8	8	6	6	4	4	4	2	2	2	2	2	1	1	1	1	1
40	10	10	8	6	6	6	4	4	2	2	2	2	1	1	0	0	0	0	0	2/0
50	10	8	6	6	6	4	4	2	2	1	1	0	0	0	2/0	2/0	2/0	2/0	2/0	3/0
60	10	8	6	6	4	4	2	2	1	1	0	0	0	2/0	2/0	3/0	3/0	3/0	3/0	3/0
70	8	6	6	4	4	2	2	1	1	0	0	2/0	2/0	3/0	3/0	3/0	3/0	3/0	4/0	4/0
80	8	6	6	4	4	2	2	1	0	0	2/0	2/0	3/0	3/0	3/0	4/0	4/0	4/0	4/0	4/0
90	8	6	4	4	2	2	1	0	0	2/0	2/0	3/0	3/0	4/0	4/0	4/0	4/0	4/0	4/0	4/0
100	6	6	4	4	2	2	1	0	2/0	2/0	3/0	3/0	4/0	4/0	4/0	4/0	4/0	4/0	4/0	4/0

Freightliner Refrigerator Troubleshooting Guide



75000005 (TJ18F)
75000011 (TJ22F)
75000026 (TJ18FP3)

1.8 CF Compressor Refrigerator Service Part Identifier Illustration

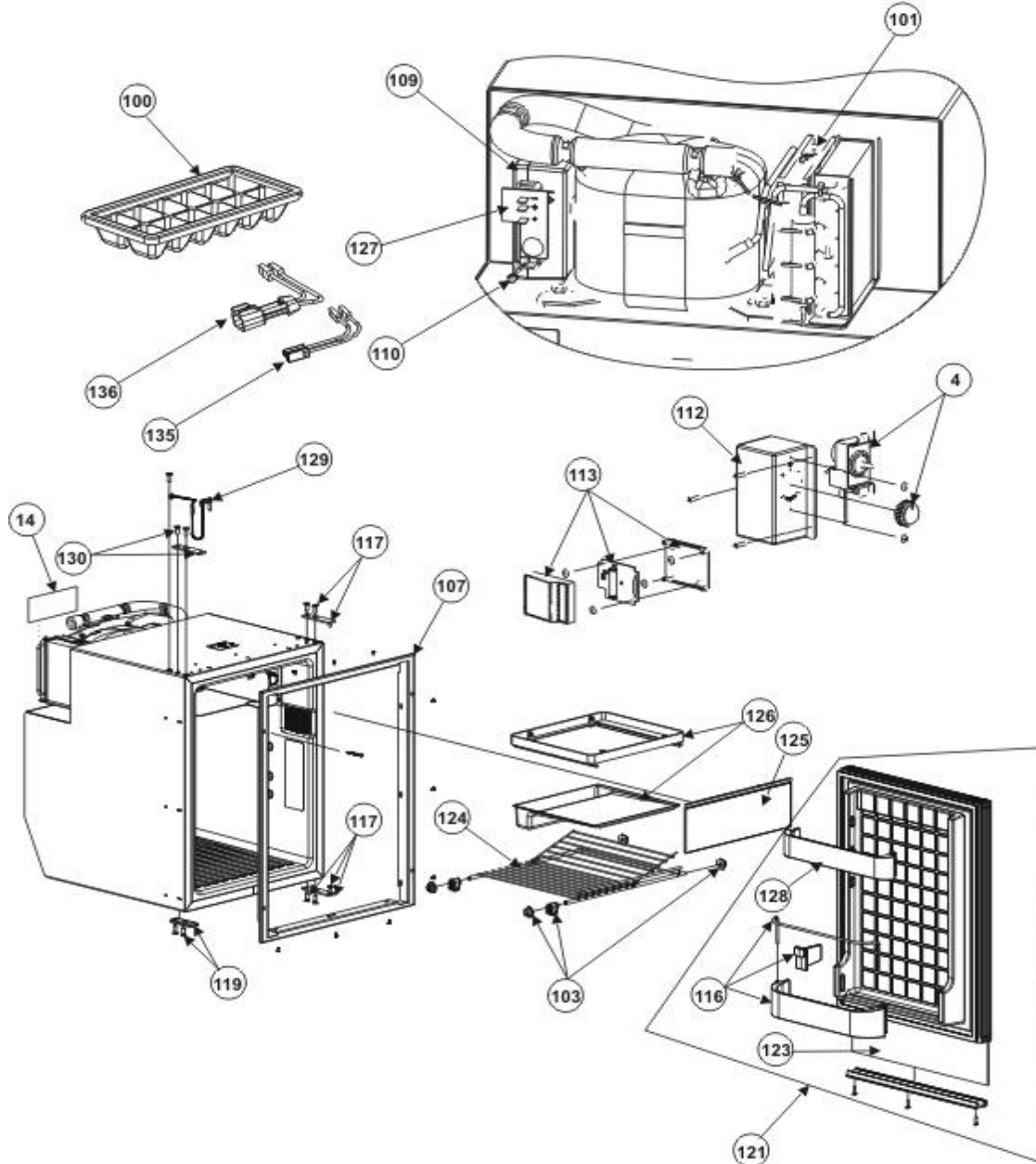

Only parts with identifiers are available as replacement parts and these will vary from model to model. See specific model number listing for service parts.

Revision A
3311821.000 3/25/08

This drawing illustrates model TJ18F. It is to be used only as a reference for model TJ18FP3.

Freightliner Refrigerator Troubleshooting Guide



75000005 (TJ18F)
75000011 (TJ22F)
75000026 (TJ18FP3)

ID	Service Part	Description
4	3311370.000	▶ THERMOSTAT KIT
14	3310735.000	▶ KIT, WARNING DECAL
100	3311359.000	▶ TRAY KIT
101	3311360.000	▶ FAN KIT
103	3311363.000	▶ RETAINER KIT
107	3311451.000	▶ FRAME KIT, TJ18F
109	3311368.000	▶ MODULE KIT, DANFOSS
110	3311369.000	▶ RESISTOR KIT
112	3311371.000	▶ HOUSING KIT, THERMOSTAT
113	3311373.000	▶ LIGHT KIT
116	3311377.000	▶ SHELF KIT
117	3311380.000	▶ HINGE KIT
119	3311462.000	▶ GUIDE KIT, DOOR TRUCK
121	3311443.000	▶ DOOR KIT, TJ18 TRUCK
123	3311468.000	▶ PANEL KIT, TJ18
124	3311361.000	▶ SHELF KIT, WIRE
125	3311364.000	▶ DOOR KIT, FREEZER
126	3311366.000	▶ PAN KIT, DRAIN
127	3311465.000	▶ LOAD DUMP KIT
128	3311376.000	▶ SHELF KIT
129	3311466.000	▶ LATCH KIT
130	3311467.000	▶ LATCH KIT
135	3312372.000	▶ HARNESS KIT, FREIGHTLINER

Freightliner Refrigerator Troubleshooting Guide



75000005 (TJ18F)
75000011 (TJ22F)
75000026 (TJ18FP3)

2.2 CF Compressor Refrigerator Service Part Identifier Illustration

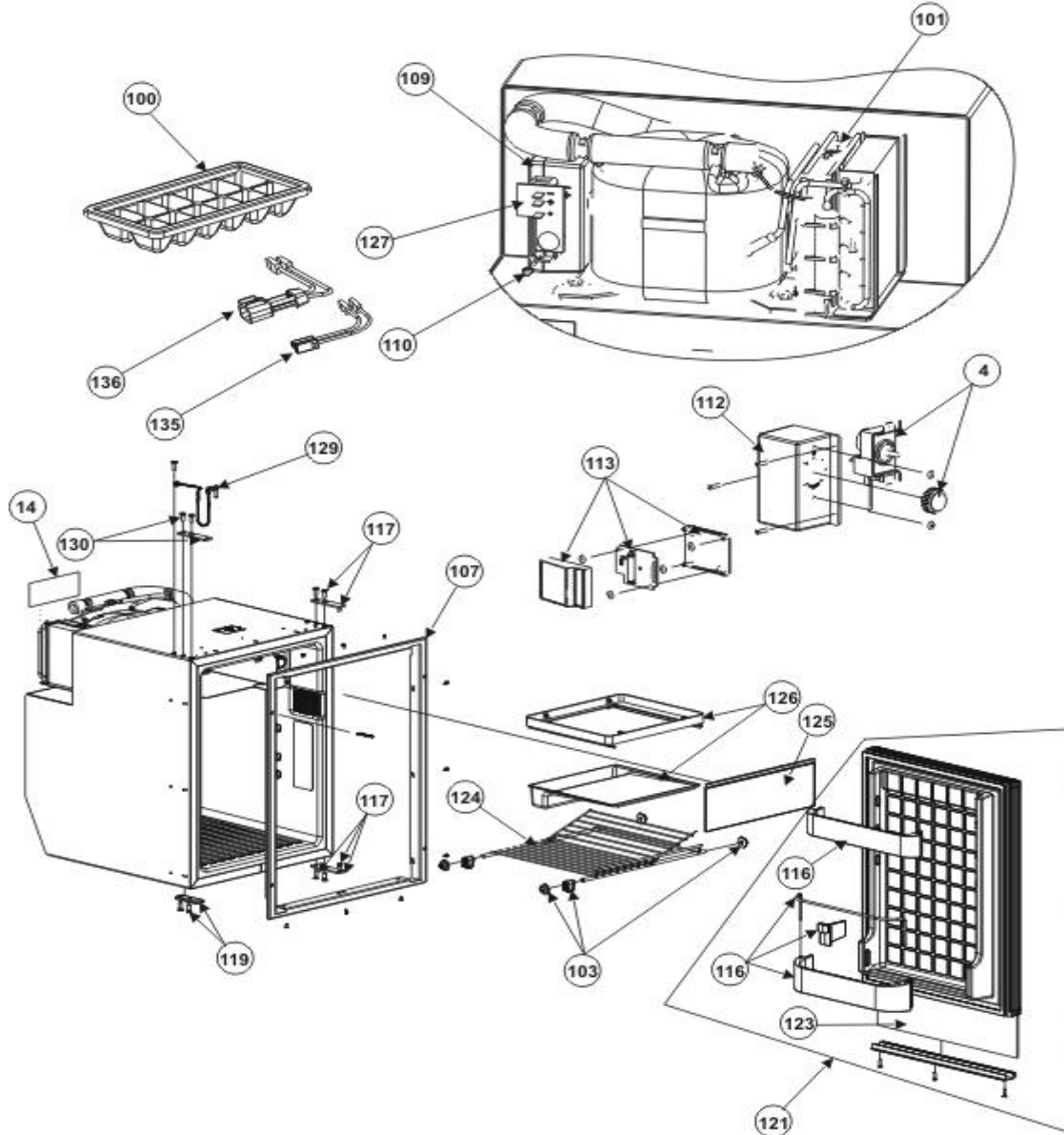

Only parts with identifiers are available as replacement parts and these will vary from model to model. See specific model number listing for service parts.

Revision A
3312424.000 4/03/08

This drawing illustrates model TJ22F.

Freightliner Refrigerator Troubleshooting Guide



75000005 (TJ18F)
75000011 (TJ22F)
75000026 (TJ18FP3)

ID	Service Part	Description
4	3311370.000	▶ THERMOSTAT KIT
14	3310735.000	▶ KIT, WARNING DECAL
100	3311359.000	▶ TRAY KIT
101	3311360.000	▶ FAN KIT
103	3311363.000	▶ RETAINER KIT
107	3311454.000	▶ FRAME KIT, TJ22F
109	3311368.000	▶ MODULE KIT, DANFOSS
110	3311369.000	▶ RESISTOR KIT
112	3311372.000	▶ HOUSING KIT, THERMOSTAT
113	3311373.000	▶ LIGHT KIT
116	3311378.000	▶ SHELF KIT
117	3311380.000	▶ HINGE KIT
119	3311462.000	▶ GUIDE KIT, DOOR TRUCK
121	3311445.000	▶ DOOR KIT, TJ22 TRUCK
123	3311469.000	▶ PANEL KIT, TJ22
124	3311362.000	▶ SHELF KIT, WIRE
125	3311365.000	▶ DOOR KIT, FREEZER
126	3311366.000	▶ PAN KIT, DRAIN
127	3311465.000	▶ LOAD DUMP KIT
129	3311466.000	▶ LATCH KIT
130	3311467.000	▶ LATCH KIT
135	3312372.000	▶ HARNESS KIT, FREIGHTLINER

Freightliner Refrigerator Troubleshooting Guide



75000005 (TJ18F)
75000011 (TJ22F)
75000026 (TJ18FP3)

WARNING

Dometic Corporation, Environmental Division (Dometic) manufacturers of Dometic Refrigerator products, makes the following safety warnings concerning the application, installation, use and care of its products. Although these warnings are extensive, there may be specific hazards which may arise out of circumstances which we have not outlined herein. Use this as a guide for developing an awareness of potential hazards of all kinds. Such awareness will be a key factor in assuring your SAFETY and comfort.

ELECTRICITY – Many Dometic products operate on 115 or 230 volt AC power and/or 12/24 volt DC power. Such voltages can be **LETHAL**: therefore, the chassis, cabinets, bases, etc., on all components must be grounded together and connected to the vehicle's grounding system. Sparks can occur as switches, thermostats and relays open and close in the normal operation of the equipment. Since this is the case, ventilating blowers for the removal of hazardous fumes or vapors should be operated at least 5 minutes before and during operation of any Dometic product or group of Dometic products. All electrical connections must be covered and protected so accidental contact cannot be made by persons using the equipment; as such contact could be **LETHAL**.

ELECTROLYSIS – Electrical leakage of any component can cause electrolytic deterioration (electrolysis) resulting in vehicle component damage which could cause loss of life. All Dometic components must be kept clean and dry and checked periodically for electrical leakage. If any electrical leakage is detected, the component should be replaced or the fault causing the leakage corrected before the component is put back into service.

GAS – Dometic Refrigerator components utilize R134a refrigerant, R409A or R404A, R125/R143a/R134 (44%/52%/47%) which are non-toxic, nonflammable gases; however, these gases contain no oxygen and will not support life. Refrigerant gas tends to settle in the lowest areas of the compartment. If you experience a leak, evacuate all personnel, and ventilate area. Do not allow open flames in the area of leaks because refrigerant gas, when burned, decomposes into other potentially **LETHAL** gases. Refrigerant components operate at high pressure and no servicing should be attempted without gloves, long-sleeved clothing and eye protection. Liquid refrigerant can cause severe frost burns to the skin and eyes.

VENTILATION – Dometic Refrigerator components are designed to move air through a heat exchanger by a blower or propeller fan. This design necessarily produces a suction on one side of the air handling component and a pressure on the other side. Air handling components must be installed so that the suction pressure action does not: (1) pressure an area to the extent that structural failure occurs which could cause harm to occupants or bystanders, or (2) cause a suction or low pressure in an area where hydrogen gas from batteries, raw fuel vapor from fuel tanks, carbon monoxide from operating propulsion engines, power generators or heaters, methane gas from sewage holding tanks, or any other

Freightliner Refrigerator Troubleshooting Guide



750000005 (TJ18F)
750000011 (TJ22F)
750000026 (TJ18FP3)

dangerous gas or vapor could exist. If a unit is installed in such a manner that allows potentially lethal gases or vapors to be discharged by the air handling unit into the living space, this could result in loss of life.

Maximum protection against the introduction of dangerous gases or vapors into living spaces can be obtained through the introduction of clean air into the living space. Bear in mind that the advent of air conditioning, whether it is for cooling or for heating, naturally leads to the practice of closing a living space tightly. Never close all windows and doors unless auxiliary ventilating systems, which introduce clean outside air into the living space, are used. Always leave enough window and door openings to provide adequate ventilation in the event potentially lethal gases or fumes should escape from any source.

Note:

Never sleep in any closed area when any equipment, which functions as a result of the combustion of a volatile fuel, is in operation (such as engines, generators, power plants, or oil-fired heaters, etc. At any time, the exhaust system of such devices could fail, resulting in a build-up of LETHAL gases within the closed area.

Free Manuals Download Website

<http://myh66.com>

<http://usermanuals.us>

<http://www.somanuals.com>

<http://www.4manuals.cc>

<http://www.manual-lib.com>

<http://www.404manual.com>

<http://www.luxmanual.com>

<http://aubethermostatmanual.com>

Golf course search by state

<http://golfingnear.com>

Email search by domain

<http://emailbydomain.com>

Auto manuals search

<http://auto.somanuals.com>

TV manuals search

<http://tv.somanuals.com>