



Vigor2700 Series Firewall Router Quick Start Guide

Version: 2.0

Date: 2006/3/15

Copyright Information

Copyright Declarations

Copyright 2005 All rights reserved. This publication contains information that is protected by copyright. No part may be reproduced, transmitted, transcribed, stored in a retrieval system, or translated into any language without written permission from the copyright holders.

Trademarks

The following trademarks are used in this document:

- Microsoft is a registered trademark of Microsoft Corp.
- Windows, Windows 95, 98, Me, NT, 2000, XP and Explorer are trademarks of Microsoft Corp.
- Apple and Mac OS are registered trademarks of Apple Computer Inc.
- Other products may be trademarks or registered trademarks of their respective manufacturers.

Safety Instructions and Approval

Safety Instructions

- Read the installation guide thoroughly before you set up the router.
- The router is a complicated electronic unit that may be repaired only by authorized and qualified personnel. Do not try to open or repair the router yourself.
- Do not place the router in a damp or humid place, e.g. a bathroom.
- Do not stack the routers.
- The router should be used in a sheltered area, within a temperature range of +5 to +40 Celsius.
- Do not expose the router to direct sunlight or other heat sources. The housing and electronic components may be damaged by direct sunlight or heat sources.
- Do not deploy the cable for LAN connection outdoor to prevent electronic shock hazards.
- Keep the package out of reach of children.
- When you want to dispose of the router, please follow local regulations on conservation of the environment.

Warranty

We warrant to the original end user (purchaser) that the router will be free from any defects in workmanship or materials for a period of two (2) years from the date of purchase from the dealer. Please keep your purchase receipt in a safe place as it serves as proof of date of purchase. During the warranty period, and upon proof of purchase, should the product have indications of failure due to faulty workmanship and/or materials, we will, at our discretion, repair or replace the defective products or components, without charge for either parts or labor, to whatever extent we deem necessary to restore the product to proper operating condition. Any replacement will consist of a new or re-manufactured functionally equivalent product of equal value, and will be offered solely at our discretion. This warranty will not apply if the product is modified, misused, tampered with, damaged by an act of God, or subjected to abnormal working conditions. The warranty does not cover the bundled or licensed software of other vendors. Defects which do not significantly affect the usability of the product will not be covered by the warranty. We reserve the right to revise the manual and online documentation and to make changes from time to time in the contents hereof without obligation to notify any person of such revision or changes.

Be a Registered Owner

Web registration is preferred. You can register your Vigor router via <http://www.draytek.com>. Alternatively, fill in the registration card and mail it to the address found on the reverse side of the card.

Firmware & Tools Updates

Due to the continuous evolution of DrayTek technology, all routers will be regularly upgraded. Please consult the DrayTek web site for more information on newest firmware, tools and documents.

<http://www.draytek.com>

European Community Declarations

Manufacturer: DrayTek Corp.
Address: No. 26, Fu Shing Road, HuKou County, HsinChu Industrial Park, Hsin-Chu, Taiwan 303
Product: Vigor2700 Series Routers

DrayTek Corp. declares that Vigor2700 series routers are in compliance with the following essential requirements and other relevant provisions of R&TTE Directive 1999/5/EEC.

The product conforms to the requirements of Electro-Magnetic Compatibility (EMC) Directive 89/336/EEC by complying with the requirements set forth in EN55022/Class B and EN55024/Class B.

The product conforms to the requirements of Low Voltage (LVD) Directive 73/23/EEC by complying with the requirements set forth in EN60950.

The Vigor2700 series routers are designed for the WLAN 2.4GHz network throughput EC region, Switzerland, and the restrictions of France.

Regulatory Information

Federal Communication Commission Interference Statement

This equipment has been tested and found to comply with the limits for a Class B digital device, pursuant to Part 15 of the FCC Rules. These limits are designed to provide reasonable protection against harmful interference in a residential installation. This equipment generates, uses and can radiate radio frequency energy and, if not installed and used in accordance with the instructions, may cause harmful interference to radio communications. However, there is no guarantee that interference will not occur in a particular installation. If this equipment does cause harmful interference to radio or television reception, which can be determined by turning the equipment off and on, the use is encouraged to try to correct the interference by one of the following measures:

- Reorient or relocate the receiving antenna.
- Increase the separation between the equipment and receiver.
- Connect the equipment into an outlet on a circuit different from that to which the receiver is connected.
- Consult the dealer or an experienced radio/TV technician for help.

This device complies with Part 15 of the FCC Rules. Operation is subject to the following two conditions:

- (1) This device may not cause harmful interference, and
- (2) This device may accept any interference received, including interference that may cause undesired operation.

Taiwanese BSMI (Bureau of Standards, Metrology and Inspection) A Warning:

Warning: This device might cause interference of radio frequency under the environment of dwelling. In such condition, the users might be asked to adopt some proper strategies.

Please visit www.draytek.com/contact_us/WEEE.php.



Table of Contents

1. Introduction.....	1
1.1 Panel Explanation	2
1.1.1 Front and Rear View for Vigor2700	2
1.1.2 Front and Rear View for Vigor2700G.....	3
1.1.3 Front and Rear View for Vigor2700Gi.....	4
1.1.4 Front and Rear View for Vigor2700V (MODULE:2S1L).....	5
1.1.5 Front and Rear View for Vigor2700V (MODULE:2S).....	6
1.1.6 Front and Rear View for Vigor2700VGi	7
1.1.7 Front and Rear View for Vigor2700VG (MODULE:2S1L).....	8
1.1.8 Front and Rear View for Vigor2700VG (MODULE:2S).....	9
1.2 Package Contents.....	10
2. Installing Your Router.....	11
2.1 Hardware Installation.....	11
3. Configuring Web Pages	13
3.1 Basic Configuration	13
3.2 Wireless LAN Settings (for G Series Model Only)	17
3.2.1 Basic Wireless LAN Concept	17
3.2.2 General Settings	18
3.2.3 Security Settings	19
4. Trouble Shooting	21
4.1 Checking If the Hardware Status Is OK or Not.....	21
4.2 Checking If the Network Connection Settings on Your Computer Is OK or Not	21
4.3 Pinging the Router from Your Computer	24
4.4 Checking If the ISP Settings are OK or Not.....	26
4.5 Backing to Factory Default Setting If Necessary.....	27
4.6 Contacting Your Dealer	28

1. Introduction

Targeting requirement for residential, SOHO (Small Office and Home Office) and business users, the Vigor router is an ADSL2/2+ enabled integrated access device. With downstream speed up to 12Mbps (ADSL2) or 24Mbps (ADSL2+), the Vigor router provides exceptional bandwidth for Internet access.



The available bandwidth depends on the Internet Service Provider.

To secure your network, the Vigor router provides an advanced firewall with advanced features, such as NAT with multi VPN pass-through, Stateful Packet Inspection (SPI) to offer network reliability by detecting and prohibiting malicious penetrating packets or DoS attacks, user-configurable web filtering for parental control against network abuse etc.

Vigor G model is embedded with an 802.11g compliant wireless module which provides wireless LAN access with data rate as much as 54Mbps. As for data privacy of wireless network, the Vigor router can encode all transmissions data with standard WEP and industrial strength WPA2 (IEEE 802.11i) encryption. Additional features include Wireless Client List and MAC Address Control for maintaining control over user's authorization in your network, and Hidden SSID for being invisible to outside intruders scanning.

Characteristics

- Easy Internet-sharing of your broadband connection
- Robust firewall to help protect your network from external attacks

1.1 Panel Explanation

1.1.1 Front and Rear View for Vigor2700

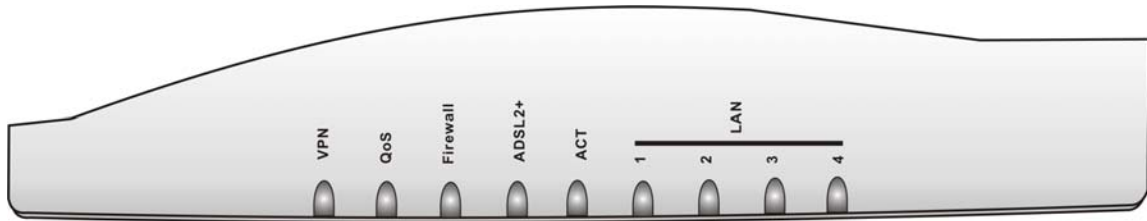

LED	Status	Explanation
VPN	On	The VPN tunnel is launched.
QoS	On	The QoS function is active.
	Off	The QoS function is inactive.
Firewall	On	The DoS function is enabled.
	Blinking	When encountered DoS attacks.
ADSL2+	On (Green)	ADSL is show time.
	Blinking (Green)	The device starts handshaking.
	Blinking (Orange)	The data is transmitting.
ACT (Activity)	On	The router is powered on.
	Blinking	The router is powered on and running properly.
LAN (1, 2, 3, 4)	Orange	A normal 10Mbps connection is through its corresponding port.
	Green	A normal 100Mbps connection is through its corresponding port.
	Blinking	Ethernet packets are transmitting.

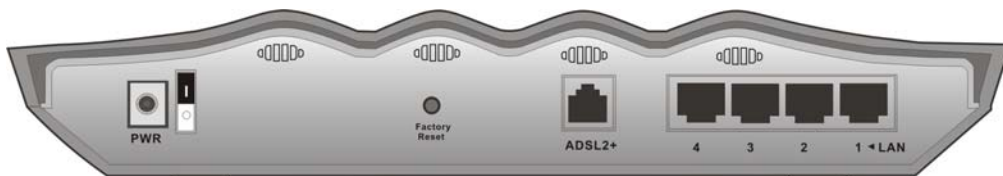

for Annex A



for Annex B

Interface	Description
PWR	Connector for a power adapter with 12~15VDC.
ON/OFF	Power Switch.
Factory Reset	Restore the default settings. Usage: Turn on the router (ACT LED is blinking). Press the hole and keep for more than 5 seconds. When you see the ACT LED begins to blink rapidly than usual, release the button. Then the router will restart with the factory default configuration.
ADSL 2+	Connector for accessing the Internet through ADSL2/2+.
LAN 4 – 1	Connector for local networked devices.

1.1.2 Front and Rear View for Vigor2700G

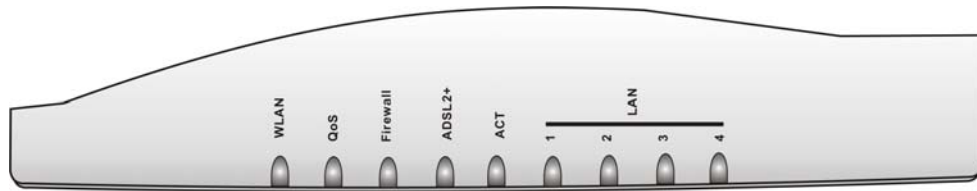

LED	Status	Explanation
WLAN	On	Wireless access point is ready.
	Blinking	Ethernet packets are transmitting over wireless LAN.
	Off	The WLAN function is inactive.
QoS	On	The QoS function is active.
	Off	The QoS function is inactive.
Firewall	On	The DoS function is enabled.
	Blinking	When encountered DoS attacks.
ADSL2+	On (Green)	ADSL is show time.
	Blinking (Green)	The device starts handshaking.
	Blinking (Orange)	The data is transmitting.
ACT (Activity)	On	The router is powered on.
	Blinking	The router is powered on and running properly.
LAN (1, 2, 3, 4)	Orange	A normal 10Mbps connection is through its corresponding port.
	Green	A normal 100Mbps connection is through its corresponding port.
	Blinking	Ethernet packets are transmitting.

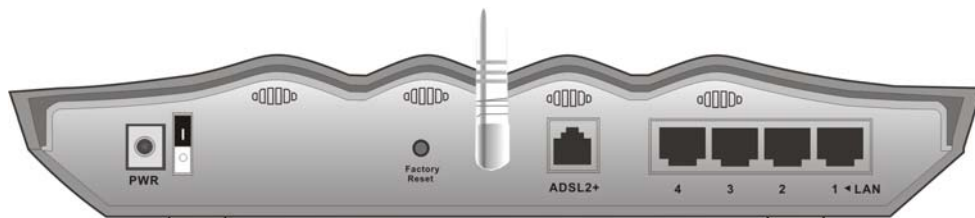

for Annex A

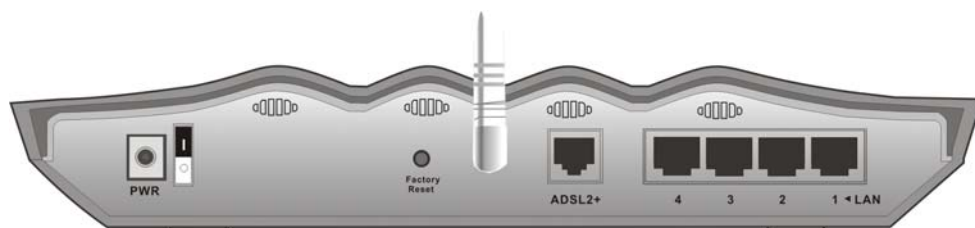

for Annex B

Interface	Description
PWR	Connector for a power adapter with 12~15VDC.
ON/OFF	Power Switch.
Factory Reset	Restore the default settings. Usage: Turn on the router (ACT LED is blinking). Press the hole and keep for more than 5 seconds. When you see the ACT LED begins to blink rapidly than usual, release the button. Then the router will restart with the factory default configuration.
ADSL 2+	Connector for accessing the Internet through ADSL2/2+.
LAN 4 – 1	Connector for local networked devices.

1.1.3 Front and Rear View for Vigor2700Gi

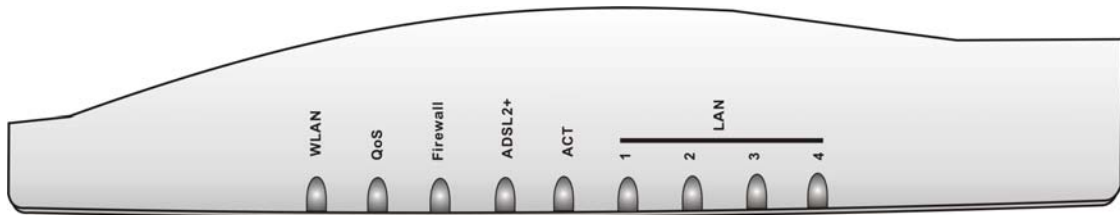

LED	Status	Explanation
WLAN	On	Wireless access point is ready.
	Blinking	Ethernet packets are transmitting over wireless LAN.
	Off	The WLAN function is inactive.
QoS	On	The QoS function is active.
	Off	The QoS function is inactive.
Firewall	On	The DoS function is enabled.
	Blinking	When encountered DoS attacks.
ADSL2+	On (Green)	ADSL is show time.
	Blinking (Green)	The device starts handshaking.
	Blinking (Orange)	The data is transmitting.
ACT (Activity)	On	The router is powered on.
	Blinking	The router is powered on and running properly.
LAN (1, 2, 3, 4)	Orange	A normal 10Mbps connection is through its corresponding port.
	Green	A normal 100Mbps connection is through its corresponding port.
	Blinking	Ethernet packets are transmitting.

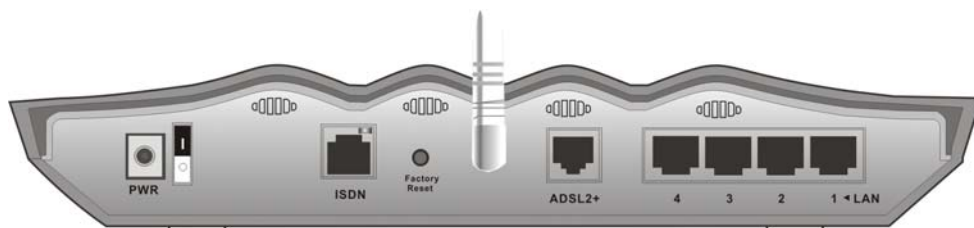

for Annex B

Interface	Description
PWR	Connector for a power adapter with 12~15VDC.
ON/OFF	Power Switch.
ISDN	Connect for NT1 (or NT1+) box provided by ISDN service provider. While using ISDN service, the LED on the top-right corner of this connector will light on.
Factory Reset	Restore the default settings. Usage: Turn on the router (ACT LED is blinking). Press the hole and keep for more than 5 seconds. When you see the ACT LED begins to blink rapidly than usual, release the button. Then the router will restart with the factory default configuration.
ADSL 2+	Connector for accessing the Internet through ADSL2/2+.
LAN 4 – 1	Connector for local networked devices.

1.1.4 Front and Rear View for Vigor2700V (MODULE:2S1L)

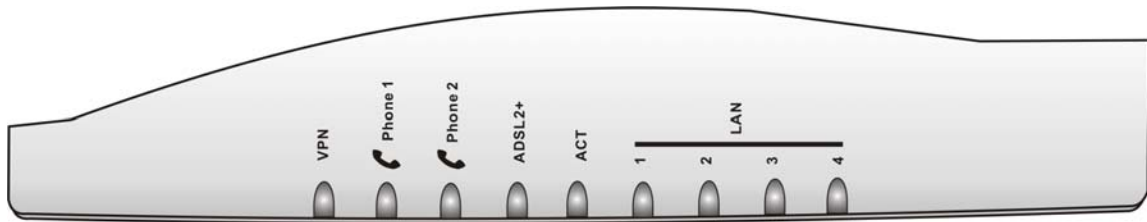

LED	Status	Explanation
VPN	On	The VPN tunnel is launched.
Phone 1 & 2 (FXS1, FXS2)	On	The phone is off hook (the handset of phone is hanging).
	Blinking	A phone call is incoming.
ADSL2+	On (Green)	ADSL is show time.
	Blinking (Green)	The device starts handshaking.
	Blinking (Orange)	The data is transmitting.
ACT (Activity)	On	The router is powered on.
	Blinking	The router is powered on and running properly.
LAN (1, 2, 3, 4)	Orange	A normal 10Mbps connection is through its corresponding port.
	Green	A normal 100Mbps connection is through its corresponding port.
	Blinking	Ethernet packets are transmitting.

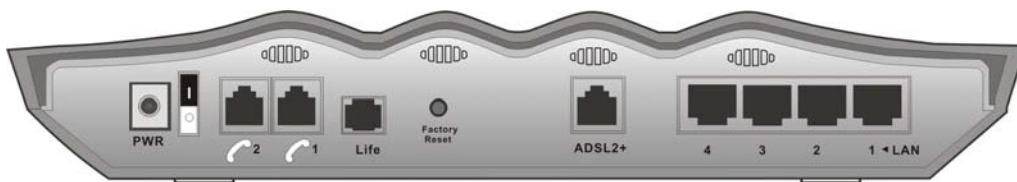

For Annex A

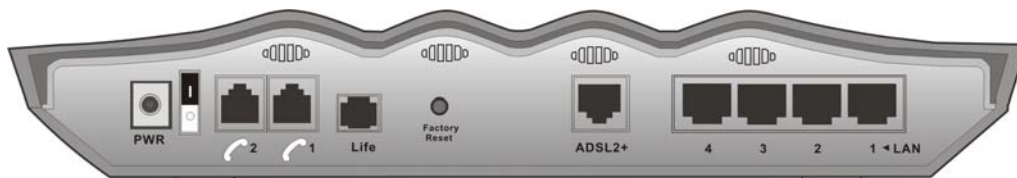

For Annex B

Interface	Description
PWR	Connector for a power adapter with 12~15VDC.
ON/OFF	Power Switch.
VoIP 1/2	Connector of analog phone for VoIP communication.
Life	Connector of analog phone for PSTN life line.
Factory Reset	Restore the default settings. Usage: Turn on the router (ACT LED is blinking). Press the hole and keep for more than 5 seconds. When you see the ACT LED begins to blink rapidly than usual, release the button. Then the router will restart with the factory default configuration.
ADSL 2+	Connector for accessing the Internet through ADSL2/2+.
LAN 4 – 1	Connector for local networked devices.

1.1.5 Front and Rear View for Vigor2700V (MODULE:2S)

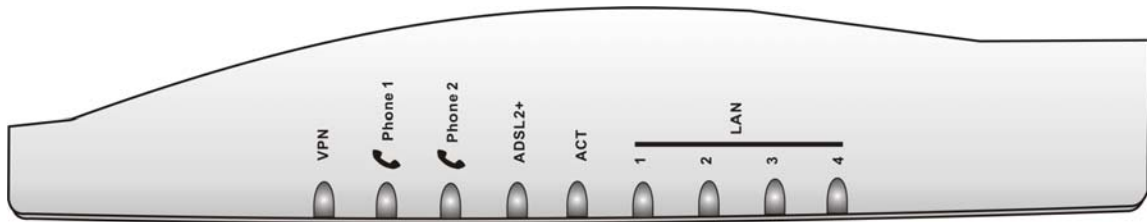

LED	Status	Explanation
VPN	On	The VPN tunnel is launched.
Phone 1 & 2 (FXS1, FXS2)	On	The phone is off hook (the handset of phone is hanging).
	Blinking	A phone call is incoming.
ADSL2+	On (Green)	ADSL is show time.
	Blinking (Green)	The device starts handshaking.
	Blinking (Orange)	The data is transmitting.
ACT (Activity)	On	The router is powered on.
	Blinking	The router is powered on and running properly.
LAN (1, 2, 3, 4)	Orange	A normal 10Mbps connection is through its corresponding port.
	Green	A normal 100Mbps connection is through its corresponding port.
	Blinking	Ethernet packets are transmitting.

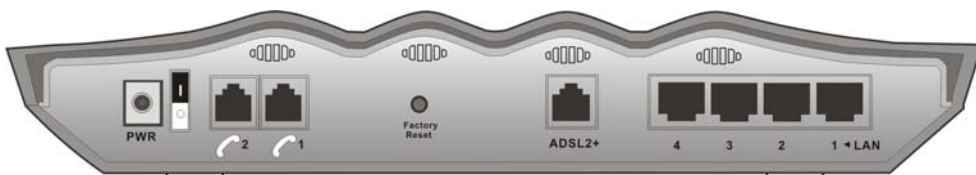

For Annex A

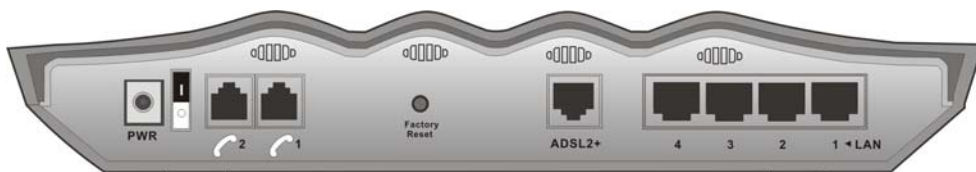

For Annex B

Interface	Description
PWR	Connector for a power adapter with 12~15VDC.
ON/OFF	Power Switch.
VoIP 1/2	Connector of analog phone for VoIP communication.
Factory Reset	Restore the default settings. Usage: Turn on the router (ACT LED is blinking). Press the hole and keep for more than 5 seconds. When you see the ACT LED begins to blink rapidly than usual, release the button. Then the router will restart with the factory default configuration.
ADSL 2+	Connector for accessing the Internet through ADSL2/2+.
LAN 4 – 1	Connector for local networked devices.

1.1.6 Front and Rear View for Vigor2700VGi

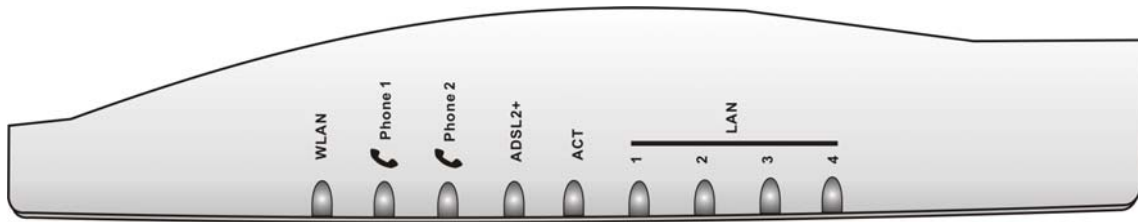

LED	Status	Explanation
WLAN	On	Wireless access point is ready.
	Blinking	Ethernet packets are transmitting over wireless LAN.
	Off	The WLAN function is inactive.
Phone 1 & 2 (FXS1, FXS2)	On	The phone is off hook (the handset of phone is hanging).
	Blinking	A phone call is incoming.
ADSL2+	On (Green)	ADSL is show time.
	Blinking (Green)	The device starts handshaking.
	Blinking (Orange)	The data is transmitting.
ACT (Activity)	On	The router is powered on.
	Blinking	The router is powered on and running properly.
LAN (1, 2, 3, 4)	Orange	A normal 10Mbps connection is through its corresponding port.
	Green	A normal 100Mbps connection is through its corresponding port.
	Blinking	Ethernet packets are transmitting.

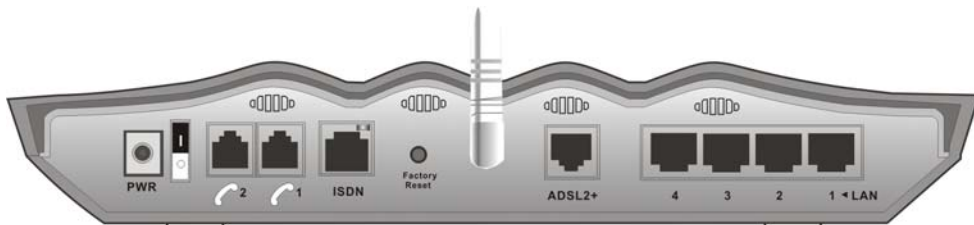

For Annex B

Interface	Description
PWR	Connector for a power adapter with 12~15VDC.
ON/OFF	Power Switch.
VoIP 1/2	Connector of analog phone for VoIP communication.
ISDN	Connect for NT1 (or NT1+) box provided by ISDN service provider. While using ISDN service, the LED on the top-right corner of this connector will light on.
Factory Reset	Restore the default settings. Usage: Turn on the router (ACT LED is blinking). Press the hole and keep for more than 5 seconds. When you see the ACT LED begins to blink rapidly than usual, release the button. Then the router will restart with the factory default configuration.
ADSL 2+	Connector for accessing the Internet through ADSL2/2+.
LAN 4 – 1	Connector for local networked devices.

1.1.7 Front and Rear View for Vigor2700VG (MODULE:2S1L)

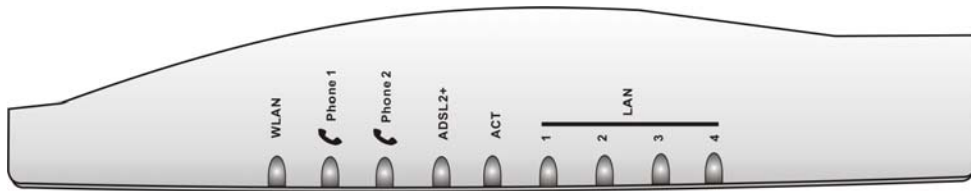

LED	Status	Explanation
WLAN	On	Wireless access point is ready.
	Blinking	Ethernet packets are transmitting over wireless LAN.
	Off	The WLAN function is inactive.
Phone 1 & 2 (FXS1, FXS2)	On	The phone is off hook (the handset of phone is hanging).
	Blinking	A phone call is incoming.
ADSL2+	On (Green)	ADSL is show time.
	Blinking (Green)	The device starts handshaking.
	Blinking (Orange)	The data is transmitting.
ACT (Activity)	On	The router is powered on.
	Blinking	The router is powered on and running properly.
LAN (1, 2, 3, 4)	Orange	A normal 10Mbps connection is through its corresponding port.
	Green	A normal 100Mbps connection is through its corresponding port.
	Blinking	Ethernet packets are transmitting.

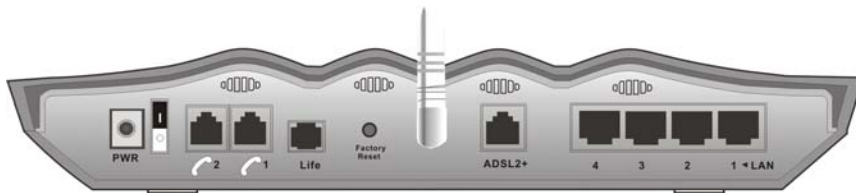

For Annex A

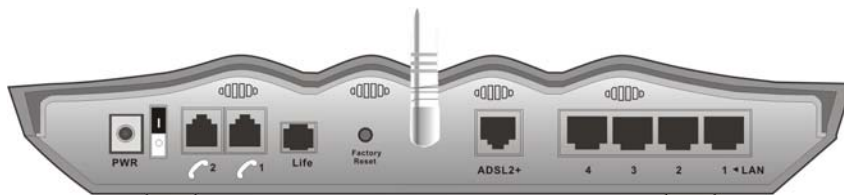

For Annex B

Interface	Description
PWR	Connector for a power adapter with 12~15VDC.
ON/OFF	Power Switch.
VoIP 1/2	Connector of analog phone for VoIP communication.
Life	Connector of analog phone for PSTN life line.
Factory Reset	Restore the default settings. Usage: Turn on the router (ACT LED is blinking). Press the hole and keep for more than 5 seconds. When you see the ACT LED begins to blink rapidly than usual, release the button. Then the router will restart with the factory default configuration.
ADSL 2+	Connector for accessing the Internet through ADSL2/2+.
LAN 4 – 1	Connector for local networked devices.

1.1.8 Front and Rear View for Vigor2700VG (MODULE:2S)

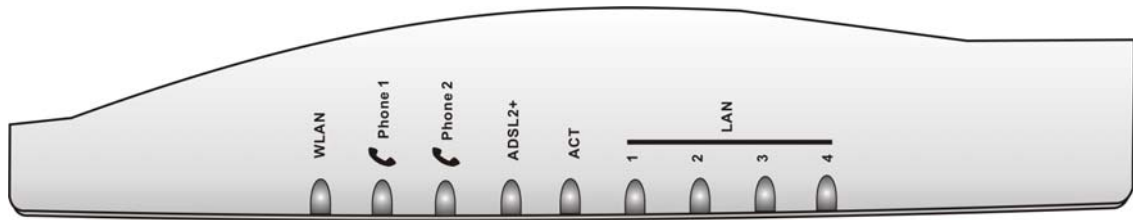

LED	Status	Explanation
WLAN	On	Wireless access point is ready.
	Blinking	Ethernet packets are transmitting over wireless LAN.
	Off	The WLAN function is inactive.
Phone 1 & 2 (FXS1, FXS2)	On	The phone is off hook (the handset of phone is hanging).
	Blinking	A phone call is incoming.
ADSL2+	On (Green)	ADSL is show time.
	Blinking (Green)	The device starts handshaking.
	Blinking (Orange)	The data is transmitting.
ACT (Activity)	On	The router is powered on.
	Blinking	The router is powered on and running properly.
LAN (1, 2, 3, 4)	Orange	A normal 10Mbps connection is through its corresponding port.
	Green	A normal 100Mbps connection is through its corresponding port.
	Blinking	Ethernet packets are transmitting.

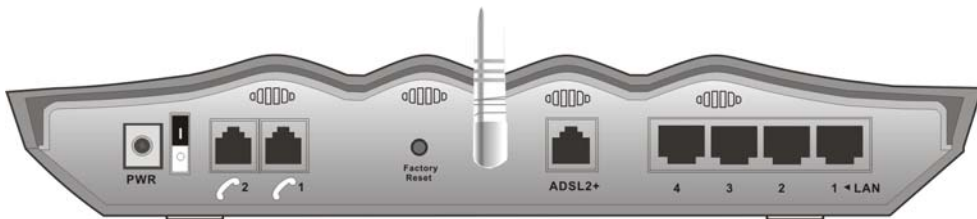

For Annex A

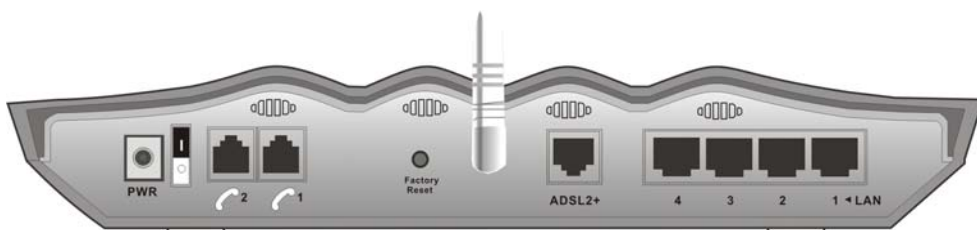

For Annex B

Interface	Description
PWR	Connector for a power adapter with 12~15VDC.
ON/OFF	Power Switch.
VoIP 1/2	Connector of analog phone for VoIP communication.
Factory Reset	Restore the default settings. Usage: Turn on the router (ACT LED is blinking). Press the hole and keep for more than 5 seconds. When you see the ACT LED begins to blink rapidly than usual, release the button. Then the router will restart with the factory default configuration.
ADSL 2+	Connector for accessing the Internet through ADSL2/2+.
LAN 4 - 1	Connector for local networked devices.

1.2 Package Contents



1 Quick Start Guide

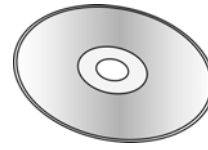

2 CD



3 Antenna for G models



4 RJ-45 Cable (Ethernet)

5 The type of the cable depends on the country that the router will be installed:



RJ-11 to RJ-11 Cable
(Annex A)

Or



RJ-11 to RJ-45 Cable
(Annex B)

Or



RJ-45 to RJ-45 Cable
(Annex B)

6 The type of the power adapter depends on the country that the router will be installed:

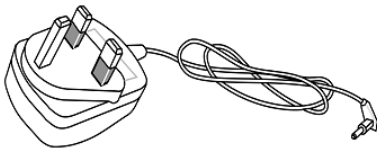

UK-type power adapter

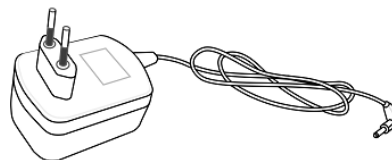

EU-type power adapter

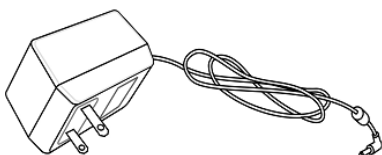

USA/Taiwan-type power adapter

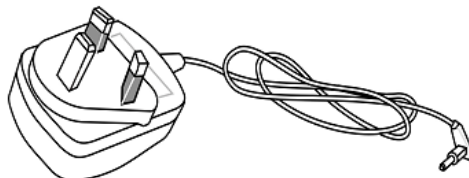

AU/NZ-type power adapter

2. Installing Your Router

This section will guide you to install the router through hardware connection and configure the router's settings through web browser.

2.1 Hardware Installation

Before starting to configure the router, you have to connect your devices correctly.

1. Connect the ADSL interface to the external ADSL splitter with an ADSL line cable.
2. Connect one port of 4-port switch to your computer with a RJ-45 cable. This device allows you to connect 4 PCs directly.
3. Connect one end of the power cord to the power port of this device. Connect the other end to the wall outlet of electricity.
4. Power on the router.
5. Check the **ACT** and **ADSL2+**, **LAN** LEDs to assure network connections.

(For the detailed information of LED status, please refer to section 1.1.)

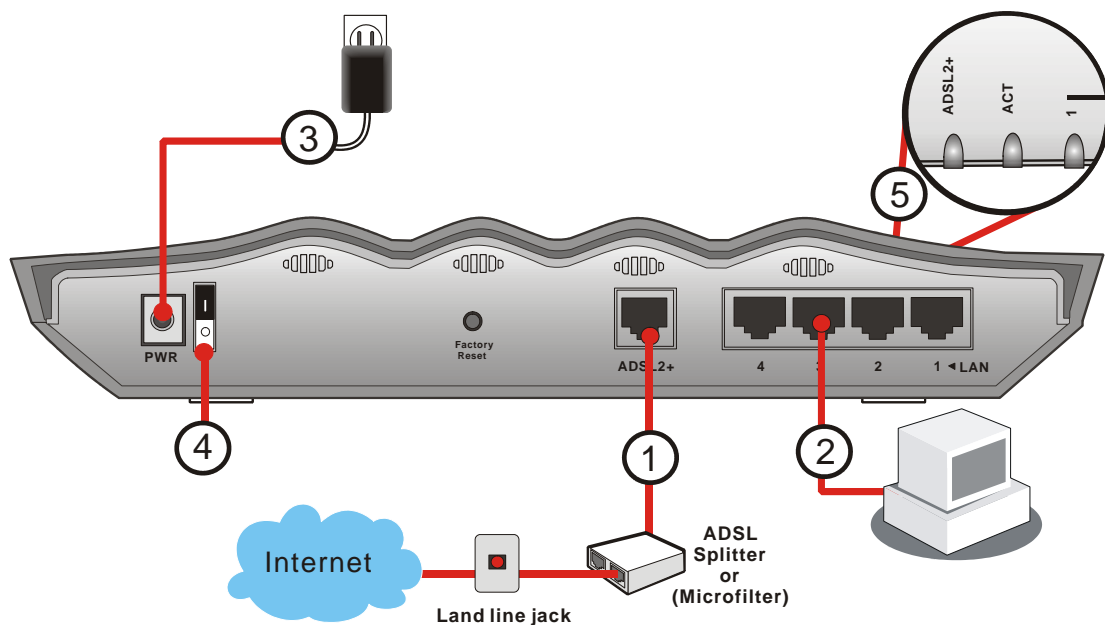

This page is left blank.

3. Configuring Web Pages

3.1 Basic Configuration

The **Quick Start Wizard** is designed for you to easily set up your router for Internet access. You can directly access the **Quick Start Wizard** via Web Configurator.

1. Make sure your PC connects to the router correctly.



Notice: You may either simply set up your computer to get IP dynamically from the router or set up the IP address of the computer to be the same subnet as **the default IP address of Vigor router 192.168.1.1**. For the detailed information, please refer to the later section - Trouble Shooting of the guide.

2. Open a web browser on your PC and type **http://192.168.1.1**. A pop-up window will open to ask for username and password. Do not type any word on the window and click **OK** for next screen.



Notice: If you fail to access to the web configuration, please go to “Trouble Shooting” for detecting and solving your problem.

3. Now, the **Main Screen** will pop up. Click **Quick Start Wizard**.

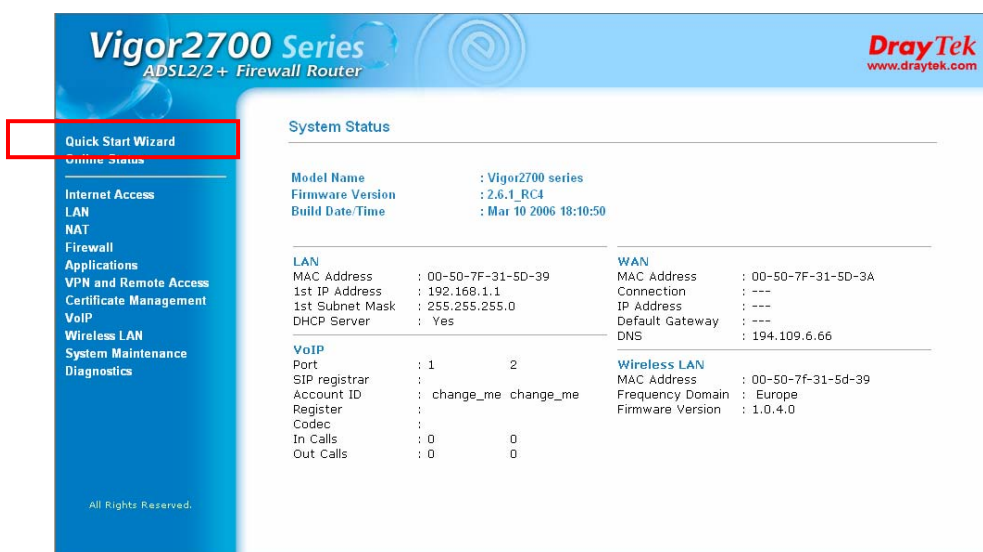

4. Enter the login password on the field of **New Password** and retype it on the field of **Retype New Password**. Then click **Next** to continue.

Quick Start Wizard

1. Enter login password

Please enter an alpha-numeric string as your **Password** (Max 23 characters).

New Password	<input type="text"/>
Confirm Password	<input type="text"/>

< Back Next > Finish Cancel

5. On the next page as shown below, please select the appropriate Internet access type according to the information from your ISP or click **Auto detect** button to detect the related DSL parameters automatically (follow the onscreen instruction). Then click **Next** for next step.

Quick Start Wizard

2. Connect to Internet

VPI	<input type="text" value="0"/>	<input type="button" value="Auto detect"/>
VCI	<input type="text" value="35"/>	
Protocol / Encapsulation	<input type="text" value="PPPoA VC MUX"/>	
Fixed IP	<input type="radio"/> Yes <input checked="" type="radio"/> No(Dynamic IP)	
IP Address	<input type="text"/>	
Subnet Mask	<input type="text"/>	
Default Gateway	<input type="text"/>	
Primary DNS	<input type="text"/>	
Second DNS	<input type="text"/>	

< Back Next > Finish Cancel

6. Choose a proper protocol/encapsulation from the drop down list. Different protocol needs different configuration.

Protocol / Encapsulation	<input type="text" value="PPPoA VC MUX"/>
Fixed IP	<input type="radio"/> Yes <input checked="" type="radio"/> No(Dynamic IP)
IP Address	<input type="text"/>
Subnet Mask	<input type="text"/>
Default Gateway	<input type="text"/>
Primary DNS	<input type="text"/>

1483 Bridged IP LLC
PPPoE LLC/SNAP
PPPoE VC MUX
PPPoA LLC/SNAP
PPPoA VC MUX
1483 Bridged IP LLC
1483 Routed IP LLC
1483 Bridged IP VC-Mux
1483 Routed IP VC-Mux (IPoA)
1483 Bridged IP (IPoE)

PPPoE or PPPoA: If you click PPPoE or PPPoA as the protocol, please manually enter the Username/Password provided by your ISP. Check **Always On** means Internet access is always on regardless of Internet usage. Then click **Next**. Besides, the protocol set here can be reviewed in the section of **DSL Modem Settings – Encapsulation** on the web page of **Internet Access – PPPoE/PPPoA**.

Quick Start Wizard

3. Set PPPoE / PPPoA

ISP Name	<input type="text" value="isp"/>
User Name	<input type="text" value="user"/>
Password	<input type="password" value="••••"/>
Confirm Password	<input type="password" value="••••"/>
<input checked="" type="checkbox"/> Always On	
Idle Timeout	<input type="text" value="-1"/> Seconds

1483 Bridged: if you click 1483 Bridged, you will get the following page. Please type in all the information originally provided by your ISP. Then click **Next** for next step. Besides, the protocol set here can be reviewed in the section of **DSL Modem Settings – Encapsulation** on the web page of **Internet Access – MPoA (1483/2684)**.

Quick Start Wizard

2. Connect to Internet

VPI	<input type="text" value="0"/>	<input type="button" value="Auto detect"/>
VCI	<input type="text" value="35"/>	
Protocol / Encapsulation	<input type="text" value="1483 Bridged IP LLC"/>	
Fixed IP	<input type="radio"/> Yes <input checked="" type="radio"/> No(Dynamic IP)	
IP Address	<input type="text"/>	
Subnet Mask	<input type="text"/>	
Default Gateway	<input type="text"/>	
Primary DNS	<input type="text"/>	
Second DNS	<input type="text"/>	

1483 Routed IP: if you click 1483 Routed IP, you will get the following page. Please type in all the information originally provided by your ISP. Then click **Next** for next step. Besides, the protocol set here can be reviewed in the section of **DSL Modem Settings – Encapsulation** on the web page of **Internet Access – MPoA (1483/2684)**.

Quick Start Wizard

2. Connect to Internet

VPI	<input type="text" value="0"/>	<input type="button" value="Auto detect"/>
VCI	<input type="text" value="35"/>	
Protocol / Encapsulation	<input type="text" value="1483 Routed IP LLC"/>	
Fixed IP	<input checked="" type="radio"/> Yes <input type="radio"/> No(Dynamic IP)	
IP Address	<input type="text" value="192.168.1.10"/>	
Subnet Mask	<input type="text" value="255.255.255.0"/>	
Default Gateway	<input type="text" value="192.168.1.1"/>	
Primary DNS	<input type="text" value="168.95.1.1"/>	
Second DNS	<input type="text"/>	

7. Now you can see the following screen. It indicates that the setup is complete. Different types of connection modes will have different summary. Click **Finish** to confirm the settings and then restart the router. Afterward, you will enjoy surfing on the Internet.

Quick Start Wizard

4. Please confirm your settings:

VPI	: 0
VCI	: 35
Protocol / Encapsulation	: 1483 Route LLC
Fixed IP	: Yes
IP Address	: 192.168.1.10
Subnet Mask	: 255.255.255.0
Default Gateway	: 192.168.1.1
Primary DNS	: 168.95.1.1
Secondary DNS	:

3.2 Wireless LAN Settings (for G Series Model Only)

For operating Vigor2700G Series well, it is necessary for you to set the wireless LAN settings for using wireless function. Please read the following section carefully for configuring the settings for this router.

(The default value of Frequency Domain was set by factory depends on the reselling region.)

3.2.1 Basic Wireless LAN Concept

In an Infrastructure Mode of wireless network, Vigor wireless router plays a role as an **Access Point (AP)** connecting to lots of wireless clients or Stations (STA). All the STAs will share the same Internet connection with other wired hosts via Vigor wireless router.

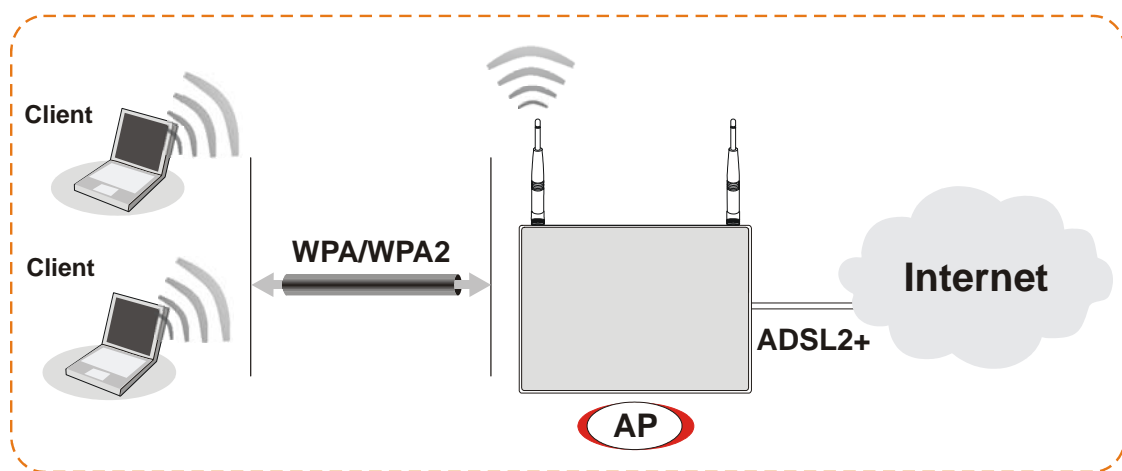

3.2.2 General Settings

1. On the **Wireless LAN** group, select **General Settings**. The following page will be shown.

Wireless LAN >> General Setup

General Setting (IEEE 802.11)

Enable Wireless LAN

Mode : Mixed(11b+11g) ▼

Index(1-15) in [Schedule](#) Setup: , , ,

SSID : default

Channel : Channel 6 ▼

Overdrive Technology:

Tx Burst

Note: the same technology must also be supported in clients to boost WLAN performance.

Hide SSID

Long Preamble

Hide SSID : prevent SSID from being scanned.

Long Preamble : necessary for some older 802.11b devices only (lowers performance).

2. Check the box **Enable Wireless LAN** to enable the wireless function.
3. Select an appropriate wireless mode.

Mode :

Mixed(11b+11g) ▼

Mixed(11b+11g)

11g Only

11b Only

- Mixed (11b+11g)** The router can connect to IEEE802.11b and IEEE802.11g stations simultaneously. This is default settings. Choose this mode if you have no idea to change the mode.
- 11g only** The router can connect to IEEE802.11g stations.
- 11b only** The router can connect to IEEE802.11b stations.

4. Type in the name of the **SSID** and **Channel**. The default name for SSID is **default**. We suggest you change it to a particular name for your necessity.

SSID (service set identifier) It is used to name the wireless LAN for this router, and it must have the same content in client PC/notebook wireless card(s). SSID can be any text numbers or various special characters.

Channel It is a wireless channel for the router. The default channel is 6. You can change it to an appropriate one if the selected channel is under serious interference. Or you can select Auto to allow the system sensing available channel automatically.

3.2.3 Security Settings

1. On the **Wireless LAN** group, select **Security** to open the following page.

[Wireless LAN >> Security Settings](#)

Security Settings

Mode: WEP

WPA:

Pre-Shared Key(PSK): *****

Type 8~63 ASCII character or 64 Hexadecimal digits leading by "0x", for example "cfigs01a2..." or "0x655abcd....".

WEP:

Key Length: 64-Bit

Key 1 : *****

Key 2 : *****

Key 3 : *****

Key 4 : *****

For 64 bit WEP key
Type 5 ASCII character or 10 Hexadecimal digits leading by "0x", for example "AB312" or "0x4142333132".

For 128 bit WEP key
Type 13 ASCII character or 26 Hexadecimal digits leading by "0x", for example "0123456789abc" or "0x30313233343536373839414243".

2. Select an appropriate encryption mode to improve the security and privacy of your wireless data packets.

Mode:
 WEP
Disable
 WEP
 WPA/PSK
 WPA2/PSK
 Mixed(WPA+WPA2)/PSK

Disable	Turn off the encryption mechanism. For the security of your router, please select any one of the encryption mode here.
WEP	Accepts only WEP clients and the encryption key should be entered in WEP Key.
WPA/PSK	Accepts only WPA clients and the encryption key should be entered in PSK.
WPA2/PSK	Accepts only WPA2 clients and the encryption key should be entered in PSK.
Mixed (WPA+WPA2)/PSK	Accepts WPA and WPA2 clients simultaneously and the encryption key should be entered in PSK.

3. For **WPA** encryption, type in 8~63 ASCII characters or 64 Hexadecimal digits leading by 0x, for example "0123456789ABCD...." or "0x321253abcde....." on the field of **Pre-Shared Key (PSK)**. WPA encrypts each frame transmitted from the radio using the Pre-Shared Key (PSK) which entered from this panel.

4. As to **WEP** encryption, select 64-bit or 128-bit as the encryption mode. For 64bits WEP key, type in 5 ASCII characters or 10 hexadecimal digitals leading by 0x, for example, ABCDE or 0x4142434445. And for 128bits WEP key, type in 13 ASCII characters or 26 hexadecimal digits leading by 0x, for example, ABCDEFGHIJKLM or 0x4142434445464748494A4B4C4D. Only one WEP key can be selected and allows user to type in the characters.
5. Click **OK** to save settings.

Be aware that for the communication, all wireless devices must support the same encryption bit length and share the same key. If WEP mode is selected, only one of four preset keys can be selected at one time.

4. Trouble Shooting

This section will guide you to solve abnormal situations if you cannot access into the Internet after installing the router and finishing the web configuration. Please follow sections below to check your basic installation status stage by stage.

- Checking if the hardware status is OK or not.
- Checking if the network connection settings on your computer are OK or not.
- Pinging the router from your computer.
- Checking if the ISP settings are OK or not.
- Backing to factory default setting if necessary.

If all above stages are done and the router still cannot run normally, it is the time for you to contact your dealer for advanced help.

4.1 Checking If the Hardware Status Is OK or Not

Follow the steps below to verify the hardware status.

1. Check the power line and WLAN/LAN cable connections.
Refer to “**2.1 Hardware Installation**” for details.
2. Turn on the router. Make sure the **ACT LED** blink once per second and the correspondent **LAN LED** is bright.

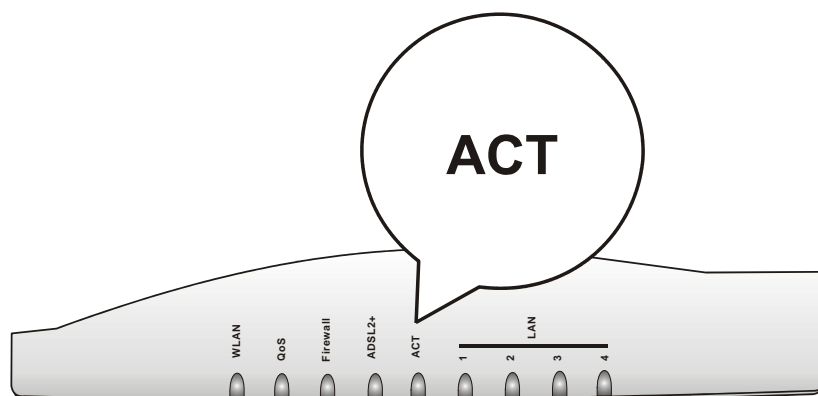

3. If not, it means that there is something wrong with the hardware status. Simply back to “**2.1 Hardware Installation**” to execute the hardware installation again. And then, try again.

4.2 Checking If the Network Connection Settings on Your Computer Is OK or Not

Sometimes the link failure occurs due to the wrong network connection settings. After trying the above section, if the link is still failed, please do the steps listed below to make sure the network connection settings is OK.

For Windows



The example is based on Windows XP. As to the examples for other operation systems, please refer to the similar steps or find support notes in www.draytek.com.

1. Go to **Control Panel** and then double-click on **Network Connections**.



2. Right-click on **Local Area Connection** and click on **Properties**.

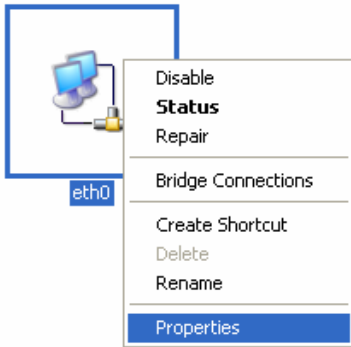

3. Select **Internet Protocol (TCP/IP)** and then click **Properties**.

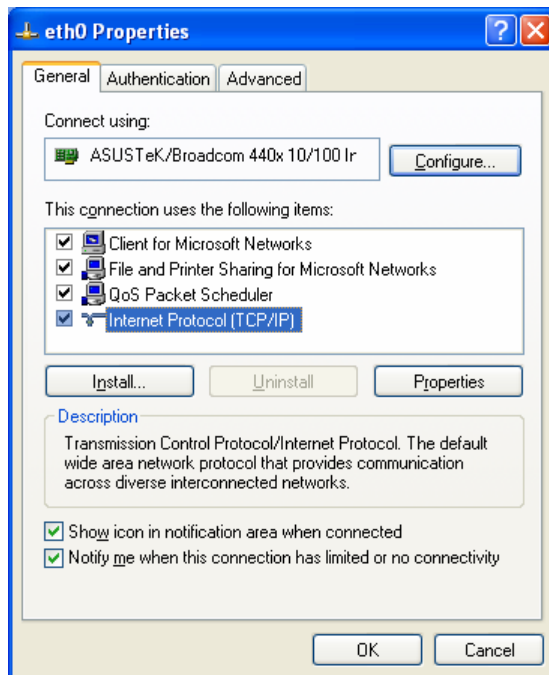

4. Select **Obtain an IP address automatically** and **Obtain DNS server address automatically**.

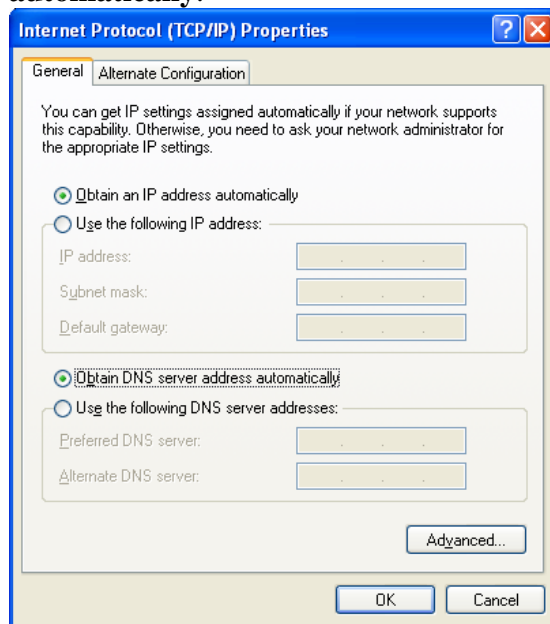

For MacOs

1. Double click on the current used MacOs on the desktop.
2. Open the **Application** folder and get into **Network**.
3. On the **Network** screen, select **Using DHCP** from the drop down list of Configure IPv4.

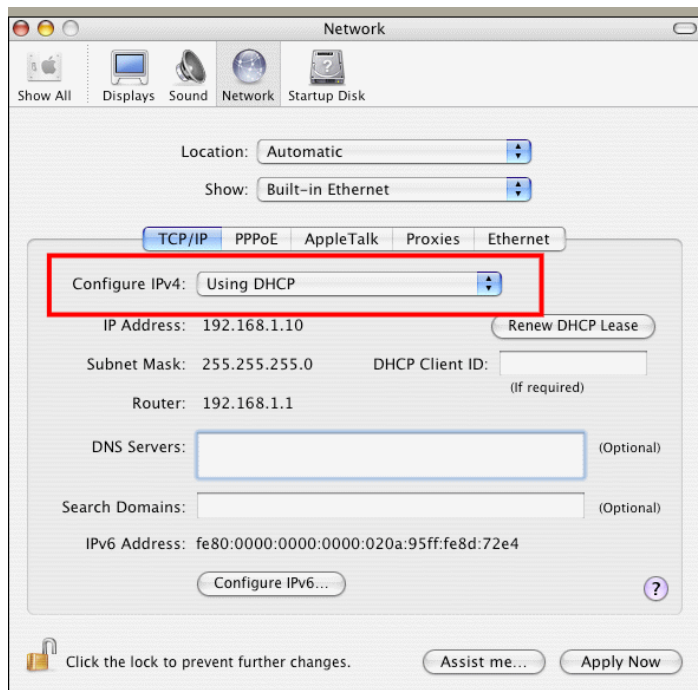

4.3 Pinging the Router from Your Computer

The default gateway IP address of the router is 192.168.1.1. For some reason, you might need to use “ping” command to check the link status of the router. **The most important thing is that the computer will receive a reply from 192.168.1.1.** If not, please check the IP address of your computer. We suggest you setting the network connection as **get IP automatically**. (Please refer to the section 4.2)

Please follow the steps below to ping the router correctly.

For Windows

1. Open the **Command Prompt** window (from **Start menu> Run**).
2. Type **command** (for Windows 95/98/ME) or **cmd** (for Windows NT/ 2000/XP). The DOS command dialog will appear.

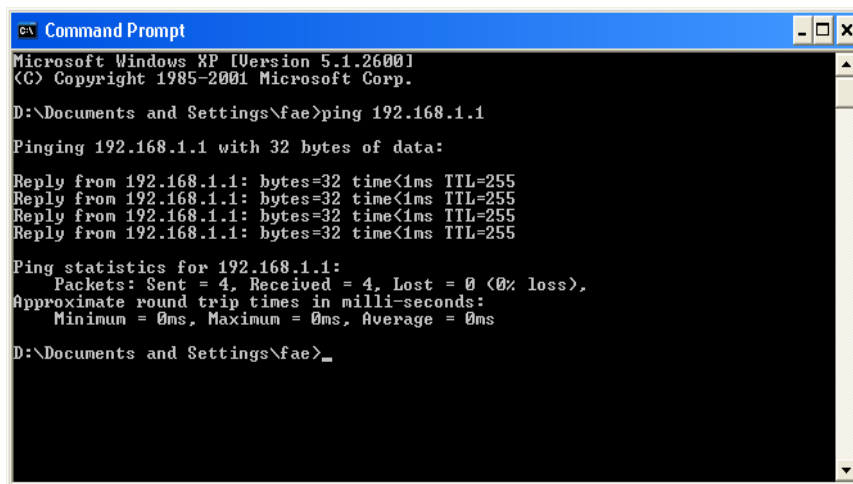

```
Microsoft Windows XP [Version 5.1.2600]
(C) Copyright 1985-2001 Microsoft Corp.

D:\Documents and Settings\fae>ping 192.168.1.1

Pinging 192.168.1.1 with 32 bytes of data:

Reply from 192.168.1.1: bytes=32 time<1ms TTL=255
Reply from 192.168.1.1: bytes=32 time<1ms TTL=255
Reply from 192.168.1.1: bytes=32 time<1ms TTL=255
Reply from 192.168.1.1: bytes=32 time<1ms TTL=255

Ping statistics for 192.168.1.1:
    Packets: Sent = 4, Received = 4, Lost = 0 (0% loss),
    Approximate round trip times in milli-seconds:
        Minimum = 0ms, Maximum = 0ms, Average = 0ms

D:\Documents and Settings\fae>_
```

3. Type **ping 192.168.1.1** and press [Enter]. If the link is OK, the line of “**Reply from 192.168.1.1:bytes=32 time<1ms TTL=255**” will appear.
4. If the line does not appear, please check the IP address setting of your computer.

For MacOs (Terminal)

1. Double click on the current used MacOs on the desktop.
2. Open the **Application** folder and get into **Utilities**.
3. Double click **Terminal**. The Terminal window will appear.
4. Type **ping 192.168.1.1** and press [Enter]. If the link is OK, the line of “**64 bytes from 192.168.1.1: icmp_seq=0 ttl=255 time=xxxx ms**” will appear.

```
Terminal — bash — 80x24
Last login: Sat Jan  3 02:24:18 on ttty1
Welcome to Darwin!
Vigor10:~ draytek$ ping 192.168.1.1
PING 192.168.1.1 (192.168.1.1): 56 data bytes
64 bytes from 192.168.1.1: icmp_seq=0 ttl=255 time=0.755 ms
64 bytes from 192.168.1.1: icmp_seq=1 ttl=255 time=0.697 ms
64 bytes from 192.168.1.1: icmp_seq=2 ttl=255 time=0.716 ms
64 bytes from 192.168.1.1: icmp_seq=3 ttl=255 time=0.731 ms
64 bytes from 192.168.1.1: icmp_seq=4 ttl=255 time=0.72 ms
^C
--- 192.168.1.1 ping statistics ---
5 packets transmitted, 5 packets received, 0% packet loss
round-trip min/avg/max = 0.697/0.723/0.755 ms
Vigor10:~ draytek$
```

4.4 Checking If the ISP Settings are OK or Not

Click **Internet Access** group and then check whether the ISP settings are set correctly.



For PPPoE/PPPoA Users

1. Check if the **Enable** option is selected.
2. Check if **Username** and **Password** are entered with correct values that you **got from your ISP**.

Internet Access >> PPPoE / PPPoA

PPPoE / PPPoA Client Mode

PPPoE/PPPoA Client Enable Disable

DSL Modem Settings

Multi-PVC channel Channel 1

VPI 0

VCI 35

Encapsulating Type VC MUX

Protocol PPPoA

Modulation Multimode

PPPoE Pass-through

For Wired LAN

For Wireless LAN

ISP Access Setup

ISP Name

Username

Password

PPP Authentication PAP or CHAP

Always On

Idle Timeout 180 second(s)

IP Address From ISP WAN IP Alias

Fixed IP Yes No (Dynamic IP)

Fixed IP Address

* : Required for some ISPs

Default MAC Address

Specify a MAC Address

MAC Address : 00 . 50 . 7F . 31 . 5D . 3A

Index(1-15) in [Schedule](#) Setup:

, , , ,

OK

For MPoA Users

1. Check if the **Enable** option for Broadband Access is selected.

[Internet Access >> MPoA \(RFC1483/2684\)](#)

MPoA (RFC1483/2684) Mode
MPoA (RFC1483/2684) Enable Disable

DSL Modem Settings
Multi-PVC channel: Channel 2
Encapsulation: 1483 Bridged IP LLC
VPI: 0
VCI: 35
Modulation: Multimode

WAN IP Network Settings
 Obtain an IP address automatically
Router Name: *
Domain Name: *
 Specify an IP address
IP Address: 0.0.0.0
Subnet Mask: 0.0.0.0
Gateway IP Address: *

* : Required for some ISPs
 Default MAC Address
 Specify a MAC Address
MAC Address : 00 . 50 . 7F . 31 . 5D . 3A

RIP Protocol
 Enable RIP

Bridge Mode
 Enable Bridge Mode

DNS Server IP Address
Primary IP Address:
Secondary IP Address:

2. Check if all parameters of **DSL Modem Settings** are entered with correct value that provided by your ISP. Especially, check if the encapsulation is selected properly or not (it should be the same with the setting on **Quick Start Wizard**).
3. Check if **IP Address**, **Subnet Mask** and **Gateway** are set correctly (must identify with the values from your ISP) if you choose **Specify an IP address**.

4.5 Backing to Factory Default Setting If Necessary

Sometimes, a wrong connection can be improved by returning to the default settings. Try to reset the router by software or hardware.



Warning: After pressing **factory default setting**, you will lose all settings you did before. Make sure you have recorded all useful settings before you pressing. The password of factory default is null.

Software Reset

You can reset the router to factory default via Web page.

Go to **System Maintenance** and choose **Reboot System** on the web page. The following screen will appear. Choose **Using factory default configuration** and click **OK**. After few seconds, the router will return all the settings to the factory settings.

Reboot System

Do You want to reboot your router ?

- Using current configuration
- Using factory default configuration

OK

Hardware Reset

While the router is running (ACT LED blinking), press the **Factory Reset** button and hold for more than 5 seconds. When you see the **ACT LED** blinks rapidly, please release the button. Then, the router will restart with the default configuration.

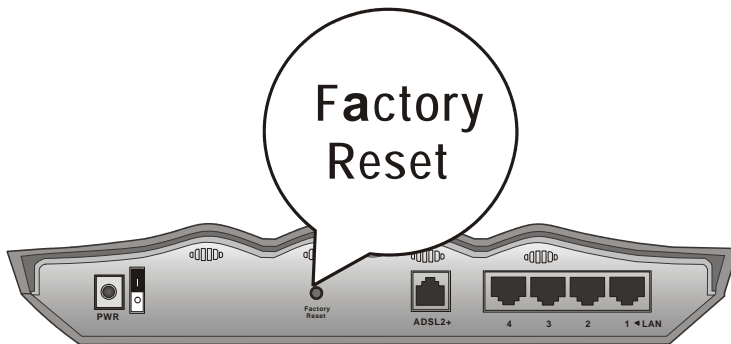

After restore the factory default setting, you can configure the settings for the router again to fit your personal request.

4.6 Contacting Your Dealer

If the router still cannot work correctly after trying many efforts, please contact your dealer for further help right away. For any questions, please feel free to send e-mail to support@draytek.com.

Free Manuals Download Website

<http://myh66.com>

<http://usermanuals.us>

<http://www.somanuals.com>

<http://www.4manuals.cc>

<http://www.manual-lib.com>

<http://www.404manual.com>

<http://www.luxmanual.com>

<http://aubethermostatmanual.com>

Golf course search by state

<http://golfingnear.com>

Email search by domain

<http://emailbydomain.com>

Auto manuals search

<http://auto.somanuals.com>

TV manuals search

<http://tv.somanuals.com>