



XDVDN8190

INSTALLATION/OWNER'S MANUAL

DVD Multimedia Receiver with Internal GPS Navigation
and 7" Touch Screen Display



Safety Notes:

The DVD video display of the in-dash unit will not operate while the vehicle is moving. This is a safety feature to prevent driver distraction. In-dash DVD video functions will only operate when vehicle is in Park and the parking brake is engaged. It is illegal in most states for the driver to view video while the vehicle is in motion.

Copyright Notes

This product incorporates copyright protection technology that is protected by method claims of certain U.S. patents and other intellectual property rights owned by Macrovision Corporation and other rights owners. Use of this copyright protection technology must be authorized by Macrovision Corporation, and is intended for home and other limited viewing uses only unless otherwise authorized by Macrovision Corporation. Reverse engineering or disassembly is prohibited.

Manufactured under license from Dolby Laboratories. "Dolby" and the double-D symbol are trademarks of Dolby Laboratories.

Windows Media and the Windows logo are trademarks, or registered trademarks of Microsoft Corporation in the United States and or other countries.

iPod is a trademark of Apple Computer, Inc., registered in the U.S. and other countries.

The Bluetooth® word mark and logos are owned by the Bluetooth SIG, Inc. and any use of such marks by Collex is under license.

NavMate® is a trademark of Horizon Navigation, Inc. The NavMate software and associated materials are protected by copyright in the US and internationally.

© 2008 Tele Atlas. All rights reserved. Tele Atlas and the Tele Atlas logo are registered trademarks of Tele Atlas N.V.

All other trademarks are property of their respective owners.

End-User License Agreement

This End-User License Agreement (EULA) is a legal agreement between you (either an individual or a single entity) and HORIZON NAVIGATION, INC. for the operating software and updates thereof that run the digital map database and associated hardware (collectively the "Software"). By installing or using the Software, you agree to be bound by the terms of this Agreement. If you do not agree to the terms of this Agreement, return the Software, along with all other accompanying items in the form they were purchased, within thirty (30) days after such purchase to the authorized dealer from where the Software was purchased, for a full refund of any fees paid. Use of the Software without acceptance of this Agreement is unauthorized and not permitted.

1. License Grant. HORIZON NAVIGATION, INC. grants you a non-exclusive license to use your purchased copy of the Software for your own internal purposes of accessing the digital map database and running the associated hardware and not for service bureau time-sharing, or other similar purposes.
2. Limitations On Use. You are not permitted to copy, modify, decompile, disassemble, or reverse engineer any portion of the Software without the expressed written permission from HORIZON NAVIGATION, INC.
3. U.S. Government End Users. The Software is provided with Restricted Rights. Use, duplication, or disclosure by the Government is subject to restrictions as set forth in subparagraph (c) (1) (II) of the Rights in Technical Data and Computer Software clause at DFARS 252.227-7013 or subparagraphs (c) (1) and (2) of the Commercial Computer Software-Restricted Rights at 48 CFR 52.227-19, as applicable. HORIZON NAVIGATION, INC., 4701 Patrick Henry Dr. Suite 1301 Santa Clara, CA 95054 USA.
4. Indemnity. You agree to indemnify, defend and hold free and harmless HORIZON NAVIGATION, INC., including its licensors, assignees, subsidiaries, affiliated companies, and the respective officers, directors, employees, shareholders, agents, authorized dealers or sales agents, and representatives of each of them from and against any liability, loss, injury, demand, cost, expense, or claim of any kind of character, including but not limited to attorney's fees, arising out of (a) any use or possession of the Software, or (b) any breach of any warranties or representations made by you in this Agreement or of your obligations under this Agreement.
5. Disclaimer of Warranty. HORIZON NAVIGATION, INC. does not make any warranties or representations, either express or implied, with respect to the software, without limiting the foregoing, HORIZON NAVIGATION, INC. expressly disclaims any implied warranties of quality, performance, merchantability, fitness for a particular purpose or non-infringement. Some states do not allow the exclusion of implied warranties, so some portion of the above exclusion may not apply to you.
6. Limitation of Liability. HORIZON NAVIGATION, INC. shall not be held responsible for any actual, anticipated or speculative loss of profit or direct, indirect, incidental, special, or consequential damages, including, without limitation, loss of revenue, data, or use incurred by you or any third party arising out of your use or possession of the software, whether in an action in contract or tort or based on a warranty, even if HORIZON NAVIGATION, INC. has been advised of the possibility of such damages.
7. Warnings. A. Copies of the digital map database reflect conditions as they existed at various points in time before your receipt of such copies. Accordingly, copies of the digital database map may contain inaccurate or incomplete data or information due to inaccurate or incomplete source materials, the passage of time, road construction, changing conditions, and otherwise. B. Neither the Software nor the digital map database include, analyze, process, consider or reflect any of the following categories of information, i.e., neighborhood quality or safety; population density; availability or proximity of law enforcement, emergency, rescue, medical or other assistance; construction work, zones, or hazards; road and lane closures; various legal restrictions (such as vehicular type, weight, load, height and speed restrictions); road slope or grade; bridge height, width, weight or other limits; road, traffic or traffic facilities safety or conditions; weather conditions; pavement characteristics or conditions; special events; traffic congestion; or travel time.
8. Transfer. This Agreement, including all rights, obligations and representations may be transferred to another individual or single entity, provided the same transfer includes the simultaneous transfer of the associated hardware in which the Software is installed, and further provided that such other individual or single entity accepts all the terms of this Agreement. In the event such individual or single entity to which the Software is transferred does not accept the terms of this agreement, then the License herein automatically terminates. Further use of the Software is unauthorized and not permitted.
9. Governing Law. This Agreement shall be governed by the laws of the State of California, without giving effect to its conflict of laws provisions.



Table of Contents

	Page
Warning Statement	3
Safety Information/Precautions	4
Preparation/Mounting/Wiring	5-7
Remote Control Overview	8
Control Locations - Monitor Closed	9-11
Control Locations - Monitor Open	12
Control Locations - Remote	13-14
General Operation	15-17
General Setup Menu	18-20
Setting the Clock	21
Anti-theft Code	22
Screen Setup	23-26
ASP Configuration	27-28
AM/FM Tuner Operation	29-32
Warning Statement	33
DVD Operation	34-42
DVD Setup	43-49
CD Operation	50-54
MP3/WMA Operation	55-58
SD Card	59-62
JPEG Operation	63-64
Media Compatibility Information	65-66
iPod Operation	67-72
Bluetooth Operation	73-76
Navigation Operation	77-83
Rear-Zone Audio Operation	84
Warranty	85
Specifications	86
Troubleshooting	87-89



XDVDN8190 PREPARATION



WARNING



Upon installation of this Monitor/DVD player ("unit") into a vehicle, the driver of the vehicle must not operate this unit by watching videos or playing video games while driving. Failure to follow this instruction could lead to driver distraction which could result in serious injury or death to the vehicle's occupants or persons outside the vehicle and/or property damage.

Several states prohibit the installation of monitors/DVD players if the screen is visible from the driver's seat. If you reside in a jurisdiction which has enacted such a law, this unit must not be installed so that the screen is visible from the driver's seat. When installing this unit in the front console/dashboard, the unit must be positioned so that it is facing the front passenger seat only. Failure to follow this instruction could lead to driver distraction which could result in serious injury or death to the vehicle's occupants or persons outside the vehicle and/or property damage.

This unit is designed so that it may be operated only when the vehicle is in "Park" and the parking brake is fully engaged. To this end, this unit includes a parking brake lock-out feature which prohibits the unit from operating if the vehicle is not in "Park" and/or the parking brake is not fully engaged. When installing this unit, the installer must connect the parking brake detect wire ("Yellow-Blue Lead") to the parking brake mechanism in order to make the parking brake lock-out feature operable. **DO NOT** simply ground the parking brake detect wire to a metal portion of the vehicle. Failure to properly install the parking brake lock-out feature could lead to driver distraction which could result in serious injury or death to the driver's occupants or persons outside the vehicle and/or property damage.

Once the parking brake lock-out feature is installed, the owner/user must not attempt to disrupt/neutralize the parking brake lock-out feature by (a) partially engaging the parking brake and/or (b) purchasing/using any device or unit designed to send necessary brake signals to the unit. Failure to follow these instructions could lead to driver distraction which could result in serious injury or death to the driver's occupants or persons outside the vehicle and/or property damage.

When operating this unit, keep the unit's volume level low enough so that the vehicle's occupants can hear traffic-related sounds such as police and emergency vehicles. Failure to follow this instruction could lead to driver distraction which could result in serious injury or death to the vehicle's occupants or persons outside the vehicle and/or property damage.



Safety Information

Please read all instructions carefully before attempting to install or operate.

Due to its technical nature, it is highly recommended that your DUAL XDVDN8190 is installed by a professional installer or an authorized dealer. This product is only for use in vehicles with 12VDC negative ground only.

Safety Notes:

The DVD video display of the in-dash unit will not operate while the vehicle is moving. This is a safety feature to prevent driver distraction. In-dash DVD video functions will only operate when vehicle is in Park and the parking brake is engaged. It is illegal in most states for the driver to view video while the vehicle is in motion.

To prevent damage or injury:

1. Make sure to ground the unit securely to the vehicle chassis ground.
2. Do not remove the top or bottom covers of the unit.
3. Do not install the unit in a spot exposed to direct sunlight or excessive heat or the possibility of water splashing.
4. Do not subject the unit to excessive shock.
5. When replacing a fuse, only use a new one with the prescribed rating. Using a fuse with the wrong rating may cause the unit to malfunction.
6. To prevent short circuits when replacing a fuse, disconnect the wiring harness first.
7. Use only the provided hardware and wire harness.
8. You cannot view video while the vehicle is moving. Find a safe place to park and engage the parking brake.
9. If you experience problems during installation, consult your nearest DUAL dealer.
10. If the unit malfunctions, reset the unit as described on page 10 first. If the problem still persists, consult your nearest DUAL dealer or call tech assistance @ 1-866-382-5476.
11. To clean the monitor, wipe only with a dry silicone cloth or soft cloth. Do not use a stiff cloth, or volatile solvents such as paint thinner and alcohol. They can scratch the surface of the panel and/or remove the printing.
12. When the temperature of the unit falls (as in winter), the liquid crystal inside the screen will become darker than usual. Normal brightness will return after using the monitor for a while.

Additional Notes:

1. When extending the ignition, battery or ground cables, make sure to use automotive-grade cables or other cables with an area of 0.75mm (AWG 18) or more to prevent voltage drops.
2. Do not touch the liquid crystal fluid if the LCD is damaged or broken. The liquid crystal fluid may be hazardous to your health or fatal. If the liquid crystal fluid from the LCD contacts your body or clothing, wash it off with soap immediately.

This device complies with part 15 of the FCC rules and regulations.

Operation is subject to the following two conditions:

- 1) This device may not cause harmful interference, and
- 2) This device must accept any interference received, including interference that may cause undesired operation.

Preparation

Please read entire manual before installation.

Before You Start

- Disconnect negative battery terminal. Consult a qualified technician for instructions.
- Avoid installing the unit where it would be subject to high temperatures, such as from direct sunlight, or where it would be subject to dust, dirt or excessive vibration.

Getting Started

- Slide the unit out of the mounting sleeve.
- Install mounting sleeve into opening, bending tabs to secure.
- Connect wiring harness and antenna as shown on pages 6-7. Consult a qualified technician if you are unsure.
- Certain vehicles may require an installation kit and/or wiring harness adapter (sold separately).
- Test for correct operation and slide unit into mounting sleeve.
- Attach unit to mounting sleeve using supplied #1 Phillips screws.
- Snap trim ring into place.
- Mount the iplug™ adapter to any smooth clean surface using the supplied double-sided tape or Phillips head screws.

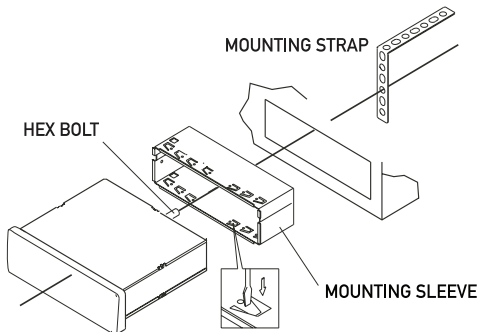
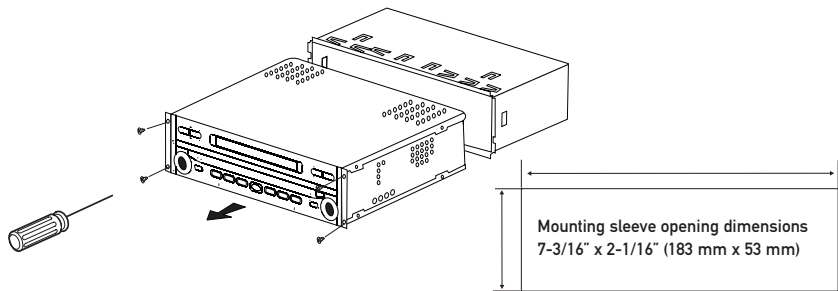

TYPICAL FRONT-LOAD DIN MOUNTING METHOD

Expanded Wiring Diagram - Inputs/Outputs

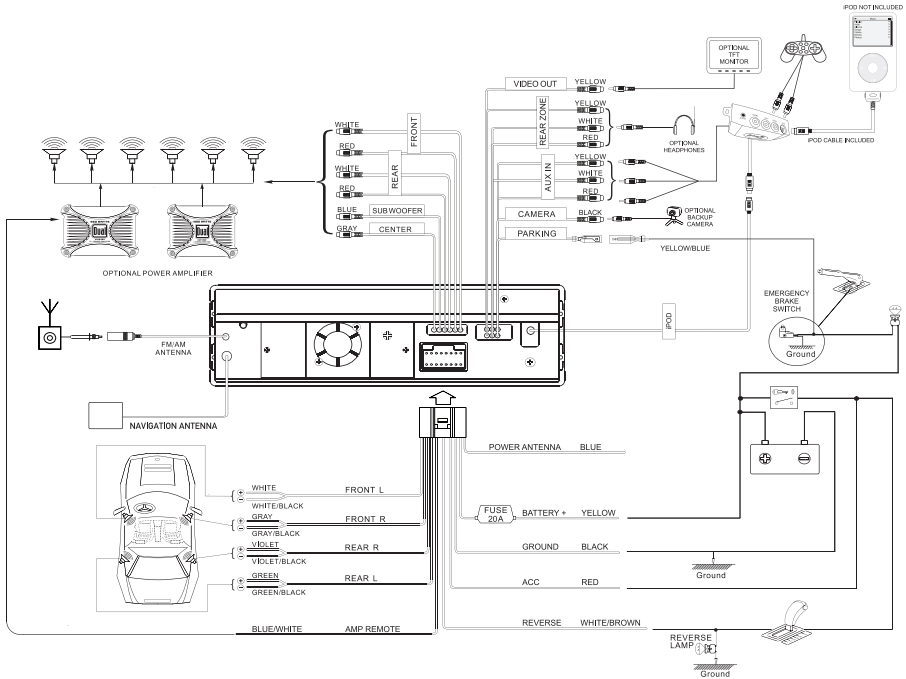

GPS Antenna Installation

Determine a suitable location for mounting the GPS antenna. For optimum reception, the antenna should be mounted in the center of the vehicle roof with a minimum of 6" from any window. The antenna can also be mounted to the rear trunk lid at least 4" from the rear window.

Do not install the antenna in a location where it may obstruct the field of view to the skyline such as on the front dashboard or rear deck tray. Clean the mounting location thoroughly before attaching the antenna. The antenna uses a powerful magnet and requires no adhesive to apply.

Do not slide the antenna during positioning as damage to the painted surface can occur. Once the antenna is mounted, carefully plan the cable route to the XDVDN8190.

Notes:

- Do not install the GPS antenna inside the vehicle - as this will reduce reception significantly.
- The antenna must be mounted on a metallic surface for best performance.
- Be careful not to pinch or twist the antenna cable.
- Use a grommet when running wires through any metal openings.

Wiring Diagram - Optional A/V Connections

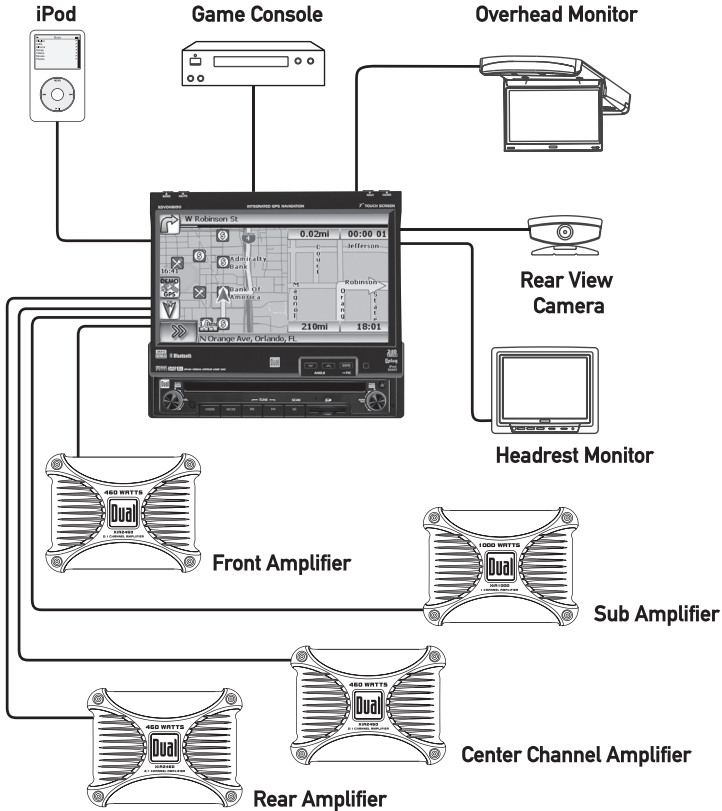

Wiring Notes:

Subwoofer output

The **SUBWOOFER** audio output (Blue RCA) is active in all audio modes and must be connected to an external amplifier.

Center output

The **CENTER** audio output (Gray RCA) is only active in DVD 5.1 (6-channel) audio modes and must be connected to an external amplifier.

Rear view camera

A rear view camera (not included) can be used with the **CAMERA** input.

Need help?

Call our Technical Service Hotline, 1-866-382-5476.

IR Remote Preparation

To first use the IR Remote control, you must first pull the battery insulation tape out

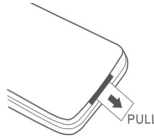

To insert or replace the battery:

Remove the battery holder

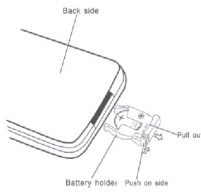

Remove the battery from the battery holder

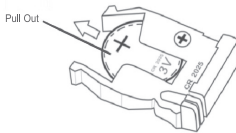

Install the new battery
Make sure to keep the (+) side up

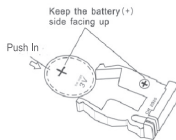

Insert the battery holder

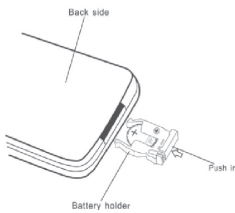

Notes:

- Remove the battery if the remote will not be used for a month or longer
- Remove and dispose of battery properly



CAUTION!!!

- Do not store battery with metallic objects or materials

Control Locations - Monitor Closed

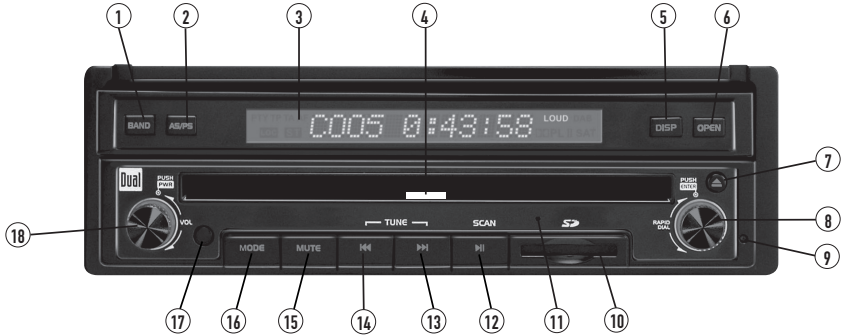

- | | |
|--------------------------|---|
| ① Band | ⑩ SD Card Slot |
| ② Auto Store/Preset Scan | ⑪ Bluetooth Hands-Free Microphone |
| ③ Secondary LCD | ⑫ Play/Pause/Scan |
| ④ Disc-In Indicator | ⑬ Channel/Chapter/Track Up/Fast Forward |
| ⑤ Display | ⑭ Channel/Chapter/Track Down/Fast Reverse |
| ⑥ Open/Close Monitor | ⑮ Mute |
| ⑦ Eject | ⑯ Mode/Rear-Zone Audio On/Off |
| ⑧ Rotary Encoder/Enter | ⑰ Infrared Sensor |
| ⑨ Reset | ⑱ Power/Volume |

Secondary LCD Information

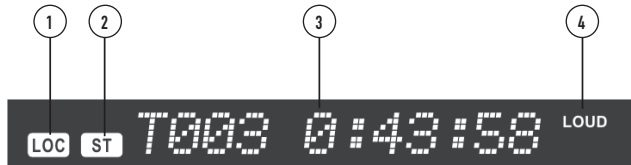

NOTE: Secondary LCD only functions when TFT monitor is closed.

- | | |
|-----------------------|--|
| 1) LOC | LOCAL indicator, icon will be off when DISTANCE (DX) is selected |
| 2) ST | STEREO radio station indicator |
| 3) TIME/TRACK/CHAPTER | Displays TRACK time, TUNING frequency, MP3 ID3 info & CLOCK information. |
| 4) LOUD | LOUDNESS selection indicator |

Control Functions - Monitor Closed

Band	Press BAND to increment from FM1, FM2, FM3, AM ⇒ FM1.
AS/PS (Auto Store/Preset Scan)	Press AS/PS momentarily to start station PRESET SCAN function. Press AS/PS for 2 seconds to start AUTO STORE station preset function in current BAND .
Secondary LCD	Additional LCD for system information while monitor is closed.
Display	When the monitor is closed, press DISP to toggle display between information available for the current mode, including clock, frequency and track information. When the monitor is open, press DISP to toggle display between the current mode and the navigation map. The navigation SD card must be inserted to use this feature.
Disc-In Indicator	Red = Disc inserted, Blue = No disc.
Open Monitor	Press OPEN to open or close the monitor. Be careful not to not touch or obstruct the monitor movement during the open/close sequence, or permanent damage could occur.
Eject	Press  once to eject disc.
Rotary Encoder/Enter	Rotate clockwise/counter-clockwise to select desired item, and press once to ENTER .
Reset	To resolve abnormal operation or if the unit is inoperable, press the RESET button located on the front bottom-right corner of the unit. The unit will reset the main processor (but not the default settings). Note: Use the tip of a pen to access the reset button. To restore the factory default settings, refer to page 19.
SD Card Slot	Insert SD card to access Navigation software, MP3, WMA or JPEG files. The card will click into place when properly inserted. To remove card, press in on the card, then release to eject.
Microphone	Use microphone for Bluetooth operation.
Play/Pause/Scan	In tuner mode, press SCAN to scan all strong stations in the current band. In disc mode, press once for PAUSE , and "PAUSE" will appear in the display. Press again to resume PLAY .
Channel/Chapter/Track Up Fast Forward	Press to select the next channel/chapter/track for playback. Press and hold to manual tune up or fast forward.
Channel/Chapter/Track Down Fast Reverse	Press to select the previous channel/chapter/track for playback. Press and hold to manual tune down or fast reverse.

Control Functions - Monitor Closed

Mute	<p>Press MUTE to silence audio output. "MUTE" will appear in the display. Press MUTE again to restore audio at previous volume level.</p>
Mode	<p>Press MODE to select between the unit's available modes, including Tuner, DVD (which includes CD and MP3/WMA playback), iPod, Camera, SD, Navigation and Auxiliary inputs. Each time the MODE button is pressed the next mode is chosen. Modes of operation are indicated on the OSD. Hold the MODE button for 3 seconds to toggle the Rear-Zone audio feature on and off.</p>
Infrared Sensor	<p>Direct the remote control towards the infrared sensor to remotely control numerous functions of the unit.</p>
Power	<p>Press PWR momentarily to turn the unit on. Press PWR for more than 3 seconds to turn the unit off.</p>
Volume	<p>When the monitor is in the open position, the left side rotary controls the volume, which is visible as a number from 0 to 40, to the right of the volume icon (🔊) displayed on the screen. When the icon is not displayed, turn the rotary to display the volume level. Turning the rotary while the volume is muted will cancel the mute function.</p> <p>Note: To program the default volume level (only up to level 20) when the unit is turned on: turn the rotary to the desired level, then push and hold the rotary for 3 seconds to program the current volume level.</p> <p>Monitor OPEN Notes:</p> <ul style="list-style-type: none"> • The angle can also be manually selected via the screen setup menu. • The color of the LCD monitor varies between viewing angles. Select the angle with the most optimum view for your location. • The last position of the monitor can be saved in memory. When "TFT Auto Open" is selected in the General Setup Menu, the monitor will return to its last position automatically the next time the unit is turned on.
Caution	<ul style="list-style-type: none"> • Due to its highly technological design, the XDVDN8190 faceplate is NOT removable. Do not attempt to remove the faceplate. • Upon installation, do not attempt to move the monitor by hand. Use the ANGLE ▲/▼ and OPEN buttons on the front panel or the remote control. • The unit will stop if it encounters any obstacles during the open/close sequence. If this occurs, remove the obstacle and press OPEN again to resume the monitor open/close sequence.

Control Locations and Functions - Monitor Open



- ① Band
- ② AS/PS
- ③ Navigation
- ④ Close Monitor
- ⑤ Info/Picture
- ⑥ Screen Angle Up
- ⑦ Screen Angle Down

Band	Press BAND to increment from FM1, FM2, FM3, AM ⇌ FM1.
AS/PS (Auto Store/Preset Scan)	Press AS/PS momentarily to start station PRESET SCAN function. Press AS/PS for 2 seconds to start AUTO STORE station preset function in current BAND .
Navi	When the monitor is open, press NAVI to toggle display between the current mode and the navigation map. The navigation SD card must be inserted to use this feature.
Close Monitor	Press CLOSE to open or close the monitor. Be careful not to touch or obstruct the monitor movement during the open/close sequence, or permanent damage could occur.
Info/Picture	Press to display DVD disc information in DVD mode. Holding this button for 3 seconds brings up the Brightness setting, which can be adjusted by pressing the ANGLE ▲/▼ buttons, turning the rotary encoder or by pressing the ◀ or ▶ buttons on the main remote control. Note: The Brightness can not be adjusted in Bluetooth mode.
Screen Angle Up	Press to adjust the angle of the screen upwards.
Screen Angle Down	Press to adjust the angle of the screen downwards.

Control Locations - Remote

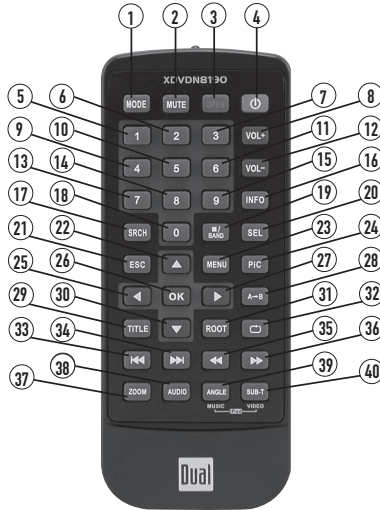



- | | | |
|---------------|---|-------------------------------------|
| ① Mode | ①⑥ Info | ③① Root |
| ② Mute | ①⑦ Search | ③② Repeat |
| ③ Open/Close | ①⑧ Key #0 | ③③ Chapter/Track/Seek Tune Down |
| ④ Power | ①⑨ Band/Stop | ③④ Chapter/Track/Seek Tune Up |
| ⑤ Key #1 | ①⑩ Audio Select | ③⑤ Fast Reverse/Manual Tune Down |
| ⑥ Key #2 | ①⑪ Escape | ③⑥ Fast Forward/Manual Tune Up |
| ⑦ Key #3 | ①⑫ 4-Way - Up | ③⑦ Zoom |
| ⑧ Volume Up | ①⑬ Menu | ③⑧ Audio |
| ⑨ Key #4 | ①⑭ Picture | ③⑨ Angle/Music mode (iPod only) |
| ⑩ Key #5 | ①⑮ 4-Way - Left | ④① Sub-Title/Video mode (iPod only) |
| ⑪ Key #6 | ①⑯ OK/Play/Pause | |
| ⑫ Volume Down | ①⑰ 4-Way - Right | |
| ⑬ Key #7 | ①⑱ Repeat A-B | |
| ⑭ Key #8 | ①⑲ Title Menu/JPEG thumbnail view/CD Scan | |
| ⑮ Key #9 | ①⑳ 4-Way - Down | |

* The remote control uses one 3 volt Lithium CR2025 battery. For best performance, replace only with CR2025 or equivalent.

Control Functions - Remote

Mode	Press once to incrementally select desired source.
Mute	Press once to MUTE audio; press again to return audio.
Open/Close	Press once to open monitor; press again to close the monitor.
Power	Press once to turn the unit on, press again to turn unit off.
Keys 0-9	Direct access chapter/track/preset station for current BAND .
Volume Up	Increase VOLUME .
Volume Down	Decrease VOLUME .
Info	Displays DVD information.
Search	Search function in the DVD mode.
Band/Stop	Press to increment BAND or to STOP while in DVD/MP3 mode.
Audio Select	Enter AUDIO Setup mode.
Escape	Exit current menu.
4-Way-Up/Down/Left/Right	Navigating system and DVD/SD/JPEG menus.
Menu	Enter the MAIN system menu.
Picture	BRIGHTNESS parameter setting for TFT.
OK	Starts/pauses playback or confirms settings.
Repeat A-B	Repeat playback from time frame A to time frame B.
Title Menu	Enters the title menu on DVD; activates thumbnail view for JPEG.
Root Menu	Enters the main menu of the DVD.
Repeat	Repeats playback of current chapter/track or folder.
Chapter/Track Down	Selects the previous chapter/track for playback.
Chapter/Track Up	Selects the next chapter/track for playback.
Fast Reverse	Fast reverses the disc/SD/iPod content.
Fast Forward	Fast forwards the disc/SD/iPod content.
Zoom	Zooming in/out on an image from DVD disc or JPEG.
Audio	Change the audio language for DVD disc playback.
Angle	Selects between different angles (when available) for a scene/Selects iPod Music mode/Rotates JPG clockwise.
Sub-Title	Language selection for subtitle/Selects iPod Video mode.

General Operation

- Power On/Off** | Press **PWR** to turn the unit on. Hold for 3 seconds to turn the unit off.
- Mute** | Press **MUTE** to silence the audio:  will appear in the OSD (On Screen Display). Press **MUTE** again to cancel.
- Mode** | Press **MODE** to select between Tuner, Disc, iPod, Bluetooth, Camera, SD, Navigation and Auxiliary inputs. Modes of operation are indicated in the **OSD** (On Screen Display). iPod, and SD card (optional) must be connected/inserted to appear in the **MODE** selection string.
- Optional Mode Selection** | Press the top left corner of the screen to display the **OSD** menu bar. Press Tuner, Disc, iPod, Bluetooth, Camera, SD, Navigation or Auxiliary in the **MAIN** menu page to select the desired source.
- Volume** | Adjust **VOLUME** using rotary encoder or the **VOL +/-** buttons (00-40).
- Audio Adjustment (from front panel)** | Press volume knob momentarily to enter the Audio Adjustment menu. Press volume knob momentarily to advance to desired parameter to be changed. Turn volume knob  or  to adjust to desired level. Press volume knob to advance to next selection or press and hold to exit.



6-Channel Audio Settings	
Item	Adjustable Range
Master Volume	00 to 40
Front Left Channel Volume	-10 to +10
Front Right Channel Volume	-10 to +10
Rear Left Channel Volume	-10 to +10
Rear Right Channel Volume	-10 to +10
Center Channel Volume	-10 to +10
Subwoofer Volume	-10 to +10



Note: 6-Channel audio is only adjustable when "Full 6CH" mode is selected. Refer to page 47 for more details.

Audio Adjustment (from remote)











Press the **SEL** button. Press the **▲** or **▼** buttons on the remote to select an item to be adjusted. Press **◀** or **▶** to adjust the desired setting. Press the **ESC** button on the remote control to exit the audio control menu.

Note: The Bass and Treble levels are only adjustable when EQ is set to "User" mode. The Loud function compensates for deficiencies in sound ranges at low levels. When the Loud function is on, LOUD is displayed in the OSD.

General Operation

- | | |
|----------------------|---|
| INFO/PIC | Press INFO momentarily to display DVD disc information. |
| Monitor Brightness | Press and hold PIC for 3 seconds to change monitor BRIGHTNESS . Turn volume knob  or  to adjust to desired level (0 minimum/20 maximum; 10 is default). |
| CVBS Screen Controls | While in iPod Video playback, Aux or Camera mode : Press and hold PIC for 3 seconds to access PICTURE MENU . Press PIC momentarily to step to next selection: |



- | | |
|------------|--|
| Sharpness | Turn volume knob  or  to adjust the sharpness. (0 minimum/+20 maximum). |
| Color | Turn volume knob  or  to adjust the color. (0 minimum/+20 maximum). |
| Contrast | Turn volume knob  or  to adjust the contrast. (0 minimum/+20 maximum). |
| Brightness | Turn volume knob  or  to adjust the brightness. (0 minimum/+20 maximum). |
| Tint | Turn volume knob  or  to adjust the tint. (0 minimum/+20 maximum). |

Note: Adjustments to Sharpness, Color, Contrast, Brightness, or Tint are only possible while in either **iPod video playback, Aux or Camera mode**. A video signal must be present for adjusting the CVBS screen controls.

General Operation - Main Menu

Main Menu Access

There are two methods to access the MAIN menu:

- Press **MENU** button on the remote control.
- Touch the upper left corner of the touch screen.

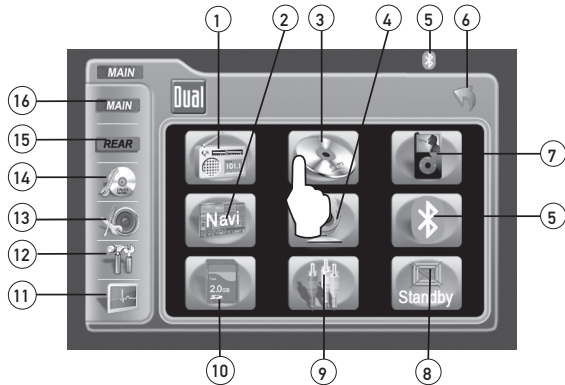

Touch Access Buttons

- 1) Touch to access **AM/FM TUNER** mode.
- 2) Touch to access **NAVIGATION** mode (Navigation SD card must be inserted).
- 3) Touch to access **CD/DVD** mode (CD/DVD must be inserted).
- 4) Touch to access **CAMERA** mode, if optional camera isn't connected, "No Signal Detected" will be displayed.
- 5) Touch to access **BLUETOOTH** mode (**BLUETOOTH** must be activated first). Refer to page 73 for more details.
- 6) Touch to **RETURN** to previous screen.
- 7) Touch to access **iPod** mode (optional iPod must be connected to activate).
- 8) Touch to enter **STANDBY** mode. Touch the screen again (or any button) to resume normal operation.
Note: VOLUME level can be controlled in **STANDBY** mode.
- 9) Touch to access **AUXILIARY A/V INPUT** mode.
- 10) Touch to access **SD** mode (optional SD card must be inserted).
- 11) Touch to access **SCREEN SETUP** menu.
- 12) Touch to access **GENERAL SETUP** menu.
- 13) Touch to access **ASP Config** menu.
- 14) Touch to access **CD/DVD SETUP** menu, (CD/DVD must be inserted to function).
- 15) Touch to access **REAR ZONE** menu.
- 16) Touch to access **MAIN** menu.

Rapid Dial Rotary Encoder

The rotary encoder on the right side can also control touch screen functions from the main menu.

- Select desired function rotating clockwise or counter-clockwise.
- Press to confirm/**ENTER**.

GENERAL Setup - Menu



General Setup Menu

- Press **GENERAL** icon to access the **GENERAL** setup mode.
- Select desired parameter you wish to change.
- Page will return back to previous screen after 15 seconds of inactivity or by pressing the **RETURN** button.

GENERAL Setup Menu matrix - page 1

Settings	Default	Options	Function
Radio	USA	USA	Set to appropriate setting for your country
		S-Amer1	
		S-Amer2	
		Europe	
Clock adjust	AM	00:00	See adjusting the clock on page 21 for more details
Clock Mode	12Hr	12Hr	PM 6:00
		24Hr	18:00
Camera Image	Normal	Normal	Normal Image
		Reverse	Mirror camera input image 180 degrees
Video Format	Auto	Auto	System will auto detect NTSC or PAL
		NTSC	For NTSC compatibility
		PAL	For PAL compatibility
TFT Auto Open	Off	On	TFT panel will automatically open when IGN is turned on
		Off	TFT panel will not auto open when IGN is turned on
		Manual	TFT will only open/close when OPEN button is pressed

GENERAL Setup - Menu

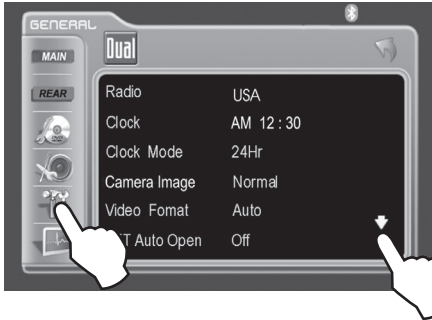

General Setup Menu

- Press **GENERAL** icon to access the **GENERAL** setup mode.
- Press **PAGE** icon in the lower right corner.
- Select desired parameter you wish to change.
- Page will return back to previous screen after 15 seconds of inactivity or by pressing the **RETURN** button.

GENERAL Setup Menu matrix - page 2

Settings	Default	Options	Function
Bluetooth	Off	Off	Turns off the Bluetooth functionality
		On	Enables Bluetooth functionality
Anti-theft Code	0000	----	Must enter password to turn anti-theft on or off
Anti-theft active	Off	On	System will require a password if main battery power is removed for more then 40 seconds
		Off	No password will be required if power is removed
Load Factory defaults	Yes	Are you sure? Yes/Cancel	Load all factory parameters to their original settlings. Notes: This will not reset the anti-theft password. Default anti-theft password is 0000.

GENERAL Setup - Adjusting Radio Frequency

Adjusting Radio Frequency

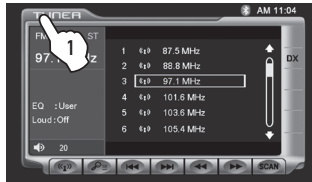

Step 1 Touch top left corner of screen.



Step 2 Touch GENERAL icon.

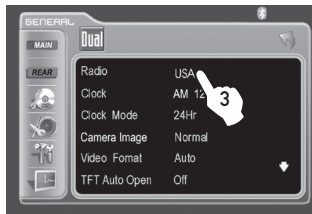

Step 3 Touch USA.



Step 4 Touch the setting for your region.

Step 5 Touch RETURN to exit.

GENERAL Setup - Adjusting the Clock

12Hr Clock Mode

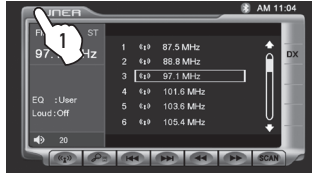

Step 1 1) Touch top left corner of screen.

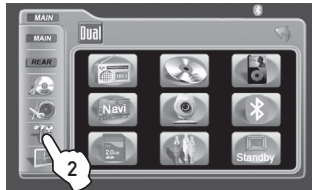

Step 2 2) Touch GENERAL icon.

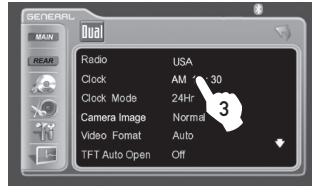

Step 3 3) Touch 00:00 area in the CLOCK row.

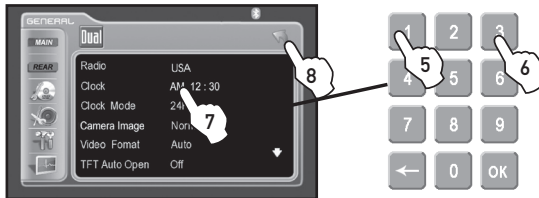

Steps 4-8
 4) Keypad will appear.
 5) Enter HOURS, touch OK.
 6) Enter MINUTES, touch OK.
 7) Touch AM or PM to set.
 8) Touch RETURN to exit.

24Hr Clock Mode

For 24Hr format, select 24Hr from CLOCK MODE, then follow steps 1-8.

GENERAL Setup - Setting the Anti-theft code

Default Anti-theft password is 0000 and is turned off. To turn this feature on, follow the steps below.

CAUTION!!

This will lock your unit from operating if battery power is disconnected for more than 5 minutes.



Step 1 & 2 1) Touch top left corner of screen. 2) Touch GENERAL icon.

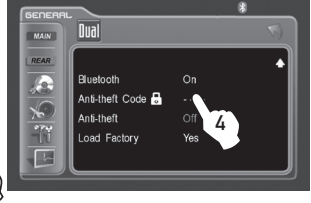
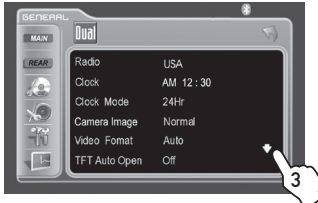

Step 3 & 4 3) Touch down arrow icon. 4) Touch ----.

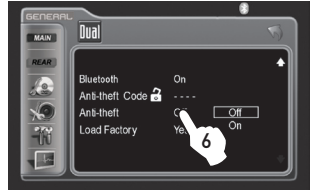

Step 5 & 6 5) Enter 0000, then press OK. 6) Touch Off.

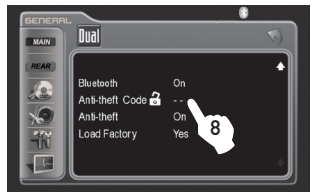
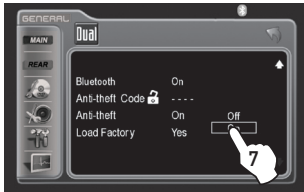

Step 7 & 8 7) Touch On. 8) Touch ---- again.



9) Enter your new 4-digit password, then press OK.

10) Touch RETURN to exit.

Note: it is recommended that you choose your own 4-digit password carefully, write it down somewhere and keep in a safe location. In the event you ever lose or forget your password, call our tech hot line for support on how to unlock your system.

Step 9 & 10

SCREEN Setup - Menu

Screen Setup Menu



- Press **SCREEN** icon to access the **SCREEN** setup mode.
- Select desired parameter you wish to change.
- Page will return back to previous screen after 15 seconds of inactivity or by pressing the **RETURN** button.

SCREEN Setup Menu matrix

Settings	Default	Options	Function
Brightness	10	0 - 20	Press ◀ or ▶ on the remote or press the right side rotary once and rotate clockwise/counter-clockwise to adjust the Brightness to the desired setting
Screen Tilt	4	1 - 6	Select 1 to 6 to adjust the default tilt angle of the screen
Screen Saver	On	Off	Select On to activate the screen saver, Off to deactivate
		On	
TS Calibrate	No	No	Touch Yes to enter the Touch Screen calibration mode
		Yes	
Version			Software version of unit

System Standby



To conserve the LCD backlight lifespan and eliminate glare while night driving, press **STANDBY**. The TFT screen will turn off (black out), however all other operations continue to operate. Press any button except **VOLUME** or **MUTE**, or touch the screen again to return to normal viewing.

SCREEN Setup - Setting TFT Brightness

This will set the default setting for the TFT display brightness.

This can also be set by pressing the INFO button on the front TFT panel.



Step 1

1) Touch top left corner of screen.



Step 2

2) Touch SCREEN icon.

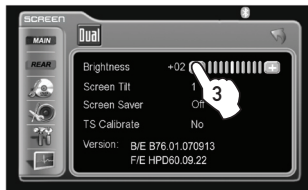

Step 3

3) Touch [-] to reduce brightness.

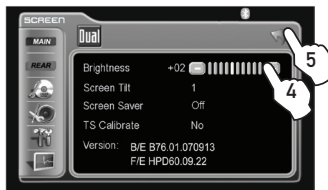

Step 4

4) Touch [+] to increase brightness.

0 - 20 is possible
Default = 10

Step 5

5) Touch RETURN to exit.

SCREEN Setup - Setting TFT Angle

Set for best viewing angle for your vehicle

Step 1

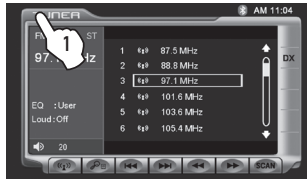

1) Touch top left corner of screen.

Step 2



2) Touch SCREEN icon.

Step 3

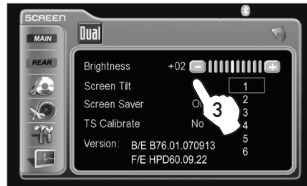

3) Touch a number displayed in SCREEN TILT row.

Step 4

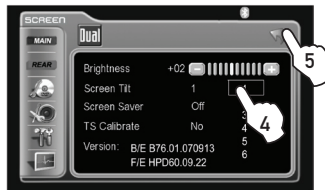

4) Touch desired angle for best viewing angle.

Step 5

5) Touch RETURN to exit.

1 - 6 is possible
Default = 4

SCREEN Setup - Touch Screen Calibration

Upon initial installation or occasionally, the touch screen may have to be calibrated. Follow these steps as described.



Step 1 1) Touch top left corner of screen.



Step 2 2) Touch SCREEN icon.



Step 3 & 4 3) Touch No in TS Calibrate row.
4) Then touch Yes.



Step 5 & 6 5) Touch and hold the pointers as indicated on the screen for 2 seconds each.
6) Screen will automatically return to MAIN MENU, touch RETURN to exit.

Notes: For proper calibration you must touch each pointer for 2 seconds. If pointers are not touched properly, the calibration sequence will start over until the calibration is done correctly.

ASP Config - Audio Settings



Notes: These settings affect the quality of the audio in "Downmix" mode only and are primarily for use by a professional installer. For the casual user, it is recommended to only adjust the general sound quality by using the Audio Setup Menu, which is accessed by pressing the **SEL** button on the remote or momentarily pressing the left side rotary.

Bass Freq Sets the bass center frequency for optimal bass effect.
Choices are 60, 80, 100, and 200Hz.

Treble Freq Sets the treble center frequency for optimal treble effect.
Choices are 10, 12.5, 15 and 17KHz.

Sub Filter Sets the subwoofer crossover frequency which affects the subwoofer's low-pass filter and the "SMALL" speakers' high-pass filter.
Choices are 80, 120 and 160Hz.

Notes: This setting has no effect when the subwoofer is set to "OFF" and/or if any other speaker is set to "LARGE".

Bass Q-Factor This setting alters the sharpness or "Q factor" of the bass output.
Choices are 1.0, 1.25, 1.5 and 2.0.

ASP Config - Audio Settings

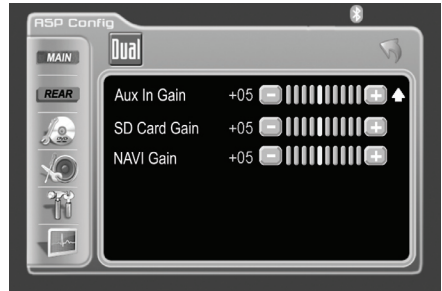
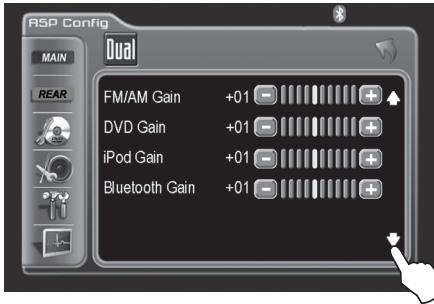

Notes: The Gain settings allow you to customize the relative volume of the various modes to compensate for volume differences between the sources. The range is adjustable between -7 to +7, with 0 being the reference point (default level).

FM/AM Gain Adjusts the relative volume in AM/FM Tuner mode.

DVD Gain Adjusts the relative volume in DVD/CD/MP3/WMA mode.

iPod Gain Adjusts the relative volume in iPod mode.

Bluetooth Gain Adjusts the relative volume in Bluetooth mode.

Aux In Gain Adjusts the relative volume in Aux In mode.

SD Card Gain Adjusts the relative volume in SD Card mode.

NAVI Gain Adjusts the relative volume in Navigation mode.

Note that **Aux In Gain**, **SD Card Gain** and **NAVI Gain** are on a separate screen, which is accessed by touching the white arrow at the bottom right corner of the screen.

AM/FM Tuner Operation - OSD Overview

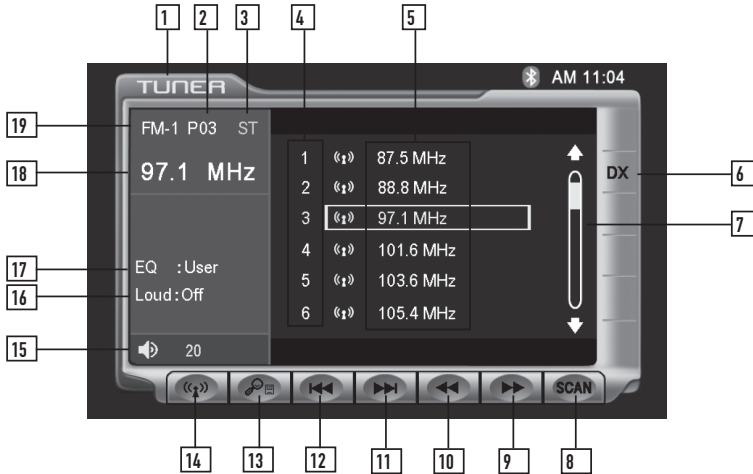

Tuner Mode

From the main menu, touch TUNER icon on the screen to select AM/FM Tuner mode.

- 1
Current Source Indicator
Displays source currently playing.
- 2
Preset Number Indicator
Shows what preset has been selected.
- 3
Stereo Indicator
Shows that the frequency selected is received in stereo.
- 4
Preset Number List Display
Shows the preset list by preset number.
- 5
Preset Station List Display
Shows the preset station list by frequency. Touch frequency to select a preset. Touch and hold frequency to store presets.
- 6
Local / DX Tuning Mode
Shows when local or distance tuning is on.
- 7
Preset Display Scroll Bar
Allows scrolling of preset list.
- 8
Tuner Scan
Touching this icon will scan through all available stations in the current band.















AM/ FM Tuner Operation - OSD Overview

- | | |
|-----------|---|
| 9 | <p>Tune Frequency - Up
Touching this icon will tune the radio to a higher frequency by one frequency step. Touch and hold for continuous tuning up. (This function can also be performed by pressing the corresponding key on the front panel or remote control.)</p> |
| 10 | <p>Tune Frequency - Down
Touching this icon will tune the radio to a lower frequency by one frequency step. Touch and hold for continuous tuning down. (This function can also be performed by pressing the corresponding key on the front panel or remote control.)</p> |
| 11 | <p>Seek Next Station - Up
Touching this icon will tune to the next strong station at a higher frequency. (This function can also be performed by pressing the corresponding key on the front panel or remote control.)</p> |
| 12 | <p>Seek Next Station - Down
Touching this icon will tune to the next strong station at a lower frequency. (This function can also be performed by pressing the corresponding key on the front panel or remote control.)</p> |
| 13 | <p>Preset Scan/Auto Station Tune
Touching this icon will scan through all presets in the current band. (This function can also be performed by pressing the AS/PS button.) Holding this button for more than 2 seconds will automatically program the 12 strongest stations available into the presets in the current band. (This function can also be performed by holding the AS/PS button.)</p> |
| 14 | <p>Band
Touch band icon repeatedly until the desired band is displayed, FM-1, FM-2, FM-3, or AM. (This function can also be performed by pressing BAND button.)</p> |
| 15 | <p>Volume Indicator
Indicates current volume level, controlled by rotary encoder.</p> |
| 16 | <p>Loudness Indicator
Touch screen here to enter Audio Setup Menu.</p> |
| 17 | <p>EQ Indicator
Touch screen here to enter Audio Setup Menu.</p> |
| 18 | <p>Current Station Indicator
Indicates current frequency.</p> |
| 19 | <p>Band Indicator
Shows which band the radio is tuned to, FM-1, FM-2, FM-3, or AM.</p> |

AM/FM Tuner Operation



AM/FM Tuner Mode	<p>From the main menu, touch TUNER icon to select AM/FM Tuner mode.</p> <p>From the remote control or the front panel: Press MODE until TUNER is displayed on the screen.</p>
Band	<p>Touch  on the screen repeatedly until the desired band is displayed, FM-1, FM-2, FM-3, or AM.</p> <p>Press the BAND button to switch between bands, FM-1, FM-2, FM-3, AM.</p> <p>From the remote control: Press the BAND button.</p>
Manual Tuning	<p>Touch  on the screen to tune to the next higher frequency step. Touch  on the screen to tune to the next lower frequency step.</p> <p>Touch and hold either  or  on the screen to continue tuning across multiple stations.</p> <p>From the remote control: Touch  or  to perform manual tuning.</p>
Seek Tuning	<p>Touch  to tune to the next higher strong station. Touch  to tune to the next lower strong station.</p> <p>From the remote control: Press  to tune to the next higher strong station. Press  to tune to the next lower strong station.</p>
Storing Presets	<p>There are 36 FM and 12 AM presets available in 4 bands. After finding a frequency that you would like to store in memory, touch and hold the screen on any of the frequencies in the preset station list until it turns yellow.</p>
Auto Store Presets	<p>Touch and hold the  icon to automatically program the 12 strongest stations available into the presets in the current band.</p> <p>Press and hold the AS/PS button for more than 2 seconds.</p>
Preset Scan	<p>Touching the  button will scan through all tunable presets in the current band and play them for 10 seconds each.</p> <p>Press the AS/PS button momentarily.</p>



AM/ FM Tuner Operation

Direct Preset Tuning

To select a desired station from the preset station list, touch any of the displayed station frequencies from the list.

Use Rapid Dial by turning the right rotary clockwise or counter-clockwise, and pressing \square to select the highlighted channel.

Use the up and down arrows on screen to scroll through the presets. Once highlighted, simply touch the screen at the appropriate preset.

From the remote control:

Press \blacktriangle or \blacktriangledown to scroll through the presets. When the correct preset is highlighted press **OK**.

Use the numeric keypad to enter the desired preset number.

Scan Tuning

Touch **SCAN** on the screen and it will tune you to all stations available with good reception for 10 seconds at a time. Touch **SCAN** again to disable. (This function can also be performed by pressing the corresponding key on the front panel.)

Local/Distance Tuning

Local tuning lets you tune in radio stations with sufficiently strong signals for good reception. In areas that reception is poor, you can switch from local to distance tuning by touching the **LOC** button on the screen. To return to distance tuning mode, press the **LOC** button again. (Distance tuning is the default tuning mode.)

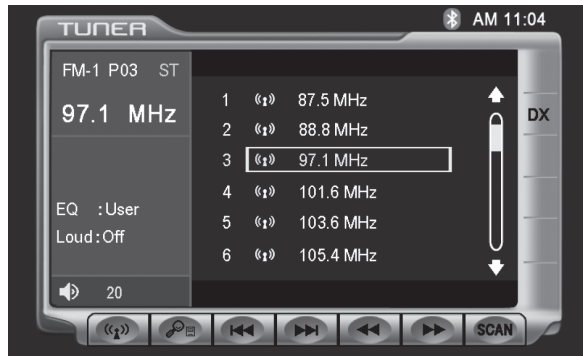



⚠ WARNING ⚠

Upon installation of this Monitor/DVD player ("unit") into a vehicle, the driver of the vehicle must not operate this unit by watching videos or playing video games while driving. Failure to follow this instruction could lead to driver distraction which could result in serious injury or death to the vehicle's occupants or persons outside the vehicle and/or property damage.

Several states prohibit the installation of monitors/DVD players if the screen is visible from the driver's seat. If you reside in a jurisdiction which has enacted such a law, this unit must not be installed so that the screen is visible from the driver's seat. When installing this unit in the front console/dashboard, the unit must be positioned so that it is facing the front passenger seat only. Failure to follow this instruction could lead to driver distraction which could result in serious injury or death to the vehicle's occupants or persons outside the vehicle and/or property damage.

This unit is designed so that it may be operated only when the vehicle is in "Park" and the parking brake is fully engaged. To this end, this unit includes a parking brake lock-out feature which prohibits the unit from operating if the vehicle is not in "Park" and/or the parking brake is not fully engaged. When installing this unit, the installer must connect the parking brake detect wire ("Yellow-Blue Lead") to the parking brake mechanism in order to make the parking brake lock-out feature operable. DO NOT simply ground the parking brake detect wire to a metal portion of the vehicle. Failure to properly install the parking brake lock-out feature could lead to driver distraction which could result in serious injury or death to the driver's occupants or persons outside the vehicle and/or property damage.

Once the parking brake lock-out feature is installed, the owner/user must not attempt to disrupt/neutralize the parking brake lock-out feature by (a) partially engaging the parking brake and/or (b) purchasing/using any device or unit designed to send necessary brake signals to the unit. Failure to follow these instructions could lead to driver distraction which could result in serious injury or death to the driver's occupants or persons outside the vehicle and/or property damage.

When operating this unit, keep the unit's volume level low enough so that the vehicle's occupants can hear traffic-related sounds such as police and emergency vehicles. Failure to follow this instruction could lead to driver distraction which could result in serious injury or death to the vehicle's occupants or persons outside the vehicle and/or property damage.

DVD Operation - Parking Brake Initialization



CAUTION !!!
IT'S UNLAWFUL TO OPERATE
A VEHICLE WHILE VIDEO IS
DISPLAY IN THE DRIVERS
VIEWING AREA

ENGAGE EMERGENCY BRAKE
TO ENJOY VIDEO

Front Monitor Video Initialization

Parking Brake Initialization Situation 1

Parking Brake Initialization Situation 2

SAFETY WARNING

- The video display of the in-dash unit will not operate while the vehicle is moving. This is a safety feature to prevent driver distraction. In-dash video functions will only operate when vehicle is in Park and the **PARKING BRAKE** is engaged. It is illegal in most states for the driver to view video while the vehicle is in motion. Refer to local laws in your area.
- The vehicle must be in park and the parking brake applied to view video on the in-dash monitor.
- As a safety feature, "**ENGAGE PARKING BRAKE**" blue screen will show on the display when the vehicle's parking brake is not engaged. Video display on the front monitor isn't allowed until the **PARKING BRAKE** is engaged. By connecting the yellow/blue **PARKING BRAKE** wire to brake switch circuit as described below, DVD and AUX AV audio can be heard while the vehicle is in motion without engaging the parking brake.

Follow these two initialization procedures carefully to allow video playback on the XDVDN8190 front monitor:

There are two situations that start the **PARKING BRAKE** sequence.

First situation (if vehicle is moving):

- 1) Stop vehicle, put in Park, make sure **PARKING BRAKE** is off/released.
- 2) Depress **PARKING BRAKE** for 1 second.
- 3) Release **PARKING BRAKE** for 1 second.
- 4) Depress **PARKING BRAKE** permanently.

Note:

Once above procedure 1-4 is completed, video will display in about 2 seconds.

Second situation (if vehicle is already parked and the **PARKING BRAKE** is already applied):

- 1) Keep vehicle in Park, **PARKING BRAKE** should be on.
- 2) Release **PARKING BRAKE** for 1 second.
- 3) Depress **PARKING BRAKE** for 1 second.
- 4) Release **PARKING BRAKE** for 1 second.
- 5) Depress **PARKING BRAKE** permanently.

Notes:

Once 2nd procedure 1-5 is completed, video will display in about 2 seconds. The transition time must be less than 2 seconds between depress and release. This procedure will have to repeated when the IGN is turned off.

DVD Operation - Region Management



DVD Region Management

Some DVD discs can be played only in certain playback modes according to the intentions of the software. As the XDVDN8190 plays discs according to their intentions, some functions may not work as intended. Please be sure to read the instructions provided with each disc. This player has been designed to play back DVD software that has been encoded for specific region areas. It cannot play back DVD software encoded for other region areas than the region areas for which it has been designed.



The XDVDN8190 will play discs labeled "Region 1" or "All".





DVD region codes:

- 1 - USA, Canada
- 2 - Japan, Europe, South Africa, Middle East
- 3 - Rep. of Korea, Taiwan, Hong Kong, Parts of Southeast Asia
- 4 - Australia, New Zealand, Mexico, South America
- 5 - Eastern Europe, Russia, India, Africa
- 6 - China

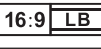

DVD Disc Symbols

Symbol	12cm Disc Properties	Max Play Time
	Single side single layer (DVD-5) Single side double layer (DVD-9) Double side single layer (DVD-10) Double side double layer (DVD-18)	(MPEG 2 Method) 133 minutes 242 minutes 266 minutes 484 minutes
	Single side single layer (VCD)	(MPEG 1 Method) 74 minutes
	Single side single layer	74 minutes

Symbol	Meaning
	Number of voice languages recorded. The number inside the icon indicates the number languages on the disc (maximum of 8).
	Number of subtitle languages available on the disc (maximum of 32).
	Number of angles provided (maximum of 9).
	Aspect ratios available. "LB" stands for Letter Box and "PS" stands for Pan/Scan. In the example on the left, the 16:9 video can be converted to Letter Box video.
	Indicates the region code where the disc can be played. <ul style="list-style-type: none"> • Region 1: USA, Canada, East Pacific Ocean Islands • Region 2: Japan, Western Europe, Northern Europe, Egypt, South Africa, Middle East • Region 3: Taiwan, Hong Kong, South Korea, Thailand, Indonesia, South-East Asia • Region 4: Australia, New Zealand, Middle and South America, South Pacific Ocean Islands/ Oceania • Region 5: Russia, Mongolia, India, Middle Asia, Eastern Europe, North Korea, North Africa, North-West Asia

Notes:

Some DVD discs can be played only in certain playback modes according to the intentions of the software. As the XDVDN8190 plays discs according to their intentions, some functions may not work as intended. Please be sure to read the instructions provided with each disc.



DVD Operation - Inserting a Disc

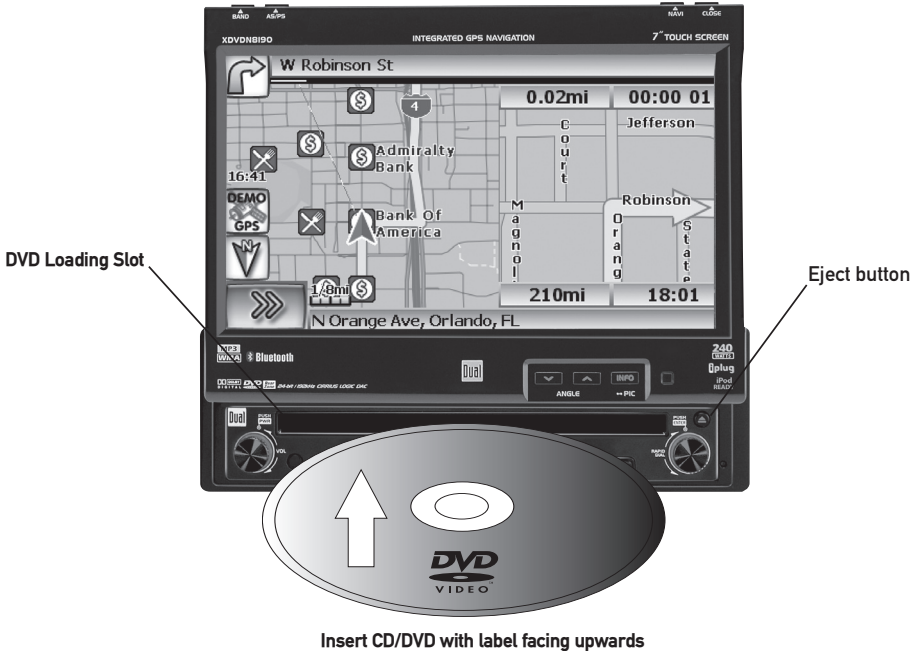

Inserting a Disc

With the label facing up, insert a standard size disc into the slot. The disc will automatically begin playback. Other sub-menus may have to be pressed to access the DVD movie/music content. Read the directions of your specific DVD disc for other features.

Note: If PARENTAL Lock is activated and the disc inserted is not authorized, a 4-digit code must be entered and/or the disc be authorized. See "RATING MENU" on page 49.

Note: Only one disc can be inserted at a time.

Ejecting the Disc

Press the EJECT button.

Resetting the Loading Mechanism

If the disc loads abnormally or an system error occurs, press and hold the eject button for 3 seconds to reset the loading mechanism. The disc will eject and normal operation should resume.

DVD Operation - Touch Screen Controls



Hidden Touch Screen area while in TUNER mode

There are several hidden TOUCH SCREEN areas as outlined below:

"A" area can be used in any mode to access MAIN menu.



Hidden Touch Screen areas while in DVD mode

"A-F" areas can be used in DVD mode to access:

- A - Displays MAIN menu
- B - Displays DVD disc information
- C - Selects PREVIOUS chapter
- D - Selects NEXT chapter
- E - Displays the full DVD transport controls
- F - Displays GOTO search menu





DVD Operation - Touch Screen Controls

Using the hidden Touch Screen Controls

- A - Displays **MAIN** menu
- B - Displays **DVD** disc information
- C - Selects **PREVIOUS** chapter
- D - Select **NEXT** chapter
- E - Displays the full **DVD** transport controls
- F - **GOTO** search menu

Note:

A DVD disc must be inserted to access these functions and features.

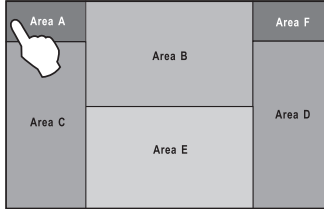

AREA A
Access MAIN Menu

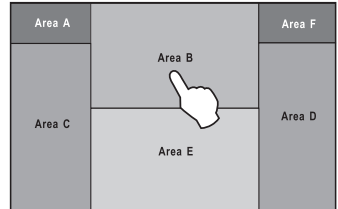

AREA B
Displays Disc Information

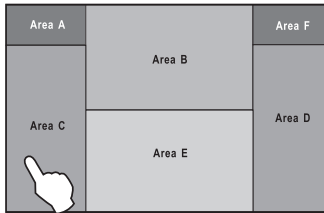

AREA C
Selects PREVIOUS Chapter

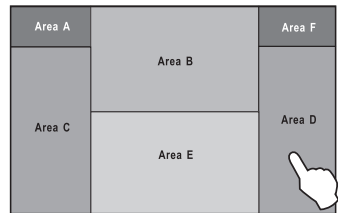

AREA D
Selects NEXT Chapter

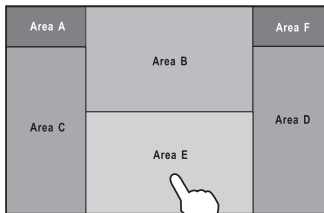

AREA E
Displays DVD Transport Controls

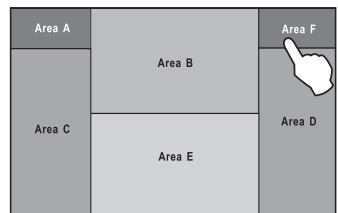

AREA F
DVD Search

DVD Operation - Touch Screen Controls







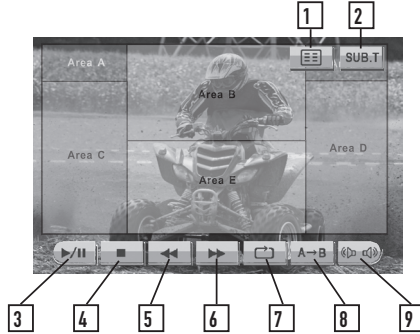

Using the hidden Touch Screen Controls

Touch AREA E



DVD Mode From the main menu, touch the DISC icon on the screen to select DVD mode.

- 1** Title Menu
Jumps to the DVD Title menu.
- 2** Sub-Title Mode
Activates sub-titles and cycles between multiple sub-title languages.
- 3** Play/Pause
Touch the  icon to temporarily stop or resume playback.
- 4** Stop
Touch the  icon to stop the chapter where it is.
- 5** Fast Reverse
Touch the  icon to fast reverse at 2x speed. Each touch changes speed from 2x to 4x to 8x to 20x then back to 1x play.
- 6** Fast Forward
Touch the  icon to fast forward at 2x speed. Each touch changes speed from 2x to 4x to 8x to 20x then back to 1x play.
- 7** Repeat
Touch the  icon to repeat the current chapter or title. This icon will remain highlighted until touched a third time to disable.
- 8** Repeat A-B
Touch the  icon once to select a start point. Touch it a second time to select and end point. The  icon will illuminate and the DVD will then loop from the start point to the end point until touched a third time.
- 9** Audio Mode
Touch this icon to activate alternate audio modes on DVD's that have alternate audio streams.



DVD Operation - Searching a DVD

Searching a DVD

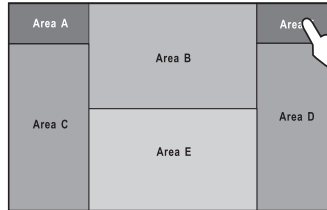

Search	---
Time	..:..:..
Title/Chapter	-- / --



Searching by Time, Title or Chapter

Touch Area F to bring up the Search Window. The Search Window allows a search for a specific time, title or chapter.

Search by TIME example

To search for a specific time, touch the --:--:-- area and an on-screen keyboard will pop up. Use the keyboard to enter a time and touch **OK**. (For example, to skip to 1 hour, 12 minutes and 19 seconds into the DVD, touch: 1 1 2 1 9 **OK**.)

To search for a specific title and/or chapter, touch the --- / --- area and an on-screen keyboard will pop up. Use the keyboard to enter a title and chapter and touch **OK**. This can be used to select a specific chapter in the current title, a new title or a specific chapter in a new title. (For example, to skip to a specific chapter within the current title, touch the --- on the right and use the keyboard to enter a chapter number, then touch **OK**.)

To skip to a different title and start from the beginning, touch the --- on the left and the keyboard to enter a title number, then touch **OK**. To skip to a specific chapter in a new title: touch the left --- and use the keyboard to enter a title number, **DO NOT** touch **OK**, then touch the right --- and use the keyboard to enter a chapter number. Then touch **OK**.)

From the remote control:

Press **SRCH** to bring up the search window, then use the arrows to highlight either the time, title or chapter field and use the numeric keypad to enter the appropriate information and press **OK**.

Notes:

Some DVD discs can be played only in certain playback modes according to the intentions of the software. As the XDVDN8190 plays discs according to their intentions, some functions may not work as intended. Please be sure to read the instructions provided with each disc.

DVD Operation



<p>Playback Control</p>	<p>Touch Area E to bring up the on-screen buttons. Touch ►► to fast forward or ◀◀ to fast reverse. Each subsequent press of the button will change the speed from normal to 2x to 4x to 8x to 20x and back to 1x.</p> <p>From the front panel: Press and hold ►► to fast forward. Press and hold ◀◀ to fast reverse.</p> <p>From the remote control: Press ►► to fast forward. Press ◀◀ to fast reverse.</p>
<p>Repeat Mode</p>	<p>Touch the ◻ icon to repeat either a chapter or title. The first touch activates Repeat Chapter mode and a second touch activates Repeat Title mode. When either mode is active, the Repeat button will be illuminated, and touching it a third time will disable Repeat Mode.</p> <p>From the remote control: Press ◻ to select Repeat Chapter, Repeat Title and Repeat Off modes.</p> <p>Note: The Repeat Mode can only be changed while the DVD is playing.</p>
<p>Repeat A->B</p>	<p>Touch the A → B icon once to select a start point. Touch it a second time to select and end point. The A → B icon will illuminate and the DVD will then loop from the start point to the end point until touched a third time.</p> <p>From the remote control: Press A → B to select a start point and stop point. Press a third time to deactivate.</p>
<p>Play/Pause</p>	<p>Touching PLAY/PAUSE will temporarily stop playback of the DVD. Touching it again will resume playback.</p> <p>Press the PLAY/PAUSE button to pause or resume the DVD.</p> <p>From the remote control: Press OK to temporarily stop and resume playback.</p>
<p>Stop</p>	<p>Touch Stop to stop playback. Pressing Play at this point will resume playback. If Stop is touched a second time, then playback stops completely and will restart from the beginning of the disc.</p> <p>From the remote control: Press ■ to stop playback of the current chapter.</p>



DVD Operation

Sub-Titles	<p>Touch the SUB.T icon to activate Sub-Title mode and select a sub-title language. Each touch will cycle the mode from off to language 1, language 2, etc., and back to off.</p>
	<p>From the remote control: Press the SUB-T button to control Sub-Title mode.</p>
	<p>Notes:</p> <ul style="list-style-type: none"> • Not all DVD's have sub-titles and when they do, some will only have 1 language. Therefore this function may be disabled or limited. • The Sub-Title Mode can only be changed while the DVD is playing.
Audio Mode	<p>Touch the  icon to change the audio stream. Each touch will cycle the language.</p>
	<p>From the remote control: Press the AUDIO button to control the Audio Mode.</p>
	<p>Notes:</p> <ul style="list-style-type: none"> • Not all DVD's have multiple languages, therefore this function may be disabled or limited. • The Audio Mode can only be changed while the DVD is playing.
DVD Disc Information	<p>Touch Area B to bring up the DVD Disc Information, which includes: Current/Total Titles and Chapters, elapsed time for current title, EQ Mode and Loudness setting, current time and Rear-Zone Indicator.</p>
	<p>Press the PIC button to bring up the DVD Disc Information.</p>
	<p>From the remote control: Press the INFO button to bring up the DVD Disc Information.</p>
Zoom Mode	<p>From the remote control: Press the ZOOM button to activate Zoom Mode. Each subsequent press of the button will change the magnification from normal to 1 to 2 to 3 to 4 and back to normal. When Zoom Mode is active, the arrows on the remote will pan the screen up, down, right and left.</p>
DVD Title Menu	<p>Touch the Title Menu icon to return to the DVD's main menu.</p> <p>From the remote control: Press TITLE to return to the DVD's main menu. Press ROOT to move up one level on the DVD's menus. (For example, when viewing bonus materials, the ROOT button will return to the bonus menu instead of the main menu.) Pressing ROOT again will usually return to the current chapter.</p>
	<p>Note: On some DVD's the TITLE and ROOT buttons may be reversed.</p>

DVD Setup Menu - Language

LANGUAGE Setup Menu

Note:
A DVD disc must be inserted to access these functions and features.

With the unit in DVD mode, press AREA A (top left screen) to display the MAIN menu. Press DVD Setup to access the DVD setup menu.



Press the **LANGUAGE** icon to select **LANGUAGE** setup page.

Disc Subtitle

Press to select desired disc subtitle language.

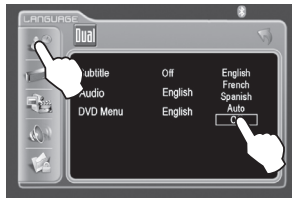

English
French
Spanish
Auto
Off = DEFAULT

Audio Language

Press to select desired disc audio language.



English = DEFAULT
French
Spanish

DVD Menu

Press to select desired disc menu language.



English = DEFAULT
French
Spanish

DVD Setup Menu - Audio

Audio Setup Menu

With the unit in DVD mode, press AREA A (top left screen) to display the MAIN menu. Press DVD Setup to access the DVD setup menu.

Note:

A DVD disc must be inserted to access these functions and features.



Press the **AUDIO** icon to select from the following menus:

Pink Noise

Press to activate pink noise generator for the desired channel. The pink noise generator is used to set the relative speaker levels for multi-channel playback.

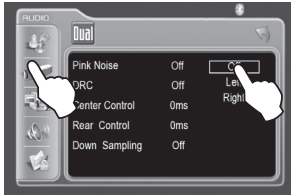

Downmix (2-channel) Settings

Off = DEFAULT

Left

Right

Full 6CH (6-channel) Settings

Off = DEFAULT

Left

Right

Left Surround

Right Surround

Dynamic Range Control

Select On to activate dynamic range control.

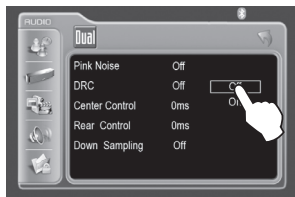

Off = DEFAULT

On

DVD Setup Menu - Audio

Center Control Press to select desired center channel time delay. The distance is defined in milliseconds.

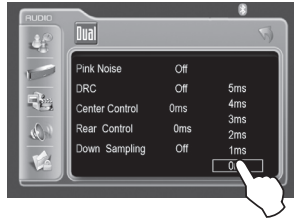

- 5ms
- 4ms
- 3ms
- 2ms
- 1ms
- 0ms = DEFAULT

Rear Control Press to select desired rear channel time delay. The distance is defined in milliseconds.

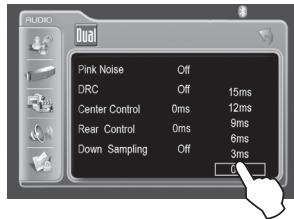

- 15ms
- 12ms
- 9ms
- 6ms
- 3ms
- 0ms = DEFAULT

Down Sampling Select On to activate audio down sampling. The DVD audio output will be downsampled to 48kHz. The original sampling frequency is preserved when Off is selected.

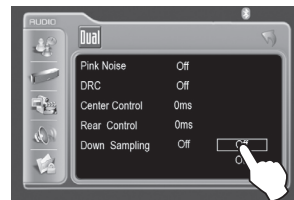

- Off = DEFAULT
- On

DVD Setup Menu - Video

Video Setup Menu

Note:

A DVD disc must be inserted to access these functions and features.

With the unit in DVD mode, press AREA A (top left screen) to display the MAIN menu. Press DVD Setup to access the DVD setup menu.



Press the VIDEO icon to select from the following menus:

TV Shape

Press to select desired TV shape.

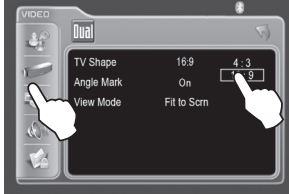

4:3
16:9 = DEFAULT



Angle Mark

Select On to activate angle mark.



On = DEFAULT
Off

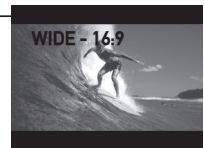

View Mode

Press to select desired view mode.

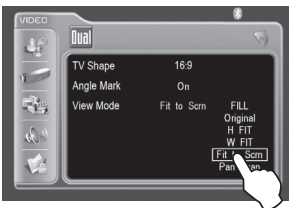

FILL
Original
H FIT
W FIT
Fit to Screen = DEFAULT
Pan Scan

DVD Setup Menu - Speaker

Speaker Setup Menu

With the unit in DVD mode, press AREA A (top left screen) to display the MAIN menu. Press DVD Setup to access the DVD setup menu.

Note:

A DVD disc must be inserted to access these functions and features.



Press **SPEAKER** icon to select from the following menus:

Speaker Mode

Select desired speaker output mode.



Full 6CH
DownMix = DEFAULT

*Front Speaker Size

Select size of front speaker.



Large = DEFAULT
Small

Note: *Full 6CH mode must be selected to adjust the front speaker size.

DVD Setup Menu - Speaker

***Surround Speaker Size** Select size of surround speaker.

Note:
A DVD disc must be inserted to access these functions and features.



Large = DEFAULT
Small
None

***Subwoofer Speaker** Select Present if a subwoofer is included in your system.



Present
None = DEFAULT

***Center Speaker Size** Press to select size of center speaker.

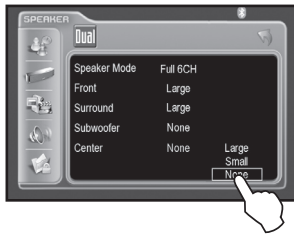

Large
Small
None = DEFAULT

Note: *Full 6CH mode must be selected to adjust the surround speaker size, subwoofer speaker and center speaker size.

DVD Setup Menu - Rating

Rating Setup Menu

With the unit in DVD mode, press AREA A (top left screen) to display the MAIN menu. Press DVD Setup to access the DVD setup menu.

Note:

A DVD disc must be inserted to access these functions and features.



Press the **RATING** icon to select from the following menus:

Enable Parental Lock Password

Press ---- to enter a password.

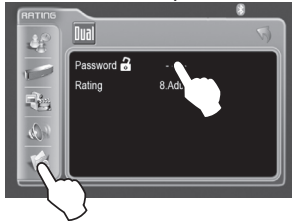

Setting Parental Lock Password

1. Enter a 4-digit code
2. Write the code down
3. Save in a safe place

Rating Setting

When unlock symbol is displayed, select desired rating.

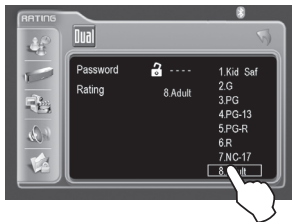

1. Kid Safe
2. G
3. PG
4. PG-13
5. PG-R
6. R
7. NC-17
8. Adult = DEFAULT

Parental Password Override

In the event you forget or loose your **PARENTAL LOCK** password, enter 9991.





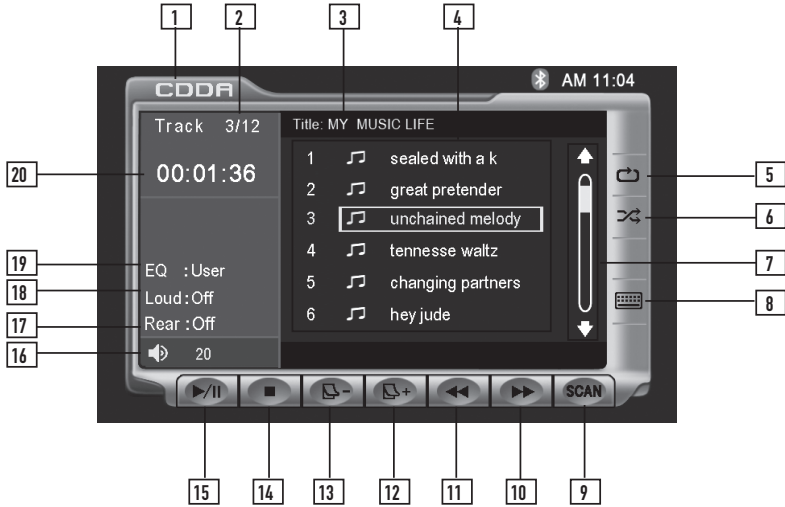



CD Operation - OSD Overview



CD Mode	
1	Current Source Indicator Displays Source Currently Playing
2	Track Number Indicator Displays current track number and total number of tracks on the disc.
3	Disc Title Indicator Displays current disc title when available.
4	Track Title List Displays up to 6 tracks on the disc in order, with track title, when available.
5	Repeat Touch the icon to repeat current track. This icon will remain highlighted until touched to disable.
6	Shuffle Touch the icon to shuffle all tracks on the disc. This icon will remain highlighted until touched to disable.

CD Operation - OSD Overview



- 7** Scroll bar
Allows scrolling of track list.
- 8** Direct Select Keyboard
Touch the  icon to display a numeric keyboard. Enter desired track number and touch **OK** to select it.
- 9** Track Scan
Touch the **SCAN** icon to listen to 10 seconds of each track in order. This icon will remain highlighted until touched to disable.
- 10** Fast Forward
Touch the  icon to fast forward at 2x speed. Each touch changes speed from 2x to 4x to 8x to 20x then to 1x play.
- 11** Fast Reverse
Touch the  icon to fast reverse at 2x speed. Each touch changes speed from 2x to 4x to 8x to 20x then to 1x play.
- 12** Page Up
Touch the  icon to see the next 6 tracks on the disc.
- 13** Page Down
Touch the  icon to see the previous 6 tracks on the disc.
- 14** Stop
Touch the  icon to stop the song where it is.
- 15** Play/Pause
Touch the  icon to temporarily stop or resume playback.
- 16** Volume Indicator
Indicates current volume level, controlled by rotary encoder.
- 17** Rear-Zone Indicator
Displays current status of **Rear-Zone** mode.
- 18** Loudness Indicator
Touch screen here to enter Audio Setup Menu.
- 19** EQ Indicator
Touch screen here to enter Audio Setup Menu.
- 20** Track Time Indicator
Shows how much time has elapsed in the current track.



CD Operation

Playing CD-DA discs

After inserting a CD disc, files will play in numerical order in the directory.



Selecting by Keypad

Touch to display keypad. Enter desired track number and press OK.



Selecting by Direct Track Access

Touch desired track for DIRECT TRACK access.



Previous/Next Page

Touch to view UP/DOWN pages of available tracks.







CD Operation



Page Up/Down	<p>The Page Up and Page Down on-screen buttons can be used to see the rest of the tracks on the CD. Use the Direct Select method to play a desired track.</p> <p>From the remote control: Press ► to display the next page. Press ◀ to display the previous page.</p>
Track Select	<p>From the front panel: Press ►► to skip to the next track. Press ◀◀ to skip to the previous track.</p> <p>From the remote control: Press ►► to skip to the next track. Press ◀◀ to skip to the previous track.</p> <p>Note: Pressing ◀◀ once will return to the beginning of the current track. Pressing it a second time will skip to the previous track.</p>
Direct Select	<p>To select a desired track from the track title list, touch any track on the list. Use the up and down arrows on screen to scroll through the tracks. Once highlighted, simply touch the screen at the appropriate track.</p> <p>Use the Rapid Dial rotary encoder to select desired track by rotating the right side rotary clockwise or counter-clockwise. Press to confirm/ENTER.</p> <p>From the remote control: Press ▲ or ▼ to scroll through the tracks. When the correct track is highlighted press OK.</p>
Direct Track Entry	<p>Touch the  icon to display a numeric keyboard. Enter desired track number, and touch OK to select it.</p> <p>From the remote control: Use the numeric keypad to enter the desired track number.</p>
Play Control	<p>You can use the Fast Forward or Fast Reverse on-screen buttons to speed up the playback of a track. Each subsequent press of the button will change the speed from normal to 2x to 4x to 8x to 20x and back to 1x.</p> <p>Press ►► to fast forward. Press ◀◀ to fast reverse.</p> <p>From the remote control: Press ►► to fast forward. Press ◀◀ to fast reverse.</p>





CD Operation

Shuffle Mode	<p>Touch the  icon to shuffle all of the tracks on the CD. The  icon will be illuminated while Shuffle Mode is active. When the  icon is illuminated, touching it a second time will disable Shuffle Mode.</p> <p>Notes: The shuffled order of the songs is fixed, therefore the Track Select operations will continue to operate properly within the shuffled order. Therefore using Next Track will move to the next shuffled track, while Previous Track will return to the start of the current track and then a second press will return to the previously played track.</p>
Repeat Mode	<p>Touch the  icon to repeat a track. When Repeat Mode is active, the  icon will be illuminated, and touching it again will disable Repeat Mode.</p> <p>From the remote control: Press  to select Repeat. Press it a second time to disable Repeat.</p> <p>Note: Shuffle and Repeat modes can not be used simultaneously and engaging one mode will cancel the other mode (if active.)</p>
Scan Mode	<p>Touch SCAN on the screen to listen to all tracks on the CD for 10 seconds at a time, starting from the first track on the CD. The Scan button will be illuminated while Scan Mode is active. When the button is illuminated, touching it a second time will disable Scan Mode.</p> <p>From the remote control: Press TITLE to activate and disable Scan Mode.</p>
Play/Pause	<p>Touching Play/Pause will temporarily stop playback of the current track. Touching it again will resume playback.</p> <p>Press PLAY/PAUSE to pause or resume the song.</p> <p>From the remote control: Press OK to temporarily stop and resume playback.</p>
Stop	<p>Touch Stop to stop playback of the current track. Pressing Play at this point will resume playback. If Stop is touched a second time, then playback stops completely and will restart from the beginning of the CD.</p> <p>From the remote control: Press  to stop playback of the current song.</p>









MP3/WMA Operation - OSD Overview



MP3/WMA Mode	From the main menu, touch the DISC icon on the screen to select MP3/WMA mode.
1	Current Source Indicator Displays source currently playing.
2	Song Number Indicator Displays current song number and total number of songs on the disc.
3	Master Song Number List Shows the number of the song relative to the entire disc.
4	Folder Displays the name of the currently selected folder.
5	Filename List Displays up to 6 songs in the current folder in order, with filename.
6	File Type Indicator Displays type of song file, either MP3 or WMA .
7	Repeat Touch  icon to repeat current song or folder. This icon will remain highlighted until touched a third time to disable.
8	Shuffle Touch  icon to shuffle all songs on the disc. This icon will remain highlighted until touched to disable.



MP3/WMA Operation - OSD Overview

- | | |
|----|---|
| 9 | <p>Scroll bar
Allows scrolling of song list.</p> |
| 10 | <p>Direct Select Keyboard
Touch the  icon to display a numeric keyboard. Enter desired song number and touch OK to select it.</p> |
| 11 | <p>Fast Forward
Touch  icon to fast forward at 2x speed. Each touch changes speed from 2x to 4x to 8x to 20x then to 1x play.</p> |
| 12 | <p>Next Folder
Touch the  icon to select the next available folder.</p> |
| 13 | <p>Previous Folder
Touch the  icon to select the previous available folder.</p> |
| 14 | <p>Page Up
Touch the  icon to see the next 6 songs in the folder.</p> |
| 15 | <p>Page Down
Touch the  icon to see the previous 6 songs in the folder.</p> |
| 16 | <p>Information
Displays available information for the current song.</p> |
| 17 | <p>Stop
Touch  icon to stop the song where it is.</p> |
| 18 | <p>Play / Pause
Touch  icon to temporarily stop or resume playback.</p> |
| 19 | <p>Volume Indicator
Indicates current volume level, controlled by rotary encoder.</p> |
| 20 | <p>Rear Zone Indicator
Displays current status of Rear-Zone mode.</p> |
| 21 | <p>Loudness Indicator
Touch screen here to enter the Audio Setup Menu.</p> |
| 22 | <p>EQ indicator
Touch screen here to enter the Audio Setup Menu.</p> |
| 23 | <p>Elapsed Time Indicator
Shows the elapsed time of the current song.</p> |

MP3/WMA Operation



Page Up/Down	<p>From the remote control: Press ► to display the next page. Press ◀ to display the previous page.</p> <p>Note: Continued operation of the Page Up and Page Down buttons will display the next and previous pages, respectively once the songs in the current page have all been displayed.</p> <p>Note that the Folder Select and Page Up/Down buttons will not select a song, but simply display more songs on the disc, and if another song is not selected within 5 seconds of the last press then the screen will return to the currently playing song/folder.</p>
Song Select	<p>From the front panel: Press ►► to skip to the next song. Press ◀◀ to skip to the previous song.</p>
Direct Select	<p>From the remote control: Press ►► to skip to the next song. Press ◀◀ to skip to the previous song.</p> <p>Note: Pressing ◀◀ once will return to the beginning of the current song. Pressing it a second time will skip to the previous song.</p> <p>To select a desired song from the filename list, touch any of the displayed filenames from the list.</p> <p>Use the up and down arrows on screen to scroll through the songs. Once highlighted, simply touch the screen at the appropriate name.</p> <p>Use the Rapid Dial rotary encoder to select desired track by rotating the right side rotary clockwise or counter-clockwise. Press to confirm/ENTER.</p>
Direct Song Entry	<p>From the remote control: Press ▲ or ▼ to scroll through the songs. When the correct song is highlighted press OK.</p> <p>Touch the  icon to display a numeric keyboard. Enter desired song number and touch OK to select it.</p> <p>From the remote control: Use the numeric keypad to enter the desired song number.</p>



MP3/WMA Operation

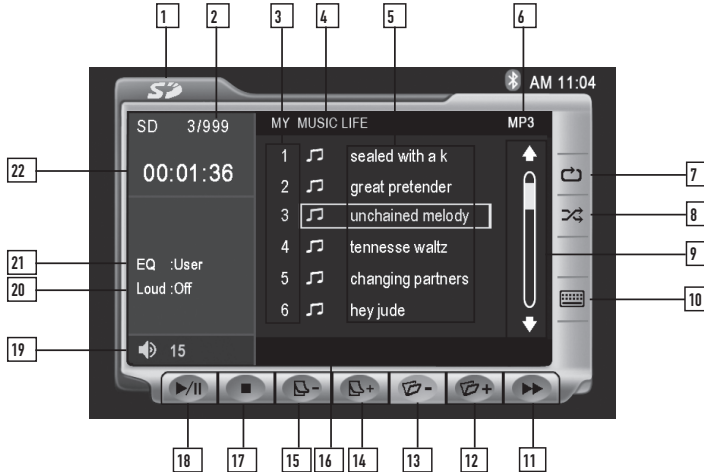

Song Control	<p>You can use the Fast Forward on-screen button to speed up the playback of a song. Each subsequent press of the button will change the speed from normal to 2x to 4x to 8x to 20x and back to 1x.</p> <p>From the front panel: Press and hold ▶▶ to fast forward. Press and hold ◀◀ to fast reverse.</p> <p>From the remote control: Press ▶▶ to fast forward. Press ◀◀ to fast reverse.</p> <p>Note: Song control only works for MP3 type files and there is no audio output while song control is active.</p>
Shuffle Mode	<p>Touch the ↻ icon to shuffle all of the songs on the disc. The ↻ icon will be illuminated while Shuffle Mode is active. When the ↻ icon is illuminated, touching it a second time will disable Shuffle Mode.</p> <p>Note: The shuffled order of the songs is fixed, therefore the Song Select operations will continue to operate properly within the shuffled order. Therefore using Next Song will move to the next shuffled song, while Previous Song will return to the start of the current song and then a second press will return to the previously played song.</p>
Repeat Mode	<p>Touch the ↺ icon to repeat either a song or folder. The first touch activates Song Repeat mode and a second touch activates Folder Repeat mode. When either mode is active, the ↺ icon will be illuminated, and touching it a third time will disable Repeat Mode.</p> <p>From the remote control: Press ↺ to select Song Repeat, Folder Repeat and Repeat Off modes.</p> <p>Note: Shuffle and Repeat modes can not be used simultaneously and engaging one mode will cancel the other mode (if active.)</p>
Play/Pause	<p>Touching Play/Pause will temporarily stop playback of the current song. Touching it again will resume playback.</p> <p>From the remote control: Press OK to temporarily stop and resume playback.</p>
Stop	<p>Touch Stop to stop playback of the current song. Pressing Play at this point will resume or restart playback from the beginning of the current song. If Stop is touched a second time, then playback stops completely and will restart from the beginning of the disc.</p> <p>From the remote control: Press ■ to stop playback of the current song.</p>

SD Card Operation











SD Mode

From the main menu, touch the SD icon on the screen.











- 1** **Current Source Indicator**
Displays source currently playing.
- 2** **Song Number Indicator**
Displays current song number and total number of songs on the SD card.
- 3** **Master Song Number List**
Shows the number of the song relative to the entire SD card.
- 4** **Folder**
Displays the name of the currently selected folder.
- 5** **Filename List**
Displays up to 6 songs in the current folder in order, with filename.
- 6** **File Type Indicator**
Displays type of song file, either **MP3** or **WMA**.
- 7** **Repeat**
Touch the  icon to repeat current song or folder. This icon will remain highlighted until touched a third time to disable.
- 8** **Shuffle**
Touch the  icon to shuffle all songs on the disc. This icon will remain highlighted until touched to disable.



- | | |
|-----------|--|
| 9 | Scroll bar
Allows scrolling of song list. |
| 10 | Direct Select Keyboard
Touch the  icon to display a numeric keyboard. Enter desired song number and touch OK to select it. |
| 11 | Fast Forward
Touch the  icon to fast forward at 2x speed. Each touch changes speed from 2x to 4x to 8x to 20x then to 1x play. |
| 12 | Next Folder
Touch the  + icon to select the next available folder. |
| 13 | Previous Folder
Touch the  - icon to select the previous available folder. |
| 14 | Page Up
Touch the  + icon to see the next 6 songs in the folder. |
| 15 | Page Down
Touch the  - icon to see the previous 6 songs in the folder. |
| 16 | Information
Displays available information for the current song. |
| 17 | Stop
Touch the  icon to stop the song where it is. |
| 18 | Play / Pause
Touch the  icon to temporarily stop or resume playback. |
| 19 | Volume Indicator
Indicates current volume level, controlled by rotary encoder. |
| 20 | Loudness Indicator
Touch screen here to enter the Audio Setup Menu. |
| 21 | EQ indicator
Touch screen here to enter the Audio Setup Menu. |
| 22 | Elapsed Time Indicator
Shows the elapsed time of the current song. |

SD Card Operation



Page Up/Down	<p>From the remote control: Press  to display the next page. Press  to display the previous page.</p> <p>Note: Continued operation of the Page Up and Page Down buttons will display the next and previous folders, respectively once the songs in the current folder have all been displayed.</p> <p>Note that the Folder Select and Page Up/Down buttons will not select a song, but simply display more songs on the disc, and if another song is not selected within 5 seconds of the last press then the screen will return to the currently playing song/folder.</p>
Song Select	<p>From the front panel: Press  to skip to the next song. Press  to skip to the previous song.</p> <p>From the remote control: Press  to skip to the next song. Press  to skip to the previous song.</p> <p>Note: Pressing  once will return to the beginning of the current song. Pressing it a second time will skip to the previous song.</p>
Direct Select	<p>To select a desired song from the filename list, touch any of the displayed filenames from the list.</p> <p>Use the up and down arrows on screen to scroll through the songs. Once highlighted, simply touch the screen at the appropriate name.</p> <p>Use the Rapid Dial rotary encoder to select desired track by rotating the right side rotary clockwise or counter-clockwise. Press to confirm/ENTER.</p> <p>From the remote control: Press  or  to scroll through the songs. When the correct song is highlighted press OK.</p>
Direct Song Entry	<p>Touch the  icon to display a numeric keyboard. Enter desired song number and touch OK to select it.</p> <p>From the remote control: Use the numeric keypad to enter the desired song number.</p>



SD Card Operation

Song Control	<p>You can use the Fast Forward on-screen button to speed up the playback of a song. Each subsequent press of the button will change the speed from normal to 2x to 4x to 8x to 20x and back to 1x.</p> <p>From the front panel: Press and hold ▶▶ to fast forward. Press and hold ◀◀ to fast reverse.</p> <p>From the remote control: Press ▶▶ to fast forward. Press ◀◀ to fast reverse.</p> <p>Note: Song control only works for MP3 type files and there is no audio output while song control is active.</p>
Shuffle Mode	<p>Touch the ↻ icon to shuffle all of the songs on the SD card. The ↻ icon will be illuminated while Shuffle Mode is active. When the ↻ is illuminated, touching it a second time will disable Shuffle Mode.</p> <p>Note: The shuffled order of the songs is fixed, therefore the Song Select operations will continue to operate properly within the shuffled order. Therefore using Next Song will move to the next shuffled song, while Previous Song will return to the start of the current song and then a second press will return to the previously played song.</p>
Repeat Mode	<p>Touch the 🔄 icon to repeat either a song or folder. The first touch activates Song Repeat mode and a second touch activates Folder Repeat mode. When either mode is active, the 🔄 icon will be illuminated, and touching it a third time will disable Repeat Mode.</p> <p>From the remote control: Press 🔄 to select Song Repeat, Folder Repeat and Repeat Off modes.</p> <p>Note: Shuffle and Repeat modes can not be used simultaneously and engaging one mode will cancel the other mode (if active.)</p>
Play/Pause	<p>Touching Play/Pause will temporarily stop playback of the current song. Touching it again will resume playback.</p> <p>From the remote control: Press OK to temporarily stop and resume playback.</p>
Stop	<p>Touch Stop to stop playback of the current song. Pressing Play at this point will resume or restart playback from the beginning of the current song. If Stop is touched a second time, then playback stops completely and will restart from the beginning of the SD card.</p> <p>From the remote control: Press ■ to stop playback of the current song.</p>

JPEG Operation - OSD Overview

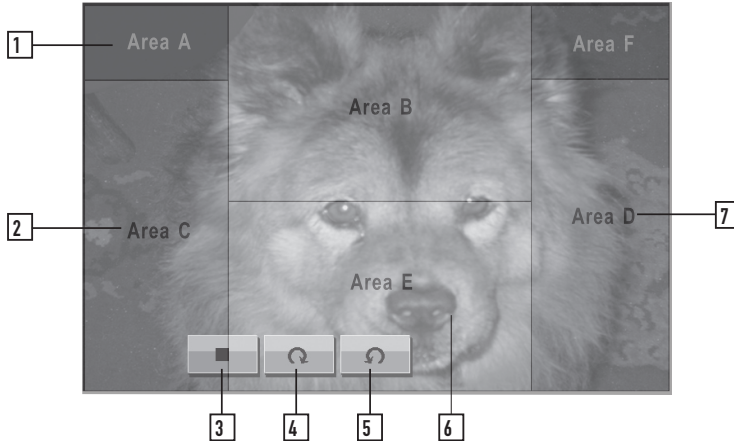

JPEG Mode

JPEG mode works a bit differently from the other modes. There is no separate JPEG mode, rather this mode is accessed within either SD mode or MP3/WMA mode. Whenever a picture is present on an SD card or CD, the unit will switch to the JPEG mode to view it. Each picture is displayed on the screen for 5 seconds, unless paused. JPEG mode will automatically exit when the next file is not a picture, or when **STOP** is pressed.

- 1** Touching this zone will bring up the Main Menu for the unit.
- 2** Touching this zone will skip to the previous file.
- 3** Stop
Touch ■ to stop viewing at the current file.
- 4** Rotate Right
Touch ↻ to rotate the image 90° clockwise.
- 5** Rotate Left
Touch ↺ to rotate the image 90° counterclockwise.
- 6** Touching this zone will bring up the on-screen buttons (3, 4 & 5).
- 7** Touching this zone will skip to the next file.



JPEG Operation

Play/Pause	Press PLAY/PAUSE to stop the viewer on a specific picture or to resume.
	From the remote control: Press OK to temporarily stop and resume the viewer.
	Note: Unlike the music player, when the viewer is paused, moving to the next or previous picture will not automatically resume the slideshow.
Next/Previous	Touch Area D to skip to the next file/image. Touch Area B to skip to the previous file/image.
	From the front panel or remote control: Press ▶▶ to skip to the next file/image. Press ◀◀ to skip to the previous file/image.
Stop	Touch ■ to stop the viewer and return to the filename list. Pressing Play at this point will resume playback from the current picture. If Stop is touched a second time, then playback stops completely and will restart from the beginning of the disc/SD card.
	From the remote control: Press ■ to stop the viewer.
Rotate Right/Left	Touch ↻ or ↺ to rotate the image 90° clockwise or counterclockwise.
	From the remote control: Press ANGLE to rotate the image 90° clockwise.
Zoom Mode	From the remote control: Press the ZOOM button to activate Zoom Mode . Each subsequent press of the button will change the magnification from normal to 4/3 to 3/2 to 2 to 3 to 1/2 to 3/4 and back to normal. When Zoom Mode is active, and the image is larger than the screen, the arrows on the remote will pan the screen up, down, right and left.
	Note: Zoom Mode is only active when the viewer is paused.
Thumbnail View	From the remote control: Press TITLE to activate Thumbnail View . The screen will display up to 9 mini-pictures at a time, starting from the current picture. Select desired picture with the arrows and press OK to view. Next and Previous will display more mini-pictures, if available.



Media Compatibility

Media Compatibility

The following types of discs/files are compatible:

- CD-ROM (ISO), CD-R, CD-RW, DVD+R/RW, DVD-R/RW
- CD-DA, DVD Video
- MP3 data
- WMA data
- JPG images

The following types of discs/files are not compatible:

- WMA files that are protected by DRM (Digital Rights Management)
- WMA lossless format
- Discs recorded with Track At Once or packet writing
- MP3 PRO format
- MP3 playlists
- WAV format
- WMV format
- DivX format
- AVI format
- MPG format
- AAC format

Some recordable DVD's and CD's may be incompatible with this unit, depending on media type and recording method.

Playback Order

MP3/WMA playback sequence is based on recorded order of files and begins in the root folder of the disc. Any empty folders or folders that do not include MP3/WMA files are skipped. This unit may not play files in the order they were recorded in. Refer to your recording software's user's manual for more information.

Compatible Recording Formats

- ISO9660 level 1
- ISO9660 level 2
- Yellow Book MODE 1
- Yellow Book MODE 2 FORM 1
- Multi session
- Maximum files - 1500
- Maximum folder levels - 8
- MPEG-1/2 Audio Layer-3

ISO9660 standards:

- Maximum nested folder depth is 8 (including the root folder).
- Valid characters for folder/file names are letters A-Z (all caps), numbers 0-9, and "_" (underscore). Some characters may not be displayed correctly, depending on the character type.
- This device can play back discs in Joliet and other standards that conform to ISO9660. MP3/WMA written in the formats other than the above may not play and/or their file names or folder names may not be displayed properly.

Media Compatibility

Additional MP3/WMA Information

An internal buffer provides ESP (Electronic Skip Protection) to virtually eliminate skipping.

When playing a disc recorded with regular audio files (CD-DA or .WAV) and MP3/WMA files, the unit will play the MP3/WMA files only.

Only MP3 files with filename extension (.mp3) can be played.
Only WMA files with filename extension (.wma) can be played.

Do not attempt to play discs which contain non-MP3/WMA files with the MP3/WMA extension.

WMA files begin playback from the beginning of the song when the unit is first turned on. MP3 files begin playback from the last position of the song when the unit is turned on.

Sampling Frequency Rates

MP3 32kHz ~ 48kHz

WMA 32kHz ~ 48kHz

Transfer Bit rates

MP3 40kbps ~ 320kbps constant
Variable bit rates

WMA 40kbps ~ 192kbps constant
Variable bit rates

Note:

Some files may not play or be displayed correctly, depending on sampling rates and bit rates.

Recommended Settings

For best results, use the following settings when burning an MP3 disc:
128kbps or higher constant bit rate
44.1kHz or higher sampling frequency

For best results, use the following settings when burning a WMA disc:
64kbps or higher constant bit rate
44kHz or higher sampling frequency

iPod Operation - OSD Overview (Optional)

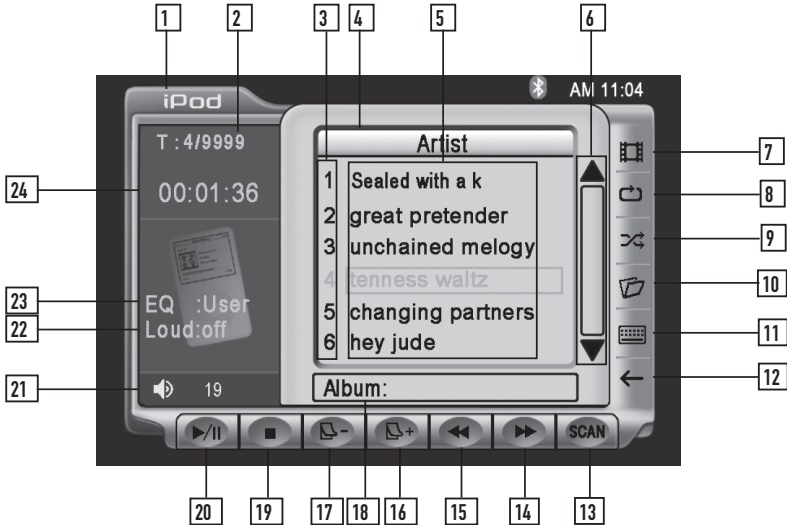









iPod Mode

From the main menu, touch the iPod icon on the screen.

- 1** Current Source Indicator
Displays source currently playing.
- 2** Song/Group Number Indicator
Displays current song number and total number of songs/groups.
- 3** Song Number List
Shows the number of the song relative to the current group.
- 4** Artist
Displays the name of the artist of the current song.
- 5** Song/group List
Displays up to 6 songs/groups in order.
- 6** Scroll bar
Allows scrolling of song or group list.
- 7** Video Mode
Allows viewing of video files.
- 8** Repeat
Touch the  icon to repeat current song.











iPod Operation - OSD Overview (Optional)

- | | |
|----|--|
| 9 | Shuffle
Touch the  icon to shuffle the songs in the current group. |
| 10 | Group Select Mode
Allows selection of songs by various groups. |
| 11 | Direct Select Keyboard
Touch the  icon to display a numeric keyboard for song selection. |
| 12 | Return/Back
Touch  to return to the previous group/menu. |
| 13 | Scan Mode
Pressing this button will scan through all songs for 10 seconds. |
| 14 | Fast Forward
Touch the  icon to fast forward at 2x speed. |
| 15 | Rewind
Touch the  icon to rewind at 2x speed. |
| 16 | Page Up
Touch the  icon to see the next 6 songs in the folder. |
| 17 | Page Down
Touch the  icon to see the previous 6 songs in the folder. |
| 18 | Album
Displays the name of the album for the current song. |
| 19 | Stop
Touch the  icon to stop the song where it is. |
| 20 | Play / Pause
Touch the  icon to temporarily stop or resume playback. |
| 21 | Volume Indicator
Indicates current volume level, controlled by rotary encoder. |
| 22 | Loudness Indicator
Touch screen here to enter the Audio Setup Menu. |
| 23 | EQ indicator
Touch screen here to enter the Audio Setup Menu. |
| 24 | Elapsed Time Indicator
Shows the elapsed time of the current song. |











iPod Operation (Optional)



Group Select Mode	<p>The songs in the iPod are organized by groups. Touching the  on the screen will put the unit into Group Select Mode:</p> <p>Once in Group Select Mode select one of the group types from the menu, then select an item in that group. (For example, select the Artist group and the display will change to a list of available artists. Then select an artist from this list to hear all songs from that artist.) Select the Song group to hear all songs on the iPod. Touch the  on-screen button to go back to a previous menu. (For example, when playing songs from a particular artist in Artist group mode, touch the Return/Back icon to return to the list of all available artists.)</p>
Return/Back	<p>As there are usually more than 6 songs in a given group, the Page Up and Page Down on-screen buttons can be used to see the rest of the songs in the current group. Then use the Direct Select method to play a song from that group.</p>
Page Up/Down	<p>The Page Up and Page Down on-screen buttons can be used to preview the next/previous pages.</p> <p>From the remote control: Press  to display the next page. Press  to display the previous page.</p> <p>Note that the Page Up/Down buttons will not select a song, but simply display more songs in the group, and if another song is not selected within 5 seconds of the last press then the screen will return to the currently playing song/group.</p> <p>From the remote control: Press  to skip to the next song. Press  to return to the beginning of the current song. A second press will skip to the previous song</p>
Song Select	<p>To select a desired song from the song list, touch any of the displayed songs in the list.</p> <p>Use the up and down arrows on screen to scroll through the songs. Once highlighted, simply touch the screen at the appropriate name.</p>
Direct Select	<p>Use the Rapid Dial rotary encoder to select desired track by rotating the right side rotary clockwise or counter-clockwise. Press to confirm/ENTER.</p> <p>From the remote control: Press  or  to scroll through the songs. When the correct song is highlighted press OK.</p>



iPod Operation (Optional)

Direct Song Entry	<p>Touch the  icon to display a numeric keyboard. Select desired song number within the current group and touch OK to select it.</p> <p>From the remote control: Use the numeric keypad to enter the desired song number.</p>
Song Control	<p>You can use the Fast Forward and Fast Reverse on-screen buttons to play a song forwards or backwards at a higher speed. Touch the same button a second time or press Play to return to normal playback.</p> <p>From the remote control: Press  to fast forward. Press  to fast reverse.</p>
Shuffle Mode	<p>Touch the  icon to shuffle the songs in the current group. The  icon will be illuminated while Shuffle Mode is active. When the  is illuminated, touching it a second time will disable Shuffle Mode.</p>
Repeat Mode	<p>Touch the  icon to repeat a song. When Repeat mode is active, the  icon will be illuminated, and touching it again will disable Repeat Mode.</p> <p>From the remote control: Press  to select Repeat. Press it a second time to disable Repeat.</p> <p>Note: Shuffle and Repeat modes can not be used simultaneously and engaging one mode will cancel the other mode (if active.)</p>
Play/Pause	<p>Touching Play/Pause will temporarily stop playback of the current song. Touching it again will resume playback.</p> <p>Press the PLAY/PAUSE button to pause or resume the song.</p> <p>From the remote control: Press OK to temporarily stop and resume playback.</p>
Stop	<p>Touch Stop to stop playback of the current song.</p> <p>From the remote control: Press  to stop playback of the current song.</p>

iPod Operation (Optional)



Playing photo or video files from iPod

Notes:

VIDEO/PHOTO FILES are only compatible with G5 iPod.

The iPod photo/video display of the in-dash unit will not operate while the vehicle is moving. This is a safety feature to prevent driver distraction. iPod photo/video functions will only operate when vehicle is in Park and the parking brake is engaged. It is illegal in most states for the driver to view video while the vehicle is in motion.



- Touch **VIDEO** icon. iPod will disconnect and wait for video signal.
- Make sure **VIDEO OUTPUT** is turned on in your iPod. Consult your iPod owner's manual for details.
- Press **PLAY** on your iPod, photos or video will appear on the TFT.



Releasing Video control from iPod

- Touch **AREA F** (upper right screen) to reconnect iPod to play music again.



iPod will reconnect



iPod Operation (Optional)

Selecting Music By:

Playlist
Artist
Album
Genre
Song



Touch desired Folder, music will begin to play after selection.

Character Support

Only alphanumeric characters can be displayed (ASCII type).

Artist Name and Album name will only be displayed if included with the song.

iPod Compatibility

The following models are supported:

- Third generation iPod - Version 2.3
- Fourth generation iPod - Version 3.1.1
- Fifth generation iPod - Version 1.1.2
- iPod Classic - Version 1.1.2
- iPod Touch - Version 1.1.4
- iPod Nano (Third Generation) - Version 1.1.2
- iPod Photo - Version 1.2.1
- iPod Mini - Version 1.4.1
- iPod Nano - Version 1.2.0

Refer to your iPod instruction manual for details on how to obtain the latest software.

Bluetooth® - OSD Overview (Optional)

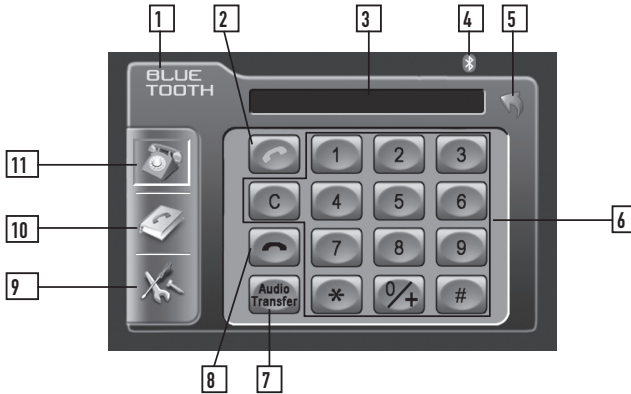

Before using the Bluetooth

Select the Bluetooth option in the General setup and select On to activate the Bluetooth feature. Refer to page 19 for more details.

Bluetooth Mode

From the main menu, touch the **Bluetooth** icon on the screen or, press the **Bluetooth** icon at the top of the screen. The Bluetooth function must be turned on for the Bluetooth icon to appear at the top of the screen.

- 1** Current Source Indicator
Displays source or current mode.
- 2** Talk button
Press to answer an incoming call or to place an outgoing call.
- 3** Display Indicator
Phone number display and call status indicator.
- 4** Bluetooth status indicator
When the Bluetooth function is Off, the indicator is black.
When the Bluetooth function is On and no phone is connected (paired) to the unit, the indicator will flash blue.
When the Bluetooth function is On and a phone is connected (paired) to the unit, the indicator is blue.
- 5** Return button
Touch to **RETURN** to previous screen.
- 6** Keypad interface
Press 0-9, *, # and + to enter desired phone number.
Press C to clear the last digit.



Bluetooth® - OSD Overview (Optional)

- 7 Audio Transfer Button
Press to transfer audio between the head unit and mobile phone.
- 8 End button
Press to end a call in progress or to reject an incoming call.
- 9 Setup Menu Icon
Press to access Bluetooth setup menu.
- 10 Phone book Icon
Press to access the phone book menu.
- 11 Keypad Interface Icon
Press to display the keypad interface.

Bluetooth Setup Menu

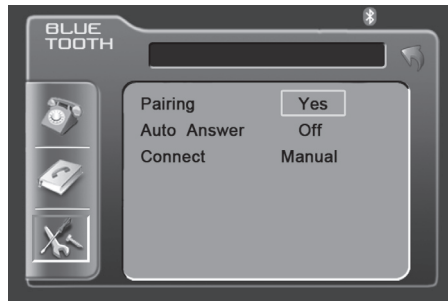

Bluetooth Setup Menu matrix

Settings	Default	Options	Function
Pairing	Yes	Yes (Pair)	Press Yes to begin the pairing function. Press Yes again to cancel the pairing process. See page 75 for more details.
Auto Answer	Off	Off	You must press the Talk button to answer an incoming call.
		On	The head unit will automatically answer incoming calls.
Connect	Manual	Manual	You must connect the phone to the head unit manually each time.
		Auto	The head unit will automatically connect to a previously paired phone. See page 75 for more details.

Notes: Some Bluetooth approved devices may not communicate or work properly with this head unit, depending on the features or specifications of the device. During hands free operation, some noise may be heard when using a mobile device with this head unit, depending on the mobile device and or the communication environment.

Bluetooth® - Setup Menu (Optional)



Pairing	<p>Before you can use a mobile device with this head unit, it must be authenticated. This is also referred to as "pairing" a device.</p> <p>Note: Please make sure that Bluetooth is activated on your mobile device before you begin the pairing process. Refer to the owner's manual of your mobile device for more details.</p>
Step 1	<p>Access Bluetooth setup menu and press Yes to begin the pairing process. The head unit will display "Wait Pairing.." and will search for any nearby Bluetooth device. If you have more than one Bluetooth device, please make sure only the device you want to connect to is powered on. Refer to the owner's manual of your mobile device for more details on searching for Bluetooth devices.</p>
Step 2	<p>When prompted by your mobile device, enter 1234 for the PIN or pass code. The device name of the head unit will show up as "MM_BT G2". After the pairing process has completed, the Bluetooth icon will turn solid blue.</p>
Notes	<p>It is possible to search for previously paired Bluetooth devices from this head unit. It may be possible to search for this head unit from other Bluetooth enabled devices.</p> <p>To search for this head unit from another device (when already connected), press Yes under the Pairing function. The currently connected device will be disconnected and pairing to the new device will be possible. It may also be possible to disconnect this head unit from another mobile device.</p> <p>This unit can remember the last 4 paired mobile devices. It is only possible to connect to one Bluetooth mobile device at a time.</p> <p>When pairing to more than 4 mobile devices, the head unit will delete the phone that was least used to allow for the new pairing (connection). The mobile device that is initially connected will always be remembered (default phone).</p> <p>The MUTE function can not be used during Bluetooth operation. If MUTE is active when a call is received, the audio will automatically be transferred to the mobile device.</p>
Auto Answer	<p>The head unit will automatically answer incoming calls when the Auto Answer feature is set to On. If the Auto Answer feature is set to Off, the Talk button must be pressed to answer an incoming call.</p>
Connect	<p>The head unit will automatically connect to a previously connected mobile device when the Connect feature is set to Auto. If the Connect feature is set to Manual, the head unit will not automatically connect to any mobile device. Set the Connect feature to Manual when you do not want to connect to any Bluetooth mobile device.</p>



Bluetooth® - Operation (Optional)

Phone Book Menu

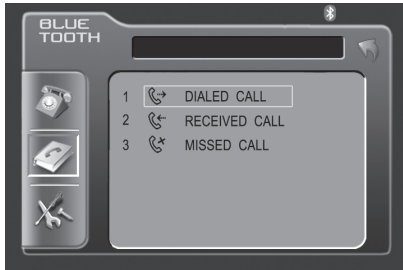

Incoming Call Screen

**Dialed Calls**

Press Dialed Call to retrieve the list of dialed calls from the mobile device. "Searching", then "Loading dialed phone book" will be displayed during the retrieval process followed by "The phone book is done". Touch the desired name to call. Press the page up/down buttons to navigate through the pages.

Received Calls

Press Received Call to retrieve the list of received calls from the mobile device. "Searching", then "Loading received phone book" will be displayed during the retrieval process followed by "The phone book is done". Touch the desired name to call. Press the page up/down buttons to navigate through the pages.

Missed Calls

Press Missed Call to retrieve the list of missed calls from the mobile device. "Searching", then "Loading missed phone book" will be displayed during the retrieval process followed by "The phone book is done". Touch the desired name to call. Press the page up/down buttons to navigate through the pages.

Making a Phone Call

It is possible to make a phone call three different ways:

1. Enter the desired phone number using the keypad interface, then press the Talk button.
2. Enter the desired phone number using the numeric keypad on the remote control, then press OK. (Bluetooth mode must be selected first.)
3. Select a previous call from the phone book menu.

Answering a Phone Call

The head unit will answer calls automatically if the Auto Answer feature is set to On. Pressing the Talk button on screen or pressing the right side rotary encoder can also be used to answer an incoming call. During an incoming call, the audio is muted for the current source and the incoming call screen will be displayed. Adjust the volume during the call using the rotary encoder volume control.

Ending a Phone Call

Press the End button on screen, the ESC button on the remote control or, the left side rotary encoder to end a call in progress or to reject an incoming call.

Navigation

Navigation Mode

From the main menu, touch the **Navi** icon on the screen. The Navigation SD card must be inserted. **Note:** When powering on the unit, there is a 10-12 second delay before the navigation mode can be selected.

Function Buttons

The following function buttons are found on many of the navigation screens:



Display menu bar



Page up in the displayed list



Display map



Page down in the displayed list



Display main menu



Select currently highlighted item

Navigating a Route

The XDVDN8190 maps a route from Point A to Point B (with stops in between if desired) in just three easy steps.

1. Select a destination (see page 78 for details).
2. Voice prompts and highlighted mapping guide you to the end point.
3. Arrive at destination.

Navigation Screen



The following options are found on the main navigation screen. After several seconds of no activity, the system will auto-hide the Menu Bar to maximize the map view. Press  at any time to display the Menu Bar.



Zoom in the map to show smaller area



Zoom out the map to show larger area



Return to the map to the current vehicle location



Change the map angle view



Display information on current map, select Point of Interest

Navigation

Navigation Main Menu

Press **MENU** to display the Main Menu:

The main menu contains six options:

- **Go to:** Pick a destination for routing
- **Edit Favorites:** Modify favorite destinations
- **Setup:** Configure system features
- **Trip Computer:** View trip statistics
- **Home Address:** Route to home address
- **Office Address:** Route to office address



Go To

The **Go To** option provides six choices for selecting a destination:

1. **Address or Intersection**
2. **Previous Destination**
3. **Point of Interest**
4. **Home Address**
5. **Office Address**
6. **Favorites**



Address or Intersection

Use this option to navigate using an exact address or cross street. After selecting the state, enter the postal code or city name. Once the postal code or the City name has been entered, enter the desired street name.

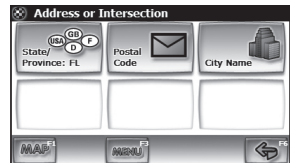

Once the city and street name are selected, start the route (**Go To**) or enter a specific street address (**House Number**) or cross street (**Intersection**).

At this time, the **Setup Routing Criteria** or **Find POI Near Destination** options can be utilized. To start immediately, select **Start Route**, and navigation will begin. Follow the voice prompts and highlighted maps to the destination. The screen will also display the time and distance to the next turn and final destination.

Previous Destination



Press the **Previous Destination** icon to scroll through and select from a list of recent destinations.

Point of Interest

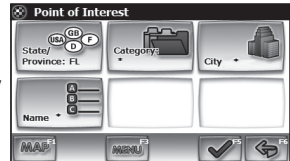
Navigating by **Point of Interest** is often helpful when traveling to a public place or looking for a type of location, such as a gas station or restaurant. After entering the state, search by **Category**, **City** or **Name**.



Navigation

Category	Press the Category icon to scroll through and select from a list of categories. After a category is selected, the unit will return to the main Point of Interest menu. Enter additional criteria, or press  to search the category. Select a sort option to display the category list in either geographical (Sort by Distance) or alphabetical (Sort by Name) order. Select the desired option, then Start Route .
City	Press the City icon to select a location in a specific city. After returning to the main Point of Interest menu, enter additional criteria or press  to display all POIs in the city. The search results are limited to a pre-defined radius from your current location. Select the desired option, then Start Route .
Name	Enter the name of the destination, and the unit will display a list of all Point of Interests containing that name. The search results are limited to a pre-defined radius from your current location. If desired, further refine the search by category or city. Select the desired option, then Start Route .
Home Address	Select this option to select a home address as the destination. To set up a home address, select Edit Favorites from the Navigation Main Menu (see page 80 for detailed instructions).
Office Address	Select this option to select an office address as the destination. To set up an office address, select Edit Favorites from the Navigation Main Menu (see page 80 for detailed instructions).
Favorites	Navigate to a specific location previously stored as a favorite. Select from entries in the Address Book , Trail Book , Trip Book , My POI or Latitude/Longitude . To set up Favorites , select Edit Favorites from the Navigation Main Menu (see page 80 for detailed instructions).
Editing a Route	To make changes to a route once navigation has begun, press  from the navigation screen. Select Edit Route , then choose one of the following options: <p>Detour The detour option allows route adjustment to Avoid Current Road, Avoid Next Road, or Avoid Specific Road. Additional parameters include Detour Distance and Setup Routing Criteria.</p> <p>Cancel Route Select this option to cancel the current route and return to the map screen.</p> <p>Find POI Near Destination Select this option to search for a Point of Interest (POI) near the destination by Category or by Name.</p>

Navigation

Edit Favorites The **Edit Favorites** option provides six choices for storing favorite destinations:

1. Address Book
2. Home Address
3. Office Address
4. Trail Book
5. Trip Book
6. My POI



Address Book Add current or previous destinations to the address book for quick access on future trips. Select **Add Previous Destination** to select from a list of recent destinations. Choose **Add Current Location** to name and save the current location. Address book entries can also be **Edited** and **Deleted** from this screen.

Home Address The unit provides several ways to store a home address for future reference.

- **Address or Intersection** - search by Postal Code, or City Name.
- **Previous Destination** - search list of previous destinations.
- **Point of Interest** - search for a Point of Interest to set as the home address.
- **Address Book** - select an address book entry to set as the home address.

Office Address The unit provides several ways to store an office address for future reference.

- **Address or Intersection** - search by Postal Code, or City Name.
- **Previous Destination** - search list of previous destinations.
- **Point of Interest** - search for a Point of Interest to set as the office address.
- **Address Book** - select an address book entry to set as the office address.

Trail Book Leave a trail from the start point to the end point and name/save the trail for future reference with the **Trail Book** option. Choose **Add**, and the unit will prompt for a trail name to be entered. Once the name is confirmed, the unit will remember the trail as it is driven. Press **[WPT]** to add a waypoint to the trail. Upon reaching the destination, press **[END]** and select **Stop Trail**. Current trails can also be edited and deleted using this option.

Trip Book This option allows trips to be created for future reference. This feature is similar to the **Trail Book** (see above) but tracks on-road rather than off-road driving.

My Point of Interest (POI) To add your own **POI**, choose **Add Category**, name your category then assign an icon to it. Next, choose **Add**, then search by **Address or Intersection**, **Previous Destination** or general **Points of Interest**. This option allows POIs to be modified, organized or you can create your own Points of Interest categories. The **Setup Display** option allows you to customize the **POI** icons that are visible on the map at various zoom levels.

Navigation

Setup

The **Setup** option allows configuration of the following options:

1. **Navigation Preferences**
2. **Display Options**
3. **User Input Settings**
4. **Location Reset**
5. **System**



Navigation Preferences

The following navigation options can be controlled from this screen: The icon indicates the option is turned on.

- **Shortest Distance/Shortest Time**
- **Avoid Freeway**
- **Avoid Tolls**
- **Use Ferries**
- **Simulation**
- **Auto Recalculation**
- **Voice Guidance**

Display Options

The following display options can be controlled from this screen: The icon indicates the option is turned on.

- **Heading Up/North Up**
- **Display Clock**
- **ETA On**
- **Display Status Bar**
- **Display GPS Icon**
- **Display Scale Icon**
- **Display Compass Icon**
- **Display Next Maneuver**
- **Enlarged Intersection**

User Input Settings

The following user input options can be controlled from this screen: The icon indicates the option is turned on.

- **Day/Night Settings** (Auto, Day, Night)
- **POI Icon Setup** (1/32 mi, 1/16 mi, 1/8 mi)
- **Distance Unit Settings** (Miles, Kilometers / meters, Miles / yards)
- **Set Time** (enter using keypad)
- **Language Settings** (select from list).

Location Reset

Reset the location of the vehicle symbol using the **Location Reset** screen. Search for a new location by:

- **Address or Intersection**
- **Point of Interest**
- **Address Book**
- **Previous Destination**

Navigation

System This screen allows diagnosis of the GPS reception status and adjustment of the current vehicle symbol position. It also provides information on the current software and map version numbers.

- **GPS Diagnostics** - displays the number of GPS satellites currently in view and in use, along with the GPS satellite time, latitude and longitude.
- **System Information** - displays the version numbers for the system software and mapping.

Trip Computer The Trip Computer shows current speed and direction, along with average speed and maximum speed. Press to view the following trip information..

- Average Speed
- Maximum Speed
- Total Trip Time
- Stopped Time
- Drive Time
- Elevation
- ETA
- Trip
- Odometer
- Digital Clock
- Current Speed

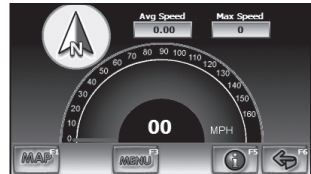

Home Address Select this option to directly access the preset home address and the following options: **Start Route, Setup Routing Criteria or Find POI Near Destination.**



Office Address Select this option to directly access the preset office address and the following options: **Start Route, Setup Routing Criteria or Find POI Near Destination.**

*Please refer to the included DVD map database disc or visit our website at www.dualav.com for the latest version of the full-length owner's manual.

Navigation - A/V Overlay Menus

A/V Overlay Menus

In navigation mode only, there are several audio/video information menus available along with a selectable source menu overlay. These menus display audio/video information at the top of navigation mode without the need to change sources. The source menu allows you to change sources quickly by using the right side rotary control.

Source Menu Overlay

To display the source menu overlay, turn the right side rotary clockwise or counter-clockwise. Anytime the right side rotary is turned, the following source menu overlay is displayed at the top of navigation mode:



Turn the right side rotary to scroll between the sources and press the rotary to select the desired source highlighted in yellow. Note - the NAVI and SD icon are not selectable. Refer to page 17 for a detailed description of the source icons.

A/V Info Bar (Tuner Mode Example)

To display the A/V info bar for tuner mode (for example, if tuner mode is playing and the map is currently being displayed), turn the left side rotary clockwise or counter-clockwise. Anytime the left side rotary is turned, the following information is displayed at the top of the navigation mode:



Turn the left side rotary to display the current station preset number on the left (if preset), the current station frequency in the center and the current volume level on the right. The A/V info bar displays various information depending on the mode. The A/V info bar is available for Tuner, DVD/CD, iPod, Bluetooth and Auxiliary modes.

Bluetooth Info Bar

During an incoming call, the Bluetooth info bar will be displayed (if a Bluetooth device is paired and connected). The Bluetooth info bar includes caller ID information (when available), the total time of the call in progress, an audio transfer icon, talk icon and end call icon. Refer to pages 73-74 for a detailed description of these functions.

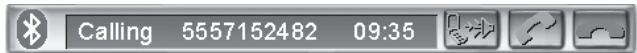

Navi Info (Next Turn Display)

To provide the best navigation experience and eliminate the need to change to navi mode, the next turn indicator and the distance to next turn information is displayed at the top of Tuner, CD and iPod modes.

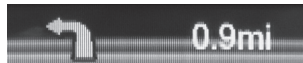

General Operation - Rear-Zone Audio Menu

Rear-Zone Audio Menu Access

To access the Rear-Zone audio menu, touch the upper left corner of the touch screen, then press Rear.

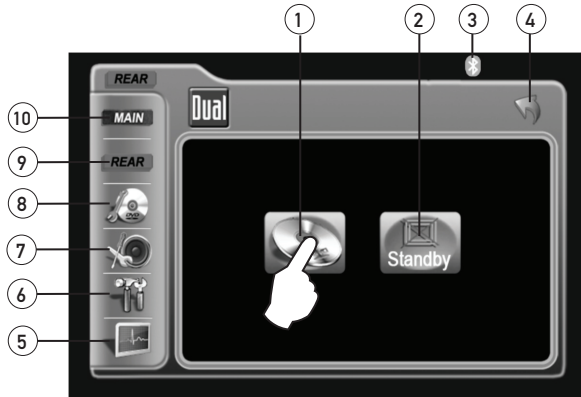

Touch Access Buttons

- ① Touch to enable Rear-Zone audio in **CD/DVD** mode (**CD/DVD** must be inserted). Rear-Zone audio is only available in **CD/DVD** mode.
- ② Touch to set Rear-Zone audio to **STANDBY** (Off).
- ③ Touch to access **BLUETOOTH** mode. (**BLUETOOTH** must be activated first). Refer to page 19 for more details.
- ④ Touch to **RETURN** to previous screen.
- ⑤ Touch to access **SCREEN SETUP** menu.
- ⑥ Touch to access **GENERAL SETUP** menu.
- ⑦ Touch to access **ASP Config** menu.
- ⑧ Touch to access **CD/DVD SETUP** menu. (**CD/DVD** must be inserted to function).
- ⑨ Touch to access **REAR-ZONE** audio menu.
- ⑩ Touch to access **MAIN** source menu.

Notes:

- Rear-Zone on/off is only for the audio signal connected to the REAR ZONE RCA audio outputs. Refer to page 6 for connection details.
- The REAR ZONE video signal is always active and is the same signal as the in-dash monitor (except for Navigation mode).
- Navigation can only be displayed on the in-dash monitor.
- It is not possible to hear rear-zone audio when the unit is set to 6-channel mode.



Limited One Year Warranty

This warranty gives you specific legal rights. You may also have other rights which vary from state to state.

Dual Electronics Corp. warrants this product to the original purchaser to be free from defects in material and workmanship for a period of one year from the date of the original purchase.

Dual Electronics Corp. agrees, at our option, during the warranty period, to repair any defect in material or workmanship or to furnish an equal new, renewed or comparable product (whichever is deemed necessary) in exchange without charges, subject to verification of the defect or malfunction and proof of the date of purchase. Subsequent replacement products are warranted for the balance of the original warranty period.

Who is covered? This warranty is extended to the original retail purchaser for products purchased and used in the U.S.A.

What is covered? This warranty covers all defects in material and workmanship in this product. The following are not covered: installation/removal costs, damage resulting from accident, misuse, abuse, neglect, product modification, improper installation, incorrect line voltage, unauthorized repair or failure to follow instructions supplied with the product, or damage occurring during return shipment of the product.

What to do?

1. Before you call for service, check the troubleshooting guide in your owner's manual. A slight adjustment of any custom controls may save you a service call.
2. If you require service during the warranty period, you must carefully pack the product (preferably in the original package) and ship it by prepaid transportation with a copy of the original receipt from the retailer to an authorized service center.
3. Please describe your problem in writing and include your name, a return UPS shipping address (P.O. Box not acceptable), and a daytime phone number with your shipment.
4. For more information and for the location of the nearest authorized service center please contact us by one of the following methods:
 - Call us toll-free at 1-866-382-5476
 - E-mail us at cs@dualav.com

Exclusion of Certain Damages: This warranty is exclusive and in lieu of any and all other warranties, expressed or implied, including without limitation the implied warranties of merchantability and fitness for a particular purpose and any obligation, liability, right, claim or remedy in contract or tort, whether or not arising from the company's negligence, actual or imputed. No person or representative is authorized to assume for the company any other liability in connection with the sale of this product. In no event shall the company be liable for indirect, incidental or consequential damages.

Specifications

DVD Player	Frequency response: 10Hz-20kHz Channel separation @ 1kHz: >65dB D/A converter: 24 Bit
FM Tuner	Tuning range: 87.5MHz-107.9MHz Usable sensitivity: 8.5dBf 50dB quieting sensitivity: 10dBf Stereo separation @ 1kHz: 40dB Frequency response: 30Hz-13kHz
AM Tuner	Tuning range: 530kHz-1710kHz Usable sensitivity: 22uV Frequency response: 30Hz-2.2kHz
SD Card	Max card size: 2GB SDHC compliant: No
Monitor	Panel size: 7" (177.8 mm) diagonal measurement View angle (up/down/left/right): 30/60/60/60 Resolution: 480 W x 234 H Brightness (cd/m ²): 350 Contrast ratio: 350:1 Elements: 336,960
General	Operating voltage: 11-16 VDC, negative ground Speaker output impedance: 4~8 ohms Line output voltage: 2 Volts Line output impedance: 200 ohms Chassis dimensions: 7" x 7" x 2" (178 x 178 x 51 mm)

Design and specifications subject to change without notice.



CEA-2006 Power Standard Specifications
(reference: 14.4VDC +/- 0.2V, 20Hz~20kHz)

Power Output: 17 Watts RMS x 4 channels at 4 ohms and $\leq 1\%$ THD+N
Signal to Noise Ratio: 80dBa (reference: 1 watt into 4 ohms)

Troubleshooting

General		
Problem	Cause	Action
Unit will not turn on (no power)	Yellow wire not connected or incorrect voltage Red wire not connected or incorrect voltage	Check connections for proper voltage (11~16VDC)
	Black wire not connected	Check connection to ground
	Fuse blown	Replace fuse
Unit has power (but no sound)	Speaker wires not connected	Check connections at speakers
	One or more speaker wires touching each other or touching chassis ground	Insulate all bare speaker wires from each other and chassis ground
Unit blows fuse	Yellow or red wire touching chassis ground	Check for pinched wire
	Speaker wires touching chassis ground	Check for pinched wire
	Incorrect fuse rating	Use fuse with correct rating
Unit has audio (but no video)	Parking brake safety circuit not connected	Check connections at parking brake
	Parking brake not applied	Apply parking brake as described on page 34
No video display (when in reverse)	Reverse circuit not connected	Check connections at reverse lamp
	Vehicle is not in reverse	Select reverse gear
DVD does not start playback	Physical defect in media	Check media for scratches
	Wrong region	Use discs labeled "Region 1" or "All" only.
IR remote does not work	Dead battery	Replace battery
Excessive skipping	Unit is not mounted correctly	Check mounting sleeve
	Physical defect in media	Check media for scratches
Bad Disc appears on display	Focus error or disc is in upside down	Press eject or RESET
Incorrect Region Code appears on display	Region code error	Use only DVD's labeled "Region 1" or "All" only.
Front panel will not open/close	Front panel obstructed	Remove the obstacle and press OPEN to resume the monitor open/close sequence.

Troubleshooting

Bluetooth		
Problem	Cause	Action
Please connect first appears in the display	There is no mobile device connected to the head unit	Pair and or connect a mobile device to the head unit as described on page 75
Mobile device will not connect to the head unit	Bluetooth function is not active on the head unit	Activate Bluetooth function as described on page 19
	Bluetooth function is not active on the mobile device	Refer to the owner's manual of your mobile device
	A mobile device is already connected to the head unit This head unit can only be connected to one device at a time	Disconnect current mobile device first, then connect desired mobile device
ERROR! Connect Timeout appears in the display	The time limit for the pairing mobile device has been reached	Pair the mobile device within 120 seconds
Pairing Fail appears in the display	The attempted pairing process has failed	Retry the pairing process again
Mobile device will not connect to the head unit automatically	The Connect function is set to Manual. When the Connect function is set to Manual, the head unit will not connect to any mobile device automatically	Set Connect function to Auto as described on page 74
Ring tone can not be heard through the speakers	Ring tone volume is turned down	Increase the volume of the ring tone using the rotary encoder during the ringing process
	MUTE function is activated on the head unit	Press MUTE to cancel the mute function and resume audio
Echo or noise is heard during a phone call	Possible road noise or interior interference	Close all open windows and turn off any fans or A/C
	Microphone opening on the front panel is obstructed	Clear any obstacles in front of microphone opening
Call is connected (but no audio can be heard through the speakers)	Audio is routed to the mobile device	Press Audio Transfer to allow audio from the phone to be heard through the speakers
	Bluetooth audio is heard through the front channel speaker outputs or the front preamp outputs only	Adjust fader forward so there is audio to the front speakers. If amplifiers are used only, be sure to use front preamp outputs
	Bluetooth mode includes memory volume. If Bluetooth volume is set to 0 when a call comes in, no audio will be heard	Adjust Bluetooth volume level above 0
Call is answered automatically	Auto Answer function is set to On	Set Auto Answer function to Off as described on page 74
Caller ID does not appear during incoming call	The calling mobile device is not set to send the Caller ID or, the service is not available	Some devices may not communicate or work properly with this head unit
XDVDN8190 does not ring when receiving a call	Cell phone ringer is set to off	Set cell phone ringer to "on"



Troubleshooting

Navigation		
Problem	Cause	Action
Unit displays "CAN'T FIND NAVIGATION SYSTEM"	There is no navigation software SD card inserted in the SD card slot	Insert the proper navigation SD card into the SD card slot
No GPS signal (red icon)	The GPS antenna is not connected	Check GPS antenna connection
	The GPS antenna cable is damaged	Check for pinched or cut antenna cable
	The GPS signal is blocked (such as inside a tunnel or garage)	Make sure the antenna has an unobstructed view of the horizon



Notes

Dual Electronics Corp.
Toll Free: 1-866-382-5476

www.dualav.com

©2008 Dual Electronics Corp. All rights reserved.

NSA0708-V01

Printed in China

Free Manuals Download Website

<http://myh66.com>

<http://usermanuals.us>

<http://www.somanuals.com>

<http://www.4manuals.cc>

<http://www.manual-lib.com>

<http://www.404manual.com>

<http://www.luxmanual.com>

<http://aubethermostatmanual.com>

Golf course search by state

<http://golfingnear.com>

Email search by domain

<http://emailbydomain.com>

Auto manuals search

<http://auto.somanuals.com>

TV manuals search

<http://tv.somanuals.com>