

ASSEMBLY GUIDE

436 INCH² 2-BURNER

⚠ DANGER

If you smell gas:

1. Shut off gas to the appliance.
2. Extinguish any open flames.
3. Open lid.
4. If odor continues, keep away from the appliance and immediately call your gas supplier or your fire department.

Leaking gas may cause a fire or explosion which can cause serious bodily injury or death, or damage to property.

⚠ WARNING

1. Do not store or use gasoline or other flammable vapors and liquids in the vicinity of this or any other appliance.
2. An LP cylinder not connected for use shall not be stored in the vicinity of this or any other appliance.

⚠ WARNING

Follow all leak-check procedures carefully in this manual prior to barbecue operation. Do this even if the barbecue was dealer-assembled.

NOTICE TO INSTALLER

These instructions must be left with the owner and the owner should keep them for future use.

THIS GAS APPLIANCE IS DESIGNED FOR OUTDOOR USE ONLY.

⚠ WARNING

Do not try to light this appliance without reading the "Lighting" Instructions section of this manual.

Customer Service: 1-800-382-2637

NOTE: Standard LP, Natural Gas and System LP are designed for use with a Ducane® portable cart.

SAVE THESE INSTRUCTIONS FOR FUTURE REFERENCE

DUCCANE®



Important

This grill head is designed to be mounted only on a Ducane® base cabinet kit. DO NOT attempt to mount on any other type of base cabinet or in any other manner.

Read all instructions before proceeding with any assembly. For an assembly view and verification of parts, see the parts list and expanded view of pages 9-10.

Assembly

NOTE: Your model may differ from those in the assembly photos.

⚠ CAUTION: Although we make every effort to ensure that the assembly process is as easy and as safe as possible, it is inherent with fabricated steel parts that corners and edges can cause cuts if improperly handled during assembly procedures. Be careful while handling any parts during assembly. **IT IS STRONGLY RECOMMENDED THAT HANDS BE PROTECTED WITH A PAIR OF WORK GLOVES.**

⚠ WARNING: Care must be taken to ensure that this grill is assembled according to these instructions. Failure to assemble the grill properly could create a fire hazard or cause burns or other bodily harm.

1. Assemble selected base cabinet kit before proceeding with these instructions.
2. Open the hood and remove the bubble wrapped side shelf package(s), Sear Grid® package, and accessory package.



2.

3. Remove the cooking rack by pushing each leg from the burner box and sliding out of the hood.



3.

-
4. With the hood open, remove the hairpin clips from the hinge clevis pins (a). Close the hood and slide clevis pins from hood hinges (b). Lift the hood from the burner box and place it on a nonabrasive surface.

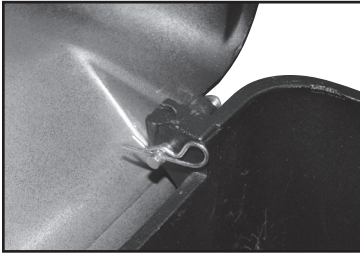
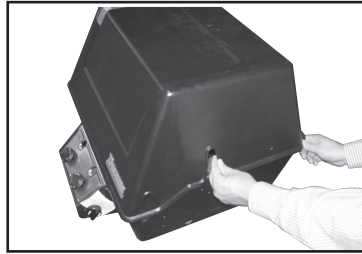
**4. (a)****4. (b)**

5. Using the hex head screws and split lockwashers from the hardware bag, attach the two hood knobs to the outside of the grill hood in the locations shown. Tighten screws from inside rather than turning the knob, to avoid scratching paint.

**5.**

6. Remove the La-Va-Grate® from the burner box and position the box on the previously assembled base cabinet kit.

**6.**

-
7. Attach the burner box to the base cabinet using the four (4) 1/4x20x1" pointed screws and the four (4) 1/4" teflon washers from the base cabinet kit (a). The screws with the washers directly underneath go through the four holes in the bottom of the burner box and engage in the caged nuts in the top of the base cabinet (b). Engage all four screws before tightening any of the four (c). In order to get the screws in the mounting holes of some grill models, it may be necessary to carefully rotate the burners out of the way of the holes. Unscrew the burner locking screw to release the burner.

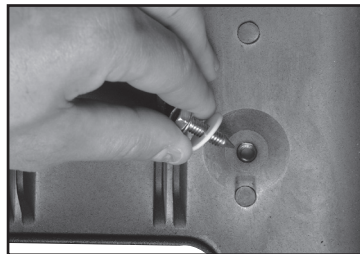

7. (a)

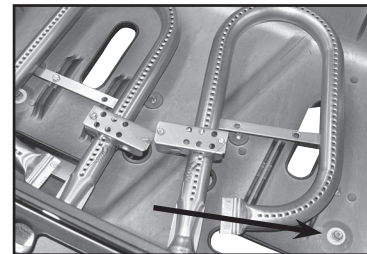

7. (b)

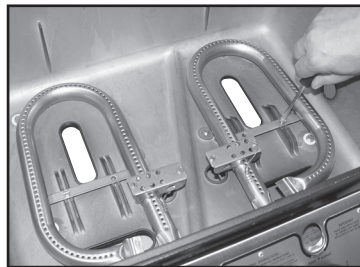

7. (c)

⚠ CAUTION: The screws used to attach the grill burner box to the base cabinet must be tightened securely but not overly tight. The Teflon washers used with these screws are very slippery and could lead to over-tightening these screws. Care should be taken to avoid compressing the washer or cracking the burner box.

⚠ CAUTION: BE CAREFUL NOT TO PULL THE BURNERS OFF THE ORIFICES OR TO DISCONNECT THE IGNITION WIRES.

-
8. Before retightening the burner locking screw (a, b, c), be sure the burners are correctly engaged over their respective orifices. This can be done by removing the control box or by viewing the burner/orifice engagement from beneath the control box (d).

Burner Locking Screws

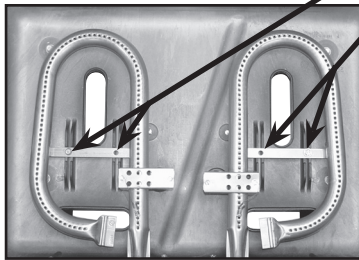

8. (a)

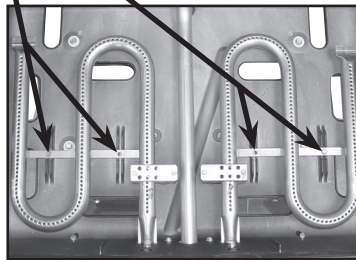

8. (b)

Burner Locking Screws

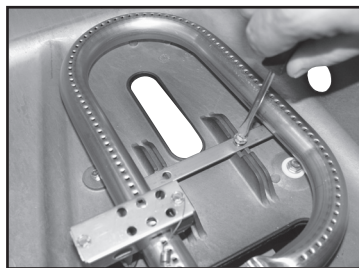

8. (c)

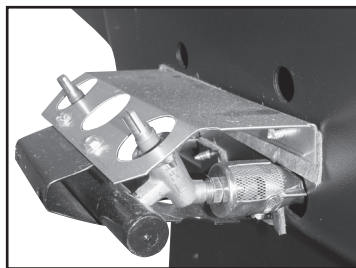

8. (d)

**⚠ WARNING: FAILURE TO CHECK PROPER BURNER ORIFICE ENGAGEMENTS
COULD LEAD TO A HAZARDOUS CONDITION AND BODILY HARM.**

Important

WHEN CONNECTING OR REPLACING ANY GAS PIPE FITTINGS, ALL JOINTS MUST BE SEALED WITH A JOINT COMPOUND (PIPE DOPE) THAT IS RESISTANT TO THE ACTION OF (LP) GASES.

9. FOR NATURAL AND SYSTEM LP GRILLS. Install the Natural Gas (or System LP) regulator/hose assembly on to the grills manifold supply pipe. To make the connection, pull back the outer sleeve of the socket connector, (at the end of the regulator/hose assembly), and insert all the way the male plug connection, (on the grills manifold), and then release the outer sleeve of the socket connector. This will produce a gas joint. After making gas connections, check all joints for leaks using soapy water and a brush. See Owner's Guide for more on Natural Gas (or System LP) installation.

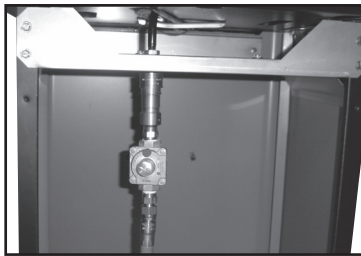

9.

⚠ WARNING: NEVER USE AN OPEN FLAME TO TEST FOR GAS LEAKS.

10. Assemble the side shelf frame using four (4) #8 x 1 1/2 Phillip's flat head screws (a-c). Depending whether your model has one or two side shelves, attach the side shelf to either or both sides of the burner box, using four (4) 1/4 x 1 1/4" black screws, 1/4-20 nuts, and stainless steel shelf support washers (oval, with two holes). The washers should go on the inside of the burner box with the raised rib side facing away from the surface of the burner box (d). The nuts go on the inside of the burner box. Tighten all four nuts securely (e).



10. (a)



10. (b)



10. (c)

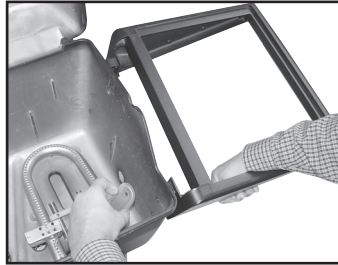

10. (d)

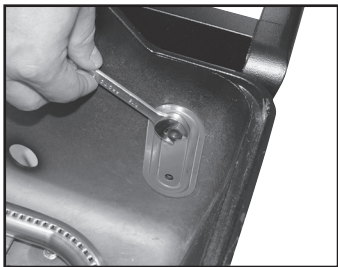

10. (e)

**⚠ WARNING: FAILURE TO INSTALL THE SIDE SHELF FRAME PROPERLY
COULD CAUSE THE SHELF TO LOOSEN AND FALL, CAUSING BODILY HARM.**

11. Reinstall the La-Va-Grate[®] into the burner box by first placing the front edge of the La-Va-Grate[®] on the lower set of supports on the front of the burner box. Holding the flange (with the “arrow” shaped cut-out) on the rear of the La-Va-Grate[®], rotate the rear edge down so that it rests on the lower set of supports on the back of the burner box. (The “arrow” on the rear flange should be pointing up.)

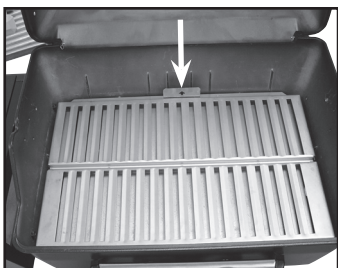

11

-
12. Carefully put the hood back on the burner box and refasten with the clevis pins and hairpin clips.
 13. Place the briquettes in a pattern as shown, filling the entire La-Va-Grate®. Spacing should be 3/8" - 1/2" between briquettes.

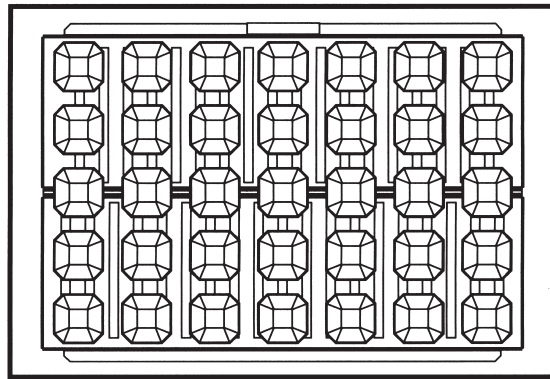

13. 436 Inch² 2-Burner

14. Replace cooking rack into hood first and then into one side of burner box. Squeeze remaining leg to lock into burner box.
15. Carefully place Sear Grid®(s) onto the upper set of supports on the front and rear of the burner box.
16. The regulator assembly shipped with the grill head must be used.
17. Refer to the Owner's Manual for the proper LP tank handling procedures.
18. Refer to the Owner's Manual for the proper use and care of your gas grill.
19. For natural and for system LP grills, refer to Owner's Manual for proper procedures for connecting to the gas supply.

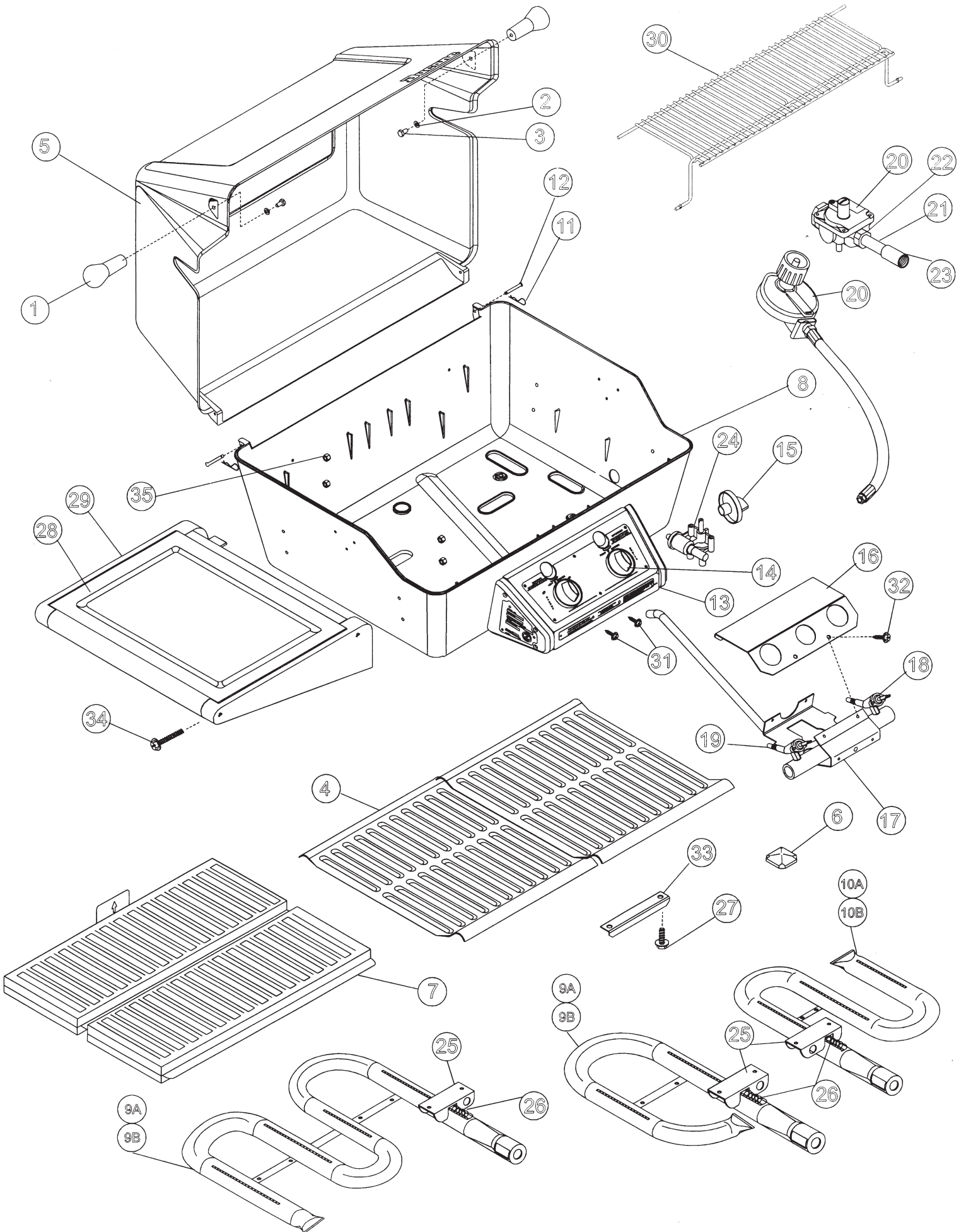

Gas Grill Parts List 436 Inch² 2-Burner

		Model Grill	
		436 INCH ² 2-BURNER	
Key	Part Description	Part Number	Qty
1.	Hood Knob	G1125350	2
2.	Lockwasher	B1008919	2
3.	1/4-20 x 1/2 Hex Head Screw	T1009088	2
4.	Sear Grid® Set (2 Pieces)	20172301	1
5.	Hood with Nameplate	20174201	1
6.	Briquette Replacement Box	20172206	1
7.	La-Va-Grate®	20172501	1
8.	Burner Box Sub Assembly	20174302	1
9A.	Burner, RH "P" Style (436 Inch ² 2-Burner) Includes 26 & 27	20177203	1
9B.	Burner, LH "P" Style (436 Inch ² 2-Burner) Includes 26 & 27	20177204	1
11.	Hair Pin Clip	G1026609	2
12.	Clevis Pin	20175601	2
13.	Control Box	20174701	1
14.	Control Knob	20173203	2
15.	Igniter Knob	20182601	1
16.	Manifold Support Upper with Gasket	20174901	1
17.	Manifold Assembly, with Gasket (LP)	20175101	1
17.	Manifold Assembly, with Gasket (Natural)	20175801	1
18.	Gas Valve (LP)	20175401	2
18.	Gas Valve (Natural)	20175402	2
19.	Gas Orifice (LP)	G1026743	2
19.	Gas Orifice (Natural)	G1031102	2
20.	Gas regulator (LP) w/Hose	20104302	1
20.	Gas regulator (Natural)	G1827628	1
20.	Gas regulator (System LP)	G1827584	1
21.	1/8" NPT x 1-1/2 pipe nipple (Nat. & Syst. LP)	G1031380	1
22.	1/8" x 3/8" npt bushing (Natural & System LP)	G1026789	1
23.	1/8" npt coupling (Natural & System LP)	G1031166	1
24.	Rotary Igniter	20182401	1
25.	Electrode and Collector Box assembly	G4313758	2
A.	Main Burner Electrode	G1129990	2
B.	#8 x 3/8 Hex Washer Head Screw (SS)	20524601	6
C.	Collector box	G4163670	2
D.	Collector box strap	G4163698	2
26.	Glow Wire	G4313301	2
27.	5/16-18 Self Tapping Screw	G1031406	2
28.	Side Shelf	20171601	1
29.	Side Shelf frame	20171701	1
30.	Cooking Shelf	20182901	1
31.	#10 x 1/2 Hex Washer Head Screw (SS)	G1026305	2
32.	#10 x 5/8 Hex Washer Head Screw (SS)	B1008062	6
33.	Angle, Supply Line Support	20176501	1
34.	1/4-20 x 1-1/4 Screw, Black	B1015956	4
35.	1/4-20 Hex Nut	B1015965	4
36.	Burner Locking Screw #10 x 1/2 Hex Head (SS) (Not Shown)	20525201	2
37.	Shelf Assembly Screw #8 x 1-1/2 (Not Shown)	20103903	4

© 2004 Ducane Products Co., 1656 Fuldner Road, Barnwell, South Carolina 29812. DUCANE is a registered trademark of Weber-Stephen Products Co. Used with permission. This product may be covered under various patents throughout the world.

20211710 01/18/05

Free Manuals Download Website

<http://myh66.com>

<http://usermanuals.us>

<http://www.somanuals.com>

<http://www.4manuals.cc>

<http://www.manual-lib.com>

<http://www.404manual.com>

<http://www.luxmanual.com>

<http://aubethermostatmanual.com>

Golf course search by state

<http://golfingnear.com>

Email search by domain

<http://emailbydomain.com>

Auto manuals search

<http://auto.somanuals.com>

TV manuals search

<http://tv.somanuals.com>