

DUKANE

Intelligent Assembly Solutions

iQ Series

ULTRASONIC POWER SUPPLY **AL**

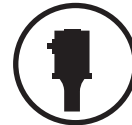

AUTOMATED



HAND PROBE



PRESS

User's Manual



Dukane Part No. 403-583-00

Dukane Intelligent Assembly Solutions • 2900 Dukane Drive • St. Charles, Illinois 60174 USA • TEL (630) 797-4900 • FAX (630) 797-4949

ISO 9001:2008

Products are manufactured in ISO registered facilities.



www.dukane.com/us

Download from Www.Somanuals.com. All Manuals Search And Download.

Copyright © 2010

Notice of Rights:

All rights reserved. No part of this manual including the interior design, cover design and icons may be reproduced, transmitted or utilized in any form or by any means, electronic, mechanical, photocopying, recording, or by any information storage and retrieval system, without written permission from the manufacturer.

Notice of Liability:

The information contained in this manual is distributed on an "As is" basis, without warranty. While every precaution has been taken in the preparation of this manual, the manufacturer shall not have any liability to any person or entity with respect to any liability, loss, or damage caused or alleged to be caused directly or indirectly by the instructions contained in this manual, or by the hardware products described herein.

Specifications are subject to change without notice.

This user's manual documents product features, hardware, and controls software available at the time this user's manual was published.

Printed in the United States of America.

Part Number: 403-583-00

This ultrasonic equipment is manufactured under one or more of the following U.S. Patents:

3,780,926 3,825,481 4,131,505 4,277,710 5,798,599 5,880,580 6,984,921 7,225,965
7,475,801 and 7,819,158 B2

Revision History

Revision Number	Revision Summary	Date
- 00	Original release.	11/02/2010

This page intentionally left blank

Section 1- Introduction	1
Section 2- Health and Safety	5
Section 3- Installation	11
Before Installation	13
Unpacking	15
Placement	15
RFI Grounding	15
Connecting Cables	16
System I/O Connector Pinout	18
Section 4 - Controls	21
Front Panel Overview	23
Start-up Sequence	25
LCD Display Overview	26
Section 5 - Process Control Settings	27
Selecting the Weld Mode	29
Navigating the Modes	30
Hold	32
Amplitude Adjustment	32
System Information, Advanced Settings	33
Setup Maintenance	35
Section 6 - Probes and Probe Stacks	37
Section 7 - Troubleshooting	49
Section 8 - Specifications	55
Section 9 - Contacting Dukane	61
Appendices	65
Appendix A - E-Stop Circuitry Examples	67
Appendix B - List of Figures	68
Appendix C - List of Tables	69

This page intentionally left blank

SECTION 1

Introduction

General User Information	3
Read the Manual First	3
Notes, Cautions and Warnings.	3
Drawings and Tables	3
System Overview	4
Key Features	4

This page intentionally left blank

General User Information

Read the Manual First

Before operating your ultrasonic system, read this User's Manual to become familiar with the equipment. This will ensure correct and safe operation. The manual is organized to allow you to learn how to safely operate this generator. The examples given are chosen for their simplicity to illustrate basic operation concepts.

Notes, Cautions and Warnings

Throughout this manual we use NOTES to provide information that is important for the successful application and understanding of the product. A NOTE block is shown to the right.

In addition, we use special notices to make you aware of safety considerations. These are the CAUTION and WARNING blocks as shown here. They have important information that, if ignored, could have increasingly severe outcomes. These statements help you to identify and avoid hazards and recognize the consequences. One of three different symbols also accompany the CAUTION and WARNING blocks to indicate whether the notice pertains to a condition or practice, an electrical safety issue or an operator protection issue.

Drawings and Tables

The figures and tables are identified by the section number followed by a sequence number. The sequence number begins with one in each section. The figures and tables are numbered separately. The figures use Arabic sequence numbers (e.g. -1, -2, -3) while the tables use Roman sequence numerals (e.g. -I, -II, -III). As an example, Figure 3-2 would be the second illustration in Section three while Table 3-II would be the second table in Section three.

NOTE

Note statements provide additional information or highlight procedures.

CAUTION

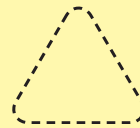

Caution statements identify conditions or practices that could result in damage to the equipment or other property.

WARNING



Warning statements point out conditions or practices that could result in personal injury or loss of life.



Condition
or Practice



Electrical
Hazard



Hearing
Protection

System Overview

Your *iQ Series Ultrasonic Power Supply AL*, an ultrasonic generator, provides a versatile stand-alone workstation.

This product's rugged internal circuitry ensures a continuous resonant frequency lock at the start of each weld.

Standard to this line of generators are time and energy control. The brightly lit display is easy to read. The menu structure makes programming simple, and the one-touch hot keys give the operator even more flexibility.

The generator also includes an RFI line filter that passes strict CE test specifications for global applications.

Key Features

- **Trigger by Power** is a Dukane patented feature that produces greater weld consistency by requiring that a sufficient amount of pressure/force is applied to the part before the actual weld begins. Trigger by Power is a cost effective alternative to trigger by force because it does not require additional, expensive components such as a load cell, amplifier board or cabling.
- **Compact Generator** is small and easily moved, and this allows your table or work bench to accommodate more of the items needed for your process.
- **Pulse Width Modulation** incorporates patented circuitry giving the power supply the ability to efficiently change the output amplitude. This makes it possible to start large horns with reduced power. It also provides more power efficient switch-mode generator operation and increased reliability.
- **Linear Ramp Soft Start** circuitry allows the acoustic stack to ramp up to operating amplitude smoothly, minimizing the start-up surges and abnormal stress to the stack and generator.
- **Digi-Trac Tuning** tracks the resonant frequency of the acoustic stack (horn, booster, transducer) and adjusts the generator output frequency to match it. This is done for every weld cycle and eliminates the need to manually tune the generator.
- **Line Voltage Regulation** automatically maintains constant amplitude regardless of line voltage deviation. The available output power is maintained with any voltage input within the specified range. This pro-

vides consistent system performance regardless of line voltage fluctuations. It also eliminates the need for bulky, external constant-voltage transformers.

- **Load Regulation** provides constant amplitude automatically regardless of power draw. The ultrasonic output amplitude level is held to within $\pm 1\%$ to provide weld process consistency and reduced weld cycle times.
- **Industrial Line-Power Source** means that standard systems will operate worldwide at all industrial high line voltage levels, whether it is 200VAC @60Hz in Japan, 240VAC @50Hz in Europe or 208VAC @60Hz in the United States. There are no internal transformer taps to change for worldwide operation. North American systems are optionally available to operate on the 120VAC line voltage level.
- **Multiple Electronic Overload** protection circuits prevent instantaneous component failure in the event of extreme output overload conditions, and rated overload power limit is based on the actual true RMS power output level.
- **CE Certification** means that the system meets the required European standards to be sold and used in Europe.
- **ISO 9001 Certification** means that this system has been manufactured to high quality standards and assures you of manufacturing excellence.

SECTION 2

Health and Safety

General Considerations	7
Plastics Health Notice.	7
Electrical Safety	8
Lifting the Equipment	9

This page intentionally left blank

General Considerations

Please observe these health and safety recommendations for safe, efficient, and injury-free operation of your equipment. In this manual, the term *system* refers to a complete group of components associated with the welding of plastic or metal parts, also known as an ultrasonic assembly system. A typical system consists of a generator and/or ultrasonic process controller, start and stop switches, power controls, connecting cables, and the probe assembly which includes the transducer, booster, horn and replaceable horn tip.

Proper Installation - Operate system components only after they are properly installed and checked.

No Unauthorized Modifications - Do not modify your system in any way unless authorized to do so by the manufacturer. Unauthorized modifications may cause injury to the operator and/or equipment damage. In addition, unauthorized modifications will void the equipment warranty.

Keep the Cover On - Do not remove any equipment cover unless specifically directed to do so by the manufacturer. The generator produces hazardous electrical voltages which could cause injury.

Grounded Electrical Power - Operate this equipment only with a properly grounded electrical connection.

(See Page 8 for grounding information.)

Comply with Regulations - You may be required to add accessories to bring the system into compliance with applicable OSHA regulations for noise exposure.

Plastics Health Notice

Before using any ultrasonic welding system, be sure you are familiar with OSHA regulations from the U.S. Department of Labor about the particular type of plastic(s) you are using.

When plastic materials are being processed, they may emit fumes and/or gases that could be hazardous. Make sure you have adequate ventilation whenever these plastics are processed.

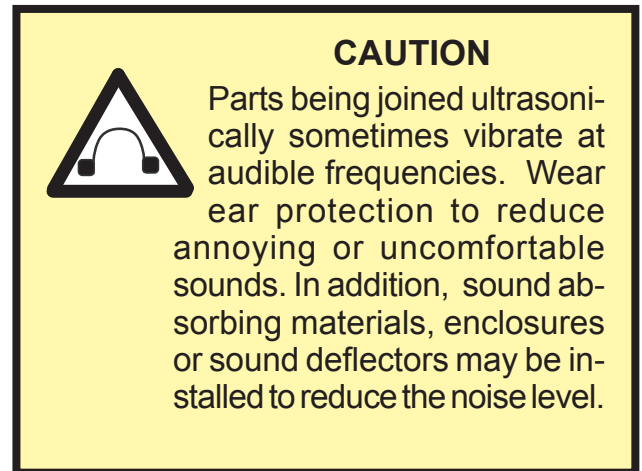
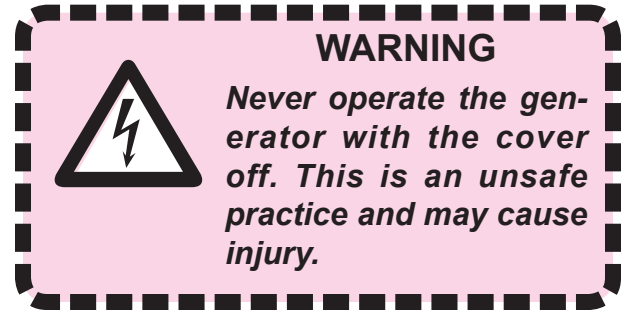

Electrical Safety

Domestic Power Grounding

For safety, the power cords used on this product have a three-wire, grounding-type power cord. Figures 2-1 and 2-2 illustrate the appropriate electrical outlet to use with the power cords included with 100-120 volt and 200-240 volt systems respectively. This information applies to systems shipped to North America or Japan.

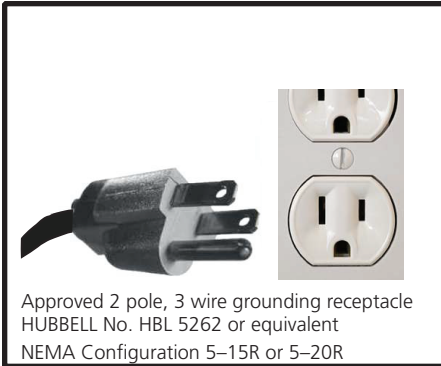

Figure 2-1 Example of 125 Volt, Grounded, 3-Prong Plug and Receptacle

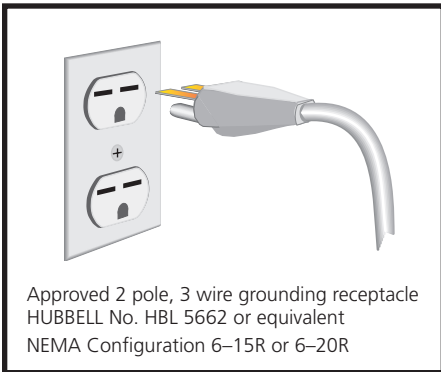

Figure 2-2 Example of 250 Volt, Grounded, 3-Prong Receptacle

International Power Grounding

The power cable normally provided for international use is compatible with the power outlet used in many Continental European countries. Refer to Figure 2-3. However, if your application requires another type of power cord, check with your equipment supplier, and follow local regulations concerning proper wiring and grounding.

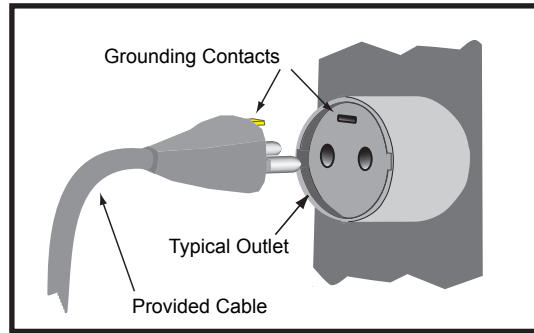

Figure 2-3 International 220/240V Grounding

CAUTION



If you have a two-prong electrical receptacle, we strongly recommend that you replace it with a properly grounded three-prong type. Have a qualified electrician replace it following the National Electric Code and any local codes and ordinances that apply.

See Figures 2-1 and 2-2.

CAUTION



If there is any question about the grounding of your receptacle, have it checked by a qualified electrician. Do not cut off the power cord grounding prong, or alter the plug in any way. If an extension cord is needed, use a three-wire cord that is in good condition. The cord should have an adequate power rating to do the job safely. It must be plugged into a grounded receptacle. Do not use a two-wire extension cord with this product.

Lifting the Equipment

	lb	kg
Generator Only	12	5.44
Generator + Packing Materials	17	7.71

Table 2-1 *iQ* Generator Weights

How to Lift Safely

- Before lifting, take a moment to think about what you're about to do.
- Examine the object for sharp corners, slippery spots or other potential hazards. Know your limit and don't try to exceed it.
- Ask for help if needed, or if possible, divide the load to make it lighter.
- Know where you are going to set the item down, and make sure it and your path are free of obstructions. Then follow these steps:
 - Step 1. Stand close to the load with your feet spread apart about shoulder width, with one foot slightly in front of the other for balance.
 - Step 2. Squat down bending at the knees (not your waist). Tuck your chin while keeping your back as vertical as possible.
 - Step 3. Get a firm grasp of the object before beginning the lift. Begin slowly lifting with your LEGS by straightening them. Never twist your body during this step.
 - Step 4. Once the lift is complete, keep the object as close to the body as possible. As the load's center of gravity moves away from the body, there is a dramatic increase in stress to the lumbar region of the back.
 - Step 5. If you must turn while carrying the load, turn using your feet-not your torso. To place the object below the level of your waist, follow the same procedures in reverse order. Remember, keep your back as vertical as possible and bend at the knees.



CAUTION

Take care in lifting the equipment. We recommend using a mechanical lift device to assist.

This page intentionally left blank

SECTION 3

Installation

Before Installation	13
When to Use Lockout/Tagout Devices	13
Unpacking	15
Placement	15
RFI Grounding	15
Connecting Cables	16
Power Cords	17
Automation Controlled System	17
System I/O Connector Pinout	18

This page intentionally left blank

Before Installation

As you plan for the installation of your generator, please consider these important subjects as listed below:

- When to use lockout / tagout devices
- Lifting the generator safely - See Section 2, *Health and Safety*, Page 9

When to Use Lockout / Tagout Devices



Figure 3-1 Lockout Device In Open Position, Unlocked

The typical kind of LOTO device for this generator is a clam shell type device (with lockout capability). The LOTO device is placed over the plug end of the generator electrical cord. This effectively prevents access to the energy isolation point. See the example of one such device in the figure above.

The figure to the right shows the lockout device in the closed, locked position.

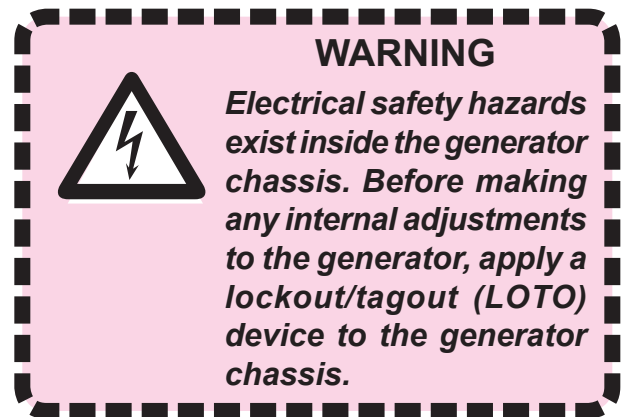

Figure 3-2 Bottom Lockout Device In Closed Position, Locked

Continued

Lockout/Tagout *Continued from previous page*

Procedure to use BEFORE making any internal adjustments to the generator:

1. Push the generator's AC power switch/breaker to the OFF position.
2. Unplug the generator's electrical cord from its source.
3. Authorized personnel apply a lockout/tagout (LOTO) device to the plug end of the generator's electrical cord. Using a typical clam shell type LOTO device:
 - 1) Open the clam shell.
 - 2) Place the electrical cord plug end inside the shell.
 - 3) Close the shell.
 - 4) Secure the shell with its lock, and lock it.
4. Wait a minimum of five minutes for the generator to discharge its electrical energy.
5. After taking these steps, make the necessary adjustments to the generator.

Assuming the generator is being put back into service. . .

Procedure to use AFTER making any internal adjustments to the generator:

1. Authorized personnel remove the lockout/tagout device from the plug end of the generator's electrical cord. Using a typical clam shell type LOTO device:
 - 1) Unlock the protective shell.
 - 2) Open the shell, exposing the electrical cord end.
 - 3) Remove the LOTO device, and set it aside.
2. Plug the generator's electrical cord into its AC power source.
3. Push the generator's AC power switch/breaker to the ON position.

Unpacking

Carefully open your shipping container, and make sure it contains the items shown on the shipping documents. Inspect all items, and report any missing items or damage immediately.

Placement

Make certain generator placement and cable routing do not interfere with normal operation. Maintain easy access to your equipment.

The operator should have unobstructed access to cables and wiring.

RFI Grounding

Proper grounding for the generator chassis is essential for the effective suppression of electrical noise or RFI (Radio Frequency Interference). Every ultrasonic generator contains a RFI filter that blocks noise on the AC power line from entering the system control circuitry. This filter also prevents ultrasonic frequency noise from being fed back into the AC power line. For the RFI filter to operate effectively, it is necessary to correctly ground the system.

Connect a grounding wire from the grounding stud connection (see Figure 3-1) to the nearest grounded metal pipe or equivalent earth ground.

See *Connecting Cables* on the next page.

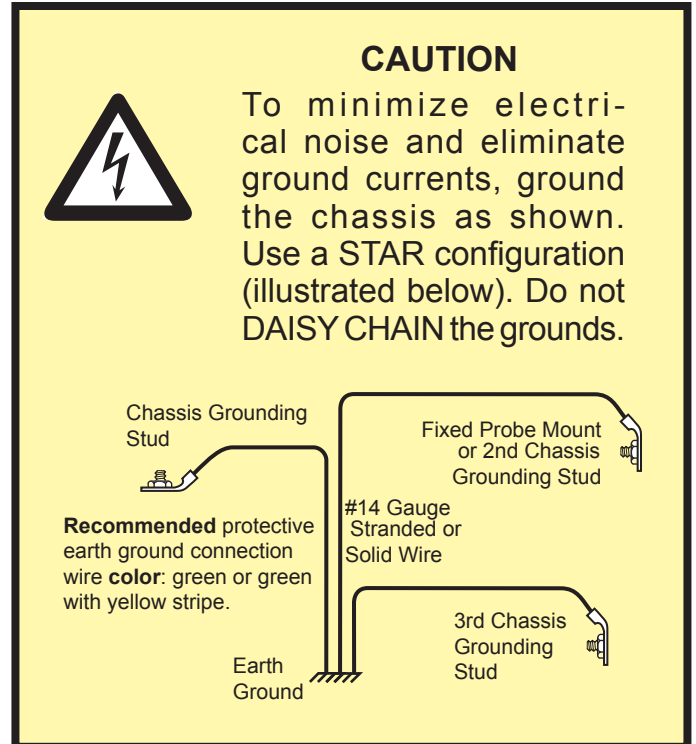

NOTE

Chassis Grounding Stud

The chassis grounding stud is used to attach a protective earth ground to the generator. This will aid in the suppression of electrical interference or radio frequency interference (RFI) that is common in a industrial environment. Stud location is shown in Figure 3-3 on the following page.

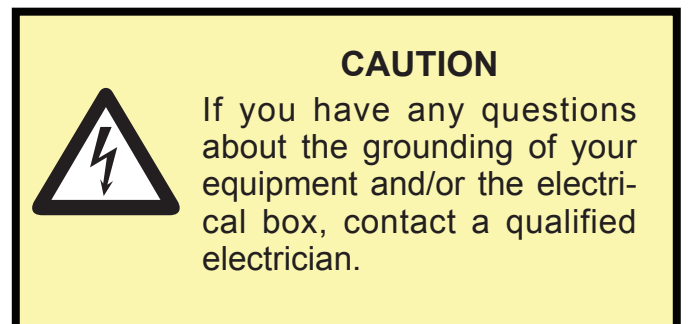

Connecting Cables - Quick Start Guide

Complete the basic connections as shown below:

- AC Line Input
- I/O (Input/Output) Connector
- Grounding Stud
- AC Power Cord Connection

Step 1. Connect the AC line. For the 100/120V model, plug the permanently attached power cord into a suitable receptacle.

For the 200/240V model, attach the female end of the power cord to the generator's power inlet connector - **A** in Figure 3-3.

Step 2. Attach the I/O cable connector to the generator's input/output connection. - **B** in Figure 3-3. Secure the connector to the system using the two jack screws attached to the connector hood.

Step 3. Ground the generator chassis with the supplied 14-Gauge wire. Attach one end to the grounding stud - **C** in Figure 3-2. Attach the other end to the nearest grounded metal pipe or equal earth ground.

Step 4. Attach the male end of the power cord to a suitable line receptacle.

Connector - See Page 19 for information about the rear panel CONFIGURATION connector **E**.

NOTE

AC Power Inlet

Depending on your generator model, line voltage required for the generator is either 100-120 VAC at 50/60 Hertz **or** 200-240 VAC at 50/60 Hertz.

The unit has a power switch, and is powered ON whenever the AC line power is live and the switch is in the ON position as shown in Figure 3-4 below.

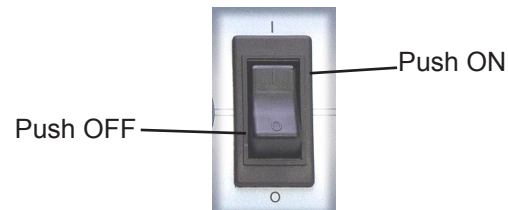

Figure 3-4 Rocker-style Power Switch/Circuit Breaker

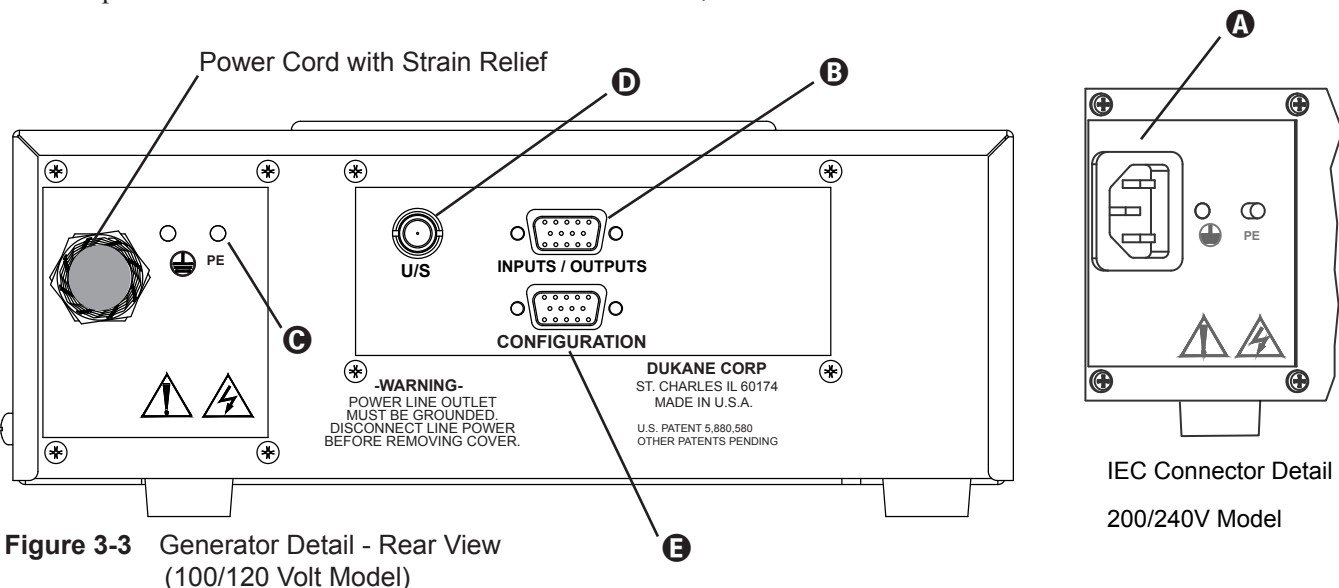

Figure 3-3 Generator Detail - Rear View (100/120 Volt Model)

IEC Connector Detail
200/240V Model

Power Cords

200/240 Volt Systems

The IEC AC power inlet connector mounted on the rear panel requires a properly configured IEC compliant power cord.

The 200/240 AC power cords supplied with the generators are matched to the ultrasonic output power rating and the continent of specified use. See Table 3-I.

Continent of Use	Power Cord Part Number	Power
North America	200 - 1541	240V, 10A
Europe	200 - 1542	240V, 10A
India	200 - 1624	240V, 10A

Table 3-I Standard IEC AC Power Cord Part Numbers

100/120 Volt Systems (North America or Japan)

The power cord (including strain relief) supplied with the 100/120 AC systems is permanently attached to the rear of the generator. Units with this power cord are for use in North America or Japan.

Automation Controlled System

- Step 1. Ground the generator chassis using the supplied 14-Gauge wire, and attach it to the grounding stud: **C** in Figure 3-3.
- Step 2. *Optional – Ground the probe support. This is a user-supplied 14-Gauge wire.*
- Step 3. Input/Output Cable - Attach the automation control cable from the user-supplied automation equipment to the system HD-15 connector, INPUTS/OUTPUTS on the rear panel: **B** in Figure 3-3.
- Step 4. Attach the high voltage coaxial cable from the probe to the ultrasound output connector, **D** in Figure 3-3.
- Step 5. Connect the AC power cord to the generator IEC power inlet connector, and plug the other end into an approved AC outlet: **A** in Figure 3-3.

System I/O Connector Pinout

Table 3-II lists the signal names and descriptions, with more detailed descriptions listed on the next page.

Pin	Color	Description
1	BLK	Enable Out
2	WHT	Enable In
3	RED	System Overload Status Output
4	GRN	Ultrasound Active Status Output
5	ORN	Any Fault Status Output
6	BLU	System Power Status Output
7	WHT/BLK	Status Output Common (iQ Chassis Ground)
8	RED/BLK	System Ready Status Output
9	GRN/BLK	Power Signal Monitor Output (1mV = 1 Watt)
10	ORN/BLK	Power Signal Monitor Common (IQ Chassis Ground)
11	BLU/BLK	Fault Reset Input
12	BLK/WHT	Ultrasound Activate/Cycle Start Input
13	RED/WHT	Isolated Input Common (Sourcing or Sinking Inputs)
14	GRN/WHT	No Connection
15	BLU/WHT	No Connection

Table 3-II Generator Input/Output Signals

Pin 1 (Enable Out)

This is a current limited voltage source output intended to connect to an E-Stop circuit. If an E-Stop circuit is not used, Pin 1 must be jumpered to Pin 2 for ultrasound operation to be enabled.

Pin 2 (Enable In)

The output from the E-Stop circuit is connected to this pin when an E-Stop circuit is used. Otherwise, this pin must be jumpered to Pin 1 for ultrasound operation to be enabled. See *Figure A-1 in Appendix A for E-Stop circuit wiring examples.*

Pin 3 (System Overload Status Output)

Pin 3 is a non-isolated digital NPN status output that activates when an output overload condition is tripped. This output will be an open circuit if an output overload condition is not tripped. This output will remain latched ON until the U/S Activate input is switched OFF and then ON again.

Pin 4 (Ultrasound Active Status Output)

Pin 4 is a non-isolated digital NPN status output that activates when the system is delivering ultrasonic power to the load attached to the ultrasound output connector. This output will be an open circuit when the ultrasound output is off.

Pin 5 (Any Fault Status Output)

Pin 5 is a non-isolated digital NPN status output that activates whenever any fault condition is detected that inhibits ultrasound output and normal system operation. This output will be an open circuit when no system fault conditions are active.

Pin 6 (System Power Status Output)

Pin 6 is a non-isolated digital NPN status output that activates when no fault conditions are detected by any of the power fault detection circuits included in the system. This output will be an open circuit when any power related fault condition is detected.

Pin 7 (Status Output Common)

Pin 7 is connected to chassis ground. The non-isolated NPN status output signals can drive isolated PNP inputs on the automation control system.

Pin 8 (System Ready Status Output)

This status output signal will activate only when the system is ready to activate ultrasound or begin a weld cycle.

Pin 8 is a digital active low status output that activates when a weld processing cycle is completed and the welding process control system is ready to start the next welding cycle. This output will be an open circuit when the welding process controller determines that the next welding cycle cannot be started. This includes system faults or E-Stop active, but not a process fault like Overload.

Pin 9 (Power Signal Monitor Output)

Pin 9 is an analog output signal proportional to the true RMS ultrasound power output level. This signal is scaled so 1mV = 1 Watt.

Pin 10 (Power Signal Monitor Common)

Pin 10 is a signal ground (non-isolated chassis ground) for the Analog Power output signal on Pin 9.

Pin 11 (Fault Reset Input)

Pin 11 is an isolated input control signal that will reset any output faults when it is activated. It can be used by the automation control system to simplify PLC programming.

Pin 12 (U/S Activate/Cycle Start Input)

Pin 12 is used to activate the generator ultrasound output. Activating this isolated control input will switch the ultrasound output ON, and deactivating this signal will switch ultrasound OFF.

Pin 13 (Isolated Input Common)

[Electrically connected to Pin 5 on MPC I/O connector if MPC Interface option is installed.]

Pin 13 is electrically isolated from chassis ground. Using sourcing (PNP) output drivers, this common line would be connected to the automation system power supply common. Using sinking (NPN) output drivers, this common line would be connected to the automation system positive supply output. *See Figure A-1 in Appendix A for E-Stop circuit wiring examples.*

Configuration Port Connector

This connector - **E** in Figure 3-3 - is a DB-9M (standard D-subminiature nine circuit, male) typically used for RS-232 serial communications. This serial port (DTE) connects to a serial port (DCE) on a computer via a standard 9-pin serial cable. If the computer does not have a serial port, you may use a USB-to-serial conversion cable.

This port is used for field updates to the generator firmware, without removing the enclosure cover. This port can also be used with a software application running on a Windows PC to modify the factory default system settings and hardware configurations. Contact your local sales representative for software availability information and access to documentation that will allow you to make use of the configuration port features.

This page intentionally left blank

SECTION 4

Controls

Front Panel Overview	23
Start-up Sequence	25
LCD Display Overview	26

This page intentionally left blank

Front Panel Overview

This section gives an overview of the front panel functions: powering the generator on/off; monitoring the process with the display; and, programming with the control keys.

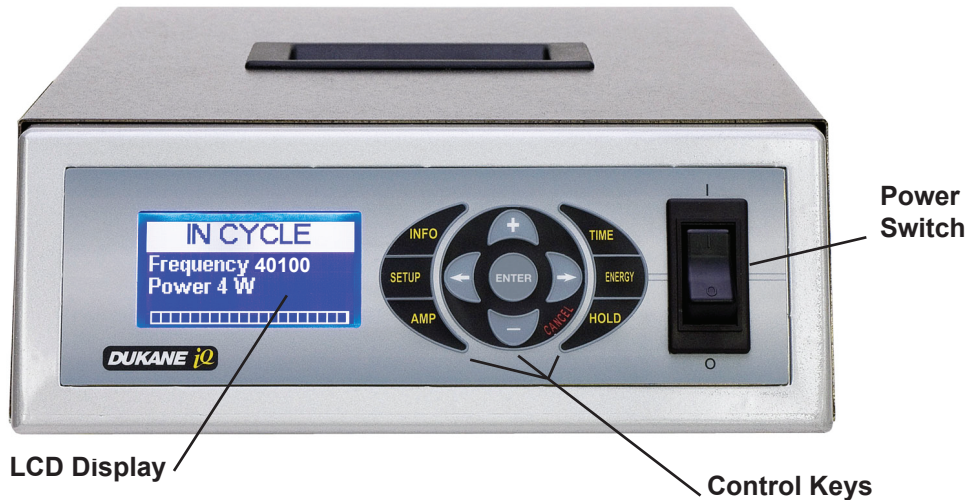

Figure 4-1 Front Panel

Power Switch/Circuit Breaker

The power switch/circuit breaker has a rocker-style actuator switch that will activate or deactivate the AC power to the system. The power ON position is marked with the internationally recognized I symbol, the power OFF position is marked with the 0 symbol. This power switch also integrates an appropriately sized over-current protection circuit breaker function in the generator.

If an over-current condition trips the circuit breaker, it will automatically switch to the OFF position. If the overload current that caused the circuit breaker to trip is due to a transient condition, the circuit breaker can be reset by switching the actuator back to the ON position.



CAUTION

If when resetting the circuit breaker after it has tripped, it immediately trips again, an internal system malfunction, is likely, and the generator will need service. Do NOT repeatedly try to reset the circuit breaker. If it trips, this will only cause more damage to the generator.

Control Keys

The control keys shown in Figure 4-1 and described below, are used to display information, and to program the generator.

INFO

Press this key to get system information or to modify the advanced settings.

System Information - Identifies the current version of system software.

Advanced Settings - Select features that can be turned on or off including the Audible Alarm or Fault Latching options.

SETUP

Use the SETUP key to Load, Store, or Delete as many as eight setups.

Continued

Control Keys

Continued

AMP

Set the ultrasound amplitude output level in the range of 20 to 100%. Typically amplitude is set to 100%.

TIME

Use this key to select time as the method of welding. Set the weld time (seconds).

ENERGY

Use this key to select energy as the method of welding. Set the weld energy (joules).

HOLD

Hold is a time period beginning after the weld portion of the cycle is complete. The automation program holds the probe in place applying pressure to the weld, and an audible alarm indicates that the Hold time is finished. Hold can be set to a maximum of 5.0 seconds.

ENTER

Press the ENTER key to select a menu item, and move to the next level of the menu. Think of it as a “forward” key. When pressed, it also confirms and stores a selection in memory. It is also used to reset a latched condition.

Arrow Keys

Press the right and left arrow keys to move the cursor to the right or left.

+ and - Keys

Press these keys to increase or decrease the value of a selected digit.

CANCEL

Press CANCEL to return to the previous screen. Think of it as a “back” key. Press this key when you do not want to store the selection in memory.

System LCD Display

This high resolution, multi-line display provides a clear graphic interface to the operate and in-cycle screens needed to monitor and program the system.

Power Bar Graph

The Power Bar Graph appears at the bottom of the LCD display. It contains 20 segments that represent the generator's range of power from 0% at the far left of the bar graph to 100% of power at the far right. Each segment equals 5% of the total.

In the example below, 40% of the available power is used during the weld cycle. The display shows an In Cycle screen (while ultrasound [U/S] is active).

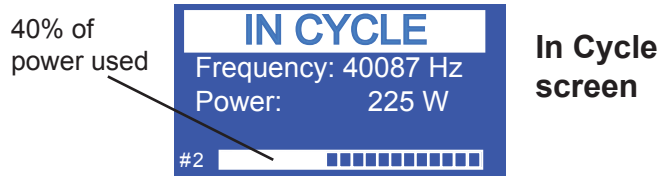

Figure 4-1A Power Bar Graph - In Cycle

In the example below, 40% of the generator power was the maximum (peak) power delivered in the previous weld. The display shows an Operate screen (while U/S is inactive).

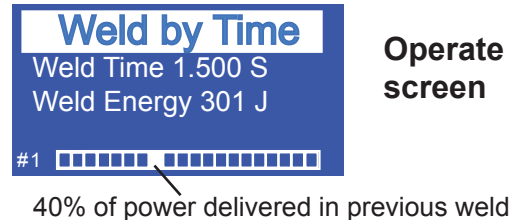

Figure 4-1B Power Bar Graph - Operate

CAUTION

Make sure the stack is properly assembled before it is connected to the system. The horn should never come in direct contact with a metal fixture or anvil when ultrasound is activated.

Start-up Sequence

After all connections have been completed.

1. Push the Power Switch to ON (Figure 4-2).
The generator performs a self-diagnostics sequence.
2. Two Power-up screens appear briefly - Figure 4-3, and Figure 4-3A.
3. The next screen is an Operate screen ready for a new weld to be done. The display shows:
The setup used for the last weld, and zeros for any weld parameters.
See Figure 4-3B.

Starting a Weld Cycle

1. If the generator is not powered, press its Power Switch/Circuit Breaker to the ON position.
2. Select the setup you want to use, if appropriate.
3. The generator is ready to start a weld cycle when the Ultrasound Activate/Cycle Start Input (Pin 12) is activated.

Stopping the Weld Cycle

Normal Conditions

The cycle stops when the programmed welding cycle ends if the generator is configured to weld by time or energy. If it is configured to weld by automation, the cycle ends when the Ultrasound Activate/Cycle Start Input (Pin 12) is deactivated.

Emergency Conditions

Manual System

Push the Power Switch to OFF (See Figure 4-2.) to stop the ultrasound signal. This may be done under any conditions.

Automated System

Customer-supplied external controls provide the means to stop the cycle for an automated system.

An auxiliary cable connects these external controls to the *iQ* generator at the INPUTS/OUTPUTS connector.

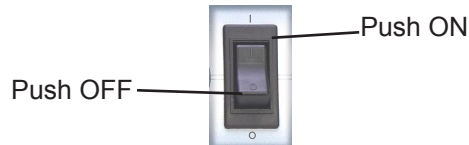

Figure 4-2 Power Switch



Figure 4-3 Power-up Screen 1



Figure 4-3A Power-up Screen 2

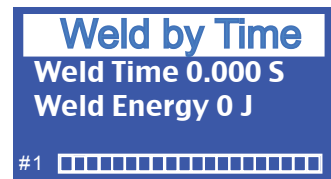

Figure 4-3B Operate Screen, After Power-up

LCD Display Overview

There are two basic kinds of screen displays:

Operate screens, and **In Cycle** screens.

An **Operate** screen tells the operator what happened in the last weld cycle.

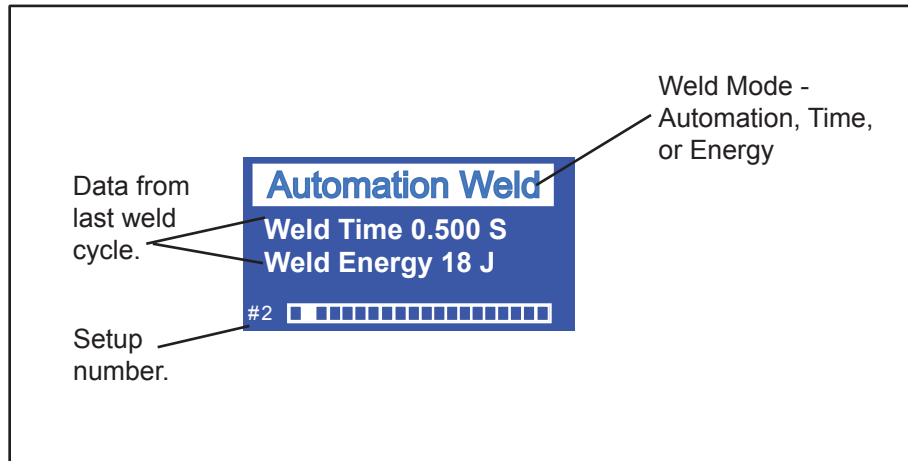

Figure 4-4 Example of an **Operate** Screen

An **In Cycle** screen activates when the ultrasound signal has been activated.

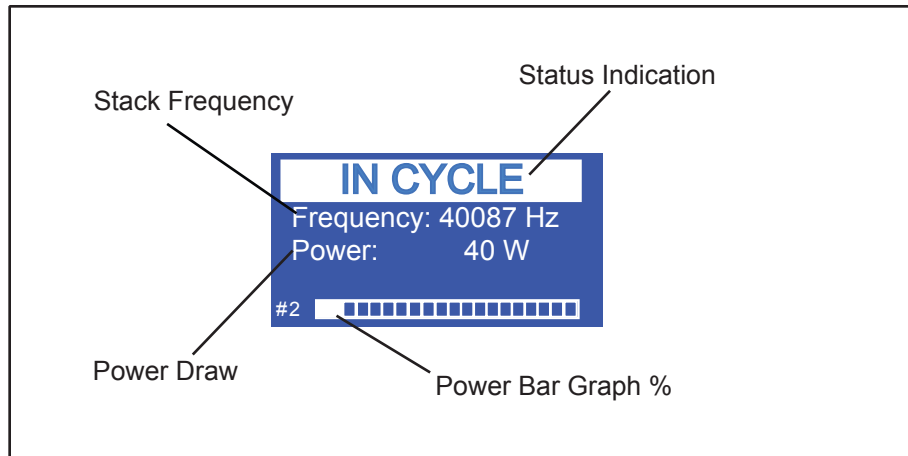

Figure 4-5 Example of an **In Cycle** Screen

SECTION 5

Process Control Settings

Select the Welding Mode	29
Navigating the Modes.	30
Hold	32
Amplitude Adjustment.	32
System Information, Advanced Settings.	33
Setup Maintenance	36

This page intentionally left blank

Process Controller Settings

This section of the manual helps the reader become familiar with the operating modes, and illustrates some typical programming steps.

There are three welding modes available. These correspond to the three ways in which the welder can be used: Automation, Time, and Energy.

Select the Welding Mode

Automation - In AUTOMATION mode the PLC controls the weld cycle. The cycle starts, and the ultrasonic signal (U/S) activates when Ultrasound Activate/Cycle Start Input (Pin 12) is activated. When the Ultrasound Activate/Cycle Start Input (Pin 12) is deactivated, the ultrasonic signal stops and the cycle is complete unless there is a hold time programmed.

Time - In TIME mode the operator sets a maximum time (seconds) that the ultrasonic signal will be active for each weld cycle. The cycle starts when the Ultrasound Activate/Cycle Start Input (Pin 12) is activated. The U/S stops when the programmed time is reached.

Energy - In ENERGY mode the operator sets a maximum energy (Joules) the generator will reach during the weld cycle. *[A maximum weld time must be set when welding by energy. If the energy level is not reached, the preset for time will determine when the U/S is deactivated.]* When the preset energy level is reached, the U/S will be deactivated. The cycle starts when the Ultrasound Activate/Cycle Start Input (Pin 12) is activated. When the programmed energy is reached, ultrasound stops.

Navigating the Modes

When the generator is first powered up, the default operating mode is Automation, and **Automation Weld** is shown at the top of the display as shown in Figure 5-1.

Navigate to Time Mode

1. Follow the sequence shown in the figures to the right to navigate from Automation mode to Time mode.

In Automation mode, press the TIME key (Figure 5-2).

2. The phrase, *Enter Changes Mode*, means when the ENTER key is pressed, the mode will change. So press the ENTER key, and the Weld by Time screen seen in Figure 5-3 appears.

3. Set the time.

Use the ← → and the + - keys to move the cursor and to set the digits for the weld time you want.

4. Press the ENTER key to accept the time that has been set (Figure 5-4).

Press the CANCEL key if you decide not to set the time.

NOTE

Navigating to Automation Mode

Set Time or Energy (depending on mode) to OFF, and press ENTER. This will put you back in Automation mode.

Alternately:

Find an empty setup. Press SETUP. Press ENTER.

A pop-up screen about defaults appears.



Select YES to load the default operating mode which is Automation, and you can weld using the Automation mode.

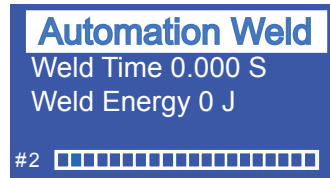

Figure 5-1 Automation Weld Mode

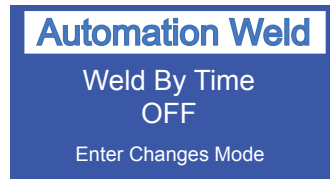

Figure 5-2 Navigate to Time Mode



Figure 5-3 Time Weld Mode - 1



Figure 5-4 Time Weld Mode - 2



Navigate to Energy Mode

- Follow the sequence shown in the figures to the right to navigate from Time mode to Energy mode.

In Time mode (Figure 5-5), press the ENERGY key, and the screen as shown in Figure 5-6 appears.

- The phrase, *Enter Changes Mode*, means when the ENTER key is pressed, the mode will change. So press the ENTER key, and the Weld by Energy screen seen in Figure 5-6A appears.
- Use the ← → and the + - keys to move the cursor and to set the digits for the energy you want. See Figure 5-7.
- Press the ENTER key to accept the energy that has been set. Press the CANCEL key if you decide not to set the energy.
- If you set the energy level, a maximum weld time needs to be set also. Set a time that is reasonable for your application. [The factory default for this time is 30 seconds (also the maximum).]

The time can not be set below 0.001 second.

Use the ← → and the + - keys to move the cursor and to set the digits for the time you want.

See Figure 5-8.

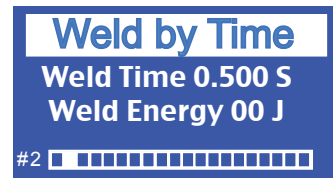

Figure 5-5 Time Weld Mode

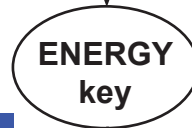

Figure 5-6 Navigate to Energy Mode - 1

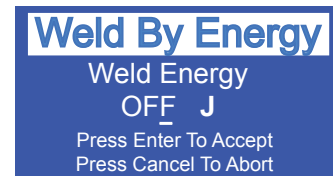

Figure 5-6A Navigate to Energy Mode - 2

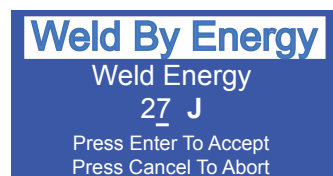
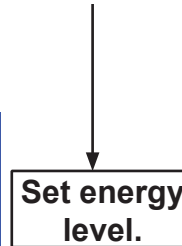

Figure 5-7 Energy Weld Mode - 1

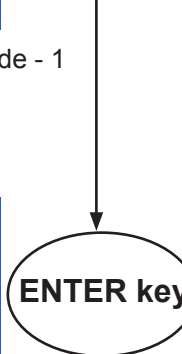

Figure 5-8 Energy Weld Mode - 2

Hold

HOLD is used more often with Time or Energy modes, but it can be used with the Automation mode.

HOLD does not allow the automation program to begin a new cycle until HOLD is finished.

To set a HOLD period:

1. Select the weld mode (Automation, Time, Energy).
2. Set the time and energy parameters as needed.
3. Press the HOLD key. The screen will appear as it does in Figure 5-9.
4. Set the time with the + - keys.

(A maximum of 5.0 seconds.)

Figure 5-9A shows a setting for 2.0 seconds.

5. Press the ENTER key to confirm your selection.

Amplitude Adjustment

Amplitude refers to the movement of the horn at its workface. The higher the amplitude setting, the higher the power output level will be at a particular pressure level.

Amplitude settings are given as a percent of the horn's nominal amplitude in the range of 20% to 100%.

It is typical to leave the amplitude setting at 100% for maximum power output.

To adjust amplitude:

1. Press the AMP key. The screen will appear as in Figure 5-10.
2. Set the amplitude level using the ← → keys and the + - keys.
3. Press ENTER to confirm your amplitude setting.



Figure 5-9 HOLD Time - 1



Figure 5-9A HOLD Time - 2

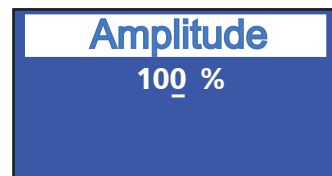

Figure 5-10 Amplitude

System Information, Advanced Settings

When the INFO key is pressed the display looks like Figure 5-11:

Using the **+** **-** keys, move the pointer to indicate:

System Information, or
Advanced Settings

Press ENTER to make the selection.

1. System Information

Manufacturer's information is shown including the manufacturer's name, the name of the system, and the software identification.

Figure 5-11A shows an example of this information.

2. Advanced Settings

After **Advanced Settings** is selected, a warning screen is displayed as shown in Figure 5-12.

Adjusting these settings may affect the operation of your unit. Before you change a setting, please check with Dukane personnel for their recommendations.

The warning screen is shown for a few seconds, then, the **Advanced Settings** screen appears.

See Figure 5-13.

Adjustments can be made to: Free Run Frequency; Ramp Up Time; Frequency Lock and Hold; and, Trigger By Power, but note that Trigger by Power is only available when the weld mode is Time or Energy.

Free Run Frequency

Free Run is the frequency at which the generator drives the ultrasound output pulses until a valid resonant frequency feedback signal is detected. Typically this value should be below the operating frequency of the probe.

Follow the on screen prompts to make setting adjustments.

Continued

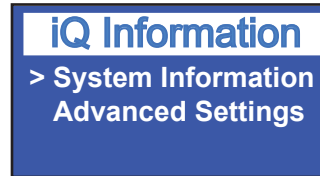

Figure 5-11 INFO Screen

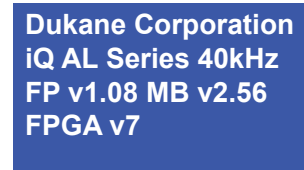

Figure 5-11A System Information Example Screen

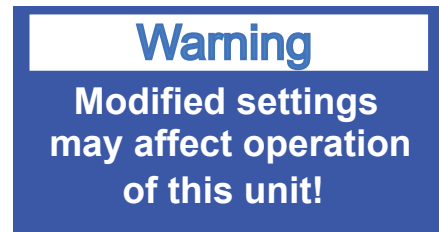

Figure 5-12 Warning Screen

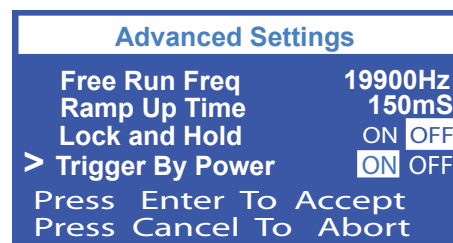
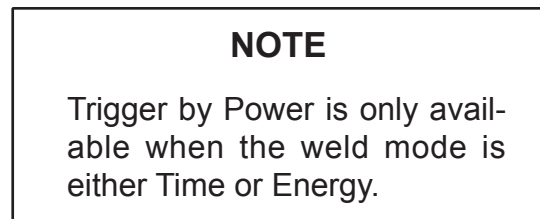

Figure 5-13 Advanced Settings Screen

Continued

Ramp Up Time

This parameter increases the amplitude linearly in the programmed time period at the start of the weld from zero to the programmed amplitude level. This brings the probe up to operating amplitude smoothly preventing shock stress.

Follow the on screen prompts to make setting adjustments.

Lock and Hold

For an explanation of Frequency Lock and Hold, please refer to *Application Note 505* found on our website at:

http://www.dukane.com/us/DL_ApplData.asp

Follow the on screen prompts to make setting adjustments.

Trigger by Power

For an explanation of Trigger by Power and the three settings that are connected with it, please refer to *Application Note 506* found on our website at:

http://www.dukane.com/us/DL_ApplData.asp

When Trigger by Power is selected, three additional settings screens are presented:

- Trigger Amplitude;
- Trigger Power; and,
- Trigger Timeout

See Figures 5-14, 5-15, and 5-16 for previews of these screens

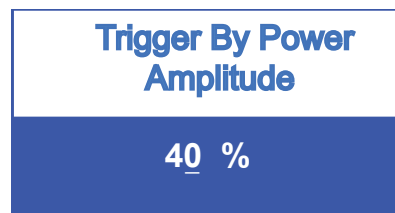

Figure 5-14 Trigger Amplitude

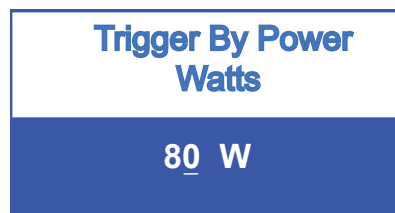

Figure 5-15 Trigger Watts



Figure 5-16 Trigger Timeout

Setup Maintenance

Introduction

The screens available in Setup Maintenance allow the operator to Load, Store, or Delete generator weld setups. As many as eight (8) setups can be loaded and stored for your convenience.

Navigating

1. When the SETUP key is pressed for the first time, the display looks like Figure 5-17. This screen indicates that Setup #1 is Empty. Because there is not yet any data available, this setup has nothing in it, and is empty. You will see that Load is highlighted.

Press ENTER.

2. **Load** - (Load means to put data into the generator's memory, or to program a setup.)

A pop-up screen asks if defaults should be loaded for Setup #1. See Figure 5-17A.

Select NO, and the display will change to an Operate screen.

Select YES, and Automation Weld shows at the top of the Operate screen that will display next. The setup number appears in the lower left corner of the screen. Refer to Figure 4-4.

3. After selecting YES, press SETUP, and the display will look like Figure 5-19.
4. **Delete** -To delete the setup, select Delete as shown in Figure 5-19, and press the ENTER key. A pop-up screen appears to ask you to confirm your choice.

Select YES or NO, and press ENTER again.

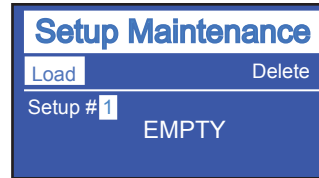

Figure 5-17 Setup Maintenance - 1

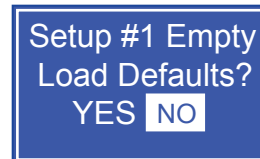

Figure 5-17A Pop-up Load Defaults?

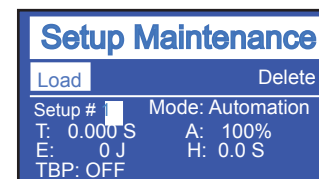

Figure 5-18 Setup Maintenance - 2

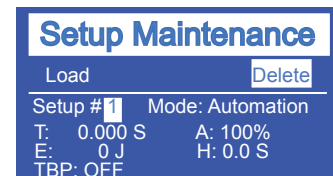

Figure 5-19 Setup Maintenance - 3

Continued

Setup Maintenance *Continued*

Changing the Current Setup

Try using your navigation skills on this example:

1. Follow instructions on Page 24 to set the mode to **Weld by Time**. Set the time to 1.520 seconds. See Figure 5-20.
2. Press **SETUP**, and you will notice that the time just set appears in the current setup. The new time replaced whatever time was in the current setup. It was changed, or overwritten.
3. To avoid having your current setup changed: Press **SETUP**, and with **LOAD** highlighted, use the **+ -** keys to select an empty setup. Press **ENTER**.

Then, make the Time (and/or Energy) entries. Nothing will be overwritten because your entries were made in an empty setup.

4. Confirm that your setup has been saved in memory by going back to **SETUP**. Your new setup should appear, as it does in Figure 5-22.

Selecting a Setup

To select a setup previously loaded:

1. Press **SETUP**.
2. With **Load** highlighted, use the **+ -** keys to select the number of the setup you want.
3. Press **ENTER**.
4. The Operate screen will display this setup selection as a number in the display's lower left hand corner.

Deleting a Setup

To delete a setup previously stored:

1. Press **SETUP**.
2. With **Delete** highlighted, use the **+ -** keys to select the number of the setup you want.
3. Press **ENTER**, and a pop-up screen will ask you to confirm your selection. Make your choice, and press **ENTER**.
4. Check that the setup is deleted. Press **SETUP**, and the Setup Maintenance screen will show **EMPTY** for the setup you just deleted.



Figure 5-20 Set Time

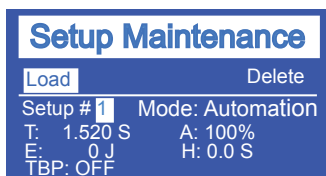

Figure 5-21 New Setup Saved

NOTE

The power supply program always has one default setup (as shown below). This can be overwritten, but can not be deleted.

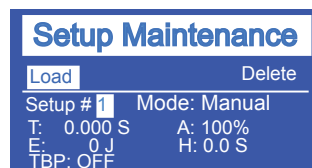

Figure 5-22 Default Setup Screen

SECTION 6

Probes and Probe Stacks

Ultrasonic Probe Overview	39
Theory of Operation	40
Probe Configuration	40
Ultrasonic Horn	41
Booster.....	41
Stack Assembly	42
Attaching Replaceable Tips.....	42
Attaching Mounting Stud to Horn/Booster.....	43
Attaching Horn to Booster.....	44
Attaching Booster to Probe	44
Attaching Horn to Probe.....	44
Stack Disassembly	46
Booster Notes.....	48

This page intentionally left blank

Ultrasonic Probe Overview

Operating Notes

Compressed Air Fitting - In continuous duty operation, it is important to keep the probe cool with compressed air. Use the probe's air fitting to connect the air source to the probe.

See Section 8, *Specifications* for more detail.

	<p>CAUTION</p> <p>The ultrasonic cable carries high electrical current when in operation. Do not nick or cut this cable. If cut, there would be a high potential for electric shock!</p>
--	---

<p>NOTE</p> <p>Compressed air supply: Make sure the air is clean, oil-free, and dry.</p>

Theory of Operation

Plastic welding is the most common application of ultrasonic assembly. To perform ultrasonic plastic welding, the vibrating tip is brought into contact with one of the work pieces. Pressure is applied and ultrasonic energy travels through the material generating frictional heat at the contact point of the two parts. The frictional heat melts a molded ridge of plastic on one of the pieces and the molten material flows between the two surfaces. When the vibration stops, the material solidifies forming a permanent bond.

Probe Configuration

A basic ultrasonic probe package consists of:

1. A probe which houses the transducer to convert the electrical energy supplied by the generator into mechanical vibrations.
2. A horn to transfer the mechanical vibrations from the probe to the parts to be welded.

Optional components include special replaceable tips which can be threaded on to the tip of the horn, and a booster to amplify the mechanical vibrations of the horn. A basic probe system is shown in Figure 6-1.

Normally a booster is not used with a probe as this increases the length and weight and reduces its versatility. The optional threaded titanium tip can be used when the application calls for a staking profile or a pointed spot weld. Replaceable tips are not commonly used in high-volume production environments.

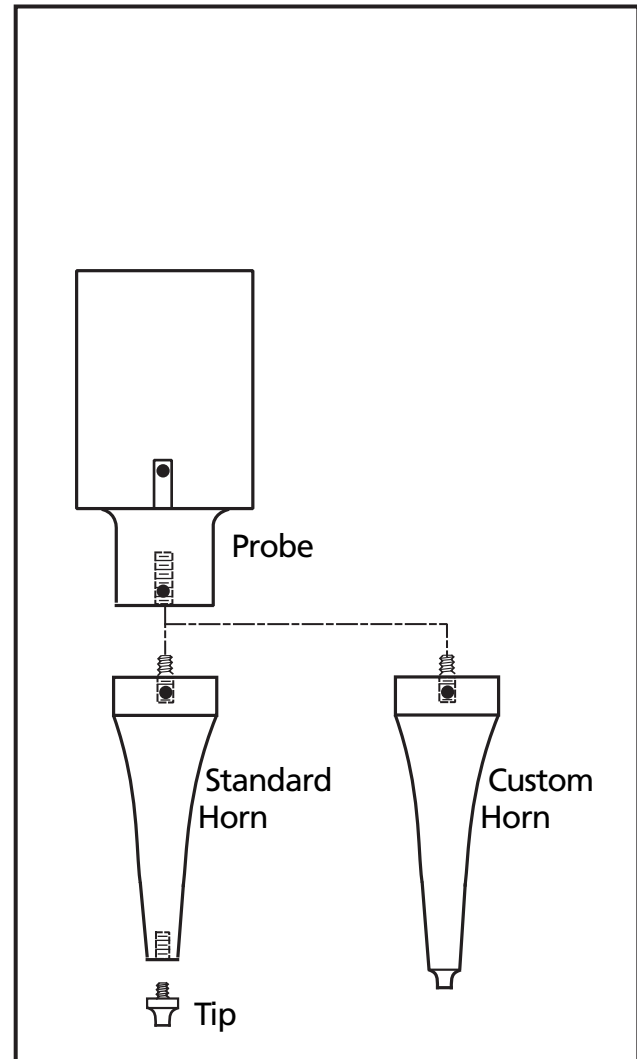
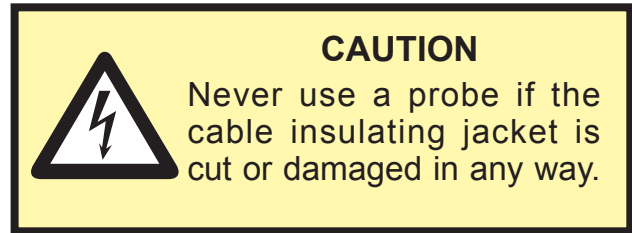
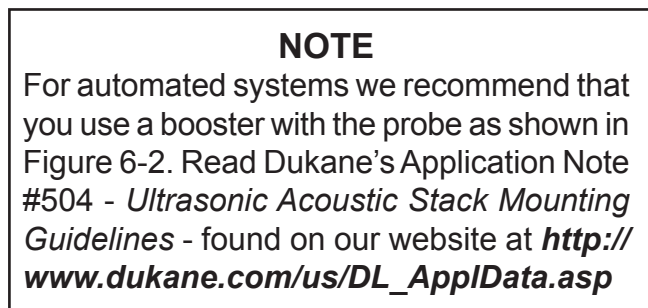

Figure 6-1 Probe, Horn and Tip



Ultrasonic Horn

The horn transfers the ultrasonic mechanical vibrations (originating at the transducer in the probe housing) to the plastic parts through direct physical contact. The horn is precision machined and designed to vibrate at either 20kHz, 30kHz, 40kHz, 50kHz or 70kHz. The tuning is accomplished using electronic frequency measurement. Inherent variations in material composition prevent tuning by dimensional machining alone.

There are many different horn profile styles depending upon the process requirements. Factors which affect the horn design are the materials to be welded and the method of assembly. Horns are usually constructed from aluminum, hardened steel or titanium. As the frequency increases, vibration amplitude typically decreases, but internal stress in the horn increases. Higher frequencies are used for delicate parts that cannot handle a lot of amplitude. Some factors to keep in mind for high-frequency (e.g. 40kHz) ultrasonic welding versus low-frequency (e.g. 20kHz) ultrasonic welding are listed here.

1. Stress in the horn is higher at high frequencies.
2. Wear on the horn is greater at high frequencies.
3. Clean and flat mating surfaces between the horn, booster and transducer are more critical at high frequencies.

Booster

The function of a booster is to alter the gain (i.e. output amplitude) of the probe. A booster is amplifying if its gain is greater than one and reducing if its gain is less than one. A neutral or coupling booster is used to provide an additional clamping location for added probe stack stability. A probe designed to be mounted in a fixture along with a booster and horn is shown in Figure 6–2. This is commonly referred to as a stack. As indicated, the components are secured with threaded studs.

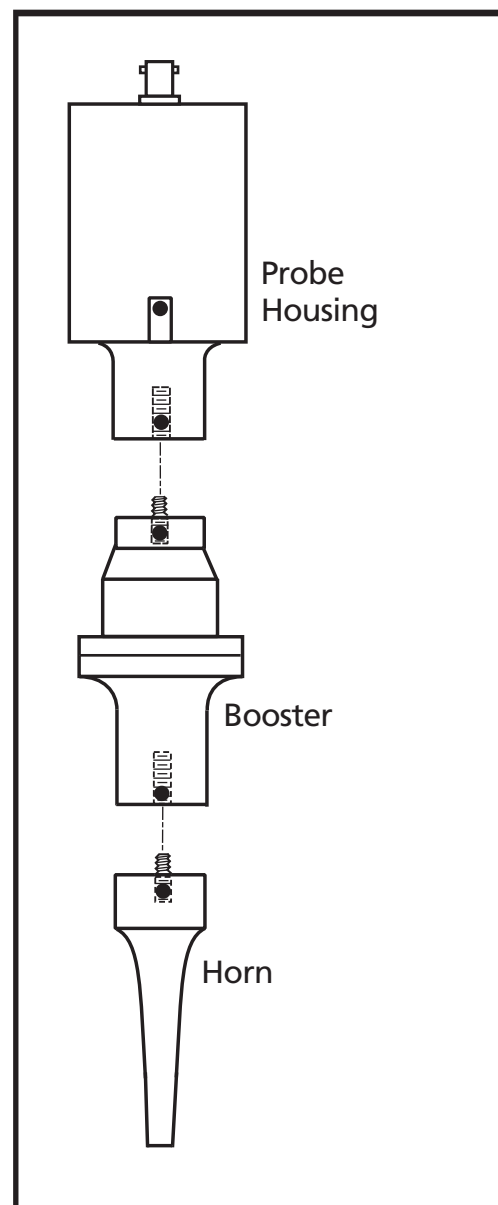

Figure 6–2 Probe, Booster and Horn

Stack Assembly

Attaching a Replaceable Tip to a Horn

1. Inspect all horn and tip surfaces for stress cracks, chips, or gouges. Any of these irregularities will affect operation and could lead to further equipment damage. Contact the Dukane Ultrasonics Tooling Department concerning damaged horn components.
2. Apply an extremely thin layer of a high temperature, high pressure silicon grease to the back surface that mates with the horn. The grease will allow both surfaces to intimately mate and become acoustically transparent which improves the energy transfer. Do not apply any grease to the threads. We recommend Dow–Corning #4 (or #111 as an alternate). A small packet of Dow–Corning #4 is supplied with the system. If you cannot use a silicon–based grease in your facility, a petroleum–based grease may be used. However, it is likely to leave carbonaceous deposits on the surface, and require more frequent joint maintenance. Failure to follow these instructions, may result in the mating surfaces bonding and difficulty removing the tip from the horn.
3. Thread the tip into the horn and tighten to the torque specifications below using an open end wrench of the correct size to fit the wrench flats of the tip. This is illustrated in Figure 6-3. If necessary, use a spanner wrench (on horns with spanner wrench holes) or an open end wrench (on horns with wrench flats) to keep the horn from turning in your hand. A canvas strap wrench is permissible if it does not gouge or scratch the horn.

Replaceable Tips to Horn

inch-lb	ft-lb	N-m	Size
360	30	40.7	1/2" x 20 tpi tip threads
336	28	38	3/8" x 24 tpi tip threads
300	25	33.9	5/16" x 24 tpi tip threads
240	20	27.1	1/4" x 28 tpi tip threads

Table 6-I Tip Torque Unit Conversions

NOTE
Do not apply any grease to the threads of the replaceable tip. This may cause the tip to loosen from the horn resulting in inconsistent operation.

CAUTION
 NEVER clamp the horn in a vise. The resulting scratches or gouges in the surface are stress risers which may result in cracks.

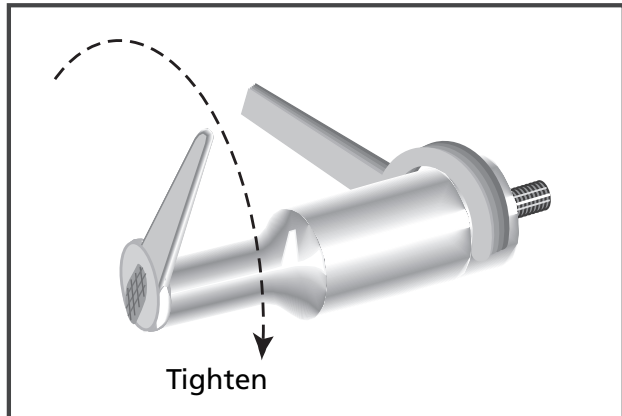

Figure 6-3 Replaceable Tip Installation

NOTE
Dukane Part No. for the 20kHz spanner wrenches is 721-68.

Dukane Part No. for the 40kHz spanner wrenches is 721-44.

Attaching the Mounting Stud to a Horn or a Booster

1. Inspect the stud for cracks or damaged threads. Replace the stud if it is cracked or otherwise damaged.
2. Remove any foreign matter from the threaded stud and the mating hole.
3. Thread the mounting stud into the input* end of the horn or the input* end of the booster and tighten to the following torque specifications using an Allen wrench in the socket head of the mounting stud. Table 6-II lists the torque specifications in units for both English and Metric systems of measurements.

DO NOT hold the booster by the mounting rings when tightening stud. The mounting rings have a shear pin which could snap under excessive torque. Use a spanner wrench (on horns with spanner wrench holes) or an open end wrench (on horns with wrench flats) to keep the horn or booster from turning in your hand.

in-lb	ft-lb	N-m	Size
12-18	1 - 1.5	1.4 - 2	1/2" x 20 tpi studs
12-18	1 - 1.5	1.4 - 2	3/8" X 20 tpi studs
12-18	1 - 1.5	1.4 - 2	8 mm studs

Table 6-II Stud Torque Unit Conversions

* Always assemble the mounting studs that mate boosters, transducers and horns to the input end of the horn or the input end of the booster first. This is shown in Figure 6-5.

NEVER thread a stud into the transducer or the output end of the booster first. See *Booster Notes* in this section for correctly identifying the output end of a booster.

NOTE

Do not apply any grease to the stud threads or the tapped hole. This may cause the stud to loosen. If the stud wanders within the joint, it can vibrate, resulting in excessive heat. In some cases, this can melt the tooling material.

NOTE

To convert inch-lbs to ft-lbs, divide by 12.
To convert inch-lbs to Nm, divide by 8.852.
To convert ft-lbs to Nm, multiply by 1.356.
To convert Nm to ft-lbs, multiply by 0.7376.

Torque specifications have a tolerance of about $\pm 10\%$.

Attaching the Horn to a Booster, Booster to a Probe, or Horn to a Probe

1. Inspect all surfaces to be joined for stress cracks, chips, or gouges. Any of these irregularities will affect operation and could lead to further equipment damage. Contact the Dukane Ultrasonic Tooling Department concerning a damaged booster.
2. Ensure that the mating surfaces of the two components are clean and smooth. These surfaces must make intimate contact for the mechanical energy to pass from one component to the next. Pitting or a buildup of old grease and dirt on a mating surface will interfere with the energy transfer and reduce the power delivered.
3. Make sure that the stud in the horn or booster is tight. See the preceding mounting stud assembly instructions for torque specifications.
4. Remove any foreign matter from the threaded stud and mating hole.
5. Apply an extremely thin layer of a high temperature, high pressure silicon grease to the surface that mates with the horn. The grease will allow both surfaces to intimately mate and become acoustically transparent which improves the energy transfer. We recommend Dow-Corning #4 (or #111 as an alternate). A small packet of Dow-Corning #4 is supplied with the system. If you cannot use a silicon-based grease in your facility, a petroleum-based grease may be used. However, it is likely to leave carbonaceous deposits on the surface, and require more frequent joint maintenance. Grease may be omitted if mylar washers are preferred on systems that require frequent changes. Mylar is plastic and will creep under compression, so mylar is not recommended for systems that are not changed frequently. Failure to follow these instructions, may result in the mating surfaces bonding and difficulty removing the horn from the booster or the booster from the probe.

NOTE

Always remove a probe stack from the machine in which it is mounted before attaching or removing a horn.

CAUTION



Never leave a horn or booster assembly hand tight. Torque it to the proper specifications before proceeding. If the assembly is installed without being properly torqued down, the assembly may vibrate severely, damaging the mating surfaces and causing the generator to overload.

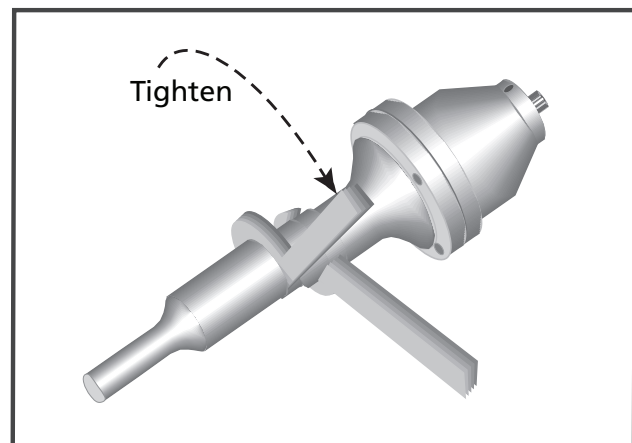

Figure 6-4 Stack Assembly Procedure

6. Thread the components together and tighten to the following torque specifications using only the correct size wrenches. Use spanner wrenches on components with spanner wrench holes or an open end wrench on components with wrench flats. See Figure 6–4 for the correct procedure. Refer to Table 6-III for torque unit conversions. Be careful not to overtighten.

In-lb	Ft-lb	N-m	kHz
540	45	61	15 kHz stack
420	35	47.5	20 kHz stack
216	18	24.4	30 kHz stack
216	18	24.4	40 kHz stack

Table 6-III Horn/Booster Torque Unit Conversions

NOTE

Horn and booster torque specifications are higher than stud torque specs. Be sure to tighten the horn or booster joints to the higher torque limits. Do not tighten the studs to these higher ratings as it may induce unnecessary stress in the assembly.

Stack Disassembly

Stack disassembly is required when changing the booster or horn, or for a thorough inspection of all stack components. In mounted systems, always remove the stack from its mounting to disassemble the stack components.

To establish a maintenance schedule, inspect the mating surfaces after the first 200–400 hours of operation. If they require cleaning, halve the time between inspections. If the surfaces do not require reconditioning, then double the time between inspections. Each system is different due to the large number of operational parameters and stress factors.

The assembly and disassembly procedures for a probe are shown in Figure 6–5. It makes no difference whether the horn is attached to the booster first, or the booster is attached to the probe first.

CAUTION



Never hold a probe by the housing when tightening or loosening an adjoining component. The probe housing has anti-rotation devices to keep the transducer aligned. These could shear under excessive torque.

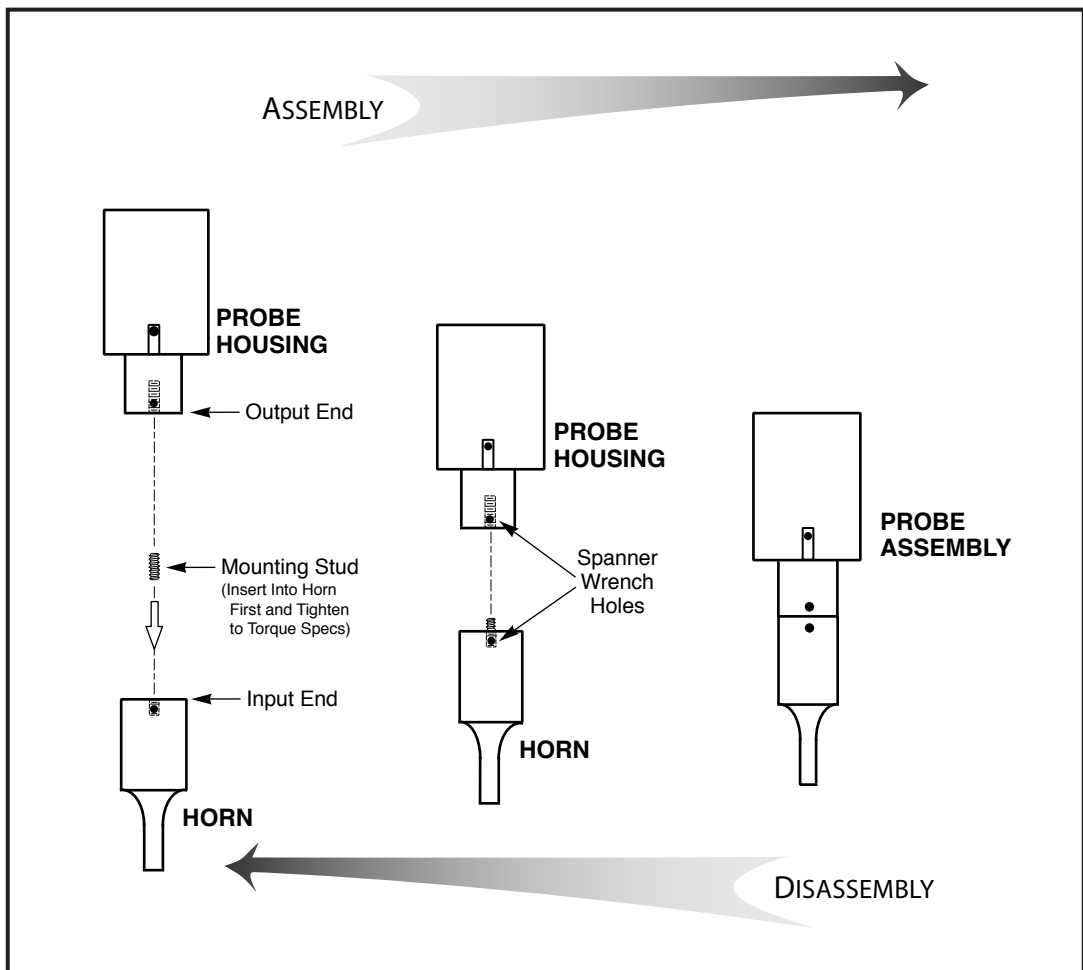

Figure 6–5 Probe Assembly and Disassembly

Separating the Horn from a Booster, Booster from a Probe or Horn from a Probe

On all transducers and horns with spanner wrench holes, use only the correct size spanner wrench that came with your system to provide sufficient torque to loosen a joint. See Figure 6–6.

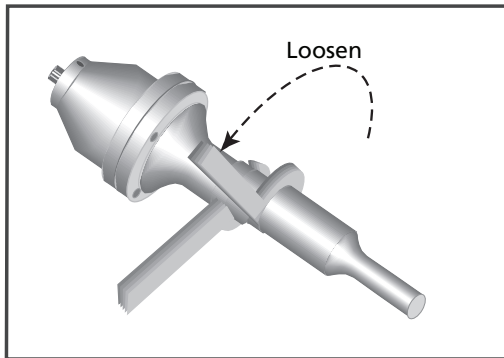

Figure 6–6 Separating the Horn from the Booster

On boosters and horns with wrench flats, use only the correct size wrench to provide sufficient torque to loosen a joint when necessary.

Removing the Mounting Stud from a Horn or Booster

Only use an Allen wrench of the correct size in the socket head's stud to remove the stud from the horn or booster.

Removing Replaceable Tips from a Horn

Use an open end wrench of the correct size to fit the wrench flats of the detachable tip. Use a spanner wrench (on horns with spanner wrench holes) or an open wrench (on horns with wrench flats) to provide an opposite force to keep the horn from turning in your hand. Refer to Figure 6–7 for the correct tip removal procedure.

NOTE

Do not hold a booster by the mounting rings when removing the stud from the booster. Use a spanner or open-end wrench to provide opposite force and keep the horn or booster from turning in your hand when loosening the stud. Use a spanner wrench on horns and boosters with spanner wrench holes. Use an open end wrench on horns and boosters with wrench flats.

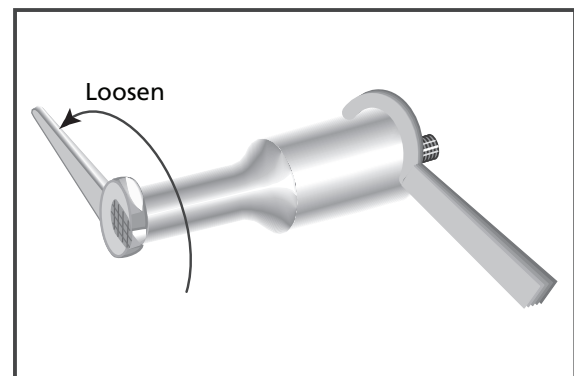

Figure 6–7 Removing a Replaceable Tip from the Horn

Booster Notes

How to Tell the Booster Input End from the Output

1. The depth of the threaded hole on the output end is always deeper than the threaded hole on the input end.
2. On an amplifying booster (gain > 1.0), the larger diameter end is the input end. On a reducing booster (gain < 1.0) the larger diameter end is the output end. On a neutral acting booster the diameters are equal.
3. The cap screws on the booster mounting rings are always inserted from the output end toward the input end.

How to Tell if the Booster Is Amplifying or Reducing

Boosters have a die-stamped number on their surface that indicates their gain or reduction. If the number is greater than 1.0 (e.g. 1.5), it is an amplifying booster. If the number is less than 1.0 (e.g. 0.6), it is a reducing or reverse booster. A neutral booster has no gain and has 1.0 stamped on it. A neutral or coupling booster is used to provide another probe stack clamping location for added stability.



CAUTION

NEVER install a booster upside down to change an amplifying system to a reducing system. The boosters are dimensionally asymmetric. They are tuned from input to output to act like an acoustic lens. Reversing them will not give the expected results and may cause damage to the system.

SECTION 7

Troubleshooting

No Ultrasonic Output	51
System Power Output Level	51
Welding Problems	52
Pop-up Fault Status Screens.....	53

This page intentionally left blank

No Ultrasonic Output

Probe

Make sure that the probe cable is connected to the generator connector (PROBE) and secured to the rear panel. Also, make sure the probe stack is properly assembled.

System Power Output Level

Overload

When an overload occurs, it will automatically reset when the next ultrasound activation signal begins. If the condition persists:

Turn the generator OFF and:

1. Check the system. Change the probe to one that is known to be good.
2. Turn the generator ON, and see if the fault condition has been corrected.

Overtemperature

When the system overheats, and the generator's internal temperature exceeds 85°C (185°F) an overtemperature fault condition will trip.

When the system cools, the system automatically resets the overtemperature fault.

Generator Fault Does Not Reset

When a system fault condition does not automatically reset, the generator needs servicing.

System Power Diagnostic Procedures

The only fault indications available with these probe systems are the ones shown on the LCD display.

NOTE

The LCD screen displays a variety of pop-up status changes as they occur. Check Table 7-I - Pop-up Fault Status Screens - Page 53.

NOTE

When Latching Faults is enabled, ENTER must be pressed to clear a fault.

Welding Problems

Weak Welds

Weak welds, or underwelding, is caused by insufficient energy being transmitted to the part. You can increase the weld pressure, increase the weld duration (Time or Energy) or change to a higher gain booster to increase the amplitude to increase the energy delivered to the weld.

Inconsistent Welds

Variations in plastic due to filler materials and moisture absorption may lead to inconsistent welds. Fillers can be especially troublesome if they are not uniformly distributed, the content is too high or it contains too much or poor quality regrind or degraded plastic.

Try welding by energy. This eliminates many inconsistencies. There should be no unusual or loud noise from the acoustic stack. If there is, disassemble the stack and reassemble.

Exchange the probe with another unit to see if the problem disappears. If not, exchange the generator with another unit to try and isolate the problem.

The horn amplitude may not be uniform if it has been machined, altered or damaged. All of these will change the resonant frequency of the horn. You can have the horn analyzed.

Pop-up Fault Status Screens





Generator Fault Status Screens - Automation Mode	
Status Text Displayed	System Status or Fault Explanation
 <p>Generator Fault Average Overload</p>	An Average Overload fault tripped. Output power exceeded rated wattage. Lower the welding pressure or amplitude. Fault will reset when next weld cycle starts.
 <p>Generator Fault Peak Overload</p>	A Peak Overload fault tripped. Peak IGBT transistor current exceeded. Caused by a severe frequency mis-match. Fault will reset when next weld cycle starts.
 <p>Generator Fault Frequency Overload</p>	Resonant frequency not found, or lost. Check for a defective stack component. Check for stack coupling to the fixture. Fault will reset when next weld cycle starts.
 <p>Generator Fault Over Temperature</p>	System Overtemperature fault detected. Fault will reset when system cools down.
 <p>Generator Fault Cycle Power</p>	Internal communications error. Turn generator power off and back on. Call Dukane service if the fault persists.

Table 7- I Pop-Up Fault Status Screens

This page intentionally left blank

SECTION 8

Specifications

Generator Outline Drawing	57
Weights	58
Operating Environment	58
AC Power Requirements	59
Regulatory Agency Compliance	60

This page intentionally left blank

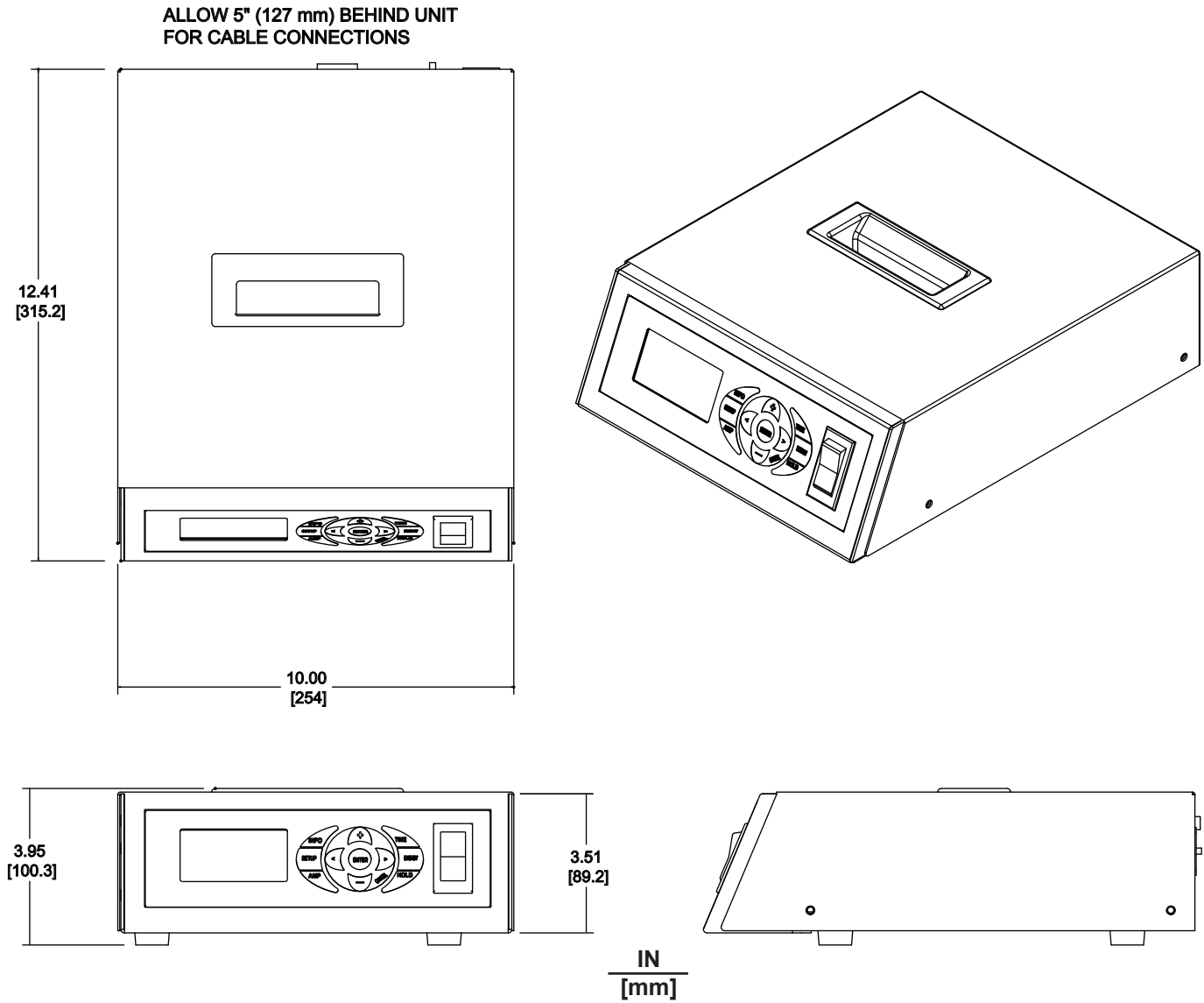

Figure 8-1 Generator Outline Drawing

Weights

- Generator: 12 pounds (5.44 kg)
Shipping: Add 5 pounds (2.27 kg) to unit weight for packing materials.

Operating Environment

Operate the equipment within these guidelines:

- Temperature:** 40°F to 100°F (+5°C to +38°C)
Air Particulates: Keep the equipment dry.
Minimize exposure to moisture, dust, dirt, smoke and mold.
Humidity: 5% to 95% non-condensing @ +5°C to +30°C
-

Nonoperating storage guidelines:

- Temperature:** - 4°F to 158°F (-20°C to +70°C)
Air Particulates: Keep the equipment dry.
Minimize exposure to moisture, dust, dirt, smoke and mold.
Humidity: 5% to 95% non-condensing @ 0°C to +30°C

AC Power Requirements

Operating Frequency	Generator Model Number	Overload Power Rating (Watts)	Input AC Power Requirements Nominal AC Volt	North America/ Japan AC Outlet Rating
20kHz	20ALP060-1E	600	100-120 VAC, 50/60 Hz @ 9.0 Amps	15.0 Amps
20kHz	20ALP060-2E		200-240 VAC, 50/60 Hz @ 4.5 Amps	
30kHz	30AL060-1E		100-120 VAC, 50/60 Hz @ 9.0 Amps	
30kHz	30AL060-2E		200-240 VAC, 50/60 Hz @ 4.5 Amps	
40kHz	40AL060-1E		100-120 VAC, 50/60 Hz @ 9.0 Amps	
40kHz	40AL060-2E		200-240 VAC, 50/60 Hz @ 4.5 Amps	

Table 8-I AC Power Requirements

Regulatory Agency Compliance

FCC

The generator complies with the following Federal Communications Commission regulations.

- The limits for FCC measurement procedure MP-5, “Methods of Measurement of Radio Noise Emissions from ISM Equipment”, pursuant to FCC Title 47 Part 18 for Ultrasonic Equipment.

CE Marking

This mark on your equipment certifies that it meets the requirements of the EU (European Union) concerning interference causing equipment regulations. CE stands for Conformité Européenne (European Conformity). The generator complies with the following CE requirements.

- The EMC Directive 2004/108/EC for Heavy Industrial —
 - EN 61000-6-4: 2001
 - EN 55011: 2003
 - EN 61000-6-2: 2001
 - EN61000-4-2
 - EN61000-4-3
 - EN61000-4-4
 - EN61000-4-5
 - EN61000-4-6
 - EN61000-4-8
 - EN61000-4-11
- The Low Voltage Directive 2006/95/EC.
- The Machinery Directive 2006/42/EC.
 - EN 60204: 2006
 - Safety of Machinery - Electrical Equipment of Machines Part 1: General Requirements.

IP (International Protection) Rating

The *iQ* generator has an IP rating from the IEC (International Electrotechnical Commission).

The rating is IP2X, in compliance with finger-safe industry standards.

NOTE

DO NOT make any modifications to the generator or associated cables as the changes may result in violating one or more regulations under which this equipment is manufactured.

SECTION 9

Contacting Dukane

This page intentionally left blank

Contacting Dukane

Identify Equipment

When contacting Dukane about a service-related problem, be prepared to give the following information:

- Model number, line voltage and serial number
- Fault/error indicators from the LCD display
- Software version (Press **INFO**. With pointer at **System Information**, press **ENTER** to get this data.)
- Problem description and steps taken to resolve it

Many problems can be solved over the telephone, so it is best to call from a telephone located near the equipment.

Intelligent Assembly Solutions

Mailing Address: Dukane Ultrasonics
2900 Dukane Drive
St. Charles, IL 60174 USA

Phone: (630) 797-4900

E-mail: ussales@dukane.com

Fax:

Main (630) 797-4949

Service & Parts (630) 584-0796

Website

The website has information about our products, processes, solutions, and technical data. Downloads are available for many kinds of literature.

Here is the address for the main website:

www.dukane.com/us/

You can locate your local representative at:

www.dukane.com/us/sales/intsales.htm

This page intentionally left blank

APPENDICES

Appendix A - E-Stop Circuitry Examples	67
Appendix B - List of Figures	68
Appendix C - List of Tables	69

This page intentionally left blank

Appendix A

Dedicated E-Stop Switch Wiring Diagram

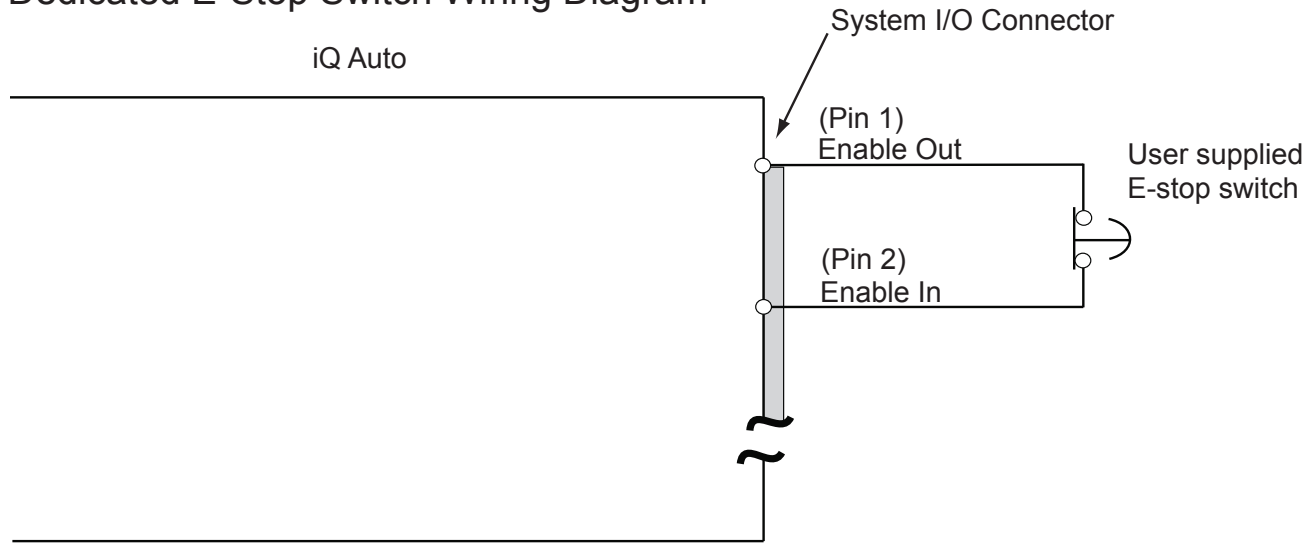

Automation System Safety Circuit Wiring Diagram

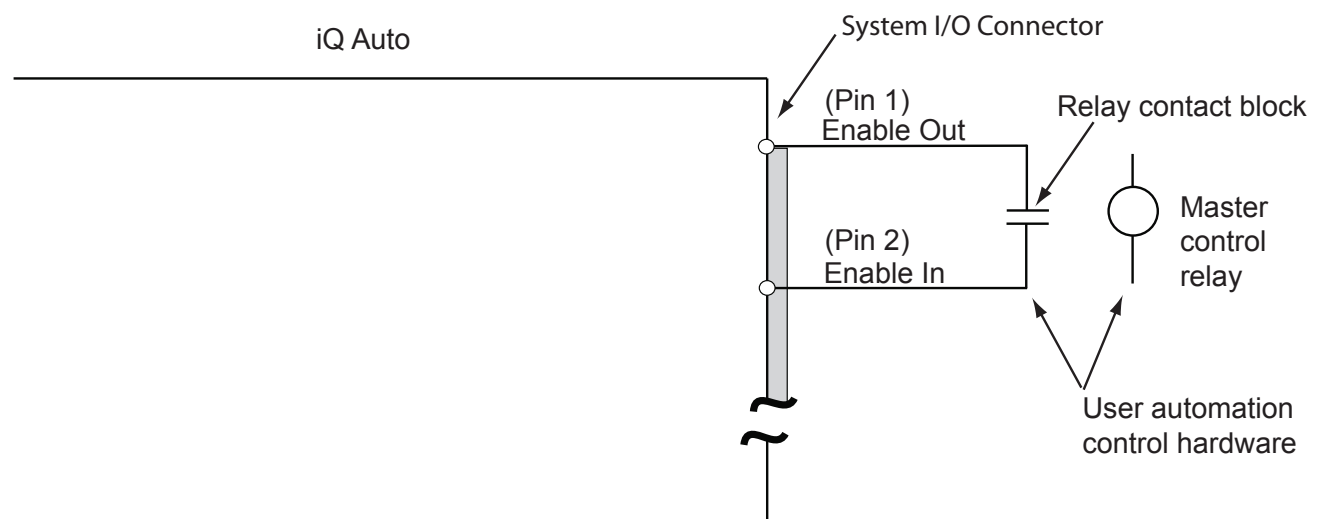

Figure A-1 E-Stop Circuitry

Appendix B

List of Figures

No.	Description	Page
2-1	Example of 125 Volt, Grounded, 3-prong Plug and Receptacle.....	8
2-2	Example of 250 Volt, Grounded, 3-prong Plug and Receptacle.....	8
2-3	International 220/240V Grounding	8
3-1	Lockout Device in Open Position, Unlocked	13
3-2	Bottom Lockout Device in Closed Position, Locked	13
3-3	Generator Detail - Rear Views.....	16
3-4	Rocker-style Power Switch/Circuit Breaker.....	16
4-1	Front Panel.....	23
4-1A	Power Bar Graph - In Cycle	24
4-1B	Power Bar Graph - Operate	24
4-2	Power Switch.....	25
4-3	Power-up Screen 1.....	25
4-3A	Power-up Screen 2.....	25
4-3B	Operate Screen Appears After Power-up	25
4-4	Example of an Operate Screen	26
4-5	Example of an In Cycle Screen	26
5-1	Manual Weld Mode.....	30
5-2	Navigate to Time Mode	30
5-3	Time Weld Mode - 1	30
5-4	Time Weld Mode - 2	30
5-5	Time Weld Mode	31
5-6	Navigate to Energy Mode -1.....	31
5-6A	Navigate to Energy Mode -2.....	31
5-7	Energy Weld Mode - 1.....	31
5-8	Energy Weld Mode - 2.....	31
5-9	HOLD Time - 1	32
5-9A	HOLD Time - 2	32
5-10	Amplitude	32
5-11	INFO Screen	33
5-11A	System Information Example Screen.....	33
5-12	Warning Screen.....	33
5-13	Advanced Settings Screen.....	33
5-14	Trigger Amplitude	34

Appendix B

Continued

List of Figures

5-15	Trigger Watts	34
5-16	Trigger Timeout	34
5-17	Setup Maintenance - 1	35
5-17A	Pop-up Load Defaults?.....	35
5-18	Setup Maintenance - 2	35
5-19	Setup Maintenance - 3	35
5-20	Set Time	36
5-21	New Setup Saved.....	36
5-22	Default Setup Screen	36
6-1	Probe, Horn and Tip	40
6-2	Probe, Booster and Horn.....	41
6-3	Replaceable Tip Installation	42
6-4	Stack Assembly Procedure	44
6-5	Probe Assembly and Disassembly	46
6-6	Separating the Horn from the Booster.....	47
6-7	Removing a Replaceable Tip From the Horn	47
8-1	Generator Outline Drawing.....	57

Appendix C

List of Tables

No.	Description	Page
2-I	<i>iQ</i> Generator Weights.....	9
3-I	Standard IEC AC Power Cord Part Numbers	17
3-II	Generator Input/Output Signals	18
6-I	Tip Torque Unit Conversions.....	42
6-II	Stud Torque Unit Conversions	43
6-III	Horn/Booster Torque Unit Conversions.....	45
7-I	Pop-up Fault Status Screens	53
8-I	AC Power Requirements	59

This page intentionally left blank

Dukane ISO

ISO CERTIFICATION

Dukane chose to become ISO 9001:2008 certified in order to demonstrate to our customers our continuing commitment to being a quality vendor. By passing its audit, Dukane can assure you that we have in place a well-defined and systematic approach to quality design, manufacturing, delivery and service. This certificate reinforces Dukane's status as a quality vendor of technology and products.

To achieve ISO 9001:2008 certification, you must prove to one of the quality system registrar groups that you meet three requirements:

1. Leadership
2. Involvement
3. Quality in Line Organizations and Quality System Infrastructure.

The ISO 9001:2008 standard establishes a minimum requirement for these requirements and starts transitioning the company from a traditional inspection-oriented quality system to one based on partnership for continuous improvement. This concept is key in that Dukane no longer focuses on inspection, but on individual processes.

Dukane's quality management system is based on the following three objectives:

1. Customer oriented quality. The aim is to improve customer satisfaction.
2. Quality is determined by people. The aim is to improve the internal organization and cooperation between staff members.
3. Quality is a continuous improvement. The aim is to continuously improve the internal organization and the competitive position.



Please refer to our website at:
www.dukane.com/us/sales/intsales.htm
to locate your local representative.

iQ Series, Ultrasonic Power Supply AL User's Manual
Part No. 403-583-00



www.dukane.com/us

Printed in the United States of America

Dukane Intelligent Assembly Solutions • 2900 Dukane Drive • St. Charles, Illinois 60174 USA • TEL (630) 797-4900 • FAX (630) 797-4949

Free Manuals Download Website

<http://myh66.com>

<http://usermanuals.us>

<http://www.somanuals.com>

<http://www.4manuals.cc>

<http://www.manual-lib.com>

<http://www.404manual.com>

<http://www.luxmanual.com>

<http://aubethermostatmanual.com>

Golf course search by state

<http://golfingnear.com>

Email search by domain

<http://emailbydomain.com>

Auto manuals search

<http://auto.somanuals.com>

TV manuals search

<http://tv.somanuals.com>