

DUKANE

Progressive Scan Liquid Crystal Projector

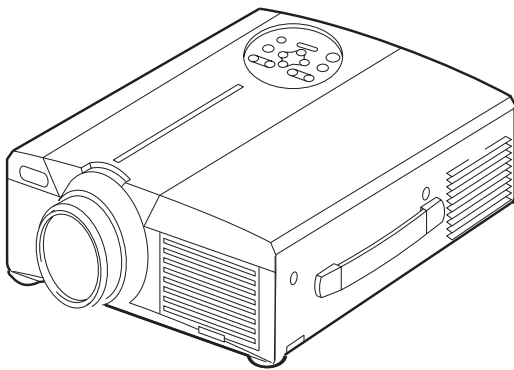

Model
28A8909
User's Manual



BEFORE USING

About the Symbols

Various symbols are used in this manual, the user's manual and on the product itself to ensure correct usage, to prevent danger to the user and others, and to prevent property damage. The meanings of these symbols are described below. It is important that you read these descriptions thoroughly and fully understand the contents.

 Warning	This symbol indicates information that, if ignored, could possibly result in personal injury or even death due to incorrect handling.
 Caution	This symbol indicates information that, if ignored, could result possibly in personal injury or physical damage due to incorrect handling.

Typical Symbols



This symbol indicates an additional warning (including cautions). An illustration is provided to clarify the contents.



This symbol indicates a prohibited action. The contents will be clearly indicated in an illustration or nearby (the symbol to the left indicates that disassembly is prohibited).



This symbol indicates a compulsory action. The contents will be clearly indicated in an illustration or nearby (the symbol to the left indicates that the power plug should be disconnected from the power outlet).

NOTE : "Remote control transmitter" may be called "Remote controller" in the "USER'S MANUAL".

SAFETY PRECAUTIONS

WARNING

Never use the projector if a problem should occur.

Abnormal operations such as smoke, strange odor, no image, no sound, excessive sound, damaged casing or elements or cables, penetration of liquids or foreign matter, etc. can cause a fire or electrical shock.

In such case, immediately turn off the power switch and then disconnect the power plug from the power outlet. After making sure that the smoke or odor has stopped, contact your dealer. Never attempt to make repairs yourself because this is dangerous this could be dangerous.

* The power outlet should be close to the projector and easily accessible.



Disconnect the plug from the power outlet.

Do not insert liquids or foreign object.

Penetration of liquids or foreign objects could result in fire or electrical shock.

Use special caution in households where children are present.

If liquids or foreign object should enter the projector, immediately turn off the power switch, disconnect the power plug from the power outlet and contact your dealer.

* Do not place the projector in a bathroom.

* Do not expose the projector to rain or moisture.

* Do not place flower vases, pots, cups, cosmetics, liquids such as water, etc on or around the projector.

* Do not place metals, combustibles, etc on or around the projector.



Never modify.

The projector contains high voltage components. Modification could result in fire or electrical shock.

* Never open the cabinet.

* Ask your dealer to repair and clean insides.



Do not disassemble

Do not give the projector any shock or impact.

If the projector should be shocked and/or broken, it could result in an injury, and continued use could result in fire or electrical shock.

If the projector is shocked, immediately turn off the power switch, disconnect the power plug from the power outlet and contact your dealer.



SAFETY PRECAUTIONS (continued)

WARNING

Do not place the projector on an unstable surface.

If the projector should be dropped and/or broken, it could result in an injury, and continued use could result in fire or electrical shock.

- * Do not place the projector on an unstable, slant or vibrant surface such as a wobbly or inclined stand.
- * Use the caster brakes placing the projector on a stand with casters.
- * Do not place the projector in the side up position, the lens up position or the lens down position.



Be cautious of High temperatures of the projector.

High temperatures are generated when the lamp is lit. It could result in fire or burn. Use special caution in households where children are present.

Do not touch about the lens, air fans and ventilation openings during use or immediately after use, to prevent a burn. Take care of ventilation.

- * Keep a space of 30 cm or more between the sides and other objects such as walls.
- * Do not place the projector on the metallic table.
- * Do not place anything about the lens, air fans and ventilation openings of the projector.
- * Never block the air fan and ventilation openings.
- * Do not use with the ventilation opening facing downwards.
- * Do not cover the projector with a tablecloth, etc.
- * Do not place the projector on a carpet or bedding.



Never look through the lens or openings when the lamp is on.

The powerful light could adversely affect vision. Use special caution in households where children are present.



Use only the correct power outlet.

Incorrect power supply could result in fire or electrical shock. Use only the correct power outlet depending on the indication on the projector and the safety standard.

- * The enclosed power cord must be used depending on the power outlet to be used.



Be cautious of the power cord connection.

Incorrect connection of the power cord could result in fire or electrical shock.

- * Do not touch the power cord with a wet hand.
- * Check that the connecting portion of the power cord is clean (with no dust), before using. Use a soft and dry cloth to clean the power plug.
- * Insert the power plug into a power outlet firmly. Avoid using a loose, unsound outlet or contact failure.



SAFETY PRECAUTIONS (continued)

WARNING

Be careful in handling the the light source lamp.

Incorrect handling the lamp could result in explosion.

- * Since the lamp is made of glass, do not apply shock to it and not scratch it.
- * When replacing lamp, turn off and remove AC cord, waite 45 minutes to let lamp cool. High-pressure lamp when hot, may explode if improperly handled.
- * The lamp has a service life. For details, read the user's manual. Please contact your dealer or service company for replacement. Do not use old use old lamp. This could also cause explosion of the lamp.



Be careful in handling the power cord and external connection cables.

If you keep using a damaged the power cord or cables, it can cause a fire or electrical shock. Do not apply too much heat, pressure or tension to the power cord and cables.

If the power cord or cables is damaged (exposed or broken core wires, etc.), contact your dealer.

- * Do not place the projector or heavy objects on the power cord and cables. Also, do not place a spread, cover, etc, over them because this could result in the inadvertent placing of heavy objects on the concealed power cord or cables.
- * Do not pull the power cord and cables. When connecting and disconnecting the power cord or cables, do it with your hand holding the plug or connector.
- * Do not place the cord near the heater.
- * Avoid bending the power cord sharply.
- * Do not attempt to work on the power cord.



Be careful in handling the battery of the remote control transmitter.

Incorrect handling of the battery could result in fire or personal injury. The battery may explode if not handled properly.

- * Keep the battery away from children and pets. If swallowed consult a physician immediately for emergency treatment.
- * Do not allow the battery in a fire or water.
- * Avoid fire or high-temperature environment.
- * Do not hold the battery with the metallic tweezers.
- * Keep the battery in a dark, cool and dry play.
- * Do not short circuit the battery.
- * Do not recharge, disassemble or solder the battery.
- * Do not give the battery a physical impact.
- * Use only the battery specified in the user's manual.
- * Make sure the plus and minus terminals are correctly aligned when loading the battery.
- * If you observe a leakage of the battery, wipe out the flower and then replace the battery. If the flower adheres your body or clothes, rinse well with water.
- * Obey the local laws on disposing the battery.



SAFETY PRECAUTIONS (continued)

CAUTION

Be careful in moving the projector.

Neglect could result in an injury or damage.

* Do not move the projector during use. Before moving, disconnect the power cord and all external connections, and close the slide lens door.

* Avoid any impact or shock to the projector.

* For carrying, use the enclosed carrying bag if provided, depending on the manual of the carrying bag.



ENGLISH

Do not put anything on top of the projector.

Placing anything on the projector could result in loss of balance or falling, and cause an injury or damage. Use special caution in households where children are present.



Avoid a humid or dusty place.

Placing the projector in a highly humid, dusty place, oily soot or corrosive gas could result in fire or electrical shock.

* Do not place near the kitchen, a humidifier or other place where there is oily smoke or humidity.



Avoid a high temperature environment.

The heat could have adverse influence on the cabinet of the projector and other parts. Do not place the projector, the remote control transmitter and other parts in direct sunlight or near a hot object such as heater, etc.



Remove the power cord for complete separation.

* For safety purposes, disconnect the power cord if the projector is not to be used for prolonged periods of time.

* Before cleaning, turn off and unplug the projector. Neglect could result in fire or electrical shock.



Disconnect the plug from the power outlet.

Ask your dealer to cleaning inside of the projector about every two years.

Accumulations of dust inside the projector cause result in fire or malfunction. Cleaning inside is more effective if performed before every humid periods such as rainy season.

* Do not clean inside yourself because it is dangerous.



SAFETY PRECAUTIONS (continued)

NOTE

Do not give the remote control transmitter any physical impact.

A physical impact could cause damage or malfunction of the remote control transmitter.

- * Take care not to drop the remote control transmitter.
- * Do not place the projector or heavy objects on the remote control transmitter.

Take care of the lens.

- * Close the slide lens door to prevent the lens surface being scratched when the projector is not used.
- * Do not touch the lens to prevent fog or dirt of the lens that cause deterioration of display quality.
- * Use commercially available lens tissue to clean the lens (used to clean cameras, eyeglasses, etc.). Be careful not to scratch the lens with hard objects.

Clean the air filter about every 100 hours.

When the air filter becomes clogged with dust, etc., the projector may display the message such as "CHECK THE AIR FLOW" or turn off the projector, to prevent the internal heat level rising. Take care of the air filter to normal ventilate.

- * Do not turn on the projector without air filter.
- * If the air filter is damaged or lost, order the air filter specified in the user's manual to your dealer.

Take care of the cabinet and the remote control transmitter.

Incorrect care could have adverse influence such as discoloration, peeling paint, etc.

- * Use a soft cloth to clean the cabinet and control panel of the projector and the remote control transmitter. When excessively soiled dilute a neutral detergent in water, wet and wring out the soft cloth and afterward wipe with a dry soft cloth. Do not use undiluted detergent directly.
- * Do not use an aerosol sprays, solvents, volatile substances or abrasive cleaner.
- * Before using chemical wipes, be sure to read and observe the instructions.
- * Do not allow long-term close contact with rubber or vinyl.

SAFETY PRECAUTIONS (continued)

NOTE

Avoid strong rays.

Any strong ray (such as direct rays of the sun or room lighting) onto the remote control transmitter sensors could invalidate the remote control transmitter.

Avoid radio interference.

Any interfering radiation could cause disordered image or noises.

* Avoid radio generator such as a mobile telephone, transceiver, etc. around the projector.

About displaying characteristic.

The display condition of the projector (such as color, contrast, etc.) depends on characteristic of the screen, because the projector uses a liquid crystal display panel. The display condition can differ from the display of CRT.

* Do not use a polarized screen. It can cause red image.

Turn the power on/off in right order.

To prevent any trouble, turn on/off the projector in right order mentioned below unless specifying.

* Power on the projector before the computer or video tape recorder.

* Power off the projector after the computer or video tape recorder.

Take care not to fatigue your eyes.

Rest the eyes periodically.

Set the sound volume at a suitable level to avoid bothering other people.

* It is better to keep the volume level low and close the windows at night to protect the neighborhood environment.

Connecting with notebook computer

When connecting with notebook computer, set to valid the RGB external image output (setting CRT display or simultaneous display of LCD and CRT).

Please read instruction manual of the notebook for more information.

USER'S MANUAL

Thank you for purchasing this liquid crystal projector.



WARNING • Please read the accompanying manual “SAFETY INSTRUCTIONS” and this “USER'S MANUAL” thoroughly to ensure correct usage through understanding. After reading, store this instruction manual in a safe place for future reference.

NOTE • The information in this manual is subject to change without notice.

- The manufacturer assumes no responsibility for any errors that may appear in this manual
- The reproduction, transmission or use of this document or contents is not permitted without express written authority.

TRADEMARK ACKNOWLEDGMENT : PS/2, VGA and XGA are registered trademarks of International Business Machines Corporation. Apple, Mac and ADB are registered trademarks of Apple Computer, Inc. VESA and SVGA are trademarks of the Video Electronics Standard Association. Windows is a registered trademark of Microsoft Corporation. Carefully observe the trademarks and registered trademarks of all companies, even when not mentioned.

CONTENTS

	Page		Page
FEATURES	2	TROUBLESHOOTING	20
BEFORE USE	2	OSD Message	20
Contents of Package	2	Indicators Message	21
Part Names.....	3	Symptom	22
Loading the Batteries.....	5	SPECIFICATIONS	23
INSTALLATION	6	WARRANTY AND AFTER-SERVICE	24
Installation of the Projector and Screen.....	6	
Angle Adjustment	6	TABLES	
Cabling	7	Table 1. Installation Reference.....	6
Power Connection	8	Table 2. Cabling	7
Example of System Setup	8	Table 3. Basic Operations	10
Plug & Play	8	Table 4. Setup Menu	12
OPERATIONS	9	Table 5. Input Menu.....	13
Power On.....	9	Table 6. Image Menu.....	14
Power Off	9	Table 7. Options Menu	15
Basic Operation	10	Table 8. No Signal Menu	16
Setup Menu	12	Table 9. OSD Message	20
Input Menu.....	13	Table 10. Indicator Message	21
Image Menu.....	14	Table 11. Symptom	22
Options Menu	15	Table 12. Specifications	23
No Signal Menu	16	
MAINTENANCE	17	For "TECHNICAL" and "REGULATORY NOTICE", see the end of this manual.	
Lamp.....	17		
Air Filter	19		
Other Maintenance	19		

FEATURES

This liquid crystal projector is used to project various computer signals as well as NTSC / PAL / SECAM video signals onto a screen. Little space is required for installation and large images can easily be realized.

Outstanding Brightness

The UHB lamp and high-efficiency optical system assure a high level of brightness.

Partial Magnification Function

Interesting parts of images can be magnified for closer viewing.

Distortion Correction Function

Distortion-free images are quickly available.

BEFORE USE

Contents of package

Make sure all of the following items are included in the package. If anything is missing, please contact your dealer.

NOTE • Keep the original packing material for future reshipment.

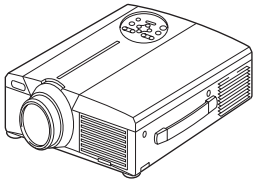

Projector



**Power Cord
(US Type)**



**Power Cord
(UK Type)**

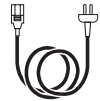

**Power Cord
(Europe Type)**



**User's Manual
(this manual)**

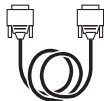

RGB Cable



**Video/Audio Cable
(with white lead)**

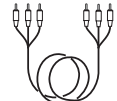

**Component
Video Cable
(with green lead)**



**Safety Instructions
(in this manual)**



**Mouse cable
(PS/2)**



**Batteries
for Remote Control
Transmitter**



**Remote Control
Transmitter**

BEFORE USE (continued)

Part Names

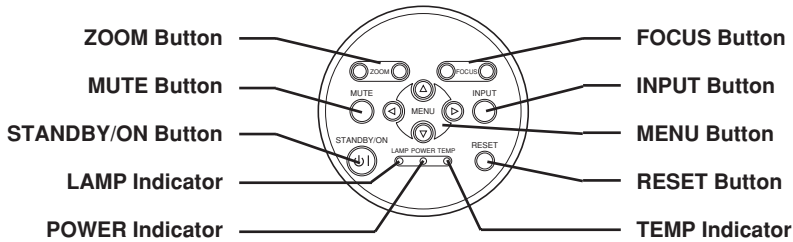

Control Panel
(Refer to P.9 "OPERATIONS")

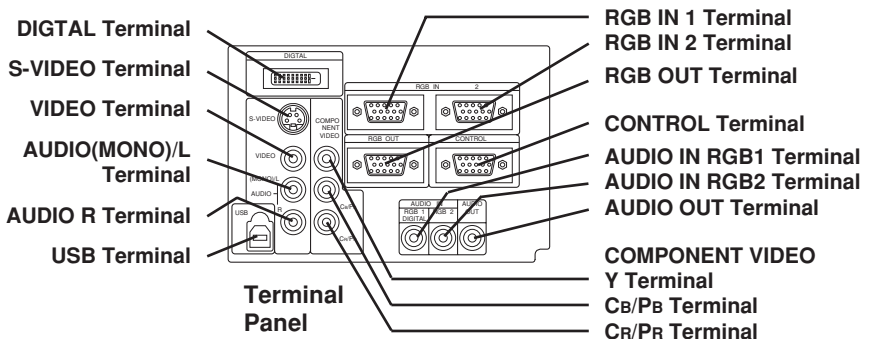
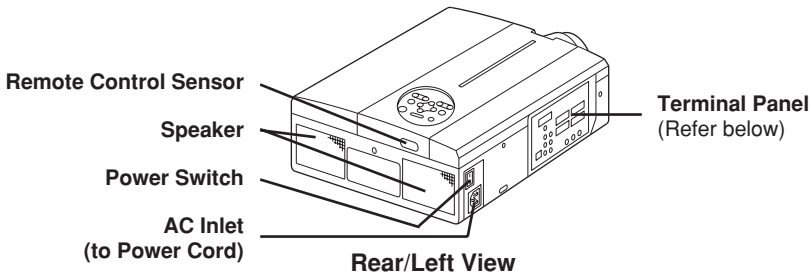
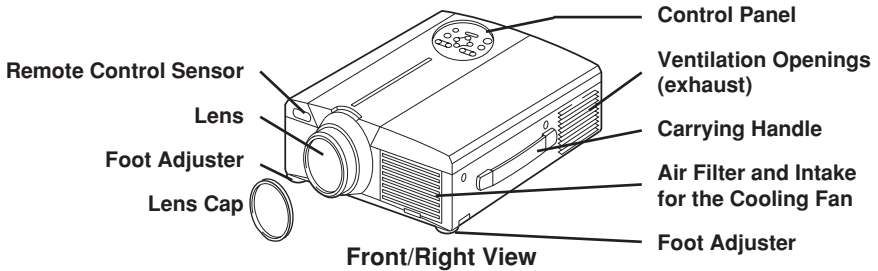

BEFORE USE (continued)

Part Names (continued)

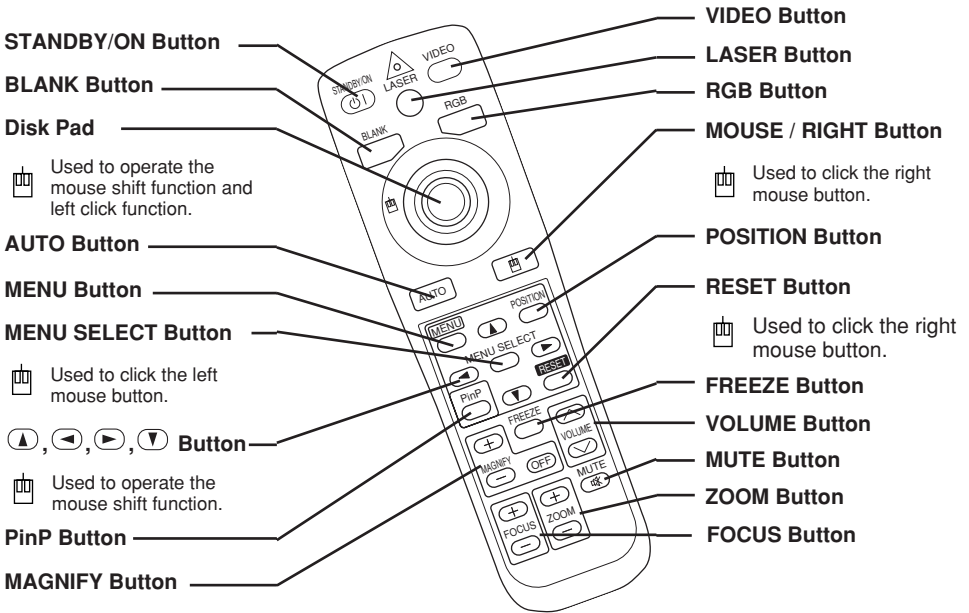

REMOTE CONTROL TRANSMITTER (Refer to P.9 "OPERATIONS")

These functions work when the mouse control function is activated. Remember, the POSITION, BLANK ON and MENU ON functions disable the mouse control function.

WARNING • The laser pointer of the remote control transmitter is used in place of a finger or rod. Never look directly into the laser beam outlet or point the laser beam at other people. The laser beam can cause vision problems.

AVOID EXPOSURE:
LASER RADIATION IS
EMITTED FROM THIS
APERTURE

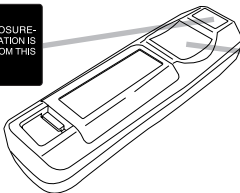

NOTE To prevent any malfunction;

- Do not give the remote control transmitter any physical impact. Take care not to drop.
- Do not place the heavy objects on the remote control transmitter.
- Do not wet the remote control transmitter or place it on any wet object.
- Do not place the remote control transmitter close to the cooling fan of the projector.
- Do not disassemble the remote control transmitter in case of malfunction. Please bring it to the service station.

BEFORE USE (continued)

Loading the Batteries

Install the AA batteries into the remote control transmitter.

1. Remove the battery cover.
Push the knob while lifting up the battery cover.
2. Load the batteries.
Make sure the plus and minus poles are correctly oriented.
3. Close the battery cover.

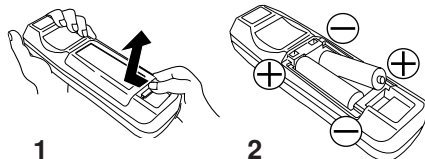

CAUTION • Use only the specified batteries with this remote control transmitter. Also, do not mix new and old batteries. This could cause in battery cracking or leakage, which could result in fire or personal injury.

- When loading the batteries, make sure the plus and minus terminals are correctly oriented as indicated in the remote control transmitter. Incorrect orientation could cause battery cracking or leakage, which could result in personal injury or pollution of the surrounding environment.
- When you dispose the battery, you obey the law in the relative area or country.
- Keep the battery away from children and pets.
- When not to be used for an extended period, remove the batteries from the remote control transmitter.

NOTE

Replace the batteries when remote control transmitter operation becomes difficult.

INSTALLATION

Installation of the Projector and Screen

Refer to the drawing and table below for determining of the screen size and projection distance.

The projection distances shown in the table below are for full size (1024 x 768 dots).

a: Distance from the projector to the screen. ($\pm 10\%$)

b: Distance from the lens center to the bottom of the screen. ($\pm 10\%$)

Table 1. Installation Reference

Screen size [inches (m)]	a [inches (m)]		b [inches (cm)]
	Min.	Max.	
40 (1.0)	55 (1.4)	73 (1.9)	1 (3)
60 (1.5)	85 (2.2)	114 (2.9)	2 (4)
80 (2.0)	114 (2.9)	151 (3.8)	2 (6)
100 (2.5)	144 (3.7)	191 (4.9)	3 (7)
120 (3.0)	176 (4.5)	231 (5.9)	3 (9)
150 (3.8)	220 (5.6)	282 (7.2)	4 (11)
200 (5.0)	291 (7.4)	386 (9.8)	6 (15)

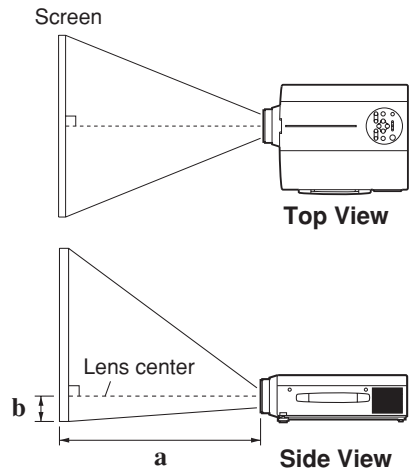

CAUTION • Install the projector in a suitable environment according to instructions of the accompanying manual “SAFETY INSTRUCTIONS” and this manual.

- Please basically use liquid crystal projector at the horizontal position. If you use liquid crystal projector by the lens up position, the lens down position and the side up position, this may cause the heat inside to build up and become the cause of damage. Be especially careful not to install it with ventilation holes blocked.
- Do not install LCD projector in smoke effected environment. Smoke residue may buildup on critical parts (i.e.LCD panel, Lens Assy etc.).

Angle Adjustment

Use the foot adjusters on the bottom of the projector to adjust the projection angle. It is variable within 0° to 9° approximately.

1. Lift up the front side of the projector, and pressing the foot adjuster button, adjust the projection angle.
2. Release the button to lock at the angle to be fixed.
3. Make the foot adjusters screw for fine adjustment. Do not force the adjusters to make screw. This could damage the adjusters or cause the lock to fail.

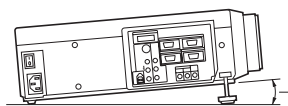
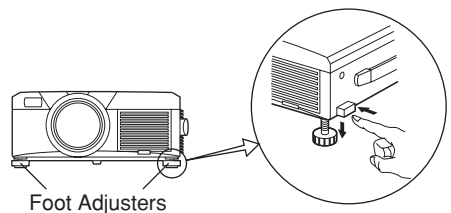

Variable within the range of approximately 0° - 9°



CAUTION • Do not release the foot adjuster button unless the projector is being held; otherwise, the projector could overturn or the fingers could get caught and cause personal injury.

INSTALLATION (continued)

Cabling

Refer to the table below for connecting each terminal of the projector to each device.

Table 2. Cabling

Function	Terminal	Cable
Analog RGB input	RGB IN 1	Accessory RGB cable or optional RGB cable with D-sub 15-pin shrink jack and inch thread screws
	RGB IN 2	
Analog RGB output	RGB OUT	
Digital RGB input	DIGITAL	Optional digital RGB cable with inch thread screws
Audio input (from the computer)	AUDIO IN [RGB 1] / [DIGITAL] (interlocked with RGB IN 1 or DIGITAL)	Optional audio cable with stereo mini jack
	AUDIO IN [RGB 2] (interlocked with RGB IN 2)	
PS/2 mouse control	CONTROL	Accessory PS/2 mouse cable
ADB mouse control		Optional ADB mouse cable
Serial mouse control		Optional Serial mouse cable
RS-232C communication		Optional RS-232C cable
USB mouse control	USB	Optional USB cable
S-video input	S-VIDEO	Optional S-video cable with mini DIN 4-pin jack
Video input	VIDEO	Accessory video/audio cable
Component video input	COMPONENT VIDEO Y	Accessory component video cable
	COMPONENT VIDEO Cb/Pb	
	COMPONENT VIDEO Cr/Pr	
Audio input (from video equipment)	AUDIO (MONO)/L	Accessory video/audio cable or optional audio cable with RCA jack
	AUDIO R	
Audio output	AUDIO OUT	Optional audio cable with stereo mini jack



CAUTION • Incorrect connecting could result in fire or electrical shock.

Please read this manual and the separate "SAFETY INSTRUCTIONS".

- Before connecting, turn off to all devices to be connected, except for the USB cable.
- The cables may have to be used with the core set to the projector side. Use the cables which are included with the projector or specified.

NOTE • Before connecting, read instruction manuals of the devices to be connected, and make sure that the projector is compatible with the device.

- Secure the screws on the connectors and tighten.
- For some RGB input modes, the optional Mac adapter is necessary.
- To select the digital RGB input, the computer may need some settings. See the manuals of the computer for details.
- Some computers may have multiple display screen modes. Use of some of these modes will not be possible with this projector.
- Refer to the "TECNICAL" section for the pin assign of connectors and RS-232C communication data.
- When the DIGITAL terminal is used, the RGB OUT terminal may not function.

INSTALLATION (continued)

Power Connection

Use the correct one of the enclosed power cords depending on the power outlet to be used. Connect the AC inlet of the projector to the power outlet firmly by the power cord.

- CAUTION** • Be careful in handling the power cord according to instructions of the accompanying manual "SAFETY INSTRUCTIONS" and this manual.
- Connect the power cord firmly. Avoid using a loose, unsound outlet or contact failure.

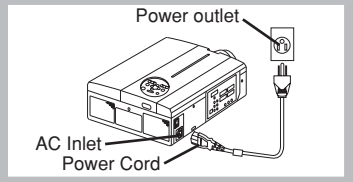

Example of system setup

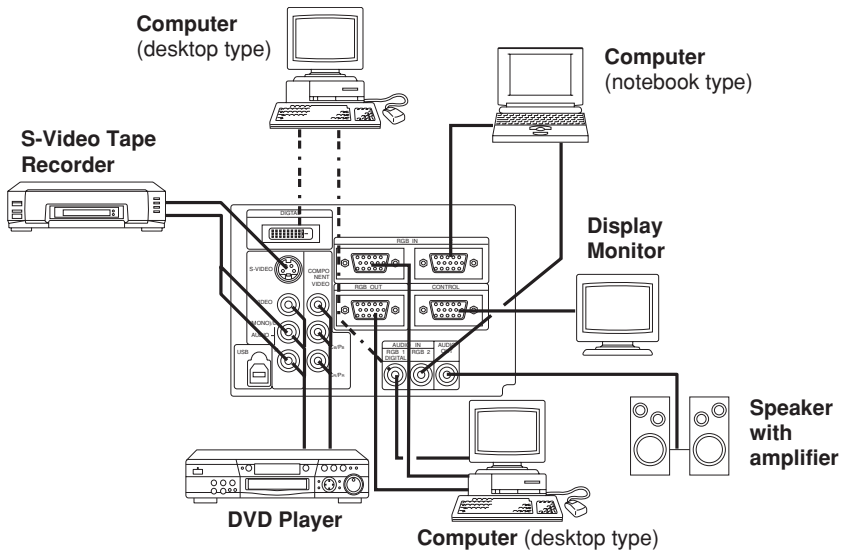

NOTE • When connecting with notebook computer, set to valid the RGB external image output (setting CRT display or simultaneous display of LCD and CRT). Please read instruction manual of the notebook for more information.

Plug & Play

This projector is VESA DDC 1/2B compatible. Plug & play is possible by connecting to a computer that is VESA DDC (Display Data Channel) compatible.

Please use this function by connecting the accessory RGB cable with RGB IN 1 terminal (DDC 1/2B compatible), or by connecting an optional digital RGB cable with DIGITAL terminal (DDC 2B compatible). Plug & play may not operate by other connecting.

NOTE • Plug & play is a system configured with peripheral equipment including a computer and display, and an operating system.

- This projector is recognized as a plug & play monitor. Use the standard display drivers.
- Plug & play may not operate by the computer to connect. Plug & play will not operate in the connection with Apple computer.

OPERATIONS

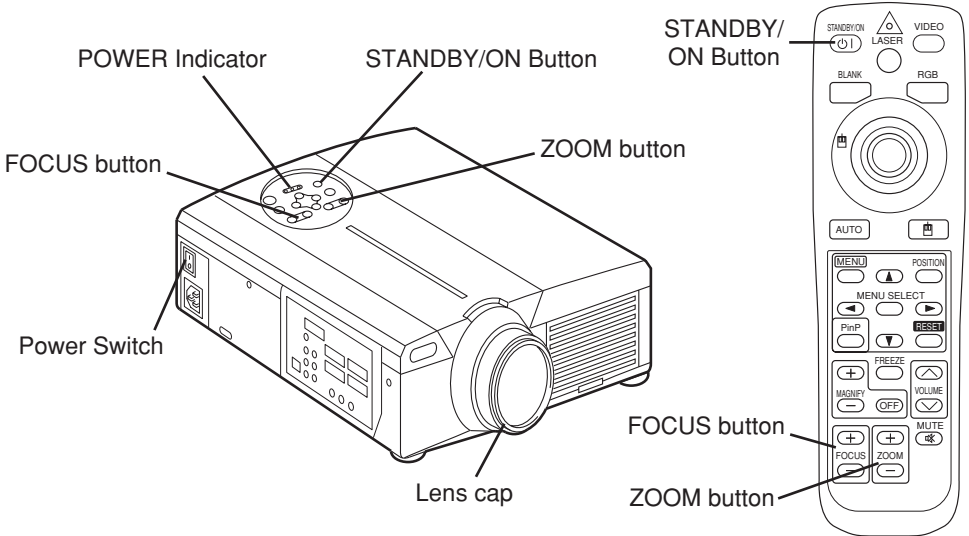

ENGLISH

Power ON

1. Check that the power cord is connected correctly.
2. Set the power switch to [I]. The standby mode is selected, and the POWER indicator is turned to orange.
3. Press the STANDBY/ON button (Ⓜ) on the control panel or the remote control transmitter. Warm-up begins and the POWER indicator blinks in green.
4. The POWER indicator ceases blinking and turns to green when power is on. Remove the lens cap.
5. Adjust picture size using the ZOOM button.
6. Adjust focus using the FOCUS button .

Power OFF

1. Press the STANDBY/ON button (Ⓜ) on the control panel or the remote control transmitter for approximately two second. The projector lamp is extinguished and lamp cooling begins. The POWER indicator blinks orange during lamp cooling. Pressing the STANDBY/ON button (Ⓜ) has no effect while the POWER indicator is blinking.
2. The system assumes the Standby mode when cooling is complete, and the POWER indicator ceases blinking and changes to orange. Check that the indicator is orange and set the Power switch to [O].
3. The POWER indicator is extinguished when power is off. Attach the lens cap.

WARNING • Please read this manual, and the separate “SAFETY INSTRUCTIONS” thoroughly before using the equipment. Always ensure that the equipment is used safely.

- NOTE** • Except in emergencies, do not turn off unless the POWER indicator is orange as it will reduce the life of the projector lamp.
- To prevent any trouble, turn on/off the projector when the computer or video tape recorder is OFF. Providing a RS-232C cable is connected, turn on the computer before the projector.

OPERATIONS (continued)

Basic Operation

The basic operations shown in Table 3 is performed from the supplied remote control transmitter or the projector control panel. Items indicated by (*) may be used from the control panel.

Table 3 . Basic Operation

Item	Description
INPUT SELECT	<p>Select Input Signal (*) : Press the INPUT button. RGB IN 1 → RGB IN 2 → DIGITAL → VIDEO → S-VIDEO → COMPONENT VIDEO (→ RGB IN 1)</p> <p>Select RGB Input : Press the RGB button. VIDEO/S-VIDEO/COMPONENT VIDEO → RGB IN 1/RGB IN 2/DIGITAL RGB IN 1 → RGB IN 2 → DIGITAL (→ RGB IN 1)</p> <p>Select Video Input : Press the VIDEO button. RGB IN 1/RGB IN 2/DIGITAL → VIDEO/S-VIDEO/COMPONENT VIDEO VIDEO → S-VIDEO → COMPONENT VIDEO (→ VIDEO)</p> <ul style="list-style-type: none"> • The selected signal name is displayed for approximately 3 seconds when the input signal is changed.
POSITION	<p>Set/Clear Position Adjustment Mode : Press the POSITION button. The [] icon is displayed in the POSITION mode.</p> <p>Image Position Adjustment: Press the (←), (→), (▲) and (▼) buttons in the POSITION mode.</p> <ul style="list-style-type: none"> • Valid only in the MAGNIFY mode with a video signal is input. • After approximately 10 seconds of inactivity the [] icon is extinguished and the POSITION mode is cleared automatically. • (←), (→), (▲) and (▼) buttons may operate as the mouse control button. Refer to page 4.
RESET (*)	<p>Initialise Each Item : Select an item and press the RESET button.</p> <p>Initialise Position Adjustment : Press the RESET button and the POSITION mode. This function is valid only when RGB signal is input.</p> <ul style="list-style-type: none"> • Valid except for the VOLUME, LANGUAGE and H PHASE. • The RESET button may operate as the mouse control button. Refer to page 4.
MAGNIFY	<p>Set MAGNIFY Mode : Press the MAGNIFY ⊕ button.</p> <p>Move Magnified Area : Run the POSITION in the MAGNIFY mode.</p> <p>Adjust Magnification : Press the MAGNIFY ⊕ / ⊖ button in MAGNIFY mode.</p> <p>Clear MAGNIFY Mode : Press the MAGNIFY ⊖ button.</p> <ul style="list-style-type: none"> • The MAGNIFY mode is cleared by running or setting the AUTO, ASPECT, INPUT SELECT or VIDEO, or by changing the input signal.
FREEZE	<p>Set/Clear FREEZE Mode : Press the FREEZE button. The [] icon is displayed, and the image frozen, in the FREEZE mode.</p> <ul style="list-style-type: none"> • The FREEZE mode is cleared by running or setting POSITION, VOLUME, MUTE, Automatic Adjustment, BLANK ON/OFF, or MENU ON/OFF, or by changing the input signal. • Do not forget to clear frozen static images.

NOTE • Use the remote control transmitter at a distance of approximately 5m from the sensor on the front of the projector, and within a range of 30° left-right. Strong light and obstacles will interfere with operation of the remote control transmitter.

OPERATIONS (continued)

Items indicated by (*) may be used from the control panel.

Table 3. Basic Operation (continued)

Item	Description
VOLUME	Volume Adjustment : Press the VOLUME ⊖ / ⊕ button.
MUTE (*)	Set/Clear Mute Mode : Press the MUTE button. No sound is heard in the MUTE mode.
AUTO	<p>Automatic Adjustment at RGB Input : Press the AUTO button. Horizontal position(H.POSIT), vertical position (V.POSIT),clock phase (H.PHASE), and horizontal size(H.SIZE) are automatically adjusted. Use with the window at maximum size in the application display.</p> <p>Automatic Adjustment at Video Input : Press the AUTO button. A signal type appropriate for the input signal is selected automatically. Valid only when AUTO is set for VIDEO on the menu.</p> <ul style="list-style-type: none"> • This operation requires approximately ten seconds. It may not function correctly with some input signals.
BLANK ON/OFF	Set/Clear Blank Mode: Press the BLANK button. No image is displayed in the Blank mode. The screen color is as set in BLANK on the Image menu.
MENU ON/OFF (*)	<p>Menu Display Start/Stop: Press the MENU button.</p> <ul style="list-style-type: none"> • The menu display is terminated automatically after approximately ten seconds of inactivity.
MENU SELECT	<p>Select Menu Type: Press the MENU SELECT button. Allows the user to select the normal menu or the single menu. Only the selected item is displayed on the single menu, and other items are displayed with the ⬅ and ➡ buttons as with the normal menu.</p> <ul style="list-style-type: none"> • Valid only when the Setup menu is used. Push the MENU SELECT button after selecting items such as "BRIGHTNESS". • The MENU SELECT button may operate as the mouse control button. Refer to page 4. <div style="text-align: center;"> <p>Normal menu (MENU SELECT) Single menu</p> </div>
P.IN P. MODE	<p>Select Mode of P.IN P. Display : Press the PinP button.</p> <p>Small → Large → P.IN P. off (→ Small)</p> <ul style="list-style-type: none"> • Valid only at RGB IN 1, RGB IN 2 or DIGITAL input.
ZOOM	Adjust Screen Size : Press the ZOOM ⊕ / ⊖ button.
FOCUS	Adjust Focus : Press the FOCUS ⊕ / ⊖ button.

OPERATIONS (continued)

Setup Menu

The following adjustments and settings are possible when SETUP is selected at the top of the menu. Part of the Setup menu differs between RGB input and video input. Select an item with the \blacktriangle and \blacktriangledown buttons, and start operation. Use the Single menu to reduce menu size (see Table 3, MENU SELECT).

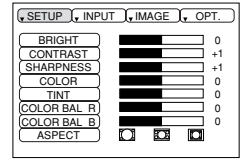
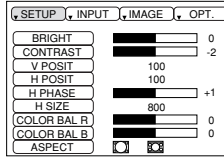

Table 4. Setup Menu

Item	Description	VIDEO S-VIDEO COMPONENT VIDEO		
		RGB IN 1 RGB IN 2 DIGITAL	DIGITAL	VIDEO S-VIDEO COMPONENT
BRIGHT	Adjustment: Dark \blacktriangle \leftrightarrow Light \blacktriangledown	✓	✓	✓
CONTRAST	Adjustment: Weak \blacktriangle \leftrightarrow Strong \blacktriangledown	✓	✓	✓
V POSIT	Adjustment: Down \blacktriangle \leftrightarrow Up \blacktriangledown	✓	-	-
H POSIT	Adjustment: Left \blacktriangle \leftrightarrow Right \blacktriangledown	✓	-	-
H PHASE	Adjustment: Left \blacktriangle \leftrightarrow Right \blacktriangledown • Adjust to eliminate flicker.	✓	-	-
H SIZE	Adjustment: Small \blacktriangle \leftrightarrow Large \blacktriangledown • The image may not be displayed correctly if the horizontal size is excessive. In such cases, press the RESET button, and initialize the horizontal size.	✓	-	-
SHARPNESS	Adjustment: Soft \blacktriangle \leftrightarrow Clear \blacktriangledown	-	-	✓
COLOR	Adjustment: Light \blacktriangle \leftrightarrow Dark \blacktriangledown	-	-	✓
TINT	Adjustment: Red \blacktriangle \leftrightarrow Green \blacktriangledown • Valid only when NTSC or NTSC 4.43 signal is received.	-	-	✓
COLOR BAL R	Adjustment: Light \blacktriangle \leftrightarrow Dark \blacktriangledown	✓	✓	✓
COLOR BAL B	Adjustment: Light \blacktriangle \leftrightarrow Dark \blacktriangledown	✓	✓	✓
ASPECT	Select Image Aspect Ratio : 4:3[] \blacktriangle \leftrightarrow \blacktriangledown 16:9[] Select Position of Image: Press the \blacktriangledown button while 16:9[] is selected. Center \rightarrow \blacktriangledown Down \rightarrow \blacktriangledown Up (\rightarrow Center \blacktriangledown)	✓	✓	-
	Select Image Aspect Ratio: 4:3[] \blacktriangle \leftrightarrow \blacktriangledown 16:9[] \blacktriangle \leftrightarrow \blacktriangledown 4:3 small[] Select Position of Image : Press the \blacktriangledown button while 16:9[] / 4:3 small[] is selected. Center \rightarrow \blacktriangledown Down \rightarrow \blacktriangledown Up (\rightarrow Center \blacktriangledown) • 4:3 small may not be displayed correctly with some input signals.	-	-	✓

OPERATIONS (continued)

Input Menu

The following functions are available when INPUT is selected on the menu. Select an item with the **▲** and **▼** buttons, and start or stop operation with the **▶** and **◀** buttons. The function indicated (**) are effective on video input mode only, not on RGB input mode, except in the P.IN P. window on RGB input mode.

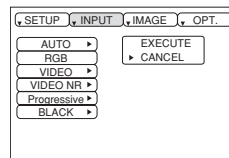

Table 5. Input Menu

Item	Description
AUTO	<p>Automatic Adjustment at RGB Input: Select the EXECUTE with the ▶ button. Horizontal position (H.POSIT), vertical position (V.POSIT), clock phase (H.PHASE), and horizontal size (H.SIZE) are automatically adjusted. Use with the window at maximum size in the application display.</p> <p>Automatic Adjustment at Video Input: Select the EXECUTE with the ▶ button. A signal type appropriate for the input signal is selected automatically when EXECUTE is selected automatically. Valid only when AUTO is set for VIDEO on the menu.</p> <ul style="list-style-type: none"> • This operation requires approximately 10 seconds. It may not function correctly with some input signals. Pressing the AUTO button in this case may correct this problem. • This function is the same as for the AUTO function in Basic operation.
RGB	<p>Displays RGB Input Frequency: Displays the horizontal and vertical sync signal frequencies for RGB input.</p> <ul style="list-style-type: none"> • Valid only at RGB input.
VIDEO (**)	<p>Select Video Signal Type: Select the signal type with the ▲ and ▼ buttons. Select NTSC, PAL, SECAM, NTSC4.43, M-PAL, or N-PAL as appropriate for the input signal. The selection of AUTO enables and executes the function AUTO (Automatic Adjustment at Video Input), except for the N-PAL input.</p> <ul style="list-style-type: none"> • Use this function when the image becomes unstable (eg. the image becomes irregular, or lacks color) at VIDEO/S-VIDEO input. • Automatic Adjustment requires approximately ten seconds. It may not function correctly with some input signals. Pressing the AUTO button in this case may correct this problem except for the N-PAL input. • For the COMPONENT VIDEO input, this function is not effective and the signal type is distinguished automatically. Refer to the item HDTV of the OPT. Menu for the signal of HDTV.
VIDEO NR (**)	<p>Set/Clear Noise Reduction Mode: Select the TURN ON / TURN OFF with the ▶/◀ button. When the TURN ON is selected, the NR mode is active and the noise on screen of the video input will be reduced.</p>
Progressive (**)	<p>Select Progressive Mode: Select the mode suitable for the input signal with the ▲ and ▼ buttons. The TV mode and the CINEMA mode convert the interlaced video signal into the progressive signal. The CINEMA mode is adaptable 2-3 Pull-Down system to the conversion.</p> <ul style="list-style-type: none"> • Use this function to raise resolution, at the interlaced video input except HDTV signal.
BLACK(**)	<p>Set/Clear Black Enhancement Mode: Select the TURN ON / TURN OFF with the ▶/◀ button. When the TURN ON is selected, the black enhancement mode is active and the contrast ratio of the screen for the video input will be raised by making black level darker.</p>

OPERATIONS (continued)

Image Menu

The following adjustments and settings are available when IMAGE is selected on the menu. Select an item with the \blacktriangle and \blacktriangledown buttons, and start operation.

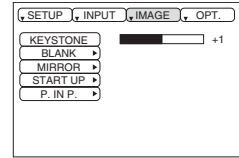

Table 6. Image Menu

Item	Description
KEYSTONE	<p>Keystone Adjustment: Reduce size of bottom of image \blacktriangle \leftrightarrow Reduce size of top of image \blacktriangledown • When this function is activated, the image may not be displayed correctly with some input signals.</p>
BLANK	<p>Select Blank Screen Color: Select color with the \blacktriangle and \blacktriangledown buttons. • The image is cleared when the BLANK mode is set with BLANK ON, or when there is no signal, and the entire screen is displayed in the selected color.</p>
MIRROR	<p>Operation Start/Stop: Press the \blacktriangle or \blacktriangledown button. Select Mirror Status: Select mirror status with \blacktriangle and \blacktriangledown buttons.</p>
START UP	<p>Operation Start/Stop: Press the \blacktriangle or \blacktriangledown button. Setup Initial Screen Display: Select TURN ON with the \blacktriangle button. Clear Initial Screen Display: Select TURN OFF with the \blacktriangledown button. • Note that if TURN OFF is selected the blank screen is displayed in blue when there is no signal.</p>
P. IN P.	<p>Operation Start/Stop: Press the \blacktriangle or \blacktriangledown button. Select Position of P. in P. Display : Press the \blacktriangle or \blacktriangledown button. \blacksquare \blacktriangle \leftrightarrow \blacktriangledown \blacksquare \blacktriangle \leftrightarrow \blacktriangledown \blacksquare \blacktriangle \leftrightarrow \blacktriangledown \blacksquare (\blacktriangle \leftrightarrow \blacktriangledown \blacksquare) • Valid only at RGB IN 1, RGB IN 2 or DIGITAL input.</p>

OPERATIONS (continued)

Options Menu

The following adjustments and settings are available when OPT. is selected on the menu. Select an item with the **▲** and **▼** buttons, and start operation. The function indicated (**) are effective on video input mode only, not on RGB input mode, except in the P.IN P. window on RGB input mode.

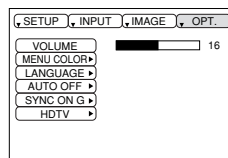

Table 7. Options Menu

Item	Description
VOLUME	Volume Adjustment: Reduce VOLUME ◀ ↔ Increase VOLUME ▶
MENU COLOR	Select Menu Background Color: Select with the ▶ and ◀ buttons.
LANGUAGE	Operation Start/Stop: Press the ▶ or ◀ button. Select Menu Display Language: Select with the ▲ and ▼ buttons.
AUTO OFF	Operation Start/Stop: Press the ▶ or ◀ button. Set AUTO OFF: Set 1~99 minutes with the ▲ and ▼ buttons. The system automatically enters the standby mode when a signal is not received for the set time. Clear AUTO OFF: Select STOP (0 min.) with the ▼ button. When STOP is selected the system does not enter the standby mode even if no signal is received.
SYNC ON G	Operation Start/Stop: Press the ▶ or ◀ button. SYNC ON G Valid: Select TURN ON with the ▲ button. SYNC ON G Invalid: Select TURN OFF with the ▼ button. • May not be displayed correctly with some input signals when SYNC ON G is valid. In such cases, remove the signal connector so that no signal is received, set SYNC ON G to invalid, and reconnect the signal.
HDTV (**)	Select HDTV mode: Select the 1035i mode or 1080i mode suitable for the input signal with the ▲ / ▼ button.

OPERATIONS (continued)

No Signal Menu

The same adjustments and settings are available as with the Image and Options menus when the MENU button is pressed during display of the “NO INPUT IS DETECTED ON ***” or “SYNC IS OUT OF RANGE ON ***” message while no signal is received.

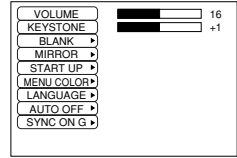

Table 8. No Signal Menu

Item	Description
VOLUME	<p>Volume Adjustment: Reduce VOLUME ◀ ↔ Increase VOLUME ▶</p> <ul style="list-style-type: none"> When this function is used, audio input is automatically switched to video. The audio input can be switched by moving the DISK PAD left and right during the display of the volume adjustment bar. The volume adjustment bar is displayed by pressing VOLUME ▶ or VOLUME ◀ button.
KEYSTONE	<p>Keystone Adjustment: Reduce the size of bottom of image ◀ ↔ Reduce the size of top of image ▶</p>
BLANK	<p>Select Blank Screen Color: Select the color with the ◀ and ▶ buttons.</p> <ul style="list-style-type: none"> When the blank mode is set with BLANK ON, by absence of a signal, or by input of a non-standard signal, the image is cleared and the complete screen is displayed in the selected color.
MIRROR	<p>Operation Start/Stop: Press the ▶ or ◀ button. Select Mirror Status: Select the mirror status with the ▲ and ▼ buttons.</p>
START UP	<p>Operation Start/Stop: Press the ▶ or ◀ button. Setup Initial Screen Display: Select the TURN ON with the ▲ button. Clear Initial Screen Display: Select the TURN OFF with the ▼ button.</p> <ul style="list-style-type: none"> Note that if TURN OFF is selected the blank screen is displayed in blue when there is no signal.
MENU COLOR	<p>Select Menu Background Color: Select the color with the ▶ and ◀ buttons.</p>
LANGUAGE	<p>Operation Start/Stop: Press the ▶ or ◀ button. Select Menu Display Language: Select the language with the ▲ and ▼ buttons.</p>
AUTO OFF	<p>Operation start/stop: Press the ◀ or ▶ button. Set AUTO OFF: Set 1~99 minutes with the ▲ and ▼ buttons. The system automatically enters the standby mode when a signal is not received for the set time. Clear AUTO OFF: Select the STOP (0 min.) with the ▼ button. When the STOP is selected the system does not enter the standby mode even if no signal is received.</p>
SYNC ON G	<p>Operation Start/Stop: Press the ▶ or ◀ button. SYNC ON G Valid: Select the TURN ON with the ▲ button. SYNC ON G Invalid: Select the TURN OFF with the ▼ button.</p> <ul style="list-style-type: none"> May not be displayed correctly with some input signals when the SYNC ON G is valid. In such cases, remove the signal connector so that no signal is received, set the SYNC ON G to invalid, and reconnect the signal.

MAINTENANCE

Lamp



**HIGH VOLTAGE
HIGH TEMPERATURE
HIGH PRESSURE**

Contact your dealer before replacing the lamp.

For the optional lamp, see the item “Option Parts” of the Table 12.

Before replacing the lamp, switch power OFF, remove the power cord from the power outlet, and wait approximately 45 minutes until the lamp has cooled. The lamp may explode if handled at high temperatures.



WARNING • For disposal of used lamp, treat according to the instruction of community authorities.

- Since the lamp is made of glass, do not apply shock to it and do not scratch it.
- Also, do not use old lamp. This could also cause explosion of the lamp.
- If it is probable that the lamp has exploded (explosive sound is heard), disconnect the power plug from the power outlet and ask your dealer to replace lamp. The lamp is covered by front glass, but, in rare cases, the reflector and the inside of the projector may be damaged by scattered broken pieces of glass, and broken pieces could cause injury when being handled.
- Do not use the projector with the lamp cover removed.

Lamp

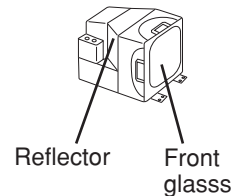

Lamp Life

Projector lamps have a finite life. The image will become darker, and hues will become weaker, after a lamp has been used for a long period of time.

Replace the lamp if the LAMP indicator is red, or the CHANGE THE LAMP message appears when the projector is switched ON. See Table 9 of P.20 and Table 10 of P.21.

NOTE • The LAMP indicator is also red when the lamp unit reaches high temperature. Before replacing the lamp, switch power OFF, wait approximately 20 minutes, and switch power ON again. If the LAMP indicator is still red, replace the lamp.

MAINTENANCE (continued)

Replacing the Lamp

1. Switch the projector OFF, remove the power cord from the power outlet, and wait at least 45 minutes for the unit to cool.
2. Prepare a new lamp.
3. Check that the projector has cooled sufficiently, and gently turn it upside down.
4. Loosen the screw as shown in the diagram, and remove the lamp cover.
5. Loosen the two screws, and gently remove the lamp while holding the grips. Touching the inside of the lamp case may result in uneven coloring.
6. Install the new lamp and tighten the two screws firmly. Also steadily push the opposite side of the screwed lamp into the unit.
7. Replace the lamp cover in position and tighten the screw firmly.
8. Gently turn the projector right-side up.

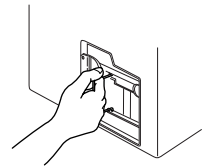
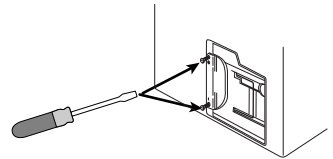
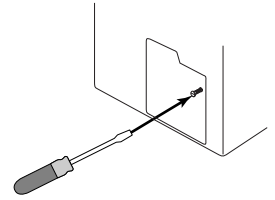

CAUTION • Ensure that screws are tightened properly. Screws not tightened fully may result in injury or accidents.
• Do not use the projector with the lamp cover removed.

Resetting the Lamp Timer

Reset the lamp timer after replacing the lamp. When the lamp has been replaced after the LAMP indicator is red, or the CHANGE THE LAMP message is displayed, complete the following operation within ten minutes of switching power ON. The power will be turned off automatically in over 10 minutes.

1. Switch power ON, and press the RESET button, for approximately three seconds. The 'LAMP xxxx hr' message will appear on the lamp timer on the bottom of the screen.
2. Press the MENU button on the remote control transmitter, or the RESET button on the control panel, while the lamp timer is displayed. The 'LAMP xxxx □ → 0 ■ CANCEL' message will then appear.
3. Press the  and select 0, and wait until the timer display is cleared.

NOTE • Do not reset the lamp timer without replacing the lamp. Reset the lamp timer always when replacing the lamp. The message functions will not operate properly if the lamp timer is not reset correctly.

MAINTENANCE (continued)

Air Filter Maintenance

The air filter should be cleaned as described below at intervals of approximately 100 hours.

1. Switch the projector power supply OFF, and remove the power cord from the power outlet.
2. Clean the air filter with a vacuum cleaner.

⚠ CAUTION • Switch power OFF and remove the power cord from the power outlet before beginning maintenance work. Please read the separate “SAFETY INSTRUCTIONS” thoroughly to ensure that maintenance is performed correctly.

- Replace the air filter if contamination cannot be removed, or if it is damaged. Contact your dealer in such case. For the optional air filter, see the item “Option Parts” of the Table 12.
- Do not use the equipment with the air filter removed.
- When the air filter is clogged with dust etc. the power supply is switched OFF automatically to prevent the temperature rising inside the projector.

Other Maintenance

Maintenance Inside the Equipment

For safety reasons, ensure that the equipment is cleaned and checked by the dealer once every two years. Maintaining the equipment by yourself is dangerous.

Cleaning the Lens

Gently wipe the lens with lens cleaning paper. Do not touch the lens with your hands.

Cleaning the Cabinet and Remote control transmitter

Gently wipe with a soft cloth. If dirt and stains etc. are not easily removed, use a soft cloth dampened with water, or water and a neutral detergent, and wipe dry with a soft, dry cloth.

⚠ CAUTION • Switch power OFF and remove the power cord from the power outlet before beginning maintenance work. Please read the separate “SAFETY INSTRUCTIONS” thoroughly to ensure that maintenance is performed correctly.

- Do not use detergents or chemicals other than those noted above (e.g. benzene or thinners).
- Do not use cleaning sprays.
- Do not rub with hard materials, or tap the equipment.

TROUBLESHOOTING

OSD Message

The messages as described below may appear on the screen at power ON. Take the appropriate measures when such a message appears.

Table 9. OSD Messages

Message	Contents
CHANGE THE LAMP AFTER REPLACING LAMP, RESET THE LAMP TIME. *1)	The message shown at left appears after the lamp has been used for more than 1300 hours. The lamp is approaching the end of its life. Power is switched OFF automatically when the lamp reaches the end of its life. Prepare a new lamp for installation. Always reset the lamp timer after replacing the lamp.
CHANGE THE LAMP AFTER REPLACING LAMP, RESET THE LAMP TIME. THE POWER WILL TURN OFF AFTER ** hr. *1)	The lamp will reach the end of its life in ** hours. Power will be switched OFF automatically in ** hours. Replace the lamp as shown in P.17~18 "Lamp". Always reset the lamp timer after replacing the lamp.
CHANGE THE LAMP AFTER REPLACING LAMP, RESET THE LAMP TIME. THE POWER WILL TURN OFF AFTER 0 hr.	The lamp has reached the end of its life. Power will be switched OFF in a few minutes. Switch power OFF immediately and replace the lamp as shown in P.17~18 "Lamp". Always reset the lamp timer after replacing the lamp.
NO INPUT IS DETECTED ON ***	No input signal found. Check signal input connections and signal sources.
SYNC IS OUT OF RANGE ON ***	The horizontal or vertical frequency of the input signal is not within the specified range. Check the specifications of the equipment and the signal source.

NOTE *1) This message is cleared automatically after approximately three minutes, and appears every time power is switched ON.

TROUBLESHOOTING (continued)

Indicators Message

The POWER indicator, LAMP indicator, and TEMP indicator are lit and blank as follows. Take the appropriate measures.

Table 10. Indicators Message

POWER indicator	LAMP indicator	TEMP indicator	Contents
Lights orange	Turns off	Turns off	The Standby mode has been set.
Blinks green	Turns off	Turns off	Warming up. Please wait.
Lights green	Turns off	Turns off	ON. Normal operation possible.
Blinks orange	Turns off	Turns off	Cooling. Please wait.
Lights red	Lights red	Turns off	Lamp is not lit. The interior of the equipment may be too hot. Switch power OFF, wait 20 minutes until the equipment cools, and check whether the ventilation openings are blocked, whether the air filter is dirty, or whether the ambient temperature exceeds 35 °C. And switch power ON again. Replace the lamp if the same problem occurs.
Lights red	Blinks red	Turns off	Lamp or lamp cover is not found, or hasn't been fitted in correctly. Switch power OFF, and wait for 45 minutes until the equipment cools. Check fitting of the lamp and lamp cover, and switch power ON again. Contact your dealer if the same problem occurs again.
Lights red	Turns off	Blinks red	The cooling fan is not operating. Switch power OFF, and wait for 20 minutes until the equipment cools. Check for foreign matters in the fan, and switch power ON again. Contact your dealer if the same problem occurs again.



NOTE *1) When the internal temperature becomes excessive power is switched OFF automatically for safety reasons, and the indicator is extinguished. Set the power switch to [O] and wait for 20 minutes until the equipment has cooled sufficiently.

TROUBLESHOOTING (continued)

Symptom

Before requesting repair, check in accordance with the following chart. If the situation cannot be corrected, then contact your dealer.

Table 11. Symptom

Symptom	Possible cause	Remedy	Page
The power is not turned on.	The main power switch is not turned on.	Turn on the main power switch.	8,9
	The power cord is disconnected.	Plug the power cord into an AC power outlet.	
No video or audio.	The input is not correctly set.	Use the projector or remote control transmitter to set.	10
	No signal input.	Connect correctly.	7,8
Video is present but no audio.	The projector is not correctly connected.	Connect correctly.	7,8
	The volume is set to minimum.	Press VOLUME  on the remote control or display the menu screen and adjust the volume.	11,15
	Mute is turned on.	Press the MUTE  button.	11
Audio is present but no video.	The projector is not correctly connected.	Connect correctly.	7,8
	The brightness adjustment knob is rotated fully clockwise.	Select BRIGHT with the MENU button and the press the  button.	12
	The lens cap is still attached.	Remove the lens cap.	9
Colors are pale and color matching is poor.	Color density and color matching are not correctly adjusted.	Adjust the video.	12
Images are dark.	Brightness and contrast are not correctly adjusted.	Adjust the video.	12
	The lamp is nearing the end of its service life.	Replace with a new lamp.	17
Video is blurred.	Focus or H PHASE is out of adjustment.	Adjust the focus or H PHASE.	9,12

SPECIFICATIONS

Table 12. Specifications

Item		Specification	
Product name		Liquid crystal projector	
Liquid crystal panel	Panel size	3.3 cm (1.3 type)	
	Drive system	TFT active matrix	
	Pixels	786,432 pixels (1024 horizontal x 768 vertical)	
Lens		Zoom lens F=1.7 ~ 2.3 f=49.0 ~ 64.0 mm	
Lamp		250 W UHB	
Speaker		1.2 W + 1.2W (Stereo)	
Power supply		AC100 ~ 120V, 4.5A / AC220 ~ 240V, 2.2A	
Power consumption		400W	
Temperature range		0 ~ 35°C (Operating)	
Size		289 (W) x 124 (H) x 350 (D) mm	
Weight (mass)		6.4 kg	
RGB signal input	RGB IN	1	Video: Analog 0.7Vp-p, 75Ω terminator (positive) H/V. sync.: TTL level (positive/negative) Composite sync.: TTL level D-sub 15-pin shrink jack
		2	Video: Analog 0.7Vp-p, 75Ω terminator (positive) H/V. sync.: TTL level (positive/negative) Composite sync.: TTL level D-sub 15-pin shrink jack
	DIGITAL		TMDS, DC: 150~1200 mV / AC: 1.56 Vp-p TTL Level (Positive/Negative)
	AUDIO IN	RGB1 DIGITAL RGB2	200mVrms, 50 kΩ (max. 3.0Vp-p) Stereo mini jack
Video signal input	VIDEO		1.0Vp-p, 75Ω terminator RCA jack
	S-VIDEO		Brightness signal: 1.0Vp-p, 75Ω terminator Color signal: 0.286Vp-p (burst signal), 75Ω terminator Mini DIN 4-pin jack
	COMPONENT VIDEO	Y	1.0 Vp-p, 75 Ω Terminator (Positive)
		CB/CR	0.7 Vp-p, 75 Ω Terminator (Positive)
		PB/PR	1.0 Vp-p, 75 Ω Terminator (Positive)
AUDIO	L	200mVrms, 50 kΩ (max. 3.0Vp-p)	
	R	RCA jack	
Signal output	RGB OUT		Video: Analog 0.7Vp-p, 75Ω output impedance (positive) H/V. sync.: TTL level (positive/negative) Composite sync.: TTL level D-sub 15-pin shrink jack
	AUDIO OUT		200mVrms, output impedance 1 kΩ (max. 3.0Vp-p) Stereo mini jack
Control functions	CONTROL		D-sub 15-pin shrink plug
	USB		USB jack (B type)
Optional Parts		Lamp: DT00341 Air Filter: MU0832 * For others, consult your dealer.	

NOTE • This specifications are subject to change without notice.

WARRANTY AND AFTER-SERVICE

If a problem occurs with the equipment, first refer to the P.20 “TROUBLESHOOTING” section and run through the suggested checks. If this does not resolve the problem contact your dealer or service company. If repairs are possible, and desirable, they will be charged.

TECHNICAL

Dimension Diagram

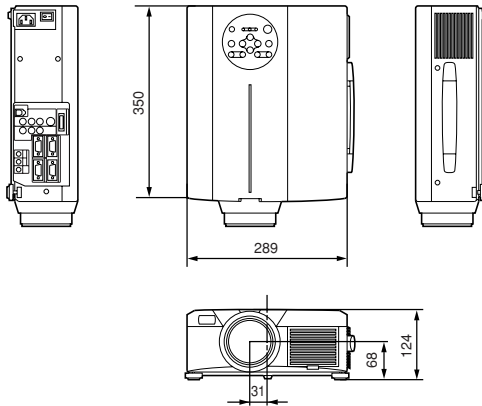

Unit : mm

Signal Connector Pin Assignment

1. D-sub 15-pin Shrink Connector (RGB IN 1/RGB IN 2/RGB OUT)

Pin No	Signal	Pin No	Signal	Pin No	Signal
1	Video input Red	9	-	15	RGB IN 1: SCL(DDC)
2	Video input Green	10	Ground		RGB IN 2: -
3	Video input Blue	11	-		RGB OUT: -
4	-	12	RGB IN 1: SDA(DDC)		
5	Ground		RGB IN 2: -		
6	Ground Red		RGB OUT: -		
7	Ground Green	13	H. sync./ Composite sync.		
8	Ground Blue	14	Vertical sync		

2. Digital Receptacle Connector (DIGITAL)

Pin No	Signal	Pin No	Signal	Pin No	Signal
1	T.M.D.S. Data 2 -	11	T.M.D.S. Data 1 / 3 Shield	21	-
2	T.M.D.S. Data 2 +	12	-	22	T.M.D.S. Clock Shield
3	T.M.D.S. Data 2 / 4 Shield	13	-	23	T.M.D.S. Clock +
4	-	14	+5V Power	24	T.M.D.S. Clock -
5	-	15	Ground (+5V, Analog H/V Sync.)		
6	DDC Clock	16	Hot-Plug Sense		
7	DDC Data	17	T.M.D.S. Data 0 -		
8	Analog V. Sync.	18	T.M.D.S. Data 0 +		
9	T.M.D.S. Data 1 -	19	T.M.D.S. Data 0 / 5 Shield		
10	T.M.D.S. Data 1 +	20	-		

3. Mini Din 4-pin Connector (S-VIDEO)

Pin No	Signal
1	Color:0.286Vp-p (NTSC, burst signal),75Ω terminator 0.3Vp-p (PAL/SECAM, burst signal),75Ω terminator
2	Brightness:1.0Vp-p, 75Ω terminator
3	Ground
4	Ground

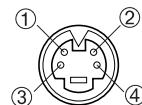

TECHNICAL

Example of computer signal

Resolution H × V	fH (kHz)	fV (Hz)	Rating	Signal mode	Display mode
720 × 400	37.9	85.0	VESA	TEXT	Zoom in
640 × 480	31.5	59.9	VESA	VGA (60Hz)	Zoom in
640 × 480	35.0	66.7		Mac13"mode	Zoom in
640 × 480	37.9	72.8	VESA	VGA (72Hz)	Zoom in
640 × 480	37.5	75.0	VESA	VGA (75Hz)	Zoom in
640 × 480	43.3	85.0	VESA	VGA (85Hz)	Zoom in
800 × 600	35.2	56.3	VESA	SVGA (56Hz)	Zoom in
800 × 600	37.9	60.3	VESA	SVGA (60Hz)	Zoom in
800 × 600	48.1	72.2	VESA	SVGA (72Hz)	Zoom in
800 × 600	46.9	75.0	VESA	SVGA (75Hz)	Zoom in
800 × 600	53.7	85.1	VESA	SVGA (85Hz)	Zoom in
832 × 624	49.7	74.5		Mac16"mode	Zoom in
1024 × 768	48.4	60.0	VESA	XGA (60Hz)	
1024 × 768	56.5	70.1	VESA	XGA (70Hz)	
1024 × 768	60.0	75.0	VESA	XGA (75Hz)	
1024 × 768	68.7	85.0	VESA	XGA (85Hz)	
1152 × 864	67.5	75.0	VESA	SXGA (75Hz)	Zoom out
1280 × 960	60.0	60.0	VESA	SXGA (60Hz)	Zoom out
1280 × 1024	64.0	60.0	VESA	SXGA (60Hz)	Zoom out
1280 × 1024	80.0	75.0	VESA	SXGA (75Hz)	Zoom out

NOTE • Some computers may have multiple display screen modes. Use of some of these modes will not be possible with this projector.

- Be sure to check jack type, signal level, timing and resolution before connecting this projector to a computer.
- Depending on the input signal, full-size display may not be possible in some cases. Refer to the number of display pixels above.
- The image might be something wrong with computer by computer on the digital RGB mode. In the case, it is recommended to reduce the resolution and / or refresh rate.

TECHNICAL (continued)

Initial set signals

The following signals are used for the initial settings.

The signal timing of some computer models may be different. In such case, refer to adjust the V.POSIT and H.POSIT of the menu.

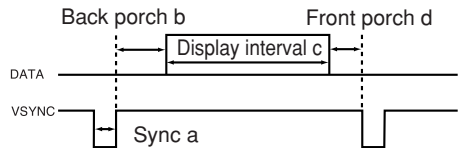
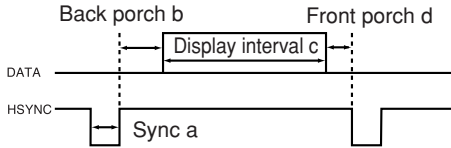

Computer / Signal	Horizontal signal timing (µs)			
	a	b	c	d
TEXT	2.0	3.0	20.3	1.0
VGA (60Hz)	3.8	1.9	25.4	0.6
Mac 13"mode	2.1	3.2	21.2	2.1
VGA (72Hz)	1.3	3.8	20.3	1.0
VGA (75Hz)	2.0	3.8	20.3	0.5
VGA (85Hz)	1.6	2.2	17.8	1.6
SVGA (56Hz)	2.0	3.6	22.2	0.7
SVGA (60Hz)	3.2	2.2	20.0	1.0
SVGA (72Hz)	2.4	1.3	16.0	1.1
SVGA (75Hz)	1.6	3.2	16.2	0.3
SVGA (85Hz)	1.1	2.7	14.2	0.6
Mac 16"mode	1.1	3.9	14.5	0.6
XGA (60Hz)	2.1	2.5	15.8	0.4
XGA (70Hz)	1.8	1.9	13.7	0.3
XGA (75Hz)	1.2	2.2	13.0	0.2
XGA (85Hz)	1.0	2.2	10.8	0.5
1152x864 (75Hz)	1.2	2.4	10.7	0.6
1280x960 (60Hz)	1.0	2.9	11.9	0.9
1280x1024 (60Hz)	1.0	2.3	11.9	0.4
1280x1024 (75Hz)	1.1	1.8	9.5	0.1

Computer / Signal	Vertical signal timing (lines)			
	a	b	c	d
TEXT	3	42	400	1
VGA (60Hz)	2	33	480	10
Mac 13"mode	3	39	480	3
VGA (72Hz)	3	28	480	9
VGA (75Hz)	3	16	480	1
VGA (85Hz)	3	25	480	1
SVGA (56Hz)	2	22	600	1
SVGA (60Hz)	4	23	600	1
SVGA (72Hz)	6	23	600	37
SVGA (75Hz)	3	21	600	1
SVGA (85Hz)	3	27	600	1
Mac 16"mode	3	39	624	1
XGA (60Hz)	6	29	768	3
XGA (70Hz)	6	29	768	3
XGA (75Hz)	3	28	768	1
XGA (85Hz)	3	36	768	1
1152x864 (75Hz)	3	32	864	1
1280x960 (60Hz)	3	36	960	1
1280x1024 (60Hz)	3	38	1024	1
1280x1024 (75Hz)	3	38	1024	1

TECHNICAL (continued)

Connection to the Mouse Control

1. PS/2, ADB or Serial Mouse

- (1) Turn off the projector and computer, and connect the two units with the appropriate cable. For PS/2 mouse control (for IBM and compatible), use the enclosed mouse cable. For others, consult your dealer.
- (2) Disconnect the USB cable from the projector if it is connected. Then turn on the projector.
- (3) Turn on the computer.
- (4) Start the mouse function. If the mouse has not been started, reboot the computer (soft reboot or reboot buttons). Refer to the descriptions of “DISC PAD” and “MOUSE/RIGHT button” of page 4.

2. USB Mouse

- (1) Connect the projector and computer with a suitable commercially available USB cable. Consult your dealer to get the cable, if you need.
- (2) Start the mouse function. Refer to the descriptions of “DISC PAD” and “MOUSE/RIGHT button” of page 4.

NOTE • Before connecting, read the instruction manuals of the devices to be connected.
• In the case of notebook type computers with an internal pointing device, the mouse control function will not work unless the internal pointing device is disabled. In such case, disable the internal pointing device and change the BIOS setting to select an external mouse before the operations described in (1) to (5) above.

Also, some computers may not have a utility program to operate a mouse.
Refer to the computer hardware manual for detail.

PS/2 Mouse

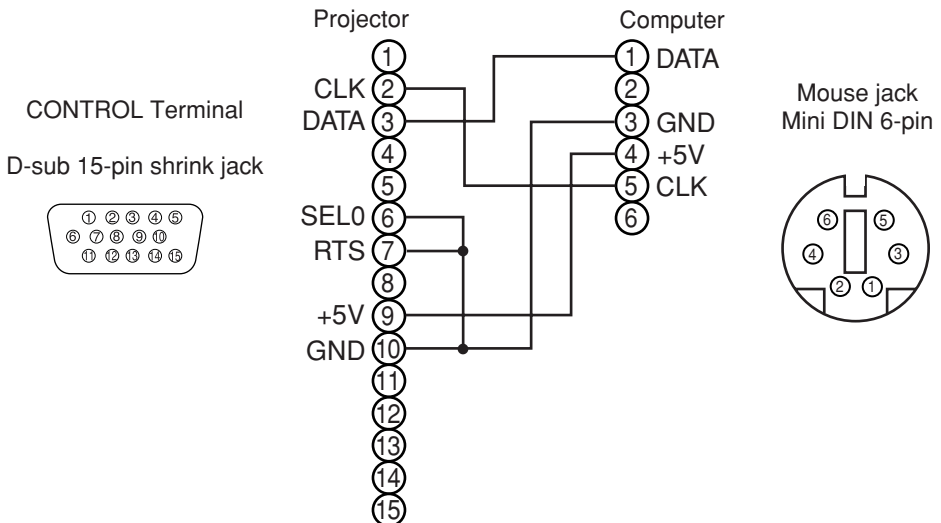

TECHNICAL (continued)

ADB Mouse

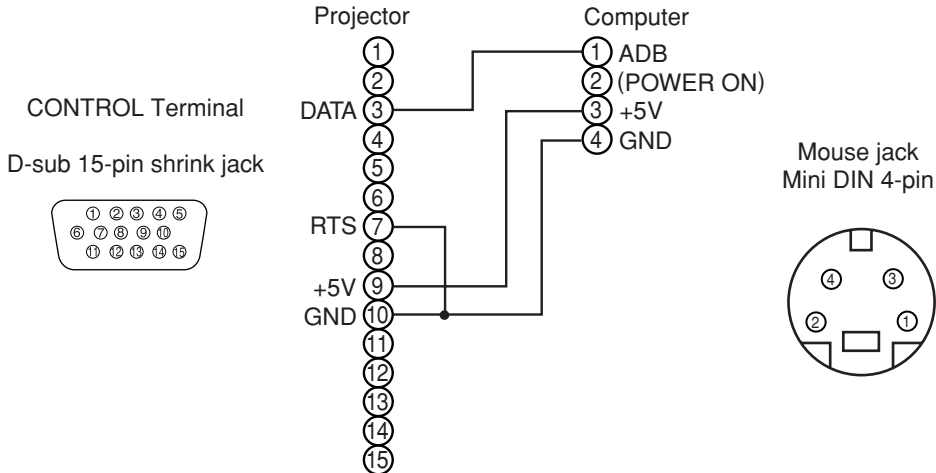

Serial Mouse

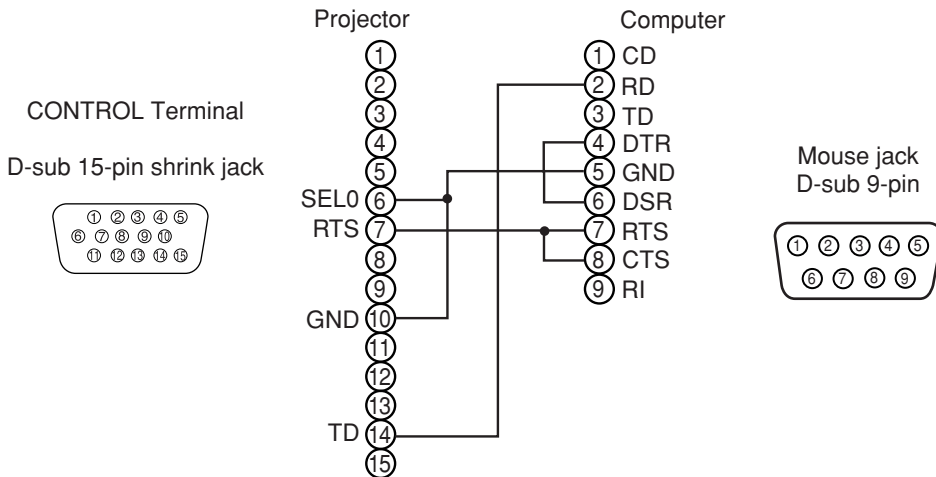

USB Mouse

USB jack
(B type)

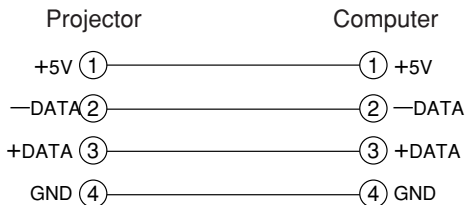
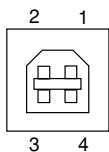

USB cable

USB jack
(A type)

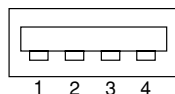

TECHNICAL (continued)

RS-232C communication

- (1) Turn off the projector and computer power supplies and connect with the RS-232C cable.
- (2) Turn on the computer power supply and, after the computer has started up, turn on the projector power supply.

Control jack
D-sub 15-pin shrink jack

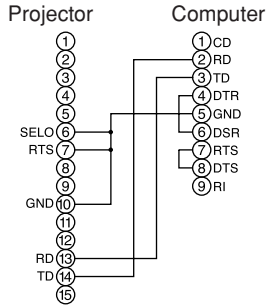
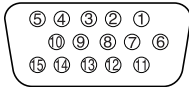

RS-232C jack
D-sub 9-pin

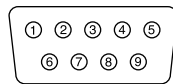

Communications setting

19200bps, 8N1

1 Protocol

Consist of header (7 bytes) + command data (6 bytes).

2 Header

BE + EF + 03 + 06 + 00 + CRC_low + CRC_high

CRC_low : Lower byte of CRC flag for command data.

CRC_high : Upper byte of CRC flag for command data.

3 Command data

Command data chart

byte_0	byte_1	byte_2	byte_3	byte_4	byte_5
Action		Type		Setting code	
low	high	low	high	low	high

Action (byte_0 - 1)

Action	Classification	Content
1	SET	Change setting to desired value.
2	GET	Read projector internal setup value.
4	INCREMENT	Increment setup value by 1.
5	DECREMENT	Decrement setup value by 1.
6	EXECUTE	Run a command.

TECHNICAL (continued)

Requesting projector status (Get command)

- (1) Send the request code Header + Command data ('02H'+ '00H'+ type (2 bytes) + '00H'+ '00H') from the computer to the projector.
- (2) The projector returns the response code '1DH'+ data (2 bytes) to the computer.

Changing the projector settings (Set command)

- (1) Send the setting code Header + Command data ('01H'+ '00H'+ type (2 bytes) + setting code (2 bytes)) from the computer to the projector.
- (2) The projector changes the setting based on the above setting code.
- (3) The projector returns the response code '06H' to the computer.

Using the projector default settings (Reset Command)

- (1) The computer sends the default setting code Header + Command data ('06H'+ '00H'+ type (2 bytes) + '00H'+ '00H') to the projector.
- (2) The projector changes the specified setting to the default value.
- (3) The projector returns the response code '06H' to the computer.

Increasing the projector setting value (Increment command)

- (1) The computer sends the increment code Header + Command data ('04H'+ '00H'+ type (2 bytes) + '00H'+ '00H') to the projector.
- (2) The projector increases the setting value on the above setting code.
- (3) The projector returns the response code '06H' to the computer.

Decreasing the projector setting value (Decrement command)

- (1) The computer sends the decrement code Header + Command data ('05H'+ '00H'+ type (2 bytes) + '00H'+ '00H') to the projector.
- (2) The projector decreases the setting value on the above setting code.
- (3) The projector returns the response code '06H' to the computer.

When a command sent by the projector cannot be understood by the computer

When the command sent by the projector cannot be understood, the error command '15H' is returned by the computer. Some times, the projector ignores RS-232C commands during other works. If the error command '15H' is returned, please send the same command again.

When data sent by the projector cannot be practice

When the command sent by the projector cannot be practiced, the the error code '1cH' + 'xxxxH' is returned.

When the data length is greater than indicated by the data length code, the projector will ignore the excess data code.

Conversely, when the data length is shorter than indicated by the data length code, an error code will be returned to the projector.

NOTE • Operation cannot be guaranteed when the projector receives an undefined command or data.

- Provide an interval of at least 40ms between the response code and any other code.
- The projector outputs test data when the power supply is switched ON, and when the lamp is lit. Ignore this data.
- Commands are not accepted during warm-up.

TECHNICAL (continued)

Command data chart

Names	Operation type		Header				Command data			
							CRC	Action	Type	Setting code
Blank Color	Set	Red	BE	EF	03	06 00	3B D3	01 00	00 30	00 00
		Orange	BE	EF	03	06 00	AB D2	01 00	00 30	01 00
		Green	BE	EF	03	06 00	5B D2	01 00	00 30	02 00
		Blue	BE	EF	03	06 00	CB D3	01 00	00 30	03 00
		Purple	BE	EF	03	06 00	FB D1	01 00	00 30	04 00
		White	BE	EF	03	06 00	6B D0	01 00	00 30	05 00
		Black	BE	EF	03	06 00	9B D0	01 00	00 30	06 00
	Get	BE	EF	03	06 00	08 D3	02 00	00 30	00 00	
Mirror	Set	Normal	BE	EF	03	06 00	C7 D2	01 00	01 30	00 00
		H Inverse	BE	EF	03	06 00	57 D3	01 00	01 30	01 00
		V Inverse	BE	EF	03	06 00	A7 D3	01 00	01 30	02 00
		H&V Inverse	BE	EF	03	06 00	37 D2	01 00	01 30	03 00
	Get	BE	EF	03	06 00	F4 D2	02 00	01 30	00 00	
Freeze	Set	Normal	BE	EF	03	06 00	83 D2	01 00	02 30	00 00
		Freeze	BE	EF	03	06 00	13 D3	01 00	02 30	01 00
	Get	BE	EF	03	06 00	B0 D2	02 00	02 30	00 00	
Menu Color	Set	Red	BE	EF	03	06 00	7F D3	01 00	03 30	00 00
		Orange	BE	EF	03	06 00	EF D2	01 00	03 30	01 00
		Green	BE	EF	03	06 00	1F D2	01 00	03 30	02 00
		Blub	BE	EF	03	06 00	8F D3	01 00	03 30	03 00
		Purple	BE	EF	03	06 00	BF D1	01 00	03 30	04 00
		Transparent	BE	EF	03	06 00	2F D0	01 00	03 30	05 00
		Gray	BE	EF	03	06 00	DF D0	01 00	03 30	06 00
	Get	BE	EF	03	06 00	4C D3	02 00	03 30	00 00	
Startup	Set	Turn ON	BE	EF	03	06 00	0B D2	01 00	04 30	00 00
		Turn OFF	BE	EF	03	06 00	9B D3	01 00	04 30	01 00
	Get	BE	EF	03	06 00	38 D2	02 00	04 30	00 00	
Language	Set	English	BE	EF	03	06 00	F7 D3	01 00	05 30	00 00
		Français	BE	EF	03	06 00	67 D2	01 00	05 30	01 00
		Deutsch	BE	EF	03	06 00	97 D2	01 00	05 30	02 00
		Español	BE	EF	03	06 00	07 D3	01 00	05 30	03 00
		Italiano	BE	EF	03	06 00	37 D1	01 00	05 30	04 00
		Norsk	BE	EF	03	06 00	A7 D0	01 00	05 30	05 00
		Nederlands	BE	EF	03	06 00	57 D0	01 00	05 30	06 00
		Português	BE	EF	03	06 00	C7 D1	01 00	05 30	07 00
		Japanese	BE	EF	03	06 00	37 D4	01 00	05 30	08 00
	Get	BE	EF	03	06 00	C4 D3	02 00	05 30	00 00	

TECHNICAL (continued)

Command data chart

Names	Operation type		Header				Command data		
						CRC	Action	Type	Setting code
Magnify	Get		BE EF	03	06 00	7C D2	02 00	07 30	00 00
	Increment		BE EF	03	06 00	1A D2	04 00	07 30	00 00
	Decrement		BE EF	03	06 00	CB D3	05 00	07 30	00 00
Auto off	Get		BE EF	03	06 00	08 86	02 00	10 31	00 00
	Increment		BE EF	03	06 00	6E 86	04 00	10 31	00 00
	Decrement		BE EF	03	06 00	BF 87	05 00	10 31	00 00
Brightness Reset	Execute		BE EF	03	06 00	58 D3	06 00	00 70	00 00
Contrast Reset	Execute		BE EF	03	06 00	A4 D2	06 00	01 70	00 00
V.Position Reset	Execute		BE EF	03	06 00	E0 D2	06 00	02 70	00 00
H.Position Reset	Execute		BE EF	03	06 00	IC D3	06 00	03 70	00 00
H.Size Reset	Execute		BE EF	03	06 00	68 D2	06 00	04 70	00 00
Color Balance R Reset	Execute		BE EF	03	06 00	94 D3	06 00	05 70	00 00
Color Balance B Reset	Execute		BE EF	03	06 00	D0 D3	06 00	06 70	00 00
Sharpness Reset	Execute		BE EF	03	06 00	C4 D0	06 00	09 70	00 00
Color Reset	Execute		BE EF	03	06 00	80 D0	06 00	0A 70	00 00
Tint Reset	Execute		BE EF	03	06 00	7C D1	06 00	0B 70	00 00
Keystone Reset	Execute		BE EF	03	06 00	08 D0	06 00	0C 70	00 00
Auto	Execute		BE EF	03	06 00	91 D0	06 00	0A 20	00 00
Blank on/off	Set	off	BE EF	03	06 00	FB D8	01 00	20 30	00 00
		on	BE EF	03	06 00	6B D9	01 00	20 30	01 00
	Get		BE EF	03	06 00	C8 D8	02 00	20 30	00 00
Error Status	Get		BE EF	03	06 00	D9 D8	02 00	20 60	00 00
			(Example of Return) 00 00 01 00 02 00 03 00 (Normal) (Cover-error) (Fan-error) (Lamp-error) 04 00 05 00 06 00 (reserved) (reserved) (Lamp-Time-over)						
Power	Set	OFF	BE EF	03	06 00	2A D3	01 00	00 60	00 00
		ON	BE EF	03	06 00	BA D2	01 00	00 60	01 00
	Get		BE EF	03	06 00	19 D3	02 00	00 60	00 00
Input Source	Set	RGB1	BE EF	03	06 00	FE D2	01 00	00 20	00 00
		RGB2	BE EF	03	06 00	3E D0	01 00	00 20	04 00
		Digital	BE EF	03	06 00	0E D2	01 00	00 20	03 00
		Video	BE EF	03	06 00	6E D3	01 00	00 20	01 00
		SVideo	BE EF	03	06 00	9E D3	01 00	00 20	02 00
		Component	BE EF	03	06 00	AE D1	01 00	00 20	05 00
Get		BE EF	03	06 00	CD D2	02 00	00 20	02 00	
Volume	Get		BE EF	03	06 00	31 D3	02 00	01 20	00 00
	Increment		BE EF	03	06 00	57 D3	04 00	01 20	00 00
	Decrement		BE EF	03	06 00	86 D2	05 00	01 20	00 00

TECHNICAL (continued)

Command data chart

Names	Operation type		Header				Command data								
							Action	Type	Setting code						
Mute	Set	Normal	BE	EF	03	06	00	46	D3	01	00	02	20	00	00
		Mute	BE	EF	03	06	00	D6	D2	01	00	02	20	01	00
	Get	BE	EF	03	06	00	75	D3	02	00	02	20	00	00	
Brightness	Get		BE	EF	03	06	00	89	D2	02	00	03	20	00	00
	Increment		BE	EF	03	06	00	EF	D2	04	00	03	20	00	00
	Decrement		BE	EF	03	06	00	3E	D3	05	00	03	20	00	00
Contrast	Get		BE	EF	03	06	00	FD	D3	02	00	04	20	00	00
	Increment		BE	EF	03	06	00	9B	D3	04	00	04	20	00	00
	Decrement		BE	EF	03	06	00	4A	D2	05	00	04	20	00	00
Color Balance R	Get		BE	EF	03	06	00	01	D2	02	00	05	20	00	00
	Increment		BE	EF	03	06	00	67	D2	04	00	05	20	00	00
	Decrement		BE	EF	03	06	00	B6	D3	05	00	05	20	00	00
Color Balance B	Get		BE	EF	03	06	00	45	D2	02	00	06	20	00	00
	Increment		BE	EF	03	06	00	23	D2	04	00	06	20	00	00
	Decrement		BE	EF	03	06	00	F2	D3	05	00	06	20	00	00
Keystone	Get		BE	EF	03	06	00	B9	D3	02	00	07	20	00	00
	Increment		BE	EF	03	06	00	DF	D3	04	00	07	20	00	00
	Decrement		BE	EF	03	06	00	0E	D2	05	00	07	20	00	00
Aspect	Set	4:3	BE	EF	03	06	00	9E	D0	01	00	08	20	00	00
		16:9	BE	EF	03	06	00	0E	D1	01	00	08	20	01	00
		Small	BE	EF	03	06	00	FE	D1	01	00	08	20	02	00
	Get	BE	EF	03	06	00	AD	D0	02	00	08	20	00	00	
Display Position at 16 : 9 or Small	Set	Default	BE	EF	03	06	00	62	D1	01	00	09	20	00	00
		Bottom	BE	EF	03	06	00	F2	D0	01	00	09	20	01	00
		Top	BE	EF	03	06	00	02	D0	01	00	09	20	02	00
	Get	BE	EF	03	06	00	51	D1	02	00	09	20	00	00	
V.Position	Get		BE	EF	03	06	00	0D	83	02	00	00	21	00	00
	Increment		BE	EF	03	06	00	6B	83	04	00	00	21	00	00
	Decrement		BE	EF	03	06	00	BA	82	05	00	00	21	00	00
H.Position	Get		BE	EF	03	06	00	F1	82	02	00	01	21	00	00
	Increment		BE	EF	03	06	00	97	82	04	00	01	21	00	00
	Decrement		BE	EF	03	06	00	46	83	05	00	01	21	00	00
H.Size	Get		BE	EF	03	06	00	B5	82	02	00	02	21	00	00
	Increment		BE	EF	03	06	00	D3	82	04	00	02	21	00	00
	Decrement		BE	EF	03	06	00	02	83	05	00	02	21	00	00
H.Phase	Get		BE	EF	03	06	00	49	83	02	00	03	21	00	00
	Increment		BE	EF	03	06	00	2F	83	04	00	03	21	00	00
	Decrement		BE	EF	03	06	00	FE	82	05	00	03	21	00	00

TECHNICAL (continued)

Command data chart

Names	Operation type	Header				Command data				
					CRC	Action	Type	Setting code		
Sharpness	Get	BE	EF	03	06 00	F1 72	02 00	01 22	00 00	
	Increment	BE	EF	03	06 00	97 72	04 00	01 22	00 00	
	Decrement	BE	EF	03	06 00	46 73	05 00	01 22	00 00	
Color	Get	BE	EF	03	06 00	B5 72	02 00	02 22	00 00	
	Increment	BE	EF	03	06 00	D3 72	04 00	02 22	00 00	
	Decrement	BE	EF	03	06 00	02 73	05 00	02 22	00 00	
Tint	Get	BE	EF	03	06 00	49 73	02 00	03 22	00 00	
	Increment	BE	EF	03	06 00	2F 73	04 00	03 22	00 00	
	Decrement	BE	EF	03	06 00	FE 72	05 00	03 22	00 00	
Video Format	Set	Auto	BE	EF	03	06 00	9E 75	01 00	00 22	0A 00
		NTSC	BE	EF	03	06 00	FE 71	01 00	00 22	04 00
		PAL	BE	EF	03	06 00	6E 70	01 00	00 22	05 00
		SECAM	BE	EF	03	06 00	6E 75	01 00	00 22	09 00
		NTSC 4.43	BE	EF	03	06 00	5E 72	01 00	00 22	02 00
		M-PAL	BE	EF	03	06 00	FE 74	01 00	00 22	08 00
	N-PAL	BE	EF	03	06 00	0E 71	01 00	00 22	07 00	
Get	BE	EF	03	06 00	0D 73	02 00	00 22	00 00		
Video NR	Set	off	BE	EF	03	06 00	B6 73	01 00	06 22	00 00
		on	BE	EF	03	06 00	26 72	01 00	06 22	01 00
	Get	BE	EF	03	06 00	85 73	02 00	06 22	00 00	
Progressive	Set	off	BE	EF	03	06 00	4A 72	01 00	07 22	00 00
		TV	BE	EF	03	06 00	DA 73	01 00	07 22	01 00
	CINEMA	BE	EF	03	06 00	2A 73	01 00	07 22	02 00	
Get	BE	EF	03	06 00	79 72	02 00	07 22	00 00		
Black	Set	off	BE	EF	03	06 00	5E 71	01 00	08 22	00 00
		on	BE	EF	03	06 00	CE 70	01 00	08 22	01 00
	Get	BE	EF	03	06 00	6D 71	02 00	08 22	00 00	
HDTV	Set	1080i	BE	EF	03	06 00	F2 73	01 00	05 22	00 00
		1035i	BE	EF	03	06 00	62 72	01 00	05 22	01 00
	Get	BE	EF	03	06 00	C1 73	02 00	05 22	00 00	
PinP Size	Set	off	BE	EF	03	06 00	FE 22	01 00	00 23	00 00
		Large	BE	EF	03	06 00	6E 23	01 00	00 23	01 00
		Small	BE	EF	03	06 00	9E 23	01 00	00 23	02 00
	Get	BE	EF	03	06 00	Cd 22	02 00	00 23	00 00	

TECHNICAL (continued)

Command data chart

Names	Operation type		Header				Command data		
			CRC	Action	Type	Setting code			
PinP Position	Set	Upper left	BE EF	03 06 00	02 23	01 00	01 23	00 00	
		Upper right	BE EF	03 06 00	92 22	01 00	01 23	01 00	
		bottom left	BE EF	03 06 00	62 22	01 00	01 23	03 00	
		bottom right	BE EF	03 06 00	F2 23	01 00	01 23	02 00	
	Get	BE EF	03 06 00	31 23	02 00	01 23	00 00		
PinP Audio ch	Set	RGB	BE EF	03 06 00	BA 22	01 00	03 23	00 00	
		Video	BE EF	03 06 00	2A 23	01 00	03 23	01 00	
	Get	BE EF	03 06 00	89 22	02 00	03 23	00 00		
FOCUS	Increment		BE EF	03 06 00	6A 93	04 00	00 24	00 00	
	Decrement		BE EF	03 06 00	BB 92	05 00	00 24	00 00	
Zoom	Increment		BE EF	03 06 00	96 92	04 00	01 24	00 00	
	Decrement		BE EF	03 06 00	47 93	05 00	01 24	00 00	
Sync on G	Set	off	BE EF	03 06 00	CB D0	01 00	08 30	01 00	
		on	BE EF	03 06 00	5B D1	01 00	08 30	00 00	
	Get	BE EF	03 06 00	68 D1	02 00	08 30	00 00		

REGULATORY NOTICES

FCC Statement Warning

WARNING: This equipment has been tested and found to comply with the limits for a Class B digital device, pursuant to Part 15 of the FCC Rules. These limits are designed to provide reasonable protection against harmful interference in a residential installation. This equipment generates, uses, and can radiate radio frequency energy and, if not installed and used in accordance with the instructions, may cause harmful interference to radio communications. However, there is no guarantee that interference will not occur in a particular installation. If this equipment does cause harmful interference to radio or television reception, which can be determined by turning the equipment off and on, the user is encouraged to try to correct the interference by one or more of the following measures:

- Reorient or relocate the receiving antenna.
- Increase the separation between the equipment and receiver.
- Connect the equipment into an outlet on a circuit different from that to which the receiver is connected.
- Consult the dealer or an experienced radio/TV technician for help.

INSTRUCTIONS TO USERS: This equipment complies with the requirements of FCC (Federal Communication Commission) equipment provided that the following conditions are met.

The cables may have to be used with the core set to the projector side. Use the cables which are included with the projector or specified.

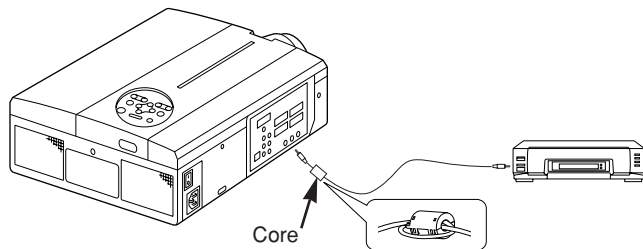

CAUTION: Changes or modifications not expressly approved by the party responsible for compliance could void the user's authority to operate the equipment.

For the Customers in CANADA

NOTICE: This Class B digital apparatus complies with Canadian ICES-003.

Pour les utilisateurs au Canada

AVIS: Cet appareil numérique de la Classe B est conforme à la norme NMB-003 du Canada.

LEGAL INFORMATION

FIVE-YEAR LIMITED WARRANTY

This Dukane LCD projector is warranted to the original purchaser for a period of five (5) years from the original purchase date - in normal use and service - against defects in material and workmanship. DUKANE CORPORATION EXPRESSLY DISCLAIMS ALL OTHER WARRANTIES OF MERCHANTABILITY AND FITNESS FOR A PARTICULAR PURPOSE.

During the warranty period, Dukane Corporation will repair or replace (at the manufacturer's option) any such defective parts (except for the lamp, which is subject to whatever warranties the manufacturer may provide) without charge to the purchaser for parts or labor when the product is returned, prepaid and insured, with proof-of-purchase date. This remedy is void if the product has been damaged by accident, unreasonable use, neglect, improper service or other causes not arising out of defects in material or workmanship.

Dukane Corporation disclaims all liability for incidental or consequential damage of any kind, including all damages arising out of any interruptions in operation of the product and all damages to software.

No person, firm, or representative is authorized to assume any obligation or to make any warranty on behalf of the Dukane Corporation other than as stated above.

**THIS LIMITED WARRANTY IS VALID FOR U.S.A AND CANADA.
FOR OTHER LOCATIONS, LOCAL WARRANTIES APPLY.**

LAMP REPLACEMENT SERVICE & REPAIR POLICY & PROCEDURE

For service and parts, contact the Dukane AV Service Department at 1 (800) 676-2487 within the USA or 1 (630) 584-2300 worldwide. If you would like to send a facsimile (FAX), dial 1 (630) 584-5156 worldwide.

When requesting warranty service, please have the sales receipt available along with the model name and serial number.

If it becomes necessary to return the projector, use the original packing material and box (if retained) or pack securely. Dukane Corporation will not be liable for any pick-up or delivery charges or any expenses incurred for service calls or service supplied by anyone other than the Dukane AV Service Department.

Audio Visual Products

Dukane Corporation
Audio Visual Products Division
2900 Dukane Drive
St. Charles, IL 60174-3395
E-mail: avsales@dukane.com

Phone: (630) 584-2300
Orders: (800) 676-2485
Information: (800) 676-2486
Fax: (630) 584-5156
Parts & Service: (800) 676-2487
Fax: (630) 584-0984

DUKANE

Part # 401-571-00

Free Manuals Download Website

<http://myh66.com>

<http://usermanuals.us>

<http://www.somanuals.com>

<http://www.4manuals.cc>

<http://www.manual-lib.com>

<http://www.404manual.com>

<http://www.luxmanual.com>

<http://aubethermostatmanual.com>

Golf course search by state

<http://golfingnear.com>

Email search by domain

<http://emailbydomain.com>

Auto manuals search

<http://auto.somanuals.com>

TV manuals search

<http://tv.somanuals.com>