

## **User's Manual (concise)**

Thank you for purchasing this projector.

Please read through this manual before using this product, in order to use safely and utilize well the product.

**⚠ WARNING** ▶ Before using this product, be sure to read all manuals for this product. See the “Using the CD manual” ( 18) to read the manuals in the CD. After reading them, store them in a safe place for future reference.

▶ Heed all the warnings and cautions in the manuals or on the product.

▶ Follow all the instructions in the manuals or on the product.

**NOTE** • In this manual, unless any comments are accompanied, “the manuals” means all the documents provided with this product, and “the product” means this projector and all the accessories came with the projector.

## **Contents**

First of all..... 2	Turning on the power..... 10
Entries and graphical symbols explanation ..... 2	Adjusting the projector's elevator ..... 11
Important safety instruction ..... 2	Operation..... 11
Regulatory notices..... 3	Turning off the power..... 13
About Electro-Magnetic Interference ..... 3	Replacing the lamp..... 14
About Waste Electrical and Electronic Equipment... 4	Cleaning and replacing the air filter.. 16
Contents of package..... 4	Replacing the internal clock battery.. 17
Arrangement..... 5	Using the CD manual ..... 18
Connecting with your devices..... 6	Specifications ..... 19
Connecting power supply ..... 8	Troubleshooting
Preparing for the remote control..... 9	- Warranty and after-service ..... 20

# First of all

## Entries and graphical symbols explanation

The following entries and graphical symbols are used for the manuals and the product as follows, for safety purpose. Please know their meanings beforehand, and heed them.

**⚠WARNING** This entry warns of a risk of serious personal injury or even death.

**⚠CAUTION** This entry warns of a risk of personal injury or physical damage.

**NOTICE** This entry notices of fear of causing trouble.

## Important safety instruction

The followings are important instructions for safely using the product. Be sure to follow them always when handling the product. The manufacturer assumes no responsibility for any damage caused by mishandling that is beyond normal usage defined in these manuals of this projector.

**⚠WARNING** ► Never use the product in or after an abnormality (ex. giving off smoke, smelling strange, took a liquid or an object inside, broken, etc.) If an abnormality should occur, unplug the projector urgently.

► Situate the product away from children and pets.

► Do not use the product when there is fear of a thunderbolt.

► Unplug the projector from the power outlet if the projector is not used for the time being.

► Do not open or remove any portion of the product, unless the manuals direct it. For internal maintenance, leave it to your dealer or their service personnel.

► Use only the accessories specified or recommended by the manufacturer.

► Do not modify the projector or accessories.

► Do not let any things or any liquids enter to the inside of the product.

► Do not wet the product.

► Do not place the projector where any oils, such as cooking or machine oil, are used.

Oil may harm the product, resulting in malfunction, or falling from the mounted position.

► Do not apply a shock or pressure to this product.

- Do not place the product on an unstable place such as the uneven surface or the leaned table.

- Do not place the product unstably. Place the projector so that it does not protrude from the surface where the projector is placed on.

- Remove all the attachments including the power cord and cables, from the projector when carrying the projector.

► Do not look into the lens and the openings on the projector, while the lamp is on, since the projection lamp ray may cause a trouble on your eyes.

► Do not approach the lamp cover and the exhaust vents, while the projection lamp is on. Also after the lamp goes out, do not approach them for a while, since too hot.

# Regulatory notices

## About Electro-Magnetic Interference

### In CANADA

CAN ICES-3(B) / NMB-3(B).

### In the US, and other places where the FCC regulations are applicable

#### Declaration of Conformity

Trade name           HITACHI / DUKANE  
Model Number        CP-BX301WN,CP-BW301WN / 8230W, 8232  
Responsible Party   Hitachi America, Ltd.  
Address               2420 Fenton Street, Suite 200 Chula Vista,CA 91914  
                              U.S.A.  
Telephone Number   +1 -800-448-2244

This device complies with part 15 of the FCC Rules. Operation is subject to the following two conditions: (1) This device may not cause harmful interference, and (2) this device must accept any interference received, including interference that may cause undesired operation. This equipment has been tested and found to comply with the limits for a Class B digital device, pursuant to Part 15 of the FCC Rules.

These limits are designed to provide reasonable protection against harmful interference in a residential installation. This equipment generates, uses, and can radiate radio frequency energy and, if not installed and used in accordance with the instructions, may cause harmful interference to radio communications. However, there is no guarantee that interference will not occur in a particular installation. If this equipment does cause harmful interference to radio or television reception, which can be determined by turning the equipment off and on, the user is encouraged to try to correct the interference by one or more of the following measures:

- Reorient or relocate the receiving antenna.
- Increase the separation between the equipment and receiver.
- Connect the equipment into an outlet on a circuit different from that to which the receiver is connected.
- Consult the dealer or an experienced radio/TV technician for help.

**INSTRUCTIONS TO USERS:** This equipment complies with the requirements of FCC (Federal Communication Commission) equipment provided that the following conditions are met. Some cables have to be used with the core set. Use the accessory cable or a designated-type cable for the connection. For cables that have a core only at one end, connect the core to the projector.

**CAUTION:** Changes or modifications not expressly approved by the party responsible for compliance could void the user's authority to operate the equipment.

## Regulatory notices (continued)

### About Waste Electrical and Electronic Equipment



The mark is in compliance with the Waste Electrical and Electronic Equipment Directive 2002/96/EC (WEEE).

The mark indicates the requirement NOT to dispose the equipment including any spent or discarded batteries or accumulators as unsorted municipal waste, but use the return and collection systems available.

If the batteries or accumulators included with this equipment, display the chemical symbol Hg, Cd, or Pb, then it means that the battery has a heavy metal content of more than 0.0005% Mercury or more than, 0.002% Cadmium, or more than 0.004% Lead.

### Contents of package

Your projector should come with the items shown below. Check that all the items are included. Require of your dealer immediately if any items are missing.

Refer to figure F-7 at the back of this manual.

- (1) Remote control with the two AA batteries
- (2) Power cord
- (3) Computer cable
- (4) Lens cover and Strap
- (5) Information sheet
- (6) Security label
- (7) Software info on the Dukane web site.
- (8) Adapter cover

**⚠ WARNING ►** Do not attempt to install the projector yourself. Have your dealer or service center handle all installation work. Note that manufacturer will accept no liability whatsoever for accidents or injuries resulting from an incorrect installation or improper use.

**NOTE •** Keep the original packing materials for future reshipment. Be sure to use the original packing materials when moving the projector. Use special caution for the lens.

## Arrangement

Refer to tables **T-1** or **T-2** and figures **F-1** and **F-2** at the end of this manual to determine the screen size and projection distance.

The values shown in the table are calculated for a full size screen.

Ⓐ Screen size (diagonal)   Ⓑ Projection distance ( $\pm 8\%$ )   Ⓒ1, Ⓒ2 Screen height ( $\pm 8\%$ )

- For the case of installation in special conditions such as on the wall or ceiling, the specified mounting accessories (📖 19) and service may be required. Tabletop use must be set up with the designated optional accessories (📖 19). Before installing the projector, consult your dealer about your installation.
- The screen position may shift after installation if the projector is mounted on locations such as the wall or ceiling, due to the flexibility of the plastic projector body. If readjustment is necessary, consult with your dealer or service personnel.
- The projected image position and/or focus may change during warm-up (approx. 30 minutes after the lamp is turned on) or when the ambient conditions change. Readjust the image position and/or focus as necessary.
- Since the projector features an ultra short throw, be aware that it is required to select a screen carefully to have better performance.
  - A soft screen such as a pull-down screen may cause serious distortion of a projected image. A hard screen such as a board screen is recommended for use with this projector.
  - A high-gain screen such as a bead screen that has narrow viewing angle is not suitable for this projector. A low-gain screen (around 1.0) such as a matte screen that has wide viewing angle is recommended for use with this projector.
  - A screen with a weave pattern may cause moiré on the projected image, which is not a failure of the projector. A screen that has less moiré effects is recommended for use with this projector.

**⚠ WARNING** ▶ Install the projector in a stable horizontal position.

▶ Place the projector in a cool place, and ensure that there is sufficient ventilation.

Keep a space of 30 cm or more between the sides of the projector and other objects such as walls. Do not place or attach anything that would block the projection window or vent holes. Do not place the projector where the air from an air conditioner or similar unit will blow on it directly.

▶ Do not place the projector anywhere where it may get wet.

▶ Use only the mounting accessories the manufacturer specified, and leave installing and removing the projector with the mounting accessories to the service personnel.

▶ Read and keep the user's manual of the mounting accessories used.

**⚠ CAUTION** ▶ Avoid placing the projector in smoky, humid or dusty place.

▶ Position the projector to prevent light from directly hitting the projector's remote sensor.

▶ If the projector is used at an altitude of about 1600 m or higher, set ALTITUDE of the SERVICE item in the OPTION menu to HIGH. Otherwise, set it to NORMAL.

If the projector is used with a wrong setting, it may cause damage to the projector itself or the parts inside.

**NOTE** • The projector may make a rattling sound when tilted, moved or shaken, since a flap to control the air flow inside of the projector has moved. Be aware that this is not a failure or malfunction.

## Arrangement (continued)

### Connecting with your devices

Be sure to read the manuals for devices before connecting them to the projector. Make sure that all the devices are suitable to be connected with this product, and prepare the cables required to connect. Refer to figures **F-3** to **F-5** at the back of this manual.

For details, please see “User’s Manual” - “Operating Guide” and “Network Guide”.

- When **AUTO** is selected for the **COMPUTER IN1** or **COMPUTER IN2** port in **COMPUTER IN** of the **INPUT** menu, that port will accept component video signals.
- To use network functions of the projector, connect the **LAN** port with the computer’s LAN port, or with an access point that is connected to the computer with wireless LAN, using a LAN cable.
  
- If you insert a USB storage device, such as a USB memory, into the **USB TYPE A** port and select the port as the input source, you can view images stored in the device.
- You can connect a dynamic microphone to the **MIC** port with a 3.5 mm mini-plug. In that case, the built-in speaker outputs the sound from the microphone, even while the sound from the projector is output.

**⚠ WARNING** ▶ Use only the appropriate accessories. Otherwise it could cause a fire or damage to the device and the projector.

- Use only the accessories specified or recommended by the projector’s manufacturer. Consult your dealer when the required accessory did not come with the product or the accessory is damaged. It may be regulated under some standard.

- For a cable with a core at only one end, connect the end with the core to the projector. That may be required by EMI regulations.

- Neither disassemble nor modify the projector and the accessories.

- Do not use the damaged accessory. Be careful not to damage the accessories. Route a cable so that it is neither stepped on nor pinched out.

**⚠ CAUTION** ▶ Do not turn on or off the projector while connected to a device in operation, unless that is directed in the manual of the device.

▶ Be careful not to mistakenly connect a connector to a wrong port.

▶ Before connecting the projector to a network, be sure to obtain the consent of the administrator of the network.

▶ Do not connect the **LAN** port to any network that might have the excessive voltage.

▶ The designated USB wireless adapter that is sold as an option is required to use the wireless network function of this projector.

▶ Before removing the USB storage device from the port of the projector, be sure to use the **REMOVE USB** function on the thumbnail screen to secure your data.

▶ Before you insert or pull out the USB wireless adapter from the projector, turn off the power of the projector and pull out the power cord’s plug from the outlet.

Do not touch the USB wireless adapter while the projector is receiving AC power.

(continued on next page)

## Connecting with your devices (continued)

**NOTICE** ► Use the cables with straight plugs, not L-shaped ones, as the input ports of the projector are recessed.

- NOTE** • If a loud feedback noise is produced from the speaker, move the microphone away from the speaker.  
• This projector doesn't support plug-in power for the microphone.

ENGLISH

### Fastening the adapter cover

Use the supplied adapter cover to prevent the USB wireless adapter (optional) from coming off easily and prevention from burn injury.

1. Loosen the screw (marked with triangle) on the bottom left of the **USB TYPE A** port.
2. Insert the tab of the cover into the hole at the upper right of the **USB TYPE A** port in the direction of the arrow.
3. Align the screw holes on the projector and the cover. Then insert the screw removed from the projector into the hole and tighten the screw.

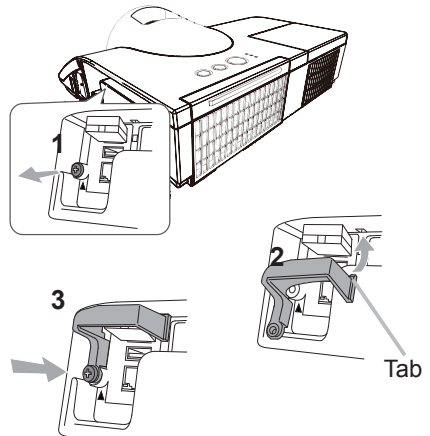

**⚠ WARNING** ► Keep small parts away from children and pets. Take care not to put in the mouth. Heat may build up in the USB wireless adapter, to avoid possible burns disconnect the projector power cord for more than 5min. before touching it.

## Connecting power supply

1. Put the connector of the power cord into the **AC** (AC inlet) of the projector.
2. Firmly plug the power cord's plug into the outlet. In a couple of seconds after the power supply connection, the **POWER** indicator will light up in steady orange.

Please remember that when the **DIRECT POWER ON** function activated, the connection of the power supply make the projector turn on.

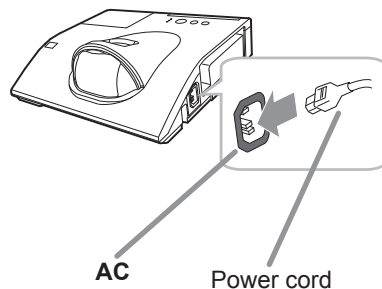

**⚠ WARNING** ► Please use extra caution when connecting the power cord, as incorrect or faulty connections may result in fire and/or electrical shock.

- Do not touch the power cord with a wet hand.
- Only use the power cord that came with the projector. If it is damaged, consult your dealer to get a new one. Never modify the power cord.
- Only plug the power cord into an outlet whose voltage is matched to the power cord. The power outlet should be close to the projector and easily accessible. Remove the power cord for complete separation.
- Do not distribute the power supply to multiple devices. Doing so may overload the outlet and connectors, loosen the connection, or result in fire, electric shock or other accidents.
- Do not press the main body of projector on the power cord.

**NOTICE** ► This product is also designed for IT power systems with a phase-to-phase voltage of 220 to 240 V.



## Preparing for the remote control

Please insert the batteries into the remote control before using it. If the remote control starts to malfunction, try to replace the batteries. If you will not use the remote control for long period, remove the batteries from the remote control and store them in a safe place.

1. Remove the battery cover.
2. Align and insert the two AA batteries (HITACHI MAXELL , Part No.LR6 or R6P) according to their plus and minus terminals as indicated in the remote control.
3. Put the battery cover back to the former state.

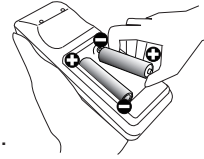

### NOTE

- Try changing the batteries when the remote control malfunctions.
- This remote control works with the remote sensors on the projector using infrared light (Class 1 LED). The active sensor senses the remote control signal assigned within 60 degrees to right and left, and within 3 meters. For details, see the Operating Guide in the CD.
- Prevent the remote sensors from being hit by a strong ray. It may cause malfunction of the projector and remote control.

Remote sensor

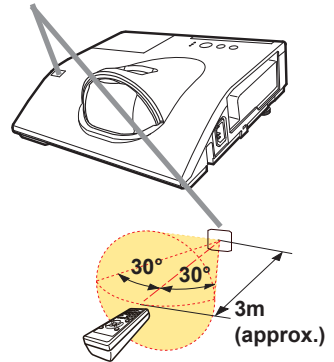

- ⚠WARNING** ► Always handle the batteries with care and use them only as directed. Improper use may result in battery explosion, cracking or leakage, which could result in fire, injury and/or pollution of the surrounding environment.
- Be sure to use only the batteries specified. Do not use batteries of different types at the same time. Do not mix a new battery with used one.
  - Make sure the plus and minus terminals are correctly aligned when loading a battery.
  - Keep a battery away from children and pets.
  - Do not recharge, short circuit, solder or disassemble a battery.
  - Do not place a battery in a fire or water. Keep batteries in a dark, cool and dry place.
  - If you observe battery leakage, wipe out the leakage and then replace a battery. If the leakage adheres to your body or clothes, rinse well with water immediately.
  - Obey the local laws on disposing the battery.

## Turning on the power

1. Make sure that the power cord is firmly and correctly connected to the projector and the outlet.
2. Make sure that the **POWER** indicator is steady orange. Then, remove the lens cover.
3. Press the **STANDBY/ON** button on the projector or the remote control.  
The projection lamp lights up, and the **POWER** indicator begins to blink green.  
When the power is completely on, the indicator will stop blinking and light in steady green.

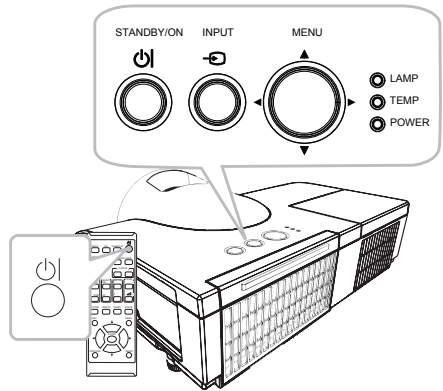

**⚠ WARNING** ► Do not touch around the lamp cover and the exhaust vents during use or just after use, since it is too hot.  
► Remove the power cord for complete separation. The power outlet should be close to the projector and easily accessible.

**NOTE** • Please power on the projector prior to the connected devices.  
• The projector has the DIRECT POWER ON function, which can make the projector automatically turn on. For more information, please see the “Operating Guide” in the CD.

## Adjusting the projector's elevator

The projector has Front foot for inclinations and Rear foot for horizontals. Spacers on the each elevator foot are installed at the time of shipment, and projector is in a condition to be able to just project. If necessary, detach the spacer, and the elevator feet can be manually twisted to make more precise adjustments.

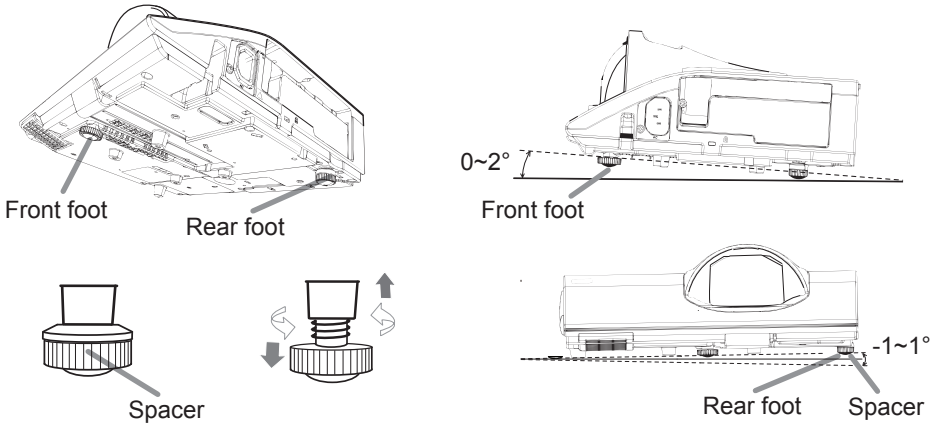

**⚠ WARNING** ▶ Keep the spacers away from children and pets. Be careful not to let them swallow the spacers. If swallowed, consult a physician immediately for emergency treatment.

**NOTE** • The adjustment angle can be adjusted up to plus or minus 1° each of foot.

• After the foot is adjusted, it is possible to return it to the state of the shipment with a spacer. If change the setting place of the projector, it will recommend keep and reuse the spacers.

## Operation

INPUT button

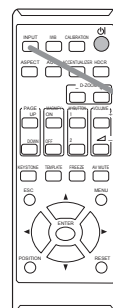
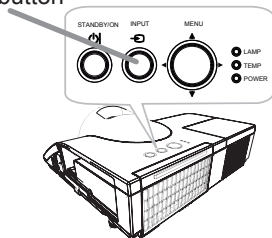

INPUT button

## Displaying and switching the image

Press the **INPUT** button. Each time you press the button, the projector switches its input port in turn. You can also use the remote control to select an input signal.

## Focusing

Use the focus ring to focus the picture.

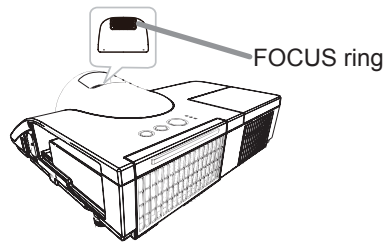

## Selecting an aspect ratio

Each time you press the **ASPECT** button on the remote control, it switches the aspect ratio of the image, in turn.

## Zooming

Use the **D-ZOOM +** and **D-ZOOM -** buttons on the remote control to adjust the screen size.

## Adjusting the picture position

After pressing the **POSITION** button on the remote control, use the **▲**, **▼**, **◀** and **▶** buttons. Press the **POSITION** button again to finish this operation.

## Correcting distortion

Press the **KEystone** button on the remote control. A dialog will appear on the screen to aid you in correcting the distortion.

Use the **◀/▶** cursor buttons for keystone correction.

## Adjusting the volume

Use the **VOLUME +/-** buttons to adjust the volume.

## Temporarily turning off the screen and audio output

Press **AV MUTE** button on the remote control.

The **BLANK** screen will be displayed instead of the screen of input signals and the sound from the **AUDIO OUT** port will be muted.

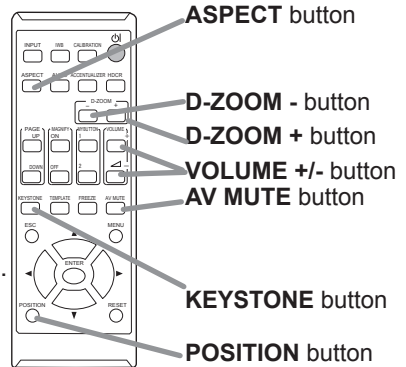

**⚠ WARNING ▶** If you wish to have a blank screen while the projector's lamp is on, use the AV MUTE function (see the Operating Guide). Blocking the beam by something causes high temperature and could result in fire or smoke.

## Operation (continued)

**NOTE** • The **ASPECT** button does not work when no proper signal is inputted.

- For details, see the Operating Guide in the CD.
- There may be some noise and/or the screen may flicker for a moment when an operation is made. This is not a malfunction.

## Turning off the power

1. Press the **STANDBY/ON** button on the projector or the remote control.  
The message “Power off?” will appear on the screen for about 5 seconds.
2. Press the **STANDBY/ON** button again while the message appears.  
The projector lamp will go off, and the **POWER** indicator will begin blinking in orange. Then the **POWER** indicator will stop blinking and light in steady orange when the lamp cooling is complete.

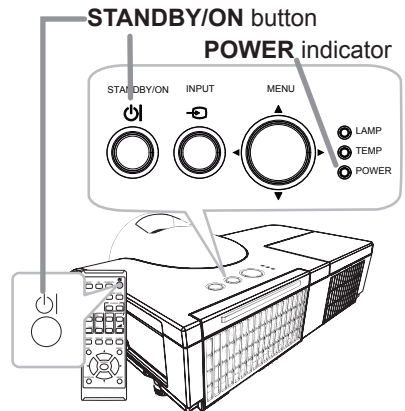

Do not turn the projector on for about 10 minutes or more after turning it off. Also, do not turn the projector off shortly after turning it on. Such operations might cause the lamp to malfunction or shorten the lifetime of some parts including the lamp.

- ⚠ WARNING** ► Do not touch around the lamp cover and the exhaust vents during use or just after use, since it is too hot.
- Remove the power cord for complete separation. The power outlet should be close to the projector and easily accessible.

**NOTE** • Please power off the projector after any connected devices are powered off.

• This projector has the AUTO POWER OFF function that can make the projector turn off automatically. For more information, please see the “Operating Guide” in the CD.

## Replacing the lamp

A lamp has finite product life. Using the lamp for long periods of time could cause the pictures darker or the color tone poor. Note that each lamp has a different lifetime, and some may burst or burn out soon after you start using them. Preparation of a new lamp and early replacement are recommended. To prepare a new lamp, make contact with your dealer and tell the lamp type number.

**Type number :** ( ) \*!, & <8232>

**Type number :** ( ) \*!, %\$- K <8230W>

1. Turn the projector off, and unplug the power cord. Allow the projector to cool for at least 45 minutes.
2. Prepare a new lamp. If the projector is mounted on a wall or ceiling, or if the lamp has broken, also ask the dealer to replace the lamp.

**In case of replacement by yourself, follow the following procedure.**

3. Loosen the screw (marked by arrow) of the lamp cover and then slide and lift the lamp cover to the side to remove it.
4. Loosen the 2 screws (marked by arrow) of the lamp, and slowly pick up the lamp by the handle. Never loosen any other screws.
5. Insert the new lamp, and retighten firmly the 2 screws of the lamp that are loosened in the previous process to lock it in place.
6. While putting the interlocking parts of the lamp cover and the projector together, slide the lamp cover back in place. Then firmly fasten the screw of the lamp cover.
7. Turn the projector on and reset the lamp time using the LAMP TIME item in the SETUP menu.

- (1) Press the **MENU** button to display a menu.
- (2) Point at the **ADVANCED MENU** in the menu using the ▼/▲ button, then press the ► button.
- (3) Point at the **SETUP** in the left column of the menu using the ▼/▲ button, then press the ► button.
- (4) Point at the **LAMP TIME** using the ▼/▲ button, then press the ► button. A dialog will appear.
- (5) Press the ► button to select "OK" on the dialog. It performs resetting the lamp time.

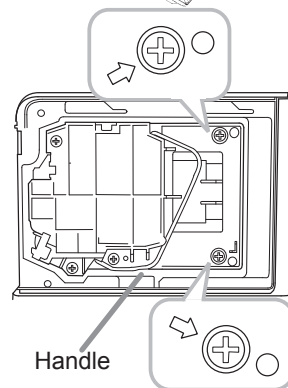
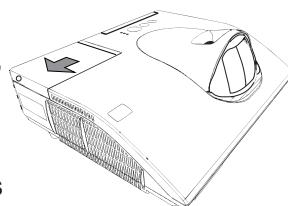
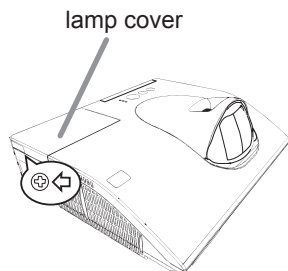

**⚠ CAUTION** ► Do not touch any inner space of the projector, while the lamp is taken out.

**NOTE** • Please reset the lamp time only when you have replaced the lamp, for a suitable indication about the lamp.

## Replacing the lamp (continued)

 **HIGH VOLTAGE**    **HIGH TEMPERATURE**    **HIGH PRESSURE**

**⚠ WARNING** ▶ The projector uses a high-pressure mercury glass lamp. The lamp can break with a loud bang, or burn out, if jolted or scratched, handled while hot, or worn over time. Note that each lamp has a different lifetime, and some may burst or burn out soon after you start using them. In addition, if the bulb bursts, it is possible for shards of glass to fly into the lamp housing, and for gas containing mercury and dust containing fine particles of glass to escape from the projector's vent holes.

▶ **About disposal of a lamp:** This product contains a mercury lamp; do not put it in a trash. Dispose of it in accordance with environmental laws.

- For lamp recycling, go to [www.lamprecycle.org](http://www.lamprecycle.org) (in the US).
- For product disposal, consult your local government agency or [www.eiae.org](http://www.eiae.org) (in the US) or [www.epsc.ca](http://www.epsc.ca) (in Canada).

For more information, ask your dealer.



Disconnect the plug from the power outlet

- If the lamp should break (it will make a loud bang when it does), unplug the power cord from the outlet, and make sure to request a replacement lamp from your local dealer. Note that shards of glass could damage the projector's internals, or cause injury during handling, so please do not try to clean the projector or replace the lamp yourself.
- If the lamp should break (it will make a loud bang when it does), ventilate the room well, and make sure not to inhale the gas or fine particles that come out from the projector's vent holes, and not to get them into your eyes or mouth.
- Before replacing the lamp, turn the projector off and unplug the power cord, then wait at least 45 minutes for the lamp to cool sufficiently. Handling the lamp while hot can cause burns, as well as damaging the lamp.



- Never unscrew except the appointed (marked by an arrow) screws.
- Do not open the lamp cover while the projector is mounted on a wall or ceiling. This is dangerous, since if the lamp's bulb has broken, the shards will fall out when the cover is opened. In addition, working in high places is dangerous, so ask your local dealer to have the lamp replaced even if the bulb is not broken.
- Do not use the projector with the lamp cover removed. At the lamp replacing, make sure that the screws are screwed in firmly. Loose screws could result in damage or injury.



- Use only the lamp of the specified type. Use of a lamp that does not meet the lamp specifications for this model could cause a fire, damage or shorten the life of this product.
- If the lamp breaks soon after the first time it is used, it is possible that there are electrical problems elsewhere besides the lamp. If this happens, consult your local dealer or a service representative.
- Handle with care: jolting or scratching could cause the lamp bulb to burst during use.
- Using the lamp for long periods of time, could cause it dark, not to light up or to burst. When the pictures appear dark, or when the color tone is poor, please replace the lamp as soon as possible. Do not use old (used) lamps; this is a cause of breakage.

## Cleaning and replacing the air filter

The air filter has two kinds of filters inside. Please check and clean the air filter periodically. When the indicators or a message prompts you to clean the air filter, comply with it as soon as possible. If the filters are damaged or heavily soiled, replace them with the new ones. To prepare the new filters, make contact with your dealer and tell the following type number.

**Type number : UX37191** (Filter set)

When you replace the lamp, please replace the air filter. An air filter of specified type will come together with a replacement lamp for this projector.

1. Turn the projector off, and unplug the power cord. Allow the projector to sufficiently cool down.
2. Use a vacuum cleaner on and around the filter cover.
3. Slide the filter unit upward to take it off from the projector.
4. Use a vacuum cleaner for the filter vent of the projector.
5. Take the fine meshed filter out while holding the filter cover. It is recommended to leave the coarse meshed filter in the filter cover as it is.
6. Use a vacuum cleaner on both sides of the fine meshed filter while holding it so it will not be sucked in. Use a vacuum cleaner for the inside of the filter cover to clean up the coarse meshed filter. If the filters are damaged or heavily soiled, replace them with new ones.
7. Put the fine meshed filter on the coarse meshed one, turning its plastic band side up.
8. Put the filter unit back into the projector.
9. Turn the projector on and reset the filter time using the FILTER TIME item in the EASY MENU.
  - (1) Press the **MENU** button to display a menu.
  - (2) Point at the FILTER TIME using the **▼/▲** button, then press the **▶** button. A dialog will appear.
  - (3) Press the **▶** button to select "OK" on the dialog. It performs resetting the filter time.

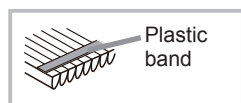
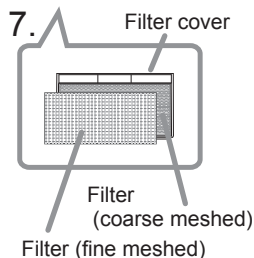
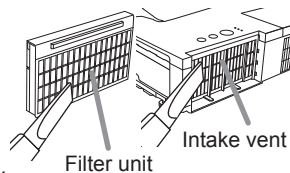
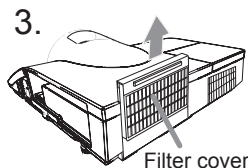

**▲WARNING ▶** Before taking care of the air filter, make sure the power cable is not plugged in, then allow the projector to cool sufficiently.

▶ Use only the air filter of the specified type. Do not use the projector without the air filter or the filter cover. It could result in a fire or malfunction to the projector.

▶ Clean the air filter periodically. If the air filter becomes clogged by dust or the like, internal temperatures rise and could cause a fire, a burn or malfunction to the projector.

**NOTE** • Please reset the filter time only when you have cleaned or replaced the air filter, for a suitable indication about the air filter.  
• The projector may display the message such as the "CHECK THE AIR FLOW" or turn off the projector, to prevent the internal heat level rising.



# Replacing the internal clock battery

Installing the battery is required in some cases. (📖Event Scheduling in the User's Manual - Network Guide) A battery is not contained at the time of factory shipment. Please replace a battery according to the following procedure.

1. Turn the projector off, and unplug the power cord.  
Allow the projector to cool sufficiently.
2. After making sure that the projector has cooled adequately, slowly turn over the projector, so that the bottom is facing.
3. Turn the battery cover fully in the direction indicated "OPEN" using a coin or the like, and pick the cover up to remove it..
4. Pry up the battery using a flathead screwdriver or the like to take it out. While prying it up, put a finger lightly on the battery since it may pop out of the holder.
5. Replace the battery with a new HITACHI MAXELL, Part No.CR2032 or CR2032H. Slide the battery in under the plastic claw, and push it into the holder until it clicks.
6. Replace the battery cover in place, then turn it in the direction indicated "CLOSE" using such as coins, to fix.

Battery Cover

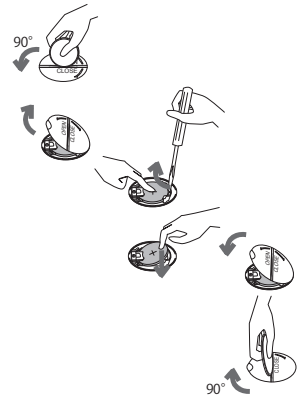
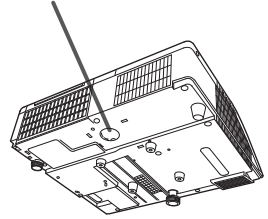

**⚠ WARNING** ► Always handle the batteries with care and use them only as directed. Battery may explode if mistreated. Do not recharge, disassemble or dispose of in fire.

And also improper use may result in cracking or leakage, which could result in fire, injury and/or pollution of the surrounding environment.

- Be sure to use only the batteries specified.
- Make sure the plus and minus terminals are correctly aligned when loading a battery.
- Keep a battery away from children and pets. If swallowed consult a physician immediately for emergency treatment.
- Do not short circuit or solder a battery.
- Do not allow a battery in a fire or water. Keep batteries in a dark, cool and dry place.
- If you observe battery leakage, wipe out the leakage and then replace a battery. If the leakage adheres to your body or clothes, rinse well with water immediately.
- Obey the local laws on disposing a battery.

## **Using the manuals**

See the Dukane web site Downloads for these models. There it provides the latest version manuals and links to the available software.

# Specifications

Item	Specification		
Product name	Liquid crystal projector		
Liquid Crystal Panel	, & & 786,432 pixels (1024 horizontal x 768 vertical) , & \$K: 1,024,000 pixels (1280 horizontal x 800 vertical)		
Lamp	225W UHP: , & & 250W UHP: , & \$K		
Speaker	16W		
Power supply	AC 100-120V/3.5A, AC 220-240V/1.7A : 8232 AC 100-120V/3.7A, AC 220-240V/1.8A : 8230W		
Power consumption	AC 100-120V:340 W, AC 220-240V:320W : 8232 AC 100-120V:360 W, AC 220-240V:350W : 8230W		
Temperature range	0 ~ 40°C (Operating) 35 ~ 40°C (The brightness of the lamp is reduced automatically.)		
Size	345 (W) x 85 (H) x 303 (D) mm * Not including protruding parts. Refer to figure <b>F-6</b> at the back of this manual.		
Weight (mass)	approx. 3.7kg		
Ports	<table border="0"> <tr> <td style="vertical-align: top;"> <b>Computer input port</b>            COMPUTER IN1            ..... D-sub 15 pin mini x1  <b>Computer input/output port</b>            COMPUTER IN2/MONITOR OUT            ..... D-sub 15 pin mini x1  <b>Video input port</b>            VIDEO ..... RCA x1         </td> <td style="vertical-align: top; padding-left: 20px;"> <b>HDMI input port</b>            HDMI ..... HDMI connector x2  <b>Audio input/output port</b>            AUDIO IN1 ..... Stereo mini x1            AUDIO IN2 (R, L) ..... RCA x2            AUDIO OUT ..... Stereo mini x1  <b>Others</b>            USB TYPE A ..... USB-Ax2            USB TYPE B ..... USB-Bx1            CONTROL ..... D-sub 9 pin x1            LAN ..... RJ45 x1            MIC ..... Mono mini x1         </td> </tr> </table>	<b>Computer input port</b> COMPUTER IN1 ..... D-sub 15 pin mini x1 <b>Computer input/output port</b> COMPUTER IN2/MONITOR OUT ..... D-sub 15 pin mini x1 <b>Video input port</b> VIDEO ..... RCA x1	<b>HDMI input port</b> HDMI ..... HDMI connector x2 <b>Audio input/output port</b> AUDIO IN1 ..... Stereo mini x1 AUDIO IN2 (R, L) ..... RCA x2 AUDIO OUT ..... Stereo mini x1 <b>Others</b> USB TYPE A ..... USB-Ax2 USB TYPE B ..... USB-Bx1 CONTROL ..... D-sub 9 pin x1 LAN ..... RJ45 x1 MIC ..... Mono mini x1
<b>Computer input port</b> COMPUTER IN1 ..... D-sub 15 pin mini x1 <b>Computer input/output port</b> COMPUTER IN2/MONITOR OUT ..... D-sub 15 pin mini x1 <b>Video input port</b> VIDEO ..... RCA x1	<b>HDMI input port</b> HDMI ..... HDMI connector x2 <b>Audio input/output port</b> AUDIO IN1 ..... Stereo mini x1 AUDIO IN2 (R, L) ..... RCA x2 AUDIO OUT ..... Stereo mini x1 <b>Others</b> USB TYPE A ..... USB-Ax2 USB TYPE B ..... USB-Bx1 CONTROL ..... D-sub 9 pin x1 LAN ..... RJ45 x1 MIC ..... Mono mini x1		
Optional parts	<b>Lamp:</b> 456-8232 < , & & <b>Lamp:</b> 456-8109W < , & \$K > <b>Filter set:</b> UX37191  <b>USB wireless adapter:</b> USB-WL-11N * For more information, please consult your dealer.		

**Note:** The Dukane models described in this document are manufactured by Hitachi and use the same firmware, software programs, control code, and accessory parts. The equivalent Dukane to Hitachi models are; 8230W (CP-BW301WN), and 8232 (CP-BX301WN).

## Troubleshooting - Warranty and after-service

If an abnormal operation (such as smoke, strange odor or excessive sound) should occur, stop using the projector immediately.

Otherwise if a problem occurs with the projector, first refer to “Troubleshooting” of “Operating Guide” and “Network Guide”, and run through the suggested checks.

If this does not resolve the problem, please consult your dealer or service company. They will tell you what warranty condition is applied.

Please check the following web address where you may find the latest information for this projector.

### DUKANE CORP AV SERVICE DEPT

2900 Dukane Drive  
St Charles, IL 60174  
800-676-2487 / 630-762-4032  
Fax 630-584-5156  
avservice@dukane.com  
www.dukaneav.com

**NOTE** • The information in this manual is subject to change without notice.

- The illustrations in this manual are for illustrative purposes. They may differ slightly from your projector.
- The manufacturer assumes no responsibility for any errors that may appear in this manual.
- The reproduction, transfer or copy of all or any part of this document is not permitted without express written consent.

### Trademark acknowledgment

- Mac®, Macintosh® and Mac OS® are registered trademarks of Apple Inc.
- Adobe® and Acrobat®, Reader® are registered trademarks of Adobe Systems Incorporated.
- Microsoft®, Internet explorer®, Windows® and Windows Vista® are registered trademarks of Microsoft Corporation in the U.S. and/or other countries.
- HDMI, the HDMI logo and High-Definition Multimedia Interface are trademarks or registered trademarks of HDMI Licensing LLC in the United States and other countries.
- Blu-ray Disc™ and Blu-ray™ are trademarks of Blu-ray Disc Association.

All other trademarks are the properties of their respective owners.

### End User License Agreement for the Projector Software

- Software in the projector consists of the plural number of independent software modules and there exist our copyright or/and third party copyrights for each of such software modules.
- Be sure to read “End User License Agreement for the Projector Software” which is separated document. (in the CD)

**F-1**

- On a horizontal surface

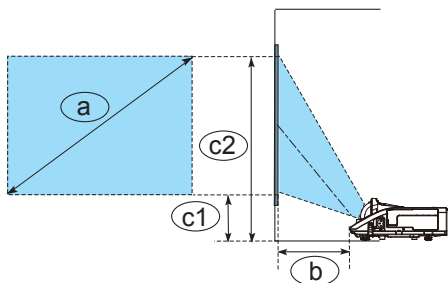

**F-2**

- Suspended from the ceiling

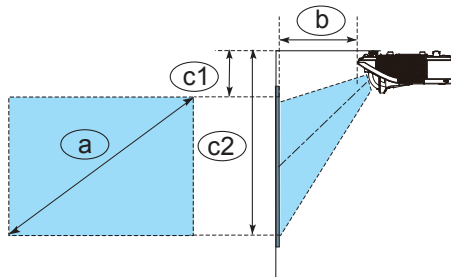

**T-1 8232**

(1024 x 768) (±8%)

(a) Screen size (diagonal)		(b) Projection distance		(c1) Screen height		(c2) Screen height	
type(inch)	m	m	inch	m	inch	m	inch
60	1.5	0.468	18.4	0.111	4.4	1.025	40.4
70	1.8	0.556	21.9	0.118	4.7	1.185	46.7
80	2.0	0.645	25.4	0.126	5.0	1.345	53.0
90	2.3	0.734	28.9	0.134	5.3	1.505	59.3
100	2.5	0.822	32.4	0.141	5.6	1.665	65.6
120	3.0	1.000	39.4	0.156	6.2	1.985	78.2
150	3.8	1.266	49.8	0.179	7.1	2.465	97.1

**T-2 8230W**

(1280 x 800) (±8%)

(a) Screen size (diagonal)		(b) Projection distance		(c1) Screen height		(c2) Screen height	
type(inch)	m	m	inch	m	inch	m	inch
60	1.5	0.500	19.7	0.194	7.6	1.002	39.4
70	1.8	0.594	23.4	0.216	8.5	1.158	45.6
80	2.0	0.688	27.1	0.237	9.3	1.314	51.7
90	2.3	0.782	30.8	0.259	10.2	1.470	57.9
100	2.5	0.876	34.5	0.280	11.0	1.627	64.0
120	3.0	1.064	41.9	0.323	12.7	1.939	76.3
150	3.8	1.346	53.0	0.388	15.3	2.407	94.8

**F-3**

**VCR/DVD/Blu-ray Disc player**

**Computer**

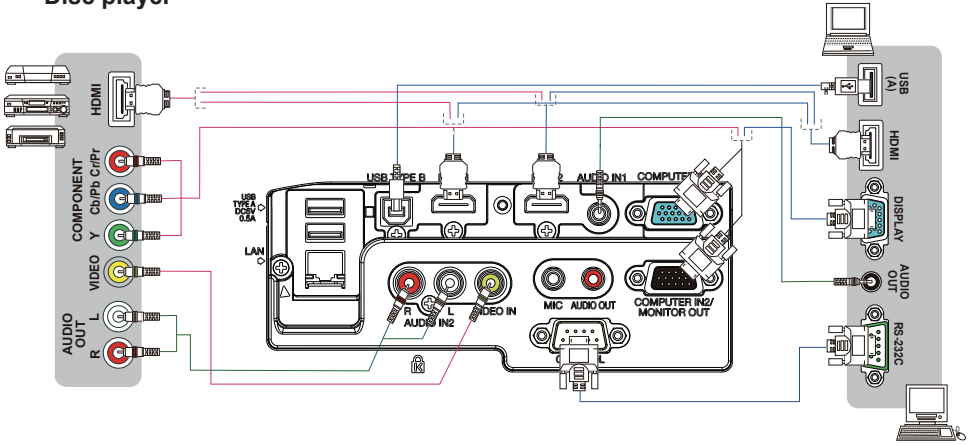

**F-4**

**Speakers (with an amplifier)**

**Monitor**

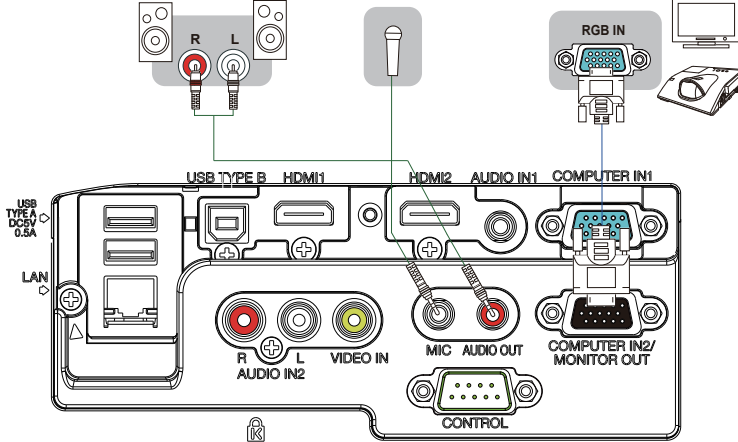

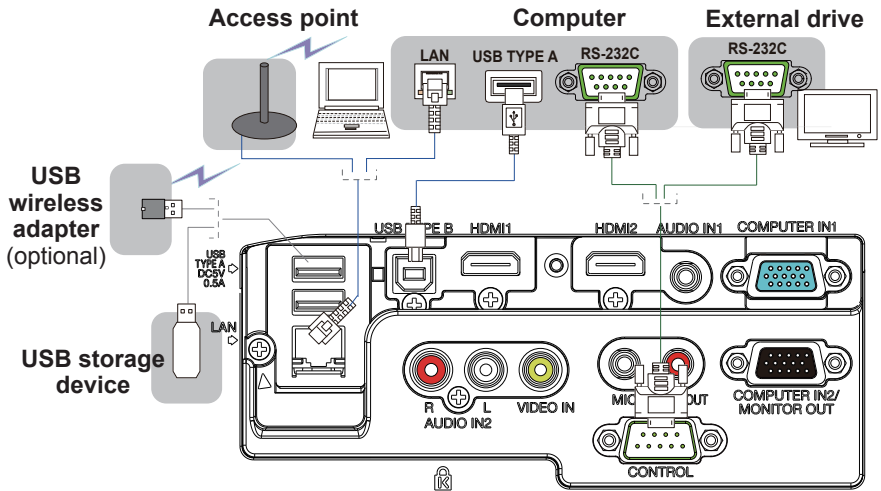

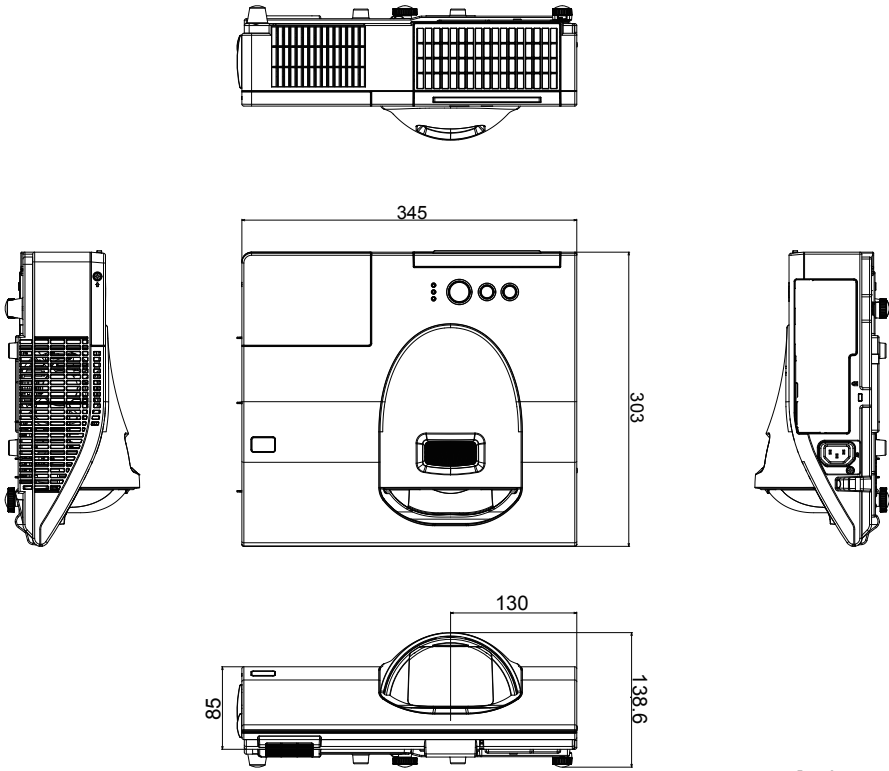

[unit: mm]



**F-7**

(1)

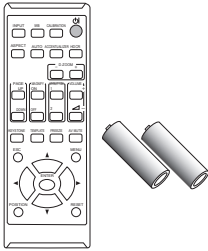

(2)

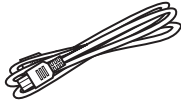

(3)

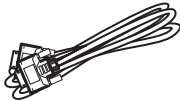

(4)

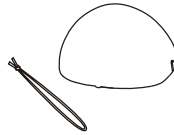

(5) Info Sheet

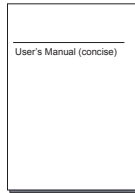

(6)

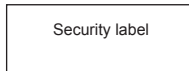

(7)

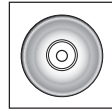

On Dukane Web site.

(8)

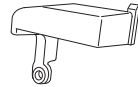

**DUKANE CORP AV SERVICE DEPT**

2900 Dukane Drive  
St Charles, IL 60174  
800-676-2487 / 630-762-4032  
Fax 630-584-5156  
avservice@dukane.com  
www.dukaneav.com

## Free Manuals Download Website

<http://myh66.com>

<http://usermanuals.us>

<http://www.somanuals.com>

<http://www.4manuals.cc>

<http://www.manual-lib.com>

<http://www.404manual.com>

<http://www.luxmanual.com>

<http://aubethermostatmanual.com>

Golf course search by state

<http://golfingnear.com>

Email search by domain

<http://emailbydomain.com>

Auto manuals search

<http://auto.somanuals.com>

TV manuals search

<http://tv.somanuals.com>