

DUKANE

Liquid Crystal Projector

Model 8768



USER'S MANUAL

Important Information

Safety Cautions

Precautions

Please read this manual carefully before using your 8768 Projector and keep the manual handy for future reference. Your serial number is located on the bottom of your projector. Record it here:

CAUTION



To turn off main power, be sure to remove the plug from power outlet.
The power outlet socket should be installed as near to the equipment as possible, and should be easily accessible.

CAUTION



TO PREVENT SHOCK, DO NOT OPEN THE CABINET.
NO USER-SERVICEABLE PARTS INSIDE.
REFER SERVICING TO QUALIFIED NEC SERVICE PERSONNEL.



This symbol warns the user that uninsulated voltage within the unit may be sufficient to cause electrical shock. Therefore, it is dangerous to make any kind of contact with any part inside of the unit.



This symbol alerts the user that important information concerning the operation and maintenance of this unit has been provided.
The information should be read carefully to avoid problems.

WARNING: TO PREVENT FIRE OR SHOCK, DO NOT EXPOSE THIS UNIT TO RAIN OR MOISTURE.
DO NOT USE THIS UNIT'S PLUG WITH AN EXTENSION CORD OR IN AN OUTLET UNLESS ALL THREE PRONGS CAN BE FULLY INSERTED.
DO NOT OPEN THE CABINET. THERE ARE HIGH-VOLTAGE COMPONENTS INSIDE. ALL SERVICING MUST BE DONE BY QUALIFIED NEC SERVICE PERSONNEL.

DOC Compliance Notice

This Class B digital apparatus meets all requirements of the Canadian Interference-Causing Equipment Regulations.

Acoustic Noise Information Ordinance-3. GSGV:

The sound pressure level is less than 70 dB (A) according to ISO 3744 or ISO 7779.

CAUTION

- Avoid displaying stationary images for a prolonged period of time.
Doing so can result in these images being temporarily sustained on the surface of the LCD panel.
If this should happen, continue to use your projector. The static background from previous images will disappear.
- Do not put the projector on its side when the lamp is turned on.
Doing so may cause damage to the projector.

WARNING TO CALIFORNIA RESIDENTS:

Handling the cables supplied with this product, will expose you to lead, a chemical known to the State of California to cause birth defects or other reproductive harm. Wash hands after handling.

RF Interference**WARNING**

The Federal Communications Commission does not allow any modifications or changes to the unit EXCEPT those specified by Solutions (America), Inc. in this manual. Failure to comply with this government regulation could void your right to operate this equipment. This equipment has been tested and found to comply with the limits for a Class B digital device, pursuant to Part 15 of the FCC Rules. These limits are designed to provide reasonable protection against harmful interference in a residential installation. This equipment generates, uses, and can radiate radio frequency energy and, if not installed and used in accordance with the instructions, may cause harmful interference to radio communications. However, there is no guarantee that interference will not occur in a particular installation.

If this equipment does cause harmful interference to radio or television reception, which can be determined by turning the equipment off and on, the user is encouraged to try to correct the interference by one or more of the following measures:

- Reorient or relocate the receiving antenna.
- Increase the separation between the equipment and receiver.
- Connect the equipment into an outlet on a circuit different from that to which the receiver is connected.
- Consult the dealer or an experienced radio / TV technician for help.

In UK, a BS approved power cable with moulded plug has a Black (five Amps) fuse installed for use with this equipment. If a power cable is not supplied with this equipment please contact your supplier.

Important Safeguards

These safety instructions are to ensure the long life of your projector and to prevent fire and shock. Please read them carefully and heed all warnings.

Installation

1. For best results, use your projector in a darkened room.
2. Place the projector on a flat, level surface in a dry area away from dust and moisture.
3. Do not place your projector in direct sunlight, near heaters or heat radiating appliances.
4. Exposure to direct sunlight, smoke or steam can harm internal components.
5. Handle your projector carefully. Dropping or jarring can damage internal components.
6. Do not place heavy objects on top of the projector.
7. If you wish to have the projector installed on the ceiling:
 - a. Do not attempt to install the projector yourself.
 - b. The projector must be installed by qualified technicians in order to ensure proper operation and reduce the risk of bodily injury.
 - c. In addition, the ceiling must be strong enough to support the projector and the installation must be in accordance with any local building codes.
 - d. Please consult your dealer for more information.

Fire and Shock Precautions

1. Ensure that there is sufficient ventilation and that vents are unobstructed to prevent the build-up of heat inside your projector. Allow at least 4 inches (10 cm) of space between your projector and a wall.
2. Prevent foreign objects such as paper clips and bits of paper from falling into your projector.
Do not attempt to retrieve any objects that might fall into your projector.
Do not insert any metal objects such as a wire or screwdriver into your projector. If something should fall into your projector, disconnect it immediately and have the object removed by a qualified service personnel.
3. Do not place any liquids on top of your projector.
4. Do not look into the lens while the projector is on. Serious damage to your eyes could result.
5. Keep any items such as magnifying glass out of the light path of the projector. The light being projected from the lens is extensive, therefore any kind of abnormal objects that can redirect light coming out of the lens, can cause unpredictable outcome such as fire or injury to the eyes.
6. Do not cover the lens with the supplied lens cap or equivalent while the projector is on. Doing so can lead to melting of the cap and possibly burning your hands due to the heat emitted from the light output.
7. The projector is designed to operate on a power supply of 100--240 V 50/60 Hz AC. Ensure that your power supply fits this requirement before attempting to use your projector.
8. Handle the power cable carefully and avoid excessive bending.
A damaged cord can cause electric shock or fire.
9. If the projector is not to be used for an extended period of time, disconnect the plug from the power outlet.
10. Do not touch the power plug during a thunderstorm. Doing so can cause electrical shock or fire.

CAUTION

- Do not try to touch the ventilation outlet on the left side (when seen from the front) as it can become heated while the projector is turned on.
- Do not use the tilt-foot for purposes other than originally intended.
Misuses such as gripping the tilt-foot or hanging on the wall can cause damage to the projector.
- Do not send the soft carrying case by parcel delivery service or cargo shipment. The projector inside the soft carrying case could be damaged. (However, it is possible to use it as a carriercase on board.)
- Enable High-Speed Fan mode if you continue to use the projector for consecutive days. (From the menu, select [Setup] → [Page 4] → [Fan Mode].)
- Do not unplug the power cable from the wall outlet under any one of the following circumstances.
Doing so can cause damage to the projector:
 - * While the Hour Glass icon appears.
 - * While the cooling fans are running. (The cooling fans continue to work for 10 seconds after the projector is turned off).

Lamp Replacement

- To replace the lamp, follow all instructions provided on page 107.
- Be sure to replace the lamp when the message **“The lamp has reached the end of its usable life. Please replace the lamp.”** appears. If you continue to use the lamp after the lamp has reached the end of its usable life, the lamp bulb may shatter, and pieces of glass may be scattered in the lamp case. Do not touch them as the pieces of glass may cause injury.

If this happens, contact your dealer for lamp replacement.

- Allow a minimum of 10 seconds to elapse after turning off the projector.

Then turn off the main power switch, disconnect the power cable and allow 60 minutes to cool the projector before replacing the lamp.

Table of Contents

Important Information	2
1. Introduction	8
1 What's in the Box?	9
2 Introduction to the Projector	10
3 Part Names of the Projector	12
Carrying the Projector	13
Top Features	14
Terminal Panel Features	15
4 Remote Control Features	17
2. Installation and Connections	20
1 Setting Up the Screen and the Projector	21
Selecting a Location	21
Throw Distance and Screen Size	22
2 Making Connections	23
Enabling the computer's external display	23
Connecting Your PC or Macintosh Computer	23
To connect SCART output (RGB)	24
Connecting an External Monitor	25
Connecting Your DVD Player with Component Output	26
Connecting Your VCR or Laser Disc Player	27
Connecting the Supplied Power Cable	28
3. Projecting an Image (Basic Operation)	29
1 Turning on the Projector	30
2 Selecting a Source	32
3 Adjusting the Picture Size and Position	33
4 Correcting Keystone Distortion	35
5 Optimizing RGB Picture Automatically	37
6 Turning Up or Down Volume	37
7 Turning off the Projector	38
8 After Use	38
4. Convenient Features	39
1 Switching Operation Mode between Computer and Projector	40
2 Turning Off the Image and Sound	40
3 Freezing a Picture	40
4 Using the Pointer	41
5 Enlarging and Moving a Picture	41
6 Getting the On-line Help	42
7 Using a USB Mouse	42
8 Using the Remote Mouse Function	43
9 Correcting Horizontal and Vertical Keystone Distortion (Cornerstone)	44
10 Making Freehand Drawings on a Projected Image (ChalkBoard)	47

⑪ Storing Images Displayed on the Projector on the PC card or USB Memory (Capture)	48
⑫ Preventing the Unauthorized Use of the Projector	49
⑬ Using a USB Memory Device or USB Memory Card Reader	54
5. Using the Viewer	55
① Making the Most out of the Viewer Function	56
② Operating the Viewer Function from the Projector	58
③ Changing Background Logo	64
6. Using Dynamic Image Utility 2.0 on the supplied CD-ROM	65
① End User License Agreement	66
② Introduction	67
③ Operating Environment	68
④ Equipment Connections and Settings	69
⑤ Software Installation	69
⑥ Starting/Exiting the Software	70
⑦ Troubleshooting	72
7. Using On-Screen Menu	73
① Using the Menus	74
② Menu tree	75
③ Menu Elements	77
④ Menu Descriptions & Functions [Adjust]	78
⑤ Menu Descriptions & Functions [Image]	82
⑥ Menu Descriptions & Functions [Setup]	85
⑦ Menu Descriptions & Functions [Information]	100
⑧ Menu Descriptions & Functions [Reset]	101
⑨ Entry List	102
8. Maintenance	104
① Cleaning the Filters	105
② Cleaning the Cabinet	105
③ Cleaning the Lens	106
④ Replacing the Lamp and Filters	107
9. Appendix	110
① Troubleshooting	111
② Specifications	114
③ Cabinet Dimensions	116
④ Pin Assignments of D-Sub COMPUTER 1/2 Input Connector	117
⑤ Compatible Input Signal List	118
⑥ PC Control Codes and Cable Connection	119
⑦ Using Software Keyboard	120

1

Introduction

.....

1 What's in the Box?	9
2 Introduction to the Projector	10
3 Part Names of the Projector	12
Carrying the Projector	13
Top Features	14
Terminal Panel Features	15
4 Remote Control Features	17

1 What's in the Box?

Make sure your box contains everything listed. If any pieces are missing, contact your dealer. Please save the original box and packing materials if you ever need to ship your VT770 Projector.

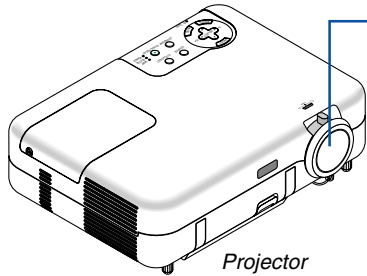

Lens cap

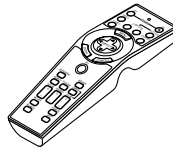

Remote control

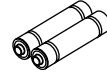

Batteries (AA × 2)

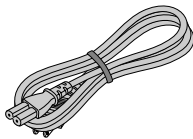

Power cable

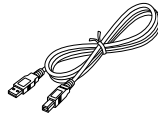

USB cable

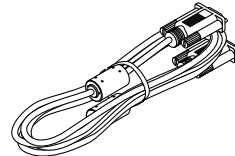

RGB signal cable

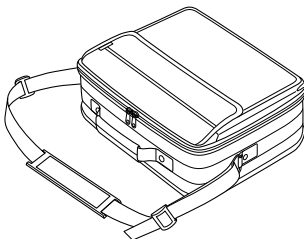

Soft carrying case

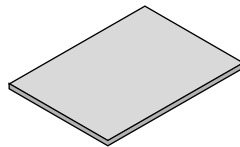

User's Manual

② Introduction to the Projector

This section introduces you to the 8768 Projector and describes key features and controls.

Congratulations on Your Purchase of the VT770 Projector

The 8768 is a sophisticated three panel LCD XGA projector that produces an enhanced display in less than an 8-pound (4kg) design. With the 8768 you will be able to project images up to 300" (measured diagonally). Enjoy crisp and sharp large screen display from your DVD player, VCR, satellite hookup, HDTV source, PC, Workstation or Macintosh computer (desktop or notebook) and images from your digital camera PC Card, compact flash memory or USB storage device. The 8768 provides for enhanced security options to help deter projector theft and provides for full projector control through RS232 support. With input and output flexibility, long lamp life and a full function remote, the 8768 lets you enjoy larger than life viewing from a compact and easy to setup and use projector.

Features you'll enjoy on the VT770:

- Automatic vertical keystone correction for fast and easy application setup
- Built-in Wall Color Correction presets provide for adaptive color correction when projecting onto non-white screen material.
- 3D Reform™ enhanced image technology for increased projector versatility that provides for horizontal, vertical and diagonal keystone correction (allows for positioning the projector in off center locations in the room and still get aligned images)
- USB memory or PC card interfaces provide for computerless presentations
- Enhanced smart security settings for password protection, control panel lock, menu lock and PC card protection key to help prevent unauthorized access, adjustments and theft deterrence
- UXGA compatible, XGA native resolution
- Variable audio out control of external amplified speakers via the projector
- Extensive user adjustable picture and color management settings
- Core technologies – Advanced Image Processing for highest quality of display and ease of use
- Display 16:9 or 4:3 aspect ratio information and fill the screen
- HDTV (1080i, 720p) and SDTV (480p, 480i) compatibility
- Digital photo viewer to display larger than life images from your digital cameras PC card, compact flash card or USB storage device
- Easy set up, use and operation
- Manual zoom and manual focus lens
- Whisper Mode lamp technology for increased lamp life, reduced energy consumption and overall total cost of ownership savings
- Wireless remote control operation
- External control via RS232

- 8768 has exclusive intelligent pixel blending technology which provides for extremely accurate image compression and HDTV (1920x1080 and 1280x720) display resolution*.
- Supports most IBM VGA, SVGA, XGA, Macintosh, component signal (YCbCr/YPbPr) or other RGB signals within a horizontal frequency range of 15 to 100 kHz and a vertical frequency range of 50 to 120 Hz. This includes NTSC, NTSC4.43, PAL, PAL-M, PAL-N, PAL60 and SECAM standard video signals

NOTE: Composite video standards are as follows:

NTSC: U.S. TV standard for video in U.S. and Canada.

PAL: TV standard used in Western Europe.

PAL-N: TV standard used in Argentine, Paraguay and Uruguay.

PAL-M: TV standard used in Brazil.

PAL60: TV standard used for NTSC playback on PAL TVs.

SECAM: TV standard used in France and Eastern Europe.

NTSC4.43: TV standard used in Middle East countries.

*1 Do not attempt to mount the projector on the ceiling yourself. To ensure proper operation and reduce the risk of bodily injury a qualified technician must install the projector. In addition, the ceiling must be strong enough to support the projector and the installation must be in accordance with any local building codes. Please consult your dealer for more information.

*2 HDTV 1080i (1920 × 1080) and HDTV 720 p (1280 × 720) are displayed.

3 Part Names of the Projector

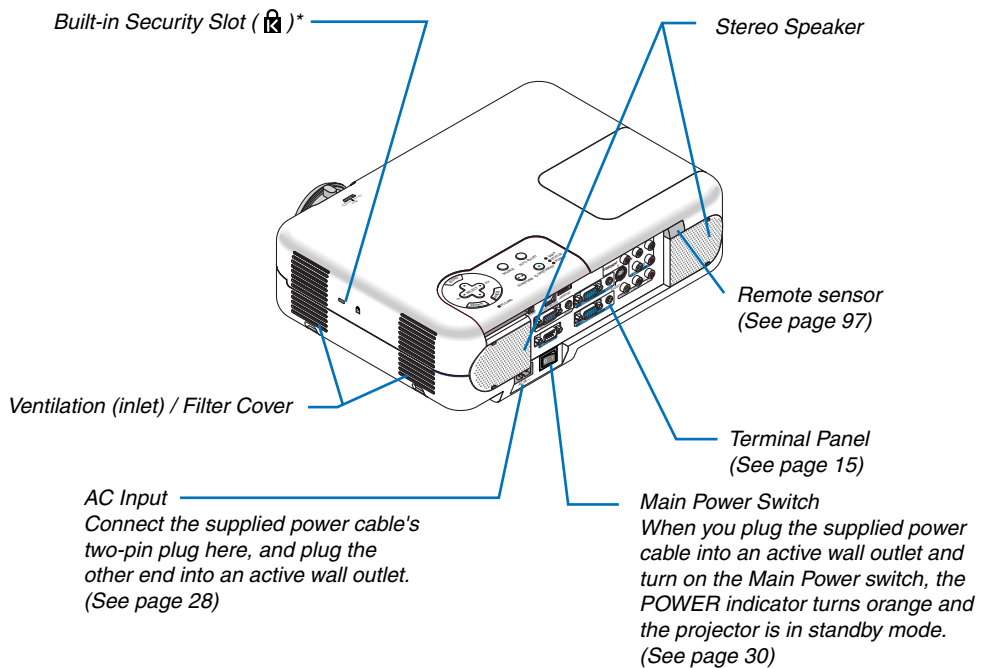
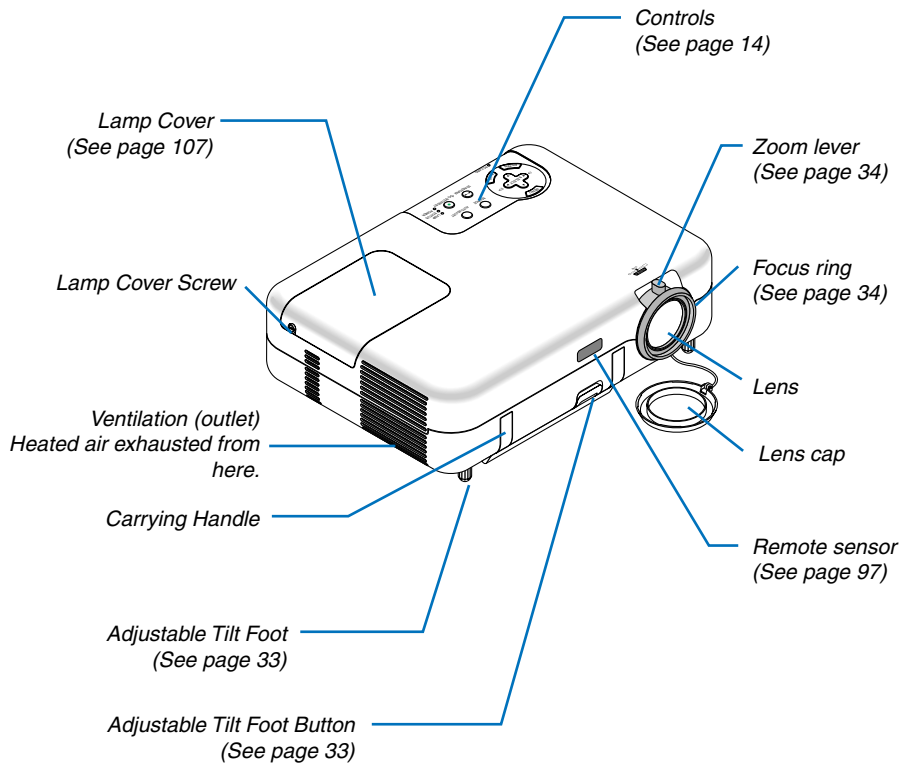

* This security slot supports the MicroSaver® Security System. MicroSaver® is a registered trademark of Kensington Microware Inc. The logo is trademarked and owned by Kensington Microware Inc.

Carrying the Projector

Always carry your projector by the handle.

Ensure that the power cable and any other cables connecting to video sources are disconnected before moving the projector.

When moving the projector or when it is not in use, cover the lens with the lens cap.

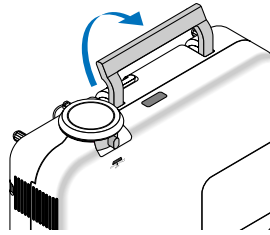

Top Features

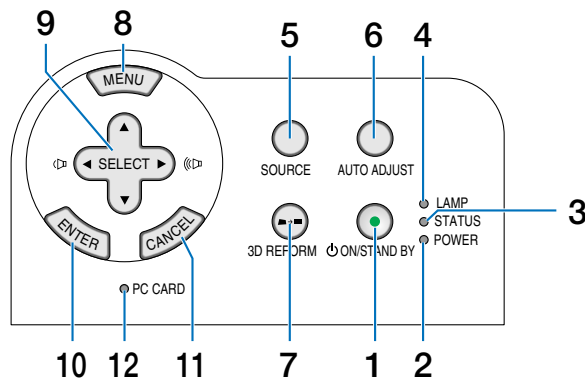
**1. POWER Button (ON / STAND BY) (⏻)**

Use this button to turn the power on and off when the main power is supplied.

To turn on or off the projector, press and hold this button for a minimum of two seconds.

2. POWER Indicator

When this indicator is green, the projector is on; when this indicator is orange, it is in standby mode. See the Power Indicator section on page 111 for more details.

3. STATUS Indicator

If this light blinks red rapidly, it indicates that an error has occurred, the lamp cover is not attached properly or the projector has overheated.

If this light remains orange, it indicates that you have pressed a cabinet button while the Cabinet Button is locked. See the Status Indicator section on page 111 for more details.

4. LAMP Indicator

If this light blinks red rapidly, it's warning you that the lamp has reached the end of its usable life. After this light appears, replace the lamp as soon as possible (See page 107). If this is lit green continually, it indicates that the lamp mode is set to Eco. See the Lamp Indicator section on page 111 for more details.

5. SOURCE Button

Use this button to select a video source such as a PC, VCR, DVD player or Viewer (PC card).

Press and release this button quickly to display the Source List.

Each time this button is pressed for a minimum of ONE second, the input source will change as follows:

Computer1 → Computer2 → Component → Video → S-Video → Viewer → Entry List → Computer1 → ...

If no input signal is present, the input will be skipped.

6. AUTO ADJ. Button

Use this button to adjust Position-H/V and Pixel Clock/Phase for an optimal picture (See page 37). Available for the RGB signal only.

7. 3D REFORM Button

Press this button to enter 3D Reform mode to correct the keystone (trapezoidal) distortion, and make the image square. See pages 35 and 44.

8. MENU Button

Displays the menu.

9. SELECT ▲▼◀▶ / Volume Buttons

▲▼ : Use these buttons to select the menu of the item you wish to adjust.

◀▶ : Use these buttons to change the level of a selected menu item.

A press of the ▶ button executes the selection. When no menus appear, these buttons work as a volume control.

When an image is magnified, the SELECT ▲▼◀▶ button moves the image.

10. ENTER Button

Executes your menu selection and activates items selected from the menu.

11. CANCEL Button

Pressing this button will return to the previous menu. While you are in the main menu, pressing this button will close the menu.

12. PC CARD Access Indicator

Lights while accessing a PC card.

Terminal Panel Features

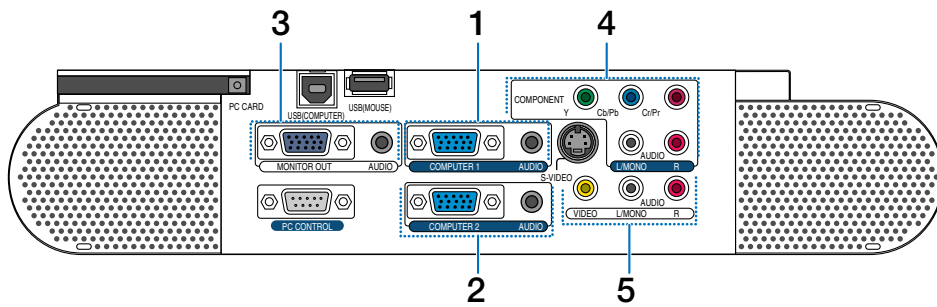

1. COMPUTER 1 Input Connector (Mini D-Sub 15 Pin)

Connect your computer or other analog RGB equipment such as IBM compatible or Macintosh computers. Use the supplied RGB cable to connect to your computer.

COMPUTER 1 AUDIO Input Mini Jack (Stereo Mini)

This is where you connect the audio output from your computer when connected to the COMPUTER 1 input. A commercially available audio cable is required.

2. COMPUTER 2 Input Connector (Mini D-Sub 15 Pin)

Connect your computer or other analog RGB equipment such as IBM compatible or Macintosh computers. Use the supplied RGB cable to connect to your computer.

This connector also supports SCART output signal.

The SCART cable is sold separately.

See page 24 for more details.

NOTE: The COMPUTER 2 Input does not support Plug & Play.

COMPUTER 2 AUDIO Input Mini Jack (Stereo Mini)

This is where you connect the audio output from your computer when connected to the COMPUTER 2 input. A commercially available audio cable is required.

3. MONITOR OUT Connector (Mini D-Sub 15 Pin)

You can use this connector to loop your computer image to an external monitor from the COMPUTER 1/2 or component video input source.

This connector also outputs a COMPUTER signal or component signal in Idle mode.

AUDIO OUT Mini Jack (Stereo Mini)

You can use this jack to output sound from the currently selected source (COMPUTER 1/2, COMPONENT, VIDEO or S-VIDEO). The current or last displayed source's audio will be sent to the audio output even in Idle mode.

Output sound level (volume, bass/treble and mute) can be adjusted in accordance with the sound level of the internal speaker.

Output sound level (volume, bass/treble and mute) cannot be adjusted in Idle mode.

Note that this cannot be used as a headphone jack. (When audio equipment is connected, the projector speaker is disabled.)

4. COMPONENT (Y, Cb/Pb, Cr/Pr) Input Connectors (RCA)

Connect component video outputs (Y/Cb/Cr, Y/Pb/Pr) of the external equipment such as DVD player.

NOTE: The "Y" connector accepts Video signal.

COMPONENT AUDIO Input Jacks R/L (RCA)

These are your left and right channel audio inputs for stereo sound from your DVD player or component equipment connected to COMPONENT Input Connectors.

5. VIDEO Input Connector (RCA)

Connect a VCR, DVD player, laser disc player, or document camera here to project video.

VIDEO/S-VIDEO AUDIO Input Jacks R/L (RCA)

These are your left and right channel audio inputs for stereo sound from a Video or S-Video source.

Terminal Panel Features

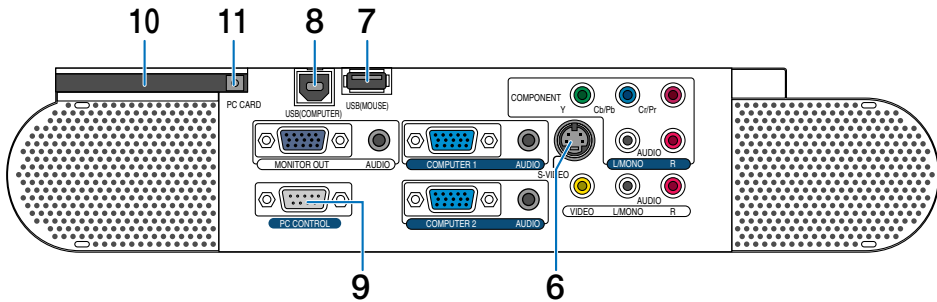

6. S-VIDEO Input Connector (Mini DIN 4 Pin)

Here is where you connect the S-Video input from an external source like a VCR.

NOTE: *S-Video provides more vivid color and higher resolution than the traditional composite video format.*

7. USB (MOUSE) Port (Type A)

Connect a commercially available USB mouse. You can operate the menu or Viewer with the USB mouse via this port.

8. USB (COMPUTER) Port (Type B)

Connect this port to the USB port (type A) of your PC using the supplied USB cable. You can operate your computer's mouse functions from the remote control.

9. PC CONTROL Port (D-Sub 9 Pin)

Use this port to connect your PC to control your projector via a serial cable. This enables you to use your PC and serial communication protocol to control the projector. A commercially available RS232C cross cable is required to use this port. You can also control the projector by using Dynamic Image Utility 2.0 included on the supplied CD-ROM.

To do so you must first have Dynamic Image Utility 2.0 installed on your PC. If you are writing your own program, typical PC control codes are on page 119.

10. PC CARD Slot

Insert a PC card here.

11. PC CARD Eject Button

Press to partially eject a PC card partially.

4 Part Names of the Remote Control

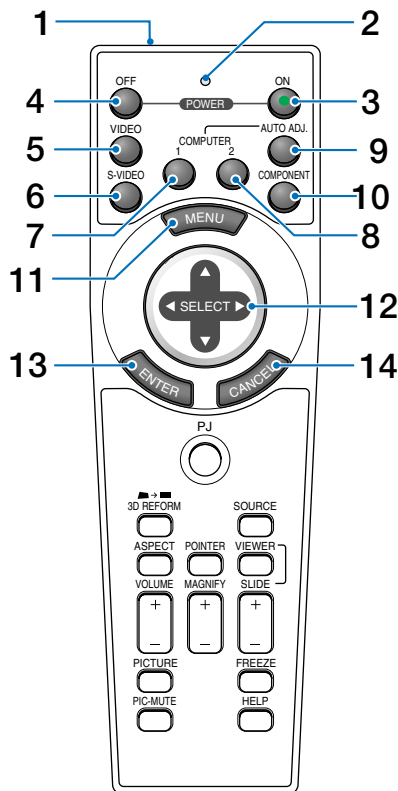

5. VIDEO Button
Press this button to select a video source from a VCR, DVD player, laser disc player or document camera.
6. S-VIDEO Button
Press this button to select an S-Video source from a VCR.
7. COMPUTER 1 Button
Press this button to select COMPUTER 1 input.
8. COMPUTER 2 Button
Press this button to select COMPUTER 2 input.
9. AUTO ADJ. Button
Use this button to adjust an RGB source for an optimal picture. See page 37.
10. COMPONENT Button
Press this button to select a video source from component equipment connected to your COMPONENT input.
11. MENU Button
Displays the menu for various settings and adjustments.

12. SELECT ▲▼◀▶ (Mouse) Button
When you are in the Computer mode, these buttons work as a computer mouse. When you are in the Projector mode, which is indicated by lighting the PJ button. See page 40.

- ▲▼ : Use these buttons to select the menu of the item you wish to adjust.
 - ◀▶ : Use these buttons to change the level of a selected menu item. A press of the ▶ button executes the selection. When no menus appear, these buttons work as a volume control.
- When an image is magnified, the SELECT ▲▼◀▶ button moves the image.

13. ENTER (Left Click) Button
When you are in the Computer mode, this button works as the mouse left button. When this button is pressed and held for a minimum of 2 seconds, the drag mode is set. When you are in the Projector mode, which is indicated by lighting the PJ button: Use this button to enter your menu selection. It works the same way as the ENTER button on the cabinet. See page 40.

14. CANCEL (Right Click) Button
When you are in the Computer mode, this button works as the mouse right button. When you are in the Projector mode, which is indicated by lighting the PJ button: It works the same way as the CANCEL button on the cabinet. See page 40.

NOTE: If you are using a Macintosh computer, you can click either the CANCEL (right-click) or ENTER (left-click) button to activate the mouse.

1. Infrared Transmitter
Direct the remote control toward the remote sensor on the projector cabinet.
2. LED
Flashes when any button is pressed.
3. POWER ON Button
When the main power is on, you can use this button to turn your projector on.

NOTE: To turn on the projector, press and hold the POWER ON button for a minimum of two seconds.

4. POWER OFF Button
You can use this button to turn your projector off.

NOTE: To turn off the projector, press and hold the POWER OFF button for a minimum of two seconds.

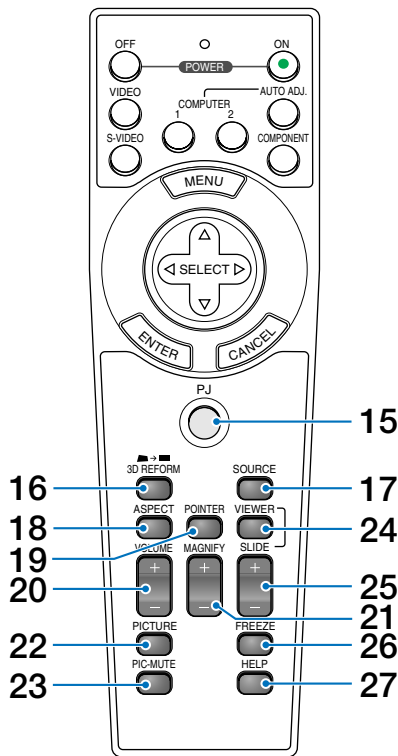

18. ASPECT Button
Press this button to display the Aspect Ratio select screen. See page 82.

19. POINTER Button
Press this button to display one of the nine pointers; press again to hide the pointer. You can move your pointer icon to the area you want on the screen using the SELECT ▲▼◀▶ button. See page 41.

20. VOLUME (+)(-) Button
Press (+) to increase the volume and (-) to decrease it.

NOTE: The default is the Computer mode, which allows you to use the SELECT, CANCEL, and ENTER buttons as your computer mouse. When the POWER ON/OFF, MENU, 3D REFORM, ASPECT, POINTER, HELP, MAGNIFY, VIEWER or PICTURE button is pressed, the PJ button lights red to indicate that you are in the Projector mode. If no buttons are pressed within 60 seconds, the light goes out and the Projector mode is canceled.

21. MAGNIFY (+)(-) Button
Use this button to adjust the image size up to 400%. The image is magnified about the center of the screen. See page 41.

22. PICTURE Button
Press this button to display the Picture window. Each time this button is pressed, the option will be changed. See page 78.

23. PIC-MUTE Button
This button turns off the image and sound for a short period of time. Press again to restore the image and sound.

24. VIEWER Button
Press this button to select the Viewer source.

25. SLIDE (+)(-) Button
Press (+) to select the next folder or slide and (-) to select the previous folder or slide. See page 58.

26. FREEZE Button
This button will freeze a picture. Press again to resume motion.

27. HELP Button
Provides suitable HELP information.

15. PJ Button
Press this button to switch the SELECT, CANCEL, and ENTER buttons between the Projector mode (lit red) and the Computer mode.

Press this button or any one of the POWER ON/OFF, MENU, 3D REFORM, ASPECT, POINTER, HELP, MAGNIFY, VIEWER or PICTURE buttons to switch to the Projector mode and the PJ button lights red. To switch back to the Computer mode, press the PJ button again. See page 40.

16. 3D REFORM Button
Press this button to enter 3D Reform to correct the keystone (trapezoidal) distortion, and make the image square. See pages 35 and 44.

17. SOURCE Button
Use this button to select a video source such as a PC, VCR, DVD player or Viewer (PC card). Press and release this button quickly to display the Source List. Each time this button is pressed for a minimum of ONE second, the input source will change as follows:

Computer1 → Computer2 → Component → Video → S-Video → Viewer → Entry List → Computer1 → ...

If no input signal is present, the input will be skipped.

Battery Installation

1 Remove the battery cover.

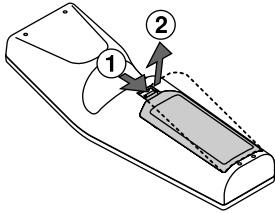

2 Remove both old batteries and install new ones (AA). Ensure that you have the batteries' polarity (+/-) aligned correctly.

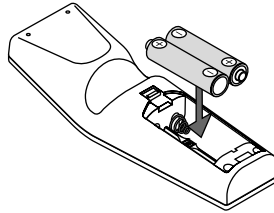

3 Slip the cover back over the batteries until it snaps into place. Do not mix different types of batteries or new and old batteries.

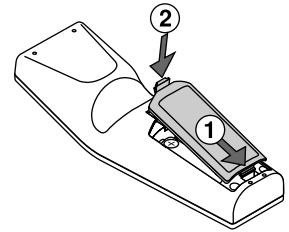

Note on Remote Control Operation

If you press and hold the SELECT \blacktriangle \blacktriangledown \blacktriangleleft \blacktriangleright button while installing new batteries, the remote control may fail to work properly.

Should this happen, remove the batteries and then install them again without touching the SELECT button.

Remote Control Precautions

- Handle the remote control carefully.
- If the remote control gets wet, wipe it dry immediately.
- Avoid excessive heat and humidity.
- If you will not be using the remote control for a long time, remove the batteries.
- Do not place the batteries upside down.
- Do not use new and old batteries together, or use different types of batteries together.

Operating Range for Wireless Remote Control

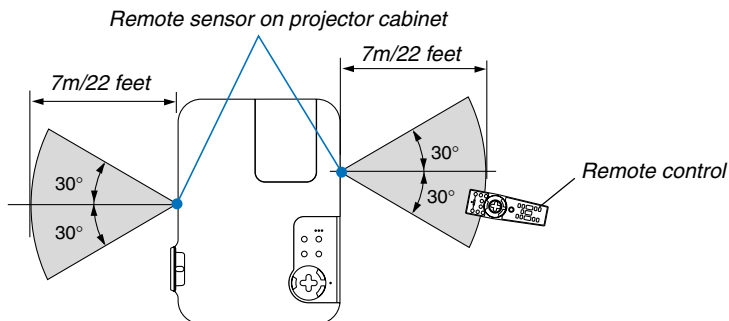

- The infrared signal operates by line-of-sight up to a distance of about 22 feet/7 m and within a 60-degree angle of the remote sensor on the projector cabinet.
 - The projector will not respond if there are objects between the remote control and the sensor, or if strong light falls on the sensor.
- Weak batteries will also prevent the remote control from properly operating the projector.

2

Installation and Connections

.....

1	Setting Up the Screen and the Projector	21
	Selecting a Location	21
	Throw Distance and Screen Size	22
2	Making Connections	23
	Enabling the computer's external display	23
	Connecting Your PC or Macintosh Computer	23
	To connect SCART output (RGB)	24
	Connecting an External Monitor	25
	Connecting Your DVD Player with Component Output	26
	Connecting Your VCR or Laser Disc Player	27
	Connecting the Supplied Power Cable	28

2. Installation and Connections

This section describes how to set up your projector and how to connect PCs, video and audio sources.

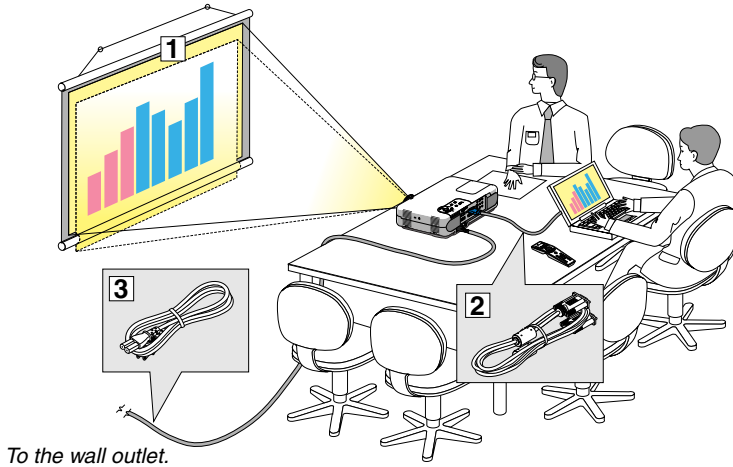

Your projector is simple to set up and use. But before you get started, you must first:

- 1 Set up a screen and the projector.
- 2 Connect your computer or video equipment to the projector. See pages 23 - 27.
- 3 Connect the supplied power cable. See page 28.

NOTE: Ensure that the power cable and any other cables are disconnected before moving the projector. When moving the projector or when it is not in use, cover the lens with the lens cap.

1 Setting Up the Screen and the Projector

Selecting a Location

The further your projector is from the screen or wall, the larger the image. The minimum size the image can be is approximately 25" (0.64 m) measured diagonally when the projector is roughly 31.5 inches (0.8 m) from the wall or screen. The largest the image can be is 300" (7.6 m) when the projector is about 393.7 inches (10 m) from the wall or screen. Use the drawing below as a guide.

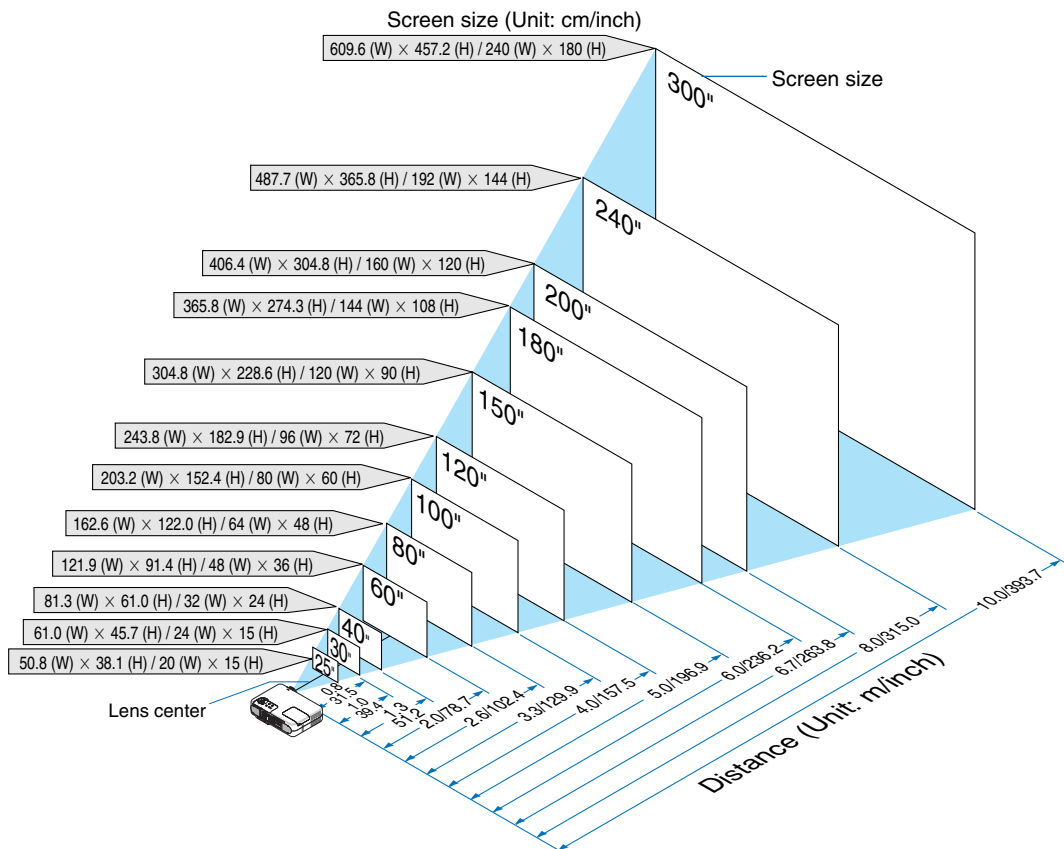

Throw Distance and Screen Size

The following shows the proper relative positions of the projector and screen. Refer to the table to determine the position of installation.

Distance Chart

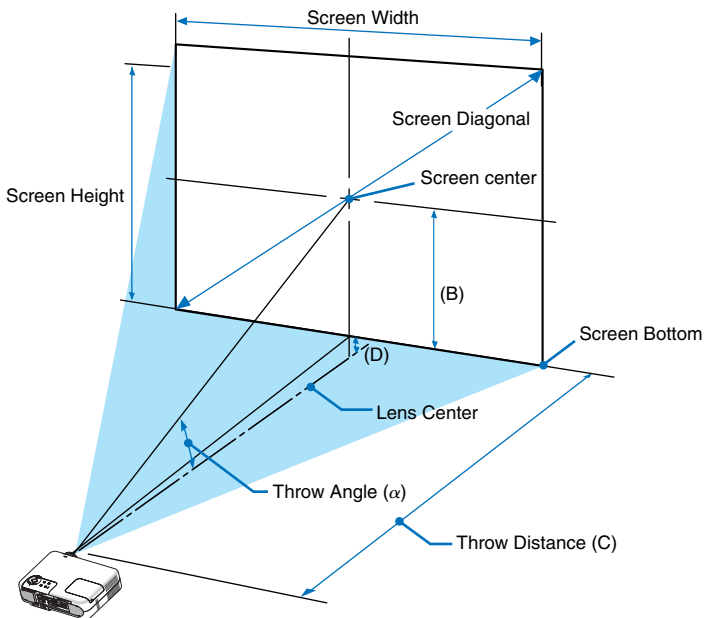

- B = Vertical distance between lens center and screen center
- C = Throw distance
- D = Vertical distance between lens center and bottom of screen (top of screen for ceiling application)
- α = Throw angle

NOTE: Distances may vary +/-5%.

Screen Size			B	C		D	α	
Diagonal	Width	Height		Wide - Tele	inch		Wide - Tele	degree
inch	inch	inch	inch	inch	inch	inch	degree	
25	20.0	15.0	6.0	28.0 - 34.0	-2.0	12.1 - 9.9		
30	24.0	18.0	7.0	34.0 - 41.0	-2.0	12.0 - 9.9		
40	32.0	24.0	10.0	46.0 - 56.0	-2.0	11.8 - 9.7		
60	48.0	36.0	14.0	70.0 - 85.0	-4.0	11.7 - 9.6		
67	54.0	40.0	16.0	78.0 - 95.0	-4.0	11.6 - 9.6		
72	58.0	43.0	17.0	84.0 - 102.0	-4.0	11.6 - 9.6		
80	64.0	48.0	19.0	94.0 - 114.0	-5.0	11.6 - 9.6		
84	67.0	50.0	20.0	98.0 - 120.0	-5.0	11.6 - 9.6		
90	72.0	54.0	22.0	106.0 - 128.0	-5.0	11.6 - 9.6		
100	80.0	60.0	24.0	118.0 - 143.0	-6.0	11.5 - 9.6		
120	96.0	72.0	29.0	141.0 - 172.0	-7.0	11.5 - 9.5		
150	120.0	90.0	36.0	177.0 - 215.0	-9.0	11.5 - 9.5		
180	144.0	108.0	43.0	213.0 - 258.0	-11.0	11.5 - 9.5		
200	160.0	120.0	48.0	237.0 - 287.0	-12.0	11.4 - 9.5		
220	176.0	132.0	53.0	261.0 - 316.0	-13.0	11.4 - 9.5		
240	192.0	144.0	58.0	285.0 - 345.0	-14.0	11.4 - 9.5		
260	208.0	156.0	62.0	309.0 - 374.0	-16.0	11.4 - 9.5		
280	224.0	168.0	67.0	333.0 - 403.0	-17.0	11.4 - 9.5		
300	240.0	180.0	72.0	356.0 - 431.0	-18.0	11.4 - 9.5		

Screen Size			B	C		D	α	
Diagonal	Width	Height		mm	Wide - Tele		mm	Wide - Tele
mm	mm	mm	mm	mm	mm	mm	degree	
635	508	381	152	710 - 870	-38	12.1 - 9.9		
762	610	457	183	860 - 1050	-46	12.0 - 9.9		
1016	813	610	244	1170 - 1420	-61	11.8 - 9.7		
1524	1219	914	366	1770 - 2160	-91	11.7 - 9.6		
1702	1361	1021	408	1990 - 2410	-102	11.6 - 9.6		
1829	1463	1097	439	2140 - 2600	-110	11.6 - 9.6		
2032	1626	1219	488	2380 - 2890	-122	11.6 - 9.6		
2134	1707	1280	512	2500 - 3040	-128	11.6 - 9.6		
2286	1829	1372	549	2680 - 3260	-137	11.6 - 9.6		
2540	2032	1524	610	2990 - 3620	-152	11.5 - 9.6		
3048	2438	1829	732	3590 - 4360	-183	11.5 - 9.5		
3810	3048	2286	914	4500 - 5460	-229	11.5 - 9.5		
4572	3658	2743	1097	5410 - 6560	-274	11.5 - 9.5		
5080	4064	3048	1219	6020 - 7290	-305	11.4 - 9.5		
5588	4470	3353	1341	6630 - 8030	-335	11.4 - 9.5		
6096	4877	3658	1463	7230 - 8760	-366	11.4 - 9.5		
6604	5283	3962	1585	7840 - 9490	-396	11.4 - 9.5		
7112	5690	4267	1707	8450 - 10230	-427	11.4 - 9.5		
7620	6096	4572	1829	9050 - 10960	-457	11.4 - 9.5		

WARNING

- * Installing your projector on the ceiling must be done by a qualified technician. Contact your NEC dealer for more information.
- * Do not attempt to install the projector yourself.
- Only use your projector on a solid, level surface. If the projector falls to the ground, you can be injured and the projector severely damaged.
- Do not use the projector where temperatures vary greatly. The projector must be used at temperatures between 32°F (0°C) and 95°F (35°C).
- Do not expose the projector to moisture, dust, or smoke. This will harm the screen image.

- Ensure that you have adequate ventilation around your projector so heat can dissipate. Do not cover the vents on the side of the projector.

Reflecting the Image

Using a mirror to reflect your projector's image enables you to enjoy a much larger image. Contact your NEC dealer if you need a mirror. If you're using a mirror and your image is inverted, use the MENU and SELECT buttons on your projector cabinet or your remote control to correct the orientation. See page 86.

2 Making Connections

NOTE: When using with a notebook PC, be sure to connect between the projector and the notebook PC before turning on the power to the notebook PC. In most cases signal cannot be output from RGB output unless the notebook PC is turned on after connecting with the projector.

** If the screen goes blank while using your remote control, it may be the result of the computer's screen-saver or power management software.*

** If you accidentally hit the POWER button on the remote control, wait 60 seconds and then press the POWER button again to resume.*

Enabling the computer's external display

Displaying an image on the notebook PC's screen does not necessarily mean it outputs a signal to the projector. When using a PC compatible laptop, a combination of function keys will enable/disable the external display. Usually, the combination of the 'Fn' key along with one of the 12 function keys gets the external display to come on or off. For example, NEC laptops use Fn + F3, while Dell laptops use Fn + F8 key combinations to toggle through external display selections.

Connecting Your PC or Macintosh Computer

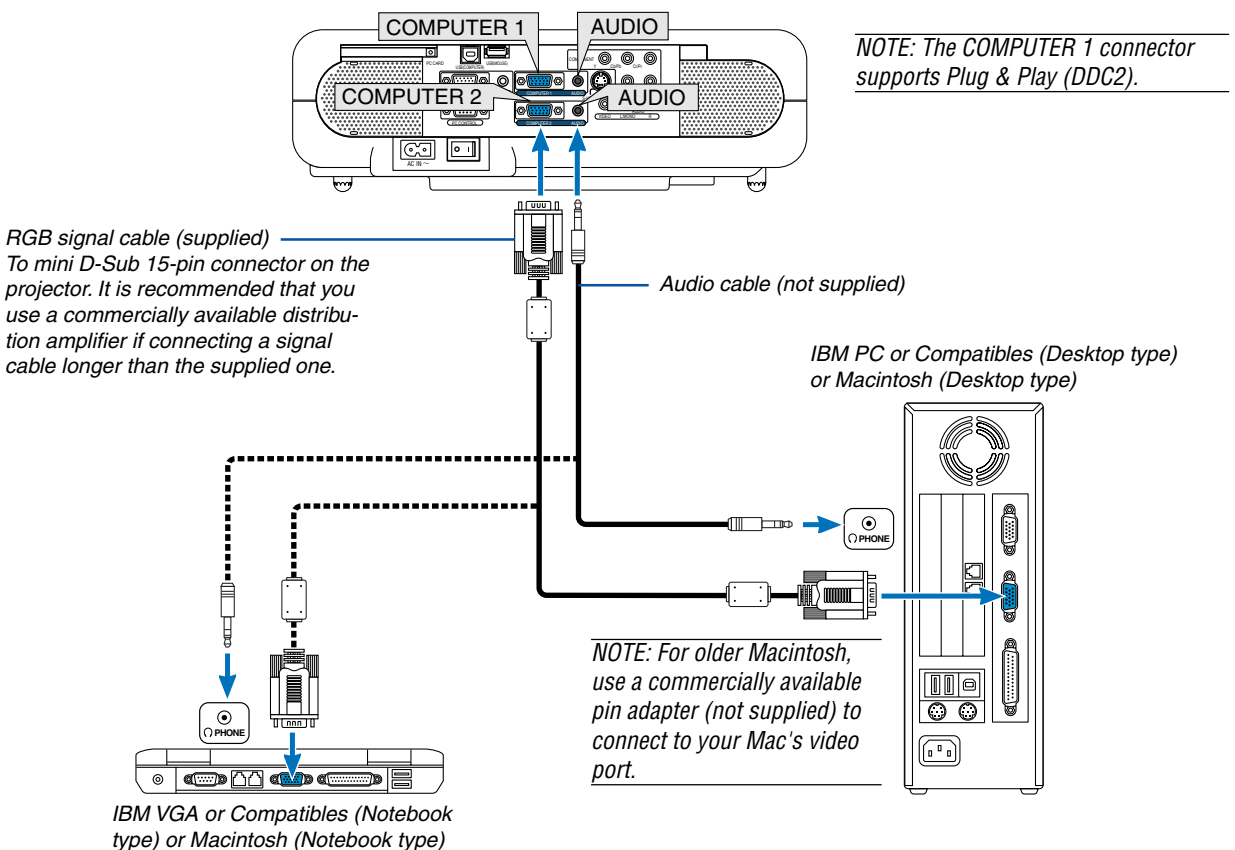

Connecting your PC or Macintosh computer to your projector will enable you to project your computer's screen image for an impressive presentation.

To connect to a PC or Macintosh, simply:

1. Turn off the power to your projector and computer.
2. Use the supplied signal cable to connect your PC or Macintosh to the projector.
3. Connect the supplied power cable. See page 28.
4. Turn on the projector and the computer.
5. If the projector goes blank after a period of inactivity, it may be caused by a screen saver installed on the computer you've connected to the projector.

2. Installation and Connections

NOTE: The 8768 is not compatible with video decoded outputs of special ISS-6020 and ISS-6010 switchers.

NOTE: An image may not be displayed correctly when a Video or S-Video source is played back via a commercially available scan converter.

This is because the projector will process a video signal as a computer signal at the default setting. In that case, do the following.

- * *When an image is displayed with the lower and upper black portion of the screen or a dark image is not displayed correctly:
Project an image to fill the screen and then press the AUTO ADJ button on the remote control or the AUTO ADJUST button on the projector cabinet.*
- * *When noise appears on the sides of the screen:
Use the Overscan feature to display the image correctly.
Be sure to change the Overscan to 0% before pressing the AUTO ADJ or AUTO ADJUST button, otherwise an image may be displayed with its sides cut off.*

To connect SCART output (RGB)

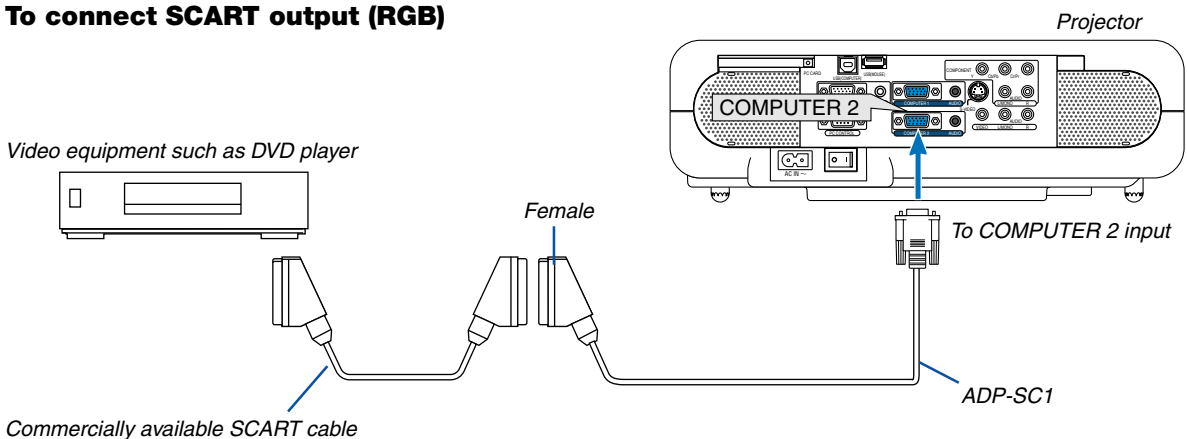

Before connections: An exclusive SCART adapter (ADP-SC1) and a commercially available SCART cable are required for this connection.

NOTE: Audio signal is not available for this connection.

1. Turn off the power to the projector and your video equipment.
2. Use the NEC ADP-SC1 SCART adapter and a commercially available SCART cable to connect the RGB input of your projector and a SCART output (RGB) of your video equipment.
3. Connect the supplied power cable. See page 28.
4. Turn on the power to the projector and your video equipment.
5. Use the COMPUTER 2 button on the remote control to select the COMPUTER 2 input.
6. Press the MENU button on the remote control to display the menu.
7. From the menu, select [Setup] → [Page3] → [Signal Select] → [Computer 2] → [Scart].
SCART is a standard European audio-visual connector for TVs, VCRs and DVD players. It is also referred to as Euro-connector.

NOTE: The ADP-SC1 SCART adapter is obtainable from your NEC dealer in Europe. Contact your NEC dealer in Europe for more information.

Connecting an External Monitor

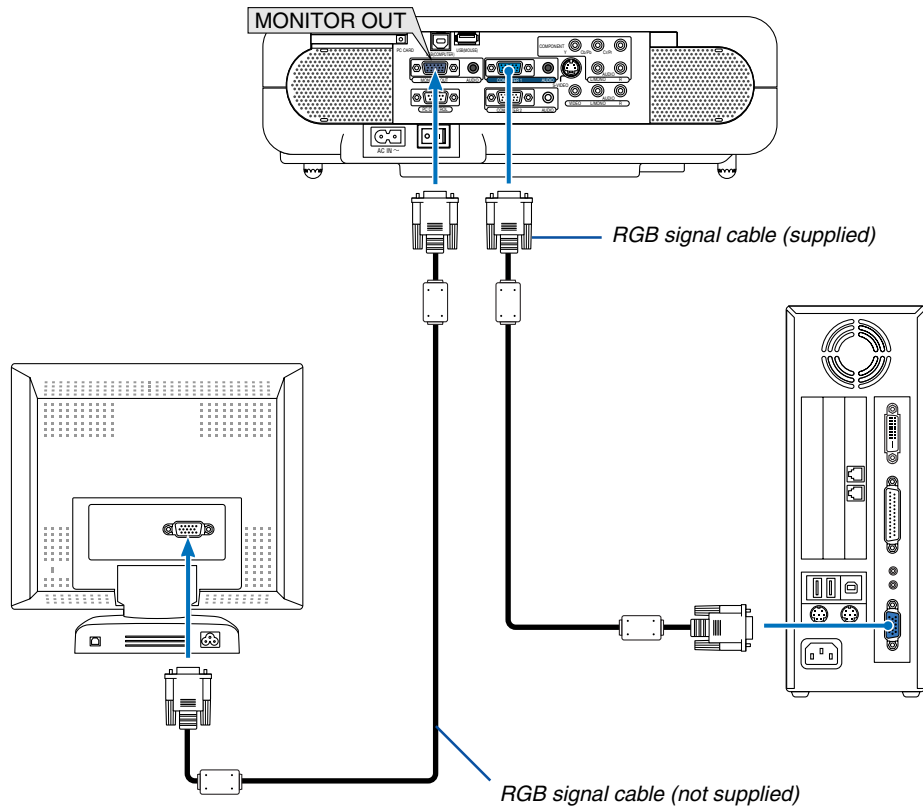

You can connect a separate, external monitor to your projector to simultaneously view on a monitor the RGB analog image you're projecting.

To do so:

1. Turn off the power to your projector, monitor and computer.
2. Use a 15-pin cable to connect your monitor to the MONITOR OUT (Mini D-Sub 15 pin) connector on your projector.
3. Connect the supplied power cable. See page 28.
4. Turn on the projector, monitor and the computer.

NOTE:

- The MONITOR OUT connector outputs RGB signal during Idle mode. When the projector goes into standby mode, the image on an external monitor disappears for a moment.
- When the projector is in the standby mode, the image may not be correctly displayed while the cooling fans are running immediately after turning on or off the power.
- Daisy chain connection is not possible.

Connecting Your DVD Player with Component Output

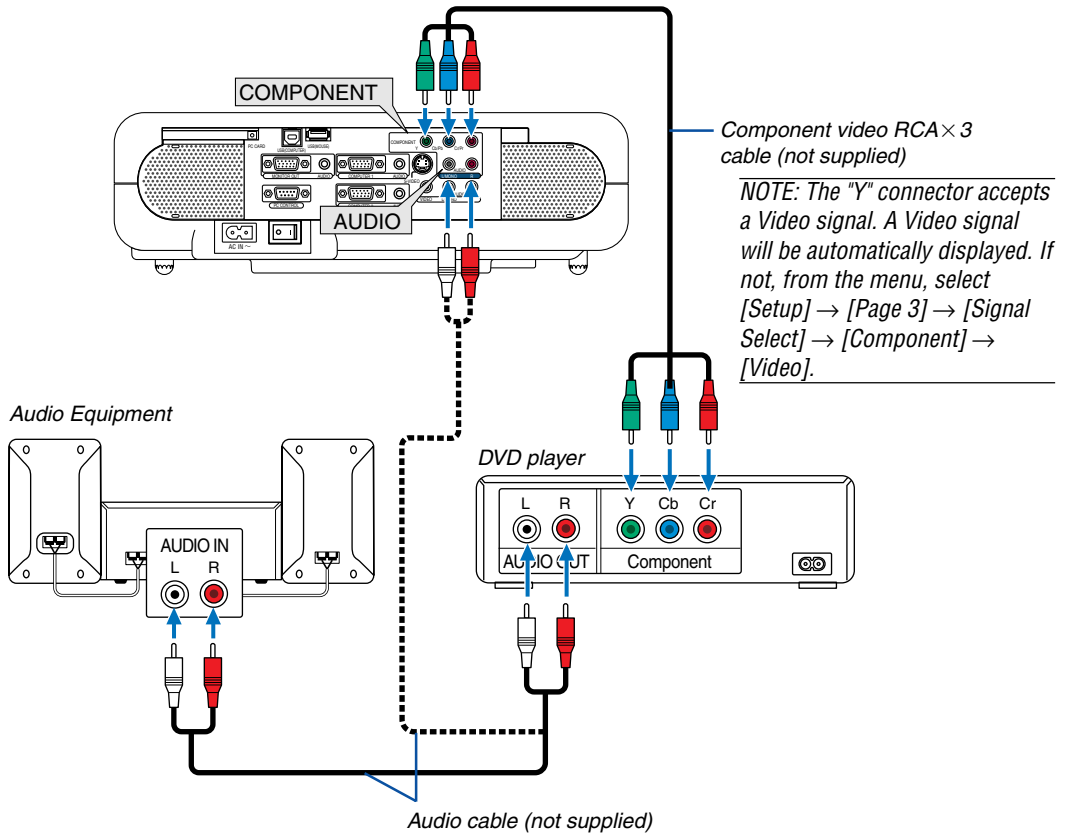

You can connect your projector to a DVD player with component output or Video output. To do so, simply:

NOTE: For a DVD player without component video (Y,Cb,Cr/Y, Pb, Pr) output, use an S-Video cable (not provided) to connect an S-Video output of the DVD player to the S-VIDEO input of the projector.

1. Turn off the power to your projector and DVD player.
2. If your DVD player has the component video (Y,Cb,Cr/Y, Pb, Pr) output, use a commercially available component video cable (RCA × 3) to connect your DVD player to the COMPONENT input connectors on the projector.

Use an audio cable (not supplied) to connect the audio from your DVD player to your audio equipment (if your DVD player has this capability). Be careful to keep your right and left channel connections correct for stereo sound.

3. Connect the supplied power cable. See page 28.
4. Turn on the projector and DVD player.

NOTE: Refer to your DVD player's owner's manual for more information about your DVD player's video output requirements.

Connecting Your VCR or Laser Disc Player

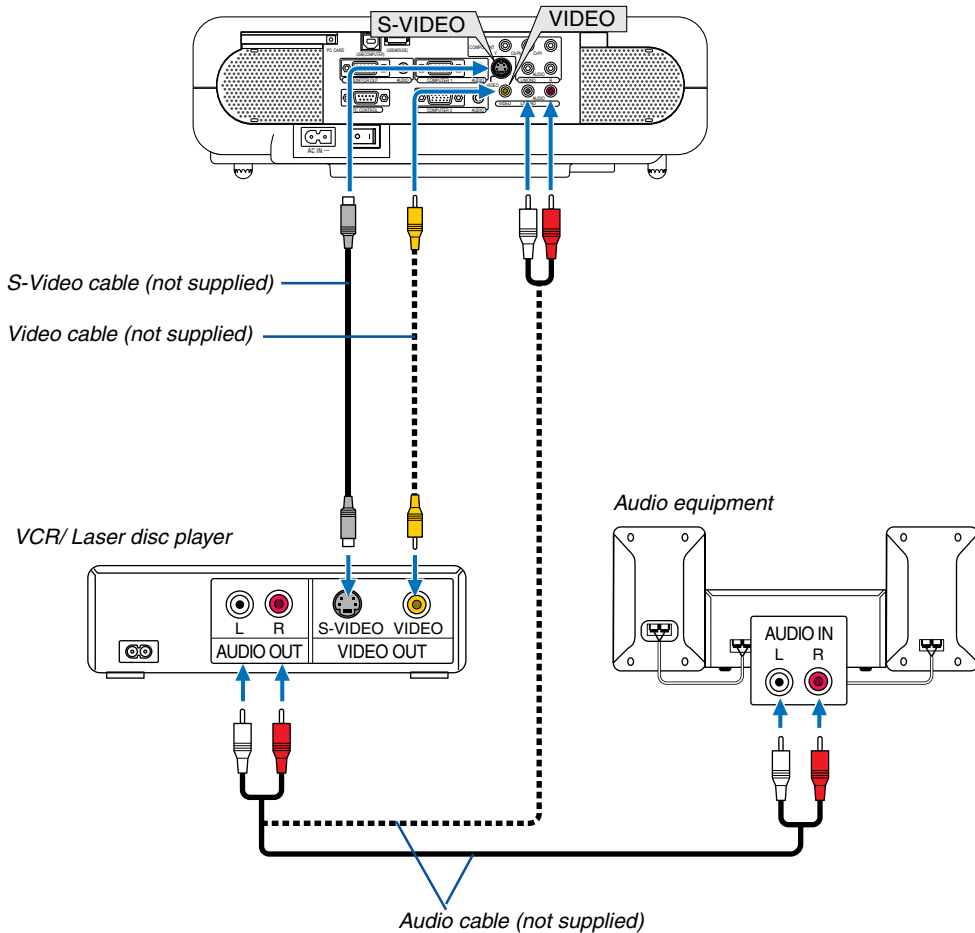

Use an RCA or S-Video cable (not provided) to connect the video and use RCA cables (not provided) to connect the audio from your VCR, laser disc player or document camera to your projector.

To make these connections, simply:

1. Turn off the power to the projector and VCR, laser disc player or document camera.
2. Connect one end of an RCA cable to the video output (or one end of an S-Video cable to the S-Video output connector) on the back of your VCR or laser disc player, connect the other end to the appropriate video input on your projector. Connect one end of a pair RCA cables (not supplied) to the audio output on the back of your VCR or laser disc player, connect the other end to your audio equipment or to the appropriate audio input on the projector.
Be careful to keep the right and left channel connections correct for stereo sound.
3. Connect the supplied power cable. See page 28.
4. Turn on the projector and the VCR or laser disc player.

NOTE: Refer to your VCR or laser disc player owner's manual for more information about your equipment's video output requirements.

NOTE: An image may not be displayed correctly when a Video or S-Video source is played back in fast-forward or fast-rewind via a scan converter.

Connecting the Supplied Power Cable

Connect the supplied power cable to the projector.

First connect the supplied power cable's two-pin plug to the AC IN of the projector, and then connect the other plug of the supplied power cable in the wall outlet.

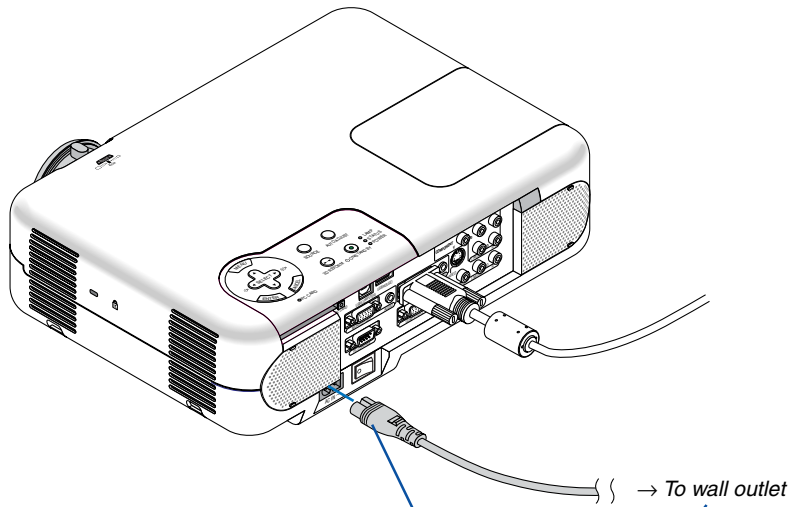

Make sure that the prongs are fully inserted into both the AC IN and the wall outlet.

3

Projecting an Image

(Basic Operation)

.....

❶	Turning on the Projector.....	30
❷	Selecting a Source	32
❸	Adjusting the Picture Size and Position	33
❹	Correcting Keystone Distortion	35
❺	Optimizing RGB Picture Automatically	37
❻	Turning Up or Down Volume	37
❼	Turning off the Projector.....	38
❽	After Use.....	38

3. Projecting an Image (Basic Operation)

This section describes how to turn on the projector and to project a picture onto the screen.

1 Turning on the Projector

NOTE:

- The projector has two power switches: a main power switch and a POWER (ON/STAND BY) button (POWER ON and OFF on the remote control).
- When plugging in or unplugging the supplied power cable, make sure that the main power switch is pushed to the off (O) position. Failure to do so may cause damage to the projector.

To turn on the main power to the projector, press the Main Power switch to the on position (I).

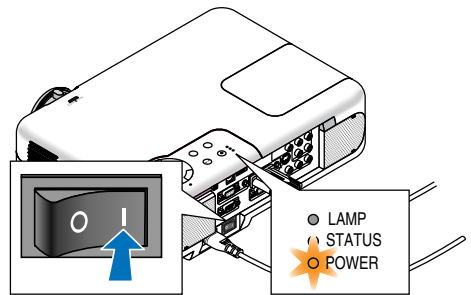

After you turn on your projector, ensure that the computer or video source is turned on and that your lens cap is removed.

Only after you press the POWER (ON/STAND BY) button on the projector cabinet or POWER ON button on the remote control for a minimum of 2 seconds will the power indicator turn to green and the projector become ready to use.

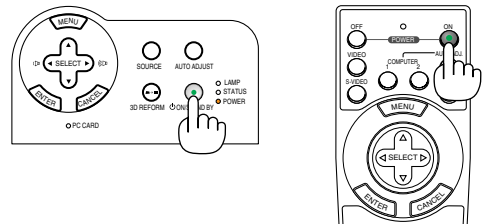

NOTE: When no signal is available, a blue, black or logo screen is displayed.

When the projector displays a blue or a black screen (not logo), the Eco mode will be automatically selected in "Lamp Mode."

3. Projecting an Image (Basic Operation)

Note on Startup screen (Menu Language Select screen)

When you first turn on the projector, you will get the Startup screen. This screen gives you the opportunity to select one of the 19 menu languages.

To select a menu language, follow these steps:

1. Use the **SELECT ▲** or **▼** button to select one of the 19 languages for the menu.

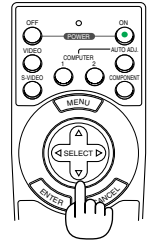
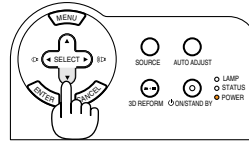
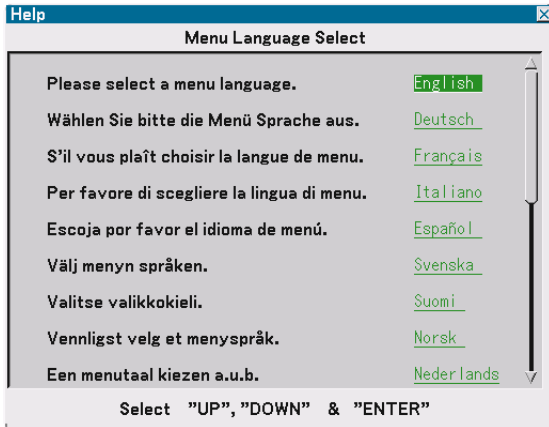

2. Press the **ENTER** button to execute the selection.

After this has been done, you can proceed to the menu operation.

If you want, you can select the menu language later. See "Language" on page 86.

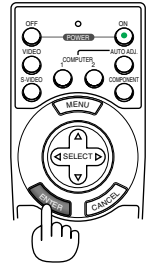
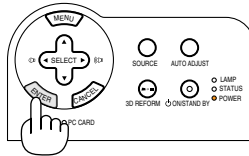

NOTE: Immediately after turning on the projector, screen flicker may occur. This is not a fault. Wait 3 to 5 minutes until the lamp lighting is stabilized.

When the Lamp mode is set to Eco, the Lamp indicator will light green.

If one of the following things happens, the projector will not turn on.

- If the internal temperature of the projector is too high, the projector detects abnormal high temperature. In this condition the projector will not turn on to protect the internal system. If this happens, wait for the projector's internal components to cool down.
- When the lamp reaches its end of usable life, the projector will not turn on. If this happens, replace the lamp. See page 107.
- If the lamp fails to light, and if the STATUS indicator flashes on and off in a cycle of six times, wait a full minute and then turn on the power.

③ Adjusting the Picture Size and Position

Place your projector on a flat level surface and ensure that the projector is square to the screen.

Lift the front edge of the projector to center the image vertically.

If the projected image does not appear square to the screen then use the Keystone feature for proper adjustment. See pages 35 and 44.

Rotate the projector's front right or left (to the right in this example) to center the image horizontally on the screen.

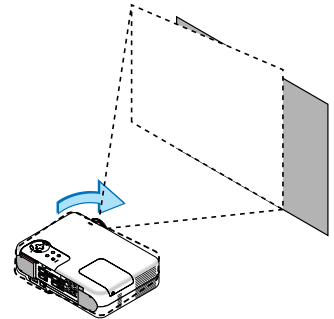
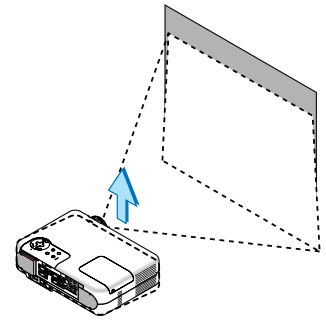

Adjust the Tilt Foot

1. Lift the front edge of the projector.
2. Push up and hold the Adjustable Tilt Foot Button on the front of the projector to extend the adjustable tilt feet (maximum height: 30mm/ 1.2").
3. Lower the front of the projector to the desired height.
4. Release the Adjustable Tilt Foot Button to lock the Adjustable tilt foot.

There is approximately 10 degrees of up and down adjustment for the front of the projector.

Adjusting the height of a projected image or changing projection angle will run the Auto Keystone correction function to quickly correct the vertical distortion. The "Keystone" screen will be displayed.

For operating the "Keystone" screen, see "④ Correcting Vertical Keystone Distortion" on page 35.

NOTE: Your "Keystone" correction data can be reset by pressing and holding the 3D REFORM button for a minimum of 2 seconds.

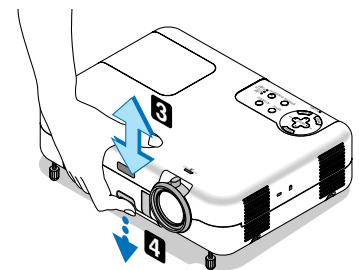
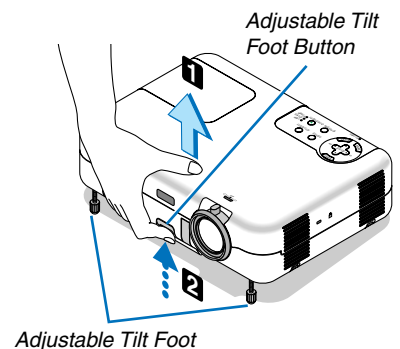

CAUTION

Do not use the tilt-foot for purposes other than originally intended. Misuses such as gripping the tilt-foot or hanging on the wall can cause damage to the projector.

3. Projecting an Image (Basic Operation)

Zoom

Use the ZOOM lever to finely adjust the image size on the screen.

You can use the ZOOM lever to enlarge or reduce an image size.

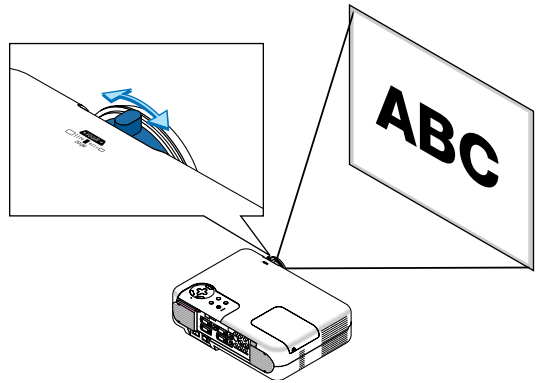

Focus

Use the FOCUS ring to obtain the best focus.

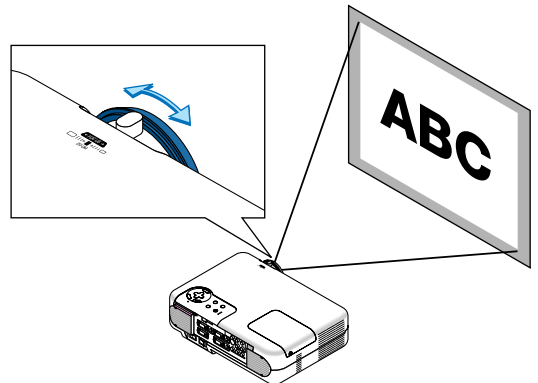

4 Correcting Keystone Distortion

Auto Keystone Correction

The Auto Keystone correction feature will correct vertical distortion of a projected image on the screen. No special operation required. Just put the projector on a flat surface.



Manual Keystone Correction

You can also correct keystone distortion manually. To do so:

1. Extend the Adjustable Tilt Foot to adjust the height of a projected image. See page 33.

The Keystone screen will be displayed on the screen.

- If the Keystone screen disappears, press the MENU button or ENTER button once to display the Keystone screen again.

2. Align the left (or right) side of the screen with the left (or right) side of the projected image.

- Use the shorter side of the projected image as the base.
- In the right example, use the left side as the base.

NOTE: When "Manual" is selected in "Keystone" from the menu, project an image adjusting projector position so that the screen is smaller than the area of the projected image. See page 87 for selecting "Manual" in "Keystone".

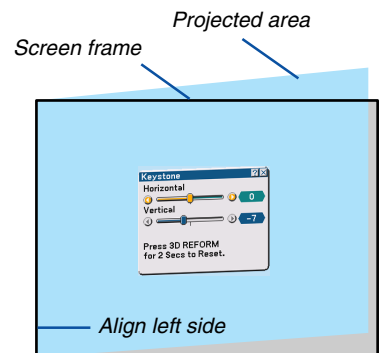
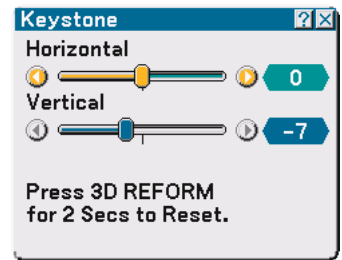

3. Use the SELECT ◀ or ▶ button to select "Horizontal".

Perform the keystone correction.

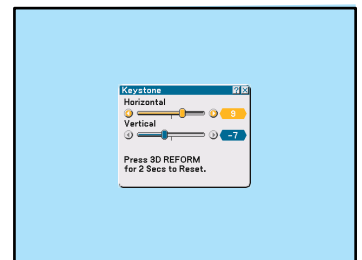

4. If the right and left sides of the projected image are not parallel to each other, use the SELECT ▼ button to select "Vertical" and use the SELECT ◀▶ button.

Fine adjust so that both sides are parallel to each other.

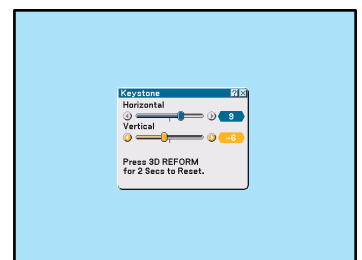

3. Projecting an Image (Basic Operation)

5. Repeat steps 3 and 4 to correct keystone distortion.

6. After completing Keystone correction, press the ENTER button.

The Keystone screen will disappear.

- To perform Keystone correction again, press the 3D REFORM button to display the Keystone screen and repeat above steps 1 to 6.



NOTE:

- Turning on the projector will reset the previous correction setting values if the projection angle is changed from the last use. If the projection angle is the same as in the last use, the previous correction setting values are retained in the memory. To use the previous correction setting values after changing projection angle, select "Manual" in "Keystone" from the menu. See page 87.
To return the 3D Reform correction setting values to the factory preset, press and hold the 3D REFORM button for a minimum of 2 seconds.
 - Each time the 3D REFORM button is pressed, the item will change as follows: Keystone → Cornerstone → None → Keystone → ...
For information on "Cornerstone", see "Correcting Horizontal and Vertical Keystone Distortion (Cornerstone) on page 44.
-

5 Optimizing RGB Picture Automatically

Adjusting the Image Using Auto Adjust

Optimizing an RGB image automatically.

Press the Auto Adjust button to optimize an RGB image automatically.

[Poor picture]

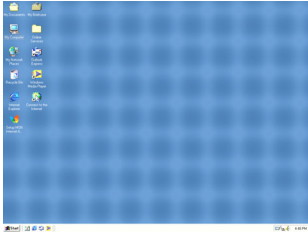

[Normal picture]

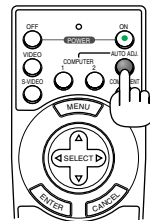
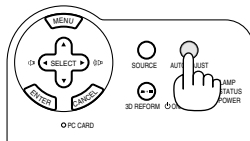
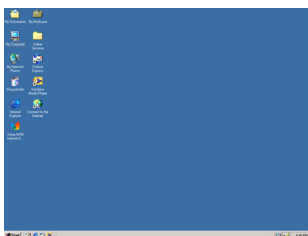

Press the Auto Adjust button to fine-tune the computer image or to remove any vertical banding that might appear and to reduce video noise, dot interference or cross talk (this is evident when part of your image appears to be shimmering). This function adjusts the clock frequencies that eliminate the horizontal banding in the image. This function also adjusts the clock phase to reduce video noise, dot interference or cross talk. (This is evident when part of your image appears to be shimmering.)

This adjustment may be necessary when you connect your computer for the first time.

NOTE:

- Some signals may not be displayed correctly or take time.
- The Auto Adjust function does not work for component and video signals.
- If the Auto Adjust operation cannot optimize the RGB signal, try to adjust Clock and Phase manually. See page 84.

6 Turning Up or Down Volume

Sound level from the speaker and the AUDIO OUT jack (Stereo mini) on the projector can be adjusted.

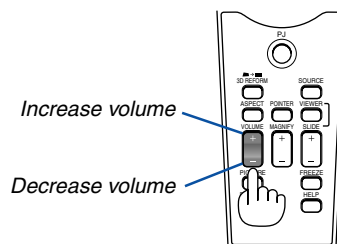

7 Turning off the Projector

To turn off the projector:

First, press the **POWER (ON/STAND BY)** button on the projector cabinet or the **POWER OFF** button on the remote control for a minimum of two seconds.

The power indicator will glow orange. After the projector turns off, the cooling fans keep operating for 10 seconds (Cooling-off time).

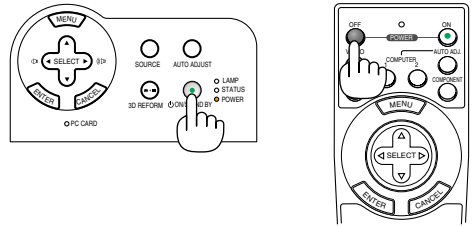

Secondly, turn off the Main Power switch. The power indicator will go out.

Finally unplug the power cable.

CAUTION

Do not unplug the power cable from the wall outlet or do not turn off the main power under any one of the following circumstances.

Doing so can cause damage to the projector:

- While the Hour Glass icon appears.
- While the cooling fans are running. (The cooling fans continue to work for 10 seconds after the projector is turned off).

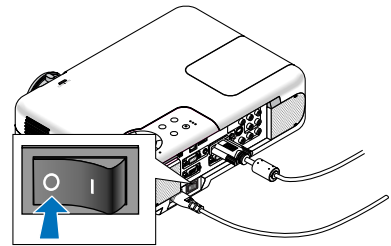

8 After Use

Preparation: Make sure that the projector is not turned on.

1. **Unplug the power cable.**
2. **Disconnect any other cables.**
3. **Retract adjustable tilt feet if extended.**
4. **Cover the lens with the lens cap.**
5. **Put the projector and its accessories in the supplied soft carrying case.**

4

Convenient Features

❶	Switching Operation Mode between Computer and Projector	40
❷	Turning Off the Image and Sound	40
❸	Freezing a Picture	40
❹	Using the Pointer	41
❺	Enlarging and Moving a Picture	41
❻	Getting the On-line Help	42
❼	Using a USB Mouse	42
❽	Using the Remote Mouse Function	43
❾	Correcting Horizontal and Vertical Keystone Distortion (Cornerstone)	44
❿	Making Freehand Drawings on a Projected Image (ChalkBoard)	47
⓫	Storing Images Displayed on the Projector on the PC card or USB Memory (Capture)	48
⓬	Preventing the Unauthorized Use of the Projector	49
⓭	Using a USB Memory Device or USB Memory Card Reader	54

1 Switching Operation Mode between Computer and Projector

The three shaded buttons shown on the drawing work as a computer mouse in the Computer mode. In the Computer mode the PJ button is not lit.

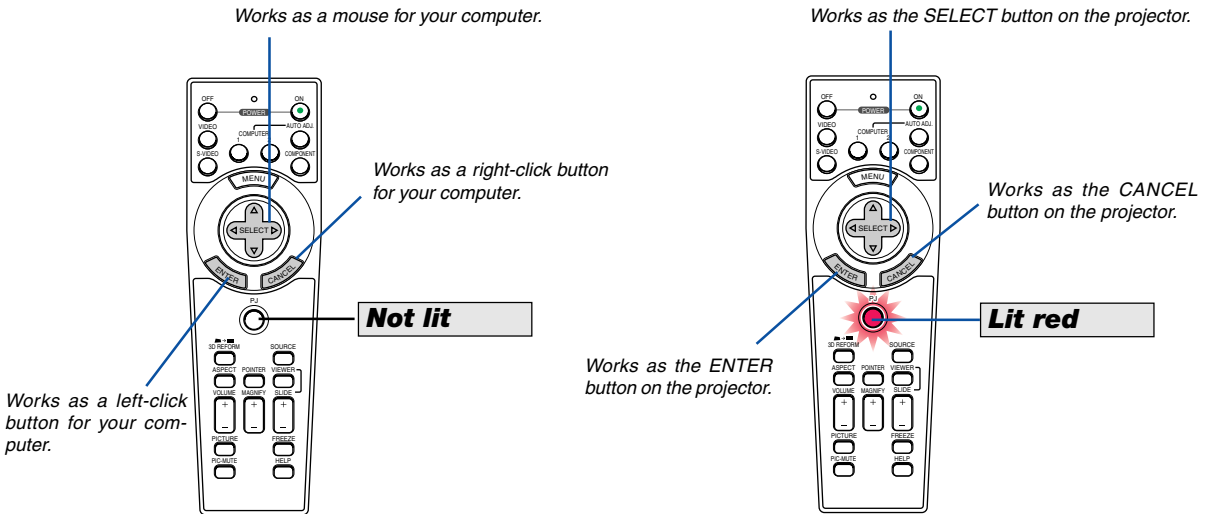

- When the MENU button is pressed, the PJ button lights red to indicate that you are in the Projector mode, which allows the projector menu operation using the three buttons.
- If no buttons are pressed within 60 seconds, the PJ button's light goes out to indicate that you are in the Computer mode. To enable the projector menu operation again, press the PJ button to light red.
- When the PJ button MENU is lit, if you want to use the mouse function immediately, press the PJ button to return to the Computer mode (not lit).

During Computer mode

In Computer mode, by pressing the ENTER button for 2 seconds or more then releasing, the drag mode is set and the drag operation can be performed simply by pressing the SELECT ▲▼◀▶ (mouse) button. To drop the item, press the ENTER (left click) button again or press the CANCEL (right click) button.

2 Turning Off the Image and Sound

Press the PIC-MUTE button to turn off the image and sound for a short period of time. Press again to restore the image and sound.

NOTE: When a picture is muted, the Eco mode will be automatically selected in "Lamp Mode."

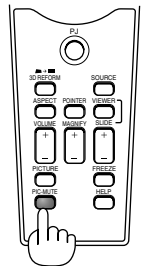

3 Freezing a Picture

Press the FREEZE button to freeze a picture. Press again to resume motion.

NOTE: Pressing the FREEZE button will display the Capture menu that allows you to capture a frozen image. See page 48 for more information.

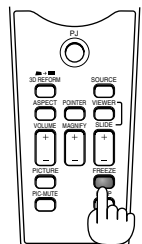

4 Using the Pointer

You can use one of nine pointers to draw your audience's attention to the portion of a projected image you want.

NOTE: You can select one pointer from the menu. See page 99.

Press the POINTER button to display the pointer.

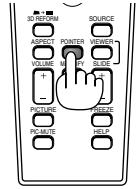
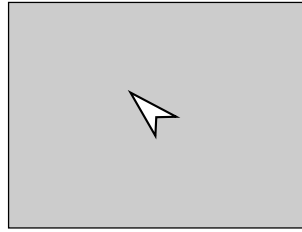

Press the Pointer button to display the pointer.

Use the SELECT button to move the pointer. Press the POINTER button again. The pointer will disappear.

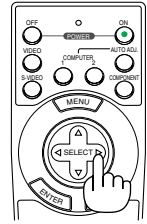
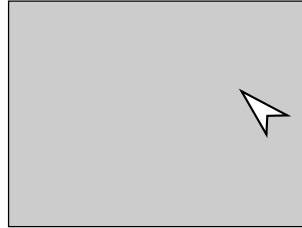

Use the Select button to move the pointer.

5 Enlarging and Moving a Picture

You can enlarge the area you want up to 400 percent.

To do so:

1. Press the POINTER button to display the pointer.

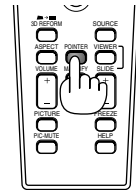
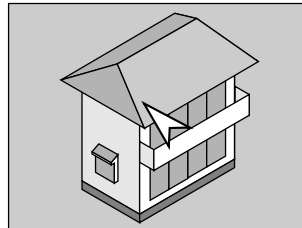

2. Move the pointer to the area you want to enlarge.

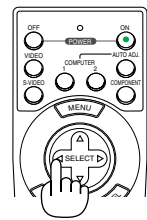
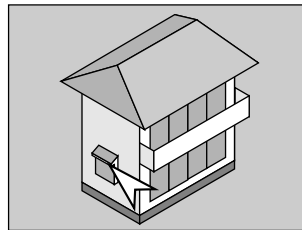

3. Enlarge the selected area.

When the MAGNIFY (+) button is pressed, the image is magnified and the magnify icon will be displayed. To magnify the selected area, use the SELECT ▲▼◀▶ button to move the magnify icon and press the MAGNIFY (+) button.

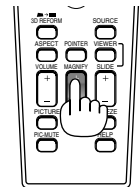
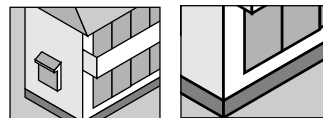

4. Return the image to the original size.

Press the MAGNIFY (-) button until the magnify icon changes to the pointer.

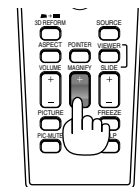
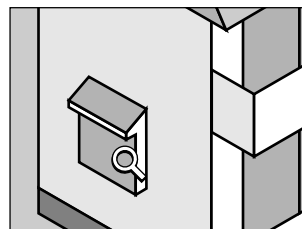

6 Getting the On-line Help

You get the contents about Help.

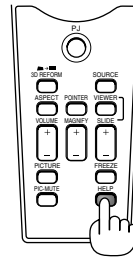

Display Help

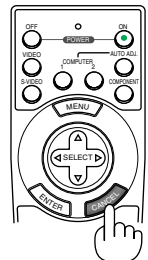

Exit Help

7 Using a USB Mouse

Using a USB mouse gives you a smooth operation. A commercially available USB mouse can be used.

NOTE: There may be some brands of a USB mouse that the projector does not support.

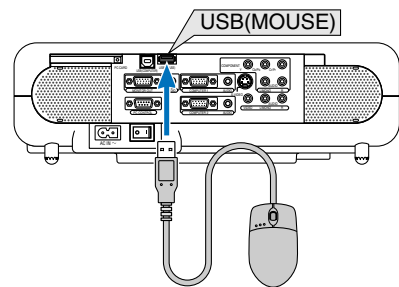

Operate the Menus using the USB mouse

Mouse Cursor

When connecting a USB mouse to the projector, you get a mouse cursor on the screen. Unless you use your USB mouse within 10 seconds, the mouse cursor disappears.

Menu Display

Clicking with the right mouse button displays the menu. To close the menu, click anywhere in the background.

Source List Display

Click with the left button anywhere on the screen except on the menu to display the Source list.

Adjusting and Setting Display

You can select a menu item and click with the left mouse button to make adjustments and settings.

Examples

Click (or press and hold) the left mouse button ◀ or ▶ to adjust the brightness. Or click and drag the left mouse button on the slide bar horizontally to adjust it.

To save the adjustments, click . The display is closed.

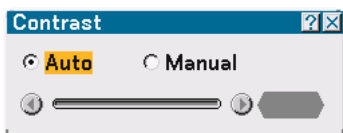

- Click with the left mouse button to display a description of the selected menu item.
- Click and drag the title bar with the left mouse button to move the adjustment or setting dialog box.
- Use the right mouse button (right-click) on the adjustment or setting dialog box to return to the previous screen with storing changes.

8 Using the Remote Mouse Function

The built-in remote mouse function enables you to operate your computer's mouse functions from the remote control (Computer mode).

It is very convenient for clicking through your computer-generated presentations. To return to the projector operation mode (Projector mode), press the PJ button (lit red).

Connecting to your computer for the remote mouse function

If you wish to use the remote mouse function, use the supplied USB cable to connect the USB port (COMPUTER) of the projector and the USB port (type A) of your computer.

NOTE: Depending on the type of connection or OS installed on your computer, you may have to restart your computer or change your computer settings.

When using the USB Port

The remote mouse function can only be used with a Windows 98, Windows Me, Windows XP, Windows 2000 or Mac OS operating system.

NOTE: Wait at least 5 seconds after disconnecting the USB cable before reconnecting it and vice versa. The computer may not identify the built-in mouse receiver if it is repeatedly connected and disconnected in rapid intervals.

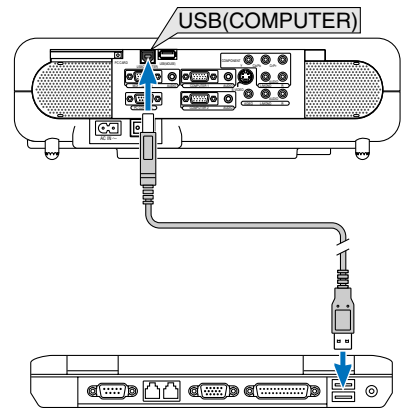

9 Correcting Horizontal and Vertical Keystone Distortion (Cornerstone)

Use the 3D Reform feature to correct keystone (trapezoidal) distortion to make the top or bottom and the left or right side of the screen longer or shorter so that the projected image is rectangular.

Cornerstone

1. Press and hold the 3D REFORM button for a minimum of 2 seconds to reset current adjustments.
Current adjustments for "Keystone" or "Cornerstone" will be cleared.
2. Project an image so that the screen is smaller than the area of the raster.
3. Pick up any one of the corners and align the corner of the screen with the one of the image.

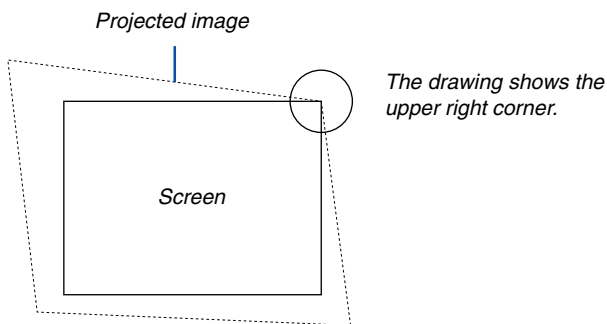

4. Press the 3D REFORM button on the remote control twice.
The Cornerstone adjustment screen is displayed.



5. Use the SELECT ▲▼◀▶ button to select one icon which points in the direction you wish to move the projected image frame.
6. Press the ENTER button.
7. Use the SELECT ▲▼◀▶ button to move the projected image frame as shown on the example.

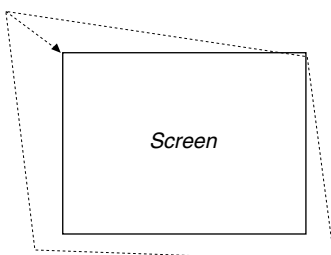

8. Press the ENTER button.

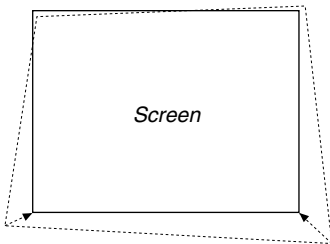

9. Use the SELECT ▲▼◀▶ button to select another icon which points in the direction.

On the Cornerstone adjustment screen, select "Exit" or press the CANCEL button on the remote control.

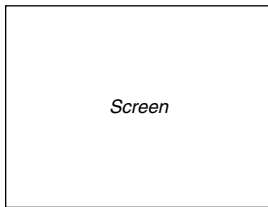

The confirmation screen is displayed.



10. Press the SELECT ◀ or ▶ button to highlight the [OK] and press the ENTER button.

This completes the keystone correction.

Selecting "Cancel" will return to the adjustment screen without saving changes (Step 3).

Selecting "Reset" will return to the factory default.

Selecting "Undo" will exit without saving changes.

NOTE: To return the 3D Reform correction setting values to the factory default, press and hold the 3D REFORM button for a minimum of 2 seconds.

NOTE: During 3D Reform adjustment, "Aspect Ratio" and "Screen" may not be available. Should this happen, first reset the 3D Reform data and then do each setting. Second repeat the 3D Reform adjustment. Changing Aspect Ratio and/or Screen setting can limit 3D Reform in its adjustable range.

The adjustable ranges for 3D Reform are as follows:

	Horizontal	Vertical
Cornerstone	Max. +/- 35° approx.	Max. + 56° approx.
Keystone	Max. +/- 27° approx.	- 30° approx.

* The following are conditions under which the maximum angle is achieved:

- Image (100") is projected in Wide (Zoom lever)
- Resolution is XGA
Higher resolution than XGA narrows the adjustable range.
- Menu items should be set as follows:
Aspect Ratio 4:3
Screen Type 4:3
- Horizontal and Vertical are adjusted separately.
A combination of both adjustments narrows the adjustable range.
- When "4:3 Fill" is selected in Aspect Ratio, "Cornerstone" and "Horizontal Keystone" are not available.

NOTE:

- If the Cornerstone screen is unavailable (grayed), press and hold the 3D REFORM button for a minimum of 2 seconds to reset the current correction data. The Cornerstone function becomes available.
- Turning on the projector will reset the previous correction setting values if the projection angle is changed from the last use. If the projection angle is the same as in the last use, the previous correction setting values are retained in the memory. To use the previous correction setting values after changing projection angle, select "Manual" in "Keystone" from the menu. See page 87.

NOTE: The 3D Reform feature can cause an image to be slightly blurred because the correction is made electronically.



10 Making Freehand Drawings on a Projected Image (ChalkBoard)

The ChalkBoard feature allows you to write and draw messages on a projected image.

NOTE: The ChalkBoard feature is available only when a USB three-button mouse is used.

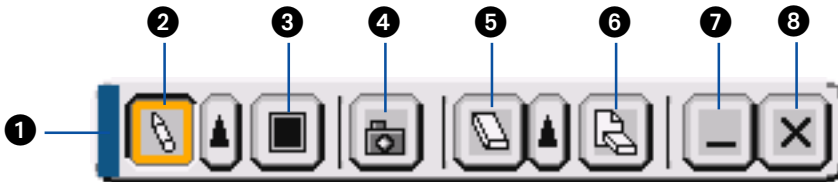
To display or hide the ChalkBoard tool bar, click the middle button on your mouse. The tool bar contains the following icons.



- 1 Drag Drags to move the tool bar.
- 2 Pen Left-click and drag to draw. Left-click  or right-click the pen icon to display the pen palette containing four lines of different thickness from which you can select a line you prefer by left-clicking.
- 3 Color Selects a color. Left-click to display the color palette from which you can select a color you prefer by left-clicking.
- 4 Capture Left-click to capture a drawing on the ChalkBoard screen and save it to your PC-card inserted into the PC card slot of the projector.
- 5 Eraser Left-click and drag to erase part of a drawing. Left-click  or right-click the eraser icon to display the eraser palette containing four eraser of different thickness from which you can select an eraser you prefer by left-clicking.
- 6 Clear Left-click to clear the drawing completely from the ChalkBoard screen.
- 7 Hide Hides the tool bar by left-clicking. Right-clicking anywhere on the screen displays the ChalkBoard tool bar again.
- 8 Exit Clears the complete drawing and exits the ChalkBoard.

NOTE:

- The menu is not available while you display the ChalkBoard screen.
 - Selecting another source or switching slides in the Viewer clears a drawing completely.
-

⑪ Storing Images Displayed on the Projector on the PC card or USB memory (Capture)

The Capture features allows you to capture an image from a source that is currently being displayed. The image is saved as JPEG in the PC card or USB memory.

NOTE:

- Unless a PC card or USB memory is inserted into the PC Card slot or USB (MOUSE) port of the projector, the Capture feature is not available.
- The "Card Error" display means that the free space of the PC card or USB memory is insufficient for saving images. Make more space available on the card by erasing unwanted images with your PC. The number of images that can be captured depends on the size of the PC card.
- Be sure not to turn off the power or remove the PC card or USB memory while capturing an image. Doing so could cause a loss of the data in the PC card or USB memory or damage to the card itself.

Preparations:

Insert the PC card into the PC card slot or USB (MOUSE) port of the projector.

Insert the PC card so that the end with the insertion direction arrow on the top goes in first.

* Press the eject button to eject the card.

- 1. Project the image you wish to store on the projector.**
- 2. Press the FREEZE button on the remote control.**
- 3. Press the MENU button to display the Capture menu.**

Capture Captures an image and save it as a JPEG file in a PC card or USB memory.

Drive Select the PC Card or USB memory. You can capture an image and save it to your PC card or USB memory.

Exit Exits the Capture function. Another option to exit the Capture function is to press MENU or CANCEL button on the remote control or projector cabinet.

NOTE:

Captured images with higher resolution than the projector's native resolution cannot be displayed correctly.

- *File size of the captured image varies depending on the resolution of an input signal.*
- *An hourglass indicating that an image is being captured appears on the projector's display. Do not eject the PC card or turn off the projector's power while this icon is displayed. Doing so will damage the PC card data. If the PC card data is damaged, use a computer to repair the data.*

12 Preventing the Unauthorized Use of the Projector

Assigning a keyword prevents the projector from being used by unauthorized individuals.

Assigning a Keyword for the first time

1. Press the **MENU** button.

The menu will be displayed.

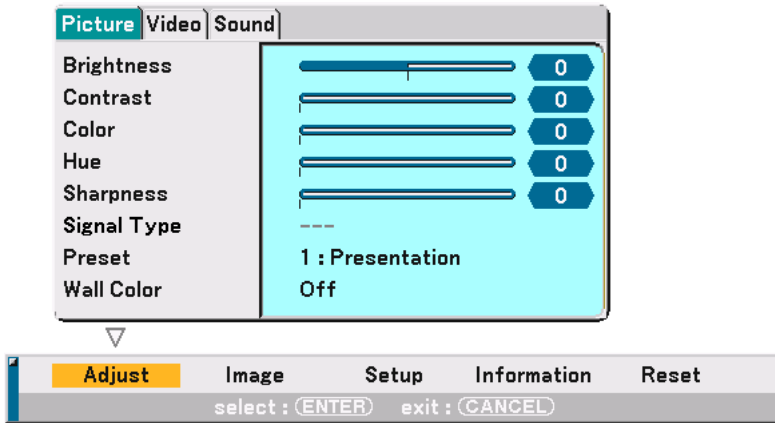

2. Press the **SELECT** ► button twice to highlight the **Setup** submenu and press the **ENTER** button.

The page tab "1" will be highlighted.

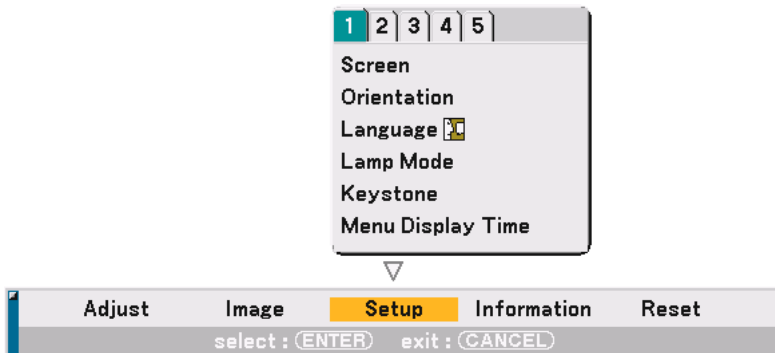

3. Press the **SELECT** ► button once to highlight the page tab "2".

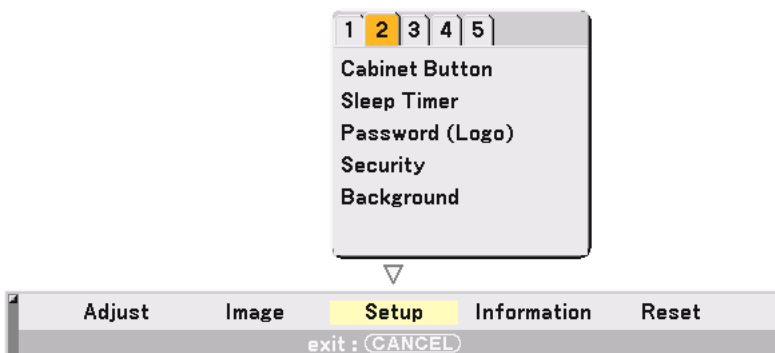

4. Press the **SELECT ▼** button four times to highlight “Security”.

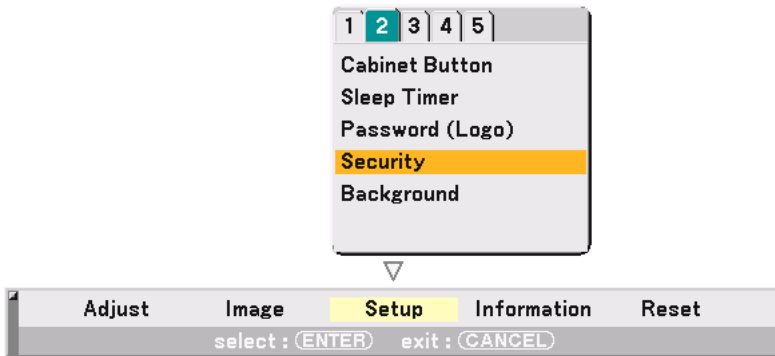

5. Press the **ENTER** button to display the Security screen.

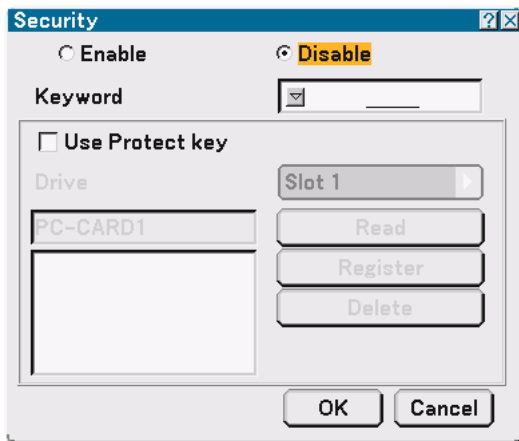

6. Press the **ENTER ▼** button once to highlight the Keyword entry box and press the **ENTER** button. The Software keyboard will be displayed.

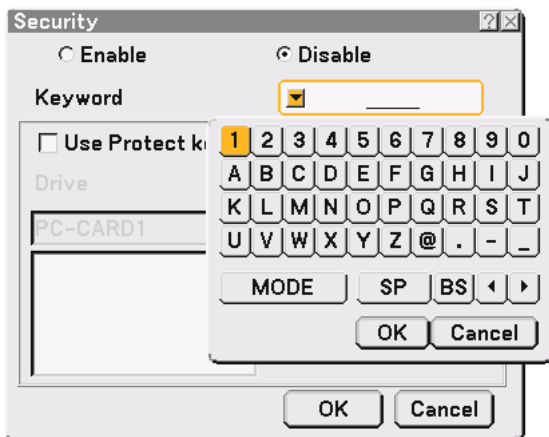

7. Enter an alphanumeric keyword using the Software keyboard

For example, to enter “1234”, follow the steps 7-1 to 7-4 below.

NOTE:

- Please make a note of your keyword.
- Do not use spaces (SP) in your keyword.

7-1. Highlight the number “1” and press the ENTER button.

The number “1” will be displayed in the Keyword entry box.

7-2. Press the SELECT ► button once to highlight “2” and press the ENTER button.

The number “12” will be displayed in the Keyword entry box.

7-3. For “3” and “4”, use the same procedure as step 7-2.

The number “1234” will be displayed in the Keyword entry box.

7-4. Press the SELECT ▼ button to highlight “OK” and press the ENTER button.

The Software keyboard will disappear.

8. Press the SELECT ▲ button once to highlight “Disable” and press the SELECT ◀ button to highlight “Enable”.

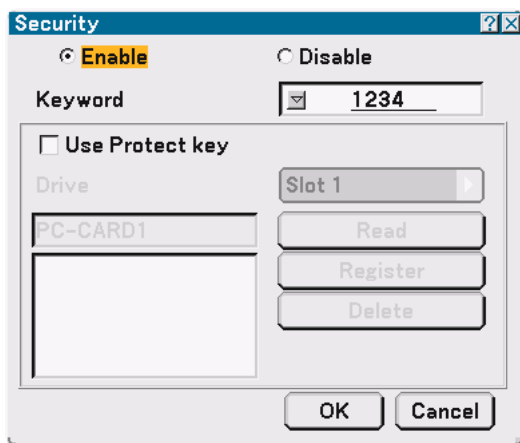

9. Press the SELECT ▼ button to highlight “OK” and press the ENTER button.

The confirmation screen will be displayed.



10. Press the ENTER button.

The Security Function is now enabled.

NOTE: A PC card can be used as a protect key. You can skip the keyword entry by inserting a registered PC card when turning on the projector. See page 91.

Checking If Security is enabled

Turn off the projector and turn it back on to check if the Security function is enabled.

1. Press and hold the POWER (ON/STANDBY) button for a minimum of two seconds.

The lamp lights off and the POWER indicator flashes orange. Please wait until the POWER indicator changes from flashing to steady light.

2. When the POWER indicator lights steady orange, push the Main POWER switch to the off position (O).

The projector will turn off.

3. Push the Main POWER switch to the on position (I).

The POWER indicator lights orange. The projector is in standby condition.

4. Press and hold the POWER (ON/STANDBY) button for a minimum of two seconds.

The projector will turn on. The "Projector is locked! Enter your keyword." message will be displayed at the bottom of the screen.

5. Press the MENU button.

The on-screen menu will be displayed.

6. Press the SELECT ► button to highlight "Setup" and press the ENTER button.

The page tab "1" will be highlighted.

7. Press the SELECT ► button once to highlight the page tab "2".

8. Press the SELECT ▼ button four times to highlight "Security" and press the ENTER button.

The Keyword entry screen will be displayed

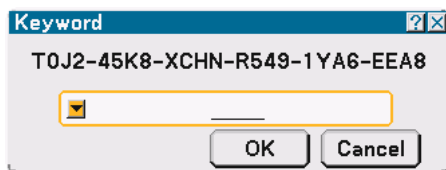

9. Press the ENTER button.

The Software keyboard will be displayed.

10. Use the same procedures as steps 1 to 7 described in the "Assigning a Keyword for the first time" section to enter "1234".

Each time one number is entered, an "" (asterisk) will appear. Keyword appears as asterisks so the real keyword is hidden.*

11. After entering your keyword, highlight "OK" and press the ENTER button.

The Software keyboard will disappear. This will allow you to operate the projector.

Disabling the Security

1. Press the MENU button.

The on-screen menu will be displayed.

2. Press the SELECT ► button to highlight “Setup” and press the ENTER button.

The page tab “1” will be highlighted.

3. Press the SELECT ► button once to highlight the page tab “2”.

4. Press the SELECT ▼ button four times to highlight “Security” and press the ENTER button.

The Keyword entry screen will be displayed

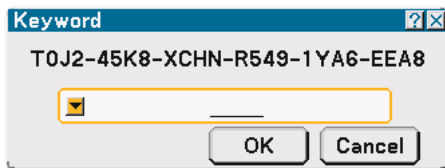

5. Press the ENTER button.

The Software keyboard will be displayed.

6. Use the same procedures as steps 1 to 7 described in the “Assigning a Keyword for the first time” section to enter “1234”.

Each time one number is entered, an “*” (asterisk) will appear. Keyword appears as asterisks so the real keyword is hidden.

7. After entering your keyword, highlight “OK” and press the ENTER button.

The Software keyboard will disappear. The Security screen will be displayed.

8. Highlight “Enable” and press the SELECT ► button to highlight “Disable”.

9. Press the SELECT ▼ button to highlight “OK” and press the ENTER button.

The Security Function is now disabled.

NOTE: To enable the Security again, enter your keyword again. Make sure that your keyword is correct.

13 Using a USB Memory Device or USB Memory Card Reader

The projector is compatible with either a USB memory device or USB memory card reader which supports the viewer and security features.

- To use a USB memory device or USB memory card reader, connect the device to the USB (MOUSE) port (type A).
- Select one of the drive icons for your USB memory in a pane on the left side of the Viewer window.
- To use a USB memory device as a Protect key for Security function, select one from the Drive icons in the Security setting screen. See page 91.

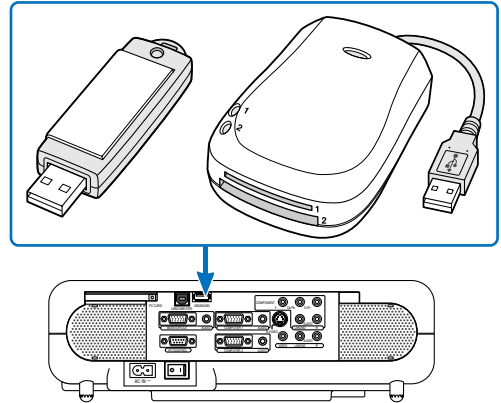

NOTE:

- Some USB memory devices (brands) or USB memory card readers may not work.
- You cannot use a USB memory device and a USB memory card reader when connecting a USB mouse to the projector.
- Do not do the following while the USB memory device or USB memory card reader's access indicator is lit or flashing (while data is being accessed.) Doing so can damage your USB memory device or USB memory card in the reader. Back up your data in case it will need to be restored.
 - * Pulling out the USB memory device or USB memory card reader from the USB port of the projector.
 - * Pulling out the memory card from the USB memory card reader
 - * Turning off the main power switch or unplugging the power cable.
- The drive for "USB 1-4" is displayed only when the USB memory device or USB memory card reader is connected to the projector. The drive for "USB 1-4" may be displayed differently from the one in the USB memory card reader.
- Some USB memory devices (brands) or USB memory cards cannot be used as Protect key for the projector's Security function.

5

Using the Viewer

.....

❶ Making the Most out of the Viewer Function	56
❷ Operating the Viewer Function from the Projector	58
❸ Changing Background Logo	64

① Making the Most out of the Viewer Function

Features

You can view presentation data, capture and play images on the projector. A PC card is used to view presentation data prepared on the computer and to capture and play images projected with the projector.

The Viewer feature allows you to view slides stored on a PC memory card (referred to as PC card in this manual) or USB memory on the projector. Even if no computer is available, presentations can be conducted simply with the projector. This feature is convenient for holding presentations at meetings and in offices, as well as for playing images taken on digital cameras.

NOTE:

- *To use the Viewer, first you need to create presentation materials on your PC (JPEG, BMP, Index* files). For creating presentation materials using the Dynamic Image Utility 2.0.*
 - * *“Index” file is a file created using the Dynamic Image Utility 2.0 contained on the supplied NEC Projector User Supportware CD-ROM.*
 - See “Using Dynamic Image Utility 2.0 on the supplied CD-ROM” for installing the Dynamic Image Utility 2.0 on your computer.*
-

Easy to use

- Presentations can be started immediately simply by inserting a PC card or USB memory (not supplied)
- Easy slide switching
- Remote control operation
- Jumping to a list of slides or any specific slide

High quality images

- High resolution up to 1024 x 768 dots
- 24-bit full color playback
- Viewing of digital camera images

Simple utility software (for computer)

- Dynamic Image Utility 2.0 operable on Windows 98/Me/XP/2000
- Slides can be created by capturing the currently displayed image
- Control screen for displaying lists of slides and editing
- * Microsoft, Windows and PowerPoint are registered trademarks of Microsoft Corporation.

Inserting and Removing a PC Card

NOTE:

- Do not try to force the PC card into the slot.
- A dummy card is inserted into the PC CARD slot at the time of shipment. First remove the dummy card before use.

Inserting the PC Card

- Hold the PC card horizontally and insert it slowly into the PC card slot with its top facing up.

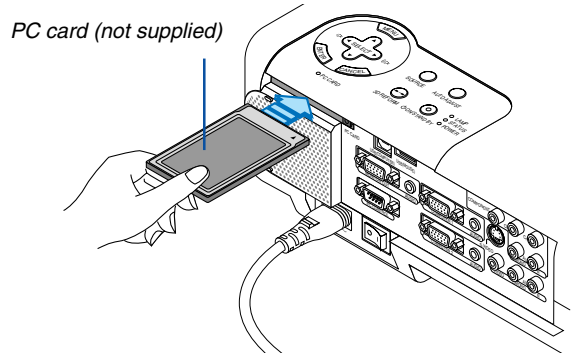

Removing the PC Card

NOTE: Do not eject the PC card while its data is being accessed.

Press the eject button twice. The PC card pops out a little. Grasp the edges of the PC card and pull it out.

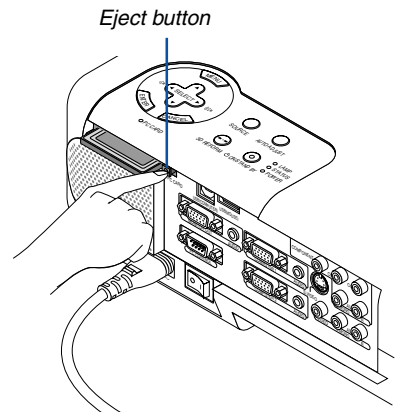

Direction for Inserting the PC Card

The PC card has a top and bottom and must be inserted into the PC card slot in a specific direction. It cannot be inserted backwards or upside-down. Attempting to force it into the slot in the wrong direction may break the internal pin and damage the card slot. Refer to the PC card's operating instructions for the proper direction of insertion.

PC Card Type

The PC Card slot accepts PCMCIA Type II only.

② Operating the Viewer Function from the Projector (playback)

This section describes the operation for showing slides created using the Viewer function with the projector. It is also possible to make slides directly from the images projected with the projector.

Projecting slides (Viewer)

Preparation: Use the Capture feature to store JPEG or BMP files in a PC card or USB memory inserted into the projector's slot. Or store JPEG or BMP files in a PC card or USB memory inserted into your PC.

1. **Insert a PC card into the PC card slot of the projector.**
2. **Press the VIEWER button on the remote control or select the "Viewer" from the source list.**
An image stored in the PC card will be displayed.
3. **Press the MENU button to display the Viewer menu.**

The Viewer menu will appear when you press the MENU button on the remote control or the projector cabinet.



The Viewer menu includes the following commands:

- Play Plays back automatically or manually depending on the setting in Option. This allows you to move on to the next slide when "Manual Play" is selected in the "Play Mode".
- Stop This allows you to stop Auto Play while you are playing back and to resume playing from the selected slide or folder when "Auto Play" is selected in the "Play Mode".
- Thumbnails Displays a list of thumbnails of JPEG or BMP files stored in the PC card inserted into the projector.
- Delete Deletes a captured slide(s) or all the captured slides in the Capture - specific folder.
- Logo Replace the default background logo with another logo in JPEG or BMP format.
- Option Displays the Viewer setting options.
- Source Select Displays the Source list.

4. **Select "Play" and then press the ENTER button to display the first slide or to start playing slides automatically.**

Viewer Window Elements

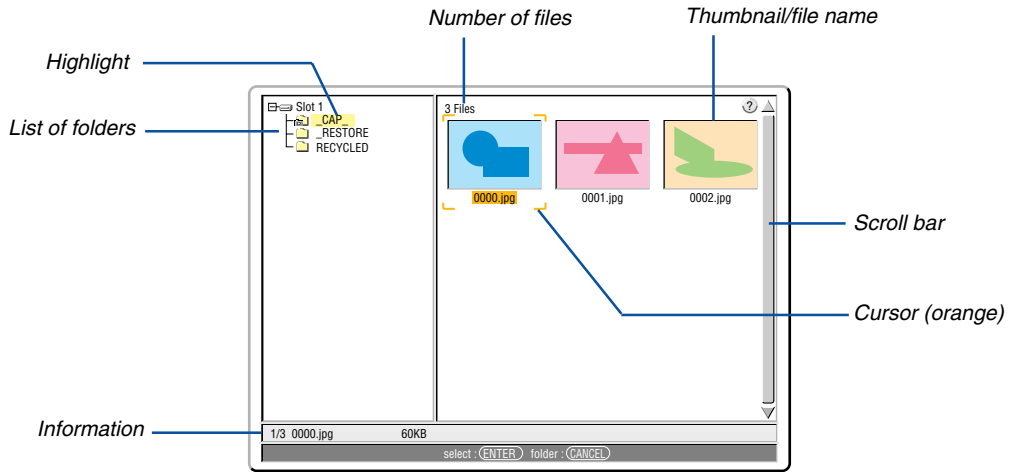

- Highlight Indicates the selected folder or drive.
- List of folders Indicates folders contained on a PC card or USB memory.
- Information Indicates information of the selected file or folder
 - Folder: folder name, creation date, creation time
 - File: slide number/number of displayable slides in a folder, file name, creation date, creation time, file size
- Number of files Indicates number of displayable slides in the selected folder. The maximum number of images recognized as slides within one directory is 128.
- Thumbnail/file name Indicates thumbnails and names contained in a folder.
- Cursor Indicates the selected slide.
- Scroll bar Uses to view folders or files not visible in the window.

Setting Option for Viewer

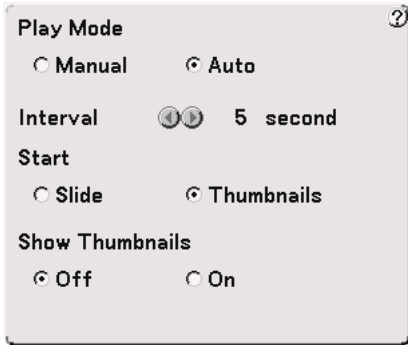

Play Mode:

- Manual Views a slide manually when the Viewer source is selected.
- Auto Plays back slides automatically when the Viewer source is selected.

Interval:

Specifies interval time between 5 and 300 seconds.

Start:

Specifies start screen when the Viewer source is selected.

Show Thumbnails:

Selecting the Viewer source will display a list of thumbnails of JPEG or BMP files stored in the PC card or USB memory when "On" is selected.

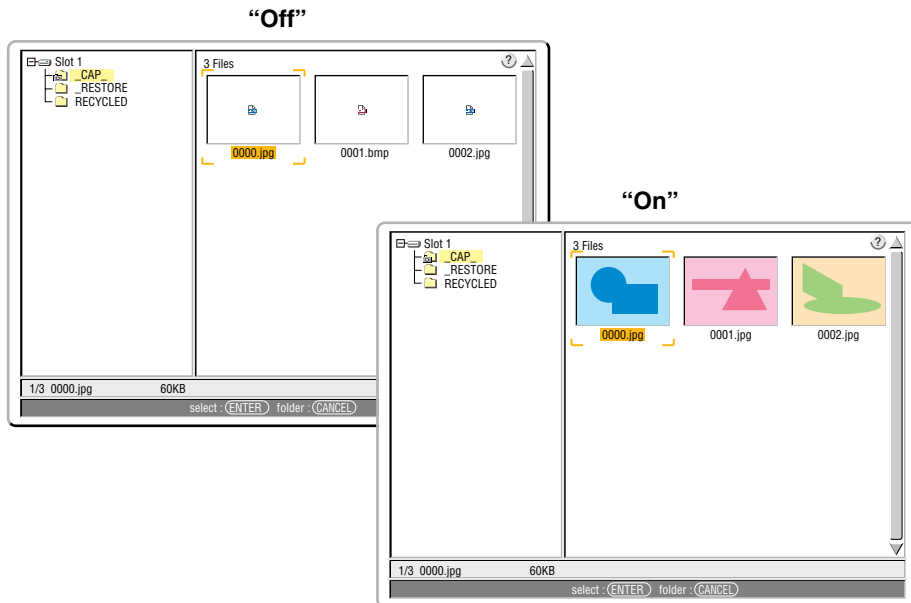

NOTE: If no memory card is inserted in the PC CARD slot, there is no signal, and a black, blue or logo background is displayed, depending on the setting. Playback is stopped when ◀▶ button on the cabinet or remote control is pressed in Auto Play mode.

Switching to Slides Directly from Other Input Modes

With this function it is possible to switch directly to a slide when the picture of a VCR or computer is being projected. Example: When conducting presentations using a combination of slides and moving pictures from a VCR, etc., it is possible to switch from a Viewer slide to the video picture then back to the Viewer slide simply by using the Viewer button.

NOTE: Even if you switch the current Viewer source to another source, the current slide is retained. When you return back to the Viewer, you will get the slide that has been retained.

Viewing Digital Images

Digital images can be played with the Viewer if the following conditions are met:

- If the image can be stored on an MS-DOS format PC card.
- If the image can be stored in a format supported by the Viewer. With the Viewer, images on the card are searched for in directories and images in JPEG or BMP format are recognized as slides. Searchable directories are directories within two steps from the root directory, and searchable images are images within the first 12 files in the directory. Only file and slide switching are possible.

NOTE: The maximum number of images recognized as slides within one directory is 128.

Deleting Captured Images

Using the Delete command on the Viewer menu allows you to delete captured images.

To delete captured images:

Preparation: Make sure that the PC card is inserted into the PC card slot of the projector.

1. Press the **VIEWER** button on the remote control to display an image.
2. Press the **MENU** button to display the Viewer menu.

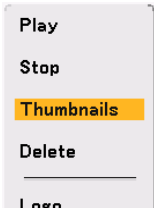

3. Use the **▼** button to select “**Thumbnails**” and then press the **ENTER** button. The Thumbnail screen will be displayed.

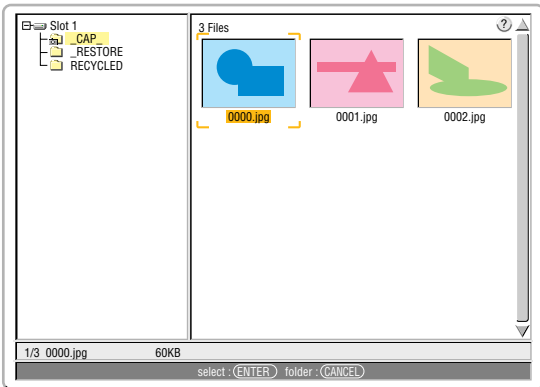

*NOTE: To change highlight from the Thumbnails screen (pane on the right) to a directory tree (pane on the left) , press the **CANCEL** button. To return highlight to the Thumbnails screen, press the **ENTER** button.*

4. Use the **▲▼◀▶** buttons to select an image you wish to delete.
5. Press the **MENU** button to display the Viewer menu.
6. Use the **▼** button to select “**Delete**” and then press the **ENTER** button.

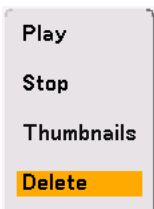

A confirmation message will be displayed.

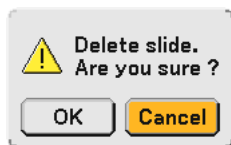

7. Use the **◀** button to select “**OK**” and then press the **ENTER** button.

This completes deleting.

To delete all the captured images:

1. Repeat steps 1 to 3 in the above described procedure.
2. Press the CANCEL button to select the “__CAP__” folder in the directory (pane on the left).

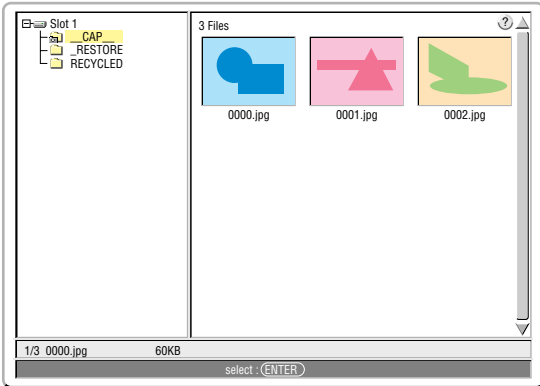

3. Press the MENU button to display the Viewer menu.

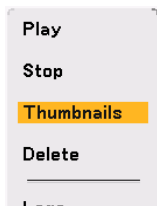

4. Use the ▼ button to select “Delete” and then press the ENTER button.

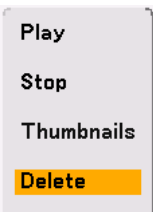

A confirmation message will be displayed.

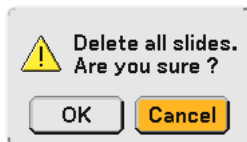

5. Use the ◀ button to select “OK” and then press the ENTER button.

This completes deleting.

NOTE: The vacant “__CAP__” folder stays even after you delete all the captured images.

③ Changing Background Logo

You can change the default background logo using the Viewer feature.

NOTE: File size must be 256KB or less. Other file formats than JPEG and BMP are not available.

Preparation:

Use the Capture feature to store JPEG or BMP files in a PC card inserted into the projector's slot. Or store JPEG or BMP files in a PC card inserted into your PC's slot and insert the PC card into the projector's slot.

1. Press the **VIEWER** button on the remote control to display an image.
2. Press the **MENU** button to display the Viewer menu.

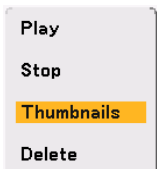

3. Use the **▼** button to select "Thumbnails" and then press the **ENTER** button.
The Thumbnail screen will be displayed.

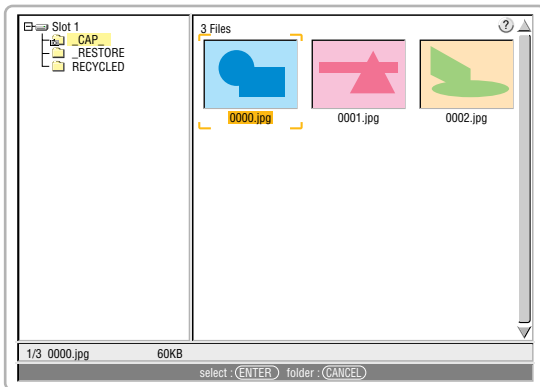

*NOTE: To change highlight from the Thumbnails screen (right window) to a directory tree (left window), press the **CANCEL** button. To return highlight to the Thumbnails screen, press the **ENTER** button.*

4. Use **▲▼◀▶** button to select a JPEG or BMP file (slide) for your background logo.
5. Press the **MENU** button to display the Viewer menu.
6. Use the **▼** button to select "Logo" and then press the **ENTER** button.
A confirmation dialog box will be displayed.



7. Use the **◀** button to select "OK" and press the **ENTER** button. This completes changing a logo for the background.

* Once you have changed the background from the NEC logo to another, you cannot return the logo to background even by using "Reset".

6

Using Dynamic Image Utility 2.0 on the supplied CD-ROM

(English version only)

.....

❶	End User License Agreement.....	66
❷	Introduction.....	67
❸	Operating Environment.....	68
❹	Equipment Connections and Settings.....	69
❺	Software Installation.....	69
❻	Starting/Exiting the Software.....	70
❼	Troubleshooting.....	72

Be sure to read this before installing and using the accompanying software.

① END USER LICENSE AGREEMENT

PLEASE READ THIS SOFTWARE LICENSE AGREEMENT ("LICENSE") CAREFULLY BEFORE INSTALLING THE SOFTWARE. IT PROVIDES THE TERMS OF THIS LICENSE.

WHILE INSTALLING THE SOFTWARE, THIS SOFTWARE LICENSE AGREEMENT WILL BE DISPLAYED. BY CLICKING ON THE "Yes" BUTTON, YOU ARE CONSENTING TO BE BOUND BY THIS AGREEMENT. FOLLOW THE DIRECTIONS ON THE SCREEN AND COMPLETE THE INSTALLATION PROCESS.

IF YOU DO NOT AGREE TO ALL OF THE TERMS OF THIS AGREEMENT, CLICK THE "No" BUTTON. THE INSTALLATION PROCESS WILL NOT CONTINUE.

Viewtechnology, Ltd. ("NECVT") grants you ("User") a license to use the PROJECTOR USER SUPPORTWARE ("Software") provided with this End User License Agreement ("EULA"). User assumes responsibility for the selection, adoption use and the result of use of the Software to achieve its intended result.

1. Term

- 1) *EULA will become effective upon User's agreement to the terms of EULA and shall remain in force until User terminates it by returning or destroying the Software and its related documents.*
- 2) *Notwithstanding the foregoing NECVT may terminate EULA at any time upon User failing to abide by any terms of EULA. Upon the termination of the EULA by NECVT, the license granted to User shall be terminated automatically. User agrees to destroy the Software together with all copies of it upon such termination.*

2. License

User use the Software on personal computers only for operating NECVT's projector supplied with the Software or other projector to be specified by NECVT ("Projector")

3. Replication, modification and merger of the Software

- 1) *User may make copies of the Software and related documentation to the extent necessary for using the Projector. User agrees to reproduce the NECVT's copyright notice and other notice on any such copies.*
- 2) *User may not use, copy, modify, or otherwise dispose of the Software, except as expressly permitted in EULA.*
- 3) *No provision in EULA shall be construed to assign and/or transfer any intellectual property right in the Software to User.*

4. Transfer of the Software

- 1) *User may transfer the Software to any third party, provided always that:*
 - a) *User must transfer, with the Software, to such third party EULA and all the related documentation with all copies thereof, and must not retain any copy thereof.*
 - b) *Such third party has agreed to the terms and conditions of EULA.*
- 2) *Except as otherwise expressly permitted above, User may not sublicense, assign, transfer or otherwise dispose of the license for the Software.*

5. Reverse Engineering

User may not reverse engineer, decompile, and/or disassemble the Software, except and only to the extent that such activity is expressly permitted by applicable law notwithstanding this limitation.

6. Limitations of Warranty

- 1) *Except as expressly specified herein, the Software is provided "as is" without warranty of any kind, including but not limited to implied warranties for fitness for a particular purpose, merchantability, title and non-infringement of any third party rights.*
- 2) *If User finds a material defect, which effects to the proper operation of the Software, in the media of the Software, NECVT will replace such defective media at no charge, if such media is returned to distributor from which such User purchased it within 1 month from such purchase and if NECVT determines that such defect is due to NECVT.*

6. Using Dynamic Image Utility 2.0 on the supplied CD-ROM

7. Limitations of Liability

In no event shall NECVT be responsible for any indirect, consequential or special damages or lost profits even if NECVT has been advised of the possibility of such damages, and/or for any claim for compensation or damage by any third party to User.

8. Others

- 1) *The validity, interpretation, construction and performance of EULA shall be governed by the laws of Japan.*
- 2) *User shall not export the Software to any country to which such export would be prohibited by any applicable laws.*

2 Introduction

Thank you for your purchase of the 8768 portable projector (hereafter referred to as "unit" or "projector"). This projector is connected to a personal computer or other equipment and clearly projects text or graphics to a screen.

This projector is supplied with convenient software that allows presentations to be made more simply and effectively. This guide gives an overview and describes the use of the accompanying software (contained in the CD-ROM that is supplied with this projector). Look over this guide in conjunction with the Help functions of the software programs.

Contents of the Supplied CD-ROM

The supplied CD-ROM contains the following software programs:

- *Dynamic Image Utility 2.0*
- *Viewer PPT Converter 2.0*
- *Image Express Utility 1.0 (not available on this model)*

Please see the Help functions of the software programs for information about their functions and operation.

What Can Be Accomplished with the Supplied Software

Dynamic Image Utility 2.0

- *Converts PowerPoint files, JPEG images, and other files and creates slides that can be displayed with the viewer function of the projector.*
- *Captures portions of the image from the screens of word processors, spreadsheets, browsers, and other programs for use in presentations.*
- *By saving the created slides on a flash memory card (*) and inserting the card into the PC Card slot of the projector, the slides can be projected to the screen without connecting a personal computer.*
 - * *Please purchase a commercially available PCMCIA Type 2 (ATA specification) flash memory card.*
- *The connection of personal computers and projectors by means of connection with serial cable (*) allows the following uses.*
 - * *A network connection is not available on this model.*
 - (1) *Images and slides can be sent from the personal computer to the projector and then projected to the screen. When using Microsoft PowerPoint 2000/2002, slides can be sent synchronized with the slide show page feed.*
 - (2) *A personal computer can be used to switch the projector power on/off, control the adjustment of image quality and other settings, and to display the remaining lamp life.*

Viewer PPT Converter 2.0

- *Converts files created with Microsoft PowerPoint 95/97/2000/2002 to an independent index format with a simple operation to enable direct playback with the viewer function of the projector.*
- *When using Microsoft PowerPoint 2000/2002, Viewer PPT Converter 2.0 can be started from PowerPoint (by means of add-in registration to PowerPoint).*

6. Using Dynamic Image Utility 2.0 on the supplied CD-ROM

Image Express Utility 1.0 (not available on this model)

- Using a network environment, this program enables the screen image displayed by the personal computer to be sent to the projector and then projected to a screen.
- Two methods are available for sending the screen image to the projector. "Continuous Transmit" automatically sends the screen image of the personal computer at a fixed interval. "Single Frame Transmit" sends the screen image by clicking the screen button (or pressing a key).

Information about Upgrading this Software

Please see the service page for NEC projectors (<http://www.nec-pj.com/>) for information about software upgrades of NEC Projector User Supportware (i.e., Dynamic Image Utility and Viewer PPT Converter).

3 Operating Environment

Supported Equipment	IBM PC/AT compatible computers <ul style="list-style-type: none">• CD-ROM drive a requirement (at time of installation)
CPU	Pentium MMX processor or higher a requirement Pentium III 800 MHz or higher recommended
Memory	For Windows XP <ul style="list-style-type: none">• 128 MB or more a requirement• 192 MB or more recommended For other operating systems <ul style="list-style-type: none">• 64 MB or more a requirement• 128 MB or more recommended * More memory may be necessary when other applications are run at the same time.
Supported OS	Windows 98 Windows 98 Second Edition Windows Me Windows 2000 Professional Windows XP Home Edition Windows XP Professional/Windows XP Tablet PC Edition * Microsoft Internet Explorer 5.01 or higher is required for the aforementioned environments. * Does not support Windows power-saving function.
Resolution	1024 dots x 768 lines recommended
Screen Colors	High Color (15 bit, 16 bit) True Color (24 bit, 32 bit)

4 Equipment Connections and Settings

When Making Connections with Serial Cable

What Can Be Accomplished

- Using Dynamic Image Utility 2.0, a picture or slide can be sent to the projector and then projected to a screen.
- Using the projector control function of Dynamic Image Utility 2.0 allows operations to be performed from the personal computer which include switching the projector power on/off, signal selection, and adjustment of the picture quality.

[For Connections with Serial Cable]

Equipment to Be Prepared

- Projector (This unit)
- Personal computer
- Serial cable not included with the projector (Optional CA03D is available)

Connection at the Projector Side

Plug the serial cable into the PC CONTROL connector. ("Terminal Panel Features" and "PC Control Connector" on pages 16 and 119)

Connection at the Personal Computer Side

Plug the serial cable into the (RS-232C) serial connector.

5 Software Installation

NOTE

- *Windows 98 operations will be described in examples given here.*
 - *When using Windows 2000, please perform software installation/uninstalling with "Administrators" authority. When using Windows XP, perform with "Computer Administrator" authority.*
-

Dynamic Image Utility 2.0 Installation

Dynamic Image Utility 2.0 and Viewer PPT Converter 2.0 will all be installed together. The various programs cannot be installed individually.

Preparation:

Start Windows.

If Windows has already been started, please exit all running application software. The installation may not be completed properly unless all software has been exited.

1. Place the supplied CD-ROM in the CD-ROM drive.
The "Startup" screen will appear.

Reference

Should the "Startup" screen not appear...

- 1) Click [Start].
- 2) Click [Run (R)]. The [Run] screen will appear.
- 3) Enter the CD-ROM drive name (e.g., "Q: \") and then "SETUPEXE" to [Open (O)].
- 4) Click [OK]. The "Startup" screen will appear.

6. Using Dynamic Image Utility 2.0 on the supplied CD-ROM

2. Click "Please read this first" and read the Readme about Dynamic Image Utility 2.0.
3. Click "Installing the Dynamic Image Utility 2.0".
The "Welcome" screen will appear.
4. Click [Next >] at the "Welcome" screen.
The "End User License Agreement" screen will appear.
Please carefully read the contents of the "End User License Agreement".
5. If you agree, click [Yes].
If you do not agree, please click [No] and exit the installer.
6. Now, follow the operations described in the screen messages.
To cancel the installation of the supplied software part way through the installation, click [Cancel] and follow the instructions of the dialog box.
Please remove the CD-ROM from the CD-ROM drive when the installation is completed.

Uninstalling

Dynamic Image Utility 2.0 and Viewer PPT Converter 2.0 will all be uninstalled together. The various programs cannot be uninstalled individually.

1. Click [Start].
2. Click [Settings] → [Control Panel].
The "Control Panel" screen will be displayed.
3. Double click [Add/Remove Programs].
The "Add/Remove Programs Properties" screen will appear.
4. Click "Dynamic Image Utility 2.0" from the list.
5. Click [Add/Remove. . .].
The "Confirm File Deletion" screen will appear.
6. Check the message and click [Yes].
7. Now, follow the operations described in the screen messages.
When the uninstall procedure is completed, there will be a return to the "Add/Remove Programs Properties" screen.
8. Click [OK].
There will be a return to the "Control Panel" screen

6 Starting/Exiting the Software

Dynamic Image Utility 2.0

Start the Software

Preparation:

Install the software on the personal computer from the supplied CD-ROM. (Page 69)
The software cannot be started from the supplied CD-ROM.

From the [Start] menu click [Program] → [NEC Projector User Supportware] → [Dynamic Image Utility 2.0].
Dynamic Image Utility 2.0 will start.

Reference

- By selecting a PowerPoint file with Dynamic Image Utility 2.0 and clicking [Tools] → [Converting PowerPoint file], the function equivalent to Viewer PPT Converter 2.0 can be executed.

6. Using Dynamic Image Utility 2.0 on the supplied CD-ROM

Display Help

Preparation:

Please start Dynamic Image Utility 2.0.

1. Click [Help].

The [Help] menu will appear.

2. Click [Help].

The [Help] screen will appear.

Exit the Software

1. Click [File].

The [File] menu will appear.

2. Click [Exit].

Dynamic Image Utility 2.0 will close.

Viewer PPT Converter 2.0

Start the Software

Preparation:

(1) Check that Microsoft PowerPoint has been installed. Viewer PPT Converter 2.0 cannot be used unless PowerPoint has been installed.

(2) Install the software on the personal computer from the supplied CD-ROM. (Page 69)

The software cannot be started from the supplied CD-ROM.

1. From the [Start] menu click [Program] → [Projector User Supportware] → [Viewer PPT Converter 2.0].

Dynamic Image Utility 2.0 will start.

Reference

- *A function equivalent to Viewer PPT Converter 2.0 can also be executed from the Dynamic Image Utility 2.0 [Tools] → [Converting PowerPoint file] menu.*
- *Viewer PPT Converter 2.0 can also be started from the Microsoft PowerPoint 2000/2002 [Tools] → [Projector User Supportware] → [Output Viewer] menu.*

Display Help

Preparation:

Please start Viewer PPT Converter 2.0.

1. Click [Help].

The [Help] menu will appear.

Exit the Software

1. Click [Exit].

Viewer PPT Converter 2.0 will close.

7 Troubleshooting

In this section, the software names have been abbreviated as follows:

Dynamic Image Utility 2.0 to DIU 2.0 and Viewer PPT Converter 2.0 to PPTC 2.0.

<Problem> Installation does not complete normally.

Check Points	Countermeasures
When using Windows 2000, did you log on with "Administrators" authority? When using Windows XP, did you log on with "Computer Administrator" authority?	When using Windows 2000 or Windows XP, log on with the authority described at the left and then install.
Has Microsoft PowerPoint 2000/2002 been installed on the personal computer to which this projector software is being installed? When this projector software is installed on a personal computer that does not have PowerPoint 2000/2002 installed, a message to the effect of "Error in the automatic registration of PPTViewer2.dll" will appear part way through the installation.	When the message described at the left appears part way through the installation, add-in registration will not be made to PowerPoint; however, the installation of this projector software will be completed normally. To have add-in registration made to PowerPoint, please install this projector software to a personal computer on which PowerPoint 2000/2002 has been installed.

<Problem> Viewer PPT Converter 2.0 does not function. (PPTC 2.0)

Check Points	Countermeasures
Has Microsoft PowerPoint been installed on the personal computer?	Install PowerPoint on the personal computer. Or, install Viewer PPT Converter 2.0 on a personal computer on which PowerPoint has been installed.

<Problem> When using the projector control function, the projector power does not switch on. (DIU 2.0)

Check Points	Countermeasures
Are the personal computer and the projector connected by a serial cable?	Connect the personal computer and the projector with an serial cable.

<Problem> You want to delete the PowerPoint add-in registration. (PPTC 2.0)

Check Points	Countermeasures
Installing this projector software when Microsoft PowerPoint 2000/2002 has already been installed on the personal computer, will result in the automatic registration of the add-in to PowerPoint.	Please see the PowerPoint Help function for the method of deleting PowerPoint add-in registrations. The PowerPoint add-in registration will not be deleted even when this projector software is uninstalled.

7

Using On-Screen Menu

.....

❶	Using the Menus	74
❷	Menu tree	75
❸	Menu Elements	77
❹	Menu Descriptions & Functions [Adjust]	78
❺	Menu Descriptions & Functions [Image]	82
❻	Menu Descriptions & Functions [Setup]	85
❼	Menu Descriptions & Functions [Information]	100
❽	Menu Descriptions & Functions [Reset]	101
❾	Entry List	102

① Using the Menus

1. Press the **MENU** button on the remote control or the projector cabinet to display the menu.

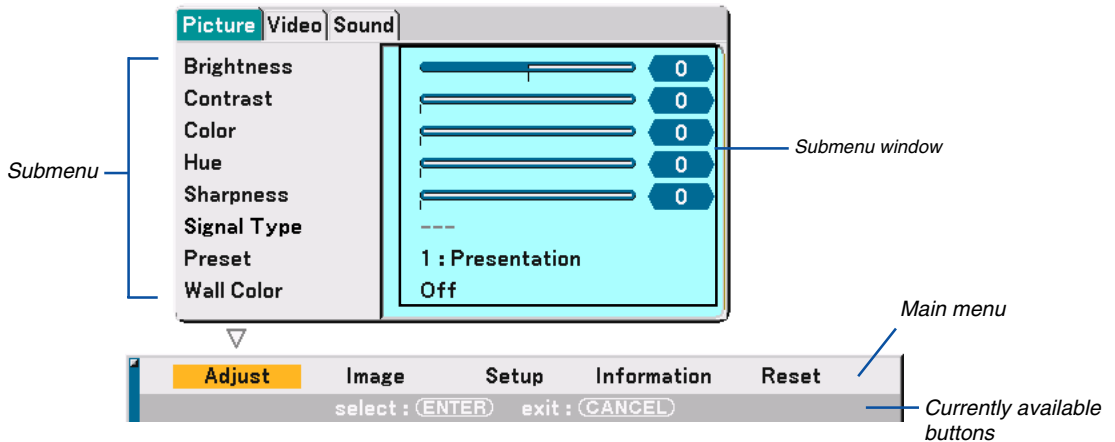

The Picture menu will be displayed (factory preset).

NOTE: The commands such as ◀▶, ENTER, CANCEL in the gray bar show available buttons for your operation.

2. Press the **SELECT** ◀▶ buttons on the remote control the projector cabinet to display the submenu.
3. Press the **ENTER** button on the remote control or the projector cabinet to highlight the top item or the first tab.
4. Use the **SELECT** ▲▼ buttons on the remote control or the projector cabinet to select the item you want to adjust or set.
You can use the **SELECT** ◀▶ buttons on the remote control or the projector cabinet to select the tab you want.

NOTE: You can select a tab only when the tab color is orange.

5. Press the **ENTER** button on the remote control or the projector cabinet to display the submenu window.

NOTE: You can also display a submenu window by pressing the **SELECT** ▶ button.

6. Adjust the level or turn the selected item on or off by using the **SELECT** ▲▼◀▶ buttons on the remote control or the projector cabinet.
7. Press the **ENTER** button or the **CANCEL** button on the remote control or the projector cabinet.
Changes are stored until you adjust it again.

ENTER Stores changes.

CANCEL Returns to the previous screen without storing changes.

8. Repeat steps 2 -7 to adjust an additional item, or press the **CANCEL** button on the remote control or the projector cabinet to quit the menu display.

2 Menu tree

Menu		Item			
Adjust	Picture	Brightness			
		Contrast	Manual/Auto		
		Color			
		Hue			
		Sharpness			
		Signal Type	RGB, Component		
		Preset	1 to 5		
			Detail Settings	Reference	Presentation, Video, Movie, Graphic, sRGB
				Gamma Correction	Dynamic, Natural, Black Detail
				Color Temperature	5000, 6500, 7200, 7800, 8500, 9300
				White Balance	Brightness RGB, Contrast RGB
				Color Correction	Red, Green, Blue, Cyan, Magenta, Yellow
				Wall Color	Off, Blackboard, Light yellow, Light green, Light blue, Sky blue, Light rose, Pink
		Video	Noise Reduction	Low, Medium, High	
			Color Matrix	HDTV, SDTV	
Y/C Delay	0 to 15				
3D Y/C Separation	Motion Control		On/Off On: Still, Normal, Movie		
Vertical Enhancer	Off, 1, 2, 3				
I/P Converter	Deinterlace(Auto/Still), Interlace				
Sound	Bass	-15 to +15			
	Treble	-15 to +15			
Image	Aspect Ratio	4:3	4:3, Letterbox, Wide Screen, Crop		
		16:9	4:3 Window, Letterbox, Wide Screen, 4:3 Fill		
	Pixel Adjust	Clock			
		Phase			
	Position	Horizontal			
	Vertical				
	Overscan	0%, 5%, 10%			
Setup	Page 1	Screen	Screen Type	4:3, 16:9	
			Position		
		Orientation	Desktop Front, Ceiling Rear, Desktop Rear, Ceiling Front		
		Language[icon]	19 languages		
		Lamp Mode	Normal, Eco		
		Keystone	Auto, Manual		
		Menu Display Time	Manual, Auto 5 sec, Auto 15 sec, Auto 45 sec		
		Page 2	Cabinet Button	Unlock, Lock	
			Sleep Timer	Off, 0:30, 1:00, 2:00, 4:00, 8:00, 12:00, 16:00	
			Password	Logo	
	Security		Keyword		
			Use Protect Key		
			Drive		
			Read		
			Register		
		Delete			
	Background	Blue, Black, Logo			

2 Menu tree

Menu		Item		
Setup	Page 3	Signal Select	Computer1	RGB/Component, RGB, Component
			Computer2	RGB/Component, RGB, Component, Scart
			Component	Auto, Component, Video
		Color System	Component (Video)	Auto, NTSC3.58, NTSC4.43, PAL, PAL-M, PAL-N, PAL60, SECAM
			Video	Auto, NTSC3.58, NTSC4.43, PAL, PAL-M, PAL-N, PAL60, SECAM
			S-Video	Auto, NTSC3.58, NTSC4.43, PAL, PAL-M, PAL-N, PAL60, SECAM
		OUT Terminal	Last, Computer1, Computer2, Component	
		S-Video Mode Select	Off, S2	
		Display Select	Source	On, Off
			Message	On, Off
	Menu Color	Color, Monochrome		
	Page 4	Power Management	On, Off	
		Power Off Confirmation	On, Off	
		Fan Mode	Auto, High Speed	
		Standby Mode	Power-saving Mode, Idle Mode	
		Auto Start	On, Off	
		Remote Sensor	Front	On, Off
			Back	On, Off
	Page 5	Filter Usage	Clear Filter Usage Meter	
		Lamp Hour	Clear Lamp Hour Meter	
Communication Speed		4800, 9600, 19200, 38400		
Pointer		Pointer 1 to 9		
Mouse		Pointer	Pointer 1 to 9	
		Button	Right Hand, Left Hand	
Information	Page 1	Source Name		
		Input Terminal		
		Entry No.		
		Horizontal Frequency		
		Vertical Frequency		
	Page 2	Signal Type		
		Video Type		
		Sync Type		
		Interlace		
	Page 3	Sync Polarity		
		Remaining Lamp Time		
		Lamp Hour Meter		
		Filter Usage		
	Page 4	Projector Usage		
Version		BIOS, Firmware, Data		
Reset		Current Signal, All Data, All Data (Including Entry List)		

3 Menu Elements

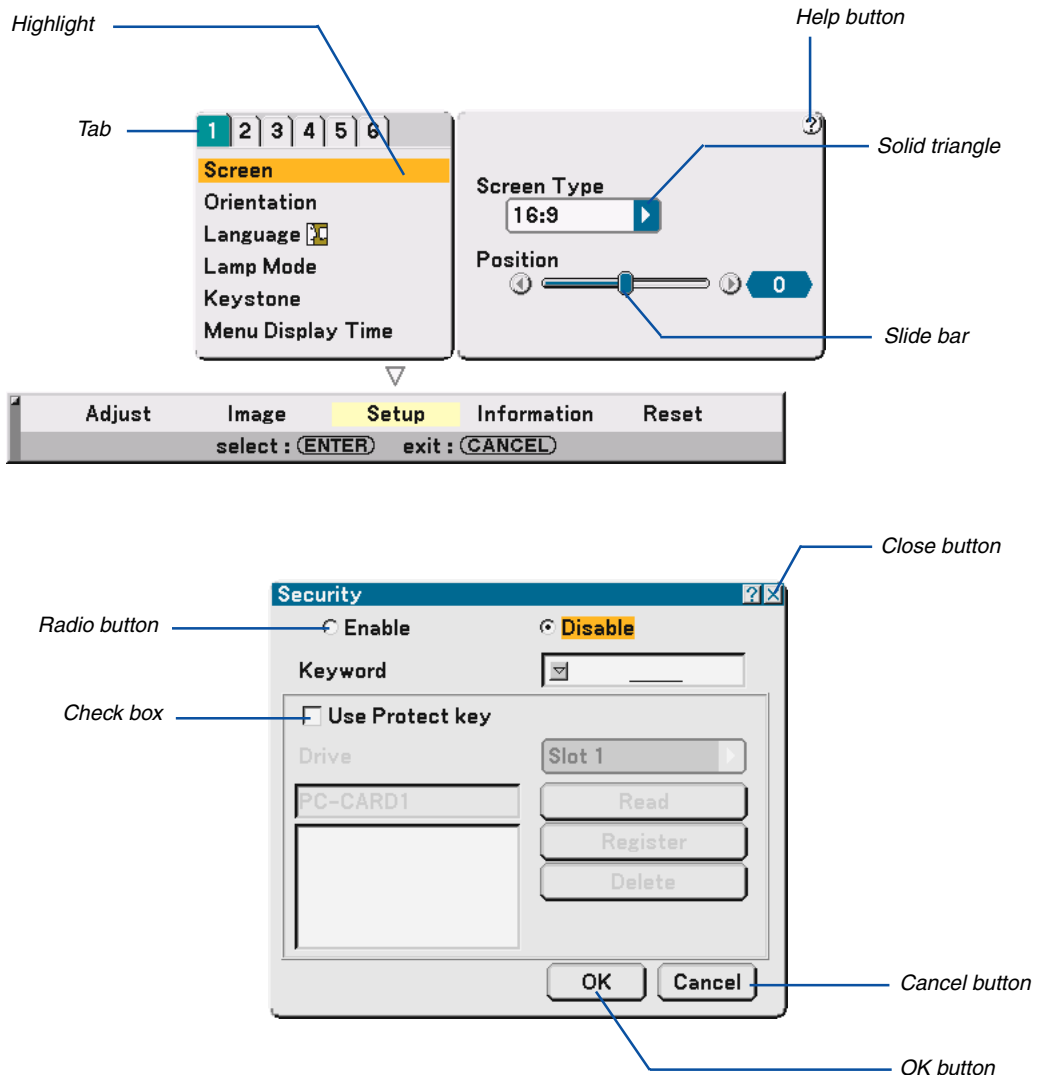

Menu windows or dialog boxes typically have the following elements:

- Highlight..... Indicates the selected menu or item.
- Solid triangle Indicates further choices are available. A highlighted triangle indicates the item is active.
- Tab Indicates a group of features in a dialog box. Selecting on any tab brings its page to the front.
- Radio button Use this round button to select an option in a dialog box.
- Check box Place a checkmark in the square box to turn the option On.
- Slide bar Indicates settings or the direction of adjustment.
- OK button Press to confirm your setting. You will return to the previous menu.
- Cancel button Press to cancel your setting. You will return to the previous menu.
- Close button Click to close the window with saving changes. (USB mouse only)
- Help button Indicates that help about that feature is available (USB mouse only). Press the HELP button on the remote control to display help.

4 Menu Descriptions & Functions [Adjust]

Picture

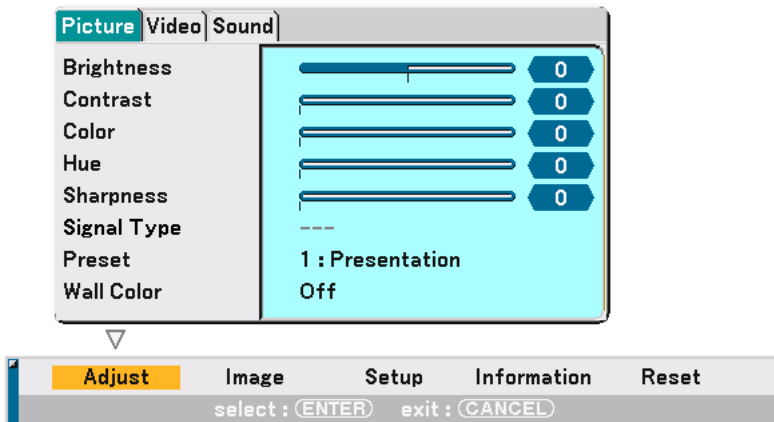

[Brightness]

Adjusts the brightness level or the back raster intensity.

[Contrast]

Adjusts the intensity of the image according to the incoming signal. You have two options: Manual/Auto.

[Color]

Increases or decreases the color saturation level (not valid for RGB).

[Hue]

Varies the color level from +/- green to +/-blue. The red level is used as reference. This adjustment is only valid for Video, Component and TV standard inputs (not valid for RGB).

[Sharpness]

Controls the detail of the image for Video (Not valid for RGB).

Selecting Signal Type [Signal Type]

Select either the computer signal type or the component signal type.

RGB Computer signal

Component Component signals such as Y/Cb/Cr, Y/Pb/Pr

NOTE: This feature is available on the computer signal only. If you do not get a better picture even when you set "Signal Select" to "Component" in Setup, set this to "Component".

[Preset]

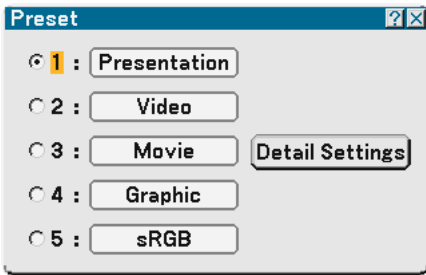

This option allows you to adjust neutral tint for yellow, cyan or magenta. There are 5 factory presets optimized for various types of images, you can set user adjustable settings.

Detail Settings

This will provide you with three pages of menus that provide more detailed settings.

[Page1]

Selecting Reference Setting [Reference]

This feature allows you to use color correction or gamma values as reference data to optimize for various types of images. You can select one of the following five settings.

- Presentation Recommended for presentations from a computer.
- Video Recommended for standard video such as a TV program.
- Movie Recommended for film based video such as a movie (DVD or HDTV).
- Graphic Recommended for viewing accurate colors in graphics.
- sRGB Standard color values.

Selecting Gamma Correction Mode [Gamma Correction]

Each mode is recommended for:

- Dynamic Creates a high-contrast picture.
- Natural Natural reproduction of the picture.
- Black Detail Emphasizes detail in dark areas of the picture.

Adjusting Color Temperature [Color Temperature]

This feature adjusts the color temperature using the slide bar. The range is between 5000K and 9300K.

NOTE:

- * When "Presentation" is selected in "Reference", this function is not available.
- * When "White Balance" settings has been changed, the color temperature value on screen does not reflect the real color temperature.

[Page 2]

Adjusting White Balance [White Balance]

This allows you to adjust the white balance. Brightness for each color (RGB) is used to adjust the black level of the screen; Contrast for each color (RGB) to adjust the white level of the screen.

[Page 3]

Selecting Color Correction [Color Correction]

Adjusts red, green, blue, yellow, magenta and cyan each independently to correct the tint on whole screen.

Using the Wall Color Correction [Wall Color]

[Interface to be determined]

This function allows for quick adaptive color correction in applications where the screen material is not white. The following eight options are available.

- OFF
- Light yellow
- Light blue
- Light rose
- Blackboard
- Light green
- Sky blue
- Pink

Video Adjustment

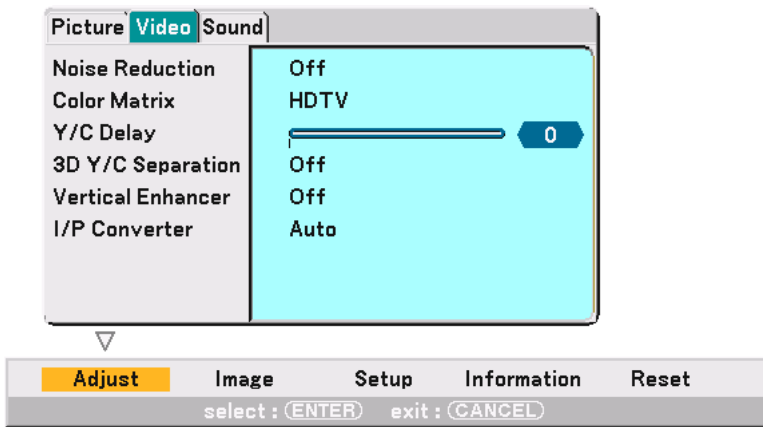

Selecting Noise Reduction Level [Noise Reduction]

(not available for COMPUTER1/2 and Viewer; available for TV standard inputs)

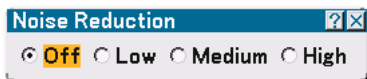

Select one of the three levels for reducing video noise: Low, Medium or High.

NOTE: The lower the Noise Reduction level, the better the image quality by way of higher video bandwidth.

Selecting Color Matrix [Color Matrix]



Select an appropriate color matrix for your input signal, either HDTV or SDTV.

Adjusting Y/C Delay Level [Y/C Delay]



Adjusts Y/C delay level.

Turning On/Off 3 Dimension Separation [3D Y/C Separation]

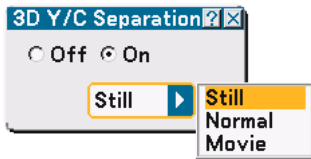

This function turns on or off the 3 dimensional separation feature.
When "On" is selected, the following three options are available from the pull-down list.

- Still Select this option for a still image.
- Normal The projector automatically makes the appropriate settings for a detected source.
- Movie Select this option for a moving image.

NOTE: This feature is available for NTSC3.58 of Video signal only.

Setting Vertical Edges [Vertical Enhancer]

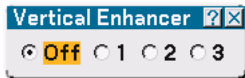

This function enhances the vertical edges around objects in the image.

NOTE: This function is not available for an RGB and Component signal.

Selecting Interlace or Deinterlace [I/P Converter]

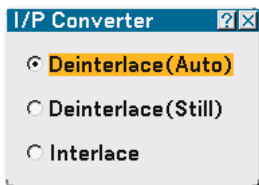

This function allows you to select between "Interlace" and "Deinterlace".

- Deinterlace (Auto) The projector automatically determines a still or moving image to display a clear picture. If selecting "Deinterlace (Auto)" causes excess jitter or artifacts, select "Interlace".
- Deinterlace (Still) Select when a still image is displayed. When this option is selected for a moving image, jitter or artifacts can be seen.
- Interlace Select when a moving image is displayed. This will eliminate jitter and artifacts in a moving image.

Controlling Bass and Treble [Sound]

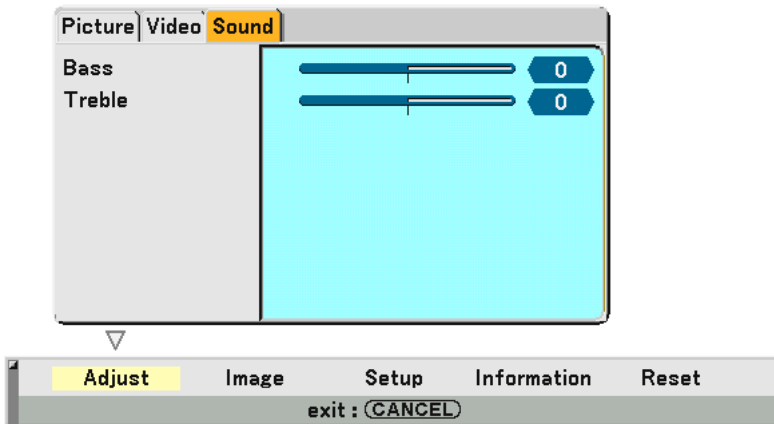

You can adjust the bass and treble level of the projector speakers and AUDIO OUT (Stereo Mini Jack).

5 Menu Descriptions & Functions [Image]

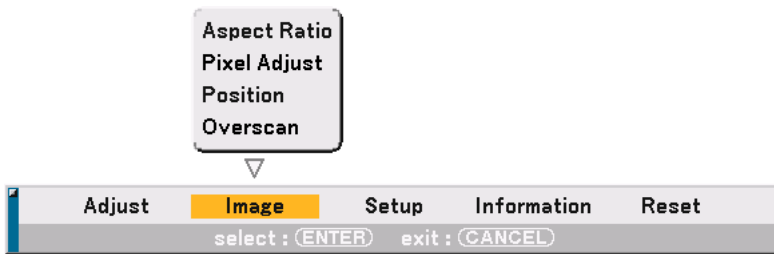

[Page 1]

Selecting Aspect Ratio [Aspect Ratio] (not available for Viewer)

Screen Type 4:3

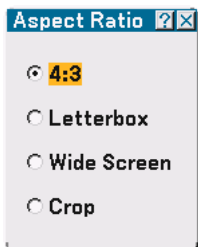

Screen Type 16:9

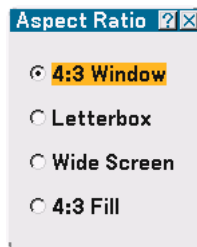

Aspect Ratio allows you to select the best Aspect mode to display your source image. When screen type 4:3 is selected for the source, the following selections will display:

- 4:3 Standard 4:3 aspect
- Letter Box Reduced to display the true aspect with black borders on top and bottom
- Wide Screen Left & Right stretched with black borders on top and bottom
- Crop Left & Right stretched. Left & Right sides cut. Available for 4:3 only.

7. Using On-Screen Menu

When screen type 16:9 is selected for the source, the following selections will display:

- 4:3 Window Reduced to display the true aspect with black borders on right and left
- Letter Box Standard 16:9 aspect
- Wide Screen Left and right stretched to display the true aspect
- 4:3 Fill Stretched to display in 16:9 aspect ratio

NOTE: You can adjust image positions vertically for source with black borders. See page 85 for setting image positions.











Copyright

Please note that using this projector for the purpose of commercial gain or the attraction of public attention in a venue such as a coffee shop or hotel and employing compression or expansion of the screen image with a "Aspect Ratio" or "Screen" setting may raise concern about the infringement of copyrights which are protected by copyright law.

NOTE: During 3D Reform adjustment, "Aspect Ratio" may not be available.

Should this happen, first reset the 3D Reform data and then do setting again. Second repeat the 3D Reform adjustment.

Changing the aspect ratio can limit 3D Reform in its adjustable range.

Input Signal / Screen Type	4:3	Letterbox	Squeeze	
4:3 Screen	 4:3	 Letterbox	 Squeeze	
16:9 Screen	 4:3	 Letterbox	 Wide Screen	 Crop
16:9 Screen	 4:3 Window	 4:3 Fill	 Letterbox	 Wide Screen

Adjusting Clock and Phase [Pixel Adjust]



This allows you to manually adjust Clock and Phase.

Clock

Use this item to fine tune the computer image or to remove any vertical banding that might appear. This function adjusts the clock frequencies that eliminate the horizontal banding in the image.

This adjustment may be necessary when you connect your computer for the first time.

Phase

Use this item to adjust the clock phase or to reduce video noise, dot interference or cross talk. (This is evident when part of your image appears to be shimmering.)

Use "Phase" only after the "Clock" is complete.

Adjusting Horizontal/Vertical Position [Position]

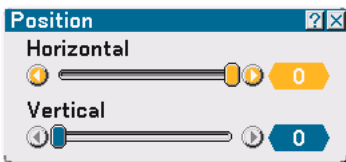

Adjusts the image location horizontally and vertically.

Selecting Overscan Percentage [Overscan]

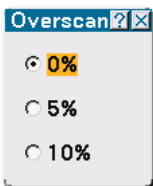

Select overscan percentage (0%, 5% and 10%) for signal.

NOTE: When "4:3 Fill" or "Crop" is selected in "Aspect Ratio", this feature is not available.

6 Menu Descriptions & Functions [Setup]



Setup [Page1]

Selecting Aspect Ratio and Position for Screen [Screen]

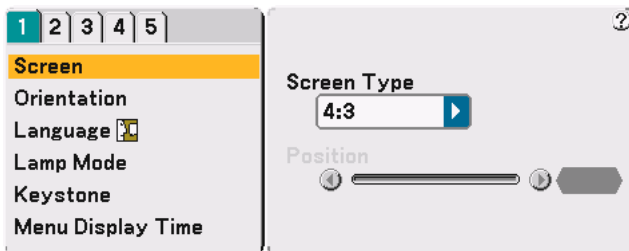

Screen Type

Select one of three options: 4:3 Screen or 16:9 Screen for the screen to be used. See also "Aspect Ratio" on pages 82 and 83.

Position

This feature adjusts the vertical position of the image when viewing video with an aspect ratio selected. When some aspect ratios are selected in Image, the image is displayed with black borders on the top and bottom. You can adjust the vertical position between top and bottom.

NOTE: This option is available only when "16:9" is selected in Screen Type.

NOTE: During 3D Reform adjustment, "Screen Type" and "Screen Position" may not be available. To make available, first reset the 3D Reform data and then do settings again. Secondly repeat the 3D Reform adjustment. Changing "Screen Type" and "Screen Position" can limit 3D Reform in its adjustable range.

Selecting Projector Orientation [Orientation]

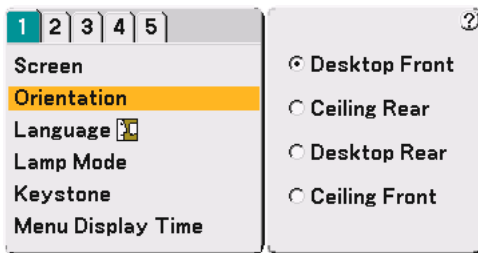

This reorients your image for your type of projection. The options are: desktop front projection, ceiling rear projection, desktop rear projection, and ceiling front projection.

NOTE: Selecting one of the other options than "Desktop Front" will force the "Keystone" mode to be "Manual".

Selecting Menu Language [Language]



You can choose one of 19 languages for on-screen instructions.

Setting Lamp Mode to Normal or Eco [Lamp Mode]

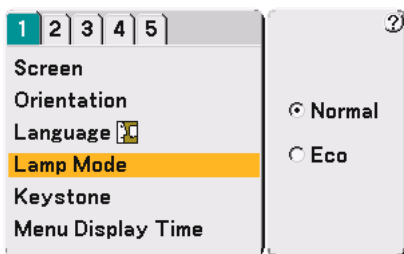

This feature enables you to select two brightness modes of the lamp: Normal and Eco modes. The lamp life can be extended up to 3000 hours by using the Eco mode. Selecting Eco mode decreases fan noise compared to in Normal mode.

Normal Mode This is the default setting (100% Brightness).

Eco Mode Select this mode to increase the lamp life (76% Brightness).

NOTE: If the projector is overheated in Normal mode, there may be a case where the Lamp mode automatically changes to Eco mode to protect the projector. When the projector is in Eco mode, the picture becomes slightly darker. When the projector comes back to normal temperature, the Lamp mode returns to Normal mode.

NOTE: When a picture is muted or there are no signals (blue or black screen), the Eco mode will be automatically selected in "Lamp Mode."

Selecting Keystone Mode [Keystone]

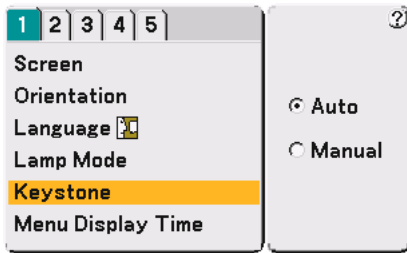

This feature allows you to correct keystone distortion manually or automatically.

Auto This feature allows the projector to detect its tilt and correct vertical distortion automatically.

Manual You can correct vertical distortion manually from the menu.

Changes will be saved even when you turn off the projector.

Selecting Menu Display Time [Menu Display Time]

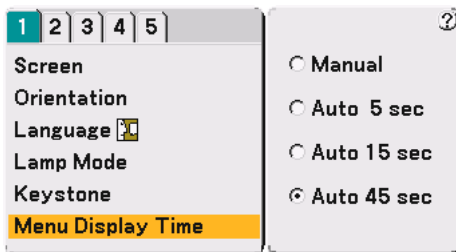

This option allows you to select how long the projector waits after the last touch of a button to turn off the menu. The preset choices are "Manual", "Auto 5 sec", "Auto 15 sec", and "Auto 45 sec". The "Auto 45 sec" is the factory preset.

Manual The menu can be turned off manually.

Auto 5 sec The menu will automatically be turned off in 5 seconds if no buttons are pressed within 5 seconds.

Auto 15 sec The menu will automatically be turned off in 15 seconds if no buttons are pressed within 15 seconds.

Auto 45 sec The menu will automatically be turned off in 45 seconds if no buttons are pressed within 45 seconds.

Setup [Page2]



Disabling the Cabinet Buttons [Cabinet Button]

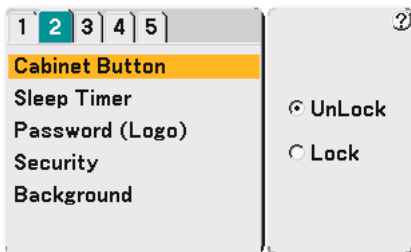

This option turns on or off the Cabinet Button Lock function.

NOTE:

- This Cabinet Button Lock does not affect the remote control functions.
- When the cabinet buttons are locked, pressing and holding the CANCEL button for about 10 seconds will change the setting to unlock.

Using Sleep Timer [Sleep Timer]

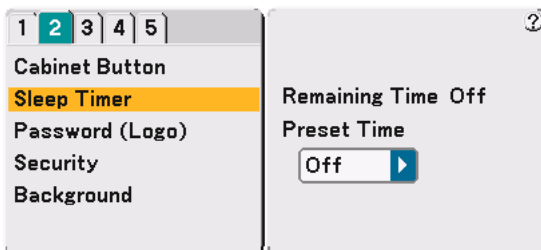

1. Select your desired time between 30 minutes and 16 hours: Off, 0:30, 1:00, 2:00, 4:00, 8:00, 12:00, 16:00.
2. Press the ENTER button on the remote control.
3. The remaining time starts counting down.
4. The projector will turn off after the countdown is complete.

NOTE:

- To cancel the preset time, set "Off" for the preset time or turn off the power.
- When the remaining time reaches 3 minutes before the projector is turned off, the "Projector will turn off in 3 minutes" message will be displayed on the bottom of the screen.

Setting a Password [Password (Logo)]

A password can be set for your projector to avoid operation by an unauthorized person.

When a password is set, doing any one of the following two operations will display the Password input screen.

- Changing the background
- Changing the logo data in a PC card

Entry:

To assign your password:

NOTE: Up to 15 alphanumeric characters can be assigned.

1. Type a password.

Highlight "Entry" and press the ENTER button.



The "Enter the Password" screen will be displayed.

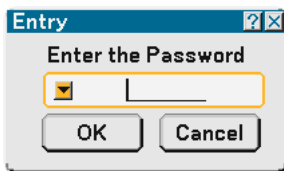

Make sure that  is highlighted and then press the ENTER button.

The Software keyboard appears. Use the Software keyboard to type a password and then highlight "OK" on the "Enter the Password" screen and press the ENTER button.

The [Confirm Password] screen will be displayed.

2. Type the same password again. Highlight "OK" on the "Enter the Password" screen and press the ENTER button.

Your password will be assigned.

Delete:

To delete your password:

1. Highlight [Delete] and press the ENTER button. The "Current Password" screen will be displayed.



2. Use the Software keyboard to type your password. Highlight "OK" on the "Current Password" screen and then press the ENTER button.

Your password will be deleted.

Security

The Security function enables you to protect your projector so that the projector will not project a signal unless you enter a keyword. There is also an option to lock the projector by using a registered PC card as a protect key. Once you have registered your PC card as a protect key, you are required to insert the registered PC card into the PC card slot of the projector each time you turn on the projector. You can enable the Security function by using a keyword only.

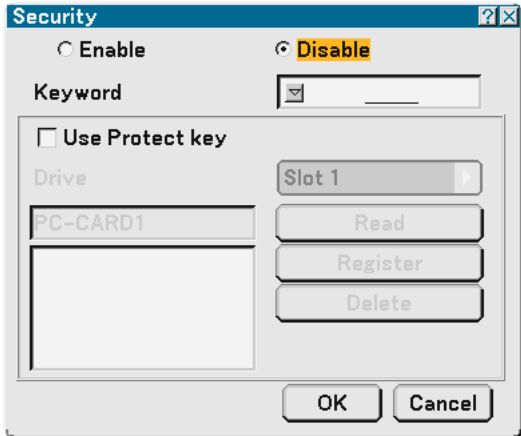

Enable/Disable This turns the Security function on or off.

Keyword Enter an appropriate keyword when you use the Security function. (Up to 10 characters can be used.) The Security function is available only when your keyword is entered.

Use Protect key Check this box to lock your projector when using a PC card. To use a keyword without a PC card, do not check this box.

Drive Switches between PC Card slot and USB port (type A).

Read Reads data from a PC card.

Register Registers data from the PC card. The Security function is not available unless at least one PC card is registered. (if the “Use Protect key” check box is selected) Up to 5 PC cards can be registered.

Delete Deletes data of a registered PC card.

To set up a keyword to enable the Security function without using a registered PC card.

1. Use the SELECT ▲▼ button to select “Keyword” and use the software keyboard to enter a keyword.

NOTE: Please make a note of your keyword.

2. Use the SELECT ▲▼ button to select “Enable” and use the SELECT ▲▼ button to select “OK”, then the Security function will be enabled.

An “Are you sure?” message will appear. Use the SELECT ◀▶ button to select “OK” and press the ENTER button.

The Security function takes effect.

To register a PC card as a protect key.

1. **Insert a PC card into the PC card slot of the projector.**
2. **Use the SELECT ▲▼ button to select "Use Protect Key" and press the ENTER button.**
3. **Use the SELECT ▲▼ button to select "Read" and press the ENTER button.**
Data of the PC card will be read into the projector.
4. **Use the SELECT ▲▼ button to select "Register" and press the ENTER button.**
Downloaded data will be registered and be displayed in the list window.
5. **Use the SELECT ▲▼ button to select "Keyword" and use the software keyboard to enter a keyword.**

NOTE: To use a PC card as a protect key, you must also set up a keyword. Please make a note of your keyword.

This completes registration of your PC card.

To enable Security, use the SELECT ▲▼ button to select "Enable" and use the SELECT ▲▼ button to select "OK" and "Security function will be enabled. An "Are you sure?" message will appear. Use the SELECT ◀▶ button and press the ENTER button.

The Security function takes effect.

To turn on the projector when Security is enabled (when using your keyword only).

1. **Press and hold the POWER button for a minimum of two seconds.**
The projector will be turned on and display a message to the effect that the projector is security-protected.
2. **Select [Setup] → [Page 2] → [Security] from the menu and press the ENTER button.**
The Release Code input screen will be displayed.
3. **Enter your keyword in the Release Code input screen.**
You can view the projected image.

NOTE: Do not forget your keyword. However, if you forget your keyword, NEC or your dealer will provide you with your Release Code. See more information at the end of this section.

To turn on the projector when Security is enabled (when using PC card as a protect key).

1. **Insert your registered PC card into the PC card slot.**
2. **Press and hold the POWER button for a minimum of two seconds.**
The projector will turn on and then recognize the PC card. Once the image has been projected, it will stay on without the PC card.
 - *The security disable mode is maintained until the main power is turned off (by setting the main power switch to "O" or unplugging the power cord). In the following cases you will be asked to check the protect key or input the keyword:*
 - (1) *When "OK" is selected at an image for which security is set and the power is turned off then back on*
 - (2) *When the main power is turned off then back on while the security function is enabled*
 - (3) *When you attempt to display an image for which security is set while the security function is enabled*
 - *Blanks (spaces) cannot be used in the Keyword section.*

To delete PC card data you registered.

1. Use the **SELECT ▲▼** button to select "Delete" and use the **SELECT ◀** button to select the list window.
2. Use the **SELECT ▲▼** button to select the PC card data you wish to delete.
3. Press the **SELECT ▶** button to select "Delete" and press the **ENTER** button.

The PC card data will be deleted.

If you've lost your registered PC card, proceed as follows:

NOTE: NEC or your dealer will provide you with your Release Code in exchange for your registered keyword and Request Code. See more information at the end of this section.

1. Press and hold the **POWER** button for a minimum of two seconds.
The projector will be turned on and display a message to the effect that the projector is security-protected.
 2. Select **[Setup] → [Page 2] → [Security]** from the menu and press the **ENTER** button.
The Release Code input screen will be displayed as well as your Request Code (24 alphanumeric characters).
 3. Enter your Release Code in the Release Code Input screen.
The projector will turn on.
- * *If the projector is turned on by entering the Release Code, your Security will be disabled.*

NOTE:

- Some types of PC cards cannot be registered as your protect key.
 - It is recommended that you register two or more PC cards in case you lose or damage your registered PC card.
 - Formatting your registered PC card will disable your protect key function.
-

NOTE:

For additional information visit:

US : <http://www.necvisualsystems.com>

Europe : <http://www.nec-europe.com/>

Global : <http://www.nec-pj.com/>

Selecting a Color or Logo for Background [Background]

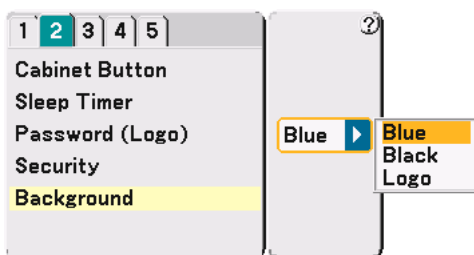

Use this feature to display a blue/black screen or logo when no signal is available. The default background is blue. You can change the logo screen using the Viewer feature. See pages 64.

NOTE: When the projector displays a blue or a black screen, the Eco mode will be automatically selected in "Lamp Mode."

Setup [Page3]

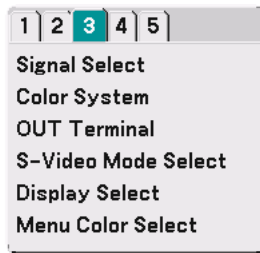

Selecting Signal Format [Signal Select]

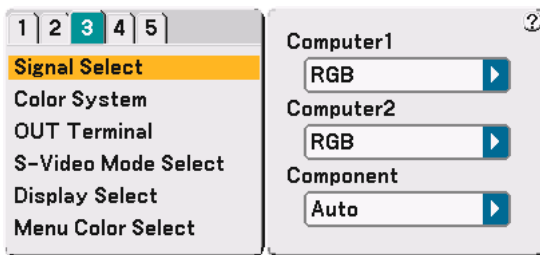

Computer 1/2

Allows you to set "Computer 1" and "Computer 2" to automatically detect an incoming RGB or component source such as a computer or DVD player. However there may be some RGB and component signals that the projector is unable to detect. In this case, select "RGB" or "Component".
Select "Scart" in COMPUTER 2 for the European Scart signal.

Component

Normally select "Auto" and the projector automatically detects an incoming signal. However there may be some component signals that the projector is unable to detect.
If this is the case, select "Component".

NOTE: When using the "Y" connector of the COMPONENT connectors to display a Video signal, select "Video".

Selecting Color System [Color System]

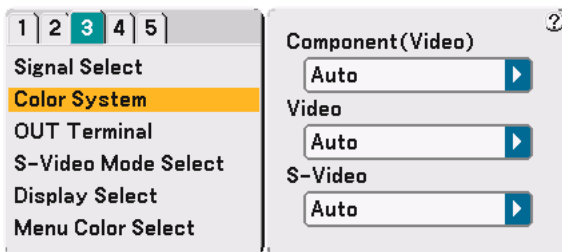

This feature enables you to select composite video standards automatically or manually.

Normally select "Auto" and the projector will automatically detect the video standard.

In the case where the projector has difficulty detecting the video standard, select the appropriate video standard from the menu.

Setting MONITOR OUT Connector [OUT Terminal]

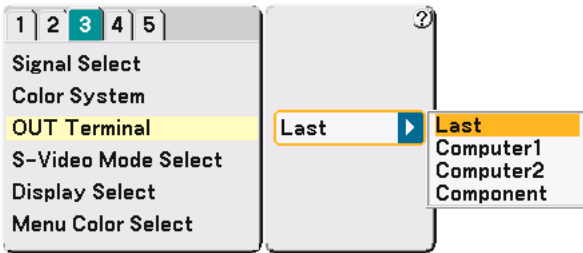

This option allows you to determine which RGB or component source is output from the MONITOR OUT connector during Idle mode.

Last The signal from the last COMPUTER1 or 2, or COMPONENT input will be output to the MONITOR OUT connector.

COMPUTER 1, 2 The signal from the COMPUTER1 or 2 input will be output to the MONITOR OUT connector.

COMPONENT The signal from the COMPONENT input will be output to the MONITOR OUT connector.

Selecting S-Video Mode [S-Video Mode Select]

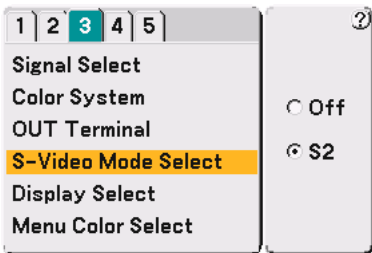

This feature is used to select the S-Video signal detection mode. This allows identifying of the S-Video signals with different aspect ratio (16:9 and 4:3).

Off Does not identify any S-video signal.

S2 Identifies the 16:9 or 4:3 signal.

Turning On / Off Source Display and Message [Display Select]

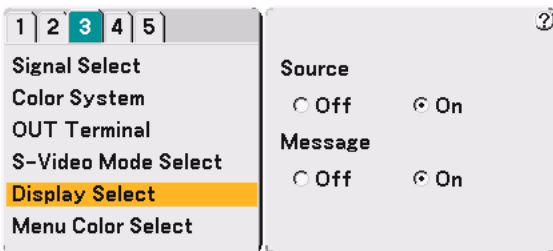

Source

This option turns on or off input name display such as Computer 1/2, Video, and No Input to be displayed in the top right corner of the screen.

Message

This option turns on and off messages for lamp life warning, 3-minute before power off time, "Please clean filter" and "Please wait a moment".

Selecting Menu Color [Menu Color Select]

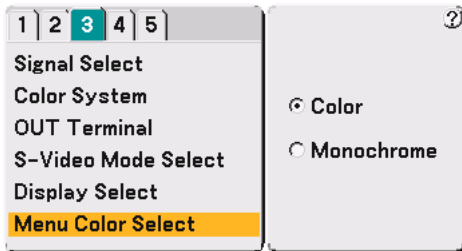

You can choose between two color modes for menu color: color and monochrome.

Setup [Page4]

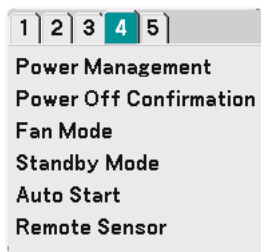

Enabling Power Management [Power Management]

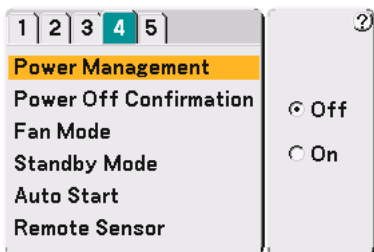

When this option is on and there is no input for five minutes or more, the projector will automatically turn itself off.

Enabling Power Off Confirmation [Power Off Confirmation]

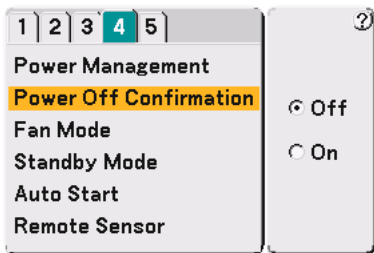

This option determines whether a confirmation dialog for turning off the projector will appear or not.

NOTE: When the confirmation message is displayed, you must be in the Projector mode to operate your projector using the remote control. If not, press the PJ button on the remote control to change your projector to the Projector mode. The button lights to indicate that you are in the Projector mode.

Enabling High Speed Fan Mode [Fan Mode]

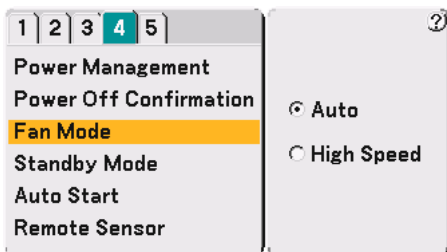

This option allows you to select two modes for fan speed: Auto mode and High speed mode.

Auto The built-in fans automatically run at a variable speed according to the internal temperature.

High Speed The built-in fans run at a fixed high speed.

When you wish to cool down the temperature inside the projector quickly, select "High Speed".

NOTE: Select High speed mode if you continue to use the projector for consecutive days.

Enabling Standby Mode [Standby Mode]

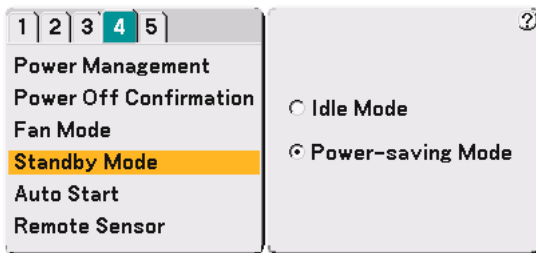

The projector has two standby modes: Idle mode and Power-saving mode. Power-saving mode is the mode that allows you to put the projector in the standby condition which consumes less power than the Idle mode. The projector is preset for Idle mode at the factory.

NOTE:

- The MONITOR OUT function is not available during Power-saving mode.
- Control through the PC Control connector is not available during Power-saving mode. For PC control of the projector it is recommended to leave the projector in Idle mode.

Enabling Auto Start [Auto Start]

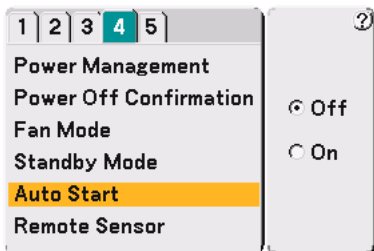

Turns the projector on automatically when the power cable is inserted into an active power outlet and the main power switch is turned on. This eliminates the need to always use the "Power" button on the remote control or projector cabinet.

[Remote Sensor]

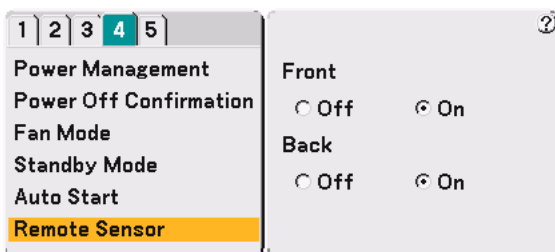

This option determines which remote sensor on the projector is enabled. Selecting "On" indicates that the selected remote sensor can accept the infrared signal from the supplied remote control.

Setup [Page5]

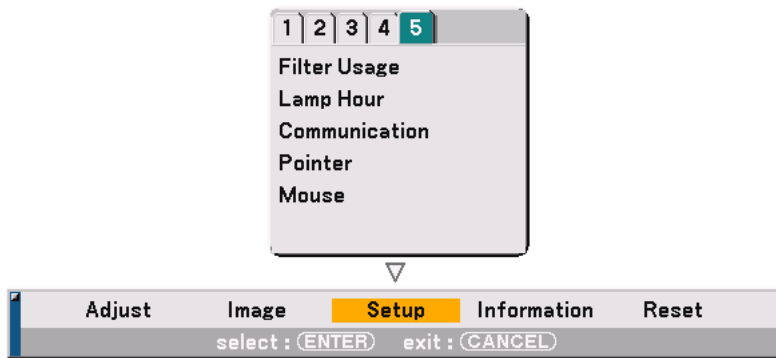

Resetting the Filter Usage Hours [Filter Usage]

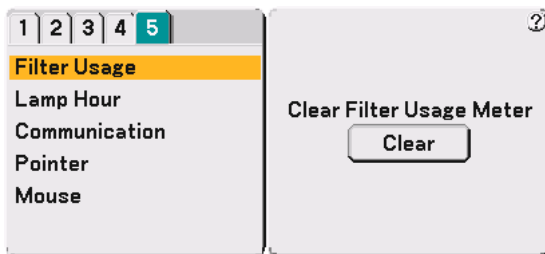

Resets the filter usage back to zero. Pressing the Clear button displays a confirmation dialog box. To reset the filter usage hours, press "OK".

Clearing Lamp Hour Meter [Lamp Hour]

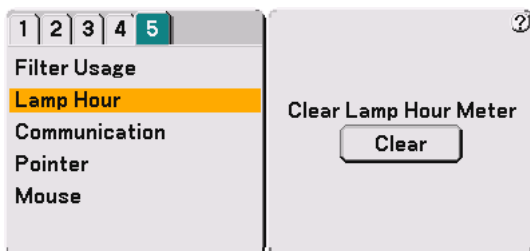

Resets the lamp clock back to zero. Pressing the Clear button displays a confirmation dialog box. To reset the lamp usage hour, press "OK".

NOTE: The projector will turn off and go into standby mode after 2100 hours (up to 3100 hours in Eco mode) of service. In this condition you cannot clear the lamp hour meter on the menu. If this happens, press the "HELP" button on the remote control for ten seconds to reset the lamp clock back to zero. Do this only after replacing the lamp.

Selecting Communication Speed [Communication]

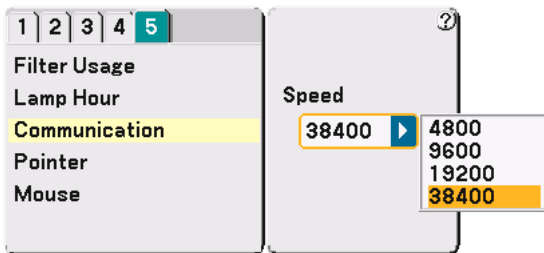

This feature sets the baud rate of the PC Control port (D-Sub 9 Pin). It supports data rates from 4800 to 38400 bps. The default is 38400 bps. Select the appropriate baud rate for your equipment to be connected (depending on the equipment, a lower baud rate may be recommended for long cable runs).

Selecting Projecting Pointer Icon [Pointer]

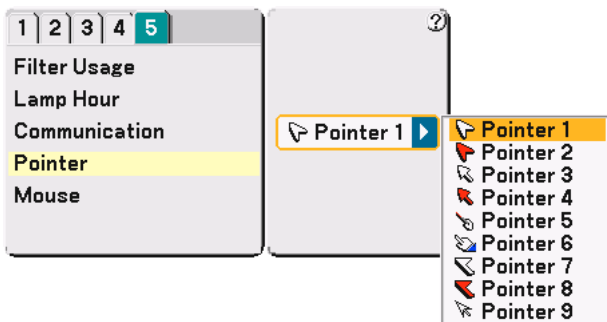

This enables you to select from nine different Pointer icons for the "Pointer" button on your remote control. After moving your Pointer icon to the area you want on the screen, press the MAGNIFY button on the remote control to enlarge the selected area on the screen. See page 41 for more details.

NOTE: There may be cases where the Pointer function is not available (ex. A non-interlace signal at 15kHz such as video game.)

Setting Mouse Pointer, Button and Sensitivity [Mouse]

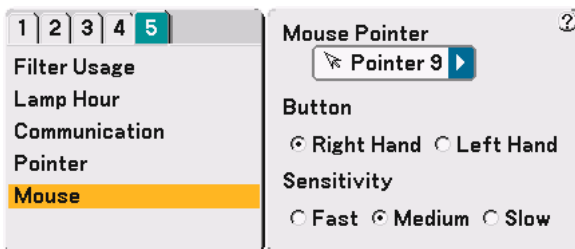

This option lets you to change your USB mouse settings. The mouse settings feature is available for USB mouse only. Choose the settings you want:

- Mouse Pointer Pointer 1 - 9
- Mouse Button "Right Hand" or "Left Hand"
- Mouse Sensitivity .. "Fast", "Medium" or "Slow"

7 Menu Descriptions & Functions [Information]

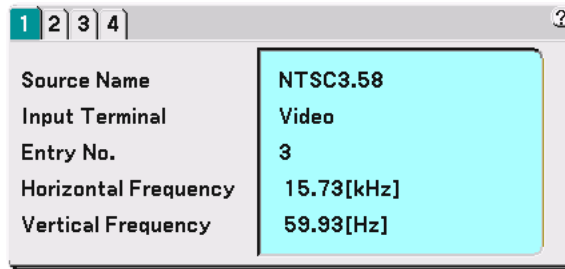

Displays the status of the current signal, the lamp and the projector usage hours. This dialog box has four pages. The information included are as follows:

[Page 1] Source Name
Input Terminal
Entry No.
Horizontal Frequency
Vertical Frequency

[Page 2] Signal Type
Video Type
Sync Type
Interlace
Sync Polarity

[Page 3] Remaining Lamp Time (%)
Lamp Hour Meter (H)
Filter Usage (H)
Projector Usage (H)

NOTE: The progress indicator shows the percentage of remaining bulb life. The value informs you of the amount of lamp and projector usage respectively.

[Page 4] Version (BIOS, Firmware, Data)

Remaining Lamp Time Display

When the remaining lamp time reaches 0, the Remaining Lamp Time bar indicator changes from 0% to 100 Hours and starts counting down. If the remaining lamp time reaches 0 hours, the projector will not turn on regardless of whether the lamp mode is set to Normal or Eco.

8 Menu Descriptions & Functions [Reset]

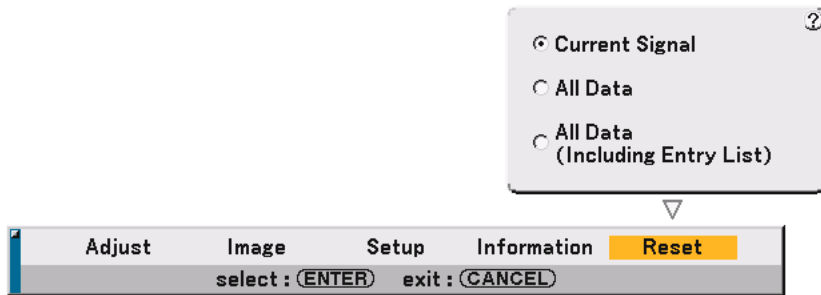

Returning to Factory Default

The Reset feature allows you to change adjustments and settings to the factory preset for sources by the following methods:

Current Signal

Resets the adjustments for the current signal to the factory preset levels.
All the items in "Adjust (except "Wall Color") and "Image" can be reset.

All Data

Reset all the adjustments and settings for all the signals to the factory preset except Remaining Lamp Time, Lamp Hour Meter, Filter Usage, Projector Usage, Communication, Language, Background, Entry List, Standby Mode, Security and Password (Logo).
(To reset the lamp usage time, see "Clear Lamp Hour Meter" on page 98)

All Data (Including Entry List)

Reset all the adjustments and settings for all the signals to the factory preset except Remaining Lamp Time, Lamp Hour Meter, Filter Usage, Projector Usage, Communication, Language, Background, Entry List, Standby Mode, Security and Password (Logo).
Also deletes all the signals in the Entry List and returns to the factory preset.

NOTE: Locked signals in Entry List cannot be reset.

9 Entry List

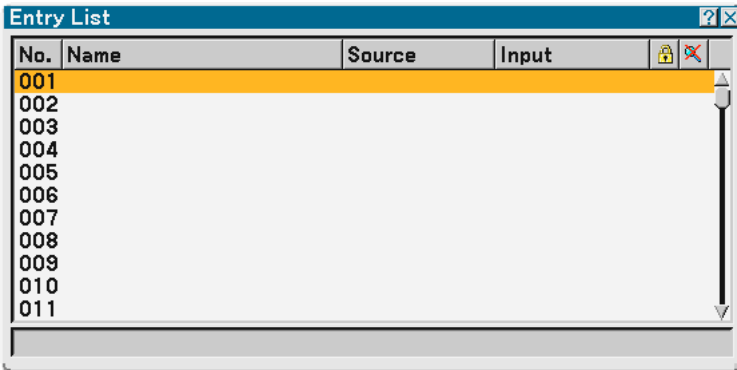

Displaying the Entry List

Press the SOURCE button to display the list of the entry signals. Use the SELECT ▲▼ buttons on your remote control or the projector cabinet to select the signal and press the ENTER button on the remote control or the projector cabinet to display the Entry Edit Command screen.

Entering the Currently Projected Signal into the Entry List

1. Display the Entry List.
2. Use the SELECT ▲ or ▼ button on your remote control or the projector cabinet to select any number and press the ENTER button on the remote control or the projector cabinet to display the Entry Edit Command screen.
3. Use the SELECT ◀ or ▶ button to select "Store" and press the ENTER button.

Using the Entry List

Making any adjustments to the current picture will automatically register its adjustments to the Entry List. The registered signal can be loaded any time from the Entry List.

NOTE: Up to 100 presets can be registered except settings on the Picture.

Entry Edit Command

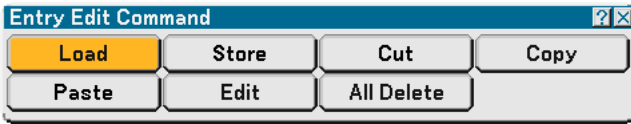

You can edit signals on the Entry List.

Load Enables you to select a signal from the list.

Store Enables you to store the currently projected signal.

Cut Enables you to remove a selected signal from the list and place it on the "clipboard" in the projector.

Copy Enables you to copy a selected signal from the list and place it on the "clipboard" in the projector.

Paste Enables you to paste the signal placed on the "clipboard" to any other line of the list. To do this, select "Paste" and then select the line number you want to paste to. Last press ENTER.

Edit Enables you to change source names.

Source Name:

Enter a signal name. Up to 18 alphanumeric characters can be used.

Input Terminal:

Change the input terminal. Video and S-Video are available for composite signal. Component and Computer are available for component signal.

Lock:

Set so that the selected signal cannot be deleted when "All Delete" is executed.

Skip:

Set so that the selected signal will be skipped during auto search.

When complete, select OK and press ENTER. To exit without storing setting, select Cancel. Select "Source Name" and press ENTER to display the Source Name Edit window. You can change source name on this window. Press ▼ to display the software keyboard, which you can enter alphanumeric characters. See page 120 for the key function of the software keyboard.

All Delete This feature enables you to delete all the registered signals in the Entry List.

The following buttons are not available for the currently projecting signals:

- 1) The Cut and Paste buttons on the Entry Edit Command screen
- 2) The Input Terminal button on the Entry Edit screen

NOTE: When all the signals in the Entry List are deleted, the currently projected signal will be also deleted except locked signals.

8

Maintenance

.....

❶	Cleaning the Filters	105
❷	Cleaning the Cabinet	105
❸	Cleaning the Lens	106
❹	Replacing the Lamp and Filters	107

This section describes the simple maintenance procedures you should follow to clean the filter and replace the lamp.

① Cleaning the Filters

The air-filter sponge keeps dust and dirt from getting inside the projector and should be cleaned after every 100 hours of operation (more often in dusty conditions). If the filters are dirty or clogged, your projector may overheat.

CAUTION

- Turn off the projector, turn off the main power switch and unplug the projector before cleaning the filters.
- Only clean the outside of the filter cover with a vacuum cleaner.

1. Vacuum the filter from the outside.

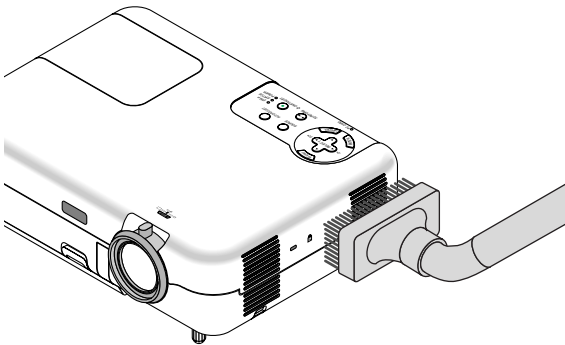

2. Reset the filter usage time.

To reset the filter usage time, from the menu, select [Setup] → [Page 5] → [Filter Usage] → [Clear Filter Usage Meter] and then press "Clear".

See also page 98 for resetting the filter usage time.

② Cleaning the Cabinet

CAUTION

Turn off the projector, turn off the main power switch and unplug the projector before cleaning the cabinet.

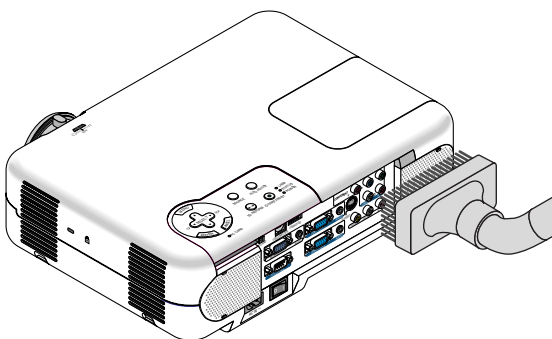

Clean the cabinet periodically with a damp cloth. If heavily soiled, use a mild detergent. Never use strong detergents or solvents such as alcohol or thinner.

③ Cleaning the Lens

CAUTION

Turn off the projector, turn off the main power switch and unplug the projector before cleaning lens.

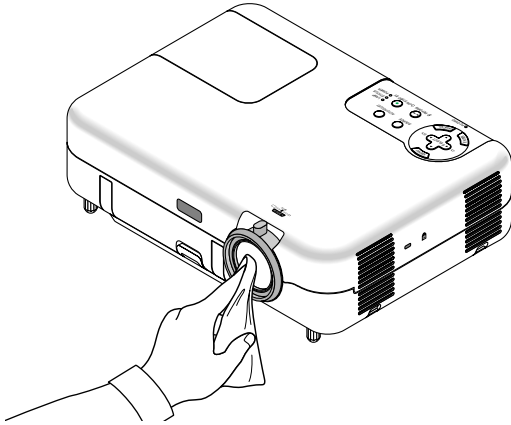

Use a blower or lens paper to clean the lens, and be careful not to scratch the lens.

4 Replacing the Lamp and Filters

After your lamp has been operating for 2000 hours (up to 3000 hours in Eco mode) or longer, the LAMP indicator in the cabinet will blink red and the message will appear. Even though the lamp may still be working, replace it at 2000 (up to 3000 hours in Eco mode) hours to maintain optimal projector performance.

CAUTION

- **DO NOT TOUCH THE LAMP** immediately after it has been used.
It will be extremely hot. Turn the projector off, wait 10 seconds, turn off the main power switch and then disconnect the power cable. Allow at least one hour for the lamp to cool before handling.
- **DO NOT REMOVE ANY SCREWS** except the lamp cover screw and two lamp case screws. You could receive an electric shock.
- The projector will turn off and go into stand by mode after 2100 (up to 3100 hours in Eco mode) hours of service. If this happens, be sure to replace the lamp. If you continue to use the lamp after 2000 hours (up to 3000 hours in Eco mode) of use, the lamp bulb may shatter, and pieces of glass may be scattered in the lamp case. Do not touch them as the pieces of glass may cause injury. If this happens, contact your dealer for lamp replacement.

To replace the lamp:

1. **Loosen the lamp cover screw until the screwdriver goes into a free-wheeling condition and remove the lamp cover. The lamp cover screw is not removable.**

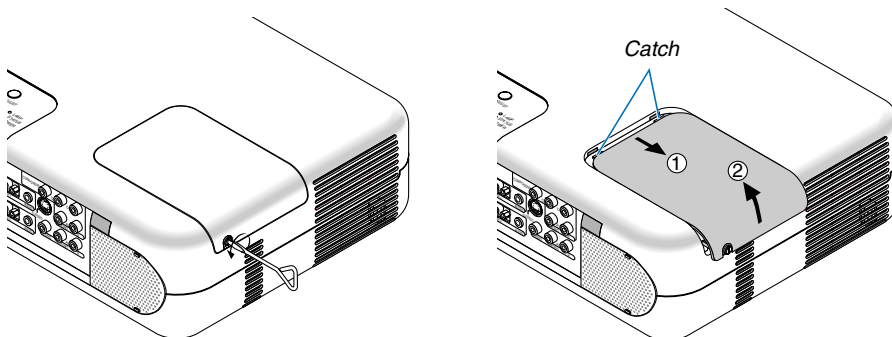

2. **Loosen the two screws securing the lamp housing until the screw-driver goes into a freewheeling condition. The two screws are not removable.**

Remove the lamp housing by pulling out the handle.

NOTE: There is an interlock on this case to prevent the risk of electrical shock. Do not attempt to circumvent this interlock.

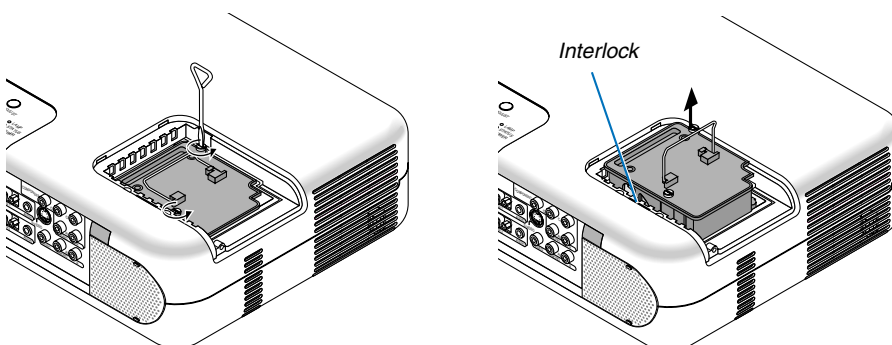

3. Insert a new lamp housing until the lamp housing is plugged into the socket.

CAUTION

Do not use a lamp other than the authorized replacement lamp.
Order this from your dealer.

Secure it in place with the two screws.

Be sure to tighten the screws.

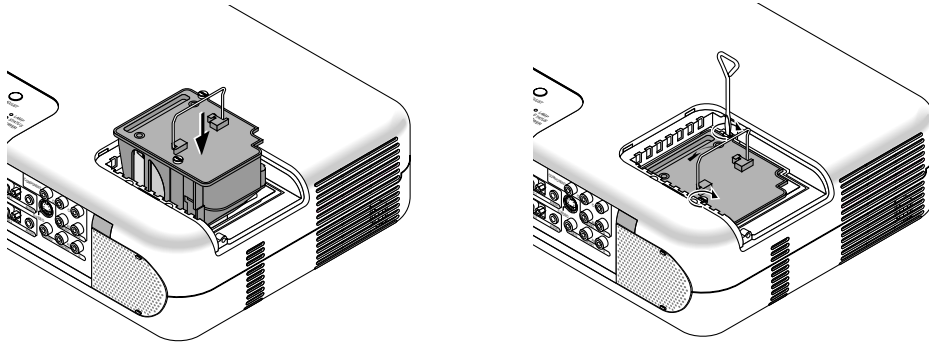

4. Reattach the lamp cover.

Tighten the lamp cover screw.

Be sure to tighten the screw.

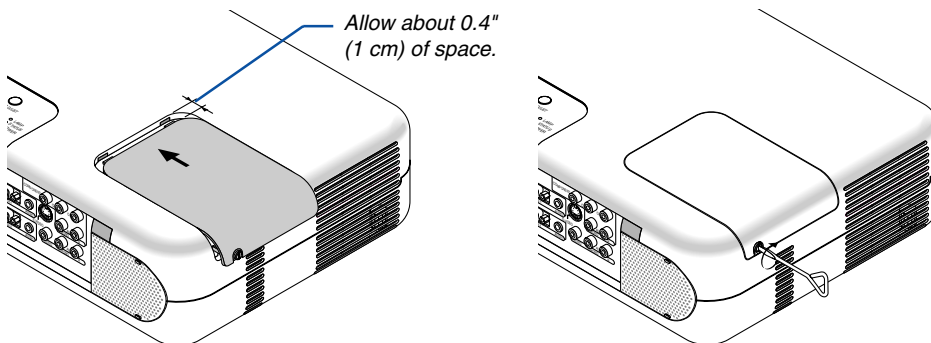

5. After you install a new lamp, select the menu → [Setup] → [Page 5] → [Lamp Hour] → [Clear Lamp Hour Meter], and then press "Clear" to clear the lamp usage hours.

NOTE: When the lamp exceeds 2100 hours (up to 3100 hours in Eco mode) of service, the projector cannot turn on and the menu is not displayed. If this happens, press the Help button on the remote control for a minimum of 10 seconds while in standby mode. When the lamp time clock is reset to zero, the LAMP indicator goes out.

Replacing the Filters

NOTE: Do not wash the filter with soap and water. Soap and water will damage the filter membrane. Before replacing the filter, remove dust and dirt from the projector cabinet. Keep out dust and dirt during filter replacement.

NOTE: When you replace the lamp, it is also wise to replace the filters. The filters come in the same package with your replacement lamp.

CAUTION

- Turn off the projector, turn off the main power switch and unplug the projector before replacing the filters.
- Do not attempt to operate the projector without the two filter covers.

To replace the filters (sponge)

1. Remove the filter by pushing on the catch and pull it.

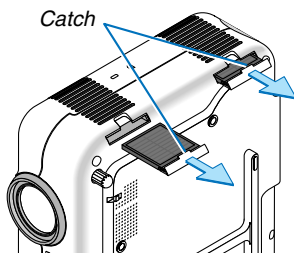

2. Gently peel off the filter (sponge) and replace it with the new one.

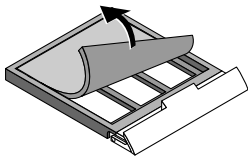

3. Reinstall the new filter cover.

The two filter covers are interchangeable.

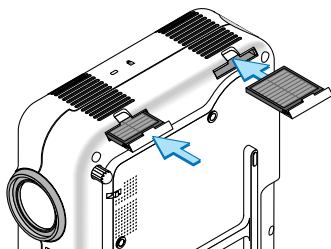

To reset the filter usage time, from the menu, select [Setup] → [Page 5] → [Filter Usage] → [Clear Filter Usage Meter]. See also page 98 for resetting the filter usage time.

9

Appendix

❶ Troubleshooting	111
❷ Specifications	114
❸ Cabinet Dimensions	116
❹ Pin Assignments of D-Sub COMPUTER 1/2 Input Connector	117
❺ Compatible Input Signal List	118
❻ PC Control Codes and Cable Connection	119
❼ Using Software Keyboard	120

1 Troubleshooting

This section helps you resolve problems you may encounter while setting up or using the projector.

Indicator Messages

Power Indicator

Indicator Condition			Projector Condition	Note
Off			The main power is off	–
Blinking light	Green	0.5 sec On, 0.5 sec Off	The projector is getting ready to turn on.	Wait for a moment.
	Orange	0.5 sec On, 0.5 sec Off	The projector is cooling down.	Wait for a moment.
Steady light	Green		The projector is turned on.	–
	Orange		The projector is in Power-saving or Idle.	–

Status Indicator

Indicator Condition			Projector Condition	Note
Off			Normal	–
Blinking light	Red	1 cycle (0.5 sec On, 2.5 sec Off)	Lamp cover error	Replace the lamp cover correctly.
		2 cycle (0.5 sec On, 0.5 sec Off)	Temperature error	The projector is overheated. Move the projector to a cooler location.
		3 cycle (0.5 sec On, 0.5 sec Off)	Power error	Power unit will not work correctly.
		4 cycle (0.5 sec On, 0.5 sec Off)	Fan error	Fans will not work correctly.
		6 cycle (0.5 sec On, 0.5 sec Off)	Lamp error	Lamp fails to light. Wait a full minute and then turn on again.
	Green		Re-firing the lamp	The projector is re-firing.
Steady light	Orange		Cabinet button is locked	You have pressed cabinet button when Cabinet Button is locked.
	Green		Idle condition	–

Lamp Indicator

Indicator Condition			Projector Condition	Note
Off			Normal	–
Blinking light	Red		Lamp has reached its end of life. Lamp replacement message will be displayed.	Replace the lamp.
Steady light	Red		Lamp has been used beyond its limit. The projector will not turn on until the lamp is replaced.	Replace the lamp.
	Green		Lamp mode is set to Eco mode	–

Common Problems & Solutions (See also "Power/Status/Lamp Indicator" on page 111.)

Problem	Check These Items
Does not turn on	<ul style="list-style-type: none"> • Check that the power cable is plugged in and that the power button on the projector cabinet or the remote control is on. See pages 28 and 30. • Ensure that the lamp cover is installed correctly. See page 108. • Check to see if the projector has overheated or the lamp usage exceeds 2100 hours (up to 3100 hours : Eco mode). If there is insufficient ventilation around the projector or if the room where you're presenting is particularly warm, move the projector to a cooler location. • The lamp may fail to light. Wait a full minute and then turn on the power again. • The lamp has reached the end of its usable life. Replace the lamp.
Will turn off	<ul style="list-style-type: none"> • Ensure that the Power Management is off. See page 95.
No picture	<ul style="list-style-type: none"> • Use the SOURCE button on the projector cabinet or the VIDEO, the S-VIDEO, the COMPONENT, the COMPUTER 1/2 or the VIEWER button on the remote control to select your source (Computer 1/2, Component, Video, S-Video or Viewer). See page 32. • Ensure your cables are connected properly. • Use menus to adjust the brightness and contrast. See page 78. • Remove the lens cap. • Reset the settings or adjustments to factory preset levels using the Reset in the Menu. See page 101. • Enter your registered keyword if the Security function is enabled. See page 49. • When using with a notebook PC, be sure to connect between the projector and the notebook PC before turning on the power to the notebook PC. In most cases signal cannot be output from RGB output unless the notebook PC is turned on after connecting with the projector. <ul style="list-style-type: none"> * If the screen goes blank while using your remote control, it may be the result of the computer's screen-saver or power management software. * If you accidentally hit the POWER button on the remote control, wait 60 seconds and then press the POWER button again to resume. • See also the next page.
Picture suddenly becomes dark	<ul style="list-style-type: none"> • When one of the following happens, the Lamp mode automatically changes from Normal to Eco. <ul style="list-style-type: none"> * When there are no signals (blue or black screen) → To return to the Normal mode, select another available source. * When the image is muted using the PIC-MUTE button on the remote control → Press the PIC-MUTE button again to return to the Normal mode. * When the room where you're presenting is particularly warm → Move the projector to a cooler location.
Color tone or hue is unusual	<ul style="list-style-type: none"> • Check if an appropriate color is selected in "Wall Color". If so, select an appropriate option. See page 80. • Adjust "Hue" in "Picture". See page 78.
Image isn't square to the screen	<ul style="list-style-type: none"> • Reposition the projector to improve its angle to the screen. See page 33. • Use the 3DReform function to correct the trapezoid distortion. See page 35.
Picture is blurred	<ul style="list-style-type: none"> • Adjust the focus. See page 34. • Reposition the projector to improve its angle to the screen. See page 33. • Ensure that the distance between the projector and screen is within the adjustment range of the lens. See page 22. • Condensation may form on the lens if the projector is cold, brought into a warm place and is then turned on. Should this happen, let the projector stand until there is no condensation on the lens.
Image is scrolling vertically, horizontally or both	<ul style="list-style-type: none"> • Use the SOURCE button on the projector cabinet or the VIDEO, the S-VIDEO, the COMPONENT, the COMPUTER 1/2 or the VIEWER button on the remote control to select your source (Video, S-Video, Component, Computer or Viewer). See page 32. • Adjust the computer image manually with the Pixel Adjust/Position in the Image. See page 84.
Remote control does not work	<ul style="list-style-type: none"> • Install new batteries. See page 19. • Make sure there are no obstacles between you and the projector. • Stand within 22 feet (7 m) of the projector. See page 19. • Check if one or more remote sensors are enabled. Select [Setup] → [Page 4] → [Remote Sensor] from the menu. See page 97. • Make sure that you are in the Projector mode and the PJ button lights in red. If not, press the PJ button. See page 40.
Indicator is lit or blinking	<ul style="list-style-type: none"> • See the POWER/STATUS/LAMP Indicator on page 111.
Cross color in RGB mode	<ul style="list-style-type: none"> • Press the AUTO ADJUST button on the projector cabinet or the AUTO ADJ. button on the remote control. See page 37. • Adjust the computer image manually with the Pixel Adjust/Position in the Image. See page 84.

For more information contact your dealer.

If there is no picture, or the picture is not displayed correctly.

- Power on process for the projector and the PC.

Be sure to connect the RGB cable between the projector and the computer before turning on the computer. There are some notebook PCs, which do not output signal unless there is a projector or monitor connected first.

NOTE: You can check the horizontal frequency of the current signal in the projector's menu under 'Menu → Help → Information'. If it reads "0kHz", this means there is no signal being output from the computer. See page 100 or go to next step.

- Enabling the computer's external display.

Displaying an image on the notebook PC's screen does not necessarily mean it outputs a signal to the projector. When using a PC compatible laptop, a combination of function keys will enable/disable the external display. Usually, the combination of the 'Fn' key along with one of the 12 function keys gets the external display to come on or off. For example, laptops use Fn + F3, while Dell laptops use Fn + F8 key combinations to toggle through external display selections.

- Non-standard signal output from the computer

If the output signal from a notebook PC is not an industry standard, the projected image may not be displayed correctly. Should this happen, deactivate the notebook PC's LCD screen when the projector display is in use. Each notebook PC has a different way of deactivate/reactivate the local LCD screens as described in the previous step. Refer to your computer's documentation for detailed information.

- Image displayed is incorrect when using a Macintosh

When using a Macintosh with the projector, set the DIPswitch of the Mac adapter (not supplied with the projector) according to your resolution. After setting, restart your Macintosh for the changes to take affect.

For setting display modes other than those supported by your Macintosh and the projector, changing the DIP switch on a Mac adapter may bounce an image slightly or may display nothing. Should this happen, set the DIP switch to the 13" fixed mode and then restart your Macintosh. After that, restore the DIP switches to a displayable mode and then restart the Macintosh again.

NOTE: A Video Adapter cable manufactured by Apple Computer is needed for a PowerBook which does not have a mini D-Sub 15-pin connector.

- Mirroring on a PowerBook

- * When using the projector with a Macintosh PowerBook, output may not be set to 1024 x 768 unless "mirroring" is off on your PowerBook. Refer to owner's manual supplied with your Macintosh computer for mirroring.

- Folders or icons are hidden on the Macintosh screen

Folders or icons may not be seen on the screen. Should this happen, select [View] ->[Arrange] from the Apple menu and arrange icons.

② Specifications

Model Number

8768

Optical

LCD Panel	0.8" p-Si TFT active-matrix with Micro Lens Array
Resolution	1024 × 768 pixels* native, up to UXGA with Advanced AccuBlend
Lens	Manual zoom and focus: F1.7 - 2.0 f=24.0 - 28.8mm
Lamp	200W (152W Eco mode)
Image Size	25 - 300 inches (0.6 - 7.6 m) diagonal
Projection Distance	2.38 - 35.8 ft / 0.7 (Wide) - 11 m (Tele)
Projection Angle	Tele : 9.5° - 9.9° Wide : 11.4° - 12.1°

Electrical

Inputs	2 RGB (D-Sub 15 Pin), 1 Component (RCA × 3 [YCbCr]), 1 S-Video (DIN 4 Pin), 1 Video (RCA), 2 Stereo Mini Audio, 2 (L/R) RCA Audio, 1 PC Control (D-Sub 9 Pin)
Outputs	1 RGB (D-Sub 15 Pin), 1 Stereo Mini Audio
USB Port	1 A Type, 1 B Type
PC Card	1 Slot
Video Compatibility	NTSC, NTSC4.43, PAL, PAL-60, PAL-N, PAL-M, SECAM, HDTV: 1080i, 1080i/50Hz, 720p, 576p, 480p, 480i, 576i/50Hz
Scan Rate	Horizontal: 15 kHz to 100 kHz (RGB: 24 kHz or over) Vertical: 50 Hz to 120 Hz
Video Bandwidth	RGB: 80 MHz (-3dB)
Color Reproduction	16.7 million colors simultaneously, Full color
Horizontal Resolution	NTSC / NTSC4.43/PAL/PAL-M/PAL-N/PAL60: 540 TV lines SECAM: 300 TV lines RGB: 1024 dots (H) × 768 dots (V)
External Control	RS232, IR
Sync Compatibility	Separate Sync / Composite Sync / Sync on G
Built-in Speaker	5W × 2
Power Requirement	100 - 240V AC, 50 / 60 Hz
Input Current	3.2A (100 - 240V AC)
Power Consumption	9W in Idle mode / 6W in Power-saving mode / 280W in Lamp Normal mode / 225W in Lamp Eco mode

Mechanical

Installation Orientation	Desktop/Front, Desktop/Rear, Ceiling/Front, Ceiling/Rear
Dimensions	13.4" (W) × 3.8" (H) × 9.6" (D) 340mm (W) × 97mm (H) × 245mm (D) (not including protrusions)
Net Weight	7.9 lbs / 3.6 kg
Environmental Considerations	Operational Temperatures : 32° to 95°F (0° to 35°C), 20% to 80% humidity (non-condensing) Storage Temperatures : 14° to 122°F (-10° to 50°C), 20% to 80% humidity (non-condensing)
Regulations	UL Approved (UL 60950, CSA 60950) Meets DOC Canada Class B requirements Meets FCC Class B requirements Meets AS/NZS Cispr. 22: Class B Meets EMC Directive (EN55022, EN55024, EN61000-3-2, EN61000-3-3) Meets Low Voltage Directive (EN60950, TUV GS Approved) CE

* Effective pixels are more than 99.99%.

The specifications are subject to change without notice.

3 Cabinet Dimensions

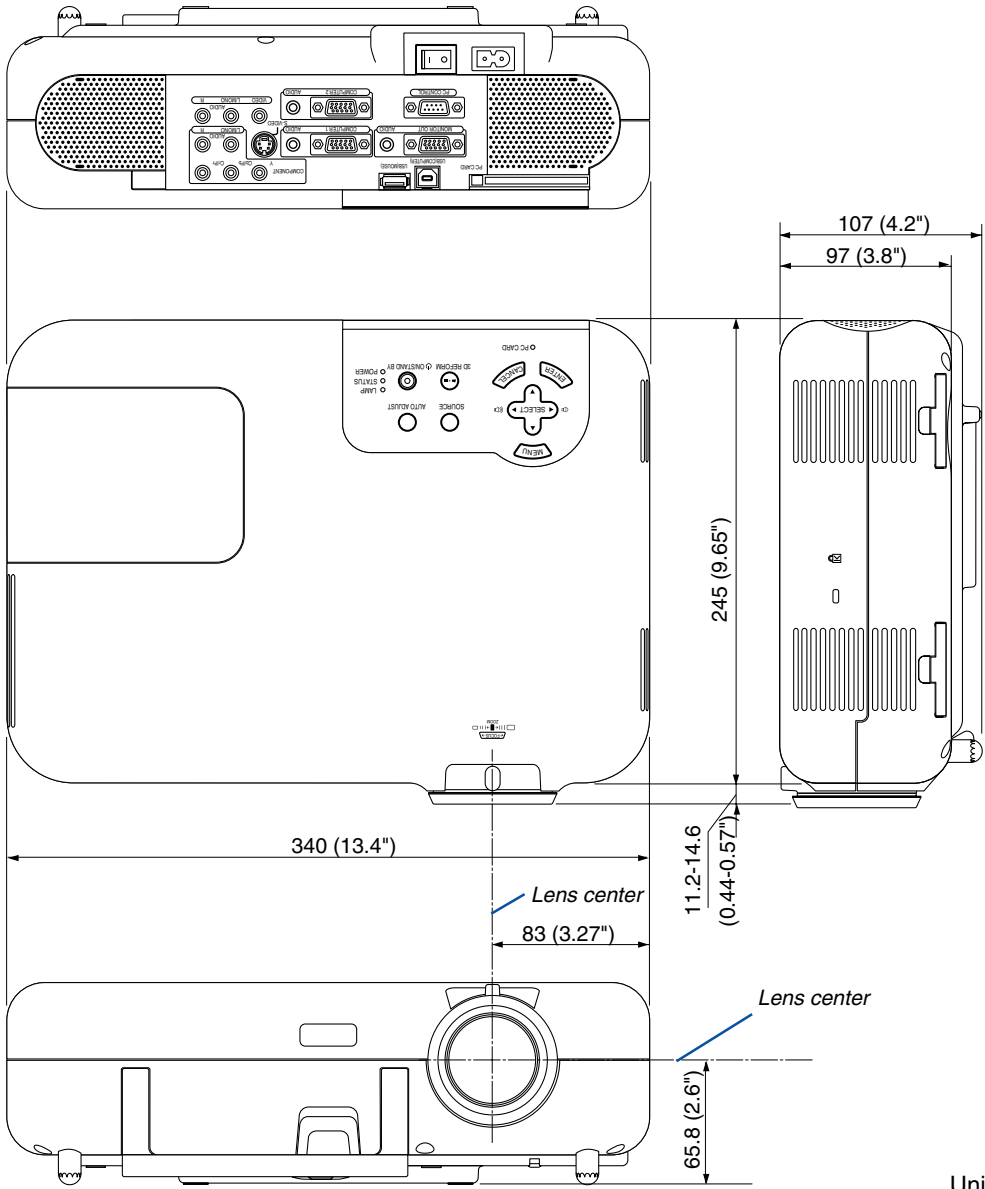

Unit: mm (inch)

④ Pin Assignments of D-Sub COMPUTER 1/2 Input Connector

Mini D-Sub 15 Pin Connector

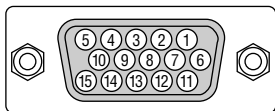

Signal Level

Video signal : 0.7Vp-p (Analog)

Sync signal : TTL level

Pin No.	RGB Signal (Analog)
1	Red
2	Green or Sync on Green
3	Blue
4	Ground
5	Ground
6	Red Ground
7	Green Ground
8	Blue Ground
9	No Connection
10	Sync Signal Ground
11	SCART Sync*1
12	Bi-directional DATA (SDA)*2
13	Horizontal Sync or Composite Sync
14	Vertical Sync
15	Data Clock

*1 COMPUTER 2 input only

*2 COMPUTER 1 input only

5 Compatible Input Signal List

Signal	Resolution (Dots)	Frequency H. (kHz)	Refresh Rate (Hz)
NTSC	–	15.734	60
PAL	–	15.625	50
PAL60	–	15.734	60
SECAM	–	15.625	50
VESA	640 × 480	31.47	59.94
IBM	640 × 480	31.47	60
MAC	640 × 480	31.47	60
MAC	640 × 480	34.97	66.67
MAC	640 × 480	35	66.67
VESA	640 × 480	37.86	72.81
VESA	640 × 480	37.5	75
IBM	640 × 480	39.375	75
VESA	640 × 480	43.269	85.01
IBM	720 × 350	31.469	70.09
VESA	720 × 400	37.927	85.04
IBM	720 × 350	39.44	87.85
IBM	720 × 400	39.44	87.85
VESA	800 × 600	35.16	56.25
VESA	800 × 600	37.879	60.32
VESA	800 × 600	48.077	72.19
VESA	800 × 600	46.88	75
VESA	800 × 600	53.674	85.06
MAC	832 × 624	49.725	74.55
VESA	1024 × 768	35.5	43 Interlaced
VESA	1024 × 768	48.363	60
VESA	1024 × 768	56.476	70.07
MAC	1024 × 768	60.241	74.93
VESA	1024 × 768	60.023	75.03
VESA	1024 × 768	68.677	85
# VESA	1152 × 864	67.5	75
# MAC	1152 × 870	68.681	75.06
# SUN	1152 × 900	61.796	65.95
# SGI	1152 × 900	71.736	76.05
# VESA	1280 × 960	60	60
# VESA	1280 × 1024	63.981	60.02
# MAC	1280 × 1024	69.89	65.18
# HP	1280 × 1024	78.125	72.01
# SUN	1280 × 1024	81.13	76.11
# VESA	1280 × 1024	79.976	75.03
# VESA	1280 × 1024	91.146	85.02
# SXGA+	1400 × 1050	–	–
# HDTV (1080p)	1920 × 1080	67.5	60 Progressive
# SDTV(576i)(625i)	–	15.6	50
# SDTV(576p)(625p)	–	31.5	50
# HDTV (1080i)(1125i)	1920 × 1080	33.75	60 Interlaced
# HDTV (1080i)(1125i)	1920 × 1080	28.125	50 Interlaced
# HDTV (720p)(750p)	1280 × 720	45	60 Progressive
# SDTV (480p)(525p)	–	31.47	59.94 Progressive
# VESA	1600 × 1200	75.0	60
# VESA	1600 × 1200	81.25	65
# VESA	1600 × 1200	87.5	70
# VESA	1600 × 1200	93.75	75
DVD YCbCr	–	15.734	59.94 Interlaced
DVD YCbCr	–	15.625	50 Interlaced

#: Images in above flagged with # are compressed with Advanced AccuBlend.

NOTE: Some composite sync signals may not be displayed correctly.

Signals other than those specified in the table above may not be displayed correctly. If this should happen, change the refresh rate or resolution on your PC. Refer to Display Properties help section of your PC for procedures.

UXGA (1600 × 1200) is supported for separate sync signal only.

6 PC Control Codes and Cable Connection

PC Control Codes

Function	Code Data						
POWER ON	02H	00H	00H	00H	00H	02H	
POWER OFF	02H	01H	00H	00H	00H	03H	
INPUT SELECT COMPUTER 1	02H	03H	00H	00H	02H	01H	09H
INPUT SELECT COMPUTER 2	02H	03H	00H	00H	02H	01H	0AH
INPUT SELECT VIDEO	02H	03H	00H	00H	02H	01H	0EH
INPUT SELECT S-VIDEO	02H	03H	00H	00H	02H	01H	0BH
INPUT COMPONENT	02H	03H	00H	00H	02H	01H	1AH
INPUT SELECT VIEWER	02H	03H	00H	00H	02H	01H	1FH
PICTURE MUTE ON	02H	10H	00H	00H	00H	12H	
PICTURE MUTE OFF	02H	11H	00H	00H	00H	13H	
SOUND MUTE ON	02H	12H	00H	00H	00H	14H	
SOUND MUTE OFF	02H	13H	00H	00H	00H	15H	
ON SCREEN MUTE ON	02H	14H	00H	00H	00H	16H	
ON SCREEN MUTE OFF	02H	15H	00H	00H	00H	17H	

NOTE: Contact your local dealer for a full list of PC Control Codes if needed.

Cable Connection

Communication Protocol

Baud rate 38400 bps
 Data length 8 bits
 Parity No parity
 Stop bit One bit
 X on/off None
 Communications procedure Full duplex

NOTE: Depending on the equipment, a lower baud rate may be recommended for long cable runs.

PC Control Connector (D-SUB 9P)

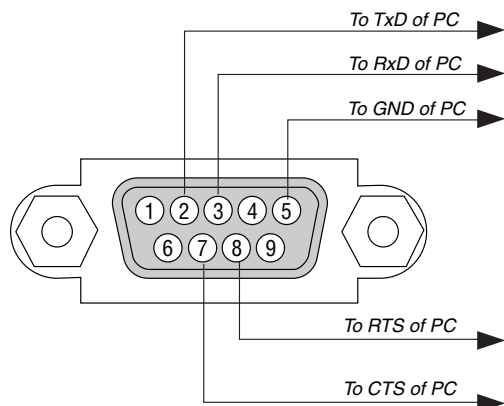

NOTE: Pins 1, 4, 6 and 9 are no used.

NOTE: Jumper "Request to Send" and "Clear to Send" together on both ends of the cable to simplify cable connection.

7 Using Software Keyboard

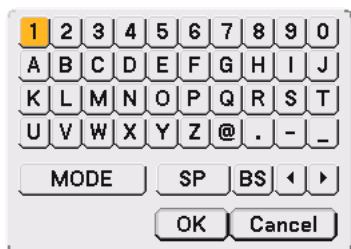

1 to 0 and Characters

..... Use to type in password or keyword.

MODE Selects one of three modes for alphabet and special characters.

SP Inserts a space

BS Deletes one character backward

◀ Returns to the previous

▶ Advances to the next

OK Executes the selection

Cancel Cancels the selection

NOTE: You can drag the Software keyboard on the screen by clicking and holding any part on the keyboard except buttons.

DUKANE CORPORATION

TWO-YEAR LIMITED WARRANTY

This Dukane projector is warranted to the original purchaser for a period of two (2) years from the original purchase date – in normal operating conditions – against defects in material and workmanship. DUKANE CORPORATION EXPRESSLY DISCLAIMS ALL OTHER WARRANTIES OF MERCHANTABILITY AND FITNESS FOR A PARTICULAR PURPOSE.

DURING THE WARRANTY PERIOD, DUKANE CORPORATION'S LIABILITY FOR ANY DEFECTIVE PRODUCT (except for the lamp, which is subject to whatever warranties the manufacturer may provide) IS LIMITED TO THE REPAIR OR REPLACEMENT OF PRODUCT AT DUKANE CORPORATION'S OPTION. REPLACEMENT PRODUCTS MAY BE NEW OR USED (used units will not exceed hours of defective unit). The following are not covered by the limited warranty and Dukane Corporation shall not be liable for:

1. Any product which is not distributed in the U.S.A. or Canada by Dukane Corporation or an authorized dealer.
2. Normal decrease in lamp light output over time.
3. Damage, deterioration or malfunction resulting from:
 - Accident, misuse, abuse, neglect, improper ventilation, fire, dust, smoke, water, lighting or other acts of nature, unauthorized product modification, or failure to follow instructions supplied with the product (including proper maintenance of air filters).
 - Repair or attempted repair by anyone other than a Dukane Corporation authorized service center.
 - Any shipment of product (claims must be presented to the carrier).
 - Removal or installation of the product.
 - Any other causes which do not relate to a product defect.
 - Use of the product beyond normal operating conditions. Normal operating conditions are defined as product use not in excess of 8 hours per day and 260 days per year.
4. Cartons, carry cases, shipping cases, batteries, or any accessories used in connection with the product.
5. Service required as a result of third party components.
6. Product used as commercial rental units

Dukane corporation will pay labor and material expenses for covered items, but Dukane Corporation will not pay for the following:

1. Removal or installation charges.
2. Cost of technical adjustment, set-up, maintenance, or adjustment of user controls.
3. Payment of shipping and related charges incurred in returning the product for warranty repair.

Dukane Corporation disclaims all liability for incidental or consequential damage of any kind, including all damages arising out of any interruptions in operation of the product and all damages to software.

No person, firm, or representative is authorized to assume any obligation or to make any warranty on behalf of the Dukane Corporation other than as stated above.

Audio Visual Products

Dukane Corporation
Audio Visual Products Division
2900 Dukane Drive
St. Charles, IL 60174-3395
E-mail: avsales@dukcorp.com

Phone: (630) 762-4040
Orders: (800) 676-2485
Information: (800) 676-2486
Fax: (630) 584-5156
Parts & Service: (800) 676-2487
Fax: (630) 584-0984

DUKANE

401-8768-00

Free Manuals Download Website

<http://myh66.com>

<http://usermanuals.us>

<http://www.somanuals.com>

<http://www.4manuals.cc>

<http://www.manual-lib.com>

<http://www.404manual.com>

<http://www.luxmanual.com>

<http://aubethermostatmanual.com>

Golf course search by state

<http://golfingnear.com>

Email search by domain

<http://emailbydomain.com>

Auto manuals search

<http://auto.somanuals.com>

TV manuals search

<http://tv.somanuals.com>