

# ***DUKANE***

## **Portable LCD Projector**

### **Model 8943**

### **8918**



## **USER'S MANUAL**

#070030

## Projector

# 8918/8943

## User's Manual – Operating Guide

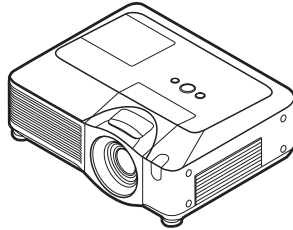

Thank you for purchasing this projector.

**⚠ WARNING** Before using this product, please read the “Safety Guide” section and related sections to ensure the proper use of this product. After reading section, store this in a safe place for future reference.

### About this manual

Various symbols are used in this manual. The meanings of these symbols are described below.

**⚠ WARNING** This symbol indicates information that, if ignored, could possibly result in personal injury or even death due to incorrect handling.

**⚠ CAUTION** This symbol indicates information that, if ignored, could possibly result in personal injury or physical damage due to incorrect handling.

 Please refer to the pages written following this symbol.

**NOTE** • The information in this manual is subject to change without notice.

- The manufacturer assumes no responsibility for any errors that may appear in this manual.
- The reproduction, transfer or copy of all or any part of this document is not permitted without express written consent.

### Trademark acknowledgment

- Mac is registered trademarks of Apple Computer, Inc.
- VESA and SVGA are trademarks of the Video Electronics Standard Association.
- Windows is a registered trademark of Microsoft Corporation.
-  is a trademark of SRS Labs, Inc.
- WOW technology is incorporated under license from SRS Labs, Inc.

All other trademarks are the properties of their respective owners.

Content



<b>About this manual</b> . . . . .	<b>1</b>	(EASY MENU continued)
<b>Content</b> . . . . .	<b>2</b>	LANGUAGE, Go to Advanced Menu...
<b>Projector features</b> . . . . .	<b>3</b>	<b>PICTURE menu</b> . . . . . <b>26</b>
<b>Preparations</b> . . . . .	<b>3</b>	BRIGHTNESS, CONTRAST, GAMMA, COLOR TEMP, COLOR, TINT, SHARPNESS, ACTIVE IRIS, MY MEMORY
Contents of package . . . . .	3	<b>IMAGE menu</b> . . . . . <b>29</b>
Fastening the lens cover . . . . .	3	ASPECT, OVER SCAN, V POSITION, H POSITION, H PHASE, H SIZE, AUTO ADJUST EXECUTE
<b>Part names</b> . . . . .	<b>4</b>	<b>INPUT menu</b> . . . . . <b>31</b>
Projector . . . . .	4	PROGRESSIVE, VIDEO NR, 3D-YCS, COLOR SPACE, COMPONENT, VIDEO FORMAT, M1-D, FRAME LOCK, RGB IN, RESOLUTION
Control panel . . . . .	5	<b>SETUP menu</b> . . . . . <b>35</b>
Rear panel . . . . .	5	AUTO KEYSTONE [∇] EXECUTE, KEYSTONE [∇], KEYSTONE [∇], WHISPER, MIRROR
Remote control . . . . .	6	<b>AUDIO menu</b> . . . . . <b>37</b>
<b>Setting up</b> . . . . .	<b>7</b>	VOLUME, TREBLE, BASS, SRS WOW, SPEAKER, AUDIO
Arrangement . . . . .	8	<b>SCREEN menu</b> . . . . . <b>38</b>
Adjusting the projector's elevator . . . . .	9	LANGUAGE, MENU POSITION, BLANK, START UP, MyScreen, MyScreen Lock, MESSAGE, SOURCE NAME
Using the security bar and slot . . . . .	9	<b>OPTION menu</b> . . . . . <b>42</b>
Connecting your devices . . . . .	10	AUTO SEARCH, AUTO KEYSTONE [∇], AUTO ON, AUTO OFF, LAMP TIME, FILTER TIME, MY BUTTON, SERVICE, SECURITY
Connecting power supply . . . . .	12	<b>NETWORK menu</b> . . . . . <b>53</b>
<b>Remote control</b> . . . . .	<b>13</b>	DHCP, IP ADDRESS, SUBNET MASK, DEFAULT GATEWAY, TIME DIFFERENCE, DATE AND TIME, e-SHOT, INFORMATION, SERVICE
Laser pointer . . . . .	13	<b>Network functions</b> . . . . . <b>55</b>
Putting batteries . . . . .	13	<b>Maintenance</b> . . . . . <b>56</b>
About the remote control signal . . . . .	14	Lamp . . . . . 56
Changing the frequency of remote control signal . . . . .	14	Air filter . . . . . 58
Using as a wired remote control . . . . .	15	Internal clock battery . . . . . 60
Using as a simple PC mouse & keyboard . . . . .	15	Other care . . . . . 61
<b>Power on/off</b> . . . . .	<b>16</b>	<b>Troubleshooting</b> . . . . . <b>62</b>
Turning on the power . . . . .	16	Related messages . . . . . 62
Turning off the power . . . . .	16	Regarding the indicator lamps . . . . . 63
<b>Operating</b> . . . . .	<b>17</b>	Phenomena that may be easy to be mistaken for machine defects . . . . . 65
Adjusting the volume . . . . .	17	<b>Warranty and after-service</b> . . . . . <b>68</b>
Temporarily muting the sound . . . . .	17	<b>Specifications</b> . . . . . <b>68</b>
Selecting an input signal . . . . .	17	<b>Technical Guide</b> . . . . . <b>1-19</b>
Searching an input signal . . . . .	18	<b>Network Functions</b> . . . . . <b>1-38</b>
Selecting an aspect ratio . . . . .	18	<b>Safety Guide</b> . . . . . <b>1-9</b>
Adjusting the zoom and focus . . . . .	19	
Adjusting the lens shift . . . . .	19	
Using the automatic adjustment feature . . . . .	19	
Adjusting the position . . . . .	20	
Correcting the keystone distortions . . . . .	20	
Using the magnify feature . . . . .	21	
Freezing the screen . . . . .	21	
Temporarily blanking the screen . . . . .	22	
Using the menu function . . . . .	23	
<b>EASY MENU</b> . . . . .	<b>24</b>	
ASPECT, AUTO KEYSTONE [∇] EXECUTE, KEYSTONE [∇], KEYSTONE [∇], PICTURE MODE, BRIGHTNESS, CONTRAST, COLOR, TINT, SHARPNESS, WHISPER, MIRROR, RESET, FILTER TIME,		

## Projector features

This projector is used to project various picture signals onto a screen. This projector requires only a minimal amount of space for installation and can produce a large projected image from even a short distance.

## Preparations

### Contents of package

Please see the “Contents of package” in the “User’s Manual (concise)” which is a book. Your projector should come with the items shown there. Contact immediately your dealer if anything is missing.

**NOTE** • Keep the original packing materials for future reshipment. Be sure to use the original packing materials when moving the projector. Use special caution for the lens.

### Fastening the lens cover

To avoid losing the lens cover, please fasten the lens cover to the projector using the included strap.

1. Fix the strap to the strap hole of the lens cover.
2. Put one side of the strap into the groove on the rivet.
3. Push the rivet into the rivet hole.

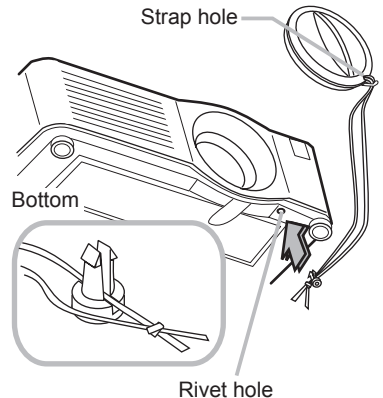

## Part names

## Projector

(1) Speakers (x 4) (📖37).

(2) Focus ring (📖19)

(3) Zoom ring (📖19)

(4) Lamp cover (📖56)

The lamp unit is inside.

(5) Lens shift cover (📖19)

(6) Horizontal lens shift dial (📖19)

(7) Vertical lens shift dial (📖19)

(8) Front cover

(9) Lens (📖61)

(10) Lens cover (📖3)

(11) Remote sensors (x 3) (📖14)

(12) Elevator feet (x 2) (📖9)

(13) Elevator knobs (x 2) (📖9)

(14) Filter cover (📖58)

The air filter and intake vent are inside.

(15) Exhaust vents

(16) Intake vents

(17) Rivet hole (📖3)

(18) Handle

(19) Battery cover (📖60)

(20) Control panel (📖5)

(21) Rear panel (📖5)

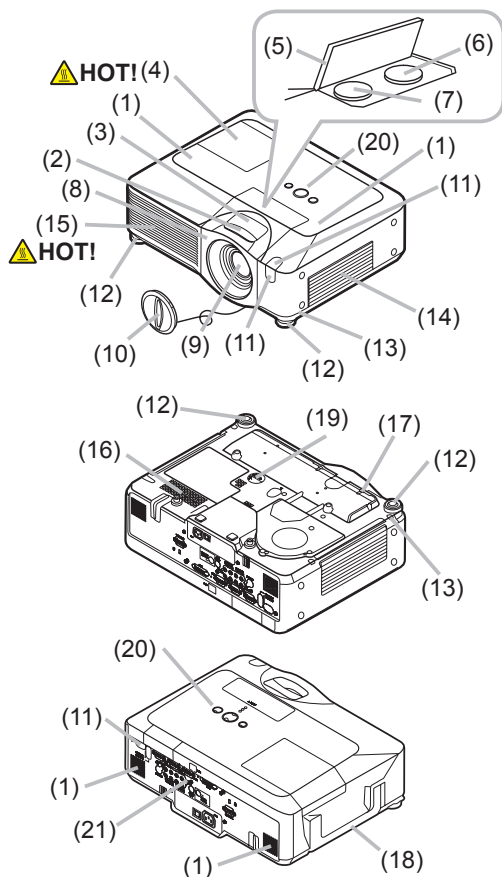

**⚠️WARNING ▶HOT!** : Do not touch around the lamp cover and the exhaust vents during use or just after use, since it is too hot.

▶ Do not look into the lens or vents while the lamp is on, since the strong light is not good for your eyes.

▶ Do not grab the front cover to hold the projector up, since the projector may drop down.

▶ Do not handle the elevator knobs without holding the projector, since the projector may drop down.

**⚠️CAUTION ▶** Maintain normal ventilation to prevent the projector from heating up. Do not cover, block or plug up the vents. Do not place anything that can stick or be sucked to the vents, around the intake vents. Clean the air filter periodically.

## Control panel

- (1) STANDBY/ON button (📖16)
- (2) MENU button (📖23)  
It consists of four cursor buttons.
- (3) INPUT button (📖17)
- (4) POWER indicator (📖16)
- (5) TEMP indicator (📖63)
- (6) LAMP indicator (📖63)

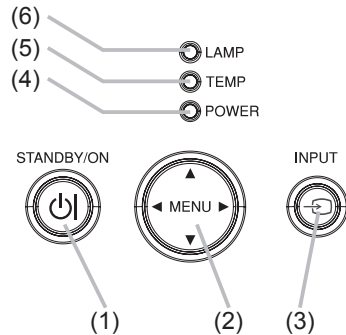

## Rear panel

- (1) Shutdown switch (📖65)
- (2) Security slot (📖9)
- (3) Security bar (📖9)
- (4) AC inlet (📖12)
- (5) Power switch (📖16)
- (6) RGB1 port (📖10)
- (7) RGB2 port (📖10)
- (8) CONTROL port (📖10)
- (9) M1-D port (📖10)
- (10) VIDEO port (📖10)
- (11) S-VIDEO port (📖10)
- (12) COMPONENT (Y, Cb/Pb, Cr/Pr) ports (📖10)
- (13) AUDIO IN1 port (📖10)
- (14) AUDIO IN2 port (📖10)
- (15) AUDIO IN3 (R/L) ports (📖10)
- (16) AUDIO IN4 (R/L) ports (📖10)
- (17) RGB OUT port (📖10)
- (18) AUDIO OUT port (📖10)
- (19) REMOTE CONTROL port (📖10)
- (20) LAN port (📖10)

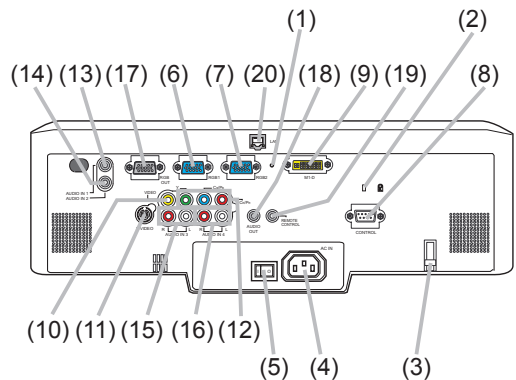

**⚠ CAUTION** ► Do not use the security bar and the security slot to prevent the projector from falling down, since it is not designed for it.

► Use the shutdown switch only when the projector is not turned off by normal procedure, since pushing this switch stops operation of the projector without cooling it down.

## Remote control

- (1) Laser pointer (📖13)  
It is a beam outlet.
- (2) LASER INDICATOR (📖13)
- (3) LASER button (📖13)
- (4) STANDBY/ON button (📖16)
- (5) VOLUME button (📖17)
- (6) MUTE button (📖17)
- (7) VIDEO button (📖18)
- (8) RGB button (📖17)
- (9) SEARCH button (📖18)
- (10) AUTO button (📖19)
- (11) ASPECT button (📖18)
- (12) POSITION button (📖20)
- (13) KEYSTONE button (📖20)
- (14) MAGNIFY - ON button (📖21)
- (15) MAGNIFY - OFF button (📖21)
- (16) FREEZE button (📖21)
- (17) BLANK button (📖22)
- (18) MY BUTTON - 1 button (📖44)
- (19) MY BUTTON - 2 button (📖44)
- (20) MENU button (📖23)
- (21) Lever switch (📖23) : acting 3 functions as below.  
Cursor button ▲ : to slide toward the side marked ▲ .  
Cursor button ▼ : to slide toward the side marked ▼ .  
ENTER button : to push down the center point.
- (22) Cursor button ◀ (📖23)
- (23) Cursor button ▶ (📖23)
- (24) RESET button (📖23)
- (25) ESC button (📖23)
- (26) Mouse left button (📖15)
- (27) Mouse right button (📖15)
- (28) PAGE UP button (📖15)
- (29) PAGE DOWN button (📖15)
- (30) Wired remote control port (📖15)
- (31) Battery cover (📖13)
- (32) Battery holder (📖13)
- (33) Frequency switch (📖14)

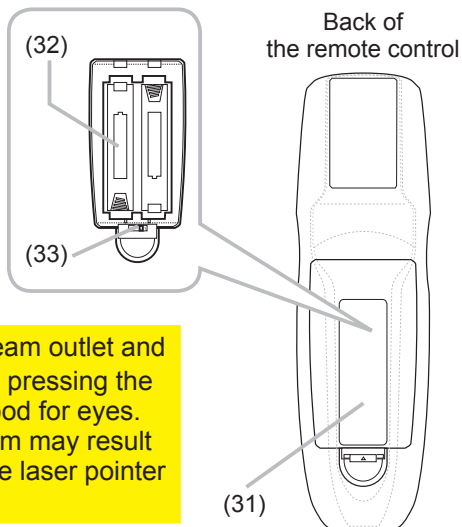
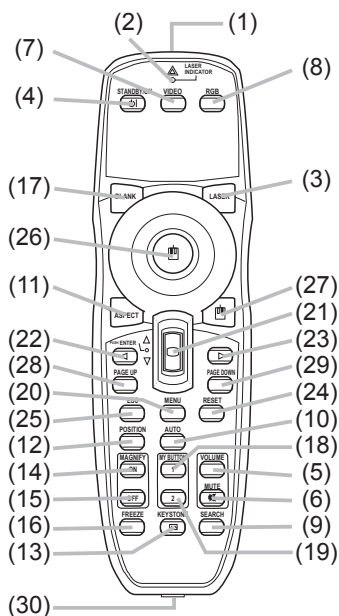

**⚠️WARNING** ► Do not look into the beam outlet and point the beam at people and pets while pressing the LASER button, since the beam is not good for eyes.  
**⚠️CAUTION** ► Note that the laser beam may result in hazardous radiation exposure. Use the laser pointer only for pointing on the screen.

## Setting up

Install the projector according to the environment and manner the projector will be used in.

**⚠ WARNING** ► Place the projector in a stable horizontal position. If the projector falls or is knocked over it could cause injury and/or damage to the projector. Using a damaged projector could then result in fire and/or electric shock.

- Do not place the projector on an unstable, slanted or vibrational surface such as a wobbly or inclined stand.
- Do not place the projector on its side, front or rear position.
- Consult with your dealer before a special installation such as suspending from a ceiling.

► Place the projector in a cool place, and ensure that there is sufficient ventilation. The high temperature of the projector could cause fire, burns and/or malfunction of the projector.

- Do not stop-up, block or otherwise cover the projector's vents.
- Keep a space of 30 cm or more between the sides of the projector and other objects such as walls.
- Do not place the projector on metallic thing or anything weak in heat.
- Do not place the projector on carpet, cushions or bedding.
- Do not place the projector in direct sunlight or near hot objects such as heaters.
- Do not place anything near the projector lens or vents, or on top of the projector.
- Do not place anything that may be sucked into or stick to the vents on the bottom of the projector. This projector has some intake vents also on the bottom.
- Do not place the projector anyplace where it may get wet. Getting the projector wet or inserting liquid into the projector could cause fire, electric shock and/or malfunction of the projector.
- Do not place the projector in a bathroom or the outdoors.
- Do not place anything containing liquid near the projector.

**⚠ CAUTION** ► Avoid placing the projector in smoky, humid or dusty place. Placing the projector in such places could cause fire, electric shock and/or malfunction of the projector.

- Do not place the projector near humidifiers, smoking spaces or a kitchen.
- Position the projector to prevent light from directly hitting the projector's remote sensor.



## Arrangement

Refer to the illustrations and tables below to determine screen size and projection distance.

The values shown in the table are calculated for a full size screen: 1024×768

(a) Screen size (diagonal)

(b) Projection distance (±10%)

(c) Screen height (±10%), when the vertical lens shift is set full upward (📖19)

### On a horizontal surface

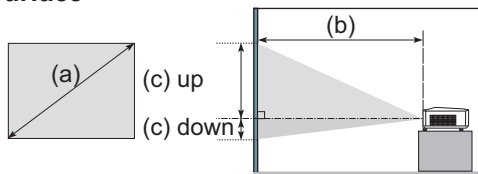

### Suspended from the ceiling

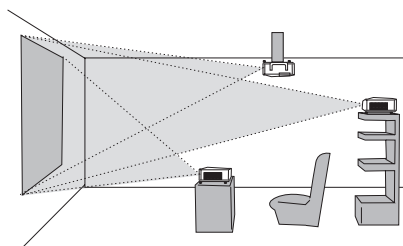
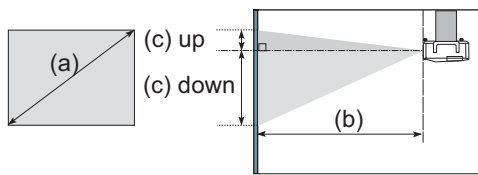

- Keep a space of 30 cm or more between the sides of the projector and other objects such as walls.
- Consult with your dealer before a special installation such as suspending from a ceiling.

(a) Screen size [inch (m)]	4 : 3 screen				16 : 9 screen			
	(b) Projection distance [m (inch)]		(c) Screen height [cm (inch)]		(b) Projection distance [m (inch)]		(c) Screen height [cm (inch)]	
	min.	max.	down	up	min.	max.	down	up
30 (0.8)	0.9 (35)	1.1 (42)	5 (2)	41 (16)	1.0 (38)	1.2 (46)	-1 (0)	39 (15)
40 (1.0)	1.2 (47)	1.4 (57)	6 (2)	55 (22)	1.3 (51)	1.6 (62)	-2 (-1)	51 (20)
60 (1.5)	1.8 (71)	2.2 (86)	9 (4)	82 (32)	2.0 (78)	2.4 (94)	-2 (-1)	77 (30)
70 (1.8)	2.1 (83)	2.6 (100)	11 (4)	96 (38)	2.3 (91)	2.8 (110)	-3 (-1)	90 (35)
80 (2.0)	2.4 (96)	2.9 (115)	12 (5)	110 (43)	2.6 (104)	3.2 (126)	-3 (-1)	103 (41)
90 (2.3)	2.7 (108)	3.3 (130)	14 (5)	123 (49)	3.0 (117)	3.6 (141)	-4 (-1)	116 (46)
100 (2.5)	3.0 (120)	3.7 (144)	15 (6)	137 (54)	3.3 (131)	4.0 (157)	-4 (-2)	129 (51)
120 (3.0)	3.7 (144)	4.4 (174)	18 (7)	165 (65)	4.0 (157)	4.8 (189)	-5 (-2)	154 (61)
150 (3.8)	4.6 (181)	5.5 (217)	23 (9)	206 (81)	5.0 (197)	6.0 (237)	-6 (-2)	193 (76)
200 (5.1)	6.1 (241)	7.4 (291)	30 (12)	274 (108)	6.7 (263)	8.0 (317)	-8 (-3)	257 (101)
250 (6.4)	7.7 (302)	9.2 (364)	38 (15)	343 (135)	8.4 (329)	10.1 (396)	-10 (-4)	322 (127)
300 (7.6)	9.2 (363)	11.1 (437)	46 (18)	411 (162)	10.0 (395)	12.1 (476)	-12 (-5)	386 (152)
350 (8.9)	10.8 (424)	13.0 (510)	53 (21)	480 (189)	11.7 (462)	14.1 (556)	-15 (-6)	450 (177)

## Adjusting the projector's elevator

When the place to put the projector is slightly uneven to the left or right, use the elevator feet to place the projector horizontally.

Using the feet can also tilt the projector in order to project at a suitable angle to the screen, elevating the front side of the projector within 8 degrees.

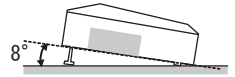

This projector has 2 elevator feet and 2 elevator knobs. An elevator foot is adjustable while pulling up the elevator knob on the same side as it.

1. Holding the projector, pull the elevator knobs up to loose the elevator feet.
2. Position the front side of the projector to the desired height.
3. Release the elevator knobs in order to lock the elevator feet.
4. After making sure that the elevator feet are locked, put the projector gently.
5. If necessary, the elevator feet can be manually twisted to make more precise adjustments. Hold the projector when twisting the feet.

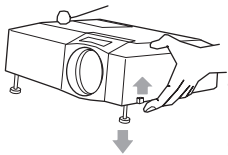

To loose an elevator foot, pull up the elevator knob on the same side as it.

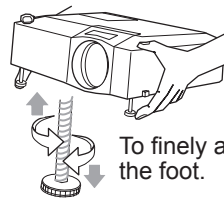

To finely adjust, twist the foot.

**⚠ CAUTION** ► Do not handle the elevator knobs without holding the projector, since the projector may drop down.

► Do not tilt the projector other than it elevating its front within 8 degrees using the adjuster feet. A tilt of the projector exceeding the restriction could cause malfunction or shortening the lifetime of consumables, or the projector itself.

## Using the security bar and slot

A commercial anti-theft chain or wire up to 10 mm in diameter can be attached to the security bar on the projector.

Also this product has the security slot for the Kensington lock.

For details, see the manual of the security tool.

**⚠ WARNING** ► Do not use the security bar and the security slot to prevent the projector from falling down, since it is not designed for it.

**NOTE** • The security bar and the security slot are not comprehensive theft prevention measures. They are intended to be used as supplemental theft prevention measure.

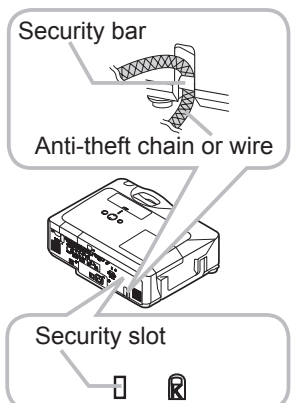

## Connecting your devices

Be sure to read the manuals for devices before connecting them to the projector. Make sure that all the devices are suitable to be connected with this product, and prepare the cables required to connect.

Please refer to the following illustrations to connect them.

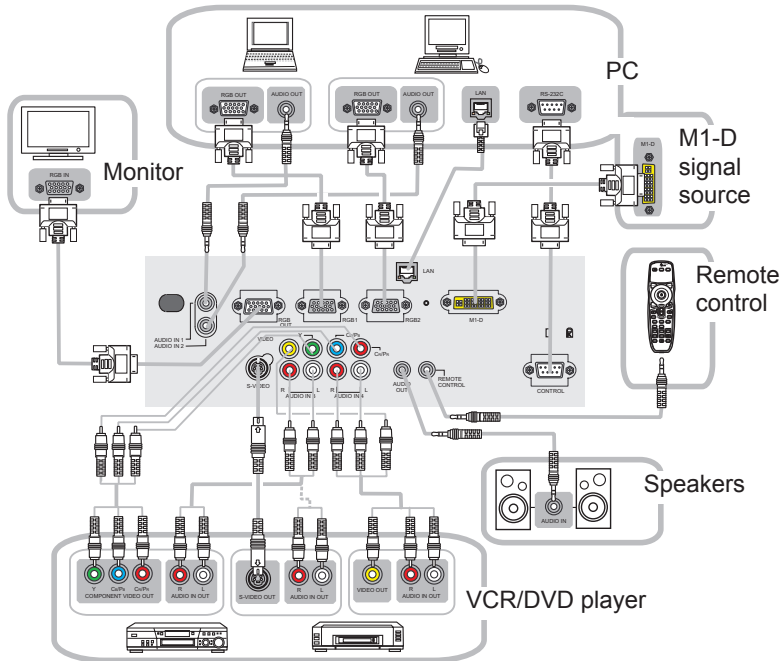

- ⚠ **WARNING** ▶ Do not disassemble or modify the projector.
- ▶ Be careful not to damage the cables, and do not use damaged cables.
- ⚠ **CAUTION** ▶ Turn off all devices and unplug their power cords prior to connecting them to projector. Connecting a live device to the projector may generate extremely loud noises or other abnormalities that may result in malfunction or damage to the device and the projector.
- ▶ Use appropriate accessory or otherwise designed cables. Ask your dealer about non-accessory cables which may have to be of a specific length or equipped with a core. For cables with a core only at one end, connect the end with the core to the projector.
- ▶ Make sure that devices are connected to the correct ports. An incorrect connection may result in malfunction or damage to the device and the projector.

## Connecting your devices (continued)

**NOTE** • Be sure to read the manuals for devices before connecting them to the projector, and make sure that all the devices are suitable to be connected with this product. Before connecting to a PC, check the signal level, the signal timing, and the resolution.

- Do not connect LAN port to any network that might have the excessive voltage.
- Some signal may need an adapter to input this projector.
- Some PCs have multiple screen display modes that may include some signals which are not supported by this projector.
- Although the projector can display signals with resolution up to UXGA (1600X1200), the signal will be converted to the projector's panel resolution before being displayed. The best display performance will be achieved if the resolutions of the input signal and the projector panel are identical.
- While connecting, make sure that the shape of the cable's connector fits the port to connect with. And be sure to tighten the screws on connectors with screws.
- When connecting a laptop PC to the projector, be sure to activate the PC's external RGB output. (Set the laptop PC to CRT display or to simultaneous LCD and CRT display.) For details on how this is done, please refer to the instruction manual of the corresponding laptop PC.
- When the picture resolution is changed on a computer depending on an input, automatic adjustment function may take some time and may not be completed. In this case, you may not be able to see a check box to select "Yes/No" for the new resolution on Windows. Then the resolution will go back to the original. It might be recommended to use other CRT or LCD monitors to change the resolution.
- In some cases, this projector may not display a proper picture or display any picture on screen. For example, automatic adjustment may not function correctly with some input signals. An input signal of composite sync or sync on G may confuse this projector, so the projector may not display a proper picture.
- The M1-D port of this model is compatible with HDCP (High-bandwidth Digital Content Protection) and therefore capable of displaying a video signal from HDCP compatible DVD players or the like.

### **About Plug-and-Play capability**

Plug-and-Play is a system composed of a computer, its operating system and peripheral equipment (i.e. display devices). This projector is VESA DDC 2B compatible. Plug-and-Play can be used by connecting this projector to a computer that is VESA DDC (display data channel) compatible.

- Take advantage of this feature by connecting an RGB cable to the RGB1 port (DDC 2B compatible). Plug-and-Play may not work properly if any other type of connection is attempted.
- Please use the standard drivers in your computer as this projector is a Plug-and-Play monitor.

## Connecting power supply

1. Connect the connector of the power cord to the AC inlet of the projector.
2. Firmly plug the power cord's plug into the outlet.

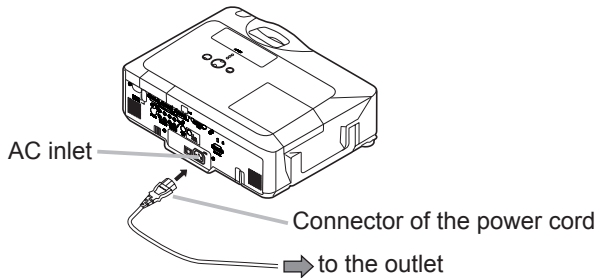

- ⚠ WARNING ►** Please use extra caution when connecting the power cord, as incorrect or faulty connections may result in fire and/or electrical shock.
- Only use the power cord that came with the projector. If it is damaged, contact your dealer to newly get correct one.
  - Only plug the power cord into an outlet rated for use with the power cord's specified voltage range.
  - Never modify the power cord.

## Remote control

## Laser pointer

This remote control has a laser pointer in place of a finger or rod. The laser beam works and the LASER INDICATOR lights while the LASER button is pressed.

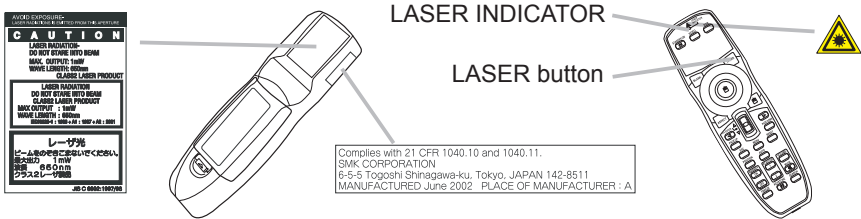

**⚠ WARNING** ▶ The laser pointer of the remote control is used in place of a finger or rod. Never look directly into the laser beam outlet or point the laser beam at other people. The laser beam can cause vision problems.

**⚠ CAUTION** ▶ Use of controls or adjustments or performance of procedures other than those specified herein may result in hazardous radiation exposure.

## Putting batteries

Please load the batteries before using the remote control. If the remote control starts to malfunction, replace the batteries. If you will not use the remote control for an extended period, remove the batteries from the remote control and store them in a safe place.

- Slide back and remove the battery cover in the direction of the arrow.
- Align and insert the two AA batteries according to their plus and minus terminals as indicated in the remote control.
- Replace the battery cover in the direction of the arrow and snap it back into place.

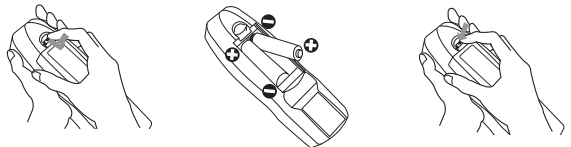

**⚠ WARNING** ▶ Always handle the batteries with care and use them only as directed. Improper use may result in battery explosion, cracking or leakage, which could result in fire, injury and/or pollution of the surrounding environment.

- Be sure to use only the batteries specified. Do not use batteries of different types at the same time. Do not mix a new battery with used one.
- Make sure the plus and minus terminals are correctly aligned when loading a battery.
- Keep a battery away from children and pets.
- Do not recharge, short circuit, solder or disassemble a battery.
- Do not allow a battery in a fire or water. Keep batteries in a dark, cool and dry place.
- If you observe a leakage of a battery, wipe out the flower and then replace a battery. If the flower adheres your body or clothes, rinse well with water immediately.

## About the remote control signal

The remote control works with the projector's remote sensors. This projector has three remote sensors on the front, on the top, and on the back.

The sensors can be respectively turned active or inactive using the "REMOTE RECEIV" in the SERVICE item of OPTION menu (46). Each sensor senses the signal within the following range when the sensor is active.

### The front and top sensors:

60 degrees (30 degrees to the left and right of the sensor) within 3 meters about.

### The back sensor:

40 degrees (20 degrees to the left and right of the sensor) within 3 meters about.

**NOTE** • The remote control signal reflected in the screen or the like may be available. If it is difficult to send the signal to the sensor directly, attempt to make the signal reflect.

- The remote control uses infrared light to send signals to the projector (Class 1 LED), so be sure to use the remote control in an area free from obstacles that could block the remote control's signal to the projector.
- The remote control may not work correctly if strong light (such as direct sun light) or light from an extremely close range (such as from an inverter fluorescent lamp) shines on the remote sensor of the projector. Adjust the position of projector avoiding those lights.

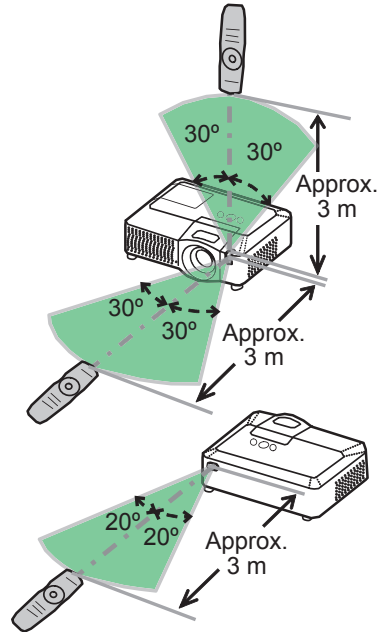

## Changing the frequency of remote control signal

The accessory remote control has the choice of the mode 1 or the mode 2, in the frequency of its signal. If the remote control does not function properly, attempt to change the signal frequency.

Please remember that the "REMOTE FREQ." in SERVICE item of OPTION menu (46) of the projector to be controlled should be set to the same mode as the remote control.

To set the mode of the remote control, slide the knob of the frequency switch inside the battery cover into the position indicated by the mode number to choose.

Back of the remote control

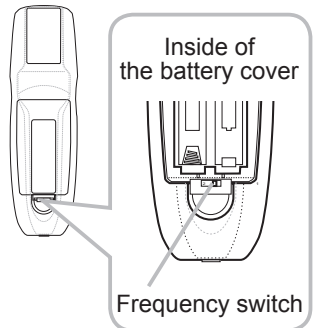

## Using as a wired remote control

The accessory remote control works as a wired remote control, when the wired control port at the bottom of the remote control connects with the REMOTE CONTROL port on the back of the projector via an audio cable with 3.5 diameter stereo mini plugs.

When the remote control signal is hard to reach surely to the projector in the environment, this function is effective.

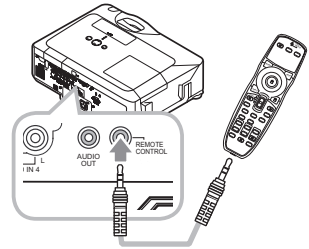

**NOTE** • To connect the remote control with the projector, use an audio cable with 3.5 diameter stereo mini plugs.

## Using as a simple PC mouse & keyboard

The accessory remote control works as a simple mouse and keyboard of the PC, when an M1-D/USB cable connects this projector's M1-D port with the PC's DVI-D and USB (A type) ports.

### (1) Mouse left button

Pushing the button into the center point works instead of clicking the mouse's left button.

Tilting this button to one of eight directions moves the PC's move pointer on the screen in the direction.

### (2) Mouse right button

Pressing the button works instead of clicking the mouse's right button.

### (3) Lever switch

Sliding toward the side marked ▲ works instead of the [↑] key on the keyboard. Sliding toward the side marked ▼ works instead of the [↓] key on the keyboard.

### (4) Cursor button ◀

This button works instead of the [←] key on the keyboard.

### (5) Cursor button ▶

This button works instead of the [→] key on the keyboard.

### (6) PAGE UP button

This button works instead of the PAGE UP key on the key board.

### (7) PAGE DOWN button

This button works instead of the PAGE DOWN key on the key board.

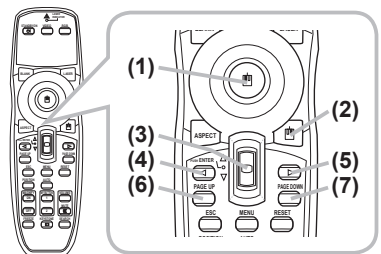
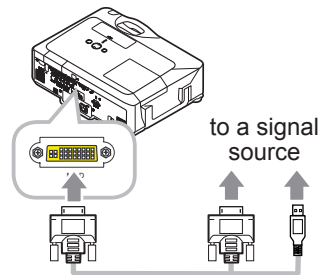

**NOTE** • When the simple mouse & keyboard function of this product does not work correctly, please check the following.

- When an M1-D/USB cable connects this projector with a PC having a built-in pointing device (e.g. track ball) like a notebook PC, open BIOS setup menu, then select the external mouse and disable the built-in pointing device, because the built-in pointing device may have priority to this function.
- Windows 95 OSR 2.1 or higher is required for this function. And also this function may not work depending on the PC's configurations and mouse drivers.
- Operating simultaneously two or more keys is void except for mouse drag and drop operation.
- This function is activated only when the projector is working properly.



## Power on/off

**Turning on the power**

1. Make sure that the power cord is firmly and correctly connected to the projector and the outlet.
2. Remove the lens cover, and set the power switch to the ON position.

The power indicator will light up in steady orange (  63). Then wait several seconds because the buttons may not function for these several seconds.

(1) When **AUTO ON** in **OPTION** menu is set to **TURN ON** (  42) :

The lamp will only be automatically turned on when the Power switch is turned on after the power was turned off by Power switch last time. Afterwards the **POWER** indicator will begin blinking in green. When the power is completely on, the indicator will stop blinking and light in green.

(2) When **AUTO ON** in the **OPTION** menu is set to **TURN OFF** (  42): Please see step 3.

3. Press the **STANDBY/ON** button on the projector or the remote control.

To display the picture, select an input signal according to the section "Selecting an input signal" (  18).

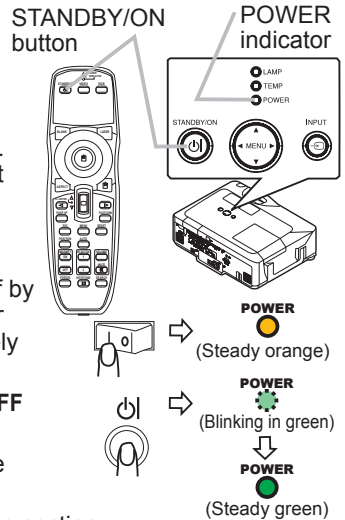
**Turning off the power**

1. Press the **STANDBY/ON** button on the projector or the remote control.  
The message "Power off?" will appear on the screen for about 5 seconds.
2. Press the **STANDBY/ON** button on the projector or the remote control again while the message appears.  
The projector lamp will go off, and the **POWER** indicator will begin blinking in orange.  
Then the **POWER** indicator will stop blinking and light in steady orange when the lamp cooling is complete.
3. Make sure that the power indicator lights in steady orange, and set the power switch to the OFF position. The **POWER** indicator will go off. Attach the lens cover.

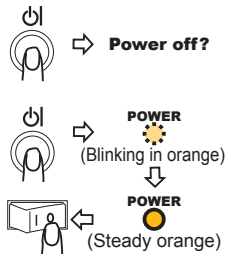

Do not turn the projector on for 10 minutes or more after turning it off. Turning the projector on again too soon could shorten the lifetime of some consumable parts of the projector.

**⚠ WARNING** ▶ A strong light is emitted when the projector's power is on. Do not look into the lens of the projector or look inside of the projector through any of the projector's openings.  
▶ Do not touch around the lamp cover and the exhaust vents during use or just after use, since it is too hot.

**NOTE** • Turn the power on/off in right order. Please power on the projector prior to the connected devices. Power off the projector later than the connected devices.  
• Use the shutdown switch (  65) only when the projector is not turned off by normal procedure.

Operating

### Adjusting the volume

1. Press the VOLUME button on the remote control.  
A dialog will appear on the screen to aid you in adjusting the volume.
2. Use the cursor buttons ▲/▼ to adjust the volume.  
To close the dialog and complete the operation, press the VOLUME button again. Even if you do not do anything, the dialog will automatically disappear after a few seconds.

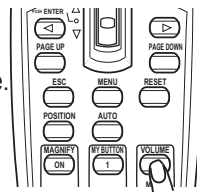

- When no audio port is selected for current picture input port, the volume adjustment is disable. Please see the AUDIO item of AUDIO menu. (37)

### Temporarily muting the sound

1. Press the MUTE button on the remote control.  
A dialog will appear on the screen indicating that you have muted the sound.  
To restore the sound, press the MUTE or VOLUME button.  
Even if you do not do anything, the dialog will automatically disappear after a few seconds.

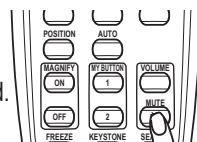

- As long as no audio input is selected for current picture input port, the sound is always muted. Please see the AUDIO item of AUDIO menu. (37)

### Selecting an input signal

1. Press the INPUT button on the projector.  
Each time you press the button, the projector switches its input port as below.

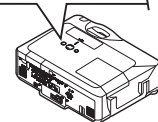
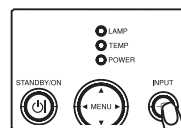

1. Press the RGB button on the remote control to select an input port for the RGB signal.  
Each time you press the button, the projector switches its RGB input port as below.

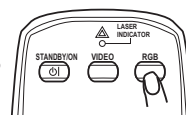

- If the RGB button is pushed (when switching from VIDEO to RGB signals) when TURN ON is selected for the AUTO SEARCH item in the OPTION menu the projector will check the RGB 1 port first. If no input is detected at the port, the projector will check other port in above order.

### Selecting an input signal (continued)

1. Press the VIDEO button on the remote control to select an input for video signal.

Each time you press the button, the projector switches its video input port as below.

COMPONENT (Y, C<sub>B</sub>/R<sub>B</sub>, C<sub>R</sub>/B<sub>R</sub>) → S-VIDEO → VIDEO

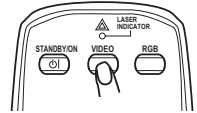

- If the VIDEO button is pushed (when switching from RGB to VIDEO signals) when TURN ON is selected for the AUTO SEARCH item in the OPTION menu the projector will check the COMPONENT (Y, C<sub>B</sub>/R<sub>B</sub>, C<sub>R</sub>/B<sub>R</sub>) port first. If no input is detected at the port, the projector will check other ports in above order.

### Searching an input signal

1. Press the SEARCH button on the remote control.  
The projector will start to check its input ports in order to find any input signals.

When an input is found, the projector will stop searching and display the image. If no signal is found, the projector will return to the state selected before the operation.

RGB 1 → RGB 2 → M1-D → COMPONENT (Y, C<sub>B</sub>/R<sub>B</sub>, C<sub>R</sub>/B<sub>R</sub>) → S-VIDEO → VIDEO



### Selecting an aspect ratio

1. Press the ASPECT button on the remote control.  
Each time you press the button, the projector switches the mode for aspect ratio in turn.

- For an RGB signal

NORMAL → 4:3 → 16:9 → SMALL



- For an M1-D signal

NORMAL → 4:3 → 16:9 → 14:9 → SMALL



- For a video signal, s-video signal or component video signal

4:3 → 16:9 → 14:9 → SMALL



- For no signal

4:3 (fixed)

- The NORMAL mode keeps the original aspect ratio of the signal.
- Performing the automatic adjustment initializes the aspect ratio setting.

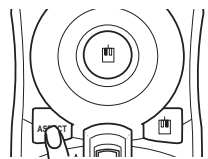

## Adjusting the zoom and focus

1. Use the zoom ring to adjust the screen size.
2. Use the focus ring to focus the picture.

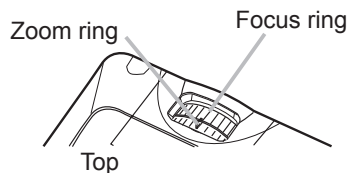

## Adjusting the lens shift

1. Use the vertical lens shift dial to shift the picture upward or downward.
2. Use the horizontal lens shift dial to shift the picture left or right.

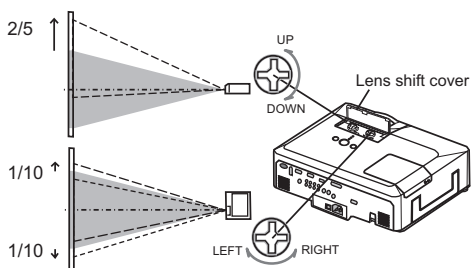

**NOTE** • When the vertical lens shift is adjusted, it is recommended to shift the picture upward.

## Using the automatic adjustment feature

1. Press the AUTO button on the remote control.

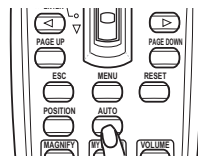

### ○ For an RGB signal

The vertical position, the horizontal position, the horizontal phase and the horizontal size will be automatically adjusted.

And the aspect ratio will be automatically set to default. Make sure that the application window is set to its maximum size prior to attempting to use this feature. A dark picture may still be incorrectly adjusted. Use a bright picture when adjusting.

### ○ For an M1-D signal

The aspect ratio will be automatically set to default.

### ○ For a video signal or s-video signal

The video format best suited for the respective input signal will be selected automatically.

This function is available only when the AUTO is selected to the VIDEO FORMAT item in INPUT menu (p.32). For a component video signal, the signal type is identified automatically independently of this function.

### ○ For a video signal, s-video signal or component video signal

The vertical position, horizontal position and aspect ratio will be automatically set to default.

### ○ For a component video signal

The horizontal phase will be automatically set to default.

- The automatic adjustment operation requires about 10 seconds. Also please note that it may not function correctly with some input.

## Adjusting the position

1. Press the POSITION button on the remote control.  
The "POSITION" indication will appear on the screen.
2. Use the cursor buttons ▲/▼/◀/▶ to adjust the picture position.

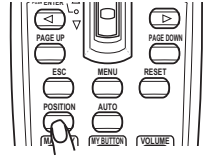

When you want to reset the operation, press the RESET button on the remote control during the operation.

To complete this operation, press the POSITION button again. Even if you do not do anything, the dialog will automatically disappear after a few seconds.

- When this function is performed on a video signal, s-video signal or component video signal, some image such as an extra-line may appear at outside of the picture.
- When this function is performed on a video signal, s-video signal, or component video signal of 525i (480i) or 625i (576i), the range of this adjustment depends on the OVER SCAN in IMAGE menu (□29) setting. It is not possible to adjust when the OVER SCAN is set to 10.

## Correcting the keystone distortions

1. Press the KEYSTONE button on the remote control. A dialog will appear on the screen to aid you in correcting the distortion.
2. Use the cursor buttons ▲/▼ to select AUTO or MANUAL operation, and press the button ▶ to perform the following.

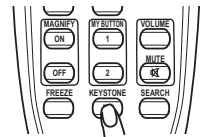
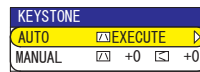

- 1) AUTO executes automatic vertical keystone correction.
- 2) Manual displays a dialog for keystone correction.  
Use the cursor buttons ◀/▶ to select the direction to correct (◻ or ◻) then use the buttons ▲/▼ for adjustment.

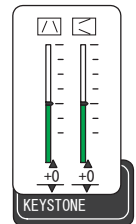

To close the dialog and complete this operation, press the KEYSTONE button again. Even if you don't do anything, the dialog will automatically disappear after a few seconds.

- The adjustable range of this function will vary among inputs. For some input, this function may not work well.
- When V:INVERT or H&V:INVERT is selected to the MIRROR item in the SETUP menu, if the projector screen is inclined or angled downward, this function may not work correctly.
- When the zoom adjustment is set to the TELE (telephoto focus), this function may be excessive. This function should be used when the zoom adjustment is set to the full WIDE (wide-angle focus) whenever possible.
- When the projector is placed on the level (about  $\pm 3^\circ$ ), this function may not work.
- When the projector is inclined to near  $\pm 30$  degree or over, this function may not work well.
- When the vertical lens shift is not set fully upward (not set fully downward for the optional lens type FL-601 only (□45)), this function may not work well.
- When the horizontal lens shift is not set to the center, this function may not work well.
- This function will be unavailable when Transition Detector is on (□51).

## Using the magnify feature

1. Press the ON button of MAGNIFY on the remote control.
  - The “MAGNIFY” indication will appear on the screen (although the indication will disappear in several seconds with no operation), and the projector will go into the MAGNIFY mode.

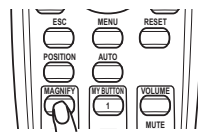

2. Use the cursor buttons ▲/▼ to adjust the zoom level.
  - To move the zoom area, press the POSITION button in the MAGNIFY mode, then use the cursor buttons ▲/▼/◀/▶ to move the area. And to finalize the zoom area, press the POSITION button again.

To exit from the MAGNIFY mode and restore the screen to normal, press the OFF button of MAGNIFY on the remote control.

- The projector automatically exits from the MAGNIFY mode when the input signal is changed, or when the display condition is changed.
- Although in the MAGNIFY mode, the keystone distortion condition may vary, it will be restored when the projector exits from the MAGNIFY mode.

**NOTE** • The zoom level can be finely adjusted. Closely watch the screen to find the level you want.

## Freezing the screen

1. Press the FREEZE button on the remote control.
  - The “FREEZE” indication will appear on the screen (although the indication will not appear when the TURN ON is selected to the MESSAGE item of SCREEN menu (41)), and the projector will go into the FREEZE mode.

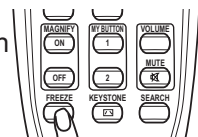

To exit the FREEZE mode and restore the screen to normal, press the FREEZE button again.

- The projector automatically exits from the FREEZE mode when the input signal changes, or when one of the projector’s buttons or the remote control buttons of STANDBY/ON, SEARCH, RGB, VIDEO, BLANK, AUTO, ASPECT, VOLUME, MUTE, KEYSTONE, POSITION, MENU, MAGNIFY and MY BUTTON is pressed.
- If the projector continues projecting a still image for a long time, the LCD panel might possibly be burned in. Do not leave the projector in the FREEZE mode for too long.

## Temporarily blanking the screen

- 1 Press the BLANK button on the remote control.
  - The blank screen will be displayed instead of the screen of input signal. Please refer to the BLANK item in SCREEN menu (p.38).

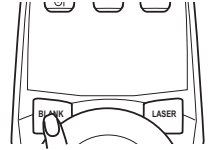

To exit from the blank screen and return to the input signal screen, press the BLANK button again.

- The projector automatically returns to the input signal screen when one of the projector's buttons or the remote control buttons is pressed or one of the commands (except get commands) is transmitted to the control port.

**NOTE** • The sound is not connected with the blank screen function. If necessary, set the volume or mute first.

## Using the menu function

This projector has the following menus: PICTURE, IMAGE, INPUT, SETUP, AUDIO, SCREEN, OPTION, NETWORK, and EASY MENU. EASY MENU consists of functions often used, and the other menus are classified into each purpose. Each of these menus is operated using the same methods. The basic operations of these menus are as follows.

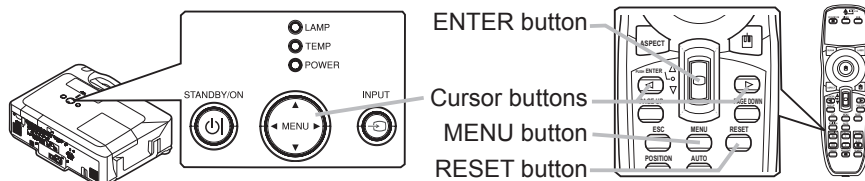

1. Press the MENU button on the remote control or one of the cursor buttons on the projector. The Advanced MENU, or EASY MENU that has priority just after powered on, will appear.

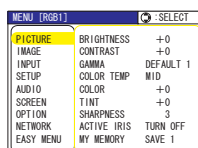

### In the EASY MENU

2. If you want to change it to the Advanced MENU, select the "Go to Advanced Menu..."
3. Use the cursor buttons ▲/▼ to select an item to operate.
4. Use the cursor buttons ◀/▶ to operate the item.

### In the Advanced MENU

2. Use the cursor buttons ▲/▼ to select a menu. If you want to change it to the EASY MENU, select the EASY MENU. Then press the cursor button ▶ on the projector or remote control, or the ENTER button on the remote control to select an item. The display of the selected menu will be active.
3. Use the cursor buttons ▲/▼ to select an item to operate. Then press the cursor button ▶ on the projector or remote control, or the ENTER button on the remote control to progress. The operation menu of the selected item will appear.
4. Use the cursor buttons ▲/▼ to operate the item.
  - When you want to reset the operation, press the RESET button on the remote control during the operation. Note that items whose functions are performed simultaneously with operation (ex. LANGUAGE, H PHASE, VOLUME etc.) cannot be reset.
  - In the Advanced MENU, when you want to return to the previous display, press the cursor button ◀ on the projector or remote control, or the ESC button on the remote control.
5. Press the MENU button on the remote control again to close the menu and complete this operation. Even if you do not do anything, the dialog will automatically disappear after about 10 seconds.
  - Some functions cannot be performed when a certain input port is selected, or when a certain input signal is displayed.

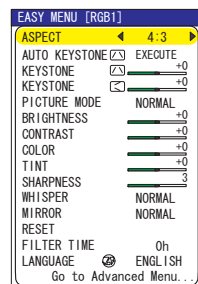



## EASY Menu

From the EASY MENU, items shown in the table below can be performed.

Select an item using the ▲/▼ cursor buttons on the projector or remote control. Then perform it according to the following table.

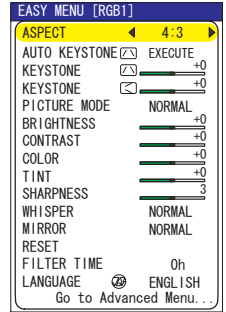

Item	Description																				
<b>ASPECT</b>	Using the ◀/▶ buttons switches the mode for aspect ratio. See the ASPECT item in IMAGE menu (📖29).																				
<b>AUTO KEYSTONE EXECUTE</b>	Using the ▶ button executes the auto keystone function. See the AUTO KEYSTONE  EXECUTE item in SETUP menu (📖35).																				
<b>KEYSTONE</b>	Using the ◀/▶ buttons corrects the vertical keystone distortion. See the KEYSTONE  item in SETUP menu (📖35).																				
<b>KEYSTONE</b>	Using the ◀/▶ buttons corrects the horizontal keystone distortion. See the KEYSTONE  item in SETUP menu (📖35).																				
<b>PICTURE MODE</b>	Using the ◀/▶ buttons switches the picture mode. The picture modes are combinations of GAMMA and COLOR TEMP settings. Choose a suitable mode according to the projected source.																				
	<p> </p> <table border="1"> <thead> <tr> <th></th> <th>COLOR TEMP</th> <th>GAMMA</th> </tr> </thead> <tbody> <tr> <td>NORMAL</td> <td>MID DEFAULT</td> <td>#1 DEFAULT</td> </tr> <tr> <td>CINEMA</td> <td>LOW DEFAULT</td> <td>#2 DEFAULT</td> </tr> <tr> <td>DYNAMIC</td> <td>HIGH DEFAULT</td> <td>#3 DEFAULT</td> </tr> <tr> <td>BOARD(BLACK)</td> <td>Hi-BRIGHT-1 DEFAULT</td> <td>#4 DEFAULT</td> </tr> <tr> <td>BOARD(GREEN)</td> <td>Hi-BRIGHT-2 DEFAULT</td> <td>#4 DEFAULT</td> </tr> <tr> <td>WHITEBOARD</td> <td>MID DEFAULT</td> <td>#5 DEFAULT</td> </tr> </tbody> </table> <ul style="list-style-type: none"> <li>• When the combination of GAMMA and COLOR TEMP differs from pre-assigned modes above, the display on the menu for the PICTURE MODE is “CUSTOM”. Please refer to the GAMMA (📖26) and COLOR TEMP (📖27) items in PICTURE menu.</li> <li>• When this function is performed, a certain extra such as a line may appear.</li> </ul>		COLOR TEMP	GAMMA	NORMAL	MID DEFAULT	#1 DEFAULT	CINEMA	LOW DEFAULT	#2 DEFAULT	DYNAMIC	HIGH DEFAULT	#3 DEFAULT	BOARD(BLACK)	Hi-BRIGHT-1 DEFAULT	#4 DEFAULT	BOARD(GREEN)	Hi-BRIGHT-2 DEFAULT	#4 DEFAULT	WHITEBOARD	MID DEFAULT
	COLOR TEMP	GAMMA																			
NORMAL	MID DEFAULT	#1 DEFAULT																			
CINEMA	LOW DEFAULT	#2 DEFAULT																			
DYNAMIC	HIGH DEFAULT	#3 DEFAULT																			
BOARD(BLACK)	Hi-BRIGHT-1 DEFAULT	#4 DEFAULT																			
BOARD(GREEN)	Hi-BRIGHT-2 DEFAULT	#4 DEFAULT																			
WHITEBOARD	MID DEFAULT	#5 DEFAULT																			

(continued on next page)

**EASY Menu (continued)**

Item	Description
<b>BRIGHTNESS</b>	Using the ◀/▶ buttons adjusts the brightness. See the BRIGHTNESS item in PICTURE menu (📖26).
<b>CONTRAST</b>	Using the ◀/▶ buttons adjusts the contrast. See the CONTRAST item in PICTURE menu (📖26).
<b>COLOR</b>	Using the ◀/▶ buttons adjusts the strength of whole color. See the COLOR item in PICTURE menu (📖27).
<b>TINT</b>	Using the ◀/▶ buttons adjusts the tint. See the TINT item in PICTURE menu (📖27).
<b>SHARPNESS</b>	Using the ◀/▶ buttons adjusts the sharpness. See the SHARPNESS item in PICTURE menu (📖27).
<b>WHISPER</b>	Using the ◀/▶ buttons turns off/on the whisper mode. See the WHISPER item in SETUP menu (📖36).
<b>MIRROR</b>	Using the ◀/▶ buttons switches the mode for mirror status. See the MIRROR item in SETUP menu (📖36).
<b>RESET</b>	Performing this item resets all of the EASY MENU items except the FILTER TIME and LANGUAGE. A dialog is displayed for confirmation. Selecting the RESET using the ▲ button performs resetting.
<b>FILTER TIME</b>	Performing this item resets the filter time which counts usage time of the air filter. A dialog is displayed for confirmation. Selecting the RESET using the ▲ button performs resetting. See the FILTER TIME item in OPTION menu (📖43).
<b>LANGUAGE</b>	Using the ◀/▶ buttons changes the display language. See the LANGUAGE item in SCREEN menu (📖38).
<b>Go to Advanced Menu...</b>	Select "Go to Advanced Menu..." on the menu, and press the ▶ or ENTER button to use the menu of PICTURE, IMAGE, INPUT, SETUP, AUDIO, SCREEN, OPTION or NETWORK.

PICTURE Menu

From the PICTURE menu, items shown in the table below can be performed.

Select an item using the ▲/▼ cursor buttons on the projector or remote control, and press the ► cursor button on the projector or remote control, or the ENTER button on the remote control to execute the item. Then perform it according to the following table.

MENU [RGB1]		◀ SELECT
PICTURE	BRIGHTNESS	+0
IMAGE	CONTRAST	+0
INPUT	GAMMA	DEFAULT 1
SETUP	COLOR TEMP	MID
AUDIO	COLOR	+0
SCREEN	TINT	+0
OPTION	SHARPNESS	3
NETWORK	ACTIVE IRIS	TURN OFF
EASY MENU	MY MEMORY	SAVE 1

Item	Description
<b>BRIGHTNESS</b>	Using the ▲/▼ buttons adjusts the brightness. Light ⇄ Dark
<b>CONTRAST</b>	Using the ▲/▼ buttons adjusts the contrast. Strong ⇄ Weak
<b>GAMMA</b>	<p>Using the ▲/▼ buttons switches the gamma mode.                      #1 DEFAULT ⇄ #1 CUSTOM ⇄ #2 DEFAULT ⇄ #2 CUSTOM ⇄ #3 DEFAULT                      ⇕ ⇕                      #5 CUSTOM ⇄ #5 DEFAULT ⇄ #4 CUSTOM ⇄ #4 DEFAULT ⇄ #3 CUSTOM</p> <p><b>To adjust CUSTOM</b></p> <p>Selecting a mode whose name includes CUSTOM and then pressing the ► button or the ENTER button displays a dialog to aid you in adjusting the mode. This function is useful when you want to change the brightness of particular tones.</p> <p>Choose an item using the ◀/▶ buttons, and adjust the level using the ▲/▼ buttons.</p> <p>You can display a test pattern for checking the effect of your adjustment by pressing the ENTER button. Each time you press the ENTER button, the pattern changes as below.</p> <p>No pattern ⇄ Gray scale of 9 steps ⇄ Ramp ⇄ Gray scale of 15 steps</p> <p>The eight equalizing bars correspond to eight tone levels of the test pattern except the darkest in the left end. If you want to adjust the 2nd tone from left end on the test pattern (Gray scale of 9 steps), use the equalizing adjustment bar "1". The darkest tone at the left end of the test pattern cannot be controlled with any of equalizing adjustment bar.</p> <ul style="list-style-type: none"> <li>When this function is performed, lines or other distortion may appear.</li> </ul>

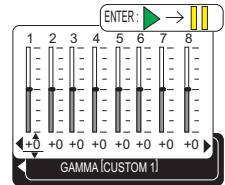

(continued on next page)

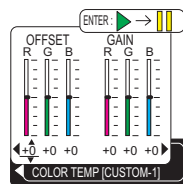

PICTURE Menu (continued)

Item	Description
<p><b>COLOR TEMP</b></p>	<p>Using the ▲/▼ buttons switches the color temperature mode.</p> <p>→ HIGH DEFAULT ⇔ HIGH CUSTOM ⇔ MID DEFAULT ⇔ MID CUSTOM ←          ↳ LOW DEFAULT ⇔ LOW CUSTOM ⇔ HI-BRIGHT-1 DEFAULT ⇔ HI-BRIGHT-1 CUSTOM ←          ↳ HI-BRIGHT-2 DEFAULT ⇔ HI-BRIGHT-2 CUSTOM ←</p> <p><b>To adjust CUSTOM</b></p> <p>Selecting a mode whose name includes CUSTOM and then pressing the ► button or the ENTER button displays a dialog to aid you in adjusting the OFFSET and GAIN of the selected mode.</p> <p>OFFSET adjustments change the color intensity on the whole tones of the test pattern.</p> <p>GAIN adjustments mainly affect color intensity on the brighter tones of the test pattern.</p> <p>Choose an item using the ◀/▶ buttons, and adjust the level using the ▲/▼ buttons.</p> <p>You can display a test pattern for checking the effect of your adjustment by pressing the ENTER button. Each time you press the ENTER button, the pattern changes as below.</p> <p>No pattern ⇔ Gray scale of 9 steps ⇐          ↑ Ramp ⇔ Gray scale of 15 steps</p> <ul style="list-style-type: none"> <li>• When this function is performed, lines or other distortion may appear.</li> </ul>
<p><b>COLOR</b></p>	<p>Using the ▲/▼ buttons adjusts the strength of whole color.</p> <p>Strong ⇔ Weak</p> <ul style="list-style-type: none"> <li>• This item can be selected only for a video signal, s-video or component video signal.</li> </ul>
<p><b>TINT</b></p>	<p>Using the ▲/▼ buttons adjusts the tint.</p> <p>Greenish ⇔ Reddish</p> <ul style="list-style-type: none"> <li>• This item can be selected only for a video signal, s-video or component video signal.</li> </ul>
<p><b>SHARPNESS</b></p>	<p>Using the ▲/▼ buttons adjusts the sharpness.</p> <p>Strong ⇔ Weak</p> <ul style="list-style-type: none"> <li>• There may be some noise and/or the screen may flicker for a moment when an adjustment is made. This is not a malfunction.</li> </ul>



(continued on next page)

**PICTURE Menu (continued)**





Item	Description								
<p><b>ACTIVE IRIS</b></p>	<p>Using the ▲/▼ cursor buttons changes the active iris control mode.            PRESENTATION ⇄ THEATER ⇄ TURN OFF</p>  <table border="1" data-bbox="318 339 1016 504"> <thead> <tr> <th></th> <th>Feature</th> </tr> </thead> <tbody> <tr> <td>PRESENTATION</td> <td>The active iris displays the best presentation image for both bright and dark scenes.</td> </tr> <tr> <td>THEATER</td> <td>The active iris displays the best theater image for both bright and dark scenes.</td> </tr> <tr> <td>TURN OFF</td> <td>The active iris is always open.</td> </tr> </tbody> </table> <ul style="list-style-type: none"> <li>• The screen may flicker when the PRESENTATION or THEATER modes are selected. If this occurs select TURN OFF.</li> </ul>		Feature	PRESENTATION	The active iris displays the best presentation image for both bright and dark scenes.	THEATER	The active iris displays the best theater image for both bright and dark scenes.	TURN OFF	The active iris is always open.
	Feature								
PRESENTATION	The active iris displays the best presentation image for both bright and dark scenes.								
THEATER	The active iris displays the best theater image for both bright and dark scenes.								
TURN OFF	The active iris is always open.								
<p><b>MY MEMORY</b></p>	<p>This projector has 4 memories for adjustment data (for all the items of the PICTURE menu).            Selecting a function using the ▲/▼ buttons and pressing the ► or ENTER button performs each function.</p>  <p><b><u>LOAD1, LOAD2, LOAD3, LOAD4</u></b></p> <p>Performing a LOAD function loads the data from the memory linked in the number included in the function's name, and adjusts the picture automatically depending on the data.</p> <ul style="list-style-type: none"> <li>• The LOAD functions whose linked memory has no data are skipped.</li> <li>• Remember that the current adjusted condition will be lost by loading data. If you want to keep the current adjustment, please save it before performing a LOAD function.</li> <li>• There may be some noise and the screen may flicker for a moment when loading data. This is not malfunction.</li> <li>• The LOAD functions can be also performed by the MY MEMORY button which can be set by the MY BUTTON item in OPTION menu (□44).</li> </ul> <p><b><u>SAVE1, SAVE2, SAVE3, SAVE4</u></b></p> <p>Performing a SAVE function saves the current adjustment data into the memory linked in the number included in the function's name.</p> <ul style="list-style-type: none"> <li>• Remember that the current data being stored of a memory will be lost by saving a new data into the memory.</li> </ul>								

## IMAGE Menu

From the IMAGE menu, items shown in the table below can be performed.

Select an item using the ▲/▼ cursor buttons on the projector or remote control, and press the ► cursor button on the projector or remote control, or ENTER button on the remote control to execute the item. Then perform it according to the following table.

MENU [RGB1]		SELECT
PICTURE	ASPECT	4:3
IMAGE	OVER SCAN	5
INPUT	V POSITION	25
SETUP	H POSITION	142
AUDIO	H PHASE	16
SCREEN	H SIZE	1344
OPTION	AUTO ADJUST	EXECUTE
NETWORK		
EASY MENU		

Item	Description
<b>ASPECT</b>	<p>Using the ▲/▼ buttons switches the mode for aspect ratio.</p> <p><b>For an RGB signal</b>            NORMAL ⇄ 4:3 ⇄ 16:9 ⇄ SMALL  </p> <p><b>For an M1-D signal</b>            NORMAL ⇄ 4:3 ⇄ 16:9 ⇄ 14:9 ⇄ SMALL  </p> <p><b>For a Video signal, S-video signal or Component video signal</b>            4:3 ⇄ 16:9 ⇄ 14:9 ⇄ SMALL  </p> <p><b>For no signal</b>            4:3 (fixed)</p> <ul style="list-style-type: none"> <li>The NORMAL mode keeps the original aspect ratio of the signal.</li> </ul>
<b>OVER SCAN</b>	<p>Using the ▲/▼ buttons adjusts the over-scan ratio.</p> <p>Large (It reduces picture) ⇄ Small (It magnifies picture)</p> <ul style="list-style-type: none"> <li>This item can be selected only for a video, s-video and component signal.</li> <li>When this adjustment is too large, certain degradation may appear at the frame area of the picture. In such a case, please adjust small.</li> </ul>
<b>V POSITION</b>	<p>Using the ▲/▼ buttons adjusts the vertical position.</p> <p>Up ⇄ Down</p> <ul style="list-style-type: none"> <li>Over-adjusting the vertical position may cause noise to appear on the screen. If this occurs please reset the vertical position to the default setting. Pressing the RESET button when the V POSITION is selected will reset the V POSITION to the default setting.</li> <li>When this function is performed on a video signal, s-video signal, or component video signal of 525i (480i) or 625i (576i), the range of this adjustment depends on the OVER SCAN (above) setting. It is not possible to adjust when the OVER SCAN is set to 10.</li> </ul>
<b>H POSITION</b>	<p>Using the ▲/▼ buttons adjusts the horizontal position.</p> <p>Left ⇄ Right</p> <ul style="list-style-type: none"> <li>Over-adjusting the horizontal position may cause noise to appear on the screen. If this occurs please reset the horizontal position to the default setting. Pressing the RESET button when the H POSITION is selected will reset the H POSITION to the default setting.</li> <li>When this function is performed on a video signal, s-video signal, or component video signal of 525i (480i) or 625i (576i), the range of this adjustment depends on the OVER SCAN (above) setting. It is not possible to adjust when the OVER SCAN is set to 10.</li> </ul>

(continued on next page)

**IMAGE Menu (continued)**

Item	Description
<p><b>H PHASE</b></p>	<p>Using the ▲/▼ buttons adjusts the horizontal phase to eliminate flicker.                      Right ⇔ Left</p> <ul style="list-style-type: none"> <li>• This item can be selected only for an RGB signal or a component video signal. (except 525i (480i), 625i (576i), SCART RGB)</li> </ul>
<p><b>H SIZE</b></p>	<p>Using the ▲/▼ buttons adjusts the horizontal size.                      Large ⇔ Small</p> <ul style="list-style-type: none"> <li>• This item can be selected only for an RGB signal.</li> <li>• When this adjustment is excessive, the picture may not be displayed correctly. In such a case, please reset the adjustment by pressing the RESET button on the remote control during this operation.</li> </ul>
<p><b>AUTO ADJUST EXECUTE</b></p>	<p>Selecting this item performs the automatic adjustment feature.</p> <p><b>For an RGB signal</b>                      The vertical position, the horizontal position, the horizontal phase and the horizontal size will be automatically set to default. And the aspect ratio will be automatically selected.                      Make sure that the application window is set to its maximum size prior to attempting to use this feature. A dark picture may still be incorrectly adjusted. Use a bright picture when adjusting.</p> <p><b>For an M1-D signal</b>                      The aspect ratio will be automatically set to default.</p> <p><b>For a Video signal or S-video signal</b>                      The video format best suited for the respective input signal will be selected automatically.                      This function is available only when the AUTO mode is selected to the VIDEO FORMAT item in INPUT menu. For a component video signal, the signal type is identified automatically independently of this function.</p> <p><b>For a Video signal, S-video signal or Component video signal</b>                      The vertical position, horizontal position and aspect ratio will be automatically set to default.</p> <p><b>For a Component video signal</b>                      The horizontal phase will be automatically set to default.</p> <ul style="list-style-type: none"> <li>• The automatic adjustment operation requires about 10 seconds. Also please note that it may not function correctly with some input.</li> </ul>

## INPUT Menu

From the INPUT menu, items shown in the table below can be performed.

Select an item using the ▲/▼ cursor buttons on the projector or remote control, and press the ► cursor button on the projector or remote control, or ENTER button on the remote control to execute the item. Then perform it according to the following table.

MENU [RGB1]		SELECT
PICTURE	PROGRESSIVE	TV
IMAGE	VIDEO NR	MID
INPUT	3D-YCS	STILL
SETUP	COLOR SPACE	AUTO
AUDIO	COMPONENT	COMPONENT
SCREEN	VIDEO FORMAT	AUTO
OPTION	M1-D	NORMAL
NETWORK	FRAME LOCK	TURN ON
EASY MENU	RGB IN	RESOLUTION

Item	Description
<b>PROGRESSIVE</b>	<p>Using the ▲/▼ buttons switches the progress mode. TV ⇔ FILM ⇔ TURN OFF</p> <ul style="list-style-type: none"> <li>• This function is performed only for an interlaced signal of a VIDEO input, an S-VIDEO input or COMPONENT VIDEO input of 525i (480i), 625i (576i) or 1125i (1080i) signal.</li> <li>• When TV or FILM is selected, the screen image will be sharp. FILM adapts to the 2-3 Pull-Down conversion system. But these may cause a certain defect (for example, jagged line) of the picture for a quick moving object. In such a case, please select TURN OFF, even though the screen image may lose the sharpness.</li> </ul>
<b>VIDEO NR</b>	<p>Using the ▲/▼ buttons switches the noise reduction mode. HIGH ⇔ MID ⇔ LOW</p> <ul style="list-style-type: none"> <li>• This function performs only at a VIDEO input, an S-VIDEO or COMPONENT VIDEO input of 525i(480i), 625i(576i) or 1125i (1080i) signal.</li> <li>• When this function is excessive, it may cause a certain degradation of the picture.</li> </ul>
<b>3D-YCS</b>	<p>Using the ▲/▼ buttons switches the 3D-YCS mode. STILL ⇔ MOVIE ⇔ TURN OFF</p> <ul style="list-style-type: none"> <li>• This function performs only at a VIDEO input of NTSC, and PAL.</li> <li>• MOVIE is the mode for images with a lot of motions like movies, and STILL is the mode for images with few motions or completely still ones like slides.</li> </ul>
<b>COLOR SPACE</b>	<p>Using the ▲/▼ buttons switches the mode for color space. AUTO ⇔ RGB ⇔ SMPTE240 ⇔ REC709 ⇔ REC601</p> <p style="text-align: center;">↑—————↑</p> <ul style="list-style-type: none"> <li>• This item can be selected only for an RGB signal or a component video signal (except 525i (480i), 625i (576i) and SCART RGB).</li> <li>• The AUTO mode automatically selects the optimum mode.</li> <li>• The AUTO operation may not work well at some signals. In such a case, it might be good to select a suitable mode except AUTO.</li> </ul>

(continued on next page)

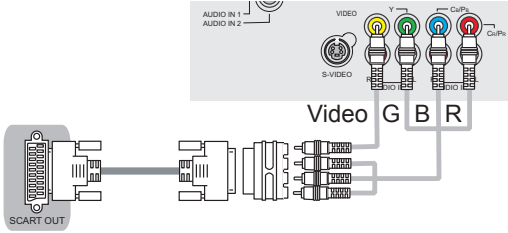
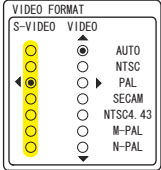

**INPUT Menu (continued)**

Item	Description						
<p><b>COMPONENT</b></p>	<p>Using the ▲/▼ buttons switches the function of the COMPONENT (Y, Cb/Pb, Cr/Pr) port.                      COMPONENT ⇔ SCART RGB</p> <p>When the SCART RGB is selected, the COMPONENT (Y, Cb/Pb, Cr/Pr) and VIDEO ports will function as a SCART RGB port. A SCART adapter or SCART cable is required for a SCART RGB input to the projector. For details, contact your dealer.</p> 						
<p><b>VIDEO FORMAT</b></p>	<p>Set the video format for the s-video port and video port.                      (1) Use the ◀/▶ buttons to select the input port.                      (2) Using the ▲/▼ buttons switches the mode for video format.</p> <p>AUTO ⇔ NTSC ⇔ PAL ⇔ SECAM                      ↕ N-PAL ⇔ M-PAL ⇔ NTSC4.43 ↕</p> <ul style="list-style-type: none"> <li>• This item is performed only for a video signal from the VIDEO port or the S-VIDEO port.</li> <li>• The AUTO mode automatically selects the optimum mode.</li> <li>• The AUTO operation may not work well for some signals. If the picture becomes unstable (e.g. an irregular picture, lack of color), please select the mode according to the input signal.</li> </ul> 						
<p><b>M1-D</b></p>	<p>Using the ▲/▼ cursor buttons changes the M1-D signal mode.                      NORMAL ⇔ ENHANCED</p> <table border="1" data-bbox="318 1129 1014 1219"> <thead> <tr> <th></th> <th>Feature</th> </tr> </thead> <tbody> <tr> <td>NORMAL</td> <td>Suitable for DVD signals (16-235)</td> </tr> <tr> <td>ENHANCED</td> <td>Suitable for VGA signals (0-255)</td> </tr> </tbody> </table> <ul style="list-style-type: none"> <li>• If the contrast of the screen image is too strong or too weak, try finding a more suitable mode.</li> </ul>		Feature	NORMAL	Suitable for DVD signals (16-235)	ENHANCED	Suitable for VGA signals (0-255)
	Feature						
NORMAL	Suitable for DVD signals (16-235)						
ENHANCED	Suitable for VGA signals (0-255)						



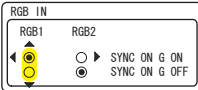

(continued on next page)

**INPUT Menu (continued)**

Item	Description
<p><b>FRAME LOCK</b></p>	<p>Using the ▲/▼ buttons turns the frame lock function on/off.            TURN ON ⇔ TURN OFF</p> <ul style="list-style-type: none"> <li>• This item can be performed only on an RGB signal with a vertical frequency of 50 to 60 Hz.</li> <li>• When the TURN ON is selected, a moving pictures are displayed more smoothly.</li> <li>• This function may cause a certain degradation of the picture. In such a case, please select the TURN OFF.</li> </ul>
<p><b>RGB IN</b></p>	<p>Set the RGB input signal type for the RGB port.</p> <p>(1) Use the ◀/▶ buttons to select the RGB port to be set.            RGB1 ⇔ RGB2</p> <p>(2) Use the ▲/▼ buttons to select the RGB input signal type.            SYNC ON G ON ⇔ SYNC ON G OFF</p> <ul style="list-style-type: none"> <li>• Selecting the SYNC ON G ON turns the SYNC ON G mode on. The SYNC ON G mode allows reception of a sync on G signal.</li> <li>• In the SYNC ON G mode, the picture may be distorted with certain input signals. In such a case, remove the signal connector so that no signal is received and turn the SYNC ON G mode off, and then reconnect the signal.</li> </ul> 

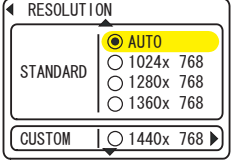
(continued on next page)

**INPUT Menu (continued)**

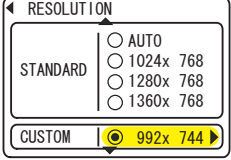

Item	Description
<p><b>RESOLUTION</b></p>	<p>The resolution for the RGB1 and RGB2 input signals can be set on this projector.</p> <p>(1) In the INPUT menu select the RESOLUTION using the ▲/▼ buttons and press the ► button. The RESOLUTION menu will be displayed.</p>  <p>RESOLUTION MENU</p> <p>(2) In the RESOLUTION menu select the resolution you wish to display using the ▲/▼ buttons. Selecting AUTO will set a resolution appropriate to the input signal.</p> <p>(3) Pressing the ► or ENTER button when selecting a STANDARD resolution will automatically adjust the horizontal and vertical positions, clock phase and horizontal size and automatically select an aspect ratio. The INFORMATION dialog (46) will be displayed.</p>  <p>(4) To set a custom resolution use the ▲/▼ buttons to select the CUSTOM and the CUSTOM RESOLUTION BOX will be displayed. Set the horizontal (HORZ) and vertical (VERT) resolutions using the ▲/▼/◀/▶ buttons. Although not all resolutions are guaranteed.</p>  <p>CUSTOM RESOLUTION BOX</p> <p>(5) To save the setting place the cursor on the right-most digit and press the ► button. The horizontal and vertical positions, clock phase and horizontal size will be automatically adjusted and an aspect ratio will be automatically selected. After the INFORMATION (46) dialog has displayed for about 10 seconds the screen will return to the RESOLUTION menu displaying the changed resolution.</p>  <p>(6) To revert back to the previous resolution without saving changes place the cursor on the left-most digit and press the ◀ button. The screen will then return to the RESOLUTION menu displaying the previous resolution.</p>  <p>• For some pictures, this function may not work well.</p>

## SETUP Menu

From the SETUP menu, items shown in the table below can be performed.

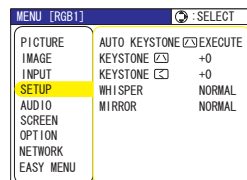
Select an item using the ▲/▼ cursor buttons on the projector or remote control, and press the ► cursor button on the projector or remote control, or the ENTER button on the remote control to execute the item. Then perform it according to the following table.



Item	Description
<p><b>AUTO KEYSTONE EXECUTE</b> </p>	<p>Selecting this item performs the Automatic keystone distortion correction. Projector automatically corrects vertical keystone distortion due to the (forward/backward) setup angle by itself.</p> <p>This function will be executed only once when selected in the Menu. When the slant of the projector is changed, executes this function again.</p> <ul style="list-style-type: none"> <li>• The adjustable range of this function will vary among inputs. For some input, this function may not work well.</li> <li>• When V:INVERT or H&amp;V:INVERT is selected to the MIRROR item in the SETUP menu, if the projector screen is inclined or angled downward, this function may not work correctly.</li> <li>• When the zoom adjustment is set to the TELE (telephoto focus), this function may be excessive. This function should be used when the zoom adjustment is set to the full WIDE (wide-angle focus) whenever possible.</li> <li>• When the projector is placed on the level (about ±3°), this function may not work.</li> <li>• When the projector is inclined to near ±30 degree or over, this function may not work well.</li> <li>• When the vertical lens shift is not set fully upward (not set fully downward for the optional lens type FL-601 only (p.45)), this function may not work well.</li> <li>• When the horizontal lens shift is not set to the center, this function may not work well.</li> <li>• This function will be unavailable when the Transition Detector is on (p.51).</li> </ul>
<p><b>KEYSTONE</b> </p>	<p>Using the ▲/▼ buttons corrects the vertical keystone distortion.</p> <p>Shrink the top of the image ⇔ Shrink the bottom of the image</p> <ul style="list-style-type: none"> <li>• The adjustable range of this function will vary among inputs. For some input, this function may not work well.</li> <li>• When the vertical lens shift is not set fully upward (not set fully downward for the optional lens type FL-601 only (p.45)), this function may not work well.</li> <li>• When the horizontal lens shift is not set to the center, this function may not work well.</li> <li>• This function will be unavailable when the Transition Detector is on (p.51).</li> </ul>
<p><b>KEYSTONE</b> </p>	<p>Using the ▲/▼ buttons corrects the horizontal keystone distortion.</p> <p>Shrink the right of the image ⇔ Shrink the left of the image</p> <ul style="list-style-type: none"> <li>• The adjustable range of this function will vary among inputs. For some input, this function may not work well.</li> <li>• When the horizontal lens shift is not set to the center, this function may not work well.</li> <li>• This function will be unavailable when the Transition Detector is on (p.51).</li> </ul>

(continued on next page)

**SETUP Menu (continued)**

Item	Description
<p><b>WHISPER</b></p>	<p>Using the ▲/▼ buttons turns off/on the whisper mode.                      NORMAL ⇔ WHISPER</p> <ul style="list-style-type: none"> <li>• When the WHISPER is selected, acoustic noise and screen brightness are reduced.</li> </ul>
<p><b>MIRROR</b></p>	<p>Using the ▲/▼ buttons switches the mode for mirror status.</p> <div style="text-align: center;">  </div> <p>NORMAL ⇔ H:INVERT ⇔ V:INVERT ⇔ H&amp;V:INVERT</p> <p style="text-align: center;">↑—————↑</p> <p>If the Transition Detector is TURN ON and MIRROR status is changed, Transition Detector Alarm (🔊51) will be displayed when projector is restarted after the power switch is turned off.</p>



## AUDIO Menu

From the AUDIO menu, items shown in the table below can be performed.

Select an item using the ▲/▼ cursor buttons on the projector or remote control, and press the ► cursor button on the projector or remote control, or ENTER button on the remote control to execute the item. Then perform it according to the following table.

MENU [RGB1]		SELECT
PICTURE	VOLUME	16
IMAGE	TREBLE	+0
INPUT	BASS	+0
SETUP	SRS WOW	MID
<b>AUDIO</b>	SPEAKER	TURN ON
SCREEN	AUDIO	
OPTION		
NETWORK		
EASY MENU		

**NOTE** • The speaker sound may distorted or the case may be trembling when the volume is too high or treble/bass is emphasized or WOW is activated. In that case, make the volume reduced, bass/treble low or WOW effect to be weakend.

Item	Description
<b>VOLUME</b>	Using the ▲/▼ buttons adjusts the volume. High ⇄ Low
<b>TREBLE</b>	Using the ▲/▼ buttons adjusts the treble level. High ⇄ Low
<b>BASS</b>	Using the ▲/▼ buttons adjusts the bass level. High ⇄ Low
<b>SRS WOW</b> 	Using the ▲/▼ buttons switches the mode for SRS WOW mode. HIGH ⇄ MID ⇄ OFF • SRS WOW™ accomplishes this by providing a panoramic three-dimensional audio image that extends the sound field in both the horizontal and vertical planes, and lowers the perceived bass response well beyond the low frequency limitations of the drivers. Adjust it depending on the user's preference.
<b>SPEAKER</b>	Using the ▲/▼ buttons turns the speaker function on/off. TURN ON ⇄ TURN OFF • When the TURN ON is selected the built-in speaker works.
<b>AUDIO</b>	Allocates the audio ports. (1) Choose a picture input port using the ▲/▼ buttons. <div style="text-align: center;">  <p>VIDEO ⇄ S-VIDEO ⇄ COMPONENT</p> </div> (2) Select the audio port to be interlocked with the input port using the ◀/▶ buttons. 1 ⇄ 2 ⇄ 3 ⇄ 4 ⇄ ✕ When ✕ is selected to an input port, any audio ports do not work interlocking with the input port, and any items in AUDIO menu are invalid.

AUDIO	1	2	3	4	✕
← QUIT	○	○	○	○	✕
RGB1	●	○	○	○	○
RGB2	○	●	○	○	○
M1-D	○	○	●	○	○
COMPONENT	○	○	○	●	○
S-VIDEO	○	○	○	○	●
VIDEO	○	○	○	○	○

## SCREEN Menu

From the SCREEN menu, items shown in the table below can be performed.

Select an item using the ▲/▼ cursor buttons on the projector or remote control, and press the ► cursor button on the projector or remote control, or ENTER button on the remote control to execute the item. Then perform it according to the following table.

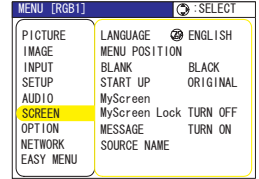

Item	Description								
<b>LANGUAGE</b>	<p>Using the ▲/▼ buttons switches the OSD (On Screen Display) language.</p> <p>ENGLISH ⇄ FRANÇAIS ⇄ DEUTSCH ⇄ ESPAÑOL ⇄ ITALIANO</p> <p>NORSK ⇄ NEDERLANDS ⇄ PORTUGUÊS ⇄ 日本語</p> <p>简体中文 ⇄ 繁體中文 ⇄ 한글 ⇄ SVENSKA ⇄ РУССКИЙ</p> <p>SUOMI ⇄ POLSKI ⇄ TÜRKÇE</p>								
<b>MENU POSITION</b>	<p>Using the ◀/▶/▲/▼ buttons adjusts the menu position.</p> <p>To quit the operation, press the MENU button on the remote control or keep no operation for about 10 seconds.</p>								
<b>BLANK</b>	<p>Using the ▲/▼ buttons switches the mode for the blank screen. The blank screen is a screen for the temporarily blanking feature (40). It is displayed by pressing the BLANK button on the remote control.</p> <p>MyScreen ⇄ ORIGINAL ⇄ BLUE ⇄ WHITE ⇄ BLACK</p> <table border="1"> <thead> <tr> <th></th> <th>Feature</th> </tr> </thead> <tbody> <tr> <td>MyScreen</td> <td>Screen can be registered by the MyScreen item (40).</td> </tr> <tr> <td>ORIGINAL</td> <td>Screen preset as the standard screen.</td> </tr> <tr> <td>BLUE, WHITE, BLACK</td> <td>Plain screens in each color.</td> </tr> </tbody> </table> <p>• To avoid remaining as an afterimage, the MyScreen or ORIGINAL screen will change to the plain black screen after several minutes.</p>		Feature	MyScreen	Screen can be registered by the MyScreen item (40).	ORIGINAL	Screen preset as the standard screen.	BLUE, WHITE, BLACK	Plain screens in each color.
	Feature								
MyScreen	Screen can be registered by the MyScreen item (40).								
ORIGINAL	Screen preset as the standard screen.								
BLUE, WHITE, BLACK	Plain screens in each color.								

(continued on next page)

**SCREEN Menu (continued)**

Item	Description			
<p><b>START UP</b></p>	<p>Using the ▲/▼ buttons switches the mode for the start-up screen. The start-up screen is a screen displayed when no signal or an unsuitable signal is detected.</p>			
	<p>MyScreen ⇄ ORIGINAL ⇄ TURN OFF</p> <p style="text-align: center;">↑—————↑</p>			
	<table border="1" style="width: 100%;"> <tr> <td style="width: 50%;"></td> <td style="width: 50%;">Feature</td> </tr> </table>		Feature	
		Feature		
	<table border="1" style="width: 100%;"> <tr> <td style="width: 50%;">MyScreen</td> <td style="width: 50%;">Screen can be registered by the MyScreen item (☐40).</td> </tr> </table>	MyScreen	Screen can be registered by the MyScreen item (☐40).	
MyScreen	Screen can be registered by the MyScreen item (☐40).			
<table border="1" style="width: 100%;"> <tr> <td style="width: 50%;">ORIGINAL</td> <td style="width: 50%;">Screen preset as the standard screen.</td> </tr> <tr> <td style="width: 50%;">TURN OFF</td> <td style="width: 50%;">Plain black screen.</td> </tr> </table>	ORIGINAL	Screen preset as the standard screen.	TURN OFF	Plain black screen.
ORIGINAL	Screen preset as the standard screen.			
TURN OFF	Plain black screen.			
<ul style="list-style-type: none"> <li>• To avoid remaining as an afterimage, the MyScreen or ORIGINAL screen will change to the BLANK screen (☐38) after several minutes. If also the BLANK screen is the MyScreen or ORIGINAL, the plain black screen is instead used.</li> <li>• When the TURN ON is selected to the MyScreen PASSWORD of SECURITY item in OPTION menu (☐48), the START UP is fixed to MyScreen.</li> </ul>				

(continued on next page)





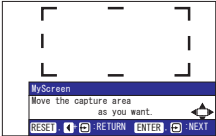

SCREEN Menu (continued)

Item	Description
<p><b>MyScreen</b></p>	<p>This item allows you to capture an image for use as a MyScreen image which can be used as the BLANK screen and START UP screen. Display the image you want to capture before executing the following procedure.</p> <ol style="list-style-type: none"> <li>1. Selecting this item displays a dialog titled "MyScreen". It will ask you if you start capturing an image from the current screen.                      <p>Please wait for the target image to be displayed, and press the ENTER button on the remote control when the image is displayed. The image will freeze and the frame for capturing will appear.</p> <p>To stop performing, press the RESET or ESC button on the remote control.</p> </li> <li>2. Using the ▲/▼/◀/▶ buttons adjusts the frame position. Please move the frame to the position of the image which you want to use. The frame may not be able to be moved for some input signals.                      <p>To start registration, press the ENTER button on the remote control.</p> <p>To restore the screen and return to the previous dialog, press the RESET or ESC button on the remote control.</p> <p>Registration takes several minutes.</p> <p>When the registration is completed, the registered screen and the following message is displayed for several seconds:</p> <p><b>"MyScreen registration is finished."</b></p> <p>If the registration failed, the following message is displayed:</p> <p><b>"A capturing error has occurred. Please try again."</b></p> <ul style="list-style-type: none"> <li>• This item cannot be selected for an M1-D signal.</li> <li>• This function cannot be selected when the TURN ON is selected to the MyScreen Lock item (<a href="#">🔗 below</a>).</li> <li>• This function cannot be selected when the TURN ON is selected to the MyScreen PASSWORD of SECURITY item in OPTION menu (<a href="#">🔗 48</a>).</li> </ul> </li> </ol>
<p><b>MyScreen Lock</b></p>	<p>Using the ▲/▼ buttons turns on/off the MyScreen lock function.</p> <p>TURN ON ⇔ TURN OFF</p> <p>When the TURN ON is selected, the item MyScreen is locked. Use this function for protecting the current MyScreen.</p> <ul style="list-style-type: none"> <li>• This function cannot be selected when the TURN ON is selected to the MyScreen PASSWORD of SECURITY item in OPTION menu (<a href="#">🔗 48</a>).</li> </ul>

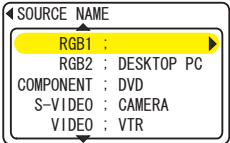
(continued on next page)

SCREEN Menu (continued)

Item	Description
<p><b>MESSAGE</b></p>	<p>Using the ▲/▼ buttons turns on/off the message function.                      TURN ON ⇔ TURN OFF</p> <p>When the TURN ON is selected, the following message function works.                      “AUTO IN PROGRESS” while automatically adjusting                      “NO INPUT IS DETECTED”                      “SYNC IS OUT OF RANGE”                      “Searching...” while searching for the input                      “Detecting...” while an input signal is detected                      The indication of the input signal displayed by changing                      The indication of the aspect ratio displayed by changing                      The indication of the PICTURE MODE displayed by changing                      The indication of the ACTIVE IRIS displayed by changing                      The indication of the MY MEMORY displayed by changing                      The indication of "FREEZE" and "II" while freezing the screen by pressing the FREEZE button.</p> <ul style="list-style-type: none"> <li>• When the TURN OFF is selected, please remember if the picture is freezing. Do not mistake freezing for a malfunction ( 21).</li> </ul>
<p><b>SOURCE NAME</b></p>	<p>Each input port for this projector can have a name applied to it.</p> <p>(1) Use the ▲/▼ buttons on the SCREEN menu to select SOURCE NAME and press the ► button. The SOURCE NAME menu will be displayed.</p>  <p>(2) Use the ▲/▼ buttons on the SOURCE NAME menu to select the port to be named and press the ► button. Right side of the menu is blank until a name is specified. The SOURCE NAME dialog will be displayed.</p>  <p>(3) The current name will be displayed on the first line. Use the ▲/▼/◀/▶ buttons and the ENTER or INPUT button to select and enter characters. The RESET button can be used to erase 1 character at a time. The name can be a maximum of 16 characters.</p>  <p>(4) To change an already inserted character, press the ▲ button while the cursor is on the [A-N] row to move the cursor to the name displayed on the first line and use the ◀/▶ buttons to select character to be changed. Once a character in the name is selected use the ▼ button to move the cursor back down to the character entry area to select and enter characters as described above.</p>  <p>(5) Select [ ] and press the ENTER or INPUT buttons when finished entering text. To revert to the previous name without saving changes press the ESC or ◀ button and the INPUT button simultaneously.</p>

## OPTION Menu

From the OPTION menu, items shown in the table below can be performed.

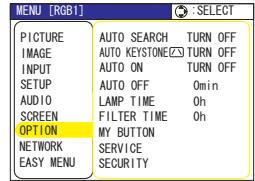

Select an item using the ▲/▼ cursor buttons on the projector or remote control, and press the ► cursor button on the projector or remote control, or ENTER button on the remote control to execute the item, except for the items LAMP TIME and FILTER TIME. Then perform it according to the following table.



Item	Description
<b>AUTO SEARCH</b>	<p>Using the ▲/▼ buttons turns on/off the automatic signal search function. TURN ON ⇔ TURN OFF</p> <p>When the TURN ON is selected, detecting no signal automatically cycles through input ports in the following order. The search is started from the current port. Then when an input is found, the projector will stop searching and display the image.</p> <p>RGB 1 ⇨ RGB 2 ⇨ M1-D ⇨ COMPONENT ⇨ S-VIDEO ⇨ VIDEO ↑</p>
<b>AUTO KEYSTONE</b> [↘]	<p>Using the ▲/▼ buttons turns on/off the automatic keystone function. TURN ON ⇔ TURN OFF</p> <p>TURN ON : Automatic keystone distortion correction will be executed whenever changing the slant of the projector.</p> <p>TURN OFF : This function is disabled. Please execute the AUTO KEYSTONE [↘] EXECUTE in the SETUP Menu for automatic keystone distortion correction.</p> <ul style="list-style-type: none"> <li>• When the projector is suspended from the ceiling this feature will not function properly so select the TURN OFF.</li> <li>• This function will be unavailable when the Transition Detector is on ([51]).</li> </ul>
<b>AUTO ON</b>	<p>Using the ▲/▼ buttons turns on/off the AUTO ON function. TURN ON ⇔ TURN OFF</p> <p>When AUTO ON is set to TURN ON, the projector's lamp will only be automatically turned on when the Power switch is turned on if the power was turned off using the Power switch the last time the projector was turned off.</p> <ul style="list-style-type: none"> <li>• After turning the lamp on by the AUTO ON function, if neither input nor operation is detected for about 30 minutes, the projector is turned off, even though the AUTO OFF function ([43]) is disabled.</li> </ul>



(continued on next page)

**OPTION Menu (continued)**

Item	Description
<p><b>AUTO OFF</b></p>	<p>Using the ▲/▼ buttons adjusts the time to count down to automatically turn the projector off.                      Long (max. 99 minutes) ⇔ Short (min. 0 minute = DISABLE)</p> <div style="display: flex; justify-content: space-around; align-items: center;">   </div> <p>When the time is set to 0, the projector is not turned off automatically. When the time is set to 1 to 99, and when the passed time with no-signal or an unsuitable signal reaches at the set time, the projector lamp will be turned off.                      If one of the projector's buttons or the remote control buttons is pressed or one of the commands (except get commands) is transmitted to the control port during the corresponding time, projector will not be turned off.                      Please refer to the section "Turning off the power" (16).</p>
<p><b>LAMP TIME</b></p>	<p>The lamp time is the time counted after the last resetting. It is shown in the OPTION menu as the usage time of the lamp. Pressing the RESET button on the remote control or the ► button of the projector displays a dialog.                      To reset the lamp time, select the RESET using the ▲ button.                      RESET ⇔ CANCEL</p> <ul style="list-style-type: none"> <li>• Please reset the lamp time only when you have replaced the lamp, for a suitable indication about the lamp.</li> <li>• For the lamp replacement, see the section "Lamp" (56, 57).</li> </ul>
<p><b>FILTER TIME</b></p>	<p>The filter time is the time counted after the last resetting. It is shown in the OPTION menu as the usage time of the air filter. Pressing the RESET button on the remote control or the ► button of the projector displays a dialog.                      To reset the filter time, select the RESET using the ▲ button.                      RESET ⇔ CANCEL</p> <ul style="list-style-type: none"> <li>• Please reset the filter time only when you have cleaned or replaced the air filter, for a suitable indication about the air filter.</li> <li>• For the air filter cleaning, see the section "Air filter" (58, 59).</li> </ul>

(continued on next page)

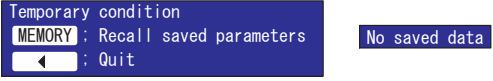
OPTION Menu (continued)

Item	Description
<p><b>MY BUTTON</b></p>	<p>This item is to assign one of the following function to MY BUTTON 1 and 2 on the remote control (📖6).            Choose 1 or 2 on the MY BUTTON menu using the ◀/▶ button first. Then using the ▲/▼ buttons sets one of the following functions to the chosen button.</p> <ul style="list-style-type: none"> <li>• RGB1: Sets port to RGB1.</li> <li>• RGB2: Sets port to RGB2.</li> <li>• M1-D: Sets port to M1-D.</li> <li>• COMPONENT: Sets port to COMPONENT (Y, Cb/Pb, Cr/Pr).</li> <li>• S-VIDEO: Sets port to S-VIDEO.</li> <li>• VIDEO: Sets port to VIDEO.</li> <li>• e-SHOT: Displays the e-SHOT menu (📖54).</li> <li>• INFORMATION: Displays a dialog of INPUT INFORMATION (📖46).</li> <li>• AUTO KEYSTONE [ ] EXECUTE:              Performs automatic keystone distortion correction (📖35).</li> <li>• MY MEMORY:              Loads one of adjustment data stored (📖28).</li> <li>• When the current adjustment is not saved to memory a dialog is displayed.</li> </ul>  <p>If you want to keep the current adjustment, please press the ◀ button to quit. Otherwise the current adjusted condition will be lost by loading a data.</p> <ul style="list-style-type: none"> <li>• PICTURE MODE: Changes the PICTURE MODE (📖24).</li> <li>• FILTER RESET:              Displays the filter time reset confirmation dialogue (📖43).</li> <li>• ACTIVE IRIS: Changes the active iris mode.</li> <li>• VOLUME+: Set the volume up.</li> <li>• VOLUME-: Set the volume down.</li> </ul>
<p><b>SERVICE</b></p>	<p>Selecting this item displays the SERVICE menu.            Select an item using the ▲/▼ buttons, and press the ▶ button or the ENTER button on the remote control to execute the item.</p> <p>FAN SPEED ⇔ AUTO ADJUST ⇔ GHOST ⇔ FILTER MESSAGE ⇔ LENS TYPE ⇔ KEY LOCK</p> <p>↙ FACTORY RESET ⇔ INFORMATION ⇔ REMOTE FREQ. ⇔ REMOTE RECEIV. ↘</p> <p><b>FAN SPEED</b></p> <p>Using the ▲/▼ buttons switches the rotation speed of the cooling fans. The HIGH is the mode for use at highlands etc. Note that the projector is noisier when the HIGH is selected.</p> <p>HIGH ⇔ NORMAL</p> 

(continued on next page)

OPTION Menu (continued)

Item	Description
<p><b>SERVICE</b></p>	<p><b>AUTO ADJUST</b> Using the ▲/▼ buttons enables/disables the automatic adjustment. When DISABLE is selected, the automatic adjustment feature is disabled, although rough adjustment is automatically performed depending on the basic setting.</p> <p>ENABLE ⇔ DISABLE</p>
	<ul style="list-style-type: none"> <li>Depending on conditions, such as input image, signal cable to the projector, environment around the projector, etc., the automatic adjustment may not work correctly. In such a case, please choose DISABLE to disable the automatic adjustment, and make adjustment manually.</li> </ul> <p><b>GHOST</b> 1. Select a color element of ghost using the ◀/▶ buttons. 2. Adjust the selected element using the ▲/▼ buttons to disappear ghost.</p>
	<p><b>FILTER MESSAGE</b> Use the ▲/▼ button to set the timer for the interval to show the message for cleaning up the air filter. 50h ⇔ 100h ⇔ 200h ⇔ 300h ⇔ TURN OFF After selecting “50h”, “100h”, “200h”, or “300h”, the message “REMINDER *** HRS PASSED AFTER THE LAST FILTER CHECK” will appear after the timer reaches the interval time set by the menu. ( 62) When the “TURN OFF” is chosen, the air filter cleaning message will not appear.</p> <ul style="list-style-type: none"> <li>Please check and clean the air filter periodically, even if there is no message. If the air filter becomes to be blocked by dust or others, the internal temperature will rise, which could cause malfunction, or reduce the lifetime of the projector.</li> <li>It is recommended to choose “100h” in general. Please be careful with the operating environment of the projector and the condition of the air filter, especially when the “200h”, “300h” or “TURN OFF” is chosen.</li> </ul>
	<p><b>LENS TYPE</b> Select the lens type currently used using the ▲/▼ buttons. 1 ⇔ 2 ⇔ 3 ⇔ 4 ⇔ 5 Please select one of them referring to the following. 1: for a standard lens (Type NL-600) 2: for a fixed short throw lens (Type FL-601) 3: for a short throw lens (Type SL-602) 4: for a long throw lens (Type LL-603) 5: for an ultra long throw lens (Type UL-604)</p> <ul style="list-style-type: none"> <li>This setting has an influence on the keystone distortion etc.</li> <li>About the optional lens, ask you dealer.</li> </ul>

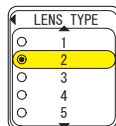
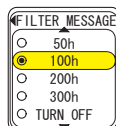
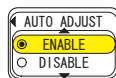

(continued on next page)

OPTION Menu (continued)

Item	Description	
<p><b>SERVICE</b></p>	<p><b>KEY LOCK</b>                      Using the ▲/▼ buttons turns on/off the key lock feature. When TURN ON is selected, the buttons on the projector except the STANDBY/ON button are locked.                      TURN ON ⇔ TURN OFF</p> <ul style="list-style-type: none"> <li>• Please use to avoid a mischief and touching accidentally. This function does not have any effect on the remote control.</li> </ul>	
	<p><b>REMOTE RECEIV.</b>                      (1) Select a remote sensor using the ▲/▼ button.                      1:FRONT ⇔ 2:TOP ⇔ 3:REAR                      (2) Switch it using the ENTER button  <input type="checkbox"/> (off) ⇔ <input checked="" type="checkbox"/> (on)</p> <ul style="list-style-type: none"> <li>• A sensor cannot be turned off when the other two are off. Always at least one sensor is on.</li> </ul>	
	<p><b>REMOTE FREQ.</b>                      Use the ▲/▼ button to change the Projector's remote sensor setting (14).                      1:NORMAL ⇔ 2:HIGH</p> <p>Items with a checkmark are on. The factory default setting is for both 1:NORMAL and 2: HIGH to be on. If the remote control does not function correctly set the this to either only 1 or only 2 as described in Remote Control Settings (14).                      Neither can be turned off at the same time.</p>	
	<p><b>INFORMATION</b>                      Selecting this item displays a dialog titled "INPUT INFORMATION". It shows the information about the current input.</p> <div style="display: flex; justify-content: space-around;"> <div data-bbox="369 1013 490 1077"> <p>◀ INPUT-INFORMATION                          RGB1                          1024x768 @60Hz                          FRAME LOCK</p> </div> <div data-bbox="610 1013 731 1077"> <p>◀ INPUT-INFORMATION                          S-VIDEO                          SECAM                          AUTO</p> </div> <div data-bbox="851 1013 972 1077"> <p>◀ INPUT-INFORMATION                          COMPONENT                          576i @50                          SCART RGB</p> </div> </div> <ul style="list-style-type: none"> <li>• The "FRAME LOCK" message on the dialog means the frame lock function is working.</li> <li>• The "SCART RGB" message means the COMPONENT VIDEO port is working as a SCART RGB input port. Please refer to the COMPONENT item in INPUT menu (32).</li> <li>• This item can't be selected for no signal and sync out.</li> </ul>	
	<p><b>FACTORY RESET</b>                      Selecting RESET using the button ▲ performs this function. By this function, all the items in all of menus will collectively return to the initial setting. Note that the items LAMP TIME, FILTER TIME, LANGUAGE and SECURITY are not reset.                      RESET ⇔ CANCEL</p>	

(continued on next page)

OPTION Menu (continued)

Item	Description
<p style="text-align: center;"><b>SECURITY</b></p>	<p>This projector is equipped with security functions. User registration is required before using the security functions. Please contact your local dealer.</p>
	<p><b>1. Using Security Features</b></p>
	<p><b>1.1 Inputting the PASSWORD</b></p>
	<p>1.1-1 Use the ▲/▼ buttons on the OPTION menu to select SECURITY and press the ► button. The ENTER PASSWORD box will be displayed. The factory default PASSWORD is <b>2400</b>. This PASSWORD can be changed (1.2 Changing the PASSWORD).</p>
	<ul style="list-style-type: none"> <li>• It is strongly recommended the factory default PASSWORD to be changed as soon as possible.</li> </ul>
<p>1.1-2 Use the ▲/▼/◀/▶ buttons to enter the registered PASSWORD. Move the cursor to the right side of the ENTER PASSWORD BOX and press the ► button to display the SECURITY menu. If an incorrect PASSWORD is input the ENTER PASSWORD BOX will be displayed again. If incorrect PASSWORD is input 3 times the projector will turn off. Afterwards the projector will turn off every time an incorrect PASSWORD is input.</p>	
<p><b>1.2 Changing the PASSWORD</b></p>	
<p>1.2-1 Use the ▲/▼ buttons on the SECURITY menu to select SECURITY PASSWORD CHANGE and press the ► button to display the ENTER NEW PASSWORD BOX.</p>	
<p>1.2-2 Use the ▲/▼/◀/▶ buttons to enter the new PASSWORD.</p>	
<p>1.2-3 Move the cursor to the right side of the ENTER NEW PASSWORD BOX and press the ► button to display the NEW PASSWORD AGAIN BOX, enter the same PASSWORD again.</p>	
<p>1.2-4 Move the cursor to the right side of the NEW PASSWORD AGAIN BOX and press the ► button and the NOTE NEW PASSWORD BOX will be displayed for about 20 seconds, please make note of the PASSWORD during this time. Pressing the ENTER button on the remote control or INPUT button on the projector will close the NOTE NEW PASSWORD BOX.</p>	
<ul style="list-style-type: none"> <li>• Please do not forget your PASSWORD.</li> </ul>	

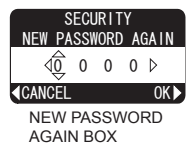
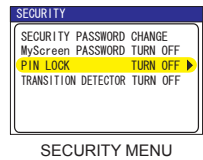

(continued on next page)



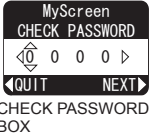
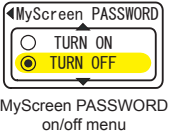

OPTION Menu (continued)

Item	Description
<p style="text-align: center;"><b>SECURITY</b></p>	<p><b>1.3 If you have forgotten your PASSWORD</b></p> <p>1.3-1 Follow the procedure in 1.1-1 to display the ENTER PASSWORD BOX.</p> <p>1.3-2 While the ENTER PASSWORD BOX is displayed, press and hold the RESET button on the remote control for about 3 seconds or press and hold the INPUT and ► buttons on the projector for about 3 seconds. The 10 digit Inquiring Code will be displayed. NOTE: If there is no key input for about 55 seconds while the Inquiring Code is displayed the menu will close. If necessary repeat the process from 1.3-1.</p> <p>1.3-3 Contact your dealer with the 10 digit Inquiring Code. Your PASSWORD will be sent after your user registration information is confirmed.</p>
	<p><b>2. Using the MyScreen PASSWORD Function</b></p> <p>The MyScreen PASSWORD function can be used to prohibit access to the MyScreen function and prevent the currently registered MyScreen image from being overwritten.</p> <p><b>2.1 Turning on the MyScreen PASSWORD Function</b></p> <p>2.1-1 Use the ▲/▼ buttons on the SECURITY menu to select MyScreen PASSWORD and press the ► button to display the MyScreen PASSWORD on/off menu.</p>
	<p><b>2.2 Setting the PASSWORD</b></p> <p>2.2-1 Display the MyScreen on/off menu using the procedure in 2.1-1.</p> <p>2.2-2 Use the ▲/▼ buttons on the MyScreen PASSWORD on/off menu to select TURN ON. The ENTER PASSWORD BOX (small) will be displayed.</p> <p>2.2-3 Use the ▲/▼/◀/▶ buttons to enter the PASSWORD. Move the cursor to the right side of the ENTER PASSWORD BOX (small) and press the ► button to display the CHECK PASSWORD BOX, enter the same PASSWORD again.</p>



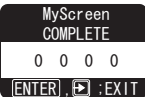

(continued on next page)

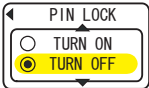
OPTION Menu (continued)

Item	Description
<p><b>SECURITY</b></p>	<p>2.2-4 Move the cursor to the right side of the CHECK PASSWORD BOX and press the ► button to display the PASSWORD for about 20 seconds, please make note of the PASSWORD during this time.</p>  <p>Pressing the ENTER button on the remote control or INPUT button on the projector will return to MyScreen PASS WORD on/off menu.</p> <p>When a PASSWORD is set for MyScreen:</p> <ul style="list-style-type: none"> <li>• The MyScreen registration function (and menu) will be unavailable.</li> <li>• The MyScreen Lock function (and menu) will be unavailable.</li> <li>• The START UP setting will be locked on MyScreen (and the menu will be unavailable).</li> </ul> <p>Turning the MyScreen PASSWORD off will allow normal operation of both functions.</p> <ul style="list-style-type: none"> <li>• Please do not forget your MyScreen PASSWORD.</li> </ul>
	<p><b>2.3 Turning the PASSWORD off</b></p>
	<p>2.3-1 Follow the procedure in 2.1-1 to display the MyScreen PASSWORD on/off menu.</p>
	<p>2.3-2 Select TURN OFF to display the ENTER PASSWORD BOX (large). Enter the registered PASSWORD and the screen will return to the MyScreen on/off menu.</p>
	<p>If an incorrect PASSWORD is input the menu will close. If necessary repeat the process from 2.3-1.</p>
<p><b>2.4 If you have forgotten your PASSWORD</b></p>	
<p>2.4-1 Follow the procedure in 2.1-1 to display the MyScreen PASSWORD on/off menu.</p>	
<p>2.4-2 Select TURN OFF to display the ENTER PASSWORD BOX (large). The 10 digit Inquiring Code will be displayed inside the BOX.</p> 	
<p>2.4-3 Contact your dealer with the 10 digit Inquiring Code. Your PASSWORD will be sent after your user registration information is confirmed.</p>	
<p><b>3. Using the PIN LOCK Function</b></p>	
<p>PIN LOCK is a function which prevents the projector from being used unless a registered Code is input.</p>	
<p><b>3.1 Registering the PIN Code</b></p>	
<p>3.1-1 Use the ▲/▼ buttons on the SECURITY menu to select PIN LOCK and press the ► button or the ENTER button to display the PIN LOCK on/off menu.</p> 	
<p>3.1-2 Use the ▲/▼ buttons on the PIN LOCK on/off menu to select TURN ON and the PIN BOX will be displayed.</p>	





(continued on next page)

**OPTION Menu (continued)**

Item	Description
<p><b>SECURITY</b></p>	<p>3.1-3 Input a 4 part PIN Code using the ▲/▼/◀/▶ /RGB and INPUT buttons. A CONFIRMATION BOX will appear. Reenter the same PIN Code. This will complete the PIN Code registration.</p> <p>NOTE: If there is no key input for about 55 seconds while the PIN BOX or the CONFIRMATION BOX are displayed the menu will close. If necessary repeat the process from 3.1-1.</p> <p>Afterwards, anytime the projector is restarted after the power switch is turned off the PIN BOX will be displayed. Enter the registered PIN Code. The projector can be used after entering the registered PIN Code. If an incorrect PIN Code is input the PIN BOX will be displayed again. If an incorrect PIN Code is input 3 times the projector will turn off. Afterwards the projector will turn off every time an incorrect PIN Code is input. The projector will also turn off if there is no key input for about 5 minutes while the PIN BOX is displayed. This function will activate only when the projector is started after the power switch was turned off.</p> <ul style="list-style-type: none"> <li>• Please do not forget your PIN Code.</li> </ul> <p><b>3.2 Turning Off the PIN LOCK Function</b></p> <p>3.2-1 Follow the procedure in 3.1-1 to display the PIN LOCK on/off menu. Use the ▲/▼ buttons to select TURN OFF and the PIN BOX will be displayed. Enter the registered PIN Code to turn the PIN LOCK function off. If an incorrect PASSWORD is entered the menu will close.</p> <p><b>3.3 If you have forgotten your PIN Code</b></p> <p>3.3-1 While the PIN BOX is displayed, press and hold the RESET button for three seconds or press and hold the INPUT and ► buttons for three seconds. The 10 digit Inquiring Code will be displayed.</p> <p>NOTE: If there is no key input for about 5 minutes while the Inquiring Code is displayed the projector will turn off.</p> <p>3.3-2 Contact your dealer with the 10 digit Inquiring Code. Your PASSWORD will be sent after your user registration information is confirmed.</p>
	 <p>PIN BOX Input PIN Code    - - - - ◀ ▶ ▲ ▼ RGB / ▶</p> <p>PIN BOX</p>
 <p>PIN BOX Confirmation    - - - - ◀ ▶ ▲ ▼ RGB / ▶</p> <p>CONFIRMATION BOX (PIN BOX)</p>	
 <p>PIN BOX Inquiring Code * * * * * * * * * *</p> <p>Inquiring Code (PIN Code)</p>	

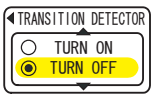
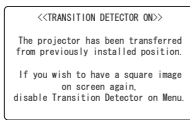
(continued on next page)

OPTION Menu (continued)

Item	Description
<p><b>SECURITY</b></p>	<p><b>4. Using the Transition Detector Function</b></p> <p>While the Transition Detector function is ON, when power switch is started to supply to the projector, it might react as below.</p> <ul style="list-style-type: none"> <li>• Transition Detector alarm shown below might appear on screen, if the projector has been moved or re-installed.</li> <li>• Transition Detector alarm might appear on screen, if the MIRROR setting has been changed.</li> <li>• Keystone adjustment feature has been prohibited as long as the Transition Detector function is ON.</li> </ul> <p><b>4.1 Turning On the Transition Detector Function</b></p> <p>4.1-1 Use the ▲/▼ buttons on the SECURITY menu to select Transition Detector and press the ► or the ENTER button to display the Transition Detector on/off menu. Select TURN ON and the current angle and mirror setting will be recorded.</p> <p>NOTE: This feature may not function properly if the projector is not in a stable position when TURN ON is selected.</p> <p>4.1-2 If this function is set to TURN ON when the vertical angle of the projector or mirror setting at which the projector is turned on is different than the previously recorded the Transition Detector Alarm will be displayed and the projector will not display the input signal.</p> <p>If the Transition Detector ALARM is displayed for about 5 minutes the lamp will turn off. This function will activate only when the projector is started after the power switch was turned off.</p> <p><b>4.2 Setting the Transition Detector PASSWORD</b></p> <p>4.2-1 Use the ▲/▼ buttons on the SECURITY menu to select Transition Detector and press the ► or the ENTER button to display the Transition Detector on/off menu.</p> <p>4.2-2 Use the ▲/▼ buttons on the Transition Detector on/off menu to select TURN ON. The ENTER PASSWORD BOX (small) will be displayed.</p> <p>4.2-3 Use the ▲/▼/◀/▶ buttons to enter a PASSWORD. Move the cursor to the right side of the ENTER PASSWORD BOX (small) and press the ► button to display the CHECK PASSWORD BOX, enter the same PASSWORD again.</p> <p>4.2-4 Move the cursor to the right side of the CHECK PASSWORD BOX and press the ► button to display the PASSWORD for about 20 seconds, please make note of the PASSWORD during this time.</p> <p>Pressing the ENTER button on the remote control or the INPUT button on the projector will return to the Transition Detector on/off menu.</p> <ul style="list-style-type: none"> <li>• Please do not forget your Transition Detector PASSWORD.</li> </ul>
	 <p>Transition Detector on/off menu</p>  <p>Transition Detector Alarm</p>  <p>ENTER PASSWORD BOX (small)</p>  <p>CHECK PASSWORD BOX</p>  <p>TRANSITION DETECTOR COMPLETE PASSWORD BOX</p>

(continued on next page)

**OPTION Menu (continued)**

Item	Description
<p><b>SECURITY</b></p>	<p><b>4.3 Setting the Transition Detector off</b></p> <p>4.3-1 Follow the procedure in 4.1-1 to display the Transition Detector on/off menu.</p> <p>4.3-2 Select TURN OFF to display the ENTER PASSWORD BOX (large). Enter the registered PASSWORD and the screen will return to the Transition Detector on/off menu. If an incorrect PASSWORD is input the menu will close. If necessary repeat the process from 4.3-1.</p> <p><b>4.4 If you have forgotten your PASSWORD</b></p> <p>4.4-1 Follow the procedure in 4.1-1 to display the Transition Detector on/off menu.</p> <p>4.4-2 Select TURN OFF to display the ENTER PASSWORD BOX (large). The 10 digit Inquiring Code will be displayed inside the BOX.</p> <p>4.4-3 Contact your dealer with the 10 digit Inquiring Code. Your PASSWORD will be sent after your user registration information is confirmed.</p>

NETWORK Menu



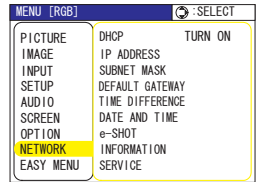

Consult with your network administrator before connecting to an existing access point on your network. Incorrect network settings on this projector may cause trouble on the network. Select "NETWORK" from the main menu to access the following functions.

Select an item using the ▲/▼ cursor buttons on the projector or remote control, and press the ► cursor button on the projector or remote control, or ENTER button on the remote control to execute the item. Then perform it according to the following table.



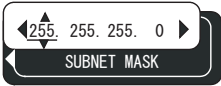

**NOTE** • The factory default setting for DHCP is "TURN ON". There is no need to set up [DHCP], [IP ADDRESS], [SUBNET MASK] or [DEFAULT GATEWAY] if your network has DHCP enabled. (📘 [User's Manual - Network Functions](#))

- If you are not utilizing SNTP (📘 [User's Manual - Network Functions](#)), then you must set the DATE AND TIME during the initial installation. Please refer to the item DATE AND TIME on the following list.

Item	Description
<b>DHCP</b> (Dynamic Host Configuration Protocol)	DHCP TURN ON/TURN OFF: Use the ▲/▼ buttons to turn DHCP on/off TURN ON ⇔ TURN OFF Select TURN OFF when the network does not have DHCP enabled. 
<b>IP ADDRESS</b>	Entering the IP ADDRESS : Use the ▲/▼/◀/▶ buttons to enter the IP ADDRESS. This function can only be used when DHCP is set to "TURN OFF".  <ul style="list-style-type: none"> <li>• The IP ADDRESS is the number that identifies this projector on the network. You cannot have two devices with the same IP ADDRESS on the same network.</li> </ul>
<b>SUBNET MASK</b>	Entering the SUBNET MASK : Use the ▲/▼/◀/▶ buttons to enter the same SUBNET MASK used by your PC. This function can only be used when DHCP is set to "TURN OFF". 
<b>DEFAULT GATEWAY</b>	Entering the DEFAULT GATEWAY : Use the ▲/▼/◀/▶ buttons to enter the DEFAULT GATEWAY (a node on a computer network that serves as an access point to another network) address. This function can only be used when DHCP is set to "TURN OFF". 

(continued on next page)

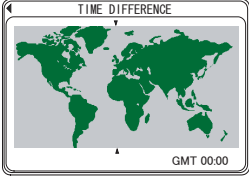
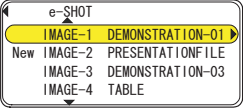
NETWORK Menu (continued)

Item	Description
<p><b>TIME DIFFERENCE</b></p>	<p>Entering the TIME DIFFERENCE :                      Use the ▲/▼ buttons to enter the TIME DIFFERENCE.                      Set the same TIME DIFFERENCE as the one set on your PC. If unsure, consult your network administrator.                      Use the ◀ button to return to the menu after setting the TIME DIFFERENCE.</p> 
<p><b>DATE AND TIME</b></p>	<p>Entering DATE AND TIME :                      Use the ▲/▼/◀/▶ buttons to enter the Year (last two digits), Month, Date, Hour and Minute.</p> <ul style="list-style-type: none"> <li>The projector will override this setting and retrieve DATE AND TIME information from the Timeserver when SNTP is enabled. See <b>[Date/ Time Settings]</b> in <b>[User's Manual - Network Functions: Configuring and Controlling the Projector via a Web Browser]</b> for SNTP settings.</li> </ul>
<p><b>e-SHOT</b></p>	<p>e-SHOT display :                      Use the ▲/▼ buttons to select an item and the ▶ or ENTER buttons to display the image.</p> <p>Image1                      Image2                      Image3                      Image4</p>  <p>File names of registered images are displayed by 16 characters or less. Example: DEMONSTRATION-01                      "NEW" stamp is added to the head of line when the image is registered newly. After the image is displayed, "NEW" stamp will be erased.</p> <p>Once an image is displayed, you can use the ▲/▼ buttons to page through the images. Use the ◀ or ESC buttons to return to the menu.</p> <p>Pressing the RESET button or the ▶ button for about 3 seconds while an image is being displayed will display the RESET menu. The displayed image can be deleted from the RESET menu using the ENTER button on the remote control or the INPUT button on the projector.</p> <p>If you do not wish to delete the image use the ESC button on the remote control or push the ◀ and INPUT buttons on the projector at the same time.</p> <ul style="list-style-type: none"> <li>Items with no image stored cannot be selected.</li> <li>Images can be changed using the ▲/▼ buttons while the image data downloads.</li> </ul>  

(continued on next page)

**NETWORK Menu (continued)**

Item	Description
<p><b>INFORMATION</b></p>	<p>INFORMATION display : Use the ► or ENTER buttons to view network information and confirm settings.</p> <div data-bbox="777 252 1021 395" style="border: 1px solid black; padding: 5px; margin: 10px 0;"> <p>◀ NETWORK-INFORMATION</p> <p>NAME</p> <p>IP ADDRESS 192.1.254</p> <p>SUBNETMASK 255.255.255.0</p> <p>DEFAULT_GATEWAY 0.0.0.0</p> <p>MAC_ADDRESS 00:00:87:56:AC:7C</p> <p>TIME_DIFFERENCE GMT +00:00</p> <p>DATE_AND_TIME 2000/1/1 8:15</p> </div> <ul style="list-style-type: none"> <li>• Only the first 16 characters of the projector name are displayed.</li> <li>• The battery for the built in clock may be dead if the clock loses time even when the DATE AND TIME have been set correctly. Replace the battery by following the instructions on replacing the battery. (📖60)</li> </ul>
<p><b>SERVICE</b></p>	<p>Choose the RESTART using the ► button.</p> <div data-bbox="542 600 717 671" style="border: 1px solid black; padding: 5px; margin: 10px 0;"> <p>◀ SERVICE</p> <p style="background-color: yellow; text-align: center;">▶ RESTART ▶</p> </div> <p>Then use the ▲ button to execute.</p> <div data-bbox="542 735 717 847" style="border: 1px solid black; padding: 5px; margin: 10px 0;"> <p>◀ RESTART</p> <p style="text-align: center;">▲ EXECUTE</p> <p style="background-color: yellow; text-align: center;">▶ CANCEL ▶</p> </div> <p>Network will be once cut off when choose restart. If DHCP is selected on, IP address may be changed. After selecting RESTART, Network menu may not be controlled approx. 20 seconds.</p>

**Network functions**

Refer to the separate volume on Network Functions.



## Maintenance

**Lamp**

A lamp has finite product life. Using the lamp for long periods of time could cause the pictures darker or the color tone poor. Note that each lamp has a different lifetime, and some may burst or burn out soon after you start using them. Preparation of a new lamp and early replacement are recommended. To prepare a new lamp, contact your dealer and tell the lamp type number.

**Type number = 456-8943**

**Replacing the lamp**

1. Turn the projector off, and unplug the power cord. Allow the projector to cool for at least 45 minutes.
  2. Prepare a new lamp.
- If the projector is mounted on a ceiling, or if the lamp has broken, also ask the dealer to replace the lamp.

**In case of replacement by yourself,**

3. Loosen the screw (marked by arrow) of the lamp cover and then slide the lamp cover to the side to remove it.
4. Loosen the 3 screws (marked by arrow) of the lamp, and slowly pick up the lamp by the handles.
5. Insert the new lamp, and retighten firmly the 3 screws of the lamp that are loosened in the previous process to lock it in place.
6. Slide the lamp cover back in place and firmly fasten the screw of the lamp cover.
7. Turn the projector on and reset the lamp time using the LAMP TIME item in the OPTION menu (43).

- (1) Press the MENU button to display a menu.
- (2) Point at the "Go to Advanced Menu ..." in the menu using the ▼/▲ button, then press the ► button.
- (3) Point at the "OPTION" in the left column of the menu using the ▼/▲ button, then press the ► button.
- (4) Point at the "LAMP TIME" using the ▼/▲ button, then press the ► button. A dialog will appear.
- (5) Press the ▲ button to select "RESET" on the dialog. It performs resetting the lamp time.

The lamp cover

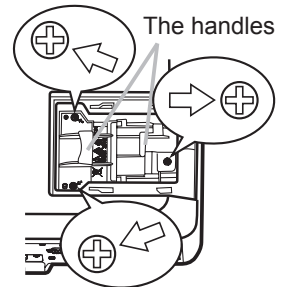
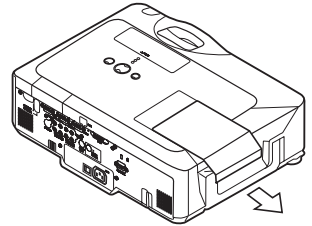
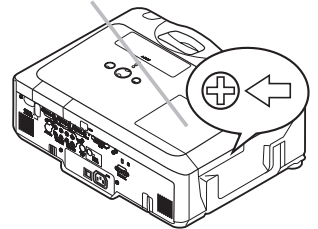

**NOTE** • Please reset the lamp time only when you have replaced the lamp, for a suitable indication about the lamp.

## Lamp (continued)

**WARNING**

HIGH VOLTAGE



HIGH TEMPERATURE



HIGH PRESSURE

► The projector uses a high-pressure mercury glass lamp. The lamp can break with a loud bang, or burn out, if jolted or scratched, handled while hot, or worn over time. Note that each lamp has a different lifetime, and some may burst or burn out soon after you start using them. In addition, when the bulb bursts, it is possible for shards of glass to fly into the lamp housing, and for gas containing mercury to escape from the projector's vent holes.

► **About disposal of a lamp** • This product contains a mercury lamp; do not put it in a trash. Dispose of it in accordance with environmental laws. For lamp recycling, go to [www.lamprecycle.org](http://www.lamprecycle.org). (in the US) For product disposal, contact your local government agency or [www.eiae.org](http://www.eiae.org) (in the US) or [www.epsc.ca](http://www.epsc.ca) (in Canada). For more information, call your dealer.



Disconnect the plug from the power outlet

- If the lamp should break (it will make a loud bang when it does), unplug the power cord from the outlet, and make sure to request a replacement lamp from your local dealer. Note that shards of glass could damage the inside of the projector, or cause injury during handling, so please do not try to clean the projector or replace the lamp yourself.
- If the lamp should break (it will make a loud bang when it does), ventilate the room well, and make sure not to breathe the gas that comes out of the projector vents, or get it in your eyes or mouth.
- Before replacing the lamp, turn the projector off and unplug the power cord, then wait at least 45 minutes for the lamp to cool sufficiently. Handling the lamp while hot can cause burns, as well as damaging the lamp.



- Never unscrew except the appointed (marked by an arrow) screws.
- Do not open the lamp cover while the projector is suspended from the ceiling. This is dangerous, since if the lamp's bulb has broken, the shards will fall out when the cover is opened. In addition, working in high places is dangerous, so ask your local dealer to have the lamp replaced even if the bulb is not broken.
- Do not use the projector with the lamp cover removed. To replace the lamp, make sure that the screws are tightened firmly. Loose screws could result in damage or injury.



- Use only the lamp of the specified type.
- If the lamp breaks soon after the first time it is used, it is possible that there are electrical problems elsewhere besides the lamp. If this happens, contact your local dealer or a service representative.
- Handle with care: jolting or scratching could cause the lamp bulb to burst during use.
- Using the lamp for long periods of time, could cause it dark, not to light up or to burst. When the pictures appear dark, or when the color tone is poor, please replace the lamp as soon as possible. Do not use old (used) lamps; this is a cause of breakage.

## Air filter

Please check and clean the air filter periodically. If the air filter becomes clogged by dust or the like, internal temperatures rise, which could cause a fire, a burn or malfunction to the projector. When the indicators or a message prompts you to clean the air filter, comply with it as soon as possible. Note that the projector may shut down, when the projector heats too much.

Please replace the air filter when it is damaged or too soiled. Preparation of a new air filter is recommended. To prepare a new air filter, contact with your dealer and tell the air filter type number.

**Type number = MU03642**

### Cleaning the air filter

1. Turn the projector off, and unplug the power cord. Allow the projector to sufficiently cool down.
2. Use a vacuum cleaner on and around the filter cover.
3. Hold the filter cover knobs while lifting it. The filter unit made up the filter cover and others will come off.
4. Use a vacuum cleaner for the filter vent of the projector and the filter frame side of the filter unit.  
If the air filter is damaged or too soiled, replace it according to the following procedure number 5 to 7. Otherwise, please jump to the procedure number 8.
5. To remove the filter frame, hold the filter cover while holding and pulling the filter frame's knob by another hand.
6. Replace the air filter with new one. It is recommended that the fluted surface of the air filter faces the filter cover.
7. Put the filter frame back.
8. Put the filter unit back into the projector.

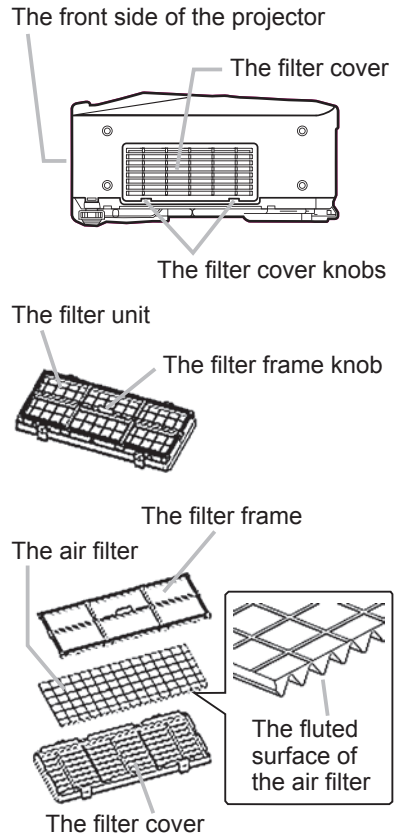

(continued on next page)

**Air filter (continued)**

9. Turn the projector on and reset the filter time using the FILTER TIME item in the EASY MENU (25).
- (1) Press the MENU button to display a menu.
  - (2) Point at the "FILTER TIME" using the ▼/▲ button, then press the ► button. A dialog will appear.
  - (3) Press the ▲ button to select "RESET" on the dialog. It performs resetting the filter time.

**⚠ WARNING ►** Before taking care of the air filter, make sure the power switch is off and the power cable is not plugged in, then allow the projector to cool sufficiently. Taking care of the air filter in a high temperature state of the projector could cause an electric shock, a burn or malfunction to the projector.

► Use only the air filter of the specified type. Do not use the projector without the air filter or the filter cover. It could result in a fire or malfunction to the projector.

► Clean the air filter periodically. If the air filter becomes clogged by dust or the like, internal temperatures rise and could cause a fire, a burn or malfunction to the projector.

**NOTE** • Please replace the air filter when it is damaged or too soiled, and also when you replace the lamp.

- When you replace the projection lamp, please replace the air filter. An air filter of specified type will come together with a replacement lamp for this projector.
- Please reset the filter time only when you have cleaned or replaced the air filter, for a suitable indication about the air filter.
- The projector may display the message such as "CHECK THE AIR FLOW" or turn off the projector, to prevent the internal heat level rising.

## Internal clock battery

Consumption of the battery makes the clock not to work correctly. When the clock is wrong or it has stopped, please replace the battery according to the following procedures.

1. Turn the projector off, and unplug the power cord. Allow the projector to cool sufficiently.
2. After making sure that the projector has cooled adequately, slowly turn over the projector, so that the bottom is facing.
3. Remove the battery cover. Turn the battery cover in the direction indicated "OPEN" using such as coins. Then the battery cover will come up. While removing the battery cover, pick its knob.
4. Take the old battery out. Press the metal claw of the battery holder. Then the battery will come up. Remove the battery.
5. Put a new battery in. **Replace battery with HITACHI MAXELL, Part No.CR2032 only. Use of another battery may present a risk of fire or explosion.** Insert a new battery in the battery holder according to its minus terminal ⊖ as indicated in the battery holder, so that the side marked by + is facing. And push the battery into the battery holder fully to fix.
6. Close the battery cover. Replace the battery cover in place, then turn it in the direction indicated "CLOSE" using such as coins, to fix.

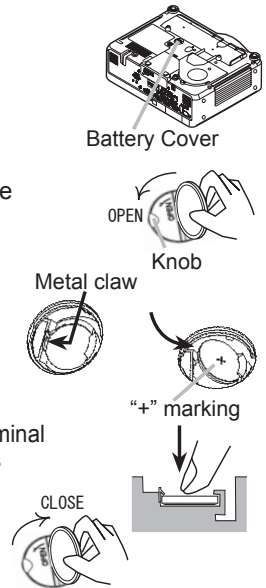

**⚠ WARNING** ► Always handle the batteries with care and use them only as directed. Battery may explode if mistreated. Do not recharge, disassemble or dispose of in fire.

And also improper use may result in cracking or leakage, which could result in fire, injury and/or pollution of the surrounding environment.

- Be sure to use only the batteries specified. Do not use batteries of different types at the same time. Do not mix a new battery with used one.
- Make sure the plus and minus terminals are correctly aligned when loading a battery. If the battery is placed in the battery holder upside-down, it may be hard to remove.
- Keep a battery away from children and pets. If swallowed consult a physician immediately for emergency treatment.
- Do not short circuit or solder a battery.
- Do not allow a battery in a fire or water. Keep batteries in a dark, cool and dry place.
- If you observe a leakage of a battery, wipe out the flower and then replace a battery. If the liquid adheres to your body or clothes, rinse well with water immediately.
- Obey the local laws on disposing the battery.

**NOTE** • If the battery is placed in the battery holder upside-down, follow the procedure below to remove and reload it properly.

1. Remove the battery cover as described in steps 1 through 3 above.
2. Turn the projector over again, so that the top of the projector is facing up.
3. While lifting the side of the projector closest to the lens, press the metal claw of the battery holder. The battery will fall out of the holder, so be careful not to lose it.
4. Turn the projector over once more, so that the bottom faces up, and reload the battery correctly.

• The internal clock's time will be reset when the battery is removed.

Please reconfigure the time via the menu or a web browser after replacing the battery.

(Please refer to [p.55](#) and User's Manual-Network Functions: Date/Time Settings for more information.)

## Other care

### Inside of the projector

In order to ensure the safe use of your projector, please have it cleaned and inspected by your dealer about once every year.

### Caring for the lens

If the lens is flawed, soiled or fogged, it could cause deterioration of display quality. Please take care of the lens, being cautious of handling.

1. Turn the projector off, and unplug the power cord. Allow the projector to cool sufficiently.
2. After making sure that the projector is cool adequately, lightly wipe the lens with a commercially available lens-cleaning wipe. Do not touch the lens directly with your hand.

### Caring for the cabinet and remote control

Incorrect care could have adverse influence such as discoloration, peeling paint, etc.

1. Turn the projector off, and unplug the power cord. Allow the projector to cool sufficiently.
2. After making sure that the projector is cool adequately, lightly wipe with gauze or a soft cloth.

If the projector is extremely dirty, dip soft cloth in water or a neutral cleaner diluted in water, and wipe lightly after wringing well. Then, wipe lightly with a soft, dry cloth.

**⚠WARNING** ► Before caring, make sure the power switch is off and the power cable is not plugged in, and then allow the projector to cool sufficiently. The care in a high temperature state of the projector could cause a burn and/or malfunction to the projector.

► Never try to care for the inside of the projector personally. Doing is so dangerous.

► Avoid wetting the projector or inserting liquids in the projector. It could result in a fire, an electric shock, and/or malfunction to the projector.

- Do not put anything containing water, cleaners or chemicals near the projector.

- Do not use aerosols or sprays.

**⚠CAUTION** ► Please take right care of the projector according to the following. Incorrect care could cause not only an injury but adverse influence such as discoloration, peeling paint, etc.

► Do not use cleaners or chemicals other than those specified in this manual.

► Do not polish or wipe with hard objects.

Troubleshooting

**Related messages**

When the unit's power is on, messages such as those shown below may be displayed. When any such message is displayed on the screen, please follow the instructions described below. If the same message is displayed after the remedy, or if a message other than the following appears, please contact your dealer or service company.

Although these messages will be automatically disappeared around several minutes, it will be reappeared every time the power is turned on.

Message	Description
<p><b>NO INPUT IS DETECTED</b> ***</p>	<p><b>There is no input signal.</b> Please confirm the signal input connection, and the status of the signal source.</p>
<p><b>SYNC IS OUT OF RANGE</b> *** fH **kHz V **Hz</p>	<p><b>The horizontal or vertical frequency of the input signal is not within the specified range.</b> Please confirm the specs for your projector or the signal source specs.</p>
<p><b>CHECK THE AIR FLOW</b></p>	<p><b>The internal temperature is rising.</b> Please turn the power off, and allow the projector to cool down at least 20 minutes. After having confirmed the following items, please turn the power ON again.</p> <ul style="list-style-type: none"> <li>• Is there blockage of the air passage aperture?</li> <li>• Is the air filter dirty?</li> <li>• Does the peripheral temperature exceed 35°C?</li> </ul> <p>If the same indication is displayed after the remedy, please set FAN SPEED of the SERVICE item in the OPTION menu to HIGH.</p>
<p><b>REMINDER</b> *** HRS PASSED AFTER THE LAST FILTER CHECK. FILTER MAINTENANCE IS ESSENTIAL TO REMOVE WARNING MESSAGE, RESET FILTER TIMER. SEE MANUAL FURTHER INFO.</p>	<p><b>A note of precaution when cleaning the air filter.</b> Please immediately turn the power off, and clean or change the air filter referring to the “Air Filter” section of this manual (458). After you have cleaned or changed the air filter, please be sure to reset the filter timer (443).</p>

## Regarding the indicator lamps

Lighting and flashing of the POWER indicator, the LAMP indicator, and the TEMP indicator have the meanings as described in the table below. Please follow the instructions within the table. If the same indication is displayed after the remedy, or if an indication other than the following is displayed, please contact your dealer or service company.

POWER indicator	LAMP indicator	TEMP indicator	Description
Lighting In <b>Orange</b>	Turned <b>off</b>	Turned <b>off</b>	<b>The projector is in a standby state.</b> Please refer to the section "Power On/Off".
<i>Blinking</i> In <b>Green</b>	Turned <b>off</b>	Turned <b>off</b>	<b>The projector is warming up.</b> Please wait.
Lighting In <b>Green</b>	Turned <b>off</b>	Turned <b>off</b>	<b>The projector is in an on state.</b> Ordinary operations may be performed.
<i>Blinking</i> In <b>Orange</b>	Turned <b>off</b>	Turned <b>off</b>	<b>The projector is cooling down.</b> Please wait.
<i>Blinking</i> In <b>Red</b>	(discretionary)	(discretionary)	<b>The projector is cooling down. A certain error has been detected.</b> Please wait until the POWER indicator finishes blinking, and then perform the proper measure using the item descriptions below.
<i>Blinking</i> In <b>Red</b> or Lighting In <b>Red</b>	Lighting In <b>Red</b>	Turned <b>off</b>	<b>The lamp does not light, and there is a possibility that interior portion has become heated.</b> Please turn the power off, and allow the projector to cool down at least 20 minutes. After the projector has sufficiently cooled down, please make confirmation of the following items, and then turn the power on again. <ul style="list-style-type: none"> <li>• Is there blockage of the air passage aperture?</li> <li>• Is the air filter dirty?</li> <li>• Does the peripheral temperature exceed 35°C?</li> </ul> If the same indication is displayed after the remedy, please change the lamp referring to the section "Lamp".
<i>Blinking</i> In <b>Red</b> or Lighting In <b>Red</b>	<i>Blinking</i> In <b>Red</b>	Turned <b>off</b>	<b>The lamp cover has not been properly fixed.</b> Please turn the power off, and allow the projector to cool down at least 45 minutes. After the projector has sufficiently cooled down, please make confirmation of the attachment state of the lamp cover. After performing any needed maintenance, turn the power on again. If the same indication is displayed after the remedy, please contact your dealer or service company.



**Regarding the indicator lamps (continued)**

POWER indicator	LAMP indicator	TEMP indicator	Description
<i>Blinking In Red or Lighting In Red</i>	Turned off	<i>Blinking In Red</i>	<b>The cooling fan is not operating.</b> Please turn the power off, and allow the projector to cool down at least 20 minutes. After the projector has sufficiently cooled down, please make confirmation that no foreign matter has become caught in the fan, etc., and then turn the power on again. If the same indication is displayed after the remedy, please contact your dealer or service company.
<i>Blinking In Red or Lighting In Red</i>	Turned off	Lighting In Red	<b>There is a possibility that the interior portion has become heated.</b> Please turn the power off, and allow the projector to cool down at least 20 minutes. After the projector has sufficiently cooled down, please make confirmation of the following items, and then turn the power on again. <ul style="list-style-type: none"> <li>• Is there blockage of the air passage aperture?</li> <li>• Is the air filter dirty?</li> <li>• Does the peripheral temperature exceed 35°C?</li> </ul> If the same indication is displayed after the remedy, please set FAN SPEED of the SERVICE item in the OPTION menu to HIGH.
Lighting In Green	Simultaneous <i>blinking in Red</i>		<b>It is time to clean the air filter.</b> Please immediately turn the power off, and clean or change the air filter referring to the section "Air Filter". After cleaning or changing the air filter, please be sure to reset the filter timer. After the remedy, reset the power to ON.
Lighting In Green	Alternative <i>blinking in Red</i>		<b>There is a possibility that the interior portion has become overcooled.</b> Please use the unit within the usage temperature parameters (5°C to 35°C). After the treatment, reset the power to ON.
<i>Blinking in Green for approx. 3 seconds</i>	Turned off	Turned off	<b>At least 1 "Power ON" schedule is saved to the projector.</b> (Please refer to the User's Manual-Network Functions: Schedule Settings for more information.)

**NOTE** • When the interior portion has become overheated, for safety purposes, the power source is automatically turned off, and the indicator lamps may also be turned off. In such a case, press the "O" (OFF) side of the power switch, and wait at least 45 minutes. After the projector has sufficiently cooled down, please make confirmation of the attachment state of the lamp and lamp cover, and then turn the power on again.

## Phenomena that may be easy to be mistaken for machine defects

**⚠WARNING** ▶ Never use the projector if abnormal operations such as smoke, strange odor, excessive sound, damaged casing or elements or cables, penetration of liquids or foreign matter, etc. should occur. In such cases, immediately turn off the power switch and then disconnect the power plug from the power outlet. After making sure that the smoke or odor has stopped, contact your dealer or service company.

1. Before requesting repair, please check in accordance with the following chart. This operation sometimes resolves your problem.

If the situation cannot be corrected,

2. The projector's microprocessor may need to be reset. Please push the Shutdown switch by using a pin or similar and the projector will be turned off immediately.

Before turning it again, wait at least 10 minutes to make the projector cool down enough.

3. Some setting may be wrong. Please use the FACTORY RESET function of the SERVICE item in the OPTION menu (▶46) to reset all settings to factory default. Then, if the problem is not removed after the remedy, please contact your dealer or service company.

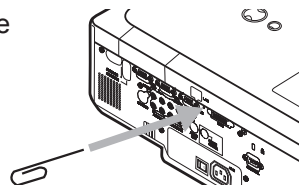

Phenomenon	Cases not involving a machine defect	Reference page
Power does not come on.	<b>The electrical power cord is not plugged in.</b> Correctly connect the power cord.	12
	<b>The power switch is not set to the on position.</b> Set the power switch to [   ] (On).	16
	<b>The main power source has been interrupted during operation such as by a power outage (blackout), etc.</b> Please turn the power off, and allow the projector to cool down at least 2 minutes, then turn the power on again.	16
	<b>Either there is no lamp and/or lamp cover, or either of these has not been properly fixed.</b> Please turn the power off, and allow the projector to cool down at least 45 minutes. After the projector has sufficiently cooled down, please make confirmation of the attachment state of the lamp and lamp cover, and then turn the power on again.	56
Neither sounds nor pictures are outputted.	<b>The signal cables are not correctly connected.</b> Correctly connect the connection cables.	10
	<b>Signal source does not correctly work.</b> Correctly set up the signal source device by referring to the manual of the source device.	—
	<b>The input changeover settings are mismatched.</b> Select the input signal, and correct the settings.	17, 18

**Phenomena that may be easy to be mistaken for machine defects (continued)**

Phenomenon	Cases not involving a machine defect	Reference page
Sound does not come out.	<b>The signal cables are not correctly connected.</b> Correctly connect the audio cables.	10
	<b>The MUTE function is working.</b> Restore the sound pressing the MUTE or VOLUME button on the remote control.	17
	<b>The volume is adjusted to an extremely low level.</b> Adjust the volume to a higher level using the menu function or the remote control.	17
	<b>The AUDIO setting is not correct.</b> Correctly set the items in the AUDIO menu.	37
No pictures are displayed.	<b>The lens cap is attached.</b> Remove the lens cover.	4, 16
	<b>The signal cables are not correctly connected.</b> Correctly connect the connection cables.	10
	<b>The brightness is adjusted to an extremely low level.</b> Adjust BRIGHTNESS to a higher level using the menu function or the remote control.	24, 26
	<b>The computer cannot detect the projector as a plug and play monitor.</b> Make sure that the computer can detect a plug and play monitor using another plug and play monitor.	11
	<b>The BLANK screen is displayed.</b> Press the BLANK button on the remote control.	22
Video screen display freezes.	<b>The FREEZE function is working.</b> Press the FREEZE button to restore the screen to normal.	21
Colors have a faded- out appearance, or Color tone is poor.	<b>Color settings are not correctly adjusted.</b> Perform picture adjustments by changing the COLOR TEMP, COLOR, TINT and/or COLOR SPACE settings, using the menu functions.	25, 27, 31
	<b>COLOR SPACE setting is not suitable.</b> Change the COLOR SPACE setting to AUTO, RGB, SMPTE240, REC709 or REC601.	31

**Phenomena that may be easy to be mistaken for machine defects (continued)**

Phenomenon	Cases not involving a machine defect	Reference page
Pictures appear dark.	<b>The brightness and/or contrast are adjusted to an extremely low level.</b> Adjust BRIGHTNESS and/or CONTRAST settings to a higher level using the menu function.	24, 25, 26
	<b>The WHISPER function is working.</b> Select NORMAL for the WHISPER item in the SETUP menu.	25, 36
	<b>The lamp is approaching the end of its product lifetime.</b> Replace the lamp.	56, 57
Pictures appear blurry.	<b>Either the focus and/or horizontal phase settings are not properly adjusted.</b> Adjust the focus using the focus ring, and/or H PHASE using the menu function.	19, 30
	<b>The lens is dirty or misty.</b> Clean the lens referring to the section "Caring for the lens".	61
Pictures are trembling.	<b>The exhaust ventilation holes at front is blocked by some objects.</b> Remove any objects from front side of the projector.	4

**NOTE** • Although bright spots or dark spots may appear on the screen, this is a unique characteristic of liquid crystal displays, and it does not constitute or imply a machine defect.

## Warranty and after-service

If a problem occurs with the equipment, first refer to the “Troubleshooting” and run through the suggested checks. If this does not resolve the problem, please contact your dealer or service company. They will tell you what warranty condition is applied.

## Specification

Item		Specification
Product name		Liquid crystal projector
Liquid Crystal Panel	Panel size	2.0 cm (0.79 type)
	Drive system	TFT active matrix
	Pixels	786,432 pixels (1024 horizontal x 768 vertical)
Lens		Zoom lens F=1.7 ~ 2.1 f=24 ~ 29 mm
Lamp		285W UHB
Speaker		4W x 4
Power supply		AC 100-120V/5.0A, AC220-240V/2.1A
Power consumption		460W
Temperature range		5 ~ 35°C (Operating)
Size		418 (W) x 139 (H) x 319 (D) mm (Not including protruding parts) * Please refer to the following figure.
Weight (mass)		7.1 kg
Ports		<b>RGB input port</b> RGB1.....D-sub 15pin mini x1 RGB2.....D-sub 15pin mini x1 <b>RGB output port</b> RGB OUT..D-sub 15pin mini x1 <b>Digital input port</b> M1-D.....M1-D x1 <b>Video input port</b> Y, CB/PB, CR/PR ..... RCA x3 S-VIDEO .....S-video x1 VIDEO .....Video x1 <b>Audio input port</b> AUDIO IN1 .....Stereo mini x1 AUDIO IN2 .....Stereo mini x1 AUDIO IN3 ..... RCA x2 AUDIO IN4 ..... RCA x2 <b>Communication port</b> CONTROL..... D-sub 9pin x1 <b>Other ports</b> NETWORK.....RJ45 x1 REMOTE CONTROL .....Stereo mini x1
Optional parts	Lamp	456-8943
	Air filter	MU03642
	Others	* Please consult your dealer.

**NOTE** • These specifications are subject to change without notice.

Specifications (continued)

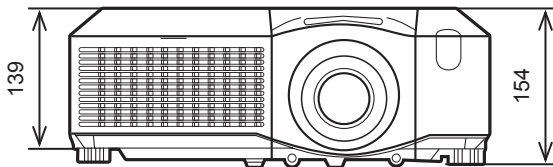
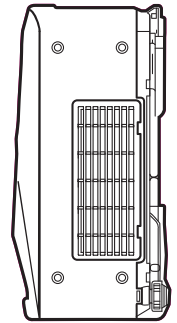
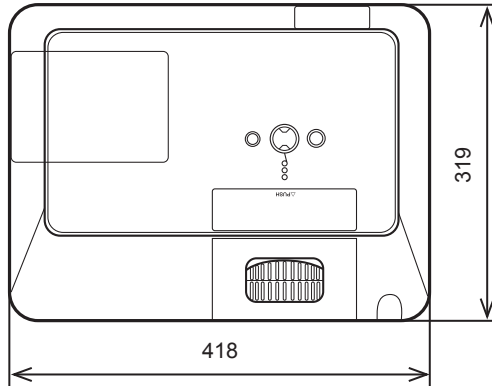
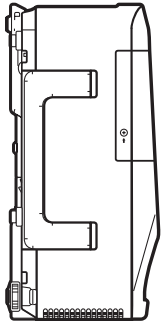
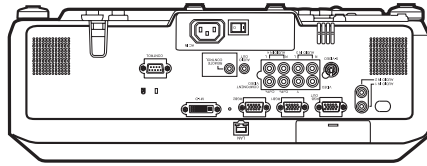

[unit: mm]

## Projector

# 8918/8943

## User's Manual – Operating Guide

### Technical

#### Example of computer signal

Resolution (H x V)	H. frequency (kHz)	V. frequency (Hz)	Rating	Signal mode
720 x 400	37.9	85.0	VESA	TEXT
640 x 480	31.5	59.9	VESA	VGA (60Hz)
640 x 480	37.9	72.8	VESA	VGA (72Hz)
640 x 480	37.5	75.0	VESA	VGA (75Hz)
640 x 480	43.3	85.0	VESA	VGA (85Hz)
800 x 600	35.2	56.3	VESA	SVGA (56Hz)
800 x 600	37.9	60.3	VESA	SVGA (60Hz)
800 x 600	48.1	72.2	VESA	SVGA (72Hz)
800 x 600	46.9	75.0	VESA	SVGA (75Hz)
800 x 600	53.7	85.1	VESA	SVGA (85Hz)
832 x 624	49.7	74.5		Mac 16" mode
1024 x 768	48.4	60.0	VESA	XGA (60Hz)
1024 x 768	56.5	70.1	VESA	XGA (70Hz)
1024 x 768	60.0	75.0	VESA	XGA (75Hz)
1024 x 768	68.7	85.0	VESA	XGA (85Hz)
1152 x 864	67.5	75.0	VESA	1152 x 864 (75Hz)
1280 x 960	60.0	60.0	VESA	1280 x 960 (60Hz)
1280 x 1024	64.0	60.0	VESA	SXGA (60Hz)
1280 x 1024	80.0	75.0	VESA	SXGA (75Hz)
1280 x 1024	91.1	85.0	VESA	SXGA (85Hz)
1600 x 1200	75.0	60.0	VESA	UXGA (60Hz)
1280 x 768	47.7	60.0	VESA	W-XGA (60Hz)
1400 x 1050	65.2	60.0	VESA	SXGA+ (60Hz)

- NOTE**
- Be sure to check jack type, signal level, timing and resolution before connecting this projector to a computer.
  - Some computers may have multiple display screen modes. Use of some of these modes will not be possible with this projector.
  - Depending on the input signal, full-size display may not be possible in some cases. Refer to the number of display pixels above.
  - Although the projector can display signals with resolution up to UXGA (1600x1200), the signal will be converted to the projector's panel resolution before being displayed. The best display performance will be achieved if the resolutions of the input signal and projector panel are identical.
  - Automatically adjustment may not function correctly with some input signals.
  - The image may not be displayed correctly when the input sync signal is a composite sync or a sync on G.

## Initial set signals

The following signals are used for the initial settings. The signal timing of some computer models may be different. In such case, adjust the items V POSITION and H POSITION in the IMAGE menu.

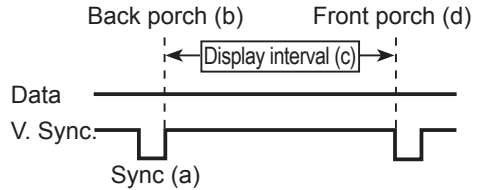
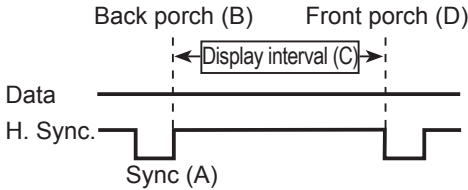

Computer/ Signal	Horizontal signal timing (µs)			
	(A)	(B)	(C)	(D)
TEXT	2.0	3.0	20.3	1.0
VGA (60Hz)	3.8	1.9	25.4	0.6
VGA (72Hz)	1.3	4.1	20.3	0.8
VGA (75Hz)	2.0	3.8	20.3	0.5
VGA (85Hz)	1.6	2.2	17.8	1.6
SVGA (56Hz)	2.0	3.6	22.2	0.7
SVGA (60Hz)	3.2	2.2	20.0	1.0
SVGA (72Hz)	2.4	1.3	16.0	1.1
SVGA (75Hz)	1.6	3.2	16.2	0.3
SVGA (85Hz)	1.1	2.7	14.2	0.6
Mac 16" mode	1.1	3.9	14.5	0.6
XGA (60Hz)	2.1	2.5	15.8	0.4
XGA (70Hz)	1.8	1.9	13.7	0.3
XGA (75Hz)	1.2	2.2	13.0	0.2
XGA (85Hz)	1.0	2.2	10.8	0.5
1152 x 864 (75Hz)	1.2	2.4	10.7	0.6
1280 x 960 (60Hz)	1.0	2.9	11.9	0.9
SXGA (60Hz)	1.0	2.3	11.9	0.4
SXGA (75Hz)	1.1	1.8	9.5	0.1
SXGA (85Hz)	1.0	1.4	8.1	0.4
UXGA (60Hz)	1.2	1.9	9.9	0.4
W-XGA (60Hz)	1.7	2.5	16.0	0.8
SXGA+ (60Hz)	1.2	2.0	11.4	0.7

Computer/ Signal	Vertical signal timing (lines)			
	(a)	(b)	(c)	(d)
TEXT	3	42	400	1
VGA (60Hz)	2	33	480	10
VGA (72Hz)	3	28	480	9
VGA (75Hz)	3	16	480	1
VGA (85Hz)	3	25	480	1
SVGA (56Hz)	2	22	600	1
SVGA (60Hz)	4	23	600	1
SVGA (72Hz)	6	23	600	37
SVGA (75Hz)	3	21	600	1
SVGA (85Hz)	3	27	600	1
Mac 16" mode	3	39	624	1
XGA (60Hz)	6	29	768	3
XGA (70Hz)	6	29	768	3
XGA (75Hz)	3	28	768	1
XGA (85Hz)	3	36	768	1
1152 x 864 (75Hz)	3	32	864	1
1280 x 960 (60Hz)	3	36	960	1
SXGA(60Hz)	3	38	1024	1
SXGA (75Hz)	3	38	1024	1
SXGA (85Hz)	3	44	1024	1
UXGA (60Hz)	3	46	1200	1
W-XGA (60Hz)	3	23	768	1
SXGA+ (60Hz)	3	33	1050	1



## Connection to the ports

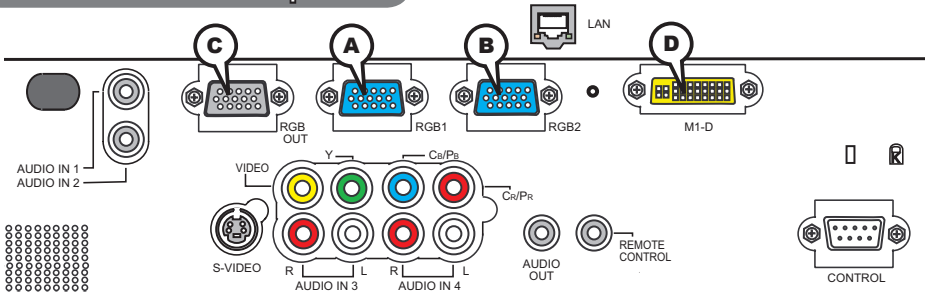

### Ⓐ RGB IN1, Ⓑ RGB IN2, Ⓒ RGB OUT

D-sub 15pin mini shrink jack

- Video signal: RGB separate, Analog, 0.7Vp-p, 75Ω terminated (positive)
- H/V. sync. Signal: TTL level (positive/negative)
- Composite sync. Signal: TTL level

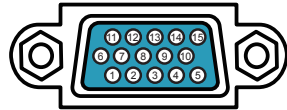

At RGB signal

Pin	Signal	Pin	Signal
1	Video Red	9	(No connection)
2	Video Green	10	Ground
3	Video Blue	11	(No connection)
4	(No connection)	12	Ⓐ: SDA (DDC data), Ⓑ/Ⓒ : (No connection)
5	Ground	13	H. sync / Composite sync.
6	Ground Red	14	V. sync.
7	Ground Green	15	Ⓐ: SCL (DDC clock), Ⓑ/Ⓒ : (No connection)
8	Ground Blue		

### Ⓓ M1-D

- Type: T.M.D.S
- Amplitude differential: DC 150-1200mV/AC 1.56 Vp-p
- Amplitude: TTL level (positive/negative)

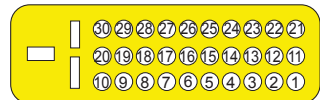

Pin	Signal	Pin	Signal	Pin	Signal
1	T.M.D.S. Data2 +	11	T.M.D.S. Data1 +	21	T.M.D.S. Data0 +
2	T.M.D.S. Data2 -	12	T.M.D.S. Data1 -	22	T.M.D.S. Data0 -
3	T.M.D.S. Data2 Return	13	T.M.D.S. Data1 Return	23	T.M.D.S. Data0 Return
4	T.M.D.S. Clock Return	14	T.M.D.S. Clock +	24	USB +5V DC Input
5	(No connection)	15	T.M.D.S. Clock -	25	DDC & USB Return
6	V.Sync.	16	USB Data +	26	DDC Data (SDA)
7	(No connection)	17	USB Data -	27	DDC Clock (SCL)
8	Hot Plug Detect (+5V DC Output)	18	(No connection)	28	DDC +5V DC Input
9	(No connection)	19	(No connection)	29	(No connection)
10	(No connection)	20	(No connection)	30	(No connection)

## Connection to the ports (continued)

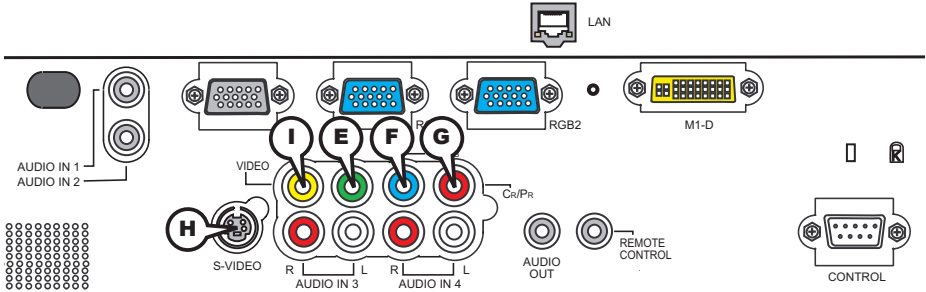

### COMPONENT VIDEO (E)Y, (F)CB/PB, (G)CR/PR

RCA jack x3

- System: 525i(480i), 525p(480p), 625i(576i), 750p(720p), 1125i(1080i)

Port	Signal
Y	Component video Y, $1.0 \pm 0.1V_{p-p}$ , $75\Omega$ terminator with composite
CB/PB	Component video CB/PB, $0.7 \pm 0.1V_{p-p}$ , $75\Omega$ terminator
CR/PR	Component video CR/PR, $0.7 \pm 0.1V_{p-p}$ , $75\Omega$ terminator

### (H)S-VIDEO

Mini DIN 4pin jack



Pin	Signal
1	Color signal $0.286V_{p-p}$ (NTSC, burst), $75\Omega$ terminator Color signal $0.300V_{p-p}$ (PAL/SECAM, burst) $75\Omega$ terminator
2	Brightness signal, $1.0V_{p-p}$ , $75\Omega$ terminator
3	Ground
4	Ground

### (I)VIDEO

RCA jack

- System: NTSC, PAL, SECAM, PAL-M, PAL-N, NTSC4.43
- $1.0 \pm 0.1V_{p-p}$ ,  $75\Omega$  terminator

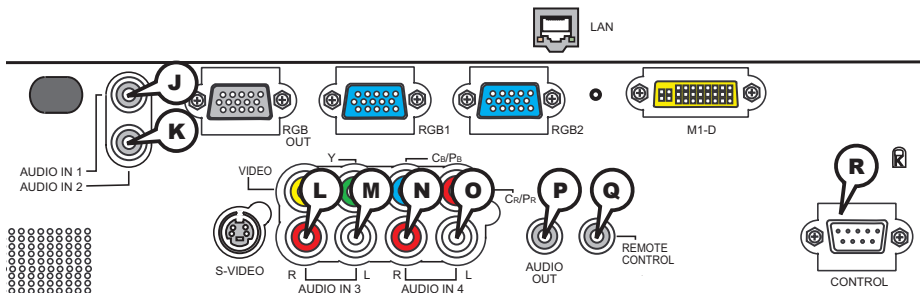

**J AUDIO IN 1, K AUDIO IN 2**

Ø3.5 stereo mini jack

- 500 mVrms 47kΩ terminator

**AUDIO IN 3 (L,R), (M), AUDIO IN 4 (N,R), (O)L**

RCA jack x2

- 500 mVrms 47kΩ terminator

**P AUDIO OUT**

Ø3.5 stereo mini jack

- 500 mVrms 1kΩ output impedance

**Q REMOTE CONTROL**

Ø3.5 stereo mini jack

- To be connected with the remote control that came with the projector.

**R CONTROL**

D-sub 9pin plug

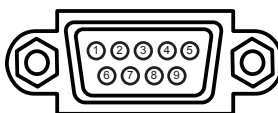

• About the details of RS-232C communication, please refer to the following page.

Pin	Signal	Pin	Signal	Pin	Signal
1	(No connection)	4	(No connection)	7	RTS
2	RD	5	Ground	8	CTS
3	TD	6	(No connection)	9	(No connection)

## Connection to the ports (continued)

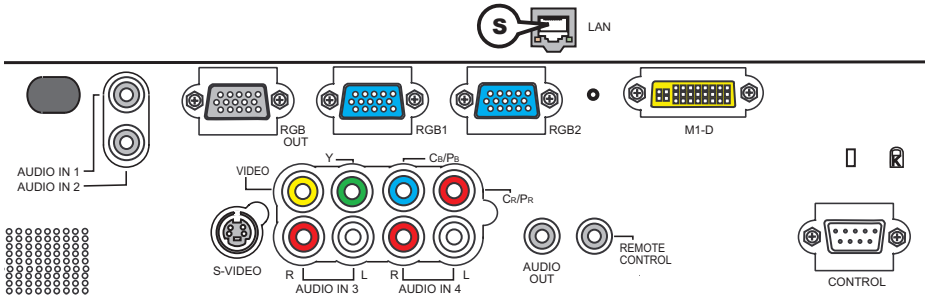

### **S** LAN

RJ-45 jack

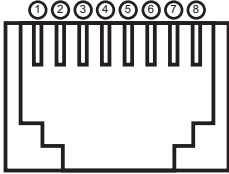

Pin	Signal	Pin	Signal	Pin	Signal
1	TX+	4	-	7	-
2	TX-	5	-	8	-
3	RX+	6	RX-		

## RS-232C Communication

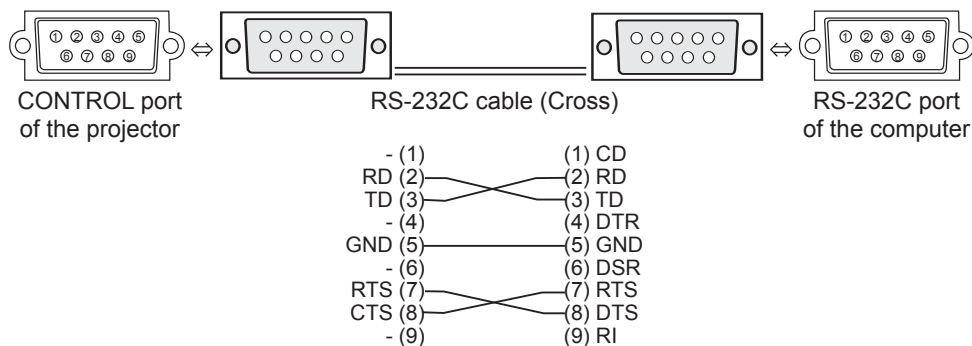

## Connecting the cable

1. Turn off the projector and the computer.
2. Connect the CONTROL port of the projector with a RS-232C port of the computer by a RS-232C cable (cross). Use the cable that fulfills the specification shown in the previous page.
3. Turn the computer on, and after the computer has started up turn the projector on.

## Communications setting

19200bps, 8N1

### 1. Protocol

Consist of header (7 bytes) + command data (6 bytes).

### 2. Header

BE + EF + 03 + 06 + 00 + CRC\_low + CRC\_high

CRC\_low : Lower byte of CRC flag for command data

CRC\_high : Upper byte of CRC flag for command data

### 3. Command data

Command data chart

byte_0	byte_1	byte_2	byte_3	byte_4	byte_5
Action		Type		Setting code	
low	high	low	high	low	high

Action (byte\_0 - 1)

Action	Classification	Content
1	SET	Change setting to desired value.
2	GET	Read projector internal setup value.
4	INCREMENT	Increment setup value by 1.
5	DECREMENT	Decrement setup value by 1.
6	EXECUTE	Run a command.

### Requesting projector status (Get command)

- (1) Send the request code Header + Command data ('02H'+ '00H'+ type (2 bytes)+ '00H' + '00H') from the computer to the projector.
- (2) The projector returns the response code '1DH'+ data (2 bytes) to the computer.

### Changing the projector settings (Set command)

- (1) Send the setting code Header + Command data ('01H'+ '00H'+ type (2 bytes) + setting code (2 bytes)) from the computer to the projector.
- (2) The projector changes the setting based on the above setting code.
- (3) The projector returns the response code '06H' to the computer.

### Using the projector default settings (Reset Command)

- (1) The computer sends the default setting code Header + Command data ('06H'+ '00H' + type (2 bytes) + '00H'+ '00H') to the projector.
- (2) The projector changes the specified setting to the default value.
- (3) The projector returns the response code '06H' to the computer.

### Increasing the projector setting value (Increment command)

- (1) The computer sends the increment code Header + Command data ('04H'+ '00H'+ type (2 bytes) + '00H'+ '00H') to the projector.
- (2) The projector increases the setting value on the above setting code.
- (3) The projector returns the response code '06H' to the computer.

### Decreasing the projector setting value (Decrement command)

- (1) The computer sends the decrement code Header + Command data ('05H'+ '00H'+ type (2 bytes) + '00H' + '00H') to the projector.
- (2) The projector decreases the setting value on the above setting code.
- (3) The projector returns the response code '06H' to the computer.

### When the projector cannot understand the received command

When the projector cannot understand the received command, the error code '15H' is sent back to the computer.

Sometimes the projector cannot properly receive the command. In such a case, the command is not executed and the error code '15H' is sent back to the computer. If this error code is returned, send the same command again.

### When the projector cannot execute the received command.

When the projector cannot execute the received command, the error code '1CH' + 'xxxxH' is sent back to the computer. When the data length is greater than indicated by the data length code, the projector ignore the excess data code.

Conversely when the data length is shorter than indicated by the data length code, an error code will be returned to the computer.

**NOTE** • Operation cannot be guaranteed when the projector receives an undefined command or data.

- Provide an interval of at least 40ms between the response code and any other code.
- The projector outputs test data when the power supply is switched ON, and when the lamp is lit. Ignore this data.
- Commands are not accepted during warm-up.

**RS-232C Communication (continued)**

Names	Operation Type	Header				Command Data			
						CRC	Action	Type	Setting Code
Power	Set	Turn off	BE EF	03	06 00	2A D3	01 00	00 60	00 00
		Turn on	BE EF	03	06 00	BA D2	01 00	00 60	01 00
	Get		BE EF	03	06 00	19 D3	02 00	00 60	00 00
		[Example return]	00 00 [Off]	01 00 [On]	02 00 [Cool down]				
Input Source	Set	RGB1	BE EF	03	06 00	FE D2	01 00	00 20	00 00
		RGB2	BE EF	03	06 00	3E D0	01 00	00 20	04 00
		M1-D	BE EF	03	06 00	0E D2	01 00	00 20	03 00
		VIDEO	BE EF	03	06 00	6E D3	01 00	00 20	01 00
		S-VIDEO	BE EF	03	06 00	9E D3	01 00	00 20	02 00
		COMPONENT	BE EF	03	06 00	AE D1	01 00	00 20	05 00
	Get	BE EF	03	06 00	CD D2	02 00	00 20	00 00	
Error Status	Get		BE EF	03	06 00	D9 D8	02 00	20 60	00 00
		[Example return]	00 00 [Normal]	01 00 [Cover error]	02 00 [Fan error]	03 00 [Lamp error]			
			04 00 [Temp error]	05 00 [Air flow error]	06 00 [Lamp time error]	07 00 [Cool error]			
			08 00 [Filter error]						
BRIGHTNESS	Get		BE EF	03	06 00	89 D2	02 00	03 20	00 00
		Increment	BE EF	03	06 00	EF D2	04 00	03 20	00 00
		Decrement	BE EF	03	06 00	3E D3	05 00	03 20	00 00
BRIGHTNESS Reset	Execute	BE EF	03	06 00	58 D3	06 00	00 70	00 00	
CONTRAST	Get		BE EF	03	06 00	FD D3	02 00	04 20	00 00
		Increment	BE EF	03	06 00	9B D3	04 00	04 20	00 00
		Decrement	BE EF	03	06 00	4A D2	05 00	04 20	00 00
CONTRAST Reset	Execute	BE EF	03	06 00	A4 D2	06 00	01 70	00 00	
PICTURE MODE	Set	NORMAL	BE EF	03	06 00	23 F6	01 00	BA 30	00 00
		CINEMA	BE EF	03	06 00	B3 F7	01 00	BA 30	01 00
		DYNAMIC	BE EF	03	06 00	E3 F4	01 00	BA 30	04 00
		BOARD(BLACK)	BE EF	03	06 00	E3 EF	01 00	BA 30	20 00
		BOARD(GREEN)	BE EF	03	06 00	73 EE	01 00	BA 30	21 00
		WHITEBOARD	BE EF	03	06 00	83 EE	01 00	BA 30	22 00
	Get	BE EF	03	06 00	10 F6	02 00	BA 30	00 00	
		[Example return]	00 00 [Normal]	01 00 [Cinema]	04 00 [Dynamic]	10 00 [Custom]			
			20 00 [BOARD(BLACK)]	21 00 [BOARD(GREEN)]	22 00 [WHITEBOARD]				
GAMMA	Set	#1 DEFAULT	BE EF	03	06 00	07 E9	01 00	A1 30	20 00
		#1 CUSTOM	BE EF	03	06 00	07 FD	01 00	A1 30	10 00
		#2 DEFAULT	BE EF	03	06 00	97 E8	01 00	A1 30	21 00
		#2 CUSTOM	BE EF	03	06 00	97 FC	01 00	A1 30	11 00
		#3 DEFAULT	BE EF	03	06 00	67 E8	01 00	A1 30	22 00
		#3 CUSTOM	BE EF	03	06 00	67 FC	01 00	A1 30	12 00
		#4 DEFAULT	BE EF	03	06 00	F7 E9	01 00	A1 30	23 00
		#4 CUSTOM	BE EF	03	06 00	F7 FD	01 00	A1 30	13 00
		#5 DEFAULT	BE EF	03	06 00	C7 EB	01 00	A1 30	24 00
		#5 CUSTOM	BE EF	03	06 00	C7 FF	01 00	A1 30	14 00
	Get	BE EF	03	06 00	F4 F0	02 00	A1 30	00 00	

## RS-232C Communication (continued)

Names	Operation Type	Header				Command Data			
						CRC	Action	Type	Setting Code
User Gamma Pattern	Set	Off	BE EF	03	06 00	FB FA	01 00	80 30	00 00
		9 step gray scale	BE EF	03	06 00	6B FB	01 00	80 30	01 00
		15 steps gray scale	BE EF	03	06 00	9B FB	01 00	80 30	02 00
		Ramp	BE EF	03	06 00	0B FA	01 00	80 30	03 00
	Get	BE EF	03	06 00	C8 FA	02 00	80 30	00 00	
User Gamma Point 1	Get	BE EF	03	06 00	08 FE	02 00	90 30	00 00	
	Increment	BE EF	03	06 00	6E FE	04 00	90 30	00 00	
	Decrement	BE EF	03	06 00	BF FF	05 00	90 30	00 00	
User Gamma Point 2	Get	BE EF	03	06 00	F4 FF	02 00	91 30	00 00	
	Increment	BE EF	03	06 00	92 FF	04 00	91 30	00 00	
	Decrement	BE EF	03	06 00	43 FE	05 00	91 30	00 00	
User Gamma Point 3	Get	BE EF	03	06 00	B0 FF	02 00	92 30	00 00	
	Increment	BE EF	03	06 00	D6 FF	04 00	92 30	00 00	
	Decrement	BE EF	03	06 00	07 FE	05 00	92 30	00 00	
User Gamma Point 4	Get	BE EF	03	06 00	4C FE	02 00	93 30	00 00	
	Increment	BE EF	03	06 00	2A FE	04 00	93 30	00 00	
	Decrement	BE EF	03	06 00	FA FF	05 00	93 30	00 00	
User Gamma Point 5	Get	BE EF	03	06 00	38 FF	02 00	94 30	00 00	
	Increment	BE EF	03	06 00	5E FF	04 00	94 30	00 00	
	Decrement	BE EF	03	06 00	8F FE	05 00	94 30	00 00	
User Gamma Point 6	Get	BE EF	03	06 00	C4 FE	02 00	95 30	00 00	
	Increment	BE EF	03	06 00	A2 FE	04 00	95 30	00 00	
	Decrement	BE EF	03	06 00	73 FF	05 00	95 30	00 00	
User Gamma Point 7	Get	BE EF	03	06 00	80 FE	02 00	96 30	00 00	
	Increment	BE EF	03	06 00	E6 FE	04 00	96 30	00 00	
	Decrement	BE EF	03	06 00	37 FF	05 00	96 30	00 00	
User Gamma Point 8	Get	BE EF	03	06 00	7C FF	02 00	97 30	00 00	
	Increment	BE EF	03	06 00	1A FF	04 00	97 30	00 00	
	Decrement	BE EF	03	06 00	CB FE	05 00	97 30	00 00	
COLOR TEMP	Set	LOW	BE EF	03	06 00	6B F4	01 00	B0 30	01 00
		MID	BE EF	03	06 00	9B F4	01 00	B0 30	02 00
		HIGH	BE EF	03	06 00	0B F5	01 00	B0 30	03 00
		Hi-BRIGHT-1	BE EF	03	06 00	3B F2	01 00	B0 30	08 00
		Hi-BRIGHT-2	BE EF	03	06 00	AB F3	01 00	B0 30	09 00
		CUSTOM-LOW	BE EF	03	06 00	AB F9	01 00	B0 30	11 00
		CUSTOM-MID	BE EF	03	06 00	5B F9	01 00	B0 30	12 00
		CUSTOM-HIGH	BE EF	03	06 00	CB F8	01 00	B0 30	13 00
		CUSTOM-HI-BRIGHT-1	BE EF	03	06 00	FB FF	01 00	B0 30	18 00
	CUSTOM-HI-BRIGHT-2	BE EF	03	06 00	6B FE	01 00	B0 30	19 00	
Get	BE EF	03	06 00	C8 F5	02 00	B0 30	00 00		
COLOR TEMP GAIN R	Get	BE EF	03	06 00	34 F4	02 00	B1 30	00 00	
	Increment	BE EF	03	06 00	52 F4	04 00	B1 30	00 00	
	Decrement	BE EF	03	06 00	83 F5	05 00	B1 30	00 00	
COLOR TEMP GAIN G	Get	BE EF	03	06 00	70 F4	02 00	B2 30	00 00	
	Increment	BE EF	03	06 00	16 F4	04 00	B2 30	00 00	
	Decrement	BE EF	03	06 00	C7 F5	05 00	B2 30	00 00	



**RS-232C Communication (continued)**

Names	Operation Type	Header				Command Data			
						CRC	Action	Type	Setting Code
COLOR TEMP GAIN B	Get	BE EF	03	06 00	8C F5	02 00	B3 30	00 00	
	Increment	BE EF	03	06 00	EA F5	04 00	B3 30	00 00	
	Decrement	BE EF	03	06 00	3B F4	05 00	B3 30	00 00	
COLOR TEMP OFFSET R	Get	BE EF	03	06 00	04 F5	02 00	B5 30	00 00	
	Increment	BE EF	03	06 00	62 F5	04 00	B5 30	00 00	
	Decrement	BE EF	03	06 00	B3 F4	05 00	B5 30	00 00	
COLOR TEMP OFFSET G	Get	BE EF	03	06 00	40 F5	02 00	B6 30	00 00	
	Increment	BE EF	03	06 00	26 F5	04 00	B6 30	00 00	
	Decrement	BE EF	03	06 00	F7 F4	05 00	B6 30	00 00	
COLOR TEMP OFFSET B	Get	BE EF	03	06 00	BC F4	02 00	B7 30	00 00	
	Increment	BE EF	03	06 00	DA F4	04 00	B7 30	00 00	
	Decrement	BE EF	03	06 00	0B F5	05 00	B7 30	00 00	
COLOR	Get	BE EF	03	06 00	B5 72	02 00	02 22	00 00	
	Increment	BE EF	03	06 00	D3 72	04 00	02 22	00 00	
	Decrement	BE EF	03	06 00	02 73	05 00	02 22	00 00	
COLOR Reset	Execute	BE EF	03	06 00	80 D0	06 00	0A 70	00 00	
TINT	Get	BE EF	03	06 00	49 73	02 00	03 22	00 00	
	Increment	BE EF	03	06 00	2F 73	04 00	03 22	00 00	
	Decrement	BE EF	03	06 00	FE 72	05 00	03 22	00 00	
TINT Reset	Execute	BE EF	03	06 00	7C D1	06 00	0B 70	00 00	
SHARPNESS	Get	BE EF	03	06 00	F1 72	02 00	01 22	00 00	
	Increment	BE EF	03	06 00	97 72	04 00	01 22	00 00	
	Decrement	BE EF	03	06 00	46 73	05 00	01 22	00 00	
SHARPNESS Reset	Execute	BE EF	03	06 00	C4 D0	06 00	09 70	00 00	
MY MEMORY Load	Set	1	BE EF	03	06 00	0E D7	01 00	14 20	00 00
		2	BE EF	03	06 00	9E D6	01 00	14 20	01 00
		3	BE EF	03	06 00	6E D6	01 00	14 20	02 00
		4	BE EF	03	06 00	FE D7	01 00	14 20	03 00
MY MEMORY Save	Set	1	BE EF	03	06 00	F2 D6	01 00	15 20	00 00
		2	BE EF	03	06 00	62 D7	01 00	15 20	01 00
		3	BE EF	03	06 00	92 D7	01 00	15 20	02 00
		4	BE EF	03	06 00	02 D6	01 00	15 20	03 00
PROGRESSIVE	Set	TURN OFF	BE EF	03	06 00	4A 72	01 00	07 22	00 00
		TV	BE EF	03	06 00	DA 73	01 00	07 22	01 00
		FILM	BE EF	03	06 00	2A 73	01 00	07 22	02 00
	Get	BE EF	03	06 00	79 72	02 00	07 22	00 00	
3D-YCS	Set	TURN OFF	BE EF	03	06 00	E6 70	01 00	0A 22	00 00
		MOVIE	BE EF	03	06 00	76 71	01 00	0A 22	01 00
		STILL	BE EF	03	06 00	86 71	01 00	0A 22	02 00
	Get	BE EF	03	06 00	D5 70	02 00	0A 22	00 00	
VIDEO NR	Set	LOW	BE EF	03	06 00	26 72	01 00	06 22	01 00
		MID	BE EF	03	06 00	D6 72	01 00	06 22	02 00
		HIGH	BE EF	03	06 00	46 73	01 00	06 22	03 00
	Get	BE EF	03	06 00	85 73	02 00	06 22	00 00	

## RS-232C Communication (continued)

Names	Operation Type	Header				Command Data			
						CRC	Action	Type	Setting Code
ASPECT	Set	4:3	BE EF	03	06 00	9E D0	01 00	08 20	00 00
		16:9	BE EF	03	06 00	0E D1	01 00	08 20	01 00
		14:9	BE EF	03	06 00	CE D6	01 00	08 20	09 00
		SMALL	BE EF	03	06 00	FE D1	01 00	08 20	02 00
	NORMAL	BE EF	03	06 00	5E DD	01 00	08 20	10 00	
	Get	BE EF	03	06 00	AD D0	02 00	08 20	00 00	
OVER SCAN	Get	BE EF	03	06 00	91 70	02 00	09 22	00 00	
	Increment	BE EF	03	06 00	F7 70	04 00	09 22	00 00	
	Decrement	BE EF	03	06 00	26 71	05 00	09 22	00 00	
OVER SCAN Reset	Execute	BE EF	03	06 00	EC D9	06 00	27 70	00 00	
V POSITION	Get	BE EF	03	06 00	0D 83	02 00	00 21	00 00	
	Increment	BE EF	03	06 00	6B 83	04 00	00 21	00 00	
	Decrement	BE EF	03	06 00	BA 82	05 00	00 21	00 00	
V POSITION Reset	Execute	BE EF	03	06 00	E0 D2	06 00	02 70	00 00	
H POSITION	Get	BE EF	03	06 00	F1 82	02 00	01 21	00 00	
	Increment	BE EF	03	06 00	97 82	04 00	01 21	00 00	
	Decrement	BE EF	03	06 00	46 83	05 00	01 21	00 00	
H POSITION Reset	Execute	BE EF	03	06 00	1C D3	06 00	03 70	00 00	
H PHASE	Get	BE EF	03	06 00	49 83	02 00	03 21	00 00	
	Increment	BE EF	03	06 00	2F 83	04 00	03 21	00 00	
	Decrement	BE EF	03	06 00	FE 82	05 00	03 21	00 00	
H SIZE	Get	BE EF	03	06 00	B5 82	02 00	02 21	00 00	
	Increment	BE EF	03	06 00	D3 82	04 00	02 21	00 00	
	Decrement	BE EF	03	06 00	02 83	05 00	02 21	00 00	
H SIZE Reset	Execute	BE EF	03	06 00	68 D2	06 00	04 70	00 00	
AUTO ADJUST	Execute	BE EF	03	06 00	91 D0	06 00	0A 20	00 00	
COLOR SPACE	Set	AUTO	BE EF	03	06 00	0E 72	01 00	04 22	00 00
		RGB	BE EF	03	06 00	9E 73	01 00	04 22	01 00
		SMPTE240	BE EF	03	06 00	6E 73	01 00	04 22	02 00
		REC709	BE EF	03	06 00	FE 72	01 00	04 22	03 00
	REC601	BE EF	03	06 00	CE 70	01 00	04 22	04 00	
Get	BE EF	03	06 00	3D 72	02 00	04 22	00 00		
COMPONENT	Set	COMPONENT	BE EF	03	06 00	4A D7	01 00	17 20	00 00
		SCART RGB	BE EF	03	06 00	DA D6	01 00	17 20	01 00
	Get	BE EF	03	06 00	79 D7	02 00	17 20	00 00	
C-VIDEO FORMAT	Set	AUTO	BE EF	03	06 00	A2 70	01 00	11 22	0A 00
		NTSC	BE EF	03	06 00	C2 74	01 00	11 22	04 00
		PAL	BE EF	03	06 00	52 75	01 00	11 22	05 00
		SECAM	BE EF	03	06 00	52 70	01 00	11 22	09 00
		NTSC4.43	BE EF	03	06 00	62 77	01 00	11 22	02 00
		M-PAL	BE EF	03	06 00	C2 71	01 00	11 22	08 00
	N-PAL	BE EF	03	06 00	32 74	01 00	11 22	07 00	
Get	BE EF	03	06 00	31 76	02 00	11 22	00 00		
S-VIDEO FORMAT	Set	AUTO	BE EF	03	06 00	E6 70	01 00	12 22	0A 00
		NTSC	BE EF	03	06 00	86 74	01 00	12 22	04 00
		PAL	BE EF	03	06 00	16 75	01 00	12 22	05 00
		SECAM	BE EF	03	06 00	16 70	01 00	12 22	09 00
		NTSC4.43	BE EF	03	06 00	26 77	01 00	12 22	02 00
		M-PAL	BE EF	03	06 00	86 71	01 00	12 22	08 00
	N-PAL	BE EF	03	06 00	76 74	01 00	12 22	07 00	
Get	BE EF	03	06 00	75 76	02 00	12 22	00 00		

**RS-232C Communication (continued)**

Names	Operation Type	Header				Command Data			
					CRC	Action	Type	Setting Code	
M1-D	Set	NORMAL	BE EF	03	06 00	3E D9	01 00	20 20	00 00
		ENHANCED	BE EF	03	06 00	AE D8	01 00	20 20	01 00
	Get	BE EF	03	06 00	0D D9	02 00	20 20	00 00	
RGB 1	Set	SYNC ON G OFF	BE EF	03	06 00	5E D7	01 00	10 20	02 00
		SYNC ON G ON	BE EF	03	06 00	CE D6	01 00	10 20	03 00
	Get	BE EF	03	06 00	0D D6	02 00	10 20	00 00	
RGB 2	Set	SYNC ON G OFF	BE EF	03	06 00	A2 D6	01 00	11 20	02 00
		SYNC ON G ON	BE EF	03	06 00	32 D7	01 00	11 20	03 00
	Get	BE EF	03	06 00	F1 D7	02 00	11 20	00 00	
FRAME LOCK	Set	TURN OFF	BE EF	03	06 00	CB D6	01 00	14 30	00 00
		TURN ON	BE EF	03	06 00	5B D7	01 00	14 30	01 00
	Get	BE EF	03	06 00	F8 D6	02 00	14 30	00 00	
KEYSTONE V	Get	BE EF	03	06 00	B9 D3	02 00	07 20	00 00	
	Increment	BE EF	03	06 00	DF D3	04 00	07 20	00 00	
	Decrement	BE EF	03	06 00	0E D2	05 00	07 20	00 00	
KEYSTONE V Reset	Execute	BE EF	03	06 00	08 D0	06 00	0C 70	00 00	
KEYSTONE H	Get	BE EF	03	06 00	E9 D0	02 00	0B 20	00 00	
	Increment	BE EF	03	06 00	8F D0	04 00	0B 20	00 00	
	Decrement	BE EF	03	06 00	5E D1	05 00	0B 20	00 00	
KEYSTONE H Reset	Execute	BE EF	03	06 00	98 D8	06 00	20 70	00 00	
ACTIVE IRIS	Set	TURN OFF	BE EF	03	06 00	0B 22	01 00	04 33	00 00
		THEATER	BE EF	03	06 00	CB SF	01 00	04 33	10 00
		PRESENTATION	BE EF	03	06 00	5B 2E	01 00	04 33	11 00
	Get	BE EF	03	06 00	38 22	02 00	04 33	00 00	
WHISPER	Set	NORMAL	BE EF	03	06 00	3B 23	01 00	00 33	00 00
		WHISPER	BE EF	03	06 00	AB 22	01 00	00 33	01 00
	Get	BE EF	03	06 00	08 23	02 00	00 33	00 00	
MIRROR	Set	NORMAL	BE EF	03	06 00	C7 D2	01 00	01 30	00 00
		H:INVERT	BE EF	03	06 00	57 D3	01 00	01 30	01 00
		V:INVERT	BE EF	03	06 00	A7 D3	01 00	01 30	02 00
		H&V:INVERT	BE EF	03	06 00	37 D2	01 00	01 30	03 00
	Get	BE EF	03	06 00	F4 D2	02 00	01 30	00 00	
VOLUME-RGB1	Get	BE EF	03	06 00	CD CC	02 00	60 20	00 00	
	Increment	BE EF	03	06 00	AB CC	04 00	60 20	00 00	
	Decrement	BE EF	03	06 00	7A CD	05 00	60 20	00 00	
VOLUME-RGB2	Get	BE EF	03	06 00	FD CD	02 00	64 20	00 00	
	Increment	BE EF	03	06 00	9B CD	04 00	64 20	00 00	
	Decrement	BE EF	03	06 00	4A CC	05 00	64 20	00 00	
VOLUME-M1-D	Get	BE EF	03	06 00	89 CC	02 00	63 20	00 00	
	Increment	BE EF	03	06 00	EF CC	04 00	63 20	00 00	
	Decrement	BE EF	03	06 00	3E CD	05 00	63 20	00 00	
VOLUME-Video	Get	BE EF	03	06 00	31 CD	02 00	61 20	00 00	
	Increment	BE EF	03	06 00	57 CD	04 00	61 20	00 00	
	Decrement	BE EF	03	06 00	86 CC	05 00	61 20	00 00	
VOLUME-S-Video	Get	BE EF	03	06 00	75 CD	02 00	62 20	00 00	
	Increment	BE EF	03	06 00	13 CD	04 00	62 20	00 00	
	Decrement	BE EF	03	06 00	C2 CC	05 00	62 20	00 00	

## RS-232C Communication (continued)

Names	Operation Type	Header				Command Data			
						CRC	Action	Type	Setting Code
VOLUME-Component	Get	BE EF	03	06 00	01 CC	02 00	65 20	00 00	
	Increment	BE EF	03	06 00	67 CC	04 00	65 20	00 00	
	Decrement	BE EF	03	06 00	B6 CD	05 00	65 20	00 00	
TREBLE-RGB1	Get	BE EF	03	06 00	0D C8	02 00	70 20	00 00	
	Increment	BE EF	03	06 00	6B C8	04 00	70 20	00 00	
	Decrement	BE EF	03	06 00	BA C9	05 00	70 20	00 00	
TREBLE-RGB2	Get	BE EF	03	06 00	3D C9	02 00	74 20	00 00	
	Increment	BE EF	03	06 00	5B C9	04 00	74 20	00 00	
	Decrement	BE EF	03	06 00	8A C8	05 00	74 20	00 00	
TREBLE-M1-D	Get	BE EF	03	06 00	49 C8	02 00	73 20	00 00	
	Increment	BE EF	03	06 00	2F C8	04 00	73 20	00 00	
	Decrement	BE EF	03	06 00	FE C9	05 00	73 20	00 00	
TREBLE-Video	Get	BE EF	03	06 00	F1 C9	02 00	71 20	00 00	
	Increment	BE EF	03	06 00	97 C9	04 00	71 20	00 00	
	Decrement	BE EF	03	06 00	46 C8	05 00	71 20	00 00	
TREBLE-S-Video	Get	BE EF	03	06 00	B5 C9	02 00	72 20	00 00	
	Increment	BE EF	03	06 00	D3 C9	04 00	72 20	00 00	
	Decrement	BE EF	03	06 00	02 C8	05 00	72 20	00 00	
TREBLE-Component	Get	BE EF	03	06 00	C1 C8	02 00	75 20	00 00	
	Increment	BE EF	03	06 00	A7 C8	04 00	75 20	00 00	
	Decrement	BE EF	03	06 00	76 C9	05 00	75 20	00 00	
BASS-RGB1	Get	BE EF	03	06 00	0D FB	02 00	80 20	00 00	
	Increment	BE EF	03	06 00	6B FB	04 00	80 20	00 00	
	Decrement	BE EF	03	06 00	BA FA	05 00	80 20	00 00	
BASS-RGB2	Get	BE EF	03	06 00	3D FA	02 00	84 20	00 00	
	Increment	BE EF	03	06 00	5B FA	04 00	84 20	00 00	
	Decrement	BE EF	03	06 00	8A FB	05 00	84 20	00 00	
BASS-M1-D	Get	BE EF	03	06 00	49 FB	02 00	83 20	00 00	
	Increment	BE EF	03	06 00	2F FB	04 00	83 20	00 00	
	Decrement	BE EF	03	06 00	FE FA	05 00	83 20	00 00	
BASS-Video	Get	BE EF	03	06 00	F1 FA	02 00	81 20	00 00	
	Increment	BE EF	03	06 00	97 FA	04 00	81 20	00 00	
	Decrement	BE EF	03	06 00	46 FB	05 00	81 20	00 00	
BASS-S-Video	Get	BE EF	03	06 00	B5 FA	02 00	82 20	00 00	
	Increment	BE EF	03	06 00	D3 FA	04 00	82 20	00 00	
	Decrement	BE EF	03	06 00	02 FB	05 00	82 20	00 00	
BASS-Component	Get	BE EF	03	06 00	C1 FB	02 00	85 20	00 00	
	Increment	BE EF	03	06 00	A7 FB	04 00	85 20	00 00	
	Decrement	BE EF	03	06 00	76 FA	05 00	85 20	00 00	
SRS WOW RGB1	Set	TURN OFF	BE EF	03	06 00	FE FF	01 00	90 20	00 00
		MID	BE EF	03	06 00	9E FE	01 00	90 20	02 00
		HIGH	BE EF	03	06 00	0E FF	01 00	90 20	03 00
	Get	BE EF	03	06 00	CD FF	02 00	90 20	00 00	

**RS-232C Communication (continued)**

Names	Operation Type	Header				Command Data			
					CRC	Action	Type	Setting Code	
SRS WOW RGB2	Set	TURN OFF	BE EF	03	06 00	CE FE	01 00	94 20	00 00
		MID	BE EF	03	06 00	AE FF	01 00	94 20	02 00
		HIGH	BE EF	03	06 00	3E FF	01 00	94 20	03 00
		Get	BE EF	03	06 00	FD FE	02 00	94 20	00 00
SRS WOW M1-D	Set	TURN OFF	BE EF	03	06 00	BA FF	01 00	93 20	00 00
		MID	BE EF	03	06 00	DA FE	01 00	93 20	02 00
		HIGH	BE EF	03	06 00	4A FF	01 00	93 20	03 00
		Get	BE EF	03	06 00	89 FF	02 00	93 20	00 00
SRS WOW Video	Set	TURN OFF	BE EF	03	06 00	02 FE	01 00	91 20	00 00
		MID	BE EF	03	06 00	62 FF	01 00	91 20	02 00
		HIGH	BE EF	03	06 00	F2 FE	01 00	91 20	03 00
		Get	BE EF	03	06 00	31 FE	02 00	91 20	00 00
SRS WOW S-Video	Set	TURN OFF	BE EF	03	06 00	46 FE	01 00	92 20	00 00
		MID	BE EF	03	06 00	26 FF	01 00	92 20	02 00
		HIGH	BE EF	03	06 00	B6 FE	01 00	92 20	03 00
		Get	BE EF	03	06 00	75 FE	02 00	92 20	00 00
SRS WOW Component	Set	TURN OFF	BE EF	03	06 00	32 FF	01 00	95 20	00 00
		MID	BE EF	03	06 00	52 FE	01 00	95 20	02 00
		HIGH	BE EF	03	06 00	C2 FF	01 00	95 20	03 00
		Get	BE EF	03	06 00	01 FF	02 00	95 20	00 00
MUTE	Set	TURN OFF	BE EF	03	06 00	46 D3	01 00	02 20	00 00
		TURN ON	BE EF	03	06 00	D6 D2	01 00	02 20	01 00
		Get	BE EF	03	06 00	75 D3	02 00	02 20	00 00
SPEAKER	Set	TURN OFF	BE EF	03	06 00	6E D5	01 00	1C 20	00 00
		TURN ON	BE EF	03	06 00	FE D4	01 00	1C 20	01 00
		Get	BE EF	03	06 00	5D D5	02 00	1C 20	00 00
AUDIO - RGB1	Set	TURN OFF	BE EF	03	06 00	FE DD	01 00	30 20	00 00
		Audio1	BE EF	03	06 00	6E DC	01 00	30 20	01 00
		Audio2	BE EF	03	06 00	9E DC	01 00	30 20	02 00
		Audio3	BE EF	03	06 00	0E DD	01 00	30 20	03 00
		Audio4	BE EF	03	06 00	3E DF	01 00	30 20	04 00
Get	BE EF	03	06 00	CD DD	02 00	30 20	00 00		
AUDIO - RGB2	Set	TURN OFF	BE EF	03	06 00	CE DC	01 00	34 20	00 00
		Audio1	BE EF	03	06 00	5E DD	01 00	34 20	01 00
		Audio2	BE EF	03	06 00	AE DD	01 00	34 20	02 00
		Audio3	BE EF	03	06 00	3E DC	01 00	34 20	03 00
		Audio4	BE EF	03	06 00	0E DE	01 00	34 20	04 00
Get	BE EF	03	06 00	FD DC	02 00	34 20	00 00		

## RS-232C Communication (continued)

Names	Operation Type	Header				Command Data			
						CRC	Action	Type	Setting Code
AUDIO - M1-D	Set	TURN OFF	BE EF	03	06 00	BA DD	01 00	33 20	00 00
		Audio1	BE EF	03	06 00	2A DC	01 00	33 20	01 00
		Audio2	BE EF	03	06 00	DA DC	01 00	33 20	02 00
		Audio3	BE EF	03	06 00	4A DD	01 00	33 20	03 00
	Audio4	BE EF	03	06 00	7A DF	01 00	33 20	04 00	
	Get	BE EF	03	06 00	89 DD	02 00	33 20	00 00	
AUDIO - Video	Set	TURN OFF	BE EF	03	06 00	02 DC	01 00	31 20	00 00
		Audio1	BE EF	03	06 00	92 DD	01 00	31 20	01 00
		Audio2	BE EF	03	06 00	62 DD	01 00	31 20	02 00
		Audio3	BE EF	03	06 00	F2 DC	01 00	31 20	03 00
	Audio4	BE EF	03	06 00	C2 DE	01 00	31 20	04 00	
	Get	BE EF	03	06 00	31 DC	02 00	31 20	00 00	
AUDIO - S-Video	Set	TURN OFF	BE EF	03	06 00	46 DC	01 00	32 20	00 00
		Audio1	BE EF	03	06 00	D6 DD	01 00	32 20	01 00
		Audio2	BE EF	03	06 00	26 DD	01 00	32 20	02 00
		Audio3	BE EF	03	06 00	B6 DC	01 00	32 20	03 00
	Audio4	BE EF	03	06 00	86 DE	01 00	32 20	04 00	
	Get	BE EF	03	06 00	75 DC	02 00	32 20	00 00	
AUDIO - Component	Set	TURN OFF	BE EF	03	06 00	32 DD	01 00	35 20	00 00
		Audio1	BE EF	03	06 00	A2 DC	01 00	35 20	01 00
		Audio2	BE EF	03	06 00	52 DC	01 00	35 20	02 00
		Audio3	BE EF	03	06 00	C2 DD	01 00	35 20	03 00
	Audio4	BE EF	03	06 00	F2 DF	01 00	35 20	04 00	
	Get	BE EF	03	06 00	01 DD	02 00	35 20	00 00	
IR REMOTE Front	Set	Off	BE EF	03	06 00	FF 32	01 00	00 26	00 00
		On	BE EF	03	06 00	6F 33	01 00	00 26	01 00
	Get	BE EF	03	06 00	CC 32	02 00	00 26	00 00	
IR REMOTE Rear	Set	Off	BE EF	03	06 00	03 33	01 00	01 26	00 00
		On	BE EF	03	06 00	93 32	01 00	01 26	01 00
	Get	BE EF	03	06 00	30 33	02 00	01 26	00 00	
IR REMOTE Top	Set	Off	BE EF	03	06 00	47 33	01 00	02 26	00 00
		On	BE EF	03	06 00	D7 32	01 00	02 26	01 00
	Get	BE EF	03	06 00	74 33	02 00	02 26	00 00	
IR REMOTE FREQ. NORMAL	Set	Off	BE EF	03	06 00	FF 3D	01 00	30 26	00 00
		On	BE EF	03	06 00	6F 3C	01 00	30 26	01 00
	Get	BE EF	03	06 00	CC 3D	02 00	30 26	00 00	
IR REMOTE FREQ. HIGH	Set	Off	BE EF	03	06 00	03 3C	01 00	31 26	00 00
		On	BE EF	03	06 00	93 3D	01 00	31 26	01 00
	Get	BE EF	03	06 00	30 3C	02 00	31 26	00 00	

**RS-232C Communication (continued)**

Names	Operation Type	Header					Command Data		
						CRC	Action	Type	Setting Code
LANGUAGE	Set	ENGLISH	BE EF	03	06 00	F7 D3	01 00	05 30	00 00
		FRANÇAIS	BE EF	03	06 00	67 D2	01 00	05 30	01 00
		DEUTSCH	BE EF	03	06 00	97 D2	01 00	05 30	02 00
		ESPAÑOL	BE EF	03	06 00	07 D3	01 00	05 30	03 00
		ITALIANO	BE EF	03	06 00	37 D1	01 00	05 30	04 00
		NORSK	BE EF	03	06 00	A7 D0	01 00	05 30	05 00
		NEDERLANDS	BE EF	03	06 00	57 D0	01 00	05 30	06 00
		PORTUGUÊS	BE EF	03	06 00	C7 D1	01 00	05 30	07 00
		日本語	BE EF	03	06 00	37 D4	01 00	05 30	08 00
		简体中文	BE EF	03	06 00	A7 D5	01 00	05 30	09 00
		繁體中文	BE EF	03	06 00	37 DE	01 00	05 30	10 00
		한글	BE EF	03	06 00	57 D5	01 00	05 30	0A 00
		SVENSKA	BE EF	03	06 00	C7 D4	01 00	05 30	0B 00
		РУССКИЙ	BE EF	03	06 00	F7 D6	01 00	05 30	0C 00
		SUOMI	BE EF	03	06 00	67 D7	01 00	05 30	0D 00
POLSKI	BE EF	03	06 00	97 D7	01 00	05 30	0E 00		
TÜRKÇE	BE EF	03	06 00	07 D6	01 00	05 30	0F 00		
	Get	BE EF	03	06 00	C4 D3	02 00	05 30	00 00	
MENU POSITION H	Get	BE EF	03	06 00	04 D7	02 00	15 30	00 00	
	Increment	BE EF	03	06 00	62 D7	04 00	15 30	00 00	
	Decrement	BE EF	03	06 00	B3 D6	05 00	15 30	00 00	
MENU POSITION H Reset	Execute	BE EF	03	06 00	DC C6	06 00	43 70	00 00	
MENU POSITION V	Get	BE EF	03	06 00	40 D7	02 00	16 30	00 00	
	Increment	BE EF	03	06 00	26 D7	04 00	16 30	00 00	
	Decrement	BE EF	03	06 00	F7 D6	05 00	16 30	00 00	
MENU POSITION V Reset	Execute	BE EF	03	06 00	A8 C7	06 00	44 70	00 00	
BLANK	Set	My Screen	BE EF	03	06 00	FB CA	01 00	00 30	20 00
		ORIGINAL	BE EF	03	06 00	FB E2	01 00	00 30	40 00
		BLUE	BE EF	03	06 00	CB D3	01 00	00 30	03 00
		WHITE	BE EF	03	06 00	6B D0	01 00	00 30	05 00
		BLACK	BE EF	03	06 00	9B D0	01 00	00 30	06 00
	Get	BE EF	03	06 00	08 D3	02 00	00 30	00 00	
BLANK On/Off	Set	TURN OFF	BE EF	03	06 00	FB D8	01 00	20 30	00 00
		TURN ON	BE EF	03	06 00	6B D9	01 00	20 30	01 00
		Get	BE EF	03	06 00	C8 D8	02 00	20 30	00 00
START UP	Set	My Screen	BE EF	03	06 00	CB CB	01 00	04 30	20 00
		ORIGINAL	BE EF	03	06 00	0B D2	01 00	04 30	00 00
		TURN OFF	BE EF	03	06 00	9B D3	01 00	04 30	01 00
	Get	BE EF	03	06 00	38 D2	02 00	04 30	00 00	
My Screen LOCK	Set	TURN OFF	BE EF	03	06 00	3B EF	01 00	C0 30	00 00
		TURN ON	BE EF	03	06 00	AB EE	01 00	C0 30	01 00
	Get	BE EF	03	06 00	08 EF	02 00	C0 30	00 00	
MESSAGE	Set	TURN OFF	BE EF	03	06 00	8F D6	01 00	17 30	00 00
		TURN ON	BE EF	03	06 00	1F D7	01 00	17 30	01 00
	Get	BE EF	03	06 00	BC D6	02 00	17 30	00 00	

## RS-232C Communication (continued)

Names	Operation Type	Header				Command Data			
						CRC	Action	Type	Setting Code
AUTO SEARCH	Set	TURN OFF	BE EF	03	06 00	B6 D6	01 00	16 20	00 00
		TURN ON	BE EF	03	06 00	26 D7	01 00	16 20	01 00
	Get	BE EF	03	06 00	85 D6	02 00	16 20	00 00	
AUTO OFF	Get	BE EF	03	06 00	08 86	02 00	10 31	00 00	
	Increment	BE EF	03	06 00	6E 86	04 00	10 31	00 00	
	Decrement	BE EF	03	06 00	BF 87	05 00	10 31	00 00	
AUTO ON	Set	TURN OFF	BE EF	03	06 00	3B 89	01 00	20 31	00 00
		TURN ON	BE EF	03	06 00	AB 88	01 00	20 31	01 00
	Get	BE EF	03	06 00	08 89	02 00	20 31	00 00	
LAMP TIME	Get	BE EF	03	06 00	C2 FF	02 00	90 10	00 00	
LAMP TIME Reset	Execute	BE EF	03	06 00	58 DC	06 00	30 70	00 00	
FILTER TIME	Get	BE EF	03	06 00	C2 F0	02 00	A0 10	00 00	
FILER TIME Reset	Execute	BE EF	03	06 00	98 C6	06 00	40 70	00 00	
AUTO KEYSTONE EXECUTE	Execute	BE EF	03	06 00	E5 D1	06 00	0D 20	00 00	
AUTO KEYSTONE	Set	TURN OFF	BE EF	03	06 00	EAD1	01 00	0F 20	00 00
		TURN ON	BE EF	03	06 00	7AD0	01 00	0F 20	01 00
	Get	BE EF	03	06 00	D9 D1	02 00	0F 20	00 00	
MY BUTTON-1	Set	RGB1	BE EF	03	06 00	3A 33	01 00	00 36	00 00
		RGB2	BE EF	03	06 00	FA 31	01 00	00 36	04 00
		M1-D	BE EF	03	06 00	CA 33	01 00	00 36	03 00
		COMPONENT	BE EF	03	06 00	6A 30	01 00	00 36	05 00
		S-VIDEO	BE EF	03	06 00	5A 32	01 00	00 36	02 00
		VIDEO	BE EF	03	06 00	AA 32	01 00	00 36	01 00
		INFORMATION	BE EF	03	06 00	FA 3E	01 00	00 36	10 00
		AUTO KEYSTONE EXECUTE	BE EF	03	06 00	6A 3F	01 00	00 36	11 00
		MY MEMORY	BE EF	03	06 00	9A 3F	01 00	00 36	12 00
		PICTURE MODE	BE EF	03	06 00	0A 3E	01 00	00 36	13 00
		FILTER RESET	BE EF	03	06 00	3A 3C	01 00	00 36	14 00
		ACTIVE IRIS	BE EF	03	06 00	AA 3D	01 00	00 36	15 00
		e-SHOT	BE EF	03	06 00	5A 3D	01 00	00 36	16 00
		VOLUME +	BE EF	03	06 00	CA 3C	01 00	00 36	17 00
VOLUME -	BE EF	03	06 00	3A 39	01 00	00 36	18 00		
Get	BE EF	03	06 00	09 33	02 00	00 36	00 00		



**RS-232C Communication (continued)**

Names	Operation Type	Header				Command Data			
					CRC	Action	Type	Setting Code	
MY BUTTON-2	Set	RGB1	BE EF	03	06 00	C6 32	01 00	01 36	00 00
		RGB2	BE EF	03	06 00	06 30	01 00	01 36	04 00
		M1-D	BE EF	03	06 00	36 32	01 00	01 36	03 00
		COMPONENT	BE EF	03	06 00	96 31	01 00	01 36	05 00
		S-VIDEO	BE EF	03	06 00	A6 33	01 00	01 36	02 00
		VIDEO	BE EF	03	06 00	56 33	01 00	01 36	01 00
		INFORMATION	BE EF	03	06 00	06 3F	01 00	01 36	10 00
		AUTO KEYSTONE EXECUTE	BE EF	03	06 00	96 3E	01 00	01 36	11 00
		MY MEMORY	BE EF	03	06 00	66 3E	01 00	01 36	12 00
		PICTURE MODE	BE EF	03	06 00	F6 3F	01 00	01 36	13 00
		FILTER RESET	BE EF	03	06 00	C6 3D	01 00	01 36	14 00
		ACTIVE IRIS	BE EF	03	06 00	56 3C	01 00	01 36	15 00
		e-SHOT	BE EF	03	06 00	A6 3C	01 00	01 36	16 00
		VOLUME +	BE EF	03	06 00	36 3D	01 00	01 36	17 00
VOLUME -	BE EF	03	06 00	C6 38	01 00	01 36	18 00		
	Get	BE EF	03	06 00	F5 32	02 00	01 36	00 00	
MAGNIFY	Get	BE EF	03	06 00	7C D2	02 00	07 30	00 00	
	Increment	BE EF	03	06 00	1A D2	04 00	07 30	00 00	
	Decrement	BE EF	03	06 00	CB D3	05 00	07 30	00 00	
FREEZE	Set	NORMAL	BE EF	03	06 00	83 D2	01 00	02 30	00 00
		FREEZE	BE EF	03	06 00	13 D3	01 00	02 30	01 00
	Get	BE EF	03	06 00	B0 D2	02 00	02 30	00 00	

# Projector 8918/8943 User's Manual – Network Functions

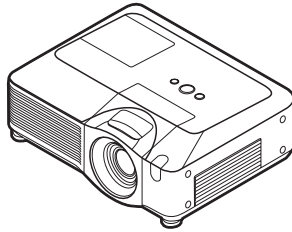

This manual is only intended to explain Network Functions.  
For safety, operations or any other issues, refer to the all user's manual for this projector.

**⚠ WARNING** • Before using the network functions, read the all the manual sections for this projector carefully to ensure your projector is set up correctly.  
• After reading, keep the manuals in a safe place for future reference.

**NOTE** • The information in this manual is subject to change without notice.  
• The manufacturer assumes no responsibility for any errors that may appear in this manual.  
• The reproduction, transfer or copy of all or any part of this document is not permitted without express written consent.

## Trademark acknowledgment

- Windows is a registered trademark of Microsoft Corporation.
  - Netscape is a registered trademark of Netscape Communications Corporation.
  - JavaScript is a registered trademark of Sun Microsystems, Inc.
- All other trademarks are the properties of their respective owners.

## Contents

	
<b>Network Functions .....</b>	<b>2</b>
<b>Settings .....</b>	<b>6</b>
<b>Projector Control .....</b>	<b>22</b>
<b>Failure &amp; Warning Alerts via E-mail .....</b>	<b>26</b>
<b>Projector Management via SNMP.....</b>	<b>28</b>
<b>Controlling the Projector via Scheduling .....</b>	<b>29</b>
<b>e-SHOT(Still Image Transfer) Display .....</b>	<b>32</b>
<b>Command Control via the Network.....</b>	<b>34</b>

## Network Functions

This projector is equipped with the following network functions.

### **Configuring and Controlling the Projector via a Web Browser**

You can change the settings of or control the projector via a network by using a web browser from a PC that is connected to the same network.

(4)

### **Failure & Warning Alerts via E-mail**

The projector can automatically send an alert to specified e-mail addresses when the projector requires maintenance or has encountered an error.

(26)

### **Projector Management via SNMP**

This projector is SNMP (Simple Network Management Protocol) compliant, allowing you to monitor it from a remote location using SNMP software. In addition, the projector is able to send failure & warning alerts to a specified PC.

(28)

### **Controlling the Projector via Scheduling**

You can schedule the projector to perform various functions according to the DATE and TIME.

(29)

### **Still Image Transfer**

The projector can display still images that are transferred via the network.

(32)

### **Projector Control via RS-232C via the Network**

The projector can be controlled using RS-232C commands over a network.

(34)

## Before using the network functions...

To use the network functions of this projector, the projector must be configured to suit your network. Consult with your network administrator before connecting the projector to your network. Incorrect network configuration of this projector may cause problems on your network.

Connect to the Gateway (The router/PC that forwards traffic to a destination outside of the subnet of the transmitting device) from the network terminal on the projector using a CAT-5 cable and configure the following settings.

### If using a network with DHCP enabled:

The projector's network settings can be configured automatically. when **[DHCP]** on the network menu is set to **[TURN ON]**. Please refer to DHCP in network menu. ( *Operating Guide : NETWORK Menu*) If a fixed / static IP address is required, please configure your projector according to the steps in the following section.

### If using a network system that does not have DHCP enabled or if using a fixed IP address on a network system equipped with DHCP enabled:

Configure the following settings on the network menu.

( *Operating Guide : NETWORK Menu*)

1. **[DHCP]**: Disable DHCP (Set **[DHCP]** to **[TURN OFF]**).
2. **[IP ADDRESS]**: Enter an appropriate IP address for the projector to connect to your network.
3. **[SUBNET MASK]**: Enter an appropriate SUBNETMASK for the projector to connect to your network.
4. **[DEFAULT GATEWAY]**: Enter an appropriate Gateway (the router/PC that forwards traffic to a destination outside of the subnet of the transmitting device) address for the projector to connect to your network.

## Configuring and controlling the projector via a web browser

You can adjust or control the projector via a network from a web browser on a PC that is connected to the same network.

**NOTE** • Internet Explorer 5.5 or higher or Netscape 6.2 or higher are required.

- If JavaScript is disabled in your web browser configuration, you must enable JavaScript in order to use the projector web pages properly. See the Help files for your web browser for details on how to enable JavaScript.
- This projector is SSL (Secure Socket Layer) compliant. Please specify "https://" when the entering the projector address.
- If no operations are performed via a web browser for approx. 50 seconds the system will automatically log off. Please Re-log on to continue operations via a web browser.
- After you logon, a small, blank window will appear behind the main operation window. Please do not close this small, blank window. If this window is closed, the system will automatically log off after certain period of time even if an operation is being performed.

The small, blank window will close when the main operation window is closed.

- The small, blank window may be considered a pop-up and be blocked if you are using Windows XP Service Pack 2, or using other security software. If Service Pack 2 blocks the window the following message will appear: "Pop-up blocked. To see this pop-up or additional options click here..." Please select "Temporarily Allow Pop-ups" or "Always Allow Pop-ups From This Site..." to allow the window to open.
- It is recommended that all web browser updates be installed. It is especially recommended that all users running Internet Explorer on a Microsoft Windows version prior to Windows XP Service Pack 2 install security update Q832894 (MS04-004) or the web browser interface may not be displayed correctly. And when using an older version of Internet Explorer, during operations the browser will log out after 50 seconds.

**Configuring and controlling the projector via a web browser (Continued)**

When configuring or controlling the projector via a web browser, an ID and password are required. There are two types of IDs, Administrator IDs and User IDs. The following chart describes the differences between user and administrator IDs.

Item	Description	Administrator ID	User ID
<b>Network Information</b>	Displays the projector's current network configuration settings.	√	√
<b>Network Settings</b>	Displays and configures network settings.	√	N/A
<b>Port Settings</b>	Displays and configures communication port settings.	√	N/A
<b>Mail Settings</b>	Displays and configures e-mail addressing settings.	√	N/A
<b>Alert Settings</b>	Displays and configures failure & warning alerts.	√	N/A
<b>Schedule Settings</b>	Displays and configures schedule settings.	√	N/A
<b>Date/Time Settings</b>	Displays and configures the date and time settings.	√	N/A
<b>Security Settings</b>	Displays and configures passwords and other security settings.	√	N/A
<b>Projector Control</b>	Controls the projector.	√	√
<b>Projector Status</b>	Displays and configures the current projector status.	√	√
<b>Network Restart</b>	Restarts the projector's network connection.	√	N/A

Below are the factory default settings for administrator IDs, user IDs and passwords.

Item	ID	Password
<b>Administrator ID</b>	Administrator	<blank>
<b>User ID</b>	User	<blank>

## Settings

Refer to the following for configuring or controlling the projector via a web browser.  
Example: If the IP address of the projector is set to 192.168.1.10:

- 1) Enter **[https://192.168.1.10]** into the address bar of the web browser and the screen in Fig. 1 will be displayed.
- 2) Enter your ID and password and click **[Login]**.

Fig. 1

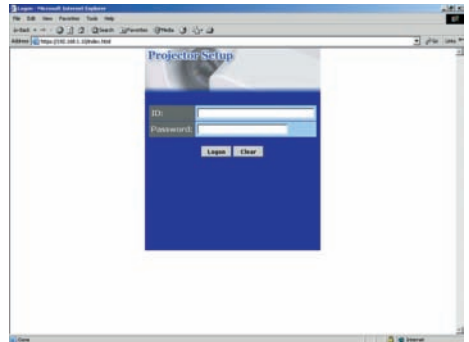

If the logon is successful either the Fig.2 or Fig.3 screen will be displayed.

Fig. 2 (Logon with administrator ID)

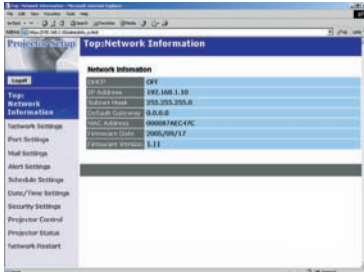
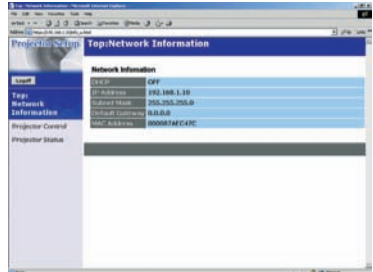
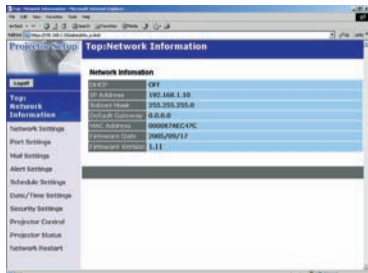

Fig. 3 (Logon with user ID)



- 3) Click the desired operation or configuration item on the main menu located on the left-hand side of the screen (Fig. 2 or Fig. 3).

## Network Information



All screen images displayed in this manual are screens of a logon using an administrator ID. Any administrator only functions will not be displayed when using a user ID. Refer to the descriptions in each table.

Displays the projector's current network configuration settings.

Item	Description
<b>DHCP</b>	Displays the DHCP configuration settings.
<b>IP Address</b>	Displays the current IP address.
<b>Subnet Mask</b>	Displays the Subnet Mask.
<b>Default Gateway</b>	Displays the Default Gateway.
<b>MAC Address</b>	Displays the MAC address.
<b>Firmware Date</b>	Displays the network firmware time stamp. This information is only displayed when logged on using an administrator ID.
<b>Firmware Version</b>	Displays the network firmware version number. This information is only displayed when logged on using an administrator ID.



## Network Settings

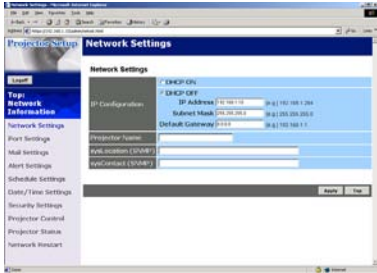

Displays and configures network settings.

Item	Description
<b>IP Configuration</b>	Configures network settings.
<b>DHCP ON</b>	Enables DHCP.
<b>DHCP OFF</b>	Disables DHCP.
<b>IP Address</b>	Configures the IP address when DHCP is disabled.
<b>Subnet Mask</b>	Configures the Subnet Mask when DHCP is disabled.
<b>Default Gateway</b>	Configures the Default Gateway when DHCP is disabled.
<b>Projector Name</b>	Configures the Projector name.
<b>SysLocation</b>	Configures the location to be referred to when using SNMP.
<b>SysContact</b>	Configures the contact information to be referred to when using SNMP.

Click the **[Apply]** button to save the settings.

**NOTE** • The new configuration settings are activated after restarting the network connection. When the configuration settings are changed, you must restart the network connection. You can restart the network connection by clicking **[Network Restart]** on the main menu.

- If you connect the projector to an existing network, consult a network administrator before setting server addresses.

## Port Settings

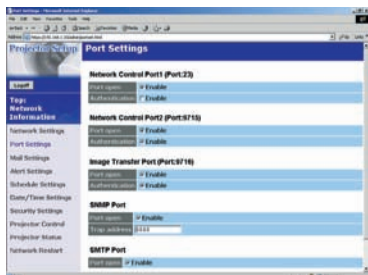

Displays and configures communication port settings.

Item	Description
<b>Network Control Port1</b> (Port:23)	Configures command control port 1 (Port:23).
<b>Port open</b>	Click the <b>[Enable]</b> check box to use port 23.
<b>Authentication</b>	Click the <b>[Enable]</b> check box when authentication is required for this port.
<b>Network Control Port2</b> (Port:9715)	Configures command control port 2 (Port:9715).
<b>Port open</b>	Click the <b>[Enable]</b> check box to use port 9715.
<b>Authentication</b>	Click the <b>[Enable]</b> check box when authentication is required for this port.
<b>Image Transfer Port</b> (Port:9716)	Configures the image transfer port (Port:9716).
<b>Port open</b>	Click the <b>[Enable]</b> check box to use port 9716.
<b>Authentication</b>	Click the <b>[Enable]</b> check box when authentication is required for this port.
<b>SNMP Port</b>	Configures the SNMP port.
<b>Port open</b>	Click the <b>[Enable]</b> check box to use SNMP.
<b>Trap address</b>	Configures the destination of the SNMP Trap in IP format.
<b>SMTP Port</b>	Configures the SMTP port.
<b>Port open</b>	Click the <b>[Enable]</b> check box to use the e-mail function.

Click the **[Apply]** button to save the settings.

**NOTE** • The new configuration settings are activated after restarting the network connection. The network connection must be restarted when the configuration settings are changed. The network connection can be restarted using **[Network Restart]** on the main menu.dresses.

## Mail Settings

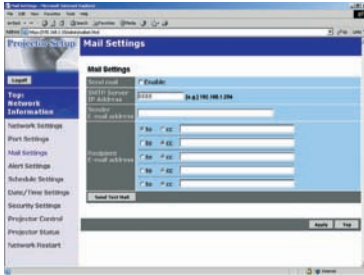

Displays and configures e-mail addressing settings.

Item	Description
<b>Send Mail</b>	Click the <b>[Enable]</b> check box to use the e-mail function. Configure the conditions for sending email under <b>[Alert Settings]</b> .
<b>SMTP Server IP Address</b>	Configures the address of the mail server in IP format.
<b>Sender E-mail address</b>	Configures the sender e-mail address. The length of the sender e-mail address can be up to 255 alphanumeric characters.
<b>Recipient E-mail address</b>	Configures the e-mail address of up to five recipients. You can also specify <b>[TO]</b> or <b>[CC]</b> for each address. The length of the recipient e-mail address can be up to 255 alphanumeric characters.

Click the **[Apply]** button to save the settings.

**NOTE** • You can confirm whether the mail settings work correctly using the [Send Test Mail] button.  
 • If you connect the projector to an existing network, consult a network administrator before setting server addresses.

## Alert Settings

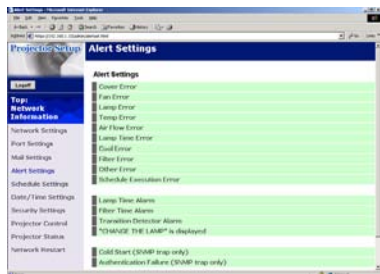

Displays and configures failure & warning alerts.

Item	Description
<b>Cover Error</b>	Configures Cover Error alert settings.
<b>SNMP Trap</b>	Click the <b>[Enable]</b> check box to enable SNMP Trap alerts for this item.
<b>Send Mail</b>	Click the <b>[Enable]</b> check box to enable e-mail alerts for this item.
<b>Mail Subject</b>	Configures the subject line of the e-mail to be sent. The length of the subject line can be up to 255 alphanumeric characters.
<b>Mail Text</b>	Configures the text of the e-mail to be sent. The length of the text can be up to 1024 alphanumeric characters.
<b>Fan Error</b>	Configures Fan Error alert settings.
<b>SNMP Trap</b>	Click the <b>[Enable]</b> check box to enable SNMP Trap alerts for this item.
<b>Send Mail</b>	Click the <b>[Enable]</b> check box to enable e-mail alerts for this item.
<b>Mail Subject</b>	Configures the subject line of the e-mail to be sent. The length of the subject line can be up to 255 alphanumeric characters.
<b>Mail Text</b>	Configures the text of the e-mail to be sent. The length of the text can be up to 1024 alphanumeric characters.

**Alert Settings (Continued)**

Item	Description
<b>Lamp Error</b>	Configures Lamp Error alert settings.
<b>SNMP Trap</b>	Click the <b>[Enable]</b> check box to enable SNMP Trap alerts for this item.
<b>Send Mail</b>	Click the <b>[Enable]</b> check box to enable e-mail alerts for this item.
<b>Mail Subject</b>	Configures the subject line of the e-mail to be sent. The length of the subject line can be up to 255 alphanumeric characters.
<b>Mail Text</b>	Configures the text of the e-mail to be sent. The length of the text can be up to 1024 alphanumeric characters.
<b>Temp Error</b>	Configures Temp Error alert settings.
<b>SNMP Trap</b>	Click the <b>[Enable]</b> check box to enable SNMP Trap alerts for this item.
<b>Send Mail</b>	Click the <b>[Enable]</b> check box to enable e-mail alerts for this item.
<b>Mail Subject</b>	Configures the subject line of the e-mail to be sent. The length of the subject line can be up to 255 alphanumeric characters.
<b>Mail Text</b>	Configures the text of the e-mail to be sent. The length of the text can be up to 1024 alphanumeric characters.
<b>Air Flow Error</b>	Configures Air Flow Error alert settings.
<b>SNMP Trap</b>	Click the <b>[Enable]</b> check box to enable SNMP Trap alerts for this item.
<b>Send Mail</b>	Click the <b>[Enable]</b> check box to enable e-mail alerts for this item.
<b>Mail Subject</b>	Configures the subject line of the e-mail to be sent. The length of the subject line can be up to 255 alphanumeric characters.
<b>Mail Text</b>	Configures the text of the e-mail to be sent. The length of the text can be up to 1024 alphanumeric characters.

**Alert Settings (Continued)**

<b>Item</b>	<b>Description</b>
<b>Lamp Time Error</b>	Configures Lamp Time Error alert settings.
<b>SNMP Trap</b>	Click the <b>[Enable]</b> check box to enable SNMP Trap alerts for this item.
<b>Send Mail</b>	Click the <b>[Enable]</b> check box to enable e-mail alerts for this item.
<b>Mail Subject</b>	Configures the subject line of the e-mail to be sent. The length of the subject line can be up to 255 alphanumeric characters.
<b>Mail Text</b>	Configures the text of the e-mail to be sent. The length of the text can be up to 1024 alphanumeric characters.
<b>Cool Error</b>	Configures Cool Error alert settings.
<b>SNMP Trap</b>	Click the <b>[Enable]</b> check box to enable SNMP Trap alerts for this item.
<b>Send Mail</b>	Click the <b>[Enable]</b> check box to enable e-mail alerts for this item.
<b>Mail Subject</b>	Configures the subject line of the e-mail to be sent. The length of the subject line can be up to 255 alphanumeric characters.
<b>Mail Text</b>	Configures the text of the e-mail to be sent. The length of the text can be up to 1024 alphanumeric characters.
<b>Filter Error</b>	Configures Filter Error alert settings.
<b>SNMP Trap</b>	Click the <b>[Enable]</b> check box to enable SNMP Trap alerts for this item.
<b>Send Mail</b>	Click the <b>[Enable]</b> check box to enable e-mail alerts for this item.
<b>Mail Subject</b>	Configures the subject line of the e-mail to be sent. The length of the subject line can be up to 255 alphanumeric characters.
<b>Mail Text</b>	Configures the text of the e-mail to be sent. The length of the text can be up to 1024 alphanumeric characters.

**Alert Settings (Continued)**

Item	Description
<b>Other Error</b>	Configures Other Error alert settings.
<b>SNMP Trap</b>	Click the <b>[Enable]</b> check box to enable SNMP Trap alerts for this item.
<b>Send Mail</b>	Click the <b>[Enable]</b> check box to enable e-mail alerts for this item.
<b>Mail Subject</b>	Configures the subject line of the e-mail to be sent. The length of the subject line can be up to 255 alphanumeric characters.
<b>Mail Text</b>	Configures the text of the e-mail to be sent. The length of the text can be up to 1024 alphanumeric characters.
<b>Schedule Execution Error</b>	Configures Schedule Execution Error alert settings.
<b>SNMP Trap</b>	Click the <b>[Enable]</b> check box to enable SNMP Trap alerts for this item.
<b>Send Mail</b>	Click the <b>[Enable]</b> check box to enable e-mail alerts for this item.
<b>Mail Subject</b>	Configures the subject line of the e-mail to be sent. The length of the subject line can be up to 255 alphanumeric characters.
<b>Mail Text</b>	Configures the text of the e-mail to be sent. The length of the text can be up to 1024 alphanumeric characters.
<b>Lamp Time Alarm</b>	Configures Lamp Time Alarm alert settings.
<b>Alarm Time</b>	Configures the lamp time to alert.
<b>SNMP Trap</b>	Click the <b>[Enable]</b> check box to enable SNMP Trap alerts for this item.
<b>Send Mail</b>	Click the <b>[Enable]</b> check box to enable e-mail alerts for this item.
<b>Mail Subject</b>	Configures the subject line of the e-mail to be sent. The length of the subject line can be up to 255 alphanumeric characters.
<b>Mail Text</b>	Configures the text of the e-mail to be sent. The length of the text can be up to 1024 alphanumeric characters.

**Alert Settings (Continued)**

Item	Description
<b>Filter Time Alarm</b>	Configures Filter Time Alarm alert settings.
<b>Alarm Time</b>	Configures the filter time to alert.
<b>SNMP Trap</b>	Click the <b>[Enable]</b> check box to enable SNMP Trap alerts for this item.
<b>Send Mail</b>	Click the <b>[Enable]</b> check box to enable e-mail alerts for this item.
<b>Mail Subject</b>	Configures the subject line of the e-mail to be sent. The length of the subject line can be up to 255 alphanumeric characters.
<b>Mail Text</b>	Configures the text of the e-mail to be sent. The length of the text can be up to 1024 alphanumeric characters.
<b>Transition Detector Alarm</b>	Configures Transition Detector Alarm alert settings.
<b>SNMP Trap</b>	Click the <b>[Enable]</b> check box to enable SNMP Trap alerts for this item.
<b>Send Mail</b>	Click the <b>[Enable]</b> check box to enable e-mail alerts for this item.
<b>Mail Subject</b>	Configures the subject line of the e-mail to be sent. The length of the subject line can be up to 255 alphanumeric characters.
<b>Mail Text</b>	Configures the text of the e-mail to be sent. The length of the text can be up to 1024 alphanumeric characters.
<b>“CHANGE THE LAMP” is displayed</b>	Configures alert settings for when “CHANGE THE LAMP” is displayed.
<b>SNMP Trap</b>	Click the <b>[Enable]</b> check box to enable SNMP Trap alerts for this item.
<b>Send Mail</b>	Click the <b>[Enable]</b> check box to enable e-mail alerts for this item.
<b>Mail Subject</b>	Configures the subject line of the e-mail to be sent. The length of the subject line can be up to 255 alphanumeric characters.
<b>Mail Text</b>	Configures the text of the e-mail to be sent. The length of the text can be up to 1024 alphanumeric characters.
<b>Cold Start</b>	Configures Cold Start alert settings.
<b>SNMP Trap</b>	Click the <b>[Enable]</b> check box to enable SNMP Trap alerts for this item.
<b>Authentication Failure</b>	Configures Authentication Failure alert settings.
<b>SNMP Trap</b>	Click the <b>[Enable]</b> check box to enable SNMP Trap alerts for this item.

Click the **[Apply]** button to save the settings.



## Schedule Settings

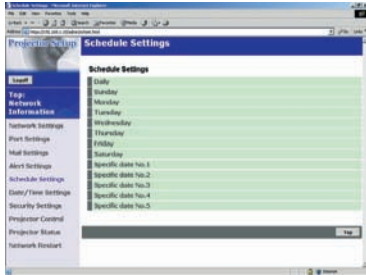

Displays and configures schedule settings.

Item	Description
<b>Daily</b>	Configures the daily schedule.
<b>Schedule</b>	Click the <b>[Enable]</b> check box to enable daily scheduling.
<b>Schedule List</b>	Displays the current daily schedule.
<b>Sunday</b>	Configures the Sunday schedule.
<b>Schedule</b>	Click the <b>[Enable]</b> check box to enable Sunday scheduling.
<b>Schedule List</b>	Displays the current Sunday schedule.
<b>Monday</b>	Configures the Monday schedule.
<b>Schedule</b>	Click the <b>[Enable]</b> check box to enable Monday scheduling.
<b>Schedule List</b>	Displays the current Monday schedule.
<b>Tuesday</b>	Configures the Tuesday schedule.
<b>Schedule</b>	Click the <b>[Enable]</b> check box to enable Tuesday scheduling.
<b>Schedule List</b>	Displays the current Tuesday schedule.
<b>Wednesday</b>	Configures the Wednesday schedule.
<b>Schedule</b>	Click the <b>[Enable]</b> check box to enable Wednesday scheduling.
<b>Schedule List</b>	Displays the current Wednesday schedule.
<b>Thursday</b>	Configures the Thursday schedule.
<b>Schedule</b>	Click the <b>[Enable]</b> check box to enable Thursday scheduling.
<b>Schedule List</b>	Displays the current Thursday schedule.
<b>Friday</b>	Configures the Friday schedule.
<b>Schedule</b>	Click the <b>[Enable]</b> check box to enable Friday scheduling.
<b>Schedule List</b>	Displays the current Friday schedule.
<b>Saturday</b>	Configures the Saturday schedule.
<b>Schedule</b>	Click the <b>[Enable]</b> check box to enable Saturday scheduling.
<b>Schedule List</b>	Displays the current Saturday schedule.

**Schedule Setting (Continued)**

Item	Description
<b>Specific date No.1</b>	Configures the specific date (No.1) schedule.
<b>Schedule</b>	Click the <b>[Enable]</b> check box to enable specific date (No.1) scheduling.
<b>Month/Day</b>	Configures the Month and date.
<b>Schedule List</b>	Displays the current specific date (No.1) schedule.
<b>Specific date No.2</b>	Configures the specific date (No.2) schedule.
<b>Schedule</b>	Click the <b>[Enable]</b> check box to enable specific date (No.2) scheduling.
<b>Month/Day</b>	Configures the Month and date.
<b>Schedule List</b>	Displays the current specific date (No.2) schedule.
<b>Specific date No.3</b>	Configures the specific date (No.3) schedule.
<b>Schedule</b>	Click the <b>[Enable]</b> check box to enable specific date (No.3) scheduling.
<b>Month/Day</b>	Configures the Month and date.
<b>Schedule List</b>	Displays the current specific date (No.3) schedule.
<b>Specific date No.4</b>	Configures the specific date (No.4) schedule.
<b>Schedule</b>	Click the <b>[Enable]</b> check box to enable specific date (No.4) scheduling.
<b>Month/Day</b>	Configures the Month and date.
<b>Schedule List</b>	Displays the current specific date (No.4) schedule.
<b>Specific date No.5</b>	Configures the specific date (No.5) schedule.
<b>Schedule</b>	Click the <b>[Enable]</b> check box to enable specific date (No.5) scheduling.
<b>Month/Day</b>	Set the Month and date.
<b>Schedule List</b>	Displays the current specific date (No.5) schedule.

Click the **[Apply]** button to save the settings.

### Schedule Setting (Continued)

To add additional functions and events click the **[Add]** button and set the following items.

Item	Description
<b>Time</b>	Configures the time to execute commands.
<b>Command</b>	Configures the commands to be executed.
<b>Power Parameter</b>	Configures the parameters for power control.
<b>Input Source Parameter</b>	Configures the parameters for input switching.
<b>Display Image Parameter</b>	Configures the parameters for display of transfer image data.

Click the **[Register]** button to add new commands to the Schedule List.

Click the **[Delete]** button to delete commands from the Schedule list.

### Date/Time Settings

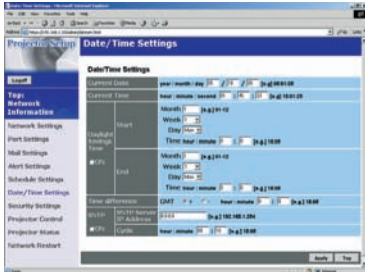

Displays and configures the date and time settings.

Item	Description
<b>Current Date</b>	Configures the current date in Year/Month/Day format.
<b>Current Time</b>	Configures the current time in Hour:Minute:Second format.

**Date/Time Settings (Continued)**

Item	Description
<b>Daylight Savings Time</b>	Click the <b>[ON]</b> check box to enable daylight savings time and set the following items.
<b>Start</b>	Configures the date and time daylight savings time begins.
<b>Month</b>	Configures the month daylight savings time begins (1~12).
<b>Week</b>	Configures the week of the month daylight savings time begins (First, 2, 3, 4, Last).
<b>Day</b>	Configures the day of the week daylight savings time begins (Sun, Mon, Tue, Wed, Thu, Fri, Sat).
<b>Hour</b>	Configures the hour daylight savings time begins (0 ~ 23).
<b>Minute</b>	Configures the minute daylight savings time begins (0 ~ 59).
<b>End</b>	Configures the date and time daylight savings time ends.
<b>Month</b>	Configures the month daylight savings time ends (1 ~ 12).
<b>Week</b>	Configures the week of the month daylight savings time ends (First, 2, 3, 4, Last).
<b>Day</b>	Configures the day of the week daylight savings time ends (Sun, Mon, Tue, Wed, Thu, Fri, Sat).
<b>Hour</b>	Configures the hour daylight savings time ends (0 ~ 23).
<b>Minute</b>	Configures the minute daylight savings time ends (0 ~ 59).
<b>Time difference</b>	Configures the time difference (hours:minutes). Set the same time difference as the one set on your PC. If unsure, consult your network administrator.
<b>SNTP</b>	Click the <b>[ON]</b> check box to retrieve Date and Time information from the SNTP server and set the following items.
<b>SNTP Server IP Address</b>	Configures the SNTP server address in IP format.
<b>Cycle</b>	Configures the interval at which to retrieve Date and Time information from the SNTP server. (hours:minutes).

Click the **[Apply]** button to save the settings.

**NOTE** • The new configuration settings are activated after restarting the network connection. The network connection must be restarted when the configuration settings are changed, The network connection can be restarted using **[Network Restart]** on the main menu.

- If you connect the projector to an existing network, consult a network administrator before setting server addresses.
- To enable the SNTP function, the time difference must be set.
- The projector will retrieve DATE and TIME information from the Timeserver and override time settings when SNTP is enabled.
- The Internal Clock's time may not remain accurate. Using SNTP is recommended to maintain accurate time.

## Security Settings

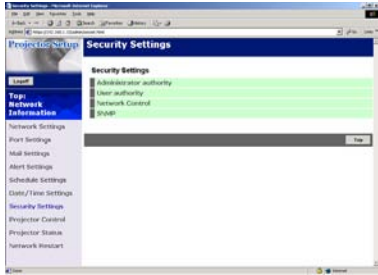

Displays and configures passwords and other security settings.

Item	Description
<b>Administrator authority</b>	Configures the Administrator ID and Password.
<b>Administrator ID</b>	Configures the Administrator ID. The length of the text can be up to 32 alphanumeric characters.
<b>Administrator Password</b>	Configures the Administrator Password. The length of the text can be up to 255 alphanumeric characters.
<b>Re-enter Administrator Password</b>	Re-enter the above password for verification.
<b>User authority</b>	Configures the User ID and Password.
<b>User ID</b>	Configures the User ID. The length of the text can be up to 32 alphanumeric characters.
<b>User Password</b>	Configures the User Password. The length of the text can be up to 255 alphanumeric characters.
<b>Re-enter User Password</b>	Used to re-enter the above password for verification.

**Security Settings (Continued)**

Item	Description
<b>Network Control</b>	Configures the Authentication Password for the command control.
<b>Authentication Password</b>	Configures the Authentication Password. The length of the text can be up to 16 alphanumeric characters.
<b>Re-enter Authentication Password</b>	Used to re-enter the above password for verification.
<b>SNMP</b>	Configures the community name if SNMP is used.
<b>Community Name</b>	Configures the community name. The length of the text can be up to 64 alphanumeric characters.

Click the **[Apply]** button to save the settings.

**NOTE** • The new configuration settings are activated after restarting the network connection. The network connection must be restarted when the configuration settings are changed. The network connection can be restarted using **[Network Restart]** on the main menu.

## Projector Control

### Projector Control

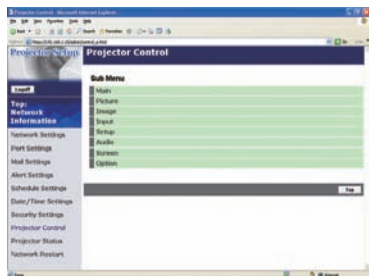

The items shown in the table below can be performed using the **[Projector Control]** menu. Select an item using the up and down arrow keys on the PC.

Most of the items have a submenu. Refer to the table below for details.

Controls the projector.

Item	Description
<b>Main</b>	
<b>Power</b>	Turns the power On/Off.
<b>Input Source</b>	Selects the input source.
<b>Picture Mode</b>	Selects the Picture Mode setting.
<b>Blank On/Off</b>	Turns Blank On/Off.
<b>Mute</b>	Turns Mute On/Off.
<b>Freeze</b>	Selects the Freeze setting.
<b>Magnify</b>	Controls the Magnify setting.
<b>Picture</b>	
<b>Brightness</b>	Adjusts the Brightness setting.
<b>Contrast</b>	Adjusts the Contrast setting.
<b>Gamma</b>	Selects the Gamma setting.
<b>Color Temp</b>	Selects the Color Temp setting.
<b>Color</b>	Adjusts the Color setting.
<b>Tint</b>	Adjusts the Tint setting.
<b>Sharpness</b>	Adjusts the Sharpness setting.
<b>Active Iris</b>	Selects the Active Iris setting.
<b>MyMemory Recall</b>	Recalls the MyMemory data.
<b>MyMemory Save</b>	Saves the MyMemory data.

**Projector Control (Continued)**

<b>Item</b>	<b>Description</b>
<b>Image</b>	
<b>Aspect</b>	Selects the Aspect setting.
<b>Over Scan</b>	Selects the Over Scan setting.
<b>V Position</b>	Adjusts the V Position.
<b>H Position</b>	Adjusts the H Position.
<b>H Phase</b>	Adjusts the H Phase.
<b>H Size</b>	Adjusts the H Size.
<b>Auto Adjust</b>	Performs Auto Adjustment.
<b>Input</b>	
<b>Progressive</b>	Selects the progressive setting.
<b>Video NR</b>	Selects the Video NR setting.
<b>3D-YCS</b>	Selects the 3D-YCS setting.
<b>Color Space</b>	Selects the Color Space.
<b>Component</b>	Selects the Component terminal setting.
<b>C-Video Format</b>	Selects the Video Format setting.
<b>S-Video Format</b>	Selects the S-Video Format setting.
<b>M1-D</b>	Selects the M1-D setting.
<b>Frame Lock</b>	Turns Frame Lock On/Off.
<b>RGB in-1</b>	Selects the RGB1 input signal type.
<b>RGB in-2</b>	Selects the RGB2 input signal type.
<b>Setup</b>	
<b>Aoto Keystone Execute</b>	Performs the Automatic keystone distortion correction.
<b>Keystone V</b>	Adjusts the Vertical Keystone setting.
<b>Keystone H</b>	Adjusts the Horizontal Keystone setting.
<b>Whisper</b>	Selects the Fan speed. (Normal or Whisper)
<b>Mirror</b>	Selects the Mirror status.



**Projector Control (Continued)**

<b>Item</b>	<b>Description</b>
<b>Audio</b>	
<b>Volume</b>	Adjusts the Volume setting.
<b>Treble</b>	Adjusts the Treble setting.
<b>Bass</b>	Adjusts the Bass setting.
<b>SRS WOW</b>	Selects the SRS WOW setting.
<b>Speaker</b>	Turns Speaker On/Off.
<b>Audio-RGB1</b>	Assigns the Audio-RGB1 input terminal.
<b>Audio-RGB2</b>	Assigns the Audio-RGB2 input terminal.
<b>Audio-M1-D</b>	Assigns the Audio-M1-D input terminal.
<b>Audio-Video</b>	Assigns the Audio-Video input terminal.
<b>Audio-S-Video</b>	Assigns the Audio-S-Video input terminal.
<b>Audio-Component</b>	Assigns the Audio-Component input terminal.
<b>Screen</b>	
<b>Language</b>	Selects the Language for the OSD.
<b>Menu Position V</b>	Adjusts the vertical Menu Position.
<b>Menu Position H</b>	Adjusts the horizontal Menu Position.
<b>Blank</b>	Selects the Blank mode.
<b>Startup</b>	Selects the Startup screen mode.
<b>MyScreen Lock</b>	Turns MyScreen Lock On/Off.
<b>Message</b>	Turns the Message function On/Off.
<b>Option</b>	
<b>Auto Search</b>	Turns the Automatic signal search function On/Off.
<b>Auto Keystone</b>	Turns the Automatic keystone distortion correction function On/Off.
<b>Auto on</b>	Turns the Auto on function On/Off.
<b>Auto off</b>	Configures the timer to shut off the projector when no signal is detected.
<b>My Button-1</b>	Assigns the functions for the MY BUTTON1 buttons on the included remote control.
<b>My Button-2</b>	Assigns the functions for the MY BUTTON2 buttons on the included remote control.
<b>Auto Adjust</b>	Enables/Disables Auto Adjustment.
<b>Remote Receiv. Front</b>	Enable/Disable Remote Receiv. Front.
<b>Remote Receiv. Rear</b>	Enable/Disable Remote Receiv. Rear.
<b>Remote Receiv. Top</b>	Enable/Disable Remote Receiv. Top.
<b>Remote Freq. Normal</b>	Enable/Disable Remote Freq. Normal.
<b>Remote Freq. High</b>	Enable/Disable Remote Freq. High.

## Projector Status



Displays and configures the current projector status.

Item	Description
<b>Error Status</b>	Displays the current error status
<b>Lamp Time</b>	Displays the usage time for the current lamp.
<b>Filter Time</b>	Displays the usage time for the current filter.
<b>Power Status</b>	Displays the current power status.
<b>Input Status</b>	Displays the current input signal source.
<b>Blank On/Off</b>	Displays the Blank On/Off status.
<b>Mute</b>	Displays the current Mute On/Off status.
<b>Freeze</b>	Displays the current Freeze On/Off status.

## Network Restart

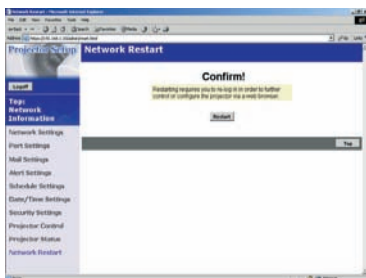

Restarts the projector's network connection.

Item	Description
<b>Restart</b>	Restarts the projector's network connection in order to activate new configuration settings.

**NOTE** • Restarting requires you to re-log on in order to further control or configure the projector via a web browser.

## Logoff

When logoff is clicked, the logon screen is displayed (📖6 : Fig. 1).

## Failure & Warning Alerts via E-mail

The projector can automatically send an alert to specified e-mail addresses when the projector requires maintenance or has encountered an error.

- NOTE** • Up to five e-mail addresses can be specified.
- The projector may be not able to send e-mail if the projector suddenly loses power.

### Mail Settings 10

To use the projector's e-mail function please configure the following items via a web browser.

**Example: If the IP address of the projector is set to 192.168.1.10:**

- 1) Enter [**https://192.168.1.10**] into the address bar of the web browser.
- 2) Enter the Administrator ID and Password and click [**Logon**].
- 3) Click [**Port Settings**] on the main menu.
- 4) Click the [**Enable**] check box to open the SMTP Port.
- 5) Click the [**Apply**] button to save the settings.

**NOTE** • A Network Restart is required after the SMTP Port configuration settings have changed. Click [**Network Restart**] and configure the following items.

- 6) Click [**Mail Settings**] and configure each item. Refer to the [**Mail Settings**] item in [**Configuring and Controlling the Projector via a Web Browser**] for further information.
- 7) Click the [**Apply**] button to save the settings.

**NOTE** • Click the [**Send Test Mail**] button in [**Mail Settings**] to confirm that the e-mail settings are correct. The following mail will be delivered to the specified addresses.

Subject line : Test Mail            <Projector name>  
Text            : Send Test Mail  
Date            <Testing date>  
Time            <Testing time>  
IP Address      <Projector IP address>  
MAC Address    <Projector MAC address>

**Mail Settings (Continued)**

- 8) Configure the Failure/Warning Alerts via E-mail settings. Click **[Alert Settings]** on the main menu.
- 9) Select and configure each alert item. Refer to **[Alert Settings]** in **[Configuring and Controlling the Projector via a Web Browser]** for further information.
- 10) Click the **[Apply]** button to save the settings.

Failure/Warning e-mails are formatted as follows:

Subject line	: <Mail title>	<Projector name>
Text	: <Mail text>	
	Date	<Failure/Warning date>
	Time	<Failure/Warning time>
	IP Address	<Projector IP address>
	MAC Address	<Projector MAC address>

## Projector management via SNMP

When SNMP is enabled, the projector is able to send Failure/Warning Alerts to a specified PC.

**NOTE** • It is recommended that SNMP functions be carried out by a network administrator.  
• SNMP management software must be installed on the computer to monitor the projector via SNMP.

### SNMP settings 9

Configure the following items via a web browser to use SNMP.

**Example: If the IP address of the projector is set to 192.168.1.10:**

- 1) Enter [**https://192.168.1.10**] into the address bar of the web browser.
- 2) Enter the Administrator ID and Password and click [**Logon**].
- 3) Click [**Port Settings**] on the main menu.
- 4) Click the [**Enable**] check box to open the SNMP Port.  
Set the IP address to send the SNMP Trap to when a Failure/Warning occurs.

**NOTE** • A Network Restart is required after the SNMP Trap configuration settings have been changed. Click [**Network Restart**] and configure the following items.

- 5) Click [**Security Settings**] on the main menu.
- 6) Click [**SNMP**] and set the Community Name on the screen that is displayed.

**NOTE** • A Network Restart is required after the Community Name has been changed.  
• Click [**Network Restart**] and configure the following items.

- 7) Configure the settings for Trap transmission of Failures/Warnings. Click [**Alert Settings**] on the main menu and select the Failure/Warning item to be configured.
- 8) Click the [**Enable**] check box to send out the SNMP trap for Failures/Warnings.  
Clear the [**Enable**] check box when SNMP trap transmission is not required.
- 9) Click the [**Apply**] button to save the settings.

## Controlling the Projector via Scheduling

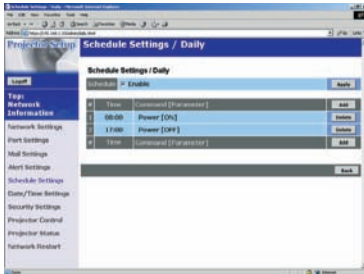

The projector can be automatically controlled via scheduling.

**NOTE** • You can schedule the following control events: Power ON/OFF, Input Source and Transferred Image Display.

- There are 3 types of Scheduling, 1) daily 2) day of the week 3) specific date.
- The priority for scheduled events is as follows 1) specific date 2) day of the week 3) daily.
- Up to five specific dates are available for scheduled events. Priority is given to those with the lower numbers when more than one event has been scheduled for the same date and time (e.g., 'Specific day No. 1' has priority over 'Specific day No. 2' and so on).
- Be sure to set the date and time before enabling scheduled events.

## Date/Time Settings (18)

The Date/Time setting can be adjusted via a web browser.

**Example: If the IP address of the projector is set to 192.168.1.10:**

- 1) Enter [**https://192.168.1.10**] into the address bar of the web browser.  
Enter the Administrator ID and Password and click [**Logon**].
- 2) Click [**Date/Time Settings**] on the main menu and configure each item.  
Refer to the [**Date/Time Settings**] item in [**Configuring and Controlling the Projector via a Web Browser**] for further information.
- 3) Click the [**Apply**] button to save the settings.

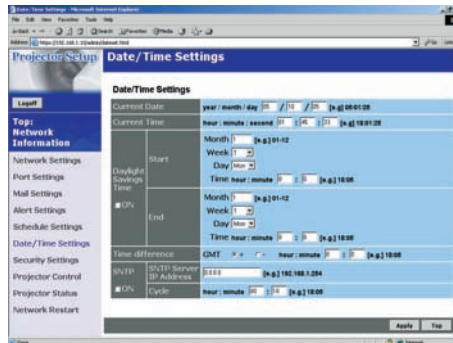

**NOTE** • A Network Restart is required after the Daylight Savings Time or SNTP configuration settings have been changed.

- The battery for the built in clock may be dead if the clock loses time even when the DATE and TIME have been set correctly. Replace the battery by following the instructions on replacing the battery.

([User's Manual - Operating Guide : Replacing Internal Clock battery](#))

- The Internal Clock's time may not remain accurate. Using SNTP is recommended to maintain accurate time.

## Schedule Settings 16

Schedule settings can be configured from a web browser.

**Example: If the IP address of the projector is set to 192.168.1.10:**

- 1) Enter [**https://192.168.1.10**] into the address bar of the web browser.
- 2) Enter the Administrator ID and Password and click [**Logon**].
- 3) Click [**Schedule Settings**] on the main menu and select the required schedule item.
- 4) Click the [**Enable**] check box to enable scheduling.
- 5) Enter the Date (Month/Day) for specific date scheduling.
- 6) Click [**Add**] and set the hour, command and parameters and click [**Add This Schedule**] when you want to add a command.
- 7) Click the [**Delete**] button when you want to delete a schedule.
- 8) Click the [**Apply**] button to save the settings.

There are three types of scheduling.

- 1) Daily: Perform the specified operation at a specified time every day.
- 2) Sunday ~ Saturday: Perform the specified operation at the specified time on a specified day of the week.
- 3) Specific Date: Perform the specified operation on the specified date and time.

**NOTE** • In Standby mode the power indicator will flash green for approx. 3 seconds when at least 1 “Power ON” schedule is saved.

- When the schedule function is used, the power cord must be connected to the projector and the outlet and the power switch must be turned on, [ | ]. The schedule function does not work when the power switch is turned off, [ O ] or the breaker in a room is tripped. The power indicator will lights orange or green when the projector gets is receiving the power.



### e-SHOT (Still Image Transfer) Display

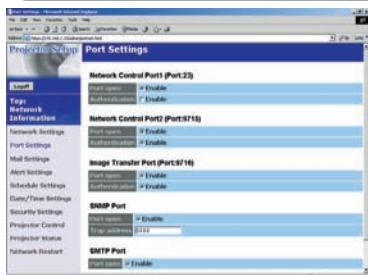

The projector can display a still image that is transferred via the network.

## Communication Port

The following port is used for e-SHOT.

TCP #9716



**NOTE** • e-SHOT is not available via communication ports which are used for the command control (TCP #23 and TCP #9715).

## e-SHOT (Still Image Transfer) Settings

Configure the following items from a web browser when e-SHOT is used.

**Example: If the IP address of the projector is set to 192.168.1.10:**

- 1) Enter [**https://192.168.1.10**] into the address bar of the web browser.
- 2) Enter the Administrator ID and Password and click [**Logon**].
- 3) Click [**Port settings**] on the main menu.
- 4) Click the [**Enable**] check box to open the [**Image Transfer Port (Port: 9716)**]. Click the [**Enable**] check box for the [**Authentication**] setting when authentication is required, otherwise clear the check box.
- 5) Click the [**Apply**] button to save the settings.

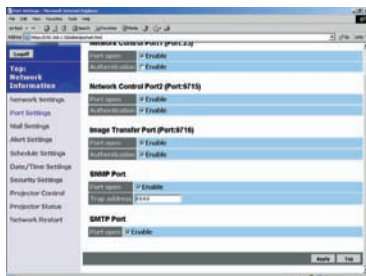

### **e-SHOT (Still Image Transfer) Settings (Continued)**

When the authentication setting is enabled, the following settings are required.

- 6) Click **[Security Settings]** on the main menu.
- 7) Select **[Network Control]** and enter the desired authentication password. \*  
see Note1
- 8) Click the **[Apply]** button to save the settings. \* see Note2

**NOTE1** • The Authentication Password will be the same for **[Network Control Port1 (Port: 23)]**, **[Network Control Port2 (Port: 9715)]**, and **[Image Transfer Port (Port: 9716)]**.

**NOTE2** • The new configuration settings are activated after restarting the network. Restart the network connection when any configuration settings are changed. The network connection can be restarted using **[Network Restart]** on the main menu.

### **e-SHOT (Still Image Transfer) Transmission**

e-SHOT transmission requires an exclusive application for your PC. You can download it from the Hitachi web site. Refer to the manual for the application for instructions.

### Command Control via the Network

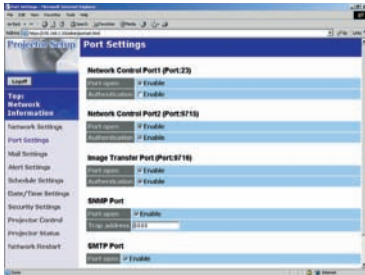

You can configure and control the projector via the network using RS-232C commands.

## Communication Port

The following two ports are assigned for the command control.

- TCP #23
- TCP #9715

**NOTE** • Command control is not available via communication port (TCP #9716) that is used for the e-SHOT transmission function.

## Command Control Settings (9)

Configure the following items from a web browser when command control is used.

**Example: If the IP address of the projector is set to 192.168.1.10:**

- 1) Enter [**https://192.168.1.10**] into the address bar of the web browser.
- 2) Enter the Administrator ID and Password and click [**Logon**].
- 3) Click [**Port settings**] on the main menu.
- 4) Click the [**Enable**] check box to open [**Network Control Port (Port: 23)**] to use TCP #23. Click the [**Enable**] check box for the [**Authentication**] setting when authentication is required, otherwise clear the check box.
- 5) Click the [**Enable**] check box to open [**Network Control Port (Port: 9715)**] to use TCP #9715. Click the [**Enable**] check box for the [**Authentication**] setting when authentication is required, otherwise clear the check box.
- 6) Click the [**Apply**] button to save the settings.

**Command Control Settings (Continued)**

When the authentication setting is enabled, the following settings are required.

(20)

- 7) Click [**Security Settings**] on the main menu.
- 8) Click [**Network Control**] and enter the desired authentication password. \* See Note1.
- 9) Click the [**Apply**] button to save the settings. \* See Note2.

**NOTE1** • The Authentication Password will be the same for [**Network Control Port1 (Port: 23)**], [**Network Control Port2 (Port: 9715)**], and [**Image Transfer Port (Port: 9716)**].

**NOTE2** • The new configuration settings are activated after restarting the network. Restart the network when any configuration settings are changed. The network connection can be restarted using [**Network Restart**] on the main menu.

## Command format

Command formats differ among the different communication ports.

TCP #23

You can use the RS-232C commands without any changes. The reply data format is the same as the RS-232C commands. However, the following reply will be sent back in the event of authentication failure when authentication is enabled.

<Reply in the event of an authentication error>

Reply	Error code	
0x1F	0x04	0x00

TCP #9715

## Send Data format

The following formatting is added to the header (0x02), Data length (0x0D), Checksum (1byte) and Connection ID (1 byte) of the RS-232C commands.

Header	Data length	RS-232Ccommand	Checksum	Connection ID
0x02	0x0D	13 bytes	1 byte	1 byte

- Header → 0x02, Fixed
- Data length → RS-232C commands byte length (0x0D, Fixed)
- RS-232C commands → RS-232C commands that start with 0xBE 0xEF (13 bytes)
- Check Sum → This is the value to make zero on the addition of the lower 8 bits from the header to the checksum.
- Connection ID → Random value from 0 to 255 (This value is attached to the reply data)

## Reply Data format

The connection ID (the data is same as the connection ID data on the sending data format) is attached to the RS-232C commands reply data.

<ACK reply>

Reply	Connection ID
0x06	1 byte

<NAK reply>

Reply	Connection ID
0x15	1 byte

<Error reply>

Reply	Error code	Connection ID
0x1C	2 bytes	1 byte

<Data reply>

Reply	Data	Connection ID
0x1D	2 bytes	1 byte

<Projector busy reply>

Reply	Status code	Connection ID
0x1F	2 bytes	1 byte

<Authentication error reply>

Reply	Authentication Error code		Connection ID
0x1F	0x04	0x00	1 byte

## Automatic Connection Break

The TCP connection will be automatically disconnected after there is no communication for 30 seconds after being established.

### Authentication

The projector does not accept commands without authentication success when authentication is enabled. The projector uses a challenge response type authentication with an MD5 (Message Digest 5) algorithm.

When the projector is using a LAN, a random eight bytes will be returned if authentication is enabled. Bind this received 8 bytes and the authentication password and digest this data with the MD5 algorithm and add this in front of the commands to send.

Following is a sample if the authentication password is set to "password" and the random eight bytes are "a572f60c".

- 1) Select the projector.
- 2) Receive the random eight bytes "a572f60c" from the projector.
- 3) Bind the random eight bytes "a572f60c" and the authentication password "password" and it becomes "a572f60cpassword".
- 4) Digest this bind "a572f60cpassword" with MD5 algorithm.  
It will be "e3d97429adffa11bce1f7275813d4bde".
- 5) Add this "e3d97429adffa11bce1f7275813d4bde" in front of the commands and send the data.  
Send "e3d97429adffa11bce1f7275813d4bde"+command.
- 6) When the sending data is correct, the command will be performed and the reply data will be returned. Otherwise, an authentication error will be returned.

Projector

# User's Manual - Safety Guide

---

Thank you for purchasing this projector.



**⚠ WARNING** • Before using, read these user's manuals of this projector to ensure correct usage through understanding. After reading, store them in a safe place for future reference. Incorrect handling of this product could possibly result in personal injury or physical damage. The manufacturer assumes no responsibility for any damage caused by mishandling that is beyond normal usage defined in these manuals of this projector.

**NOTE** • The information in this manual is subject to change without notice.

- The manufacturer assumes no responsibility for any errors that may appear in this manual.
- The reproduction, transmission or use of this document or contents is not permitted without express written authority.

## About The Symbols

Various symbols are used in this manual, the user's manual and on the product itself to ensure correct usage, to prevent danger to the user and others, and to prevent property damage. The meanings of these symbols are described below. It is important that you read these descriptions thoroughly and fully understand the contents.

 <b>WARNING</b>	This symbol indicates information that, if ignored, could possibly result in personal injury or even death due to incorrect handling.
 <b>CAUTION</b>	This symbol indicates information that, if ignored, could result possibly in personal injury or physical damage due to incorrect handling.

## Typical Symbols



This symbol indicates an additional warning (including cautions). An illustration is provided to clarify the contents.



This symbol indicates a prohibited action. The contents will be clearly indicated in an illustration or nearby (the symbol to the left indicates that disassembly is prohibited).



This symbol indicates a compulsory action. The contents will be clearly indicated in an illustration or nearby (the symbol to the left indicates that the power plug should be disconnected from the power outlet).



# Safety Precautions

## WARNING

### **Never use the projector if a problem should occur.**

Abnormal operations such as smoke, strange odor, no image, no sound, excessive sound, damaged casing or elements or cables, penetration of liquids or foreign matter, etc. can cause a fire or electrical shock.

In such case, immediately turn off the power switch and then disconnect the power plug from the power outlet. After making sure that the smoke or odor has stopped, contact your dealer. Never attempt to make repairs yourself because this could be dangerous.

- The power outlet should be close to the projector and easily accessible.

### **Use special caution for children and pets.**

Incorrect handling could result in fire, electrical shock, injury, burn or vision problem.

Use special caution in households where children and pets are present.

### **Do not insert liquids or foreign object.**

Penetration of liquids or foreign objects could result in fire or electrical shock.

Use special caution in households where children are present.

If liquids or foreign object should enter the projector, immediately turn off the power switch, disconnect the power plug from the power outlet and contact your dealer.

- Do not place the projector near water (ex. a bathroom, a beach, etc.).
- Do not expose the projector to rain or moisture. Do not place the projector outdoors.
- Do not place flower vases, pots, cups, cosmetics, liquids such as water, etc on or around the projector.
- Do not place metals, combustibles, etc on or around the projector.
- To avoid penetration of foreign objects, do not put the projector into a case or bag together with any thing except the accessories of the projector, signal cables and connectors.

### **Never disassemble and modify.**

The projector contains high voltage components. Modification and/or disassembly of the projector or accessories could result in fire or electrical shock.

- Never open the cabinet.
- Ask your dealer to repair and clean insides.

### **Do not give the projector any shock or impact.**

If the projector should be shocked and/or broken, it could result in an injury, and continued use could result in fire or electrical shock.

If the projector is shocked, immediately turn off the power switch, disconnect the power plug from the power outlet and contact your dealer.

### **Do not place the projector on an unstable surface.**

If the projector should be dropped and/or broken, it could result in an injury, and continued use could result in fire or electrical shock.

- Do not place the projector on an unstable, slant or vibrant surface such as a wobbly or inclined stand.
- Use the caster brakes placing the projector on a stand with casters.
- Do not place the projector in the side up position, the lens up position or the lens down position.
- In the case of a ceiling installation or the like, contact your dealer before installation.



Disconnect the plug from the power outlet.



Do not disassemble.



# Safety Precautions (continued)

## **WARNING**

### **Be cautious of High temperatures of the projector.**

High temperatures are generated when the lamp is lit. It could result in fire or burn. Use special caution in households where children are present.

Do not touch about the lens, air fans and ventilation openings during use or immediately after use, to prevent a burn. Take care of ventilation.

- Keep a space of 30 cm or more between the sides and other objects such as walls.
- Do not place the projector on a metallic table or anything weak in heat.
- Do not place anything about the lens, air fans and ventilation openings of the projector.
- Never block the air fan and ventilation openings.
- Do not cover the projector with a tablecloth, etc.
- Do not place the projector on a carpet or bedding.



### **Never look through the lens or openings when the lamp is on.**

The powerful light could adversely affect vision.

Use special caution in households where children are present.

### **Use only the correct power cord and the correct power outlet.**

Incorrect power supply could result in fire or electrical shock.

- Use only the correct power outlet depending on the indication on the projector and the safety standard.
- The enclosed power cord must be used depending on the power outlet to be used.



### **Be cautious of the power cord connection.**

Incorrect connection of the power cord could result in fire or electrical shock.

- Do not touch the power cord with a wet hand.
- Check that the connecting portion of the power cord is clean (with no dust), before using. Use a soft and dry cloth to clean the power plug.
- Insert the power plug into a power outlet firmly. Avoid using a loose, unsound outlet or contact failure.



### **Be sure to connect with ground wire.**

Connect the ground terminal of AC inlet of this unit with the ground terminal provided at the building using the correct power cord; otherwise, fire or electric shock can result.

- Don't take the core of power cord away.



Surely connect the ground wire.

# Safety Precautions (continued)

## **WARNING**

### **Be careful in handling the light source lamp.**

The projector uses a high-pressure mercury glass lamp made of glass. The lamp can break with a loud bang, or burn out. When the bulb bursts, it is possible for shards of glass to fly into the lamp housing, and for gas containing mercury to escape from the projector's vent holes.

**Please carefully read the section "Lamp".**

### **Be careful in handling the power cord and external connection cables.**

If you keep using a damaged the power cord or cables, it can cause a fire or electrical shock. Do not apply too much heat, pressure or tension to the power cord and cables.

If the power cord or cables is damaged (exposed or broken core wires, etc.), contact your dealer.

- Do not place the projector or heavy objects on the power cord and cables. Also, do not place a spread, cover, etc. over them because this could result in the inadvertent placing of heavy objects on the concealed power cord or cables.

- Do not pull the power cord and cables. When connecting and disconnecting the power cord or cables, do it with your hand holding the plug or connector.

- Do not place the cord near the heater.

- Avoid bending the power cord sharply.

- Do not attempt to work on the power cord.

### **Be careful in handling the battery of the remote control.**

Incorrect handling of the battery could result in fire or personal injury. The battery may explode if not handled properly.

- Keep the battery away from children and pets. If swallowed consult a physician immediately for emergency treatment.

- Do not allow the battery in a fire or water.

- Avoid fire or high-temperature environment.

- Do not hold the battery with the metallic tweezers.

- Keep the battery in a dark, cool and dry play.

- Do not short circuit the battery.

- Do not recharge, disassemble or solder the battery.

- Do not give the battery a physical impact.

- Use only the battery specified in the other manual of this projector.

- Make sure the plus and minus terminals are correctly aligned when loading the battery.

- If you observe a leakage of the battery, wipe out the flower and then replace the battery. If the flower adheres your body or clothes, rinse well with water.

- Obey the local laws on disposing the battery.



# Safety Precautions (continued)

## CAUTION

### **Be careful in moving the projector.**

Neglect could result in an injury or damage.

- Do not move the projector during use. Before moving, disconnect the power cord and all external connections, and close the slide lens door or attach the lens cap.
- Avoid any impact or shock to the projector.
- Do not drag the projector.
- For moving the projector, use the enclosed case or bag if provided.



### **Do not put anything on top of the projector.**

Placing anything on the projector could result in loss of balance or falling, and cause an injury or damage. Use special caution in households where children are present.



### **Do not attach anything other than specified things to the projector.**

Neglect could result in an injury or damage.

- Some projector has a screw thread in a lens part. Do not attach anything other than specified options (such as conversion lens) to the screw thread.



### **Avoid a smoky, humid or dusty place.**

Placing the projector in a smoke, a highly humid, dusty place, oily soot or corrosive gas could result in fire or electrical shock.

- Do not place the projector near a smoky, humid or dusty place (ex. a smoking space, a kitchen, a beach, etc.). Do not place the projector outdoors.
- Do not use a humidifier near the projector.



### **Take care of the air filter to normal ventilate.**

The air filter should be cleaned periodically. If the air filter becomes clogged by dust or the like, internal temperature rises and could cause malfunction. The projector may display the message such as "CHECK THE AIR FLOW" or turn off the projector, to prevent the internal heat level rising.

- When the indicators or a message prompts you to clean the air filter, clean the air filter as soon as possible.
- If the soiling will not come off the air filter, or it becomes damaged, replace the air filter.
- Use the air filter of the specified type only. Please order the air filter specified in the other manual of this projector to your dealer.
- When you replace the lamp, replace also the air filter. The air filter may be attached when you buy a replacement lamp for this projector.
- Do not turn on the projector without air filter.



### **Avoid a high temperature environment.**

The heat could have adverse influence on the cabinet of the projector and other parts. Do not place the projector, the remote control and other parts in direct sunlight or near a hot object such as heater, etc.



### **Avoid Magnetism.**

Manufacture strongly recommends to avoid any magnetic contact that is not shielded or protected on or near the projector itself. (ie., Magnetic Security Devices, or other projector accessory that contains magnetic material that has not been provided by the manufacture etc.) Magnetic objects may cause interruption of the projector's internal mechanical performance which may interfere with cooling fans speed or stopping, and may cause the projector to completely shut down.



# Safety Precautions (continued)

## CAUTION

### **Remove the power cord for complete separation.**

- For safety purposes, disconnect the power cord if the projector is not to be used for prolonged periods of time.
- Before cleaning, turn off and unplug the projector. Neglect could result in fire or electrical shock.

### **Ask your dealer to cleaning inside of the projector about every year.**

Accumulations of dust inside the projector cause result in fire or malfunction. Cleaning inside is more effective if performed before every humid periods such as rainy season.

- Do not clean inside yourself because it is dangerous.



Disconnect the plug from the power outlet.



## NOTE

### **Do not give the remote control any physical impact.**

A physical impact could cause damage or malfunction of the remote control.

- Take care not to drop the remote control.
- Do not place the projector or heavy objects on the remote control.

### **Take care of the lens.**

- Close the slide lens door or attach the lens cap to prevent the lens surface being scratched when the projector is not used.
- Do not touch the lens to prevent fog or dirt of the lens that cause deterioration of display quality.
- Use commercially available lens tissue to clean the lens (used to clean cameras, eyeglasses, etc.). Be careful not to scratch the lens with hard objects.

### **Take care of the cabinet and the remote control.**

Incorrect care could have adverse influence such as discoloration, peeling paint, etc.

- Use a soft cloth to clean the cabinet and control panel of the projector and the remote control. When excessively soiled dilute a neutral detergent in water, wet and wring out the soft cloth and afterward wipe with a dry soft cloth. Do not use undiluted detergent directly.
- Do not use an aerosol sprays, solvents, volatile substances or abrasive cleaner.
- Before using chemical wipes, be sure to read and observe the instructions.
- Do not allow long-term close contact with rubber or vinyl.

### **About bright spots or dark spots.**

Although bright spots or dark spots may appear on the screen, this is a unique characteristic of liquid crystal displays, and such do not constitute or imply a machine defect.

### **Be careful of printing of the LCD panel.**

If the projector continues projecting a still image, inactive images or 16:9 aspect images in case of 4:3 panel, etc., for long time, the LCD panel might possibly be printed.

# Safety Precautions (continued)

## NOTE

### **About consumables.**

Lamp, LCD panels, polarizers and other optical components, and air filter and cooling fans have a different lifetime in each. These parts may need to be replaced after a long usage time.

- This product isn't designed for continuous use of long time. In the case of continuous use for 6 hours or more, or use for 6 hours or more every day (even if it isn't continuous), or repetitious use, the lifetime may be shortened, and these parts may need to be replaced even if one year has not passed since the beginning of using.
- Any inclining use beyond the adjustment range explained in these user's manuals may shorten the lifetimes of the consumables.

### **Before turning on the power, make the projector cool down adequately.**

After turning the projector off, pushing the restart switch or interrupting of the power supply, make the projector cool down adequately. Operation in a high temperature state of the projector causes a damage of the electrode and un-lighting of the lamp.

### **Avoid strong rays.**

Any strong ray (such as direct rays of the sun or room lighting) onto the remote control sensors could invalidate the remote control.

### **Avoid radio interference.**

Any interfering radiation could cause disordered image or noises.

- Avoid radio generator such as a mobile telephone, transceiver, etc. around the projector.

### **About displaying characteristic.**

The display condition of the projector (such as color, contrast, etc.) depends on characteristic of the screen, because the projector uses a liquid crystal display panel. The display condition can differ from the display of CRT.

- Do not use a polarized screen. It can cause red image.

### **Turn the power on/off in right order.**

To prevent any trouble, turn on/off the projector in right order mentioned below unless specifying.

- Power on the projector before the computer or video tape recorder.
- Power off the projector after the computer or video tape recorder.

### **Take care not to fatigue your eyes.**

Rest the eyes periodically.

### **Set the sound volume at a suitable level to avoid bothering other people.**

- It is better to keep the volume level low and close the windows at night to protect the neighborhood environment.

### **Connecting with notebook computer**

When connecting with notebook computer, set to valid the RGB external image output (setting CRT display or simultaneous display of LCD and CRT).

Please read instruction manual of the notebook for more information.

# Lamp

## **WARNING**



HIGH VOLTAGE



HIGH TEMPERATURE



HIGH PRESSURE

The projector uses a high-pressure mercury glass lamp. The lamp can **break with a loud bang, or burn out**, if jolted or scratched, handled while hot, or worn over time. Note that each lamp has a different lifetime, and some may burst or burn out soon after you start using them. In addition, when the bulb bursts, it is possible for **shards of glass** to fly into the lamp housing, and for **gas containing mercury** to escape from the projector's vent holes.

**About disposal of a lamp** • This product contains a mercury lamp; do not put in trash. Dispose of in accord with environmental laws.

For lamp recycling, go to [www.lamprecycle.org](http://www.lamprecycle.org). (in USA)

For product disposal, contact your local government agency or [www.eiae.org](http://www.eiae.org) (in the US) or [www.epsc.ca](http://www.epsc.ca) (in Canada).

For more information, call your dealer.



Disconnect  
the plug from  
the power  
outlet

- If the lamp should break (it will make a loud bang when it does), unplug the power cord from the outlet, and make sure to request a replacement lamp from your local dealer. Note that shards of glass could damage the projector's internals, or cause injury during handling, so please do not try to clean the projector or replace the lamp yourself.
- If the lamp should break (it will make a loud bang when it does), ventilate the room well, and make sure not to breathe the gas that comes out of the projector vents, or get it in your eyes or mouth.
- Before replacing the lamp, make sure the power switch is off and the power cable is not plugged in, then wait at least 45 minutes for the lamp to cool sufficiently. Handling the lamp while hot can cause burns, as well as damaging the lamp.



- Do not open the lamp cover while the projector is suspended from above. This is dangerous, since if the lamp's bulb has broken, the shards will fall out when the cover is opened. In addition, working in high places is dangerous, so ask your local dealer to have the lamp replaced even if the bulb is not broken.
- Do not use the projector with the lamp cover removed. At the lamp replacing, make sure that the screws are screwed in firmly. Loose screws could result in damage or injury.



- Use the lamp of the specified type only.
- If the lamp breaks soon after the first time it is used, it is possible that there are electrical problems elsewhere besides the lamp. If this happens, contact your local dealer or a service representative.
- Handle with care: jolting or scratching could cause the lamp bulb to burst during use.
- Using the lamp for long periods of time, could cause it dark, not to light up or to burst. When the pictures appear dark, or when the color tone is poor, please replace the lamp as soon as possible. Do not use old (used) lamps; this is a cause of breakage.

# Regulatory Notices

## FCC Statement Warning

**WARNING:** This equipment has been tested and found to comply with the limits for a Class B digital device, pursuant to Part 15 of the FCC Rules. These limits are designed to provide reasonable protection against harmful interference in a residential installation. This equipment generates, uses, and can radiate radio frequency energy and, if not installed and used in accordance with the instructions, may cause harmful interference to radio communications. However, there is no guarantee that interference will not occur in a particular installation. If this equipment does cause harmful interference to radio or television reception, which can be determined by turning the equipment off and on, the user is encouraged to try to correct the interference by one or more of the following measures:

- Reorient or relocate the receiving antenna.
- Increase the separation between the equipment and receiver.
- Connect the equipment into an outlet on a circuit different from that to which the receiver is connected.
- Consult the dealer or an experienced radio/TV technician for help.

**INSTRUCTIONS TO USERS:** This equipment complies with the requirements of FCC (Federal Communication Commission) equipment provided that the following conditions are met. Some cables have to be used with the core set. Use the accessory cable or a designated-type cable for the connection. For cables that have a core only at one end, connect the core to the projector.

**CAUTION:** Changes or modifications not expressly approved by the party responsible for compliance could void the user's authority to operate the equipment.

## For the Customers in CANADA

**NOTICE:** This Class B digital apparatus complies with Canadian ICES-003.

# Warranty And After-Service

Unless seen any abnormal operations (mentioned with the first paragraph of WARNING in this manual), when a problem occurs with the equipment, first refer to the "Troubleshooting" section of the "Operating Guide", and run through the suggested checks. If this does not resolve the problem contact your dealer or service company. They will tell you what warranty condition is applied.



---

2900 Dukane Drive  
St. Charles, Illinois 60174  
[www.dukcorp.com/av](http://www.dukcorp.com/av)

Toll-free: 800-676-2487  
Fax: 630-584-5156  
e-mail: [avsales@dukcorp.com](mailto:avsales@dukcorp.com)

*Audio Visual Products*

***DUKANE***

## Free Manuals Download Website

<http://myh66.com>

<http://usermanuals.us>

<http://www.somanuals.com>

<http://www.4manuals.cc>

<http://www.manual-lib.com>

<http://www.404manual.com>

<http://www.luxmanual.com>

<http://aubethermostatmanual.com>

Golf course search by state

<http://golfingnear.com>

Email search by domain

<http://emailbydomain.com>

Auto manuals search

<http://auto.somanuals.com>

TV manuals search

<http://tv.somanuals.com>