

## Projector

**8970/8971/8972W/8973W/  
8976SX/8974WU/8975WU**

**DUKANE**

## User's Manual (detailed) Operating Guide

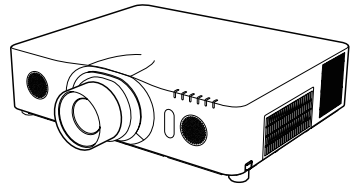

Thank you for purchasing this projector.

**⚠ WARNING** ▶ Before using this product, please read all manuals for this product. Be sure to read **Safety Guide** first. After reading them, store them in a safe place for future reference.

### About this manual

Various symbols are used in this manual. The meanings of these symbols are described below.

- ⚠ WARNING** This symbol indicates information that, if ignored, could possibly result in personal injury or even death due to incorrect handling.
- ⚠ CAUTION** This symbol indicates information that, if ignored, could possibly result in personal injury or physical damage due to incorrect handling.
- NOTICE** This entry notices of fear of causing trouble.
  -  Please refer to the pages written following this symbol.

**NOTE** • The information in this manual is subject to change without notice.  
• The manufacturer assumes no responsibility for any errors that may appear in this manual.  
• The reproduction, transfer or copy of all or any part of this document is not permitted without express written consent.

### Trademark acknowledgment

- Mac<sup>®</sup> is a registered trademark of Apple Inc.
- Windows<sup>®</sup>, DirectDraw<sup>®</sup> and Direct3D<sup>®</sup> are registered trademarks of Microsoft Corporation in the U.S. and/or other countries.
- VESA and DDC are trademarks of the Video Electronics Standard Association.
- HDMI<sup>™</sup>, the HDMI logo, and High-Definition Multimedia Interface are trademarks or registered trademarks of HDMI Licensing LLC in the United States and other countries.
- Trademark PJLink is a trademark applied for trademark rights in Japan, the United States of America and other countries and areas.
- Blu-ray Disc<sup>™</sup> and Blu-ray<sup>™</sup> are trademarks of Blu-ray Disc Association.
- DICOM<sup>®</sup> is the registered trademark of the National Electrical Manufacturers Association for its standards publications relating to digital communications of medical information.

**PJLink<sup>™</sup>**

All other trademarks are the properties of their respective owners.

# Contents



<b>Introduction</b> .....	<b>3</b>	<b>EASY MENU</b> .....	<b>40</b>
Features .....	3	<b>PICTURE menu</b> .....	<b>42</b>
Checking the contents of package .....	3	<b>IMAGE menu</b> .....	<b>45</b>
Part names .....	4	<b>INPUT menu</b> .....	<b>48</b>
Projector, Control panel and Indicators, Ports, Remote control .....		<b>SETUP menu</b> .....	<b>52</b>
<b>Setting up</b> .....	<b>7</b>	<b>AUDIO menu</b> .....	<b>55</b>
Arrangement .....	7	<b>SCREEN menu</b> .....	<b>57</b>
Connecting with your devices .....	10	<b>OPTION menu</b> .....	<b>63</b>
Fastening the cables .....		<b>NETWORK menu</b> .....	<b>74</b>
Fastening the adapter cover .....	15	<b>SECURITY menu</b> .....	<b>85</b>
Using the security bar and slot .....	15	<b>Presentation tools</b> .....	<b>92</b>
Connecting to a power supply .....	16	PC-LESS Presentation .....	92
<b>Remote control</b> .....	<b>17</b>	Thumbnail Mode, Full Screen Mode, Slideshow Mode, Playlist .....	
Installing the batteries .....	17	Drawing function .....	102
Using the REMOTE ID function .....	17	Connecting the devices, Using the Drawing function .....	
Changing the frequency of remote control signal .....	18	USB Display .....	107
About the remote control signal .....	18	Starting USB Display, Right-Click menu, Floating menu, Options window .....	
Using as a simple PC mouse & keyboard .....	19	<b>Maintenance</b> .....	<b>111</b>
<b>Status Monitor</b> .....	<b>20</b>	Replacing the lamp .....	111
<Only for 8971, 8973W and 8975WU>		Cleaning and replacing the air filter .....	113
Displaying the condition of the projector .....	20	Other care .....	115
Displaying the log .....	22	<b>Troubleshooting</b> .....	<b>116</b>
<b>Power on/off</b> .....	<b>24</b>	Warnings displayed on the Status Monitor .....	116
Turning on the power .....	24	Related messages .....	116
Turning off the power .....	24	Regarding the indicator lamps .....	118
<b>Operating</b> .....	<b>25</b>	Resetting all settings .....	120
Adjusting the volume .....	25	Phenomena that may be easy to be mistaken for machine defects .....	121
Temporarily turning off the screen and audio .....	25	<b>Specifications</b> .....	<b>126</b>
Selecting an input signal .....	26		
Selecting an aspect ratio .....	27		
Adjusting the projector's elevator .....	28		
Adjusting the lens .....	29		
Adjusting the zoom and focus, Adjusting the lens position, Lens memory .....			
Using the automatic adjustment feature .....	31		
Adjusting the position .....	31		
Correcting the distortion .....	32		
Using the magnify feature .....	35		
Temporarily freezing the screen .....	36		
Temporarily shading the screen .....	36		
Using the menu function .....	37		
Indication in OSD, Containing items of each menu .....			

## Introduction

### Features

The projector provides you with the broad use by the following features.

- ✓ The **HDMI** ports can support various image equipment which have digital interface to get clearer pictures on a screen.
- ✓ The super bright lamp and high quality optical system can fulfill the demands of professional uses.
- ✓ Some optional lens units and the wide range of the lens shift feature will give much more chances to install the product wherever you want.
- ✓ The lens shade can hide your inside operations and will help your presentation.
- ✓ The wealth of I/O ports is believed to support any business scene.

### Checking the contents of package

Please see the **Contents of package** section in the **User's Manual (concise)** which is a book. Your projector should come with the items shown there. Require of your dealer immediately if any items are missing.

**⚠ WARNING** ► Keep small parts away from children and pets. Take care not to put in the mouth. If swallowed, consult a physician immediately for emergency treatment.

**NOTE** • Keep the original packing materials, for future reshipment. Be sure to use the original packing materials when moving the projector. Use special caution for the lens.

- The projector may make a rattling sound when tilted, moved or shaken, since a flap to control the air flow inside of the projector has moved. Be aware that this is not a failure or malfunction.

**Note:** The Dukane models described in the document are manufactured by Hitachi and use the same firmware and software programs. The equivalent Dukane to Hitachi models are 8970 (CP-X8150), 8971(CP-X8160), 8972W (CP-WX8240), 8973W (CP-WX8255), 8974WU (CP-WU8440), 8975WU (CP-WU8450), 8976SX (CP-SX8350).

## Part names

### Projector

- (1) Lamp cover (📖111)  
The lamp unit is inside.
- (2) Speakers (x2) (📖25, 55)
- (3) Filter cover (📖113)  
The air filter and intake vent are inside.
- (4) Elevator feet (x2) (📖28)
- (5) Elevator buttons (x2) (📖28)
- (6) Remote sensors (x2) (📖18, 69)
- (7) Lens
- (8) Lens cover
- (9) Indicators (📖5)
- (10) Intake vents
- (11) Control panel (📖5)
- (12) Status Monitor (📖20)  
<Only for 8971, 8973W and 8975WU>
- (13) **AC IN** (AC inlet) (📖16)
- (14) Exhaust vents
- (15) Ports (📖5)
- (16) Security bar (📖15)
- (17) Security slot (📖15)
- (18) Grip (📖below)
- (19) Safety bar (📖15)

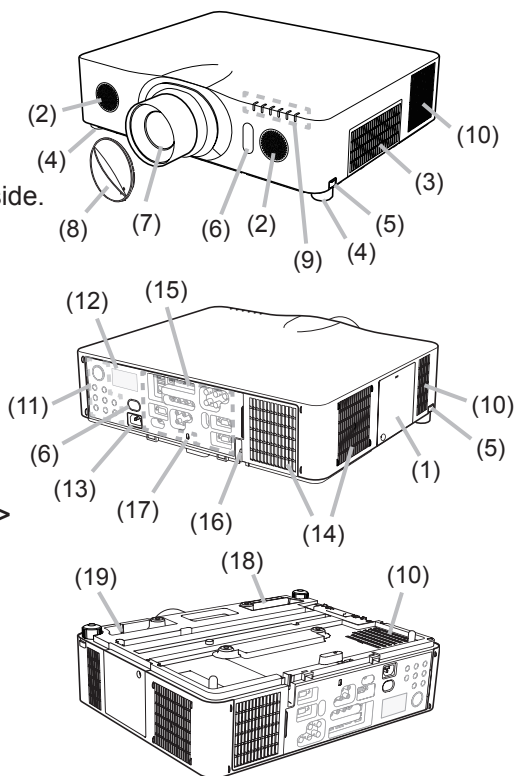

**⚠ WARNING** ▶ Do not open or remove any portion of the product, unless the manuals direct it.

▶ Do not subject the projector to unstable conditions.  
▶ Do not apply a shock or pressure to this product. Place your hands on the grip on the bottom of the projector when carrying the projector. Remove all the attachments including the power cord and cables, from the projector when carrying the projector.

▶ Do not look into the lens and the openings on the projector while the lamp is on.

**⚠ CAUTION** ▶ Do not touch around the lamp cover and the exhaust vents during use or just after use, since it is too hot.

▶ Do not attach anything onto the lens except the lens cover of this projector because it could damage the lens, such as melting the lens.

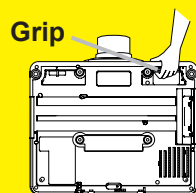

(continued on next page)

## Part names (continued)

## Control panel and Indicators

- (1) **STANDBY/ON** button (📖 24)
- (2) **INPUT** button (📖 26, 37)
- (3) **MENU** button (📖 37)
- (4) **LENS SHIFT** button (📖 29)
- (5) **ZOOM** button (📖 29)
- (6) **FOCUS - / +** buttons (📖 29)
- (7) **SHADE** button (📖 36)
- (8) **FUNCTION** button (📖 22, 29)
- (9) **FILTER** indicator (📖 120)
- (10) **SHADE** indicator (📖 36)
- (11) **SECURITY** indicator (📖 91)
- (12) **LAMP** indicator (📖 118, 119)
- (13) **TEMP** indicator (📖 118, 119)
- (14) **POWER** indicator (📖 24, 118, 119)

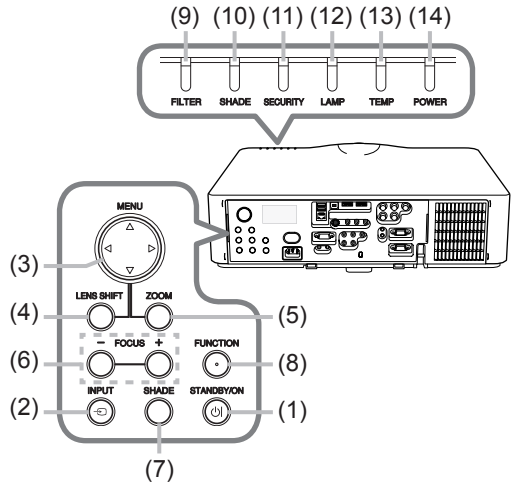

## Ports (📖 10 ~ 14)

- |  |                                     |
|--|-------------------------------------|
| (1) <b>COMPUTER IN1</b> port                                   | (9) <b>S-VIDEO</b> port             |
| (2) <b>COMPUTER IN2</b> ports<br>(G/Y, B/Cb/Pb, R/Cr/Pr, H, V) | (10) <b>VIDEO</b> port              |
| (3) <b>LAN</b> port  | (11) <b>AUDIO IN1</b> port          |
| (4) <b>USB TYPE A</b> ports                                    | (12) <b>AUDIO IN2</b> port          |
| (5) <b>USB TYPE B</b> port                                     | (13) <b>AUDIO IN3 (L, R)</b> ports  |
| (6) <b>HDMI 1</b> port   | (14) <b>AUDIO OUT (L, R)</b> ports  |
| (7) <b>HDMI 2</b> port   | (15) <b>MONITOR OUT</b> port        |
| (8) <b>COMPONENT</b> ports<br>(Y, Cb/Pb, Cr/Pr)                | (16) <b>REMOTE CONTROL IN</b> port  |
|  | (17) <b>REMOTE CONTROL OUT</b> port |
|  | (18) <b>CONTROL</b> port            |

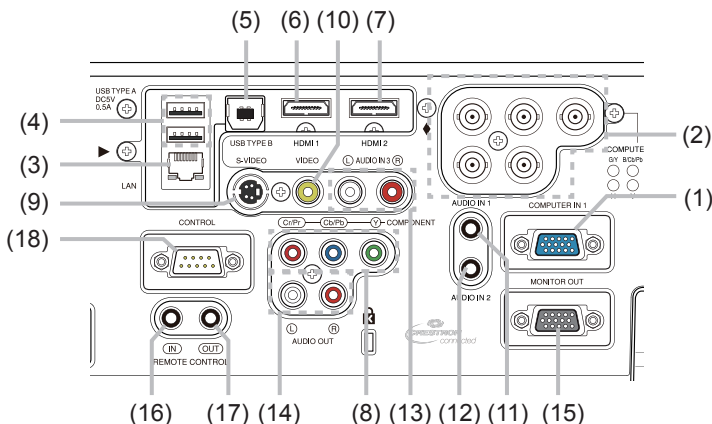

(continued on next page)

## Part names (continued)

## Remote control

- 
- (1) **STANDBY** button (📖24)
- (2) **ON** button (📖24)
- (3) **ID - 1 / 2 / 3 / 4** buttons (📖17)
- (4) **COMPUTER 1** button (📖26)
- (5) **COMPUTER 2** button (📖26)
- (6) **COMPUTER 3** button \*
- (7) **LAN** button (📖26)
- (8) **USB TYPE A** button (📖26)
- (9) **USB TYPE B** button (📖26)
- (10) **COMPONENT** button (📖26)
- (11) **S-VIDEO** button (📖26)
- (12) **VIDEO** button (📖26)
- (13) **HDMI 1** button (📖26)
- (14) **HDMI 2** button (📖26)
- (15) **DIGITAL** button \*
- (16) **PAGE UP / PAGE DOWN** buttons (📖19, 94)
- (17) **F5** button (📖18, 19)
- (18) **ENTER** button (📖19, 22, 37)
- (19) **RESET** button (📖37)
- (20) **ESC** button (📖19, 37)
- (21) **▲/▼/◀/▶** cursor buttons
- (22) **MENU** button (📖37)
- (23) **VOL + / -** buttons (📖25)
- (24) **AV MUTE** button (📖25)
- (25) **MAGNIFY ON / OFF** buttons (📖35)
- (26) **FREEZE** button (📖36)
- (27) **PbyP** button ◦
- (28) **ASPECT** button (📖27)
- (29) **AUTO** button (📖31)
- (30) **POSITION** button (📖30, 31, 38)
- (31) **KEystone** button (📖32)
- (32) **MY BUTTON - 1, 2, 3, 4** buttons (📖66)
- (33) **LENS SHIF** button (📖29)
- (34) **LENS MEMORY** button (📖30)
- (35) **FOCUS + / -** buttons (📖29)
- (36) **ZOOM + / -** buttons (📖29)
- (37) Battery cover (📖17)
- (38) Wired remote control port (📖14)

**NOTE** • Any button marked with “\*” is not supported on this projector (📖117).  
 • Any button marked with “◦” is available only for **8974WU** and **8975WU**.  
 • Each time you press any button (except **ID** buttons), the **ID** button of current selected ID number will light (📖17).

## Setting up

Install the projector according to the environment and manner the projector will be used in.

For the case of installation in a special state such as ceiling mount, the specified mounting accessories ([Specifications](#) in the **User's Manual (concise)**) and service may be required. Before installing the projector, consult your dealer about your installation.

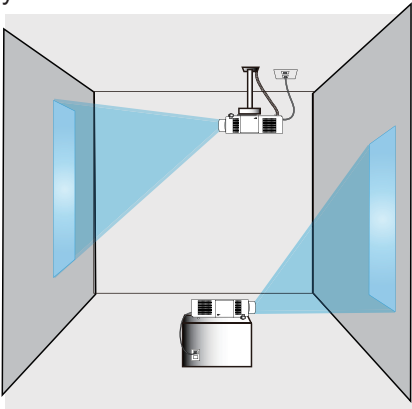

## Arrangement

Refer to tables **T-1** to **T-6** at the back of **User's Manual (concise)** as well as the following to determine the screen size and projection distance. The values shown in the table are calculated for a full size screen.

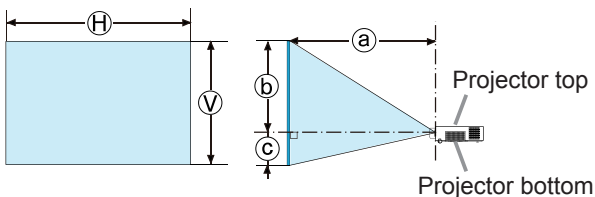

- Ⓜ × Ⓥ : Screen size
- ⓐ : Projection distance  
(from the front of the projector unit)
- ⓑ , ⓒ : Screen height

(continued on next page)

**Arrangement (continued)**

**⚠ WARNING ▶ Install the projector where you can access the power outlet easily.** If an abnormality should occur, unplug the projector urgently. Otherwise it could cause a fire or electric shock.

**▶ Do not subject the projector to unstable conditions.** If the projector falls or topples over, it could result in injury or damage to the projector and the surrounding things. Using a damaged projector could result in a fire and an electric shock.

- Do not place the projector in unstable places, such as an inclined surface, places subject to vibration, on top of a wobbly table or cart, or a surface that is smaller than the projector.
- Do not put the projector on its side, front or rear position.
- Do not attach nor place anything on the projector unless otherwise specified in the manual.
- Do not use any mounting accessories except the accessories specified by the manufacturer. Read and keep the manuals of the accessories used.
- For special installation such as ceiling mounting, be sure to consult your dealer beforehand.
- Only for **8971**, **8973W** and **8975WU**, it is possible to install the projector for any direction with specified mounting accessories. Consult with your dealer about such a special installation.
- Place your hands on the grip on the bottom of the projector when carrying the projector. Remove all the attachments including the power cord and cables, from the projector when carrying the projector.

**▶ Do not install the projector near thermally conductive or flammable things.** Such things when heated by the projector could result in a fire and burns.

- Do not place the projector on a metal stand.

**▶ Do not place the projector where any oils, such as cooking or machine oil, are used.** Oil may harm the product, resulting in malfunction, or falling from the mounted position.

**▶ Do not place the projector in a place where it may get wet.** Getting the projector wet or inserting liquid into the projector could cause a fire and an electric shock, and damage the projector.

- Do not place the projector near water, such as in a bathroom, kitchen, or poolside.
- Do not place the projector outdoors or by the window.
- Do not place anything containing liquid near the projector.

(continued on next page)



**Arrangement (continued)**

**⚠ CAUTION** ► **Place the projector in a cool place with sufficient ventilation.** The projector may shutdown automatically or may malfunction if its internal temperature is too high.

Using a damaged projector could result in a fire and an electric shock.

- Do not place the projector in direct sunlight or near hot objects such as heaters.
- Do not place the projector where the air from an air conditioner or similar unit will blow on it directly.
- Keep a space of 30 cm or more between a side of the projector and other objects such as walls.
- Do not place the projector on carpet, cushions or bedding.
- Do not stop up, block nor cover the projector's vent holes. Do not place anything around the projector that could be sucked in or stuck to the projector's intake vents.
- Do not place the projector at places that are exposed to magnetic fields, doing so can cause the cooling fans inside the projector to malfunction.

► **Avoid placing the projector in smoky, humid or dusty place.** Placing the projector in such places could cause a fire, an electric shock and malfunction of the projector.

- Do not place the projector near humidifiers. Especially for an ultrasonic humidifier, chlorine and minerals contained in tap water are atomized and could be deposited in the projector causing image degradation or other problems.
- Do not place the projector in a smoking area, kitchen, passageway or by the window.

**NOTICE** • Position the projector to prevent light from directly hitting the projector's remote sensor.

- Do not place the product in a place where radio interference may be caused.
- Set the ALTITUDE of the SERVICE item in the OPTION menu correctly. It is recommended to leave it at AUTO usually (📖67). If the projector is used with a wrong setting, it may cause damage to the projector itself or the parts inside.
- Keep heat-sensitive things away from the projector. Otherwise, they may be damaged by the heat from the projector.

## Connecting with your devices

Before connecting the projector to a device, consult the manual of the device to confirm that the device is suitable for connecting with this projector and prepare the required accessories, such as a cable in accord with the signal of the device. Consult your dealer when the required accessory did not come with the product or the accessory is damaged.

After making sure that the projector and the devices are turned off, perform the connection, according to the following instructions. Refer to the figures in subsequent pages.

Before connecting the projector to a network system, be sure to read **Network Guide** too.

**⚠ WARNING** ▶ Use only the appropriate accessories. Otherwise it could cause a fire or damage the projector and devices.

- Use only the accessories specified or recommended by the projector's manufacturer. It may be regulated under some standard.
- Neither disassemble nor modify the projector and the accessories.
- Do not use the damaged accessory. Be careful not to damage the accessories. Route a cable so that it is neither stepped on nor pinched out.

**⚠ CAUTION** ▶ For a cable with a core at only one end, connect the end with the core to the projector. That may be required by EMI regulations.

**NOTE** • Do not turn on or off the projector while connected to a device in operation, unless that is directed in the manual of the device. Otherwise it may cause malfunction in the device or projector.

- The function of some input ports can be selected according to your usage requirements. Check the reference page indicated beside each port in the following illustration.
- Be careful not to mistakenly connect a connector to a wrong port. Otherwise it may cause malfunction in the device or projector.
  - When connecting a connector to a port, make sure that the shape of the connector fits the port.
  - Tighten the screws to connect a connector equipped with screws to a port.
  - Use the cables with straight plugs, not L-shaped ones, as the input ports of the projector are recessed.

### About Plug-and-Play capability

- Plug-and-Play is a system composed of a computer, its operating system and peripheral equipment (i.e. display devices). This projector is VESA DDC 2B compatible. Plug-and-Play can be used by connecting this projector to a computer that is VESA DDC (display data channel) compatible.
  - Take advantage of this feature by connecting a computer cable to the **COMPUTER IN1** port (DDC 2B compatible). Plug-and-Play may not work properly if any other type of connection is attempted.
  - Please use the standard drivers in your computer as this projector is a Plug-and-Play monitor.

(continued on next page)

## Connecting with your devices (continued)

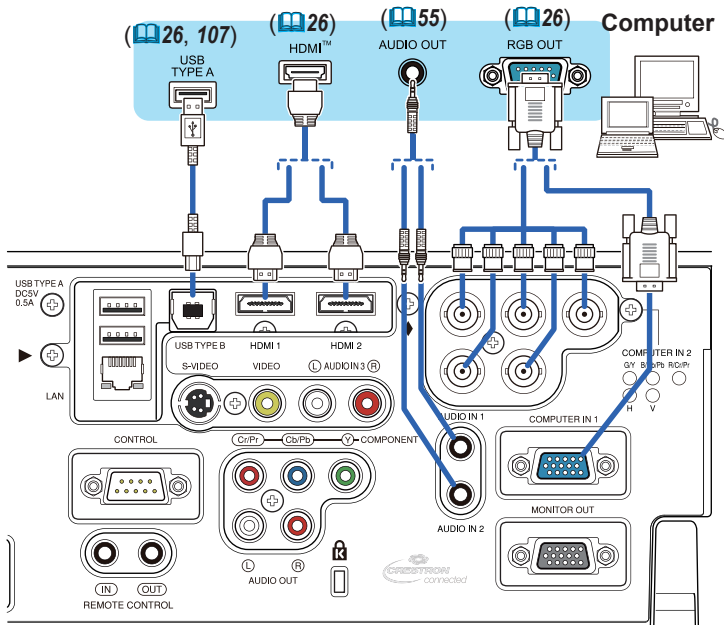

**NOTE** • Before connecting the projector to a computer, consult the computer's manual and check the compatibility of the signal level, the synchronization methods and the display resolution output to the projector.

- Some signal may need an adapter to input this projector.
- Some computers have multiple screen display modes that may include some signals which are not supported by this projector.
- Although the projector can display signals with resolution up to UXGA (1600x1200), the signal will be converted to the projector's panel resolution before being displayed. The best display performance will be achieved if the resolutions of the input signal and the projector panel are identical.
- If you connect this projector and a notebook computer, you need output the display to an external monitor, or output simultaneously to the internal display and an external monitor. Consult the computer's manual for the setting.
- Depending on the input signal, the automatic adjustment function of this projector may take some time and not function correctly.
- Note that a composite sync signal or sync-on-green signal may confuse the automatic adjustment function of this projector (26 50).
- If the automatic adjustment function does not work correctly, you may not see the dialog to set the display resolution. In such a case, use an external display device. You may be able to see the dialog and set an appropriate display resolution.

(continued on next page)

## Connecting with your devices (continued)

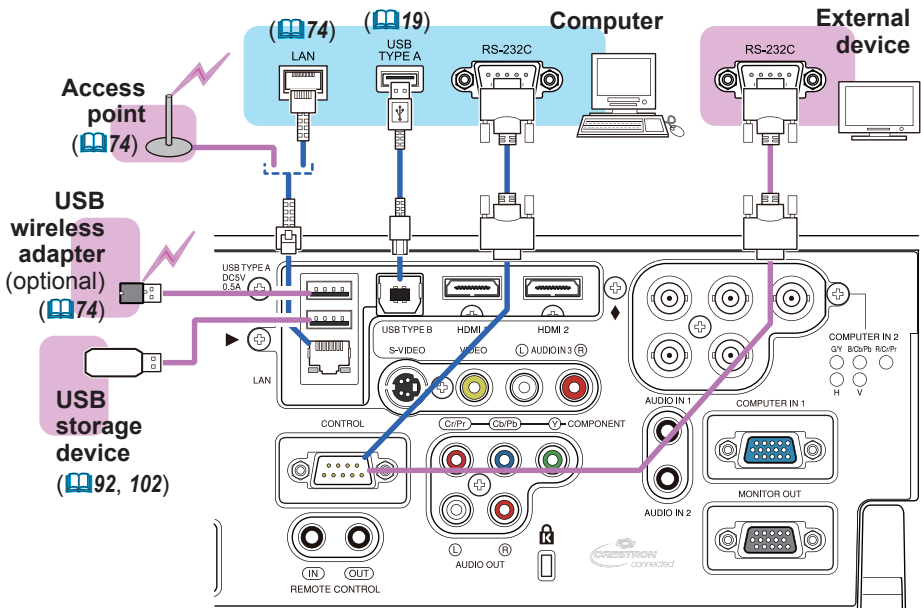

**⚠ WARNING** ▶ Heat may build up in the USB wireless adapter, to avoid possible burns disconnect the projector power cord for 10 minutes before touching the adapter.

▶ When using the USB wireless adapter, be sure to connect the adapter to the further **USB TYPE A** port from the **LAN** port and use the supplied adapter cover (15).

**⚠ CAUTION** ▶ Before connecting the projector to a network system be sure to obtain the consent of the administrator of the network.

▶ Do not connect the **LAN** port to any network that might have the excessive voltage.

▶ The designated USB wireless adapter that is sold as an option is required to use the wireless network function of this projector. Before connecting the USB wireless adapter, turn off the power of the projector and disconnect the power cord. Do not use any extension cable or device when connecting the adapter to the projector.

▶ Before removing the USB storage device from the port of the projector, be sure to use the REMOVE USB function on the Thumbnail screen to secure your data (95).

▶ To connect both the LAN cable and USB device to the projector, use only the further **USB TYPE A** port from the **LAN** port or a LAN cable that is flat on the side where the plug's wire is visible. Otherwise, both of them cannot be connected correctly, or the wire may break (malfunction).

**NOTE** • If an oversized USB storage device blocks the **LAN** port, use only the further **USB TYPE A** port from the **LAN** port or a USB extension cable to connect the USB storage device.

## Connecting with your devices (continued)

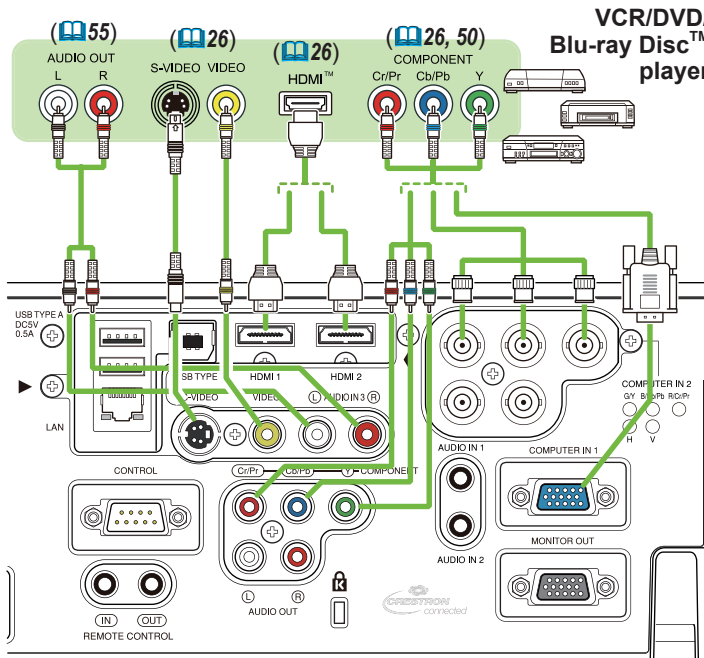

**NOTE** • The **HDMI** ports of this model are compatible with HDCP (High-bandwidth Digital Content Protection) and therefore capable of displaying video signals from HDCP compatible DVD players or the like.

- The **HDMI** ports support the following signals:

Video signal : 480i@60, 480p@60, 576i@50, 576p@50, 720p@50/60,  
1080i@50/60, 1080p@50/60

Audio signal : Format Linear PCM

Sampling frequency 48kHz / 44.1kHz / 32kHz

- This projector can be connected with another equipment that has HDMI™ connector, but with some equipment the projector may not work properly, something like no video.

- Be sure to use an HDMI™ cable that has the HDMI™ logo.

- Use a Category 2-certified HDMI™ cable to input 1080p@50/60 signal to the projector.

- When the projector is connected with a device having DVI connector, use a DVI to HDMI™ cable to connect with the HDMI™ input.

• The HDMI™ cables might come off easily due to the lack of a mechanical lock on the cables and connectors. It is recommended to fasten the cables to the projector to prevent the cables from coming off (📖14).

(continued on next page)

Connecting with your devices (continued)

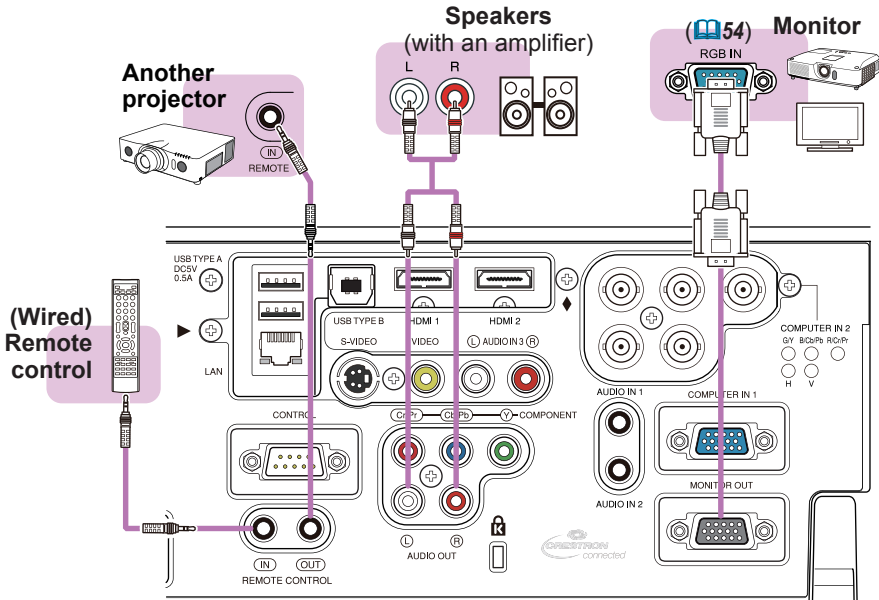

**NOTE** • To use a wired remote control, connect a wired remote control to the **REMOTE CONTROL IN** port. You can also connect another projector to the **REMOTE CONTROL OUT** port to control it from the wired remote control. You can utilize this projector as a remote control-relay with the **REMOTE CONTROL IN** and **OUT** ports. To connect the wired remote control or another projector to the **REMOTE CONTROL IN** or **OUT** ports, use audio cables with 3.5 mm diameter stereo mini plugs. This function is useful when a wireless remote signal may not reliably reach the projector.

**Fastening the cables**

To get together the signal cables and prevent them from coming off, fasten them to the projector using a commercially available plastic cable tie. Use a cable tie of size 2.0x5.0mm or smaller. It is recommended to curl the end of the tie slightly before you thread it to the tie holder to enable it to get through easily.

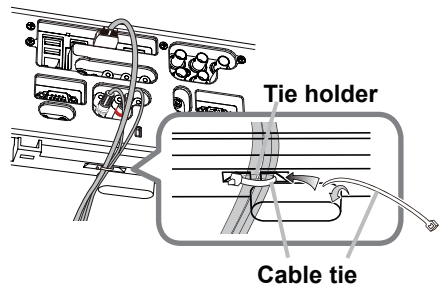

- ⚠ **WARNING** ▶ Do not bind the power cord.
- ⚠ **CAUTION** ▶ Use only a plastic tie to get together or fasten the cables. A metallic tie may cause damage to the cables and tie holder.
- ▶ Do not bind the cables too tightly. The cables or the hole might be damaged.

## Fastening the adapter cover

When using the USB wireless adapter, be sure to connect the adapter to the further **USB TYPE A** port from the **LAN** port and use the supplied adapter cover.

1. Loosen the screw (marked with triangle) on the bottom left of the **USB TYPE A** ports.
2. Insert the tab of the cover into the hole at the upper right of the **USB TYPE A** ports in the direction of the arrow.
3. Align the screw holes on the projector and the cover. Then insert the screw removed from the projector into the hole and tighten the screw.

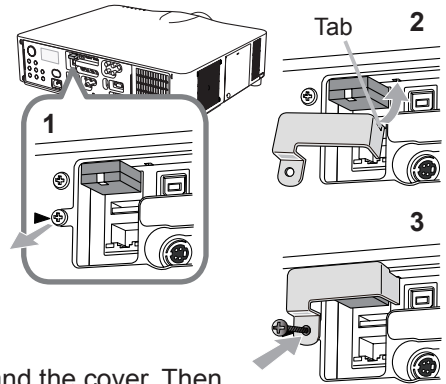

**⚠ WARNING** ▶ Keep small parts away from children and pets. Take care not to put in the mouth.

▶ Heat may build up in the USB wireless adapter, to avoid possible burns disconnect the projector power cord for 10 minutes before touching the adapter.

## Using the security bar and slot

A commercially available anti-theft chain or wire can be attached to the security bar on the projector. Refer to the figure to choose an anti-theft chain or wire.

Also this product has the security slot for the Kensington lock.

For details, see the manual of the security tool.

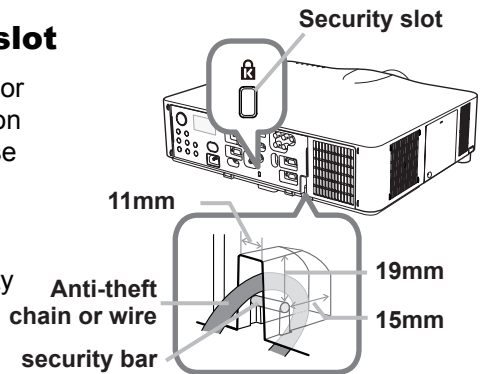

**⚠ WARNING** ▶ Do not use the security bars and slot to prevent the projector from falling down, since it is not designed for it.

**⚠ CAUTION** ▶ Do not place anti-theft chain or wire near the exhaust vents. It may become too hot.

**NOTE** • The security bar and slot is not comprehensive theft prevention measures. It is intended to be used as supplemental theft prevention measure.  
• The safety bar (🔒4) can be used for the same purpose as the security bar.

## Connecting to a power supply

1. Put the connector of the power cord into the **AC IN** (AC inlet) of the projector.
2. Firmly plug the power cord's plug into the outlet. In a couple of seconds after the power supply connection, the **POWER** indicator will light up in steady orange.

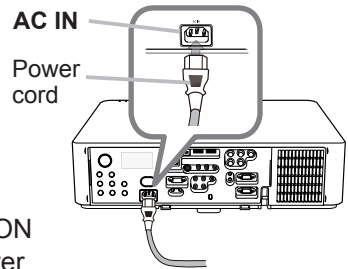

Please remember that when the **DIRECT POWER ON** function activated (  64), the connection of the power supply make the projector turn on.

**⚠ WARNING** ▶ Do not connect the projector to a power supply while no lens unit is attached to it.

▶ Please use extra caution when connecting the power cord, as incorrect or faulty connections may result in fire and/or electrical shock.

- Do not touch the power cord with a wet hand.
- Only use the power cord that came with the projector. If it is damaged, consult your dealer to get a new one. Never modify the power cord.
- Only plug the power cord into an outlet whose voltage is matched to the power cord. The power outlet should be close to the projector and easily accessible. Remove the power cord for complete separation.
- Do not distribute the power supply to multiple devices. Doing so may overload the outlet and connectors, loosen the connection, or result in fire, electric shock or other accidents.
- Connect the ground terminal for the AC inlet of this unit to the ground terminal of the building using an appropriate power cord (bundled).

**NOTICE** • This product is also designed for IT power systems with a phase-to-phase voltage of 220 to 240 V.



## Remote control

### Installing the batteries

Please insert the batteries into the remote control before using it. If the remote control starts to malfunction, try to replace the batteries. If you will not use the remote control for long period, remove the batteries from the remote control and store them in a safe place.

1. Holding the hook part of the battery cover, remove it.
2. Align and insert the two AA batteries (**HITACHI MAXELL** or **HITACHI MAXELL ENERGY, Part No.LR6 or R6P**) according to their plus and minus terminals as indicated in the remote control.
3. Replace the battery cover in the direction of the arrow and snap it back into place.

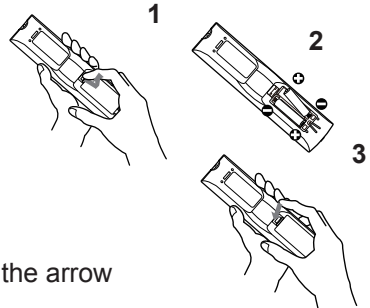

**⚠ WARNING** ▶ Always handle the batteries with care and use them only as directed. Improper use may result in battery explosion, cracking or leakage, which could result in fire, injury and/or pollution of the surrounding environment.

- Be sure to use only the batteries specified. Do not use batteries of different types at the same time. Do not mix a new battery with used one.
- Make sure the plus and minus terminals are correctly aligned when loading a battery.
- Keep a battery away from children and pets.
- Do not recharge, short circuit, solder or disassemble a battery.
- Do not place a battery in a fire or water. Keep batteries in a dark, cool and dry place.
- If you observe battery leakage, wipe out the leakage and then replace a battery. If the leakage adheres to your body or clothes, rinse well with water immediately.
- Obey the local laws on disposing the battery.

### Using the REMOTE ID function

Utilize this function to control specific projectors by the remote control assigned the same ID number when you use multiple projectors of the same type at the same time.

Assign an ID number to each projector before using the REMOTE ID item in the SERVICE menu of the OPTION menu (📖 69). Press the **ID** button with the same ID number as assigned to the projector you are going to control. The **ID** button selected will light for several seconds.

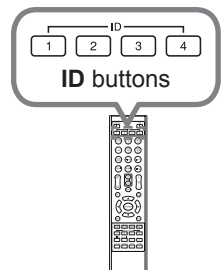

**NOTE** • Each time you press any button (except **ID** buttons), the **ID** button of current selected ID number will light.

- To confirm the projector's current ID, press any **ID** button for 3 seconds. Its number will be shown on each screen regardless of set ID of projector.

## Changing the frequency of remote control signal

The accessory remote control has the two choices on signal frequency Mode 1:NORMAL and Mode 2:HIGH. If the remote control does not function properly, attempt to change the signal frequency.

In order to set the Mode, please keep pressing the combination of two buttons listed below simultaneously for about 3 seconds.

- (1) Set to Mode 1:NORMAL  
**AV MUTE** and **ZOOM -** buttons
- (2) Set to Mode 2:HIGH  
**F5** and **KEYSTONE** buttons

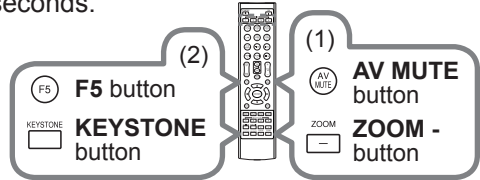

Please remember that the REMOTE

FREQ. in the SERVICE item of the OPTION menu (📖69) of the projector to be controlled should be set to the same mode as the remote control.

## About the remote control signal

The remote control works with the projector's remote sensor. This projector has two remote sensors on the front and back sides.

The sensors can sense signals within the following range:

60 degrees (30 degrees to the left and right of the sensor) within 3 meters about.

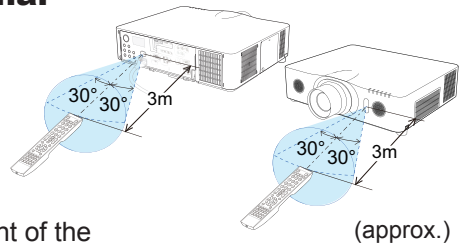

**NOTE** • You can deactivate one of the sensors using the REMOTE RECEIV. item in the SERVICE menu of the OPTION menu (📖69) .

- The remote control signal reflected in the screen or the like may be available. If it is difficult to send the signal to the sensor directly, attempt to make the signal reflect.
- The remote control uses infrared light to send signals to the projector (Class 1 LED), so be sure to use the remote control in an area free from obstacles that could block the remote control's signal to the projector.
- The remote control may not work correctly if strong light (such as direct sun light) or light from an extremely close range (such as from an inverter fluorescent lamp) shines on the remote sensor of the projector. Adjust the position of projector avoiding those lights.

## Using as a simple PC mouse & keyboard

The accessory remote control works as a simple mouse and keyboard of the computer, when the projector's **USB TYPE B** port and the computer's type A USB port are connected and **MOUSE** is selected for the **USB TYPE B** item in the **OPTION** menu (📖65).

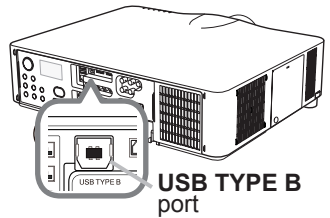

- (1) **PAGE UP key:** Press **PAGE UP** button.
- (2) **PAGE DOWN key:** Press **PAGE DOWN** button.
- (3) **Mouse left button:** Press **ENTER** button.
- (4) **Move pointer:** Use the cursor buttons  
▲, ▼, ◀ and ▶.
- (5) **ESC key:** Press **ESC** button.
- (6) **Mouse right button:** Press **RESET** button.
- (7) **F5 key:** Press **F5** button.

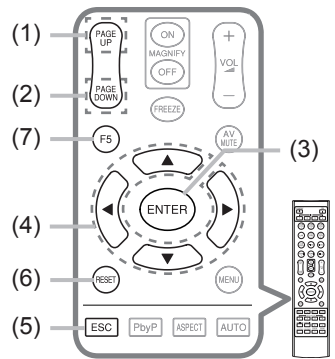

**NOTICE** ▶ Improper use of the simple mouse & keyboard function could damage your equipment. While using this function, please connect this product only to a computer. Be sure to check your computer's manuals before connecting this product to the computer.

- NOTE** • When the simple mouse & keyboard function of this product does not work correctly, please check the following.
- When a USB cable connects this projector with a computer having a built-in pointing device (e.g. track ball) like a laptop PC, open BIOS setup menu, then select the external mouse and disable the built-in pointing device, because the built-in pointing device may have priority to this function.
  - Windows 95 OSR 2.1 or higher is required for this function. And also this function may not work depending on the computer's configurations and mouse drivers. This function can work with the computer which can operate general USB mouse or keyboard.
  - You cannot do things like press two buttons at once (for instance, pressing two buttons at the same time to move the mouse pointer diagonally).
  - This function is activated only when the projector is working properly. This function is not available in any of the following cases:
    - While the lamp is warming up. (The **POWER** indicator blinks in green.)
    - When either **USB TYPE A** or **USB TYPE B** is selected as the input source.
    - While displaying **BLANK** (📖57), **TEMPLATE** (📖61) or **MY IMAGE** (📖82) screen.
    - When any menu is displayed on the screen.
    - While using the cursor buttons to operate the sound or screen functions such as adjusting the sound volume, correcting the keystone, correcting the picture position and magnifying the screen.

## Status Monitor

<Only for 8971, 8973W and 8975WU>

The Status Monitor is the sub LCD in the rear panel of **8971, 8973W** and **8975WU**. The Status Monitor displays the present condition of the projector including errors, setup information and error history.

Status Monitor

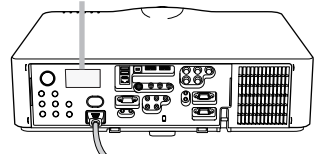

## Displaying the condition of the projector

If no buttons have been operated, the Status Monitor displays as below depending on the condition of the projector.

**NOTE** • The Status Monitor displays nothing while the projector is in standby mode if the STANDBY MODE item of SETUP menu is set to SAVING ( 54 ).  
 • When INSTALLATION in the SETUP menu is set to FRONT / CEILING or REAR / CEILING, the contents on the Status Monitor are displayed upside down ( 53 ).

### ○ In a normal state

The Status Monitor displays the condition of the projector in three lines.

**1st line** : Displays the condition of the projector.  
 While the lamp is on, the selected port is displayed.

Displayed conditions are as below;

STANDBY: The projector is in standby mode.

WARM UP: The projector is warming up.

SEARCHING: The projector is searching an input signal.

COOL DOWN: The projector is cooling down.

**2nd line** : Displays the condition of the detected input signal while the lamp is on. Otherwise, displays the serial number of the projector.

Displayed conditions are as below;

SYNC OUT: Detected input signal is out of specified range.

NO SIGNAL: There is no input signal.

CONNECTED: The projector has connected to the network or the computer and some image is transferred to the projector while the **LAN** or **USB TYPE B** port is selected.

HOLD: The projector has connected to the network but no image is transferred while the **LAN** port is selected.

NOT CONNECTED: The projector is not connected to the network or the computer while the **LAN** or **USB TYPE B** port is selected.

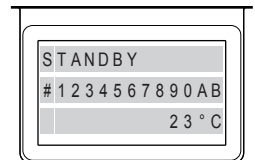

example

(continued on next page)

## Displaying the condition of the projector (continued)

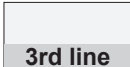
: Displays peripheral temperature in Celsius. While the lamp is on, supplied voltage is also displayed.

**3rd line:** Displays supplied voltage and peripheral temperature in Celsius while the lamp is on.

**NOTE** • While the projector is searching an input signal or **USB TYPE A** ports are selected in normal condition, nothing is displayed on the 2nd line of the monitor.

- When the **USB TYPE B** port is selected even if MOUSE is selected in the USB TYPE B item of the OPTION menu, "NO SIGNAL" is displayed on the 2nd line of the monitor ([☞65](#)).
- Displayed temperature might differ from actual peripheral temperature because the displayed temperature is measured inside of the projector.

### ○ In error state

The Status Monitor displays a warning of an error with larger letters. Resolve the errors referring to the table of the sections "**Related messages**" ([☞117](#)) and "**Regarding the indicator lamps**" ([☞118, 119](#)) when the warning is displayed.

Displayed warnings are as below;

COVER: The lamp cover has not been properly fixed.

Refer to the **LAMP** indicator blinking in the table ([☞118](#)).

FAN: The cooling fan is not operating.

Refer to the **TEMP** indicator blinking in the table ([☞119](#)).

LAMP: The lamp does not light.

Refer to the **LAMP** indicator lighting in the table ([☞118](#)).

TEMP: The projector's interior becomes over heated.

Refer to the **TEMP** indicator lighting in the table ([☞119](#)).

AIR (AIR FLOW): The internal temperature is rising.

Refer to the description of the message, "CHECK THE AIR FLOW" in the table ([☞117](#)).

COLD: There is a possibility that the interior portion has become over cooled.

Refer to the **LAMP** and **TEMP** indicators alternatively blinking in the table ([☞119](#)).

FILTR (FILTER): It is time to clean the air filter.

Refer to the **LAMP** and **TEMP** indicators simultaneous blinking in the table ([☞119](#)).



example

**NOTE** • When one of the warnings of FAN, LAMP, COVER, TEMP errors is displayed, the backlight blinks at the same time.

## Displaying the log

The present setup information and the error history can be displayed on the Status Monitor with button operation.

- NOTE**
- While the projector is warming up, button presses are ignored.
  - When the **USB TYPE A** port is selected, use the buttons on the control panel to display the logs. The button operation of the Status Monitor on the remote control may be unavailable.
  - The Status Monitor displays nothing or no button presses for the monitor are available while the projector is in standby mode if the **STANDBY MODE** item of **SETUP** menu is set to **SAVING** (p.54).
  - Both of the Status Monitor and the OSD menu cannot be operated at same time.

When the projector is in a normal condition, or displays one of the warnings of **AIR FLOW**, **COLD** or **FILTER** errors, press the **FUNCTION** button on the control panel or press the **ENTER** button on the remote control for three seconds. The backlight of the monitor turns on.

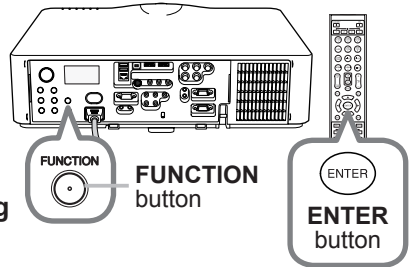

○ **To display the setup information including usage time**

Use the ◀/▶ buttons to switch display.

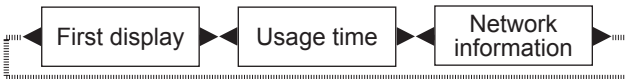

Usage time: The Status Monitor displays the lamp time (usage time of the present lamp), the filter time (usage time of the air filter) and the projector usage time.

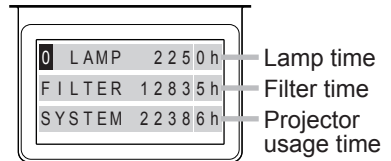

Usage time (example)

Network information: The network information is displayed over three pages.

Use the ▲/▼ buttons to switch the page.

Displayed information in each page is as below;

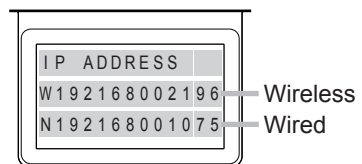
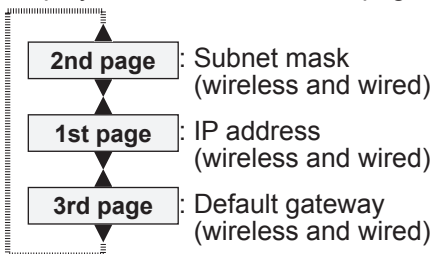

Network information (example)

(continued on next page)

## Displaying the log (continued)

- NOTE** • The Status Monitor and its backlight returns to the first state before the **FUNCTION** or **ENTER** button was pressed when any button except cursor buttons is pressed, or after about 30 seconds without button operation.
- The projector usage time is the total lamp time from the projector is manufactured. It is not reset by using LAMP TIME in the OPTION menu (📖65).
  - If the ▲/▼ buttons are pressed while the usage time is displayed, the usage time switches to the past one when an error occurred.

### ○ To display error history

Press the ▲ button to display previous error log. If a warning has been displayed, the first previous error log is the present error currently occurring. The Status Monitor displays the log number, occurred error, the supplied voltage and peripheral temperature at that time. Press the ► button to display the usage time when each error occurred.

Use the ▲/▼ buttons to switch the log. The display switches with the ◀/▶ buttons at each log. Up to 10 error logs including the present one can be displayed.

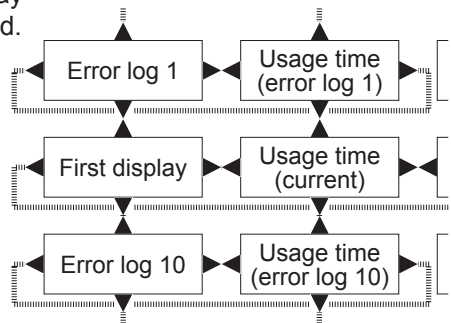
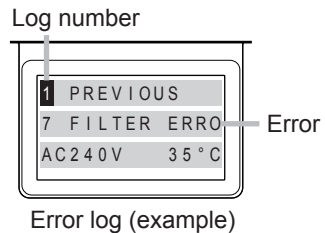

- NOTE** • The Status Monitor and its backlight returns to the first state before the **FUNCTION** or **ENTER** button was pressed when any button except cursor buttons is pressed, or after about 30 seconds without button operation.
- If no error or less than 10 errors have occurred, "NO DATA" is displayed in spite of occurred error in the error log.

## Power on/off

**Turning on the power**

1. Make sure that the power cord is firmly and correctly connected to the projector and the outlet.
2. Make sure that the **POWER** indicator is lighted in steady orange (📖118). Then remove the lens cover.
3. Press **STANDBY/ON** button on the projector or the **ON** button on the remote control.  
The projection lamp will light up and **POWER** indicator will begin blinking in green. When the power is completely on, the indicator will stop blinking and light in steady green (📖118).

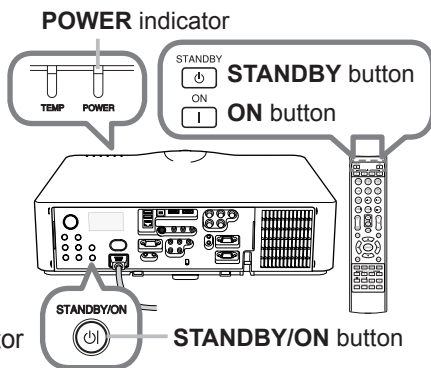

To display the picture, select an input signal according to the section **Selecting an input signal** (📖26).

**Turning off the power**

1. Press the **STANDBY/ON** button on the projector or the **STANDBY** button on the remote control.  
The message "Power off?" will appear on the screen for about 5 seconds.
2. Press the **STANDBY/ON** or **STANDBY** button again while the message appears.  
The projector lamp will go off, and the **POWER** indicator will begin blinking in orange. Then the **POWER** indicator will stop blinking and light in steady orange when the lamp cooling is complete (📖118).
3. Attach the lens cover, after the **POWER** indicator turns to steady orange.

Do not turn the projector on for about 10 minutes or more after turning it off. Also, do not turn the projector off shortly after turning it on. Such operations might cause the lamp to malfunction or shorten the lifetime of some parts including the lamp.

**⚠ WARNING** ▶ A strong light is emitted when the projector's power is on. Do not look into the lens of the projector or look inside of the projector through any of the projector's openings.  
▶ Do not touch around the lamp cover and the exhaust vents during use or just after use, since it is too hot.

**NOTE** • Turn the power on/off in right order. Please power on the projector prior to the connected devices.  
• This projector has the function that can make the projector automatically turn on/off. Please refer to the **DIRECT POWER ON** (📖64) and **AUTO POWER OFF** (📖64) items of the **OPTION** menu.



## Operating

**Adjusting the volume**

1. Use the **VOL + / -** buttons to adjust the volume. A dialog will appear on the screen to aid you in adjusting the volume. If you do not do anything, the dialog will automatically disappear after a few seconds.

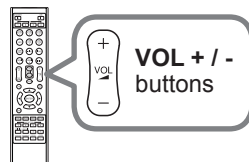

**NOTE** • When  $\times$  is selected for current picture input port, the volume adjustment is disabled. Please see AUDIO SOURCE item of AUDIO menu (☞55).

- Even if the projector is in the standby mode, the volume is adjustable when both of the following conditions are true:
  - An option other than  $\times$  is selected for AUDIO OUT STANDBY in the AUDIO SOURCE item of the AUDIO menu (☞55).
  - NORMAL is selected in the STANDBY MODE item of the SETUP menu (☞54).

**Temporarily turning off the screen and audio**

1. Press **AV MUTE** button on the remote control. The BLANK screen will be displayed instead of the screen of input signals and the sound from the internal speakers will be muted. Please refer to the BLANK item in SCREEN menu about the BLANK screen (☞57).

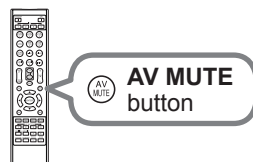

To exit from the AV MUTE mode and restore the screen and audio, press **AV MUTE** button again.

**NOTE** • The projector automatically exits from the AV MUTE mode when some control buttons are pressed.

**⚠ CAUTION** ► If you wish to have a blank screen while the projector's lamp is on, use the AV MUTE function above or the lens shade function (☞36). Taking any other action may cause the damage on the projector.

## Selecting an input signal

- Press **INPUT** button on the projector. Each time you press the button, the projector switches its input port from the current port to below.

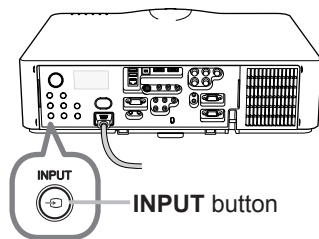
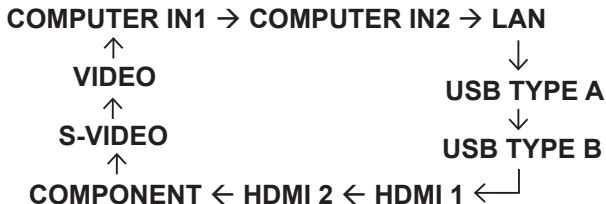

**NOTE** • If you have set SKIP to some ports from SOURCE SKIP in the OPTION menu, the input from the ports cannot be selected ( 63 ).

- While ON is selected for AUTO SEARCH item in OPTION menu, the projector will keep checking the ports in above order repeatedly till an input signal is detected ( 63 ).
- It may take several seconds to project the images from the **USB TYPE B** port.

- Press **COMPUTER 1 / 2, LAN, USB TYPE A / B, HDMI 1 / 2, COMPONENT, S-VIDEO** or **VIDEO** button on the remote control. The port corresponding to each button is selected as below.

Button	Ports
COMPUTER 1	COMPUTER IN1
COMPUTER 2	COMPUTER IN2
LAN	LAN
USB TYPE A	USB TYPE A
USB TYPE B	USB TYPE B
HDMI 1	HDMI 1
HDMI 2	HDMI 2
COMPONENT	COMPONENT
S-VIDEO	S-VIDEO
VIDEO	VIDEO

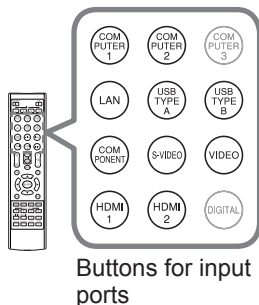

**NOTE** • While ON is selected for AUTO SEARCH item in OPTION menu, the projector will keep checking every port sequentially till an input signal is detected ( 63 ).

- It may take several seconds to project the images from the **USB TYPE B** port.

## Selecting an aspect ratio

1. Press **ASPECT** button on the remote control.
  - Each time you press the button, the projector switches the mode for aspect ratio in turn.



**ASPECT**  
button

### ○ For a computer signal

**8970, 8971:**

NORMAL → 4:3 → 16:9 → 16:10



**8972W, 8973W, 8976SX, 8974WU, 8975WU:**

NORMAL → 4:3 → 16:9 → 16:10 → NATIVE



### ○ For an HDMI™ signal

**8970, 8971**

NORMAL → 4:3 → 16:9 → 16:10 → 14:9



**8972W, 8973W, 8976SX, 8974WU, 8975WU:**

NORMAL → 4:3 → 16:9 → 16:10 → 14:9 → NATIVE



### ○ For a video signal, s-video signal or component video signal

**8970, 8971:**

4:3 → 16:9 → 14:9



**8976SX:**

4:3 → 16:9 → 14:9 → NATIVE



**8970, 8971, 8974WU, 8975WU:**

4:3 → 16:9 → 16:10 → 14:9 → NATIVE



### ○ For an input signal from the LAN, USB TYPE A or USB TYPE B ports, or if there is no signal

**8970, 8971, 8976SX:** 4:3 (fixed)

**8972W, 8973W, 8974WU, 8975WU:** 16:10 (fixed)

**NOTE** • **ASPECT** button does not work when no proper signal is inputted.  
• **NORMAL** mode keeps the original aspect ratio setting.

## Adjusting the projector's elevator

When the place to put the projector is slightly uneven to the left or right, use the elevator feet to place the projector horizontally.

Using the feet can also tilt the projector in order to project at a suitable angle to the screen, elevating the front side of the projector within 9 degrees.

This projector has 2 elevator feet and 2 elevator buttons. An elevator foot is adjustable while pushing the elevator button on the same side as it.

1. Holding the projector, push the elevator buttons to loose the elevator feet.
2. Position the front side of the projector to the desired height.
3. Release the elevator buttons in order to lock the elevator feet.
4. After making sure that the elevator feet are locked, put the projector down gently.
5. If necessary, the elevator feet can be manually twisted to make more precise adjustments. Hold the projector when twisting the feet.

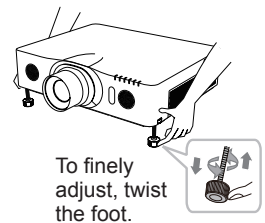
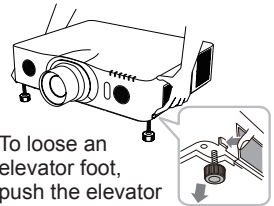
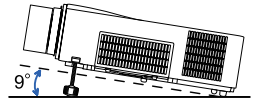

**⚠ CAUTION** ► Do not handle the elevator buttons without holding the projector, since the projector may drop down.

► Do not tilt the projector other than elevating its front within 9 degrees using the adjuster feet. A tilt of the projector exceeding the restriction could cause malfunction or shortening the lifetime of consumables, or the projector itself. Only for **C8970**, **8973W5** and **8975W**, it is possible to install the projector for any direction with specified mounting accessories. Consult with your dealer about such a special installation.

## Adjusting the lens

### Adjusting the zoom and focus

The ZOOM or FOCUS dialog will appear when you press any of the buttons from **ZOOM**, **ZOOM -**, **ZOOM +**, **FOCUS +** and **FOCUS -**.

1. Use the **ZOOM + / -** buttons on the remote control or **ZOOM** button and **◀/▶** cursor buttons on the projector to adjust the screen size.
2. Use the **FOCUS + / -** buttons to focus the picture.

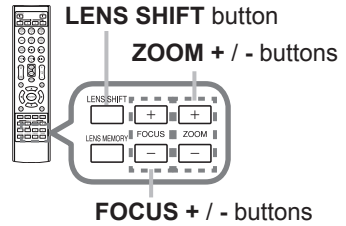

**NOTE** • The projector may ignore operation by other buttons while the lens is moving.

### Adjusting the lens position

Press the **LENS SHIFT** button. The LENS SHIFT dialog will appear. Using the **▲/▼/◀/▶** buttons while the dialog is displayed shifts the lens. Generally, better image quality can be got when the lens is set to the center.

Press the **LENS SHIFT** button again to exit the LENS SHIFT function.

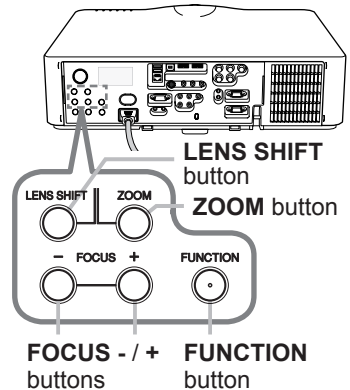

### CENTERING

Press the **ENTER** or **INPUT** button while the dialog is displayed to execute the CENTERING feature, which adjusts the lens to the center. A message dialog is displayed for confirmation. Pressing the **▶** button performs CENTERING. You can also perform CENTERING in the standby mode by pressing the **FUNCTION** and **LENS SHIFT** buttons on the control panel for 3 seconds at the same time.



**⚠ CAUTION** ▶ Do not put your fingers or any other things around the lens. The moving lens could catch them in the space around the lens and result in an injury.

**NOTE** • While the lens is moving to the center, the menu will disappear and an hourglass icon will appear on the screen. CENTERING may take some time till the lens reaches the center.

- The projector may ignore operation by buttons while moving the lens.
- The CENTERING feature while the projector is in the standby mode is disabled if the STANDBY MODE item of SETUP menu is set to SAVING. Perform CENTERING before the projector's power is turned off, or set the STANDBY MODE to NORMAL.
- The adjustable range of LENS SHIFT varies depending on the lens unit mounted on the projector to maintain picture quality. Therefore LENS SHIFT adjustment may not reach the end of the indicator in the dialog, and that is not a failure.

## Adjusting the lens (continued)

### Lens memory

This projector is equipped with memory functions for the lens adjustments (LENS SHIFT and LENS TYPE). Up to 3 sets of adjustments can be stored.

To utilize the lens memory feature, press the **POSITION** or **FUNCTION** button while the LENS SHIFT dialog is displayed. Then the LENS MEMORY dialog will appear. The current lens adjustments are displayed on the "CURRENT" line. The adjustments already stored in the lens memory are displayed on the lines of SAVE and LOAD-1 to 3.

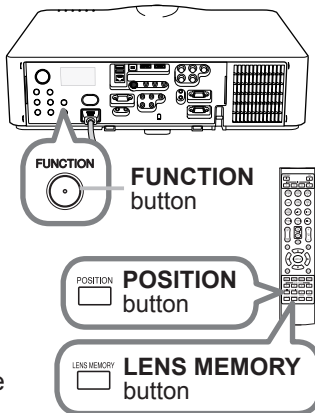

#### ○ SAVE:

To store the current lens adjustments, select one of the "SAVE" options numbered 1 to 3 (number of the lens memory) and press the ► or **ENTER** button. Remember that the current data being stored of a memory will be lost by saving new data into the memory.

#### ○ LOAD:

To recall stored adjustments, select one of the "LOAD" options numbered 1 to 3 (number of the lens memory) and press the ► or **ENTER** button.

Remember that the current adjusted condition will be lost by loading data. If you want to keep the current adjustment, please save it before performing a LOAD function.

#### ○ CLEAR LENS MEMORY:

To clear the adjustment stored in a lens memory, select CLEAR LENS MEMORY and press the ► or **ENTER** button. The CLEAR LENS MEMORY dialog will be displayed. Select the number of the lens memory to be cleared using the ▲/▼ buttons and press the ► button. A message dialog is displayed for confirmation. Press the ► button again to clear the lens memory.

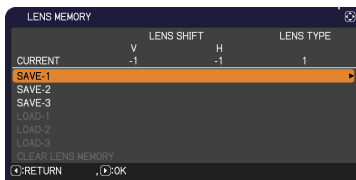

**NOTE** • The projector may ignore operation by buttons while moving the lens.  
• You can perform the LOAD function using **LENS MEMORY** button.

## Using the automatic adjustment feature

1. Press **AUTO** button on the remote control.
  - Pressing this button performs the following.
    - **For a computer signal**  
The vertical position, the horizontal position and the horizontal phase will be automatically adjusted.  
Make sure that the application window is set to its maximum size prior to attempting to use this feature. A dark picture may still be incorrectly adjusted. Use a bright picture when adjusting.
    - **For a video signal and s-video signal**  
The video format best suited for the respective input signal will be selected automatically. This function is available only when the AUTO is selected for the VIDEO FORMAT item in the INPUT menu ( [49](#) ). The vertical position and horizontal position will be automatically set to the default.
    - **For a component video signal**  
The vertical position and horizontal position will be automatically set to the default. The horizontal phase will be automatically adjusted.

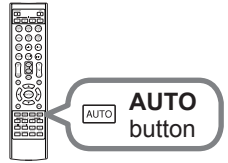

**NOTE** • The automatic adjustment operation requires approx. 10 seconds. Also please note that it may not function correctly with some input.

- When this function is performed for a video signal, a certain extra such as a line may appear outside a picture.
- When this function is performed for a computer signal, a black frame may be displayed on the edge of the screen, depending on the computer model.
- The items adjusted by this function may vary when the FINE or DISABLE is selected for the AUTO ADJUST item of the SERVICE item in the OPTION menu ( [67](#) ).

## Adjusting the position

1. Press **POSITION** button on the remote control when no menu is indicated.
  - The “POSITION” indication will appear on the screen.
2. Use the ▲/▼/◀/▶ cursor buttons to adjust the picture position.
  - When you want to reset the operation, press **RESET** button on the remote control during the operation.
  - To complete this operation, press **POSITION** button again. Even if you do not do anything, the dialog will automatically disappear after a few seconds.

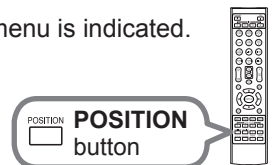

**NOTE** • When this function is performed on a video signal or an s-video signal, some image such as an extra-line may appear at outside of the picture.

- When this function is performed on a video signal or s-video signal, the range of this adjustment depends on OVER SCAN in IMAGE menu ( [46](#) ) setting. It is not possible to adjust when OVER SCAN is set to 10.
- If **POSITION** button is pressed when a menu is indicated on screen, the displayed picture does not move its position but the menu does.
- This function is unavailable for a signal from the LAN, USB TYPE A / B or HDMI 1 / 2 port.

## Correcting the distortion

To correct the distortion of projected screen, you can select one of three options, AUTO, MANUAL and PERFECT FIT. First press the **KEYSTONE** button to display the KEYSTONE menu, and point at one of items with the ▲/▼ buttons.

**AUTO**: performs the automatic vertical keystone correction. (📖52)

**MANUAL**: allows you to adjust the vertical and horizontal keystone.

**PERFECT FIT**: allows you to adjust each of the screen corners and sides to correct the distortion.

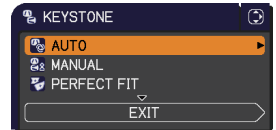

Then follow the procedure shown below for the item you selected.

**NOTE** • The menu or dialog will automatically disappear after several seconds of inactivity. Press the **KEYSTONE** button again, or point the cursor at EXIT in the dialog and press the ► or **ENTER** button to end the operation and close the menu or dialog.

- When the screen is adjusted by PERFECT FIT, neither AUTO nor MANUAL is selectable. If you wish to use these functions, refer to step 3 in the PERFECT FIT item to initialize the adjustment of PERFECT FIT.
- When TRANSITION DETECTOR is ON, these functions are not available (📖88).

### ○ **AUTO:**

When AUTO is pointed at, pressing the ► or **ENTER** button performs automatic vertical keystone correction.

**NOTE** • When the projector is in one of the following conditions, the automatic vertical keystone correction feature may not work correctly or at all.

- REAR / CEILING or FRONT / CEILING is selected for the INSTALLATION item in the SETUP menu, and the projector screen is slanted or tilted downwards.
- The ZOOM adjustment is not set to the full WIDE (wide-angle focus).
- The projector is nearly horizontal (about  $\pm 4^\circ$ ).
- The projector is inclined at about  $\pm 35$  degrees or over.
- When the horizontal lens shift is not set to the center, this function may not work well.



### Correcting the distortion (continued)

○ **MANUAL:**

When MANUAL is pointed at, pressing the ► or **ENTER** button displays the KEYSTONE\_MANUAL dialog.

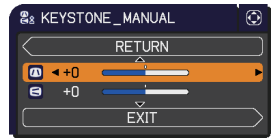

1. Select the vertical or horizontal keystone (▲/▼) with the ▲/▼ buttons.
2. Use the ◀/▶ buttons to adjust the keystone distortion.

**NOTE** • When the zoom adjustment is set to the TELE (telephoto focus), this function may be excessive. This function should be used when the zoom adjustment is set to the full WIDE (wide-angle focus) whenever possible.

- When the horizontal lens shift is not set to the center, this function may not work well.
- Point at RETURN in the dialog with the ▲/▼ buttons and press ◀ or **ENTER** button to return to the KEYSTONE menu.

○ **PERFECT FIT:**

When PERFECT FIT is pointed at, pressing the ► or **ENTER** button displays the KEYSTONE\_PERFECT FIT dialog.

This projector is equipped with a test pattern for PERFECT FIT. Select the test pattern icon shown in the lower left of the dialog with the ◀/▼ buttons. When you press the **ENTER** or **INPUT** button, the test pattern appears or disappears.



**8970, 8971,  
8972W, 8973W**

1. If it is necessary to initialize the current adjustment, point at RESET in the dialog with the **RESET** button, and press the **ENTER** or **INPUT** button.

2. Select one of the corners to be adjusted with the ▲/▼/◀▶ buttons and press the **ENTER** or **INPUT** button. For **8970, 8971, 8972W, 8972W** and **8973W**, also the sides can be selected to adjust.

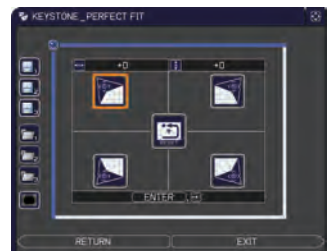

**8976SX,  
8974WU, 8975WU**



(continued on next page)

### Correcting the distortion (continued)

#### 3. Adjust the selected part as below.

- For adjusting a corner, use the ▲/▼/◀/▶ buttons to adjust the position of the corner.
- <Only for **8970, 871, 8972W** and **8973W**>  
For adjusting the upper or lower side, use the ◀/▶ buttons to select any one point on the side, and use the ▲/▼ buttons to adjust the distortion of the side.
- <Only for **8970, 871, 8972W** and **8973W**>  
For adjusting the left or right side, use the ▲/▼ buttons to select any one point on the side, and use the ◀/▶ buttons to adjust the distortion of the side.
- To adjust another corner or side, press the **ENTER** or **INPUT** button and follow the procedure from step 2.

#### 4. This projector is equipped with a memory feature for PERFECT FIT adjustment. Up to 3 sets of adjustments can be stored.

- **SAVE:**  
To store the current PERFECT FIT adjustment, select one of the SAVE icons  numbered 1 to 3 (number of the memory) with the ◀/▲/▼ buttons and press the **ENTER** or **INPUT** button.  
Remember that the current data being stored of a memory will be lost by saving new data into the memory.
- **LOAD:**  
To recall stored adjustments, select one of the LOAD icons  numbered 1 to 3 (number of the memory) with the ◀/▲/▼ buttons and press the **ENTER** or **INPUT** button.  
Remember that the current adjusted condition will be lost by loading data. If you want to keep the current adjustment, please save it before performing a LOAD function.

**NOTE** • <Only for **8970, 871, 8972W** and **8973W**>

Each corner and side can be adjusted individually but in some cases it may be adjusted in conjunction with another corner or side. This is due to control restrictions and not a malfunction.

- The LOAD functions whose linked memory has no data are skipped.
- There may be some noise and the screen may flicker for a moment when loading data. This is not malfunction.
- Point at RETURN in the dialog with the ▲/▼ buttons and press the ◀ or **ENTER** button to return to the KEYSTONE menu.

## Using the magnify feature

1. Press the **MAGNIFY ON** button on the remote control.  
The picture will be magnified, and the MAGNIFY dialog will appear on the screen. When the **MAGNIFY ON** button is pressed for the first time after the projector is turned on, the picture will be zoomed by 1.5 times. On the dialog, triangle marks to show each direction will be displayed.
2. The display magnification of the projector switches in order with every press of the **MAGNIFY ON** button.
  - For computer signals, HDMI™ (RGB) signals, input signals from the LAN, USB TYPE A or USB TYPE B ports  
1.5 times → 2 times → 3 times → 4 times → 1 time  
↑
  - For video signals, s-video signals, component video signals or HDMI™ (Component) signals  
1.5 times → 2 times → 1 time  
↑
3. While the triangles are displayed on the dialog, use the ▲/▼/◀/▶ cursor buttons to shift the magnifying area.
4. Press the **MAGNIFY OFF** button on the remote control to exit magnification.

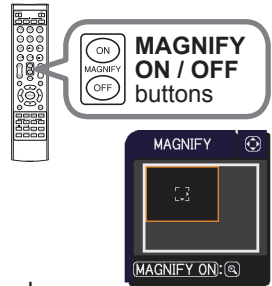

- NOTE** • The MAGNIFY dialog will automatically disappear in several seconds with no operation. The dialog will appear again if the **MAGNIFY ON** button is pressed when the dialog has automatically disappeared.
- The magnification is automatically disabled when the displaying signal or its display condition is changed.
  - While the magnification is active, the keystone distortion condition may vary. It will be restored when the magnification is disabled.
  - Some horizontal stripes might be visible on the image while magnification is active.
  - This function is not available in the following cases:
    - A sync signal in the range not supported is input.
    - There is no input signal.

## Temporarily freezing the screen

1. Press the **FREEZE** button on the remote control.  
The “FREEZE” indication will appear on the screen (however, the indication will not appear when the OFF is selected for the MESSAGE item in the SCREEN menu (📖59), and the projector will go into the FREEZE mode, which the picture is frozen.  
To exit the FREEZE mode and restore the screen to normal, press the **FREEZE** button again.



**NOTE** • The projector automatically exits from the FREEZE mode when some control buttons are pressed.

- If the projector continues projecting a still image for a long time, the LCD panel might possibly be burned in. Do not leave the projector in the FREEZE mode for too long.
- Images might appear degraded when this function is operated, but it is not a malfunction.

## Temporarily shading the screen

1. Press the **SHADE** button on the control panel.  
The mechanical lens shade closes and the screen turns to black. The **SHADE** indicator on the projector blinks in yellow while the shade is closed.  
To open the shade and restore the screen, press the **SHADE** button again.

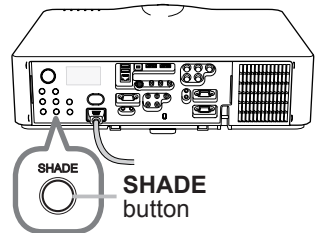

**⚠ CAUTION** ► If you wish to have a blank screen while the projector's lamp is on, use the lens shade function above or the AV MUTE function (📖25). Taking any other action may cause the damage on the projector.

**NOTE** • The projector will turn off automatically when the time set up by the SHADE TIMER passes (📖64).

- When turning off the power by the normal procedure, the lens shade opens automatically. If AC power supply is disconnected while opening or closing the lens shade, the moving of the lens shade stops. However, the next time the projector is turned on, the lens shade opens again automatically.

## Using the menu function

This projector has the following menus:

PICTURE, IMAGE, INPUT, SETUP, AUDIO, SCREEN, OPTION, NETWORK, SECURITY and EASY MENU.

EASY MENU consists of functions often used, and the other menus are classified into each purpose and brought together as the ADVANCED MENU.

Each of these menus is operated using the same methods. While the projector is displaying any menu, the **MENU** button on the projector works as the cursor buttons. The basic operations of these menus are as follows.

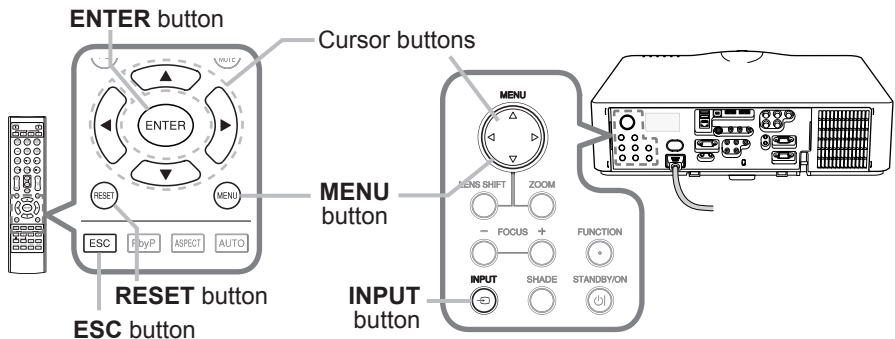

1. To start the MENU, press the **MENU** button. The MENU you last used (EASY or ADVANCED) will appear. EASY MENU has priority to appear just after powered on.

### 2. In the EASY MENU

- (1) Use the ▲/▼ cursor buttons to select an item to operate. If you want to change it to the ADVANCED MENU, select the ADVANCED MENU.
- (2) Use the ◀/▶ cursor buttons to operate the item.

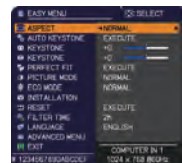

### In the ADVANCED MENU

- (1) Use the ▲/▼ cursor buttons to select a menu. If you want to change it to the EASY MENU, select the EASY MENU. The items in the menu appear on the right side.
- (2) Press the ▶ cursor button or **ENTER** button to move the cursor to the right side. Then use the ▲/▼ cursor buttons to select an item to operate and press the ▶ cursor button or **ENTER** button to progress. The operation menu or dialog of the selected item will appear.
- (3) Use the buttons as instructed in the OSD to operate the item.

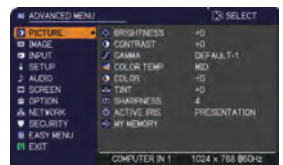

(continued on next page)

### Using the menu function (continued)

3. To close the MENU, press the **MENU** button again or select EXIT and press the ◀ cursor button or **ENTER** button. Even if you do not do anything, the dialog will automatically disappear after about 30 seconds.
  - If you want to move the menu position, use the cursor buttons after pressing the **POSITION** button.
  - Some functions cannot be performed when a certain input port is selected, or when a certain input signal is displayed.
  - When you want to reset the operation, press **RESET** button on the remote control during the operation. Note that some items (ex. LANGUAGE, VOLUME) cannot be reset.
  - In the **ADVANCED MENU**, when you want to return to the previous display, press the ◀ cursor button or **ESC** button on the remote control.

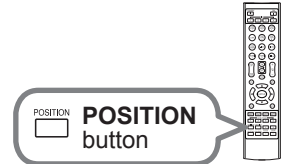

### Indication in OSD (On Screen Display)

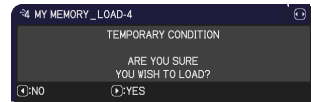
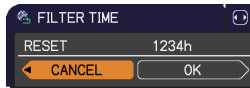





The meanings of the general words on the OSD are as follows.

Indication	Meaning
EXIT	Selecting this word finishes the OSD menu. It's the same as pressing the <b>MENU</b> button.
RETURN	Selecting this word returns the menu to the previous menu.
CANCEL or NO	Selecting this word cancels the operation in the present menu and returns to the previous menu.
OK or YES	Selecting this word executes the prepared function or shifts the menu to the next menu.

## Using the menu function (continued)

### Containing items of each menu

The items contained in the menus are as below;

Menu	Items
<b>EASY MENU</b> (📖40)	ASPECT, AUTO KEYSTONE,  KEYSTONE,  KEYSTONE, PERFECT FIT, PICTURE MODE, ECO MODE, INSTALLATION, RESET, FILTER TIME, LANGUAGE, ADVANCED MENU, EXIT
<b>PICTURE</b> (📖42)	BRIGHTNESS, CONTRAST, GAMMA, COLOR TEMP, COLOR, TINT, SHARPNESS, ACTIVE IRIS, MY MEMORY
<b>IMAGE</b> (📖45)	ASPECT, OVER SCAN, V POSITION, H POSITION, H PHASE, H SIZE, AUTO ADJUST EXECUTE
<b>INPUT</b> (📖48)	PROGRESSIVE, VIDEO NR, COLOR SPACE, COMPONENT, VIDEO FORMAT, HDMI FORMAT, HDMI RANGE, COMPUTER IN, FRAME LOCK, RESOLUTION
<b>SETUP</b> (📖52)	AUTOKEYSTONE,  KEYSTONE,  KEYSTONE, PERFECTFIT, AUTO ECO MODE, ECO MODE, INSTALLATION, STANDBY MODE, MONITOR OUT
<b>AUDIO</b> (📖55)	VOLUME, SPEAKER, AUDIO SOURCE, HDMI AUDIO
<b>SCREEN</b> (📖57)	LANGUAGE, MENU POSITION, BLANK, START UP, MyScreen, MyScreen Lock, MESSAGE, SOURCE NAME, TEMPLATE, C. C.
<b>OPTION</b> (📖63)	SOURCE SKIP, AUTO SEARCH, AUTO KEYSTONE, DIRECT POWER ON, AUTO POWER OFF, SHADE TIMER, USB TYPE B, LAMP TIME, FILTER TIME, MY BUTTON, SERVICE
<b>NETWORK</b> (📖74)	WIRELESS SETUP, WIRELESS INFORMATION, WIRED SETUP, WIRED INFORMATION, PROJECTOR NAME, MY IMAGE, AMX D. D., PRESENTATION, SERVICE
<b>SECURITY</b> (📖85)	SECURITY PASSWORD CHANGE, MyScreen PASSWORD, PIN LOCK, TRANSITION DETECTOR, MY TEXT PASSWORD, MY TEXT DISPLAY, MY TEXT WRITING, SECURITY INDICATOR, STACK LOCK

## EASY MENU

From the EASY MENU, items shown in the table below can be performed.

Select an item using the ▲/▼ cursor buttons. Then perform it according to the following table.

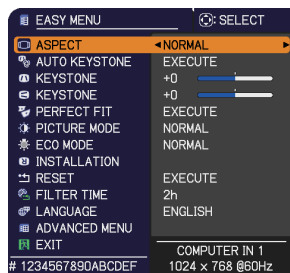

Item	Description
<b>ASPECT</b>	Using the ◀/▶ buttons switches the mode for aspect ratio. See the ASPECT item in IMAGE menu (📐45).
<b>AUTO KEYSTONE</b>	Using the ▶ button executes the auto keystone function. See the AUTO KEYSTONE item in SETUP menu (📐52).
<b>ⓐ KEYSTONE</b>	Using the ◀/▶ buttons corrects the vertical keystone distortion. See the ⓐ KEYSTONE item in SETUP menu (📐52).
<b>ⓑ KEYSTONE</b>	Using the ◀/▶ buttons corrects the horizontal keystone distortion. See the ⓑ KEYSTONE in SETUP menu (📐53).
<b>PERFECT FIT</b>	Pressing the ▶ button displays the PERFECT FIT dialog. See the PERFECT FIT item in SETUP menu (📐53).
<b>PICTURE MODE</b>	Using the ◀/▶ buttons switches the picture mode. The picture modes are combinations of GAMMA and COLOR TEMP settings. Choose a suitable mode according to the projected source. NORMAL ⇄ CINEMA ⇄ DYNAMIC ⇄ BOARD(BLACK) ⇕ DICOM SIM. ⇄ DAYTIME ⇄ WHITEBOARD ⇄ BOARD(GREEN) (continued on next page)

(continued on next page)



Item	Description		
<b>PICTURE MODE</b> (continued)		GAMMA	COLOR TEMP
	NORMAL	1 DEFAULT	2 MID
	CINEMA	2 DEFAULT	3 LOW
	DYNAMIC	3 DEFAULT	1 HIGH
	BOARD(BLACK)	4 DEFAULT	4 Hi-BRIGHT-1
	BOARD(GREEN)	4 DEFAULT	5 Hi-BRIGHT-2
	WHITEBOARD	5 DEFAULT	2 MID
	DAYTIME	6 DEFAULT	6 Hi-BRIGHT-3
	DICOM SIM.	7 DEFAULT	2 MID
<b>ECO MODE</b>	<ul style="list-style-type: none"> <li>• When the combination of GAMMA and COLOR TEMP differs from pre-assigned modes above, the display on the menu for the PICTURE MODE is "CUSTOM". Please refer to the GAMMA and COLOR TEMP (42, 43) items in PICTURE menu.</li> <li>• Lines or other noise might appear on the screen when this function is operated, but it is not a malfunction.</li> <li>• DICOM SIM. is the projector's DICOM® ("Digital Imaging and Communication in Medicine") simulation mode. This mode simulates the DICOM standard, which is a standard applicable to digital communications in medicine, and can be useful for displaying medical images, such as X-rays photos. This projector is not a medical device and is not compliant to the DICOM standard, and neither the projector nor the DICOM SIM. mode should be used for medical diagnosis.</li> </ul>		
<b>INSTALLATION</b>	Using the ◀/▶ buttons turns off/on the Eco mode. See the ECO MODE item in SETUP menu (53).		
<b>RESET</b>	Pressing the ▶ button displays the INSTALLATION dialog. See the INSTALLATION item in SETUP menu (53).		
<b>FILTER TIME</b>	Performing this item resets all of the EASY MENU items except the FILTER TIME and LANGUAGE. A dialog is displayed for confirmation. Selecting the OK using the ▶ button performs resetting.		
<b>LANGUAGE</b>	The usage time of the air filter is shown in the menu. Performing this item resets the filter time which counts usage time of the air filter. A dialog is displayed for confirmation. Selecting the OK using the ▶ button performs resetting. See the FILTER TIME item in OPTION menu (65).		
<b>ADVANCED MENU</b>	Using the ◀/▶ buttons changes the display language. See the LANGUAGE item in SCREEN menu (57).		
<b>EXIT</b>	Press the ▶ or ENTER button to use the menu of PICTURE, IMAGE, INPUT, SETUP, AUDIO, SCREEN, OPTION, NETWORK or SECURITY.		
<b>EXIT</b>	Press the ◀ or ENTER button to finish the OSD menu.		

## PICTURE menu

From the PICTURE menu, items shown in the table below can be performed.



Select an item using the ▲/▼ cursor buttons, and press the ► cursor button or **ENTER** button to execute the item. Then perform it according to the following table.

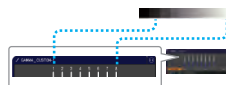

Item	Description
<b>BRIGHTNESS</b>	Using the ◀/▶ buttons adjusts the brightness. Dark ⇔ Light
<b>CONTRAST</b>	Using the ◀/▶ buttons adjusts the contrast. Weak ⇔ Strong
<b>GAMMA</b>	<p>Using the ▲/▼ buttons switches the gamma mode.</p> <p>1 DEFAULT ⇔ 1 CUSTOM ⇔ 2 DEFAULT ⇔ 2 CUSTOM ⇔ 3 DEFAULT ⇕ 7 CUSTOM ⇕ 3 CUSTOM ⇕ 7 DEFAULT ⇕ 4 DEFAULT ⇕ 6 CUSTOM ⇔ 6 DEFAULT ⇔ 5 CUSTOM ⇔ 5 DEFAULT ⇔ 4 CUSTOM</p> <p><b>To adjust CUSTOM</b></p> <p>Selecting a mode whose name includes CUSTOM and then pressing the ► button or the <b>ENTER</b> button displays a dialog to aid you in adjusting the mode. This function is useful when you want to change the brightness of particular tones. Choose an item using the ◀/▶ buttons, and adjust the level using the ▲/▼ buttons. You can display a test pattern for checking the effect of your adjustment by pressing the <b>ENTER</b> button. Each time you press the <b>ENTER</b> button, the pattern changes as below.</p> <p>No pattern ⇔ Gray scale of 9 steps ⇐ ⇑ Ramp ⇔ Gray scale of 15 steps</p> <p>The eight equalizing bars correspond to eight tone levels of the test pattern (Gray scale of 9 steps) except the darkest in the left end. If you want to adjust the 2nd tone from left end on the test pattern, use the equalizing adjustment bar "1". The darkest tone at the left end of the test pattern cannot be controlled with any of equalizing adjustment bar.</p> <ul style="list-style-type: none"> <li>• Lines or other noise might appear on the screen when this function is operated, but it is not a malfunction.</li> </ul>

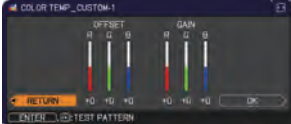

(continued on next page)

Item	Description
<p><b>COLOR TEMP</b></p>	<p>Using the ▲/▼ buttons switches the color temperature mode.</p> <p>1 HIGH ⇄ 1 CUSTOM ⇄ 2 MID ⇄ 2 CUSTOM ⇄ 3 LOW ⇄ 3 CUSTOM          ⇅          6 CUSTOM ⇄ 4 Hi-BRIGHT-1          ⇅          ⇅ 6 Hi-BRIGHT-3 ⇄ 5 CUSTOM ⇄ 5 Hi-BRIGHT-2 ⇄ 4 CUSTOM ⇅</p> <p><b>To adjust CUSTOM</b></p> <p>Selecting a mode whose name includes CUSTOM and then pressing the ► button or the <b>ENTER</b> button displays a dialog to aid you in adjusting the OFFSET and GAIN of the selected mode.</p>  <p>OFFSET adjustments change the color intensity on the whole tones of the test pattern. GAIN adjustments mainly affect color intensity on the brighter tones of the test pattern.</p> <p>Choose an item using the ◀/▶ buttons, and adjust the level using the ▲/▼ buttons.</p> <p>You can display a test pattern for checking the effect of your adjustment by pressing the <b>ENTER</b> button.</p> <p>Each time you press the <b>ENTER</b> button, the pattern changes as below.</p> <p>No pattern ⇄ Gray scale of 9 steps ⇅          ⇅ Ramp ⇄ Gray scale of 15 steps</p> <ul style="list-style-type: none"> <li>• Lines or other noise might appear on the screen when this function is operated, but it is not a malfunction.</li> </ul> 
<p><b>COLOR</b></p>	<p>Using the ◀/▶ buttons adjusts the strength of whole color.</p> <p>Weak ⇄ Strong</p> <ul style="list-style-type: none"> <li>• This item can be selected only for a video, s-video and component video signal.</li> <li>• For an HDMI™ signal, this item can also be selected if either (1) or (2) applies.</li> </ul> <p>(1) HDMI FORMAT item in the INPUT menu for selected port is set to VIDEO.</p> <p>(2) HDMI FORMAT item in the INPUT menu for selected port is set to AUTO, and the projector recognizes that it receives video signals.</p>
<p><b>TINT</b></p>	<p>Using the ◀/▶ buttons adjusts the tint.</p> <p>Reddish ⇄ Greenish</p> <ul style="list-style-type: none"> <li>• This item can be selected only for a video, s-video and component video signal.</li> <li>• For an HDMI™ signal, this item can also be selected if either (1) or (2) applies.</li> </ul> <p>(1) HDMI FORMAT item in the INPUT menu for selected port is set to VIDEO.</p> <p>(2) HDMI FORMAT item in the INPUT menu for selected port is set to AUTO, and the projector recognizes that it receives video signals.</p>

(continued on next page)

Item	Description
<b>SHARPNESS</b>	<p>Using the ◀/▶ buttons adjusts the sharpness. Weak ⇔ Strong</p> <ul style="list-style-type: none"> <li>• There may be some noise and/or the screen may flicker for a moment when an adjustment is made. This is not a malfunction.</li> </ul>
<b>ACTIVE IRIS</b>	<p>Using the ▲/▼ cursor buttons changes the active iris control mode. PRESENTATION ⇔ THEATER ⇔ OFF</p>  <p><u>PRESENTATION</u> : The active iris displays the best presentation image for both bright and dark scenes. <u>THEATER</u> : The active iris displays the best theater image for both bright and dark scenes. <u>OFF</u> : The active iris is always open.</p> <ul style="list-style-type: none"> <li>• The screen may flicker when the PRESENTATION or THEATER modes are selected. If this occurs select OFF.</li> </ul>
<b>MY MEMORY</b>	<p>This projector has 4 memories for adjustment data (for all the items of the PICTURE menu). Selecting a function using the ▲/▼ buttons and pressing the ▶ or <b>ENTER</b> button performs each function.</p>  <p><u>SAVE-1, SAVE-2, SAVE-3, SAVE-4</u> Performing a SAVE function saves the current adjustment data into the memory linked in the number included in the function's name.</p> <ul style="list-style-type: none"> <li>• Remember that the current data being stored of a memory will be lost by saving new data into the memory.</li> </ul> <p><u>LOAD-1, LOAD-2, LOAD-3, LOAD-4</u> Performing a LOAD function loads the data from the memory linked in the number included in the function's name, and adjusts the picture automatically depending on the data.</p> <ul style="list-style-type: none"> <li>• The LOAD functions whose linked memory has no data are skipped.</li> <li>• Remember that the current adjusted condition will be lost by loading data. If you want to keep the current adjustment, please save it before performing a LOAD function.</li> <li>• There may be some noise and the screen may flicker for a moment when loading data. This is not malfunction.</li> <li>• You can perform the LOAD function using <b>MY BUTTON</b>. Please see MY BUTTON item in OPTION menu (p.66).</li> </ul>

IMAGE menu

From the IMAGE menu, items shown in the table below can be performed. Select an item using the ▲/▼ cursor buttons, and press the ► cursor button or **ENTER** button to execute the item. Then perform it according to the following table. for selected port

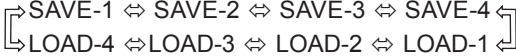
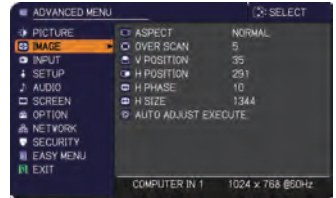

Item	Description
<b>ASPECT</b>	<p>Using the ▲/▼ buttons switches the mode for aspect ratio.</p> <p><b>For a computer signal</b></p> <p><b>8970, 8971:</b>            NORMAL ⇔ 4:3 ⇔ 16:9 ⇔ 16:10</p> <p><b>8972W, 8973W, 8976SX, 8974WU, 8975WU:</b>            NORMAL ⇔ 4:3 ⇔ 16:9 ⇔ 16:10 ⇔ NATIVE</p> <p><b>For an HDMI™ signal</b></p> <p><b>8970, 8971:</b>            NORMAL ⇔ 4:3 ⇔ 16:9 ⇔ 16:10 ⇔ 14:9</p> <p><b>8972W, 8973W, 8976SX, 8974WU, 8975WU:</b>            NORMAL ⇔ 4:3 ⇔ 16:9 ⇔ 16:10 ⇔ 14:9 ⇔ NATIVE</p> <p><b>For a video signal, s-video signal or component video signal</b></p> <p><b>8970, 8971:</b>            4:3 ⇔ 16:9 ⇔ 14:9</p> <p><b>8976SX:</b>            4:3 ⇔ 16:9 ⇔ 14:9 ⇔ NATIVE</p> <p><b>8972W, 8973W, 8974WU, 8975WU:</b>            4:3 ⇔ 16:9 ⇔ 16:10 ⇔ 14:9 ⇔ NATIVE</p> <p><b>For an input signal from the LAN, USB TYPE A or USB TYPE B ports, or if there is no signal</b></p> <p><b>8970, 8971, 89876SX:</b> 4:3 (fixed)  <b>8972W, 8973W, 8974WU, 8975WU:</b> 16:10 (fixed)</p> <ul style="list-style-type: none"> <li>• The NORMAL mode keeps the original aspect ratio of the signal.</li> </ul>

(continued on next page)

Item	Description
<b>OVER SCAN</b>	<p>Using the ◀/▶ buttons adjusts the over-scan ratio.                      Small (It magnifies picture) ⇔ Large (It reduces picture)</p> <ul style="list-style-type: none"> <li>• This item can be selected only for a video, s-video and component video signal.</li> <li>• For an HDMI™ signal, this item can also be selected if either (1) or (2) applies.                             <ol style="list-style-type: none"> <li>(1) HDMI FORMAT item in the INPUT menu for selected port is set to VIDEO.</li> <li>(2) HDMI FORMAT item in the INPUT menu for selected port is set to AUTO, and the projector recognizes that it receives video signals.</li> </ol> </li> </ul>
<b>V POSITION</b>	<p>Using the ◀/▶ buttons adjusts the vertical position.                      Down ⇔ Up</p> <ul style="list-style-type: none"> <li>• Over-adjusting the vertical position may cause noise to appear on the screen. If this occurs, please reset the vertical position to the default setting. Pressing the <b>RESET</b> button when the V POSITION is selected will reset the V POSITION to the default setting.</li> <li>• When this function is performed on a video signal or an s-video signal, the range of this adjustment depends on OVER SCAN (📄above) setting. It is not possible to adjust when OVER SCAN is set to 10.</li> <li>• This function is unavailable for a signal from the <b>LAN, USB TYPE A / B or HDMI 1 / 2</b> port.</li> </ul>
<b>H POSITION</b>	<p>Using the ◀/▶ buttons adjusts the horizontal position.                      Right ⇔ Left</p> <ul style="list-style-type: none"> <li>• Over-adjusting the horizontal position may cause noise to appear on the screen. If this occurs, please reset the horizontal position to the default setting. Pressing the <b>RESET</b> button when the H POSITION is selected will reset the H POSITION to the default setting.</li> <li>• When this function is performed on a video signal or an s-video signal, the range of this adjustment depends on OVER SCAN (📄above) setting. It is not possible to adjust when OVER SCAN is set to 10.</li> <li>• This function is unavailable for a signal from the <b>LAN, USB TYPE A / B or HDMI 1 / 2</b> port.</li> </ul>

(continued on next page)

Item	Description
<b>H PHASE</b>	<p>Using the ◀/▶ buttons adjusts the horizontal phase to eliminate flicker. Right ⇔ Left</p> <ul style="list-style-type: none"> <li>• This item can be selected only for a computer signal or a component video signal. This function is unavailable for a signal from the <b>LAN</b>, <b>USB TYPE A / B</b> or <b>HDMI 1 / 2</b> port.</li> </ul>
<b>H SIZE</b>	<p>Using the ◀/▶ buttons adjusts the horizontal size. Small ⇔ Large</p> <ul style="list-style-type: none"> <li>• This item can be selected only for a computer signal. This function is unavailable for a signal from the <b>LAN</b>, <b>USB TYPE A / B</b> or <b>HDMI 1 / 2</b> port.</li> <li>• When this adjustment is excessive, the picture may not be displayed correctly. In such a case, please reset the adjustment by pressing the <b>RESET</b> button on the remote control during this operation.</li> <li>• Images might appear degraded when this function is operated, but it is not a malfunction.</li> </ul>
<b>AUTO ADJUST EXECUTE</b>	<p>Selecting this item performs the automatic adjustment feature.</p> <p><b>For a computer signal</b> The vertical position, the horizontal position and the horizontal phase will be automatically adjusted. Make sure that the application window is set to its maximum size prior to attempting to use this feature. A dark picture may still be incorrectly adjusted. Use a bright picture when adjusting.</p> <p><b>For a video signal and s-video signal</b> The video format best suited for the respective input signal will be selected automatically. This function is available only when the <b>AUTO</b> is selected for the <b>VIDEO FORMAT</b> item in the <b>INPUT</b> menu (📺49). The vertical position and horizontal position will be automatically set to the default.</p> <p><b>For a component video signal</b> The vertical position and horizontal position will be automatically set to the default. The horizontal phase will be automatically adjusted.</p> <ul style="list-style-type: none"> <li>• The automatic adjustment operation requires approx. 10 seconds. Also please note that it may not function correctly with some input.</li> <li>• When this function is performed for a video signal, a certain extra such as a line may appear outside a picture.</li> <li>• When this function is performed for a computer signal, a black frame may be displayed on the edge of the screen, depending on the computer model.</li> <li>• The items adjusted by this function may vary when the <b>FINE</b> or <b>DISABLE</b> is selected for the <b>AUTO ADJUST</b> item of the <b>SERVICE</b> item in the <b>OPTION</b> menu (📺67).</li> </ul>

## INPUT menu

From the INPUT menu, items shown in the table below can be performed. Select an item using the ▲/▼ cursor buttons, and press the ► cursor button or **ENTER** button to execute the item. Then perform it according to the following table.

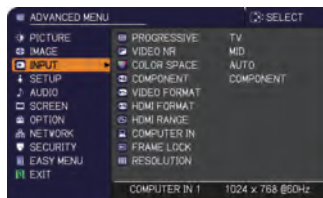

Item	Description
<b>PROGRESSIVE</b>	<p>Using the ▲/▼ buttons switches the progress mode.            TV ⇄ FILM ⇄ OFF            ↑—————↑</p> <ul style="list-style-type: none"> <li>• This function works only for a video signal, s-video signal, component video signal (of 480i@60 or 576i@50 or 1080i@50/60) and an HDMI™ signal (of 480i@60 or 576i@50 or 1080i@50/60).</li> <li>• When TV or FILM is selected, the screen image will be sharp. FILM adapts to the 2-3 Pull-Down conversion system. But these may cause a certain defect (for example, jagged line) of the picture for a quick moving object. In such a case, please select OFF, even though the screen image may lose sharpness.</li> </ul>
<b>VIDEO NR</b>	<p>Using the ▲/▼ buttons switches the noise reduction mode.            HIGH ⇄ MID ⇄ LOW            ↑—————↑</p> <ul style="list-style-type: none"> <li>• This function works only for a video signal, s-video signal, component video signal (of 480i@60 or 576i@50 or 1080i@50/60) and an HDMI™ signal (of 480i@60 or 576i@50 or 1080i@50/60).</li> </ul>
<b>COLOR SPACE</b>	<p>Using the ▲/▼ buttons switches the mode for color space.            AUTO ⇄ RGB ⇄ SMPTE240 ⇄ REC709 ⇄ REC601            ↑—————↑</p> <ul style="list-style-type: none"> <li>• This item can be selected only for a computer signal (except for signals from the <b>LAN</b>, <b>USB TYPE A</b> and <b>USB TYPE B</b> ports) or a component video signal (except SCART RGB).</li> <li>• The AUTO mode automatically selects the optimum mode.</li> <li>• The AUTO operation may not work well at some signals. In such a case, it might be good to select a suitable mode except AUTO.</li> </ul>
<b>COMPONENT</b>	<p>Using the ▲/▼ buttons switches the function of the <b>COMPONENT</b> ports.            COMPONENT ⇄ SCART RGB</p> <p>When the SCART RGB is selected, the <b>COMPONENT (Y, Cb/Pb, Cr/Pr)</b> and <b>VIDEO</b> ports will function as a SCART RGB port. A SCART adapter or SCART cable is required for a SCART RGB input to the projector. For details, contact your dealer.</p>

(continued on next page)



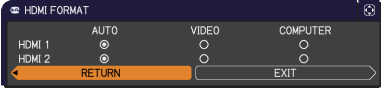
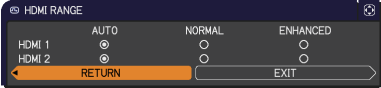

Item	Description
<p><b>VIDEO FORMAT</b></p>	<p>The video format for <b>S-VIDEO</b> port and <b>VIDEO</b> port can be set.</p> <p>(1) Use the ▲/▼ buttons to select the input port.</p> <p>(2) Using the ◀/▶ buttons switches the mode for video format.</p> <p>AUTO ⇔ NTSC ⇔ PAL ⇔ SECAM            ⇕ N-PAL ⇔ M-PAL ⇔ NTSC4.43 ⇕</p>  <ul style="list-style-type: none"> <li>• This item is performed only for a video signal from the <b>VIDEO</b> port or the <b>S-VIDEO</b> port.</li> <li>• The AUTO mode automatically selects the optimum mode.</li> <li>• The AUTO operation may not work well for some signals. If the picture becomes unstable (e.g. an irregular picture, lack of color), please select the mode according to the input signal.</li> </ul>
<p><b>HDMI FORMAT</b></p>	<p>The video format of HDMI™ input signals from the <b>HDMI 1</b> and <b>2</b> ports can be set.</p> <p>(1) Use the ▲/▼ buttons to select the <b>HDMI</b> port to be set.</p> <p>(2) Use the ◀/▶ buttons to select the video format.</p> <p>AUTO ⇔ VIDEO ⇔ COMPUTER</p>  <p><u>AUTO</u>: automatically sets the optimum mode.  <u>VIDEO</u>: sets the suitable mode for DVD signals.  <u>COMPUTER</u>: sets the suitable mode for computer signals.</p> <ul style="list-style-type: none"> <li>• When the <b>COMPUTER</b> is selected, the functions <b>COLOR</b> (PICTURE menu), <b>TINT</b> (PICTURE menu) and <b>OVER SCAN</b> (IMAGE menu) are unavailable.</li> </ul>
<p><b>HDMI RANGE</b></p>	<p>The digital range of HDMI™ input signals from the <b>HDMI 1</b> and <b>2</b> ports can be set.</p> <p>(1) Use the ▲/▼ buttons to select the <b>HDMI</b> port to be set.</p> <p>(2) Use the ◀/▶ buttons to select the digital range.</p> <p>AUTO ⇔ NORMAL ⇔ ENHANCED</p>  <p><u>AUTO</u>: automatically sets the optimum mode.  <u>NORMAL</u>: sets the suitable mode for DVD signals. (16-235)  <u>ENHANCED</u>: sets the suitable mode for computer signals. (0-255)</p> <ul style="list-style-type: none"> <li>• If the contrast of the screen image is too strong or too weak, try finding a more suitable mode.</li> </ul>

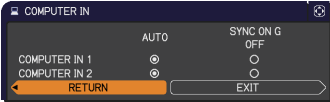
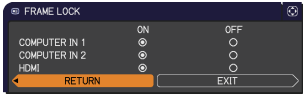
(continued on next page)

Item	Description
<p><b>COMPUTER IN</b></p>	<p>The computer input signal type for <b>COMPUTER IN1</b> and <b>IN2</b> ports can be set.</p> <p>(1) Use the ▲/▼ buttons to select the <b>COMPUTER IN</b> port to be set.</p> <p>(2) Use the ◀/▶ buttons to select the computer input signal type.</p> <p style="text-align: center;">AUTO ⇔ SYNC ON G OFF</p>  <ul style="list-style-type: none"> <li>• Selecting the AUTO mode allows you to input a sync on G signal or component video signal from the port.</li> <li>• In the AUTO mode, the picture may be distorted with certain input signals. In such a case, remove the signal connector so that no signal is received and select the SYNC ON G OFF, and then reconnect the signal.</li> </ul>
<p><b>FRAME LOCK</b></p>	<p>Set the frame lock function on/off for each port.</p> <p>(1) Use the ▲/▼ buttons to select the input ports.</p> <p>(2) Use the ◀/▶ buttons to turn the frame lock function on/off .</p> <p style="text-align: center;">ON ⇔ OFF</p>  <ul style="list-style-type: none"> <li>• This item can be performed only on a signal with a vertical frequency of 49 to 51Hz, 59 to 61 Hz.</li> <li>• When ON is selected, moving pictures are displayed more smoothly.</li> </ul>

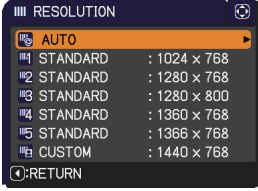
(continued on next page)

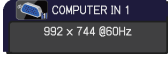
Item	Description
<p><b>RESOLUTION</b></p>	<p>The resolution for the <b>COMPUTER IN1</b> and <b>COMPUTER IN2</b> input signals can be set on this projector.</p> <p>(1) In the INPUT menu select the RESOLUTION using the ▲/▼ buttons and press the ► button. The RESOLUTION menu will be displayed.</p>  <p>(2) In the RESOLUTION menu select the resolution you wish to display using the ▲/▼ buttons. Selecting AUTO will set a resolution appropriate to the input signal.</p> <p>(3) Pressing the ► or <b>ENTER</b> button when selecting a STANDARD resolution will automatically adjust the horizontal and vertical positions, clock phase and horizontal size. The INPUT_INFORMATION dialog will be displayed.</p>  <p>(4) To set a custom resolution use the ▲/▼ buttons to select the CUSTOM and the RESOLUTION_CUSTOM box will be displayed. Set the horizontal (HORZ) and vertical (VERT) resolutions using the ▲/▼/◀/▶ buttons. This function may not support all resolutions.</p>  <p>(5) Move the cursor to OK on screen and press the ► or <b>ENTER</b> button. The message "ARE YOU SURE YOU WISH TO CHANGE RESOLUTION?" appears. To save the setting, press the ► button. The horizontal and vertical positions, clock phase and horizontal size will be automatically adjusted. The INPUT_INFORMATION dialog will be displayed.</p>  <p>(6) To revert back to the previous resolution without saving changes, move the cursor to CANCEL on screen and press the ◀ or <b>ENTER</b> button. The screen will then return to the RESOLUTION menu displaying the previous resolution.</p> <ul style="list-style-type: none"> <li>• For some pictures, this function may not work well.</li> </ul>

## SETUP menu

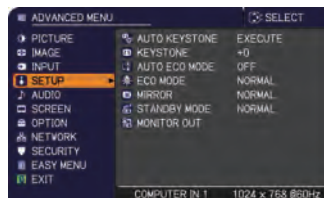

From the SETUP menu, items shown in the table below can be performed.

Select an item using the ▲/▼ cursor buttons, and press the ► cursor button or **ENTER** button to execute the item. Then perform it according to the following table.



Item	Description
<p><b>AUTO KEYSTONE</b></p>	<p>Selecting this item performs the Automatic keystone distortion correction. Projector automatically corrects vertical keystone distortion due to the (forward/backward) setup angle by itself. This function will be executed only once when selected in the menu. When the slant of the projector is changed, execute this function again.</p> <ul style="list-style-type: none"> <li>• The adjustable range of this function will vary among inputs. For some input, this function may not work well.</li> <li>• When the projector is in one of the following conditions, the automatic vertical keystone correction feature may not work correctly or at all.                     <ul style="list-style-type: none"> <li>- REAR / CEILING or FRONT / CEILING is selected for the INSTALLATION item in the SETUP menu, and the projector screen is slanted or tilted downwards.</li> <li>- The ZOOM adjustment is not set to the full WIDE (wide-angle focus).</li> <li>- The projector is nearly horizontal (about ±4°).</li> <li>- The projector is inclined at about ±35 degrees or over.</li> </ul> </li> <li>• This function is unavailable when the TRANSITION DETECTOR (📖88) is ON or the screen is adjusted by PERFECT FIT (📖33, 34).</li> </ul>
<p><b>KEYSTONE</b></p>	<p>Using the ◀/▶ buttons corrects the vertical keystone distortion.</p> <p>Shrink the bottom of the image ⇔ Shrink the top of the image</p> <ul style="list-style-type: none"> <li>• The adjustable range of this function will vary among inputs. For some input, this function may not work well.</li> <li>• When the zoom adjustment is set to the TELE (telephoto focus), this function may be excessive. This function should be used when the zoom adjustment is set to the full WIDE (wide-angle focus) whenever possible.</li> <li>• This function is unavailable when the TRANSITION DETECTOR (📖88) is ON or the screen is adjusted by PERFECT FIT (📖33, 34).</li> </ul>

(continued on next page)

Item	Description
 <b>KEYSTONE</b>	<p>Using the ◀/▶ buttons corrects the horizontal keystone distortion.                      Shrink the right of the image ⇔ Shrink the left of the image</p> <ul style="list-style-type: none"> <li>• The adjustable range of this function will vary among inputs. For some input, this function may not work well.</li> <li>• When the horizontal lens shift is not set to the center, this function may not work well.</li> <li>• This function is unavailable when the TRANSITION DETECTOR (📖88) is ON or the screen is adjusted by PERFECT FIT (📖33, 34).</li> </ul>
<b>PERFECT FIT</b>	<p>Selecting this item displays the PERFECT FIT dialog. For details, see PERFECT FIT in <b>Correcting the distortion</b> (📖33, 34).</p> <ul style="list-style-type: none"> <li>• This is unavailable when the TRANSITION DETECTOR is ON (📖88).</li> </ul>
<b>AUTO ECO MODE</b>	<p>Using the ▲/▼ buttons turns on/off the AUTO ECO MODE.                      ON ⇔ OFF</p> <ul style="list-style-type: none"> <li>• When ON is selected, the projector will always be set to Eco mode at start-up regardless of the ECO MODE (📖below) setting. An OSD message “AUTO ECO MODE” will be displayed for tens of seconds when the projector starts with this function activated.</li> </ul>
<b>ECO MODE</b>	<p>Using the ▲/▼ buttons turns off/on the Eco mode.                      NORMAL ⇔ ECO</p> <ul style="list-style-type: none"> <li>• When the ECO is selected, acoustic noise and screen brightness are reduced.</li> <li>• When AUTO ECO MODE (📖above) is set to ON, the projector will always be set to Eco mode at start-up regardless this setting.</li> </ul>
<b>INSTALATION</b>	<p>Pressing the ▶ button displays the dialog for changing the INSTALLATION setting.</p> <div style="display: flex; align-items: center;">  <div style="margin-left: 10px;"> <p>FRONT / DESKTOP</p> <p>⇕</p> <p>REAR / DESKTOP</p> <p>⇕</p> <p>REAR / CEILING</p> <p>⇕</p> <p>FRONT / CEILING</p> </div> </div> <p>Use the ▲/▼ buttons to select the desired setting on the INSTALLATION dialog, and press the <b>ENTER</b> button of the remote control or the <b>INPUT</b> button of the projector to execute.</p> <p>If TRANSITION DETECTOR is ON and the INSTALLATION status is changed, the TRANSITION DETECTOR ON alarm (📖88) will be displayed when the projector is restarted.</p>

(continued on next page)

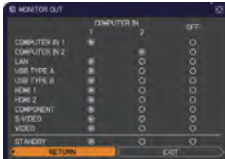
Item	Description
<p><b>STANDBY MODE</b></p>	<p>Using ▲/▼ buttons switches the standby mode setting between NORMAL and SAVING.</p> <p>NORMAL ⇔ SAVING</p> <p>When SAVING is selected, the power consumption in the standby mode is lowered with some functional restriction as below:</p> <ul style="list-style-type: none"> <li>• When SAVING is selected, the RS-232C communication control except to turn the projector on and the network function are disabled while the projector is in the standby mode. If the COMMUNICATION TYPE in the COMMUNICATION menu is set to NETWORK BRIDGE, all of the RS-232C commands are disabled (p.70).</li> <li>• When SAVING is selected, AUDIO OUT STANDBY setting of AUDIO SOURCE (p.55) is invalid, and no signal is output from <b>AUDIO OUT</b> port in the standby mode.</li> <li>• When SAVING is selected, STANDBY setting of MONITOR OUT is invalid, and no signal is output from <b>MONITOR OUT</b> port in the standby mode.</li> <li>• When SAVING is selected, the CENTERING feature while the projector is in the standby mode is disabled.</li> <li>• &lt;Only for 8971, 8973W and 8975WU&gt; When SAVING is selected, the Status Monitor and its button operation are unavailable while the projector is in the standby mode.</li> </ul>
<p><b>MONITOR OUT</b></p>	<p>While the image signal from the input port chosen in step (1) is projected, the image signal from the input port selected in step (2) is output to <b>MONITOR OUT</b> port.</p> <p>(1) Choose a picture input port using ▲/▼ buttons. Choose STANDBY to select the picture output in the standby mode.</p> <p>(2) Select one of the <b>COMPUTER IN</b> ports using ◀/▶ buttons. Select OFF to disable the <b>MONITOR OUT</b> port for the input port or standby mode chosen in the step (1).</p> <p>• You cannot select <b>COMPUTER IN1</b> in step (1) and <b>COMPUTER IN2</b> in step (2) and vice versa.</p> 

AUDIO menu

From the AUDIO menu, items shown in the table below can be performed. Select an item using the ▲/▼ cursor buttons, and press the ► cursor button or the ENTER button to execute the item. Then perform it according to the following table.



Item	Description								
<b>VOLUME</b>	Using the ◀/▶ buttons adjusts the volume. Low ⇔ High								
<b>SPEAKER</b>	Using the ▲/▼ buttons turns on/off the built-in speaker. ON ⇔ OFF When OFF is selected, the built-in speaker does not work.								
<b>AUDIO SOURCE</b>	<p>While the image signal from the input port chosen in step (1) is projected, the audio signal from the input port selected in step (2) is output to both the <b>AUDIO OUT</b> port and built-in speaker of this projector. However, the built-in speaker does not work when SPEAKER is set to OFF.</p> <p>(1) Choose a picture input port using the ▲/▼ buttons. Choose <b>AUDIO OUT STANDBY</b> to select the sound output in the standby mode.</p> <p>(2) Select an audio input port or the mute icon using the ◀/▶ buttons. The icons indicate the following;</p> <table data-bbox="336 925 896 1069"> <tr> <td>No.1: <b>AUDIO IN1</b> port</td> <td>No.2: <b>AUDIO IN2</b> port</td> </tr> <tr> <td>No.3: <b>AUDIO IN3</b> ports</td> <td>No.4: <b>LAN</b> port</td> </tr> <tr> <td>No.5: <b>USB TYPE A</b> ports</td> <td>No.6: <b>USB TYPE B</b> port</td> </tr> <tr> <td>No.7: <b>HDMI 1</b> port</td> <td>No.8: <b>HDMI 2</b> port</td> </tr> </table> <p>⌘ : mutes the sound</p> <ul style="list-style-type: none"> <li>• Audio input from port nos.4 to 8 can only be selected by each of the picture input ports.</li> <li>• C.C. (Closed Caption) is automatically activated when ⌘ is selected and an input signal containing C.C. is received. This function is available only when the signal is NTSC for <b>VIDEO</b> or <b>S-VIDEO</b>, or 480i@60 for <b>COMPONENT</b>, <b>COMPUTER IN1</b> or <b>COMPUTER IN2</b>, and when AUTO is selected for DISPLAY in the C.C. menu under the SCREEN menu (62).</li> </ul>	No.1: <b>AUDIO IN1</b> port	No.2: <b>AUDIO IN2</b> port	No.3: <b>AUDIO IN3</b> ports	No.4: <b>LAN</b> port	No.5: <b>USB TYPE A</b> ports	No.6: <b>USB TYPE B</b> port	No.7: <b>HDMI 1</b> port	No.8: <b>HDMI 2</b> port
No.1: <b>AUDIO IN1</b> port	No.2: <b>AUDIO IN2</b> port								
No.3: <b>AUDIO IN3</b> ports	No.4: <b>LAN</b> port								
No.5: <b>USB TYPE A</b> ports	No.6: <b>USB TYPE B</b> port								
No.7: <b>HDMI 1</b> port	No.8: <b>HDMI 2</b> port								



(continued on next page)

Item	Description
<p><b>HDMI AUDIO</b></p>	<p>The mode of HDMI™ audio from the <b>HDMI 1</b> and <b>2</b> ports can be set.</p> <p>(1) Use the ▲/▼ buttons to select the <b>HDMI</b> port to be set.</p> <p>(2) Use the ◀/▶ buttons to select the mode of HDMI™ audio.</p> <p>Check each of the two modes provided and select the suitable one for your HDMI™ audio device.</p>







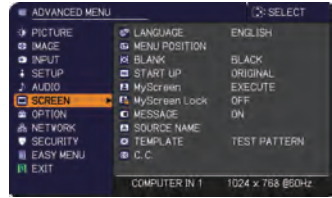

SCREEN menu

From the SCREEN menu, items shown in the table below can be performed. Select an item using the ▲/▼ cursor buttons, and press the ► cursor button or **ENTER** button to execute the item. Then perform it according to the following table.

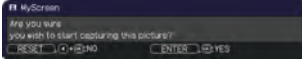

Item	Description
<b>LANGUAGE</b>	<p>Using the ▲/▼/◀/▶ buttons switches the OSD (On Screen Display) language.                      ENGLISH ⇄ FRANÇAIS ⇄ DEUTSCH ⇄ ESPAÑOL                      ⤴ ..... (shown in the LANGUAGE dialog) ..... ⤵                      Press the <b>ENTER</b> or <b>INPUT</b> button to save the language setting.</p>
<b>MENU POSITION</b>	<p>Using the ▲/▼/◀/▶ buttons adjusts the menu position. To quit the operation, press the <b>MENU</b> button on the remote control or keep no operation for about 10 seconds.</p>
<b>BLANK</b>	<p>Using the ▲/▼ buttons switches the BLANK screen. The BLANK screen is displayed for the AV MUTE function (📖25). It is displayed by pressing the <b>AV MUTE</b> button on the remote control.                      MyScreen ⇄ ORIGINAL ⇄ BLUE ⇄ WHITE ⇄ BLACK                      ⤴ ..... ⤵  <u>MyScreen</u> : Screen can be registered by the MyScreen item (📖58).  <u>ORIGINAL</u> : Screen preset as the standard screen.  <u>BLUE, WHITE, BLACK</u> : Plain screens in each color.                      • To avoid remaining as an afterimage, the MyScreen or ORIGINAL screen will change to the plain black screen after several minutes.</p>
<b>START UP</b>	<p>Using the ▲/▼ buttons switches the mode for the start-up screen. The start-up screen is a screen displayed when no signal or an unsuitable signal is detected.                      MyScreen ⇄ ORIGINAL ⇄ OFF                      ⤴ ..... ⤵  <u>MyScreen</u> : Screen can be registered by the MyScreen item (📖58).  <u>ORIGINAL</u> : Screen preset as the standard screen.  <u>OFF</u> : Plain black screen.                      • To avoid remaining as an afterimage, the MyScreen or ORIGINAL screen will change to the BLANK screen (📖above) after several minutes. If also the BLANK screen is the MyScreen or ORIGINAL, the plain black screen is instead used.                      • When the ON is selected to the MyScreen PASSWORD item in the SECURITY menu (📖86), the START UP is fixed to MyScreen.</p>

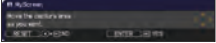
(continued on next page)

Item	Description
<p><b>MyScreen</b></p>	<p>This item allows you to capture an image for use as a MyScreen image which can be used as the BLANK screen and START UP screen. Display the image you want to capture before executing the following procedure.</p> <p>(1) Selecting this item displays a dialog titled "MyScreen". It will ask you if you start capturing an image from the current screen.</p>  <p>Please wait for the target image to be displayed, and press the <b>ENTER</b> or <b>INPUT</b> button when the image is displayed. The image will freeze and the frame for capturing will appear.</p> <p>To stop performing, press the <b>RESET</b> button on the remote control.</p> <p>(2) Using the <b>▲/▼/◀/▶</b> buttons adjusts the frame position.</p>  <p>Please move the frame to the position of the image which you want to use. The frame may not be able to be moved for some input signals.</p>  <p>To start registration, press the <b>ENTER</b> or <b>INPUT</b> button on the remote control.</p>  <p>To restore the screen and return to the previous dialog, press the <b>RESET</b> button on the remote control. Registration may take several minutes.</p> <p>When the registration is completed, the registered screen and the following message is displayed for several seconds:</p> <p><b>"MyScreen registration is finished."</b></p> <p>If the registration failed, the following message is displayed:</p> <p><b>"A capturing error has occurred. Please try again."</b></p> <ul style="list-style-type: none"> <li>• This function cannot be selected when the ON is selected to the MyScreen Lock item ( <a href="#">1059</a> ).</li> <li>• This function cannot be selected when the ON is selected to the MyScreen PASSWORD item in SECURITY menu ( <a href="#">1086</a> ).</li> <li>• This function is unavailable for a signal from the <b>LAN, USB TYPE A / B</b> or <b>HDMI 1 / 2</b> port.</li> <li>• Drawing with Drawing function cannot be captured ( <a href="#">10102</a> ).</li> </ul>

(continued on next page)

Item	Description
<b>MyScreen Lock</b>	<p>Using the ▲/▼ buttons turns on/off the MyScreen lock function. ON ⇄ OFF</p> <p>When the ON is selected, the item MyScreen is locked. Use this function for protecting the current MyScreen.</p> <ul style="list-style-type: none"> <li>• This function cannot be selected when the ON is selected to the MyScreen PASSWORD item in SECURITY menu (📖 86).</li> </ul>
<b>MESSAGE</b>	<p>Using the ▲/▼ buttons turns on/off the message function. ON ⇄ OFF</p> <p>When the ON is selected, the following message function works.</p> <p>“AUTO IN PROGRESS” while automatically adjusting  “NO INPUT IS DETECTED”  “SYNC IS OUT OF RANGE”  “INVALID SCAN FREQ.”  “NOT AVAILABLE”  “+++ FOCUS +++”  “Searching....” while searching for the input  “Detecting....” while an input signal is detected  “AUTO ECO MODE” while starting up with AUTO ECO MODE</p> <p>The indication of the input signal displayed by changing  The indication of the aspect ratio displayed by changing  The indication of the PICTURE MODE displayed by changing  The indication of the ACTIVE IRIS displayed by changing  The indication of the MY MEMORY displayed by changing  The indication of “FREEZE” and “II” while freezing the screen by pressing the <b>FREEZE</b> button.  The indication of the TEMPLATE displayed by changing.  The indication of the ECO MODE displayed by changing.</p> <ul style="list-style-type: none"> <li>• When the OFF is selected, please remember if the picture is frozen. Do not mistake freezing for a malfunction (📖 36).</li> </ul>

(continued on next page)

Item	Description
<p><b>SOURCE NAME</b></p>	<p>Each input port for this projector can have a name applied to it.</p> <ol style="list-style-type: none"> <li>(1) Use the ▲/▼ buttons on the SCREEN menu to select SOURCE NAME and press the ► or <b>ENTER</b> button. The SOURCE NAME menu will be displayed.</li> <li>(2) Use the ▲/▼ buttons on the SOURCE NAME menu to select the port to be named and press the ► button. The SOURCE NAME dialog will be displayed. Right side of the menu is blank until a name is specified.</li> <li>(3) Select an icon you would like to assign to the port in the SOURCE NAME dialog. The name assigned to the port will also be automatically switched according to your icon selection. Press the <b>ENTER</b> or <b>INPUT</b> button to determine your icon selection.</li> <li>(4) Select a number you would like to assign to the port along with the icon. You can select the number either from blank (no number assigned), 1, 2, 3, or 4. Then press the <b>ENTER</b> or <b>INPUT</b> button.</li> <li>(5) If you would like to modify the name assigned to the port, select CUSTOM NAME and press the <b>ENTER</b> or <b>INPUT</b> button.</li> </ol>





(continued on next page)

Item	Description
<p><b>SOURCE NAME</b> (continued)</p>	<p>(6) The current name will be displayed on the first line. Use the ▲/▼/◀/▶ buttons and the <b>ENTER</b> or <b>INPUT</b> button to select and enter characters. To erase 1 character at one time, press the <b>RESET</b> button or press the ◀ and <b>INPUT</b> button at the same time. Also if you move the cursor to <b>DELETE</b> or <b>ALL CLEAR</b> on screen and press the <b>ENTER</b> or <b>INPUT</b> button, 1 character or all characters will be erased. The name can be a maximum of 16 characters.</p> <p>(7) To change an already inserted character, press the ▲ button to move the cursor to the first line, and use the ◀/▶ buttons to move the cursor on the character to be changed.</p> <p>After pressing the <b>ENTER</b> or <b>INPUT</b> button, the character is selected. Then, follow the same procedure as described at the item (6) above.</p> <p>(8) To finish entering text, move the cursor to the OK on screen and press the ▶, <b>ENTER</b> or <b>INPUT</b> button. To revert to the previous name without saving changes, move the cursor to the <b>CANCEL</b> on screen and press the ◀, <b>ENTER</b> or <b>INPUT</b> button.</p> 
<p><b>TEMPLATE</b></p>	<p>Using the ▲/▼ cursor buttons switches the mode for the template screen.</p> <p>Press the ▶ cursor (or the <b>ENTER</b>) button to display the selected template, and press the ◀ cursor button to close the displayed screen.</p> <p>The last selected template is displayed when the <b>MY BUTTON</b> allocated to the <b>TEMPLATE</b> function is pressed (66).</p> <p>TEST PATTERN ⇔ DOT-LINE1 ⇔ DOT-LINE2 ⇔ DOT-LINE3          ⇕ ⇕</p> <p>STACK ⇔ MAP2 ⇔ MAP1 ⇔ CIRCLE2 ⇔ CIRCLE1 ⇔ DOT-LINE4</p> <p>You can turn a map upside down and scroll it horizontally when MAP1 or MAP2 is selected. To invert or scroll the map, display the guidance by pressing the <b>RESET</b> button on the remote three seconds or more when MAP1 or MAP2 appears.</p>

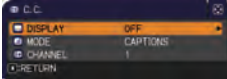
(continued on next page)

Item	Description
<p align="center"><b>C.C. (Closed Caption)</b></p>	<p>The C.C. is the function that displays a transcript or dialog of the audio portion of a video, files or other presentation or other relevant sounds. It is required to have NTSC format video or 480i@60 format component video source supporting C.C. feature to utilize this function.</p> <p>It may not work properly, depending on equipment or signal source. In this case, please turn off the Closed Caption.</p> 
	<p><b>DISPLAY</b> Select Closed Caption DISPLAY setting from following options using ▲/▼ buttons.</p> <p align="center">AUTO ⇔ ON ⇔ OFF</p> <p align="center">↑—————↓</p> <p><u>AUTO</u> : Closed Caption automatically appears when the input signal (C.C. compatible) from the port with the mute icon set at AUDIO SOURCE is selected.</p> <p><u>ON</u> : Closed Caption is on.</p> <p><u>OFF</u> : Closed Caption is off.</p> <ul style="list-style-type: none"> <li>• The caption is not displayed when the OSD menu is active.</li> <li>• The Closed Caption is the function to display the dialogue, narration, and / or sound effects of a television program or other video sources. The Closed Caption availability is depending upon broadcaster and/or content.</li> </ul>
	<p><b>MODE</b> Select Closed Caption MODE setting from following options using ▲/▼ buttons.</p> <p align="center">CAPTIONS ⇔ TEXT</p> <p><u>CAPTIONS</u> : Display Closed Caption.</p> <p><u>TEXT</u> : Display Text data, which is for additional information such as news reports or a TV program guide. The information covers the entire screen. Not all of the C.C. program has Text information.</p>
	<p><b>CHANNEL</b> Select Closed Caption CHANNEL from following options using ▲/▼ buttons.</p> <p align="center">1 ⇔ 2 ⇔ 3 ⇔ 4</p> <p align="center">↑—————↓</p> <p>1: Channel 1, primary channel / language 2: Channel 2 3: Channel 3 4: Channel 4</p> <p>The channel data may vary, depending on the content. Some channel might be used for secondary language or empty.</p>

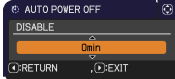

Item	Description
<p><b>DIRECT POWER ON</b></p>	<p>Using the ▲/▼ buttons turns on/off the DIRECT POWER ON function.                      ON ⇔ OFF</p> <p>When set to the ON, the lamp in projector will be automatically turned on without the usual procedure (24), only when the projector is supplied with the power after the power was cut while the lamp was on.</p> <ul style="list-style-type: none"> <li>• This function does not work as long as the power has been supplied to the projector while the lamp is off.</li> <li>• After turning the lamp on by the DIRECT POWER ON function, if neither input nor operation is detected for about 30 minutes, the projector is turned off, even though the AUTO POWER OFF function (24 below) is disabled.</li> </ul>
<p><b>AUTO POWER OFF</b></p>	<p>Using the ▲/▼ buttons adjusts the time to count down to automatically turn the projector off.                      Long (max. 99 minutes) ⇔ Short (min. 0 minute = DISABLE)</p> <div style="display: flex; justify-content: space-around; align-items: center;">   </div> <p>When the time is set to 0, the projector is not turned off automatically.</p> <p>When the time is set to 1 to 99, and when the passed time with no-signal or an unsuitable signal reaches at the set time, the projector lamp will be turned off.</p> <p>If one of the projector's buttons or the remote control buttons is pressed or one of the commands (except get commands) is transmitted to the <b>CONTROL</b> port during the corresponding time, projector will not be turned off.</p> <p>Please refer to the section <b>Turning off the power</b> (24).</p>
<p><b>SHADE TIMER</b></p>	<p>Using the ▲/▼ buttons sets the time from closing the lens shade to automatically turning the projector off.</p> <p>1h ⇔ 3h ⇔ 6h</p>  <ul style="list-style-type: none"> <li>• The shade will open automatically when turning the projector on again.</li> </ul>

(continued on next page)



Item	Description
<b>USB TYPE B</b>	<p>Using the ▲/▼ buttons selects the function of <b>USB TYPE B</b> port. To use this function, you need to connect the <b>USB TYPE B</b> port of the projector and the type A USB port of a computer.</p> <p>MOUSE ⇔ USB DISPLAY</p> <p><u>MOUSE</u>: The accessory remote control works as the simple mouse and keyboard of the computer.</p> <p><u>USB DISPLAY</u>: The port works as an input port that receives image signals from the computer (📖107).</p> <ul style="list-style-type: none"> <li>• It may take several seconds to project the images from the <b>USB TYPE B</b> port.</li> <li>• In the following cases, a message to notify you that <b>USB TYPE B</b> port is not available for picture input appears together with the USB TYPE B dialog: <ul style="list-style-type: none"> <li>- This setting is switched to MOUSE while a picture input from the <b>USB TYPE B</b> port is projected.</li> <li>- The <b>USB TYPE B</b> port is selected as the picture input source while this setting is set to MOUSE. Select USB DISPLAY in the dialog to project the picture input to the <b>USB TYPE B</b> port. In this case, you cannot use the simple mouse and keyboard function. Otherwise select other port for picture input.</li> </ul> </li> </ul>
<b>LAMP TIME</b>	<p>The lamp time is the usage time of the lamp, counted after the last resetting. It is shown in the OPTION menu.</p> <p>Pressing the <b>RESET</b> button on the remote control or the ► button of the projector displays a dialog.</p> <p>To reset the lamp time, select the OK using the ► button.</p> <p>CANCEL ⇔ OK</p> <ul style="list-style-type: none"> <li>• Please reset the lamp time only when you have replaced the lamp, for a suitable indication about the lamp.</li> <li>• For the lamp replacement, see the section <b>Replacing the lamp</b> (📖111).</li> <li>• The lamp time can be checked also with the Status Monitor on <b>8971, 8973W, 8975WU</b> (📖22).</li> </ul>
<b>FILTER TIME</b>	<p>The filter time is the usage time of the air filter, counted after the last resetting. It is shown in the OPTION menu.</p> <p>Pressing the <b>RESET</b> button on the remote control or the ► button of the projector displays a dialog.</p> <p>To reset the filter time, select the OK using the ► button.</p> <p>CANCEL ⇔ OK</p> <ul style="list-style-type: none"> <li>• Please reset the filter time only when you have cleaned or replaced the air filter, for a suitable indication about the air filter.</li> <li>• For the air filter cleaning, see the section <b>Cleaning and replacing the air filter</b> (📖113).</li> <li>• The filter time can be checked also with the Status Monitor on <b>CP-8971, 8973W, 8975WU</b> (📖22).</li> </ul>

(continued on next page)

Item	Description
<p><b>MY BUTTON</b></p>	<p>This item is to assign one of the following functions to <b>MY BUTTON (1 to 4)</b> on the remote control (☞6).</p> <p>(1) Use the ▲/▼ buttons on the MY BUTTON menu to select a button from MY BUTTON - 1 to 4 and press the ► or <b>ENTER</b> button to display the MY BUTTON setup dialog.</p> <p>(2) Then using the ▲/▼/◀/▶ buttons sets one of the following functions to the chosen button. Press the <b>ENTER</b> or <b>INPUT</b> button to save the setting.</p> <p><u>SLIDESHOW</u>: Selects the input from <b>USB TYPE A</b>, and starts a Slideshow.</p> <p><u>MY IMAGE</u>: Displays the MY IMAGE menu (☞82).</p> <p><u>MESSENGER</u>: Turns the messenger text displayed on the screen on/off (☞5. <b>Messenger Function</b> in the <b>Network Guide</b>). When there is no transferred text data to display, the message "NO MESSENGER DATA" appears.</p> <p><u>SHADE</u>: Turns the lens shade closed and opened (☞36).</p> <p><u>INFORMATION</u>: Displays SYSTEM_INFORMATION, INPUT_INFORMATION (☞73), WIRELESS INFORMATION (☞78), WIRED INFORMATION (☞80) or nothing.</p> <p><u>AUTO KEYSTONE</u>: Performs automatic keystone distortion correction (☞52).</p> <p><u>MY MEMORY</u>: Loads one of adjustment data stored (☞44). When more than one data are saved, the adjustment changes every time the <b>MY BUTTON</b> is pressed. When no data is saved in memory, the dialog "No saved data" appears.</p> <p>When the current adjustment is not saved to memory, the dialog as shown in  the right appears.</p> <p>If you want to keep the current adjustment, please press the ► button to exit. Otherwise loading a data will overwrite the current adjusted condition.</p> <p><u>ACTIVE IRIS</u>: Changes the active iris mode (☞44).</p> <p><u>PICTURE MODE</u>: Changes the PICTURE MODE (☞40).</p> <p><u>FILTER RESET</u>: Displays the filter time reset confirmation dialogue (☞65).</p> <p><u>TEMPLATE</u>: Makes the template pattern selected to the TEMPLATE item (☞61) appear or disappear.</p> <p><u>MUTE</u>: Turns the audio mute on/off.</p> <p><u>RESOLUTION</u>: Turns on/off the RESOLUTION dialog (☞51).</p> <p><u>ECO MODE</u>: Turns on/off the ECO MODE dialog (☞53).</p>



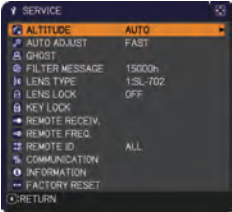

(continued on next page)

Item	Description
<b>SERVICE</b>	<p>Selecting this item displays the SERVICE menu.                      Select an item using the ▲/▼ buttons, and press the ► button or the ENTER button on the remote control to execute the item.</p> 
	<p><b>ALTITUDE</b>                      Using the ▲/▼ buttons switches the rotation speed of the cooling fans. It is recommended to leave it at AUTO speed.                      HIGH-2 ⇄ HIGH-1 ⇄ NORMAL ⇄ AUTO                      ↑—————↑</p> <p><u>AUTO</u>: The projector changes the rotation speed automatically to suit the altitude and other environmental factors.                      Choose an option below when there is a trouble with the AUTO mode.</p> <p><u>NORMAL</u>: This mode can be used below 1600m (5250ft.).  <u>HIGH-1</u>: This mode can be used between 1600 to 2300m (5250 to 7550ft.).  <u>HIGH-2</u>: This mode can be used above 2300m (7550ft.).</p>
	<p><b>AUTO ADJUST</b>                      Using the ▲/▼ buttons to select one of the mode. When the DISABLE is selected, the automatic adjustment feature is disabled.                      FINE ⇄ FAST ⇄ DISABLE                      ↑—————↑</p> <p><u>FINE</u>: Finer tuning including H.SIZE adjustment.  <u>FAST</u>: Faster tuning, setting H.SIZE to prearranged data for the input signal.</p> <ul style="list-style-type: none"> <li>Depending on conditions, such as input image, signal cable to the projector, environment around the projector, etc., the automatic adjustment may not work correctly. In such a case, please choose DISABLE to disable the automatic adjustment, and make adjustment manually.</li> </ul>
	<p><b>GHOST</b>                      Adjust the settings using the ▲/▼ buttons to eliminate ghosting.</p>

(continued on next page)

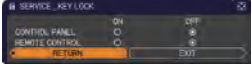
Item	Description
<p><b>SERVICE</b> (continued)</p>	<p><b>FILTER MESSAGE</b></p> <p>Use the ▲/▼ button to set the timer for notifying by the message when to replace the filter unit</p> <p><b>C8970, 8972W, 8976SX, 8974WU:</b> 1000h ⇔ 2000h ⇔ 5000h ⇔ 10000h ⇔ 15000h ⇔ OFF</p> <p><b>8970, 8973W, 8975WU:</b> 1000h ⇔ 2000h ⇔ 5000h ⇔ 10000h ⇔ 15000h ⇔ 20000h ⇔ OFF</p> <p>After choosing an item except OFF, the message “REMINDER *** HRS PASSED ...” will appear after the timer reaches the interval time set by this feature (117).</p> <p>When the OFF is chosen, the message will not appear. Utilize this feature to keep the air filter clean, setting the suitable time according to your environment of this projector.</p> <ul style="list-style-type: none"> <li>• Please take care of the filter unit periodically, even if there is no message. If the air filter becomes to be blocked by dust or other matter, the internal temperature will rise, which could cause malfunction, or reduce the lifetime of the projector.</li> <li>• Please be careful with the operating environment of the projector and the condition of the filter unit.</li> </ul>
	<p><b>LENS TYPE</b></p> <p>(1) Select the lens type currently used using the ▲/▼ buttons and press the ► or <b>ENTER</b> button. Please select one of following according to the type of lens unit. If AUTO is selected, the projector determines the lens type automatically.</p> <p>(2) A message dialog is displayed for confirmation. Press the ► or <b>ENTER</b> button to save the lens type.</p> <ul style="list-style-type: none"> <li>• This setting has an influence on the keystone distortion etc.</li> <li>• The lens type determined by the projector will be displayed on the right of "AUTO".</li> <li>• If the projector cannot determine the lens type automatically when this item is set to AUTO, "UNKNOWN LENS" is displayed on the right of "AUTO".</li> <li>• About the optional lens, ask your dealer.</li> </ul>
	<p><b>LENS LOCK</b></p> <p>Using the ▲/▼ buttons turns on/off the lens lock feature. When ON is selected, the buttons (<b>ZOOM</b>, <b>ZOOM + / -</b>, <b>FOCUS + / -</b>, <b>LENS SHIFT</b>, <b>LENS MEMORY</b>) are locked.</p> <p>ON ⇔ OFF</p>

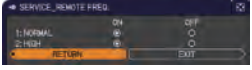
(continued on next page)

Item	Description
<p><b>SERVICE (continued)</b></p>	<p><b>KEY LOCK</b></p> <p>(1) Use the ▲/▼ buttons to choose the operations control. CONTROL PANEL ⇔ REMOTE CONTROL</p> <p>(2) Use the ◀/▶ buttons to select ON or OFF. ON ⇔ OFF</p>  <p>Selecting ON in Step 2 locks the buttons except <b>STANDBY, ON</b> and <b>STANDBY/ON</b> on the operations control selected in Step 1. Selecting OFF releases the locked buttons on the operations control selected in Step 1.</p> <ul style="list-style-type: none"> <li>• Please use this function to prevent tampering or accidental operation.</li> <li>• It's not possible to disable both options at the same time.</li> </ul>
	<p><b>REMOTE RECEIV.</b></p> <p>(1) Select a remote sensor using the ▲/▼ button. FRONT ⇔ REAR</p> <p>(2) Switch it using the ◀/▶ button. ON ⇔ OFF</p>  <ul style="list-style-type: none"> <li>• When one sensor is turned off, the other cannot be turned off too.</li> </ul>
	<p><b>REMOTE FREQ.</b></p> <p>(1) Use the ▲/▼ button to change the projector's remote sensor frequency setting (□4, 18). 1:NORMAL ⇔ 2:HIGH</p> <p>(2) Use the ◀/▶ button to change the projector's remote sensor on or off. ON ⇔ OFF</p>  <p>The factory default setting is for both 1:NORMAL and 2:HIGH to be on. If the remote control does not function correctly, disable either of them.</p> <ul style="list-style-type: none"> <li>• It's not possible to disable both options at the same time.</li> </ul>
	<p><b>REMOTE ID</b></p> <p>Use the ▲/▼ buttons on the REMOTE ID menu to select ID and press the ▶ button. ALL ⇔ 1 ⇔ 2 ⇔ 3 ⇔ 4</p>  <p>The projector is controlled by the remote control whose <b>ID</b> button is set the same number as this number. When the ALL is selected, the projector is controlled by a remote control irrespective of the ID setting.</p>

(continued on next page)

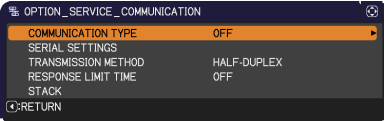
Item	Description
<p><b>SERVICE</b> (continued)</p>	<p><b>COMMUNICATION</b></p> <p>Selecting this item displays COMMUNICATION menu. In this menu, you can configure the serial communication settings of the projector using the <b>CONTROL</b> port.</p>  <ul style="list-style-type: none"> <li>• Select an item using the cursor buttons ▲/▼. Then pressing the ► button opens the submenu for the setting item you selected. Or, pressing the ◀ button instead of the ► button makes the menu back to the previous one without changing the setup. Each submenu can be operated as described above.</li> <li>• When COMMUNICATION TYPE (📖<i>below</i>) is set to OFF, the other items except STACK in COMMUNICATION menu are invalid.</li> <li>• For the function of serial communication, refer to the <b>Network Guide</b>.</li> </ul>
	<p><b>COMMUNICATION TYPE</b></p> <p>Select the communication type for transmission via the <b>CONTROL</b> port.</p> <p>NETWORK BRIDGE (WIRELESS) ⇕ NETWORK BRIDGE (WIRED) ⇕ OFF ←</p> <p><b>NETWORK BRIDGE:</b> Select this type, if it is required to control an external device as a network terminal, via this projector from the computer. Select WIRELESS or WIRED as your network connection mode. The <b>CONTROL</b> port doesn't accept RS-232C commands (📖<b>6. Network Bridge Function</b> in the <b>Network Guide</b>)</p> <p><b>OFF:</b> Select this mode to receive RS-232C commands using the <b>CONTROL</b> port.</p> <ul style="list-style-type: none"> <li>• OFF is selected as the default setting.</li> <li>• When you select the NETWORK BRIDGE, check the item, TRANSMISSION METHOD (📖<b>71</b>)</li> </ul>



(continued on next page)



Item	Description	
<p><b>SERVICE (continued)</b></p>	<p><b>COMMUNICATION (continued)</b></p>	<p><b>RESPONSE LIMIT TIME</b>                      Select the time period to wait for receiving response data from other device communicating by the NETWORK BRIDGE and the HALF-DUPLEX through the <b>CONTROL</b> port.</p> <p>OFF ⇔ 1s ⇔ 2s ⇔ 3s                      ↑—————↑</p> <p><u>OFF</u>: Select this mode if it is not required to check the responses from the device that the projector sends data to. In this mode, the projector can send out data from the computer continuously.</p> <p><u>1s /2s /3s</u>: Select the time period to keep the projector waiting for response from the device that the projector sends data to. While waiting the response, the projector does not send out any data from the <b>CONTROL</b> port.</p> <ul style="list-style-type: none"> <li>• This menu is available only when the NETWORK BRIDGE is selected for the COMMUNICATION TYPE and the HALF-DUPLEX is selected for the TRANSMISSION METHOD (71).</li> <li>• OFF is selected as the default setting.</li> </ul>
		<p><b>STACK</b>                      Selecting this item displays the STACK menu. For more information, please see <b>Instant Stack Guide</b>.</p> <ul style="list-style-type: none"> <li>• When STACK MODE is set to MAIN or SUB, the other items in COMMUNICATION menu are invalid.</li> </ul>

(continued on next page)

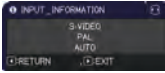

Item	Description
<p><b>SERVICE</b> (continued)</p>	<p><b>INFORMATION</b></p> <p>Selecting this item displays a dialog titled “INPUT_INFORMATION”. It shows the information about the current input.</p> <div style="display: flex; justify-content: space-around; align-items: center;">    </div> <ul style="list-style-type: none"> <li>• The “FRAME LOCK” message on the dialog means the frame lock function is working.</li> <li>• The “SCART RGB” message means the <b>COMPONENT</b> ports are working as a SCART RGB input port. Please refer to the COMPONENT item in INPUT menu (<a href="#">p.48</a>).</li> <li>• This item can't be selected for no signal and sync out.</li> <li>• When the MY TEXT DISPLAY is set to ON, the MY TEXT is displayed together with the input information in the INPUT_INFORMATION box (<a href="#">p.90</a>).</li> </ul>
	<p><b>FACTORY RESET</b></p> <p>Selecting OK using the ► button performs this function. By this function, all the items in all of menus will collectively return to the initial setting. Note that the items LAMP TIME, FILTER TIME, LANGUAGE, FILTER MESSAGE, STANDBY MODE, COMMUNICATION, NETWORK and SECURITY settings are not reset.</p> <p>CANCEL ⇨ OK</p>

NETWORK menu

Remember that incorrect network settings on this projector may cause trouble on the network. Be sure to consult with your network administrator before connecting to an existing access point on your network. Select "NETWORK" from the main menu to access the following functions.

Select an item using the ▲/▼ cursor buttons on the projector or remote control, and press the ► cursor button on the projector or remote control, or **ENTER** button on the remote control to execute the item. Then perform it according to the following table.

See the **Network Guide** for details of NETWORK operation.

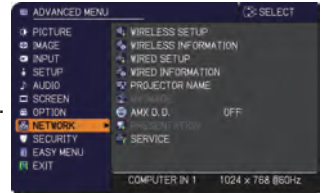

**NOTE** • To use the wireless network function of this projector, the designated USB wireless adapter that is sold as an option is required. Do not use any extension cable or device when connecting the adapter to the projector.

- The projector does not allow both wireless and wired LAN to be connected to the same network.
- Do not set the same network address for both wireless and wired LAN.
- If you are not utilizing SNTP (see 3.1.8 Date/Time Settings in the Network Guide), then you must set the DATE AND TIME during the initial installation.
- The network communication control is disabled while the projector is in standby mode if the STANDBY MODE item of SETUP menu is set to SAVING. Please connect the network communication to the projector after setting the STANDBY MODE to NORMAL (see 54).

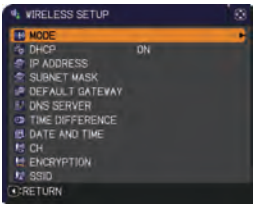

Item	Description	
<p><b>WIRELESS SETUP</b></p>	<p>Selecting this item displays the WIRELESS SETUP menu for the wireless LAN. Use the ▲/▼ buttons to select an item, and the ► or <b>ENTER</b> button on the remote control to perform the item.</p> 	
	<p><b>MODE</b></p>	<p>Use the ▲/▼ buttons to select the mode of the network communication system. Select according to the settings of your computer.</p> <p>ADHOC ↔ INFRASTRUCTURE</p> <p>To save the setting, press the ► button.</p> <ul style="list-style-type: none"> <li>• When ADHOC is selected, IEEE802.11 n cannot be used.</li> <li>• If ADHOC is set to MODE while one of WPA-PSK or WPA2-PSK is selected in ENCRYPTION, the ENCRYPTION (see 76) setting switches to OFF automatically.</li> </ul>

Item	Description	
<b>WIRELESS SETUP (continued)</b>	<b>DHCP (Dynamic Host Configuration Protocol)</b>	<p>Use the ▲/▼ buttons to turn DHCP on/off. ON ⇄ OFF</p> <p>Select OFF when the network does not have DHCP enabled. To save the setting, press the ► button.</p> <ul style="list-style-type: none"> <li>• When the “DHCP” setting changes to “ON”, it takes a little time to obtain IP address from DHCP server.</li> <li>• Auto IP function will be assigned an IP address if the projector could not obtain an IP address from server even if DHCP is “ON”</li> </ul>
	<b>IP ADDRESS</b>	<p>Use the ▲/▼/◀/▶ buttons to enter the IP ADDRESS.</p> <p>This function can only be used when DHCP is set to OFF.</p> <ul style="list-style-type: none"> <li>• The IP ADDRESS is the number that identifies this projector on the network. You cannot have two devices with the same IP ADDRESS on the same network.</li> <li>• The IP ADDRESS “0.0.0.0” is prohibited.</li> </ul>
	<b>SUBNET MASK</b>	<p>Use the ▲/▼/◀/▶ buttons to enter the same SUBNET MASK used by your computer.</p> <p>This function can only be used when DHCP is set to OFF.</p> <ul style="list-style-type: none"> <li>• The SUBNET MASK “0.0.0.0” is prohibited.</li> </ul>
	<b>DEFAULT GATEWAY</b>	<p>Use the ▲/▼/◀/▶ buttons to enter the DEFAULT GATEWAY (a node on a computer network that serves as an access point to another network) address.</p> <p>This function can only be used when DHCP is set to OFF.</p>
	<b>DNS SERVER</b>	<p>Use the ▲/▼/◀/▶ buttons to input the DNS server address.</p> <p>The DNS server is a system to control domain names and IP addresses on the Network.</p>
	<b>TIME DIFFERENCE</b>	<p>Use the ▲/▼ buttons to enter the TIME DIFFERENCE.</p> <p>Set the same TIME DIFFERENCE as the one set on your computer. If unsure, consult your IT manager.</p> <p>Use the ► button to return to the menu after setting the TIME DIFFERENCE.</p> <ul style="list-style-type: none"> <li>• When this item is set, the same item in the WIRED SETUP menu is overwritten with the same setting (  80).</li> </ul>

(continued on next page)

Item	Description	
<p><b>WIRELESS SETUP (continued)</b></p>	<p><b>DATE AND TIME</b></p>	<p>Use the ▲/▼/◀/▶ buttons to enter the Year (last two digits), Month, Date, Hour and Minute.</p> <ul style="list-style-type: none"> <li>• When this item is set, the same item in the WIRED SETUP menu is overwritten with the same setting (🔑80).</li> <li>• The projector will override this setting and retrieve DATE AND TIME information from the Time server when SNTP is enabled. (🔑3.1.8 <b>Date/Time Settings</b> in the <b>Network Guide</b>)</li> <li>• This setting will be reset if the projector is turned off while STANDBY MODE in the SETUP menu is set to SAVING (🔑54), or when the AC power is turned off.</li> </ul>
	<p><b>CH</b></p>	<p>Use the ▲/▼ buttons to select the channel of the wireless LAN to be used while MODE (🔑74) is set to ADHOC. Select according to the settings of your computer.</p> <p>The channels 1 to 11 are available. To save the setting, press the ▶ button.</p> <ul style="list-style-type: none"> <li>• The available channels would be various depending on a country. In addition, wireless network card might be required due to the standard.</li> <li>• This item can only be selected when MODE is set to ADHOC. When MODE is set to INFRASTRUCTURE, the channel is automatically selected.</li> </ul>
	<p><b>ENCRYPTION</b></p>	<p>Use the ▲/▼ buttons to select the encryption method to be used.</p> <p style="text-align: center;">             WPA2-PSK(AES) ⇔ WPA2-PSK(TKIP)              ⇕ ⇕              OFF ⇔ WPA-PSK(AES)              ⇕ ⇕              WEP 64bit ⇔ WEP 128bit ⇔ WPA-PSK(TKIP)         </p> <p>To save the setting, press the ▶ button.</p> <ul style="list-style-type: none"> <li>• When MODE (🔑74) is set to ADHOC, either WPA-PSK and WPA2-PSK cannot be selected.</li> <li>• If IEEE802.11 n is used while MODE is set to INFRASTRUCTURE, TKIP and WEP are disabled. If OFF or AES is not selected, communication will switch automatically to IEEE802.11 b/g.</li> </ul>

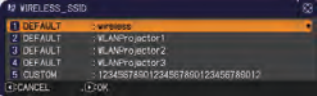
(continued on next page)

Item	Description
<p><b>WIRELESS SETUP (continued)</b></p>	<p><b>SSID</b></p> <p>Use the ▲/▼ buttons to select the SSID to display the SSID menu.</p>  <p>#1 DEFAULT ⇔ #2 DEFAULT ⇔ #3 DEFAULT          ↶ ↷ #5 CUSTOM ⇔ #4 DEFAULT ↶ ↷</p> <p>Select one of the DEFAULT (#1~#4) and press ► or <b>ENTER</b> button.</p> <p><b>To adjust CUSTOM</b></p> <p>Press the ► or <b>ENTER</b> button when the # 5 CUSTOM is selected. The SSID #5 CUSTOM menu will be appeared.</p> <p>(1) The current SSID will be displayed on the first line. If not yet written, the line will be blank. Use the ▲/▼/◀/► buttons and the <b>ENTER</b> or <b>INPUT</b> button to select and enter characters. To erase 1 character at one time, press the <b>RESET</b> button or press the ◀ and <b>INPUT</b> button at the same time. Also if you move the cursor to DELETE or ALL CLEAR on screen and press the <b>ENTER</b> or <b>INPUT</b> button, 1 character or all characters will be erased. The SSID can be input up to 32 characters.</p> <p>(2) To change an already inserted character, press the ▲/▼ button to move the cursor to one of the first 2 lines, and use the ◀/► buttons to move the cursor on the character to be changed. After pressing the <b>ENTER</b> or <b>INPUT</b> button, the character is selected. Then, follow the same procedure as described at the item (1) above.</p>  <p>(3) To finish entering text, move the cursor to the OK on screen and press the ►, <b>ENTER</b> or <b>INPUT</b> button. To revert to the previous name without saving changes, move the cursor to the CANCEL on screen and press the ◀, <b>ENTER</b> or <b>INPUT</b> button.</p>

(continued on next page)

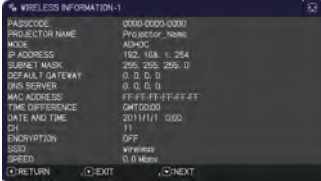
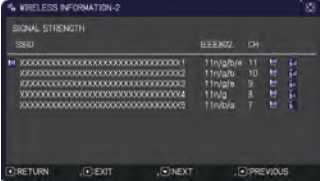
Item	Description
<p><b>WIRELESS INFORMATION</b></p>	<p>Selecting this item displays the WIRELESS INFORMATION dialog for viewing the wireless LAN settings. Use the ▲/▼ buttons to switch the page.</p> <p>The first page shows the wireless LAN settings. The second and subsequent pages display the signal information of wireless LAN connection devices.</p> <div style="display: flex; justify-content: space-around;">   </div> <ul style="list-style-type: none"> <li>• For details of PASSCODE, refer to the manual for “LiveViewer”.</li> <li>• Nothing (blank) is shown in the PROJECTOR NAME (📄81) and SSID (📄77) field until you setup those items. Only the first 16 characters of the PROJECTOR NAME.</li> <li>• IP ADDRESS, SUBNET MASK and DEFAULT GATEWAY indicate “0.0.0.0” in the following condition.             <ol style="list-style-type: none"> <li>(1) The USB wireless adapter is not inserted into the projector.</li> <li>(2) DHCP is ON and the projector does not get address from DHCP server.</li> </ol> </li> <li>• Nothing (blank) is shown in the CH and SPEED fields if the USB wireless adapter is not inserted.</li> <li>• The actual performance and setting will be shown in the CH field, instead of the setting value in the WIRELESS SETUP menu.</li> <li>• An icon is displayed to the left of the SSID of the device connected to the projector.</li> </ul>

(continued on next page)

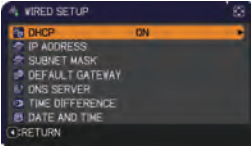

Item	Description	
<b>WIRED SETUP</b>	<p>Selecting this item displays the WIRED SETUP menu for the wired LAN. Use the ▲/▼ buttons to select an item, and the ► or ENTER button on the remote control to perform the item.</p> 	
	<b>DHCP (Dynamic Host Configuration Protocol)</b>	<p>Use the ▲/▼ buttons to turn DHCP on/off. ON ⇄ OFF</p> <p>Select OFF when the network does not have DHCP enabled. To save the setting, press the ► button.</p> <ul style="list-style-type: none"> <li>• When the “DHCP” setting changes to “ON”, it takes a little time to obtain IP address from DHCP server.</li> <li>• Auto IP function will be assigned an IP address if the projector could not obtain an IP address from server even if DHCP is “ON”.</li> </ul>
	<b>IP ADDRESS</b>	<p>Use the ▲/▼/◀/▶ buttons to enter the IP ADDRESS. This function can only be used when DHCP is set to OFF.</p> <ul style="list-style-type: none"> <li>• The IP ADDRESS is the number that identifies this projector on the network. You cannot have two devices with the same IP ADDRESS on the same network.</li> <li>• The IP ADDRESS “0.0.0.0” is prohibited.</li> </ul>
	<b>SUBNET MASK</b>	<p>Use the ▲/▼/◀/▶ buttons to enter the same SUBNET MASK used by your computer. This function can only be used when DHCP is set to OFF.</p> <ul style="list-style-type: none"> <li>• The SUBNET MASK “0.0.0.0” is prohibited.</li> </ul>
	<b>DEFAULT GATEWAY</b>	<p>Use the ▲/▼/◀/▶ buttons to enter the DEFAULT GATEWAY (a node on a computer network that serves as an access point to another network) address. This function can only be used when DHCP is set to OFF.</p>
	<b>DNS SERVER</b>	<p>Use the ▲/▼/◀/▶ buttons to input the DNS server address. The DNS server is a system to control domain names and IP addresses on the Network.</p>

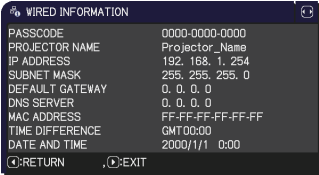
(continued on next page)

Item	Description	
<p><b>WIRED SETUP</b> (continued)</p>	<p><b>TIME DIFFERENCE</b></p>	<p>Use the ▲/▼ buttons to enter the TIME DIFFERENCE. Set the same TIME DIFFERENCE as the one set on your computer. If unsure, consult your IT manager. Use the ► button to return to the menu after setting the TIME DIFFERENCE.</p> <ul style="list-style-type: none"> <li>• When this item is set, the same item in the WIRELESS SETUP menu is overwritten with the same setting (🔗75).</li> </ul>
	<p><b>DATE AND TIME</b></p>	<p>Use the ▲/▼/◀/▶ buttons to enter the Year (last two digits), Month, Date, Hour and Minute.</p> <ul style="list-style-type: none"> <li>• When this item is set, the same item in the WIRELESS SETUP menu is overwritten with the same setting (🔗76).</li> <li>• The projector will override this setting and retrieve DATE AND TIME information from the Time server when SNTP is enabled. (🔗3.1.8 <b>Date/Time Settings</b> in the <b>Network Guide</b>)</li> <li>• This setting will be reset if the projector is turned off while STANDBY MODE in the SETUP menu is set to SAVING (🔗54), or when the AC power is turned off.</li> </ul>
<p><b>WIRED INFORMATION</b></p>	<p>Selecting this item displays the WIRED INFORMATION dialog for viewing the wired LAN settings.</p>  <ul style="list-style-type: none"> <li>• For details of PASSCODE, refer to the manual for “LiveViewer”.</li> <li>• Only the first 16 characters of the PROJECTOR NAME are displayed.</li> <li>• IP ADDRESS, SUBNET MASK and DEFAULT GATEWAY indicate “0.0.0.0” when DHCP is ON and the projector has not gotten address from DHCP server.</li> </ul>	

(continued on next page)



Item	Description
<p><b>PROJECTOR NAME</b></p>	<p>(1) Use the ▲/▼ buttons on the NETWORK menu to select the PROJECTOR NAME and press the ► button. The PROJECTOR NAME dialog will be displayed.</p>  <p>(2) The current PROJECTOR NAME will be displayed on the first 3 lines. Particular projector name is pre-assigned by default. Use the ▲/▼/◀/► buttons and the <b>ENTER</b> or <b>INPUT</b> button to select and enter characters. To erase 1 character at one time, press the <b>RESET</b> button or press the ◀ and <b>INPUT</b> button at the same time. Also if you move the cursor to DELETE or ALL CLEAR on screen and push the <b>ENTER</b> or <b>INPUT</b> button, 1 character or all characters will be erased. The PROJECTOR NAME can be input up to 64 characters.</p> <p>(3) To change an already inserted character, press the ▲/▼ button to move the cursor to one of the first 3 lines, and use the ◀/► buttons to move the cursor on the character to be changed. After pressing the <b>ENTER</b> or <b>INPUT</b> button, the character is selected. Then, follow the same procedure as described at the item (2) above.</p>  <p>(4) To finish entering text, move the cursor to the OK on screen and press the ►, <b>ENTER</b> or <b>INPUT</b> button. To revert to the previous PROJECTOR NAME without saving changes, move the cursor to the CANCEL on screen and press the ◀, <b>ENTER</b> or <b>INPUT</b> button.</p>

(continued on next page)

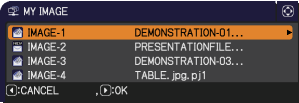
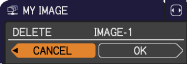

Item	Description
<p><b>MY IMAGE</b></p>	<p>Selecting this item displays the MY IMAGE menu.                      Use the application to transfer the image data. It can be downloaded from the Hitachi web site.                      (<a href="http://www.hitachi-america.us/digitalmedia">http://www.hitachi-america.us/digitalmedia</a> or <a href="http://www.hitachidigitalmedia.com">http://www.hitachidigitalmedia.com</a>).</p> <p>Use the ▲/▼ buttons to select an item which is a still image by the MY IMAGE (4. My Image Function in the Network Guide) and the ► or ENTER button to display the image.</p> <ul style="list-style-type: none"> <li>• The item without image stored cannot be selected.</li> <li>• The image names are each displayed in 16 characters or less.</li> </ul> <p><b>To switch the image displayed</b>                      Use the ▲/▼ buttons.</p> <p><b>To return to the menu</b>                      Press the ◀ button on the remote control.</p> <p><b>To erase the image displayed and its source file in the projector.</b>                      (1) Press the <b>RESET</b> button on the remote control while displaying an image to display the MY IMAGE DELETE menu.</p>  <p>(2) Press the ► button to perform to erase.                      To stop erasing, press the ◀ button.</p> 
<p><b>AMX D.D. (AMX Device Discovery)</b></p>	<p>Use the ▲/▼ buttons to turn the AMX Device Discovery on/off.                      ON ⇔ OFF</p> <p>When ON is selected, the projector can be detected by controllers of AMX connected to the same network. For the details of AMX Device Discovery, visit the AMX web site.                      URL: <a href="http://www.amx.com/">http://www.amx.com/</a> (as of Dec. 2011)</p>

(continued on next page)

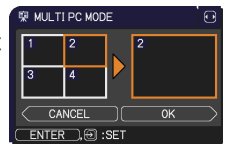
Item	Description
PRESENTATION	<p>Selecting this item displays the PRESENTATION menu. Use ▲/▼ buttons to select one of the following items, then press ► or <b>ENTER</b> button to use the function.</p> <ul style="list-style-type: none"> <li>To use Network Presentation, an exclusive application, “LiveViewer” is required. It can be installed from the bundled application CD. You can also download the latest version and relevant information from the Hitachi website (<a href="http://www.hitachi-america.us/digitalmedia">http://www.hitachi-america.us/digitalmedia</a> or <a href="http://www.hitachidigitalmedia.com">http://www.hitachidigitalmedia.com</a>). For details of Network Presentation and instructions to install the “LiveViewer”, refer to the manual for “LiveViewer”.</li> </ul>
	<p><b>QUIT PRESENTER MODE</b></p> <p>If you set a computer to the Presenter mode while its image is projected, the projector is occupied by the computer and access from any other computer is blocked.</p> <p>Use this function to quit the Presenter mode and allow other computers to access the projector. Select this item to display a dialog. Press ► button to choose OK in the dialog. The Presenter mode is cancelled and a message is displayed indicating the result.</p> <ul style="list-style-type: none"> <li>To make Presenter mode setting, use “LiveViewer”. For details, refer to the manual for “LiveViewer”.</li> </ul>
	<p><b>MULTI PC MODE</b></p> <p>If you set one or more computers to the Multi PC mode on “LiveViewer” and send their images to the projector, you can select the display mode on the projector from two options below.</p> <ul style="list-style-type: none"> <li>- Single PC mode: displays the image of the selected computer on full screen.</li> <li>- Multi PC mode: displays the images sent from up to four computers on screen that is divided into quarter sections.</li> </ul> <p>Select this item to display a dialog. Use the dialog to change the display mode as explained below.</p> <ul style="list-style-type: none"> <li>To change from Multi PC mode to Single PC mode, select one of computers in the dialog using the ▲/▼/◀/▶ buttons and press the <b>ENTER</b> or <b>INPUT</b> button.</li> </ul> <p>Press the ► button to choose OK, and then press <b>ENTER</b> or <b>INPUT</b> again. The image for the selected computer is displayed on full screen.</p> <p>(continued on next page)</p>

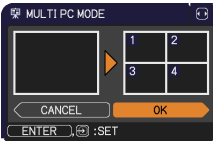

(continued on next page)

Item	Description	
<p><b>PRESENTATION</b> (continued)</p>	<p><b>MULTI PC MODE</b> (continued)</p>	<ul style="list-style-type: none"> <li>• To change from Single PC mode to Multi PC mode, press ► button to choose OK in the dialog and press the <b>ENTER</b> or <b>INPUT</b> button. The display mode is changed.</li> <li>• For details on how to switch the display mode to Multi PC mode on your computer, refer to the manual for “LiveVier”.</li> <li>• The Presenter mode setting of the selected computer becomes valid when the display mode is changed to Single PC mode. Also, the Presenter mode setting becomes invalid when the display mode is changed to Multi PC mode, regardless the setting on the computers. For details, refer to the manual for “LiveViewer”.</li> </ul> 
	<p><b>DISPLAY USER NAME</b></p>	<p>Selecting this item displays the user name. This function helps you identify from which computer the current image is sent.</p> <ul style="list-style-type: none"> <li>• You can set a user name for each computer on “LiveVier”. For details, refer to the manual for “LiveViewer”.</li> </ul>
<p><b>SERVICE</b></p>	<p>Executing this item restarts and initializes the network functions. Choose the NETWORK RESTART EXECUTE using the button ►.</p>  <p>Then use the button ► to execute.</p>  <p>Network will be once cut off when choose restart. If DHCP is selected on, IP address may be changed. After selecting NETWORK RESTART EXECUTE, NETWORK menu may not be controlled approx. 30 seconds.</p>	

## SECURITY menu

This projector is equipped with security functions. From the SECURITY menu, items shown in the table below can be performed.

To use SECURITY menu: User registration is required before using the security functions.

### Enter to the SECURITY menu

1. Press the ► button. The ENTER PASSWORD box will be displayed.
2. Use the ▲/▼/◀/▶ buttons to enter the registered password. The factory default password is as follows.

**8970, 8971:** 3605      **8972W, 8973W:** 2005  
**8976SX:** 2105      **8974WU, 8975WU:** 3705

This password can be changed (see below). Move the cursor to the right side of the ENTER PASSWORD box and press the ► button to display the SECURITY menu.

- It is strongly recommended the factory default password to be changed as soon as possible.
- If an incorrect password is input, the ENTER PASSWORD box will be displayed again. If incorrect password is input 3 times, the projector will turn off. Afterwards the projector will turn off every time an incorrect password is input.

3. Items shown in the table below can be performed.

### If you have forgotten your password

- (1) While the ENTER PASSWORD box is displayed, press and hold the **RESET** button on the remote control for about 3 seconds or press and hold the **INPUT** button for 3 seconds while pressing the ► button on the projector.
- (2) The 10 digit Inquiring Code will be displayed. Contact your dealer with the 10 digit Inquiring Code. Your password will be sent after your user registration information is confirmed.



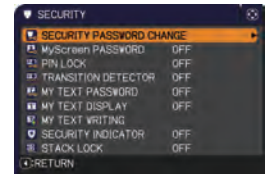

- If there is no key input for about 55 seconds while the Inquiring Code is displayed, the menu will close. If necessary, repeat the process from (1).



Item	Description
<p><b>SECURITY PASSWORD CHANGE</b></p>	<ol style="list-style-type: none"> <li>(1) Use the ▲/▼ buttons on the SECURITY menu to select SECURITY PASSWORD CHANGE and press the ► button to display the ENTER NEW PASSWORD box.</li> <li>(2) Use the ▲/▼/◀/▶ buttons to enter the new password.</li> <li>(3) Move the cursor to the right side of the ENTER NEW PASSWORD box and press the ► button to display the NEW PASSWORD AGAIN box, enter the same password again.</li> <li>(4) Move the cursor to the right side of the NEW PASSWORD AGAIN box and press the ► button and the NOTE NEW PASSWORD box will be displayed for about 30 seconds, please make note of the password during this time. Pressing the <b>ENTER</b> button on the remote control or ► button on the projector will close the NOTE NEW PASSWORD box.</li> </ol> <ul style="list-style-type: none"> <li>• Please do not forget your password.</li> </ul>



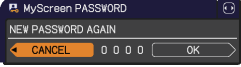
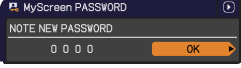

(continued on next page)

Item	Description
<p><b>MyScreen PASSWORD</b></p>	<p>The MyScreen PASSWORD function can be used to prohibit access to the MyScreen function and prevent the currently registered MyScreen image from being overwritten.</p> <p><b>1 Turning on the MyScreen PASSWORD</b></p> <p>1-1 Use the ▲/▼ buttons on the SECURITY menu to select MyScreen PASSWORD and press the ► button to display the MyScreen PASSWORD on/off menu.</p>  <p>1-2 Use the ▲/▼ buttons on the MyScreen PASSWORD on/off menu to select ON. The ENTER NEW PASSWORD box (small) will be displayed.</p>  <p>1-3 Use the ▲/▼/◀/▶ buttons to enter the password. Move the cursor to the right side of the ENTER NEW PASSWORD box (small) and press the ► button to display the NEW PASSWORD AGAIN box, enter the same PASSWORD again.</p>  <p>1-4 Move the cursor to the right side of the NEW PASSWORD AGAIN box and press the ► button to display the NOTE NEW PASSWORD box for about 30 seconds, please make note of the password during this time.</p>  <p>Pressing the <b>ENTER</b> button on the remote control or ► button on the projector will return to MyScreen PASSWORD on/off menu.</p> <p>When a password is set for MyScreen:</p> <ul style="list-style-type: none"> <li>• The MyScreen registration function (and menu) will be unavailable.</li> <li>• The MyScreen Lock menu will be unavailable.</li> <li>• The START UP setting will be locked on MyScreen (and the menu will be unavailable).</li> </ul> <p>Turning the MyScreen PASSWORD off will allow normal operation of these functions.</p> <ul style="list-style-type: none"> <li>• Please do not forget your MyScreen PASSWORD.</li> </ul> <p><b>2 Turning off the MyScreen PASSWORD</b></p> <p>2-1 Follow the procedure in 1-1 to display the MyScreen PASSWORD on/off menu.</p> <p>2-2 Select OFF to display the ENTER PASSWORD box (large). Enter the registered password and the screen will return to the MyScreen PASSWORD on/off menu.</p>  <p>If an incorrect PASSWORD is input, the menu will close. If necessary, repeat the process from 2-1.</p> <p><b>3 If you have forgotten your password</b></p> <p>3-1 Follow the procedure in 1-1 to display the MyScreen PASSWORD on/off menu.</p> <p>3-2 Select OFF to display the ENTER PASSWORD box (large). The 10 digit Inquiring Code will be displayed inside the box.</p> <p>3-3 Contact your dealer with the 10 digit Inquiring Code. Your password will be sent after your user registration information is confirmed.</p>

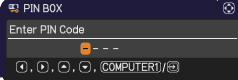
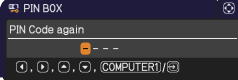
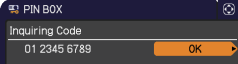

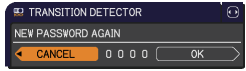
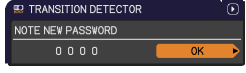
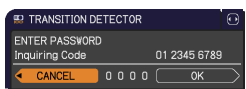

(continued on next page)

Item	Description
PIN LOCK	<p>PIN LOCK is a function which prevents the projector from being used unless a registered Code is input.</p> <p><b>1 Turning on the PIN LOCK</b></p> <p>1-1 Use the ▲/▼ buttons on the SECURITY menu to select PIN LOCK and press the ► button or the ENTER button to display the PIN LOCK on/off menu.</p>  <p>1-2 Use the ▲/▼ buttons on the PIN LOCK on/off menu to select ON and the Enter PIN Code box will be displayed.</p>  <p>1-3 Input a 4 part PIN code using the ▲/▼/◀/▶, COMPUTER 1 or INPUT button. The PIN Code again box will appear. Reenter the same PIN code. This will complete the PIN code registration.</p>  <ul style="list-style-type: none"> <li>• If there is no key input for about 55 seconds while the Enter PIN Code box or the PIN Code again box is displayed, the menu will close. If necessary, repeat the process from 1-1.</li> </ul> <p>Afterwards, anytime the projector is restarted after AC power is turned off the Enter PIN Code box will be displayed. Enter the registered PIN code. The projector can be used after entering the registered PIN code. If an incorrect PIN code is input, the Enter PIN code box will be displayed again. If an incorrect PIN code is input 3 times, the projector will turn off. Afterwards the projector will turn off every time an incorrect PIN code is input. The projector will also turn off if there is no key input for about 5 minutes while the Enter PIN code box is displayed. This function will activate only when the projector is started after AC power is turned off.</p> <ul style="list-style-type: none"> <li>• Please do not forget your PIN code.</li> </ul> <p><b>2 Turning off the PIN LOCK</b></p> <p>2-1 Follow the procedure in 1-1 to display the PIN LOCK on/off menu.</p> <p>2-2 Use the ▲/▼ buttons to select OFF and the Enter PIN Code box will be displayed. Enter the registered PIN code to turn the PIN LOCK function off. If an incorrect PIN code is input 3 times, the projector will turn off.</p> <p><b>3 If you have forgotten your PIN code</b></p> <p>3-1 While the Enter PIN code box is displayed, press and hold the RESET button for three seconds or press and hold the INPUT button for 3 seconds while pressing the ► button on the projector. The 10 digit Inquiring Code will be displayed.</p> <ul style="list-style-type: none"> <li>• If there is no key input for about 5 minutes while the Inquiring Code is displayed, the projector will turn off.</li> </ul>  <p>3-2 Contact your dealer with the 10 digit Inquiring Code. Your PIN code will be sent after your user registration information is confirmed.</p>

(continued on next page)

Item	Description
<p><b>TRANSITION DETECTOR</b></p>	<p>If this function is set to ON and the vertical angle of the projector or the INSTALLATION setting is different from the previous recorded setting, the TRANSITION DETECTOR ON alarm will be displayed and the input signal will not be displayed.</p> <ul style="list-style-type: none"> <li>• To display the signal again, set this function OFF.</li> <li>• After about 5 minutes of displaying the TRANSITION DETECTOR ON alarm, the lamp will turn off.</li> <li>• Keystone adjustment feature has been prohibited as long as the Transition Detector function is on.</li> </ul> <p><b>1 Turning on the TRANSITION DETECTOR</b></p> <p>1-1 Use the ▲/▼ buttons on the SECURITY menu to select TRANSITION DETECTOR and press the ► or the ENTER button to display the TRANSITION DETECTOR on/off menu.</p> <p>1-2 Use the ▲/▼ buttons on the TRANSITION DETECTOR on/off menu to select ON. Selecting ON will save the setting of the current angle and the INSTALLATION setting. The ENTER NEW PASSWORD box (small) will be displayed.</p> <p>1-3 Use the ▲/▼/◀/▶ buttons to enter a password. Move the cursor to the right side of the ENTER NEW PASSWORD box (small) and press the ► button to display the NEW PASSWORD AGAIN box, enter the same password again.</p> <p>1-4 Move the cursor to the right side of the NEW PASSWORD AGAIN box and press the ► button to display the NOTE NEW PASSWORD box for about 30 seconds, please make note of the password during this time. Pressing the ENTER button on the remote control or the ► button on the projector will return to the TRANSITION DETECTOR on/off menu.</p> <ul style="list-style-type: none"> <li>• Please do not forget your TRANSITION DETECTOR password.</li> <li>• This function will activate only when the projector is started after turning off the AC power.</li> <li>• This feature may not function properly if the projector is not in a stable position when ON is selected.</li> </ul> <p><b>2 Turning off the TRANSITION DETECTOR</b></p> <p>2-1 Follow the procedure in 1-1 to display the TRANSITION DETECTOR on/off menu.</p> <p>2-2 Select OFF to display the ENTER PASSWORD box (large). Enter the registered password and the screen will return to the TRANSITION DETECTOR on/off menu.</p> <p>If an incorrect password is input, the menu will close. If necessary, repeat the process from 2-1.</p> <p><b>3 If you have forgotten your password</b></p> <p>3-1 Follow the procedure in 1-1 to display the TRANSITION DETECTOR on/off menu.</p> <p>3-2 Select OFF to display the ENTER PASSWORD box (large). The 10 digit Inquiring Code will be displayed inside the box.</p> <p>3-3 Contact your dealer with the 10 digit Inquiring Code. Your password will be sent after your user registration information is confirmed.</p>
	     

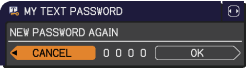
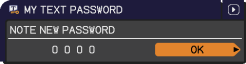

Item	Description
<b>MY TEXT PASSWORD</b>	<p>The MY TEXT PASSWORD function can prevent the MY TEXT from being overwritten. When the password is set for the MY TEXT;</p> <ul style="list-style-type: none"> <li>• The MY TEXT DISPLAY menu will be unavailable, which can prohibit changing the DISPLAY setting.</li> <li>• The MY TEXT WRITING menu will be unavailable, which can prevent the MY TEXT from being overwritten.</li> </ul> <p><b>1 Turning on the MY TEXT PASSWORD</b></p> <p>1-1 Use the ▲/▼ buttons on the SECURITY menu to select the MY TEXT PASSWORD and press the ► button to display the MY TEXT PASSWORD on/off menu.</p>  <p>1-2 Use the ▲/▼ buttons on the MY TEXT PASSWORD on/off menu to select ON. The ENTER NEW PASSWORD box (small) will be displayed.</p>  <p>ENTER NEW PASSWORD box (small)</p> <p>1-3 Use the ▲/▼/◀/▶ buttons to enter the password. Move the cursor to the right side of the ENTER NEW PASSWORD box (small) and press the ► button to display the NEW PASSWORD AGAIN box, and then enter the same password again.</p>  <p>1-4 Move the cursor to the right side of the NEW PASSWORD AGAIN box and press ► button to display the NOTE NEW PASSWORD box for about 30 seconds, then please make note of the password during this time.</p>  <p>Pressing the <b>ENTER</b> button on the remote control or ► button on the projector will return to the MY TEXT PASSWORD on/off menu.</p> <p><b>2 Turning off the MY TEXT PASSWORD</b></p> <p>2-1 Follow the procedure in 1-1 to display the MY TEXT PASSWORD on/off menu.</p> <p>2-2 Select OFF to display the ENTER PASSWORD box (large). Enter the registered password and the screen will return to the MY TEXT PASSWORD on/off menu.</p>  <p>ENTER PASSWORD box (large)</p> <p>If an incorrect password is input, the menu will close. If necessary, repeat the process from 2-1</p> <p><b>3 If you have forgotten your password</b></p> <p>3-1 Follow the procedure in 1-1 to display the MY TEXT PASSWORD on/off menu.</p> <p>3-2 Select OFF to display the ENTER PASSWORD box (large). The 10 digit inquiring code will be displayed inside the box.</p> <p>3-3 Contact your dealer with the 10 digit inquiring code. Your password will be sent after your user registration information is confirmed.</p>

(continued on next page)

Item	Description
<p><b>MY TEXT DISPLAY</b></p>	<p>(1) Use the ▲/▼ buttons on the SECURITY menu to select the MY TEXT DISPLAY and press the ► or <b>ENTER</b> button to display the MY TEXT DISPLAY on/off menu.</p> <p>(2) Use the ▲/▼ buttons on the MY TEXT DISPLAY on/off menu to select on or off.</p> <p>ON ⇔ OFF</p> <p>When it is set ON, the MY TEXT will be displayed on the START UP screen and the INPUT_INFORMATION when the INFORMATION on the SERVICE menu is chosen.</p> <ul style="list-style-type: none"> <li>• This function is available only when the MY TEXT PASSWORD function is set to the OFF.</li> </ul>
<p><b>MY TEXT WRITING</b></p>	<p>(1) Use the ▲/▼ buttons on the SECURITY menu to select the MY TEXT WRITING and press the ► button. The MY TEXT WRITING dialog will be displayed.</p> <p>(2) The current MY TEXT will be displayed on the first 3 lines. If not yet written, the lines will be blank.</p> <p>Use the ▲/▼/◀/▶ buttons and the <b>ENTER</b> or <b>INPUT</b> button to select and enter characters. To erase 1 character at one time, press the <b>RESET</b> button or press the ◀ and <b>INPUT</b> button at the same time. Also if you move the cursor to DELETE or ALL CLEAR on screen and press the <b>ENTER</b> or <b>INPUT</b> button, 1 character or all characters will be erased. The MY TEXT can be input up to 24 characters on each line.</p> <p>(3) To change an already inserted character, press the ▲/▼ button to move the cursor to one of the first 3 lines, and use the ◀/▶ buttons to move the cursor on the character to be changed.</p> <p>After pressing the <b>ENTER</b> or <b>INPUT</b> button, the character is selected. Then, follow the same procedure as described at the item (2) above.</p> <p>(4) To finish entering text, move the cursor to the OK on screen and press the ►, <b>ENTER</b> or <b>INPUT</b> button. To revert to the previous MY TEXT without saving changes, move the cursor to the CANCEL on screen and press the ◀, <b>ENTER</b> or <b>INPUT</b> button.</p> <ul style="list-style-type: none"> <li>• The MY TEXT WRITING function is available only when the MY TEXT PASSWORD function is set to OFF.</li> </ul>

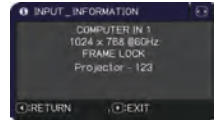

(continued on next page)

Item	Description
<b>SECURITY INDICATOR</b>	Selecting this item displays the SECURITY INDICATOR dialog. Use the ▲/▼ buttons to select ON or OFF. ON ⇄ OFF When ON is selected while PIN LOCK or TRANSITION DETECTOR is ON, the <b>SECURITY</b> indicator blinks in yellow in the standby mode (📖 87, 88).
<b>STACK LOCK</b>	Selecting this item displays the STACK LOCK dialog. For more information, please see <b>Instant Stack Guide</b> .

### Presentation tools

The projector has the following convenient tools that enable on-screen presentations easily and quickly:

- PC-LESS Presentation ([📖 below](#))
- Drawing function ([📖 102](#))
- USB Display ([📖 107](#))
- Network Presentation

For details of Network Presentation, refer to the **Network Guide** and the manual for "LiveViewer".

### PC-LESS Presentation

The PC-LESS Presentation reads image and audio data from the storage media inserted into the **USB TYPE A** ports and displays the image in the following modes.

The PC-LESS Presentation can be started by selecting the **USB TYPE A** as the input source.

This feature allows you to make your presentations without using your computer.

- Thumbnail mode ([📖 93](#))
- Full Screen mode ([📖 97](#))
- Slideshow mode ([📖 99](#))

### [Supported storage media]

- USB memory (USB memory type, USB hard disk and USB card reader type)

**NOTE** • Some USB memory devices and/or USB hubs may not operate properly.  
• USB devices with security software may not work.  
• Be careful when inserting or removing a USB device. ([📖 12, 95](#))

### [Supported format]

- FAT12, FAT16 and FAT32

**NOTE** • NTFS is not supported.

### [Supported file format and its extension]

- JPEG (.jpeg, .jpg) \* Progressive is not supported.
- Bitmap (.bmp) \* 16bit mode and compressed bitmap is not supported.
- PNG (.png) \* Interlace PNG is not supported.
- GIF (.gif)
- Movie (.avi, .mov) \* Supported video format: Motion-JPEG  
Supported audio format: WAV (Linear PCM, Stereo 16bit), IMA-ADPCM

(continued on next page)

**PC-LESS Presentation (continued)**

**NOTE** • Files with a resolution larger than the following are not supported.

**8970, 8971:** 1024 x 768 (Still), 768 x 576 (Movie)

**8972W 8973W:** 1280 x 800 (Still), 768 x 576 (Movie)

**8976SX:** 1400 x 1050 (Still), 768 x 576 (Movie)

**8974WU, 8975WU:** 1920 x 1200 (Still), 768 x 576 (Movie)

(\* Some computers may not support above resolutions.)

- Files with a resolution smaller than 36 x 36 are not supported.
- Files with a resolution smaller than 100 x 100 may not be displayed.
- Movie images with a frame rate higher than 15 fps cannot be displayed.
- Movie images with a bit rate higher than 20 Mbps cannot be displayed.
- Some supported files may not be displayed.
- Only a frame appears when the content of image data cannot be displayed in the Thumbnail mode.
- Even with the file format and audio format combinations described above, playback of some files may fail.

**Thumbnail Mode**

The Thumbnail mode displays the images stored in USB storage devices on the Thumbnail screen. Maximum 20 images are displayed in a screen.

If you wish, you can jump into the Full Screen mode or Slideshow mode, after you select some images in the Thumbnail mode.

The Thumbnail mode will be started as the primary function of the PC-LESS Presentation after selecting the **USB TYPE A** as the input source.



**PC-LESS Presentation (continued)**

**Operating by buttons**

You can control the images on the Thumbnail screen with the remote control, control panel or Web Remote Control. The following functions can be supported while the Thumbnail screen is displayed.





Button operation			Functions
Remote control	Control panel	Web Remote Control	
▲/▼/◀/▶	▲/▼/◀/▶	[▲]/[▼]/[◀]/[▶]	Moves cursor.
PAGE UP PAGE DOWN	-	[PAGE UP] [PAGE DOWN]	Switches pages.
ENTER	INPUT	[ENTER]	<ul style="list-style-type: none"> <li>• Displays the selected image on the Full Screen mode when a cursor is on a Thumbnail image.</li> <li>• Displays the SETUP menu (<a href="#">📖 below</a>) for the selected image when a cursor is on a Thumbnail image number.</li> </ul>

**The SETUP menu for the selected image**

Item	Functions
SETUP	Use the ◀/▶ cursor buttons to switch each setting or use the ▶ cursor button to execute the functions as follows.
RETURN	Press the ▶ cursor button or <b>ENTER</b> to return to the Thumbnail screen.
START	Switch to ON to set the selected image as the first image in the Slideshow. This setting information will be saved in the "playlist.txt" file ( <a href="#">📖 101</a> ).
STOP	Switch to ON to set the selected image as the last image in the Slideshow. This setting information will be saved in the "playlist.txt" file ( <a href="#">📖 101</a> ).
SKIP	Switch to ON to skip the selected image in the Slideshow. This setting information will be saved in the "playlist.txt" file ( <a href="#">📖 101</a> ).
ROTATE	Press the ▶ cursor or <b>ENTER</b> button to rotate the selected still image 90 degrees clockwise. This setting information will be saved in the "playlist.txt" file ( <a href="#">📖 101</a> ).

**PC-LESS Presentation (continued)****Operating by the Thumbnail menu**

You can also control the images by using the menu on the Thumbnail screen.

Item	Functions
	Moves to an upper folder.
<b>SORT</b>	Allows you to sort files and folders as following.
<b>RETURN</b>	Press the ► cursor button or <b>ENTER</b> to return to the Thumbnail screen.
<b>NAME UP</b>	Sorts in ascending order by file name.
<b>NAME DOWN</b>	Sorts in descending order by file name.
<b>DATE UP</b>	Sorts in ascending order by file date.
<b>DATE DOWN</b>	Sorts in descending order by file date.
<b>▲ / ▼</b>	Go to previous / next page.
<b>SLIDESHOW</b>	Configures and starts the Slideshow (  99).
<b>RETURN</b>	Press the ► cursor button or <b>ENTER</b> to return to the Thumbnail screen.
<b>PLAY</b>	Press the ► cursor button or <b>ENTER</b> to start the Slideshow.
<b>START</b>	Sets the beginning number of the Slideshow.
<b>STOP</b>	Sets the end number of the Slideshow.
<b>INTERVAL</b>	Sets the interval time for displaying still images during the Slideshow. It is not recommend to set the interval time very short something like several seconds, because it may take more than several seconds to read and display an image file if it is stored in very deep layer directory or if so many files are stored in the same directory.
<b>PLAY MODE</b>	Selects the mode of Slideshow. <u>ONE TIME</u> : Play the Slideshow one time. <u>ENDLESS</u> : Play the Slideshow endless.
<b>INPUT</b>	Switches the input port.
<b>MENU</b>	Displays the menu.
<b>REMOVE USB</b>	Be sure to use this function before removing USB storage device from the projector. After that, the projector will not recognize USB storage devices until you insert it again into the <b>USB TYPE A</b> ports.
 / 	Turns the sound on/off for files that contain audio data.

(continued on next page)

**PC-LESS Presentation (continued)**

- NOTE** • These operations are not accessible while the projector OSD is displayed.
- The Thumbnail mode is able to display up to 20 files in one page.
  - It is not possible to change the input port by using the **INPUT** button when the Thumbnail screen, Slideshow, or Full Screen image is displayed.
  - The image quality may deteriorate when playing back audio data included in a movie. If you want to give priority to the image quality, turn off the sound by setting  $\text{♪}$  to off.
  - If one of the **AUDIO IN** ports is selected or  $\text{X}$  is selected for USB TYPE A in AUDIO SOURCE of the AUDIO menu (  $\text{📖55}$  ),  $\text{♪}$  cannot be operated.
  - Some error icons will be displayed on the Thumbnail screen.



————— This file seems to be broken or not supported format.

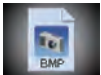

} A file that cannot be displayed on the Thumbnail screen is indicated by a file format icon.





**PC-LESS Presentation (continued)****Full Screen Mode**

The Full Screen mode shows a full display image. To display in Full Screen mode, select an image in the Thumbnail screen. Then press the **ENTER** button on the remote control, the **INPUT** button on the control panel or click **[ENTER]** on the Web Remote Control.



} Full screen display

**Operations for still images**

The following operations are enabled in the Full Screen mode while a still image is displayed.

Button operation			Functions
Remote control	Control panel	Web Remote Control	
▼ ▶ or <b>PAGE DOWN</b>	▼ or ▶	[▼] [▶] or <b>[PAGE DOWN]</b>	Shows the next file.
▲ ◀ or <b>PAGE UP</b>	▲ or ◀	[▲] [◀] or <b>[PAGE UP]</b>	Shows the previous file.
<b>ENTER</b>	<b>INPUT</b>	<b>[ENTER]</b>	Displays Thumbnail.

**PC-LESS Presentation (continued)**

**Operations for movie**

A remote control icon and a progress bar are displayed when one of the cursor buttons, **ENTER** button or **INPUT** button on the remote control, control panel or Web Remote Control is pressed or clicked while a movie is playing in the Full Screen mode. The following operations are enabled while the remote control icon and progress bar are displayed.



Button operation			Functions
Remote control	Control panel	Web Remote Control	
▲	▲	[▲]	(Play) /  (Pause) toggle
▶	▶	[▶]	(FF) Fast-forward
◀	◀	[◀]	(REW) Fast-rewind
<b>ENTER</b>	<b>INPUT</b>	[ENTER]	(Stop), Displays Thumbnail.
<b>PAGE DOWN</b>	–	[PAGE DOWN]	Shows the next file.
<b>PAGE UP</b>	–	[PAGE UP]	Shows the previous file.

**NOTE** • These operations are not accessible while the projector OSD is displayed.  
 • It is not possible to change the input port by using the **INPUT** button when the Thumbnail screen, Slideshow, or Full Screen image is displayed.

## PC-LESS Presentation (continued)

### Slideshow Mode

The Slideshow mode displays images in full screen and switches the images at intervals set in INTERVAL on the Thumbnail menu (📖95).

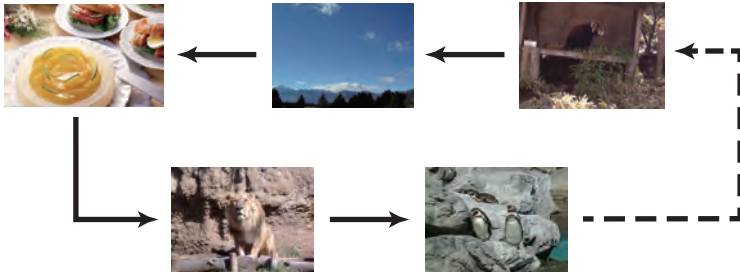

You can start this function from the Slideshow menu. To display the Slideshow menu, select the SLIDESHOW button in the Thumbnail menu and press the **ENTER** button on the remote control, **INPUT** button on the control panel, or click **[ENTER]** on the Web Remote Control.

### Operating by buttons

While the Slideshow is displayed, the following button operations are enabled when still images are displayed, and the same button operations in the Full Screen mode are enabled when movies are displayed.

Button operation			Functions
Remote control	Control panel	Web Remote Control	
<b>ENTER</b>	<b>INPUT</b>	<b>[ENTER]</b>	Displays Thumbnail.

**NOTE** • These operations are not accessible while the projector OSD is displayed.

- It is not possible to change the input port by using the **INPUT** button when the Thumbnail screen, Slideshow, or Full Screen image is displayed.
- When the Slideshow mode is set to ONE TIME and the last file is a still image, the last slide of the presentation will remain displayed until the **ENTER** button on the remote control or Web Remote Control, or the **INPUT** button on the control panel is pressed.

**PC-LESS Presentation (continued)**

**Operating by SLIDESHOW in the Thumbnail menu**

You can play the Slideshow at your desired configuration. Configure the SLIDESHOW item in the Thumbnail menu (95).

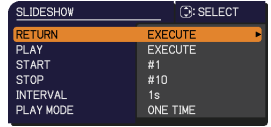

Item	Functions
SLIDESHOW	
RETURN	Returns to the Thumbnail mode.
PLAY	Play the Slideshow.
START	Set the beginning number of the Slideshow.
STOP	Set the end number of the Slideshow.
INTERVAL	Sets the interval time for displaying still images during the Slideshow. It is not recommend to set the interval time very short something like several seconds, because it may take more than several seconds to read and display an image file if it is stored in very deep layer directory or if so many files are stored in the same directory.
PLAY MODE	Selects the mode of Slideshow. <u>ONE TIME</u> : Play the Slideshow one time. <u>ENDLESS</u> : Play the Slideshow endless.

**NOTE** • The settings of the Slideshow are saved to the “**playlist.txt**” file that is stored in the storage media. If the file is not existed, it is generated automatically.

- The settings for the START, STOP, INTERVAL, and PLAY MODE are saved to the Playlist.
- If the storage media is under the write protection or the “**playlist.txt**” is the read only type file, it is impossible to change the settings of the Slideshow.

**PC-LESS Presentation (continued)****Playlist**

The Playlist is a DOS format text file, which decides the order of displayed still image files in the Thumbnail mode or Slideshow.

The playlist file name is "playlist.txt" and it can be edited on a computer.

It is created in the folder that contains the selected image files when the PC-LESS Presentation is started or the Slideshow is configured.

**[Example of "playlist.txt" files]**

START setting : STOP setting : INTERVAL setting : PLAY MODE setting :

img001.jpg: : :

img002.jpg:600: : :

img003.jpg:700:rot1: :

img004.jpg: : :SKIP:

img005.jpg:1000:rot2:SKIP:

The "playlist.txt" file contains the following information.

Each piece of information requires to be separated by ":", and "." at the end of each line.

**1st line:** START, STOP, INTERVAL and PLAY MODE settings ([📖95](#)).

**2nd line and after:** file name, interval time, rotation setting and skip setting.

interval time: It can be set from 0 to 999900 (ms) with an increment of 100 (ms).

rotation setting: "rot1" means a rotation at 90 degrees clockwise; "rot2" and "rot3" increase another 90 degrees in order.

skip setting: "SKIP" means that the image will not be displayed in the Slideshow.

**NOTE** • The maximum length in a line on the "playlist.txt" file is 255 characters including linefeed. If any line exceeds the limit, the "playlist.txt" file becomes invalid.

- Up to 999 files can be registered to the Playlist. However, if some folders exist in the same directory the limit number is decreased by the number of folders.

Any files over the limit will not be shown in the Slideshow.

- If the storage device is protected or does not have sufficient space, the "playlist.txt" file cannot be created.

- For the Slideshow settings, refer to the section **Slideshow mode** ([📖99](#)).

## Drawing function

Drawing function enables you to draw on the projector's screen with **Ö\æ^ Pen tablet** or **USB mouse** connected to the **USB TYPE A** ports. This function is an interactive tool, that offers effective features for making classroom and business presentations more fun and easier to understand.

✓ **Drawing on projected images**

You can draw pictures or text on projected images.

✓ **Saving and displaying drawn images**

You can save images with pictures or text drawn on them to a USB memory device and then retrieve the saved images and display them again later.

✓ **Use as a simple mouse**

The **Ö\æ^ Pen tablet** and **USB mouse** can be used in place of the mouse of a computer connected to the projector.

**NOTE** • Authorization by the copyright owner(s) is required pursuant to including visual images, if such works are copyrighted works.

- This drawing function may not work depending on the image signal.
- A USB storage device is necessary to save data. In addition, if the projector only has one available **USB TYPE A** port, a USB hub is needed.
- Copyright protected images cannot be saved.
- To use simple mouse function, a USB cable is required to connect the computer and the projector.
- Some pen tablets and USB mice may not operate properly.

## Drawing function (continued)

### Connecting the Devices

Connect the  $\text{Ö} \setminus \text{æ} \wedge$  Pen tablet or USB mouse to the **USB TYPE A** port on the projector.

To save an image that has been drawn, a USB storage device must also be connected to a **USB TYPE A** port of the projector.

If the projector only has one available **USB TYPE A** port, use a USB hub to connect both devices.

In order to use the simple mouse function, connect the **USB TYPE B** port of the projector with a USB (A) port of the computer with a USB cable.

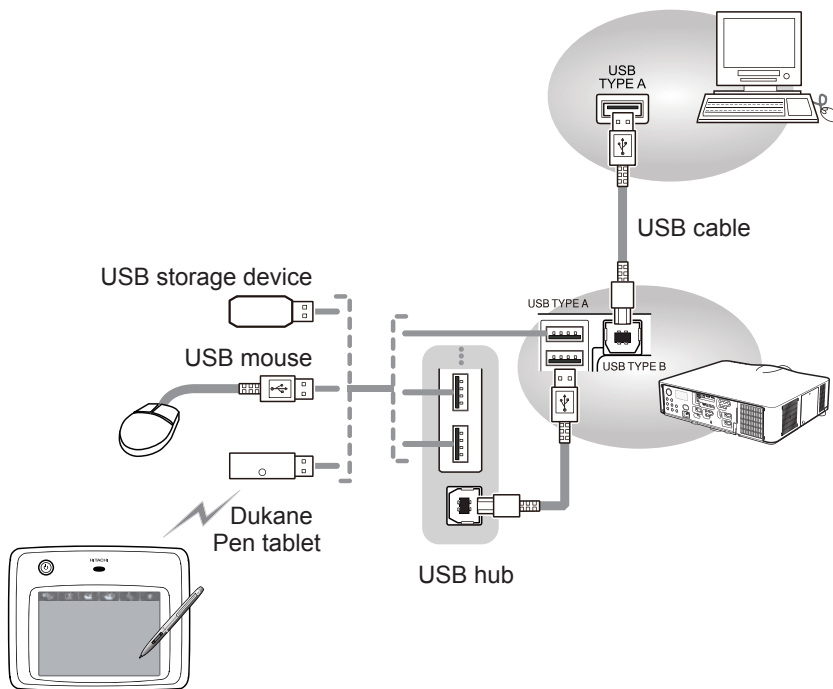

### Example of connections

**NOTE** • Some USB storage devices and/or USB hubs may not operate properly.  
 • Before removing the USB storage device from the port of the projector, be sure to use the REMOVE USB function on the Thumbnail screen to secure your data (95). If you do not run the REMOVE USB function and remove the USB storage device, the time stamp may not be recorded correctly.

**Drawing function (continued)**

**Using the Drawing function**

Touching or clicking the connected  $\ddot{O} \backslash \text{æ} \wedge$  Pen tablet / USB mouse starts up drawing mode. A tool bar like the figure below is displayed on the projector screen while in the drawing mode. Touching/clicking an icon on the tool bar enables the following functions. Touching anywhere on the tool bar except an icon and dragging moves the toolbar.

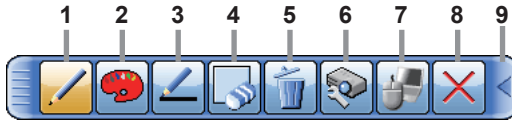

**NOTE** • Images may be copyrighted, in which case, permission from the copyright holder is necessary for use, in accordance with the copyright act and other applicable laws.

• The drawing function does not support drawing on images from the **LAN** port or the **USB TYPE B** port of the projector. If you operate the  $\ddot{O} \backslash \text{æ} \wedge$  Pen tablet / USB mouse while these images are displayed, the input source may automatically switch to **USB TYPE A** port.

**1. Pen**



Selects the pen function.



The cursor turns into a **Pencil** ; dragging it draws a line of the specified pen color and size.



The cursor turns into a **Laser Pointer** . Dragging it does not draw a line.

**2. Pen color**



Selects the **Color** of the line drawn by the **Pencil**.



Specifies **Black**.



Specifies **Red**.



Specifies **Blue**.

**3. Pen size**

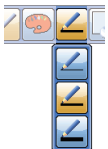

Selects the **Thickness** of the line drawn by the **Pencil**.



Specifies **1-dot**.



Specifies **3-dot**.



Specifies **5-dot**.

(continued on next page)



## Drawing function (continued)

### 4. Eraser



Switches the electronic pen function to that of an eraser and specifies its size. The cursor turns into an **Eraser** ; dragging it erases previously drawn lines.



Specifies a **12-dot Eraser**.



Specifies a **20-dot Eraser**.



Specifies a **28-dot Eraser**.

### 5. Erase



Erases all the lines drawn with the pen.

### 6. Projector Operation

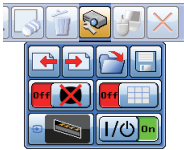

Operates the projector.



Calls up and display the previous file in the USB storage device from that currently selected. This function is available when the projector is displaying a file from a USB storage device.



Calls up and display the next file in the USB storage device from that currently displayed. This function is available when the projector is displaying a file from a USB storage device.



Displays thumbnails of files recorded on a USB storage device. The cursor on the screen turns to an arrow and can select an icon of folder, image and moving to upper folder. Touching or clicking activates in the same way as the **ENTER** button of the remote control. You can display an image onto the projector screen by touching or clicking its thumbnail.



Saves the image on the projector screen, along with any text or pictures drawn, onto a USB storage device connected to the projector.

- Files are saved with the file name “Pxxx.bmp” (where xxx is a consecutive number) into a folder named “PJ\_Capture”. If it does not already exist, a “PJ\_Capture” folder is created automatically.
- The time stamp of saved files are as per the date and time settings of the projector. Check the DATE AND TIME setting for WIRELESS SETUP or WIRED SETUP in the NETWORK menu ([76](#), [80](#)).
- The tool bar is not saved.
- Copyright protected images cannot be saved.
- Drawing with this function cannot be saved to MyScreen ([58](#)).

(continued on next page)

## Drawing function (continued)

### 6. Projector Operation (continued)

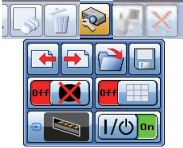

Temporarily blanks out the display.  
Another touching or clicking recovers the display.



Toggles between display/hide the Pattern (grid lines).



Cycles through the display source signals.  
 • It can be used in the same way as the **INPUT** button on the control panel. However, images cannot be selected from the **LAN** port or the **USB TYPE B** port.



Turns off the projector.  
 Touch/click the icon for three seconds or so.  
 • If you turn the projector off while using the drawing function, any unsaved drawings will be lost.

### 7. Mouse Operation



When the computer screen is displayed, this function operates the computer like a simple mouse or keyboard.

• In order to use this function, connect the **USB TYPE B** port of the projector with a USB (A) port of the computer via a USB cable. Then select MOUSE for USB TYPE B item in the OPTION menu (65).



Works like the Page Down button on a keyboard.



Works like the Page Up button on a keyboard.



Works like the left-click button on a mouse.



Works like the right-click button on a mouse.



Moves the mouse's cursor in the direction of the arrow.

### 8. Exit



Closes the tool bar and exits the drawing function.  
 • When exiting the drawing mode, all unsaved drawings are lost.

### 9. Minimize



Minimizes the tool bar.



Touching or clicking the minimized tool bar icon displays the tool bar again.

## USB Display

The projector can display images transferred from a computer via an USB cable (🔌11).

**NOTE** • When the screen resolution of your computer is over specified, the computer image is shrunk in specified size as below before transferring to the projector.

**8970, 8971:** 1024 x 768 (XGA)

**The other models:** 1280 x 800

The transferred image is displayed as shrunk on the projected screen even if the panel resolution of the projector is larger than above.

### Hardware and software requirement for computer

- **OS:** One of the following. (32 bit version only)
  - Windows<sup>®</sup> XP Home Edition /Professional Edition
  - Windows Vista<sup>®</sup> Home Basic /Home Premium /Business /Ultimate /Enterprise
  - Windows<sup>®</sup> 7 Starter /Home Basic /Home Premium /Professional / Ultimate / Enterprise
- **CPU:** Pentium 4 (2.8 GHz or higher)
- **Graphic card:** 16 bit, XGA or higher
- **Memory:** 512 MB or higher
- **Hard disk space:** 30 MB or higher
- **USB(A) Port**
- **USB cable :** 1 piece

## USB Display (continued)

### Starting USB Display

Select the USB DISPLAY for the USB TYPE B item in the OPTION menu. When you connect your computer to the **USB TYPE B** port on the projector using a USB cable, the projector will be recognized as a CD-ROM drive on your computer. Then, the software in the projector, "LiveViewerLiteUSB.exe", will run automatically and the application, "LiveViewer Lite for USB", will be ready on your computer for the USB Display. The application, "LiveViewer Lite for USB", will be automatically closed when the USB cable is unplugged.

**NOTE** • If the software does not start automatically (this is typically because CD-ROM autorun is disabled on your OS), follow the instructions below.

(1) Click on the [Start] button on the toolbar and select the "Run"

(2) Enter F:\LiveViewerLiteUSB.exe and then press the [OK]

↑ If your CD-ROM drive is not drive F on your computer, you will need to replace F with the correct drive letter assigned to your CD-ROM drive.

- CD-ROM autorun is disabled while the screen saver is running.
- The image transmission from the computer is suspended while the password-protected screen saver is running. To resume the transmission, exit the screen saver.
- Check our web site for the latest version of the software and its manual.

(📖) **User's Manual (concise)**

Follow the instructions that can be obtained at the site for updating.

This application will appear as an icon in the Windows notification area once it starts. You can quit the application from your computer by selecting "Quit" on the menu.



**NOTE** • The "LiveViewer" (refer to the **Network Guide**) and this application cannot be used at the same time. If you connect your computer to the projector by using a USB cable while the "LiveViewer" is running, the following message will be displayed.

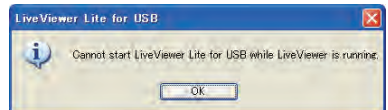

- Depending on the software installed on your computer, images on your computer cannot be transferred using "LiveViewer Lite for USB".
- If any application software having the firewall function is installed into your computer, make the firewall function invalid with following the user's manual.
- Some security software may block image transmission. Please change the security software setting to allow the use of "LiveViewer Lite for USB".
- When the audio input from **USB TYPE B** (🔊55) is selected, if the sound level is still low even after raising the volume level in the projector to the maximum, check whether your computer outputs audio and raise the volume level accordingly.

## USB Display (continued)

### Right-Click menu

The menu shown in the right will be displayed when you right-click the application icon in the Windows notification area.

**Display** : The Floating menu is displayed, and the icon disappears from the Windows notification area.

**Quit** : The application is closed, and the icon disappears from the Windows notification area.

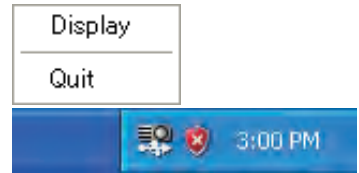

**NOTE** • If you wish to restart the application, you need to unplug the USB cable and plug it again.

### Floating menu

If you select “Display” on the Right-Click menu, the Floating menu shown in the right will appear on your computer screen.

① Start capture button

The transmission to the projector is started and the images will be displayed.

② Stop capture button

The image transmission is stopped.

③ Hold button

The image on the projector’s screen is temporarily frozen. The last image before the button is clicked is remained on the screen. You can revise the image data on your computer without showing it on the projector's screen.

④ Option button

The Options window is displayed.

⑤ Minimize button

The Floating menu is closed, and the icon reappears in the Windows notification area.

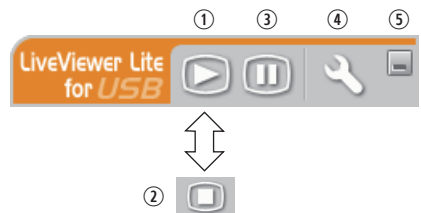

**NOTE** • Images may not be displayed on screen, if the start/stop capture buttons are clicked repeatedly.

## USB Display (continued)

### Options window

If you select the Option button on the Floating menu, the Options window is displayed.

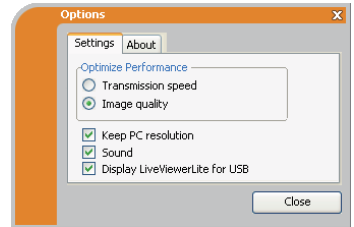

### Optimize Performance

The “LiveViewer Lite for USB” captures screenshots in JPEG data and sends them to the projector.

The “LiveViewer Lite for USB” has two options that have different compression rate of JPEG data.

#### Transmission speed

Speed takes priority over Image quality.

It makes JPEG compression rate higher. The screen on the projector is rewritten quicker because the transferred data is smaller, but the image quality is worse.

#### Image quality

Image quality takes priority over Speed.

It makes JPEG compression rate lower. The screen on the projector is rewritten slower because the transferred data is larger, but the image quality is better.

### Keep PC resolution

If you remove the check mark from the [**Keep PC resolution**] box, the screen resolution of your computer will be switched as follows, and the display speed may be faster.

**8970, 8971:** 1024 x 768 (XGA)

**The other models:** 1280 x 800

If your computer does not support the display resolution specified above, a smaller resolution that is the largest among the resolutions that are supported by the computer will be selected.

### Sound

Turns the sound on/off. The image quality may deteriorate when you play back audio data transferred together with the image data. To give priority to the image quality, turn off the sound by selecting the checkbox.

### Display LiveViewer Lite for USB

If you want to display the "LiveViewer Lite for USB" application window on the screen, please check the box.

### About

The version information of the “LiveViewer Lite for USB”.

**NOTE** • When the resolution is changed, the arrangement of icons on computer desktop screen may be changed.

• If one of the **AUDIO IN** ports is selected or **X** is selected for USB TYPE B in AUDIO SOURCE of the AUDIO menu (**55**), audio sound operation in the Options window will be disabled.

## Maintenance

## Replacing the lamp

A lamp has finite product life. Using the lamp for long periods of time could cause the pictures darker or the color tone poor. Note that each lamp has a different lifetime, and some may burst or burn out soon after you start using them.

Preparation of a new lamp and early replacement are recommended. To prepare a new lamp, make contact with your dealer and tell the lamp type number.

**Type number <8970, 8972W, 8974WU>: 456-8970**

**Type number <8971, 8973W, 8975WU, 8976SX>: 456-8971**

### Replacing the lamp

- 1 Turn the projector off, and unplug the power cord. Allow the projector to cool for at least 45 minutes.
- 2 Prepare a new lamp. If the projector is mounted with specified mounting accessories, or if the lamp has broken, also ask the dealer to replace the lamp.

**In case of replacement by yourself, follow the following procedure.**

- 3 Loosen the screw (marked by arrow) of the lamp cover and then slide down and lift the lamp cover to remove it.
- 4 Loosen the 3 screws (marked by arrow) of the lamp, and slowly pull the lamp out by the handles. Never loosen any other screws.
- 5 Insert the new lamp, and retighten firmly the 3 screws of the lamp that are loosened in the previous process to lock it in place.
- 6 While putting the interlocking parts of the lamp cover and the projector together, slide the lamp cover back in place. Then firmly fasten the screw of the lamp cover.
- 7 Turn the projector on and reset the lamp time using the LAMP TIME item in the OPTION menu.
  - (1) Press the **MENU** button to display a menu.
  - (2) Point at the **ADVANCED MENU** in the menu using the **▼/▲** button, then press the **▶** button.
  - (3) Point at the **OPTION** in the left column of the menu using the **▼/▲** button, then press the **▶** button.
  - (4) Point at the **LAMP TIME** using the **▼/▲** button, then press the **▶** button. A dialog will appear.
  - (5) Press the **▶** button to select "OK" on the dialog. It performs resetting the lamp time.

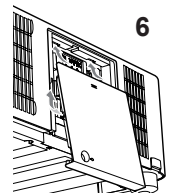
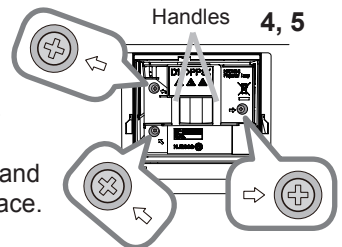
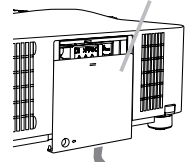
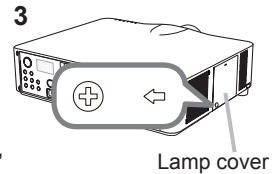

**⚠ CAUTION** ▶ Do not touch the interior of the projector, while the lamp is taken out.

**NOTE** • Please reset the lamp time only when you have replaced the lamp, for a suitable indication about the lamp.

## Replacing the lamp (continued)

### Lamp warning

 **HIGH VOLTAGE**     **HIGH TEMPERATURE**     **HIGH PRESSURE**

**⚠ WARNING** ▶ The projector uses a high-pressure mercury glass lamp. The lamp can break with a loud bang, or burn out, if jolted or scratched, handled while hot, or worn over time. Note that each lamp has a different lifetime, and some may burst or burn out soon after you start using them. In addition, if the bulb bursts, it is possible for shards of glass to fly into the lamp housing, and for gas containing mercury and dust containing fine particles of glass to escape from the projector's vent holes.

▶ **About disposal of a lamp:** This product contains a mercury lamp; do not put it in a trash. Dispose of it in accordance with environmental laws.

- For lamp recycling, go to [www.lamprecycle.org](http://www.lamprecycle.org) (in the US).
- For product disposal, consult your local government agency or [www.eiae.org](http://www.eiae.org) (in the US) or [www.epsc.ca](http://www.epsc.ca) (in Canada).

For more information, call your dealer.



Disconnect  
the plug  
from the  
power  
outlet

- If the lamp should break (it will make a loud bang when it does), unplug the power cord from the outlet, and make sure to request a replacement lamp from your local dealer. Note that shards of glass could damage the projector's internals, or cause injury during handling, so please do not try to clean the projector or replace the lamp yourself.
- If the lamp should break (it will make a loud bang when it does), ventilate the room well, and make sure not to inhale the gas or fine particles that come out from the projector's vent holes, and not to get them into your eyes or mouth.
- Before replacing the lamp, turn the projector off and unplug the power cord, then wait at least 45 minutes for the lamp to cool sufficiently. Handling the lamp while hot can cause burns, as well as damaging the lamp.



- Never unscrew except the appointed (marked by an arrow) screws.
- Do not open the lamp cover while the projector is suspended from a ceiling. This is dangerous, since if the lamp's bulb has broken, the shards will fall out when the cover is opened. In addition, working in high places is dangerous, so ask your local dealer to have the lamp replaced even if the bulb is not broken.
- Do not use the projector with the lamp cover removed. At the lamp replacing, make sure that the screws are screwed in firmly. Loose screws could result in damage or injury.



- Use only the lamp of the specified type. Use of a lamp that does not meet the lamp specifications for this model could cause a fire, damage or shorten the life of this product.
- If the lamp breaks soon after the first time it is used, it is possible that there are electrical problems elsewhere besides the lamp. If this happens, consult your local dealer or a service representative.
- Handle with care: jolting or scratching could cause the lamp bulb to burst during use.
- Using the lamp for long periods of time, could cause it dark, not to light up or to burst. When the pictures appear dark, or when the color tone is poor, please replace the lamp as soon as possible. Do not use old (used) lamps; this is a cause of breakage.



## Cleaning and replacing the air filter

Please check and clean the air filter periodically. When the indicators or a message prompts you to clean the air filter, comply with it as soon as possible. The filter unit with 2 sheets of filters is inside of the filter cover. In addition, the extra air filter is attached to inner side of the filter cover of **8971**, **873W** and **8975WU**. If one of the filters is damaged or heavily soiled, replace whole filter set with a new one.

Request for a filter set with the following type number from your dealer when purchasing a new one.

**Type number <8970, 8972W, 8976SX, 8974WU0>: MU06642**

**Type number <8971, 8973W, 8975WU>: UX38241**

1. Turn the projector off, and unplug the power cord. Allow the projector to sufficiently cool down.
2. Use a vacuum cleaner on and around the filter cover.
3. Pick and pull up the filter cover knobs to take it off.
4. Press up slightly the bottom side knobs to unlock the bottom side of the filter unit. Pull the center knob to take the filter unit off.
5. Use a vacuum cleaner for the filter vent of the projector and the outer side of the filter unit.
6. The filter unit consists of two parts. Press down around the interlocking parts to unlock, then separate the two parts.
7. Use a vacuum cleaner for the inner side of each part of the filter unit to clean them up. If the filters are damaged or heavily soiled, replace them with the new ones.
8. Combine the two parts to reassemble the filter unit.
9. Put the filter unit back into the projector.

(continued on next page)

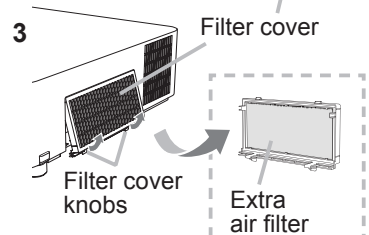
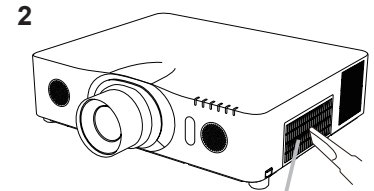

**<Only for 8971, 8972W and 8975WU>**

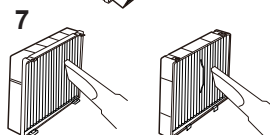
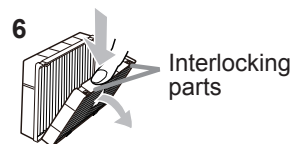
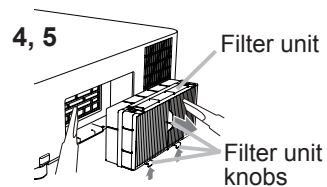

### Cleaning and replacing the air filter (continued)

10. Put the filter cover back into the place.
11. Turn the projector on and reset the filter time using the FILTER TIME item in the EASY MENU.
  - (1) Press the **MENU** button to display a menu.
  - (2) Point at the FILTER TIME using the ▲/▼ cursor buttons, then press the ► cursor (or the **ENTER** / the **RESET**) button. A dialog will appear.
  - (3) Press the ► cursor button to select the “OK” on the dialog. It performs resetting the filter time.

**⚠ WARNING** ► Before taking care of the air filter, make sure the power cable is not plugged in, then allow the projector to cool sufficiently.

► Use only the air filter of the specified type. Do not use the projector without the air filter or the filter cover. It could result in a fire or malfunction to the projector.

► Clean the air filter periodically. If the air filter becomes clogged by dust or the like, internal temperatures rise and could cause a fire, a burn or malfunction to the projector.

**NOTE** • Please reset the filter time only when you have cleaned or replaced the air filter, for a suitable indication about the air filter.

• The projector may display the message such as the “CHECK THE AIR FLOW” or turn off the projector, to prevent the internal heat level rising.

## Other care

### Inside of the projector

In order to ensure the safe use of your projector, please have it cleaned and inspected by your dealer about once every year.

### Caring for the lens

If the lens is flawed, soiled or fogged, it could cause deterioration of display quality. Please take care of the lens, being cautious of handling.

1. Turn the projector off, and unplug the power cord. Allow the projector to cool sufficiently.
2. After making sure that the projector is cool adequately, lightly wipe the lens with a commercially available lens-cleaning wipe. Do not touch the lens directly with your hand.

### Caring for the cabinet and remote control

Incorrect care could have adverse influence such as discoloration, peeling paint, etc.

1. Turn the projector off, and unplug the power cord. Allow the projector to cool sufficiently.
2. After making sure that the projector is cool adequately, lightly wipe with gauze or a soft cloth.  
If the projector is extremely dirty, dip soft cloth in water or a neutral cleaner diluted in water, and wipe lightly after wringing well. Then, wipe lightly with a soft, dry cloth.

**⚠ WARNING** ► Before caring, make sure the power cord is not plugged in, and then allow the projector to cool sufficiently. The care in a high temperature state of the projector could cause a burn and/or malfunction to the projector.

► Never try to care for the inside of the projector personally. Doing is so dangerous.

► Avoid wetting the projector or inserting liquids in the projector. It could result in a fire, an electric shock, and/or malfunction to the projector.

- Do not put anything containing water, cleaners or chemicals near the projector.
- Do not use aerosols or sprays.

**⚠ CAUTION** ► Please take right care of the projector according to the following. Incorrect care could cause not only an injury but adverse influence such as discoloration, peeling paint, etc.

► Do not use cleaners or chemicals other than those specified in this manual.

► Do not polish or wipe with hard objects.

**NOTICE** ► Do not directly touch the lens surface with hands.

## Troubleshooting

If an abnormal operation should occur, stop using the projector immediately.

**⚠ WARNING** ▶ Never use the projector if abnormal operations such as smoke, strange odor, excessive sound, damaged casing or elements or cables, penetration of liquids or foreign matter, etc. should occur. In such cases, immediately disconnect the power plug from the power outlet. After making sure that the smoke or odor has stopped, contact to your dealer or service company.

Otherwise if a problem occurs with the projector, the following checks and measures are recommended before requesting repair.

If this does not resolve the problem, please contact your dealer or service company. They will tell you what warranty condition is applied.



### Warnings displayed on the Status Monitor

If an error occurs, a warning will be displayed on the Status Monitor (📖21).

Resolve the errors referring to the table of the sections "Related messages" and "Regarding the indicator lamps" when the warning is displayed.



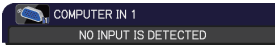

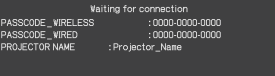
### Related messages

When some message appears, check and cope with it according to the following table. Although these messages will be automatically disappeared around several minutes, it will be reappeared every time the power is turned on.

Message	Description
	<p><b>There is no input signal.</b> Please confirm the signal input connection, and the status of the signal source.</p>
	<p><b>The USB TYPE B port is selected as the picture input source even if MOUSE is selected for USB TYPE B (📖65).</b> Select the USB DISPLAY for the USB TYPE B item in the OPTION menu. In this case, you cannot use the simple mouse and keyboard function. Otherwise select other port for picture input.</p>
	<p><b>Projector is waiting for an image file.</b> Check the hardware connection, settings on the projector and network-related settings.</p>
	<p>The computer-Projector network connection might be disconnected. Please re-connect them.</p>

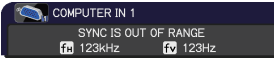
(continued on next page)

Related messages (continued)

Message	Description
	<p><b>The horizontal or vertical frequency of the input signal is not within the specified range.</b> Please confirm the specs for your projector or the signal source specs.</p>
	<p><b>An improper signal is input.</b> Please confirm the specs for your projector or the signal source specs.</p>
	<p><b>The internal temperature is rising.</b> Please turn the power off, and allow the projector to cool down at least 20 minutes. After having confirmed the following items, please turn the power ON again.</p> <ul style="list-style-type: none"> <li>• Is there blockage of the air passage aperture?</li> <li>• Is the air filter dirty?</li> <li>• Does the peripheral temperature exceed 45°C?</li> <li>• If you use <b>8970, 8972W, 8976SX</b> or <b>8974WU</b>, does the peripheral temperature exceed 40°C?</li> <li>• Is the setting for ALTITUDE appropriate?</li> </ul> <p>For details of ALTITUDE, refer to ALTITUDE of SERVICE in the OPTION menu (📖67). If the projector is used with a wrong setting, it may cause damage to the projector itself or the parts inside.</p>
	<p><b>A note of precaution when cleaning the air filter.</b> Please immediately turn the power off, and clean or change the air filter referring to the <b>Cleaning and replacing the air filter</b> section of this manual. After you have cleaned or changed the air filter, please be sure to reset the filter timer (📖65, 113).</p>
	<p><b>The button operation is not available.</b> Check the button you are going to use (📖6). Even when a usable button is pressed, all button operations are not available under the following conditions.</p> <ul style="list-style-type: none"> <li>- While the lens is moving, button operation from the control panel or the remote control might be ignored.</li> <li>- Pressing the one of buttons to call a signal input might be ignored, when all the input ports belonging to the category the button's name shows are set to the "SKIP" by the item SOURCE SKIP of the OPTION menu.</li> </ul>

## Regarding the indicator lamps

When operation of the **LAMP**, **TEMP** and **POWER** indicators differs from usual, check and cope with it according to the following table.

POWER indicator	LAMP indicator	TEMP indicator	Description
Lighting In <b>Orange</b>	Turned <b>off</b>	Turned <b>off</b>	<b>The projector is in a standby state.</b> Please refer to the section "Power on/off".
<i>Blinking</i> In <b>Green</b>	Turned <b>off</b>	Turned <b>off</b>	<b>The projector is warming up.</b> Please wait.
Lighting In <b>Green</b>	Turned <b>off</b>	Turned <b>off</b>	<b>The projector is in an on state.</b> Ordinary operations may be performed.
<i>Blinking</i> In <b>Orange</b>	Turned <b>off</b>	Turned <b>off</b>	<b>The projector is cooling down.</b> Please wait.
<i>Blinking</i> In <b>Red</b>	(discretionary)	(discretionary)	<b>The projector is cooling down. A certain error has been detected.</b> Please wait until <b>POWER</b> indicator finishes blinking, and then perform the proper measure using the item descriptions below.
<i>Blinking</i> In <b>Red</b> or Lighting In <b>Red</b>	Lighting In <b>Red</b>	Turned <b>off</b>	<b>The lamp does not light, and there is a possibility that interior portion has become heated.</b> Please turn the power off, and allow the projector to cool down at least 20 minutes. After the projector has sufficiently cooled down, please make confirmation of the following items, and then turn the power on again. <ul style="list-style-type: none"> <li>• Is there blockage of the air passage aperture?</li> <li>• Is the air filter dirty?</li> <li>• Does the peripheral temperature exceed 45°C?</li> <li>• If you use <b>8970</b>, <b>8972W</b>, <b>8976SX</b> or <b>8974WU</b>, does the peripheral temperature exceed 40°C?</li> </ul> If the same indication is displayed after the remedy, please change the lamp referring to the section <b>Replacing the lamp</b> .
<i>Blinking</i> In <b>Red</b> or Lighting In <b>Red</b>	<i>Blinking</i> In <b>Red</b>	Turned <b>off</b>	<b>The lamp cover has not been properly fixed.</b> Please turn the power off, and allow the projector to cool down at least 45 minutes. After the projector has sufficiently cooled down, please make confirmation of the attachment state of the lamp cover. After performing any needed maintenance, turn the power on again. If the same indication is displayed after the remedy, please contact your dealer or service company.

(continued on next page)

**Regarding the indicator lamps (continued)**

POWER indicator	LAMP indicator	TEMP indicator	Description
Blinking In <b>Red</b> or Lighting In <b>Red</b>	Turned off	Blinking In <b>Red</b>	<p><b>The cooling fan is not operating.</b> Please turn the power off, and allow the projector to cool down at least 20 minutes. After the projector has sufficiently cooled down, please make confirmation that no foreign matter has become caught in the fan, etc., and then turn the power on again. If the same indication is displayed after the remedy, please contact your dealer or service company.</p>
Blinking In <b>Red</b> or Lighting In <b>Red</b>	Turned off	Lighting In <b>Red</b>	<p><b>There is a possibility that the interior portion has become heated.</b> Please turn the power off, and allow the projector to cool down at least 20 minutes. After the projector has sufficiently cooled down, please make confirmation of the following items, and then turn the power on again.</p> <ul style="list-style-type: none"> <li>• Is there blockage of the air passage aperture?</li> <li>• Is the air filter dirty?</li> <li>• Does the peripheral temperature exceed 45°C?</li> <li>• If you use <b>8970, 8972W, 8976SX</b> or <b>8974WU</b>, does the peripheral temperature exceed 40°C?</li> <li>• Is the setting for ALTITUDE appropriate? For details on ALTITUDE, refer to ALTITUDE of SERVICE in the OPTION menu (<a href="#">67</a>). If the projector is used with a wrong setting, it may cause damage to the projector itself or the parts inside.</li> </ul>
Lighting In <b>Green</b>	Simultaneous blinking in <b>Red</b>		<p><b>It is time to clean the air filter.</b> Please immediately turn the power off, and clean or change the air filter referring to the section <b>Cleaning and replacing the air filter</b>. After cleaning or changing the air filter, please be sure to reset the filter timer. After the remedy, reset the power to ON.</p>
Lighting In <b>Green</b>	Alternative blinking in <b>Red</b>		<p><b>There is a possibility that the interior portion has become overcooled.</b> Please use the unit within the usage temperature parameters (0°C to 40°C or 45°C (<a href="#">User's Manual (concise)</a>)). After the treatment, reset the power to ON.</p>
Blinking In <b>Green</b> for approx. 3 seconds.	Turned off	Turned off	<p><b>At least 1 Power ON schedule is saved to the projector.</b> Please refer to <b>3.1.7 Schedule Settings</b> in the <b>Network Guide</b>.</p>

(continued on next page)

**Regarding the indicator lamps (continued)**

**NOTE** • When the interior portion has become overheated, for safety purposes, the projector is automatically shut down, and the indicator lamps may also be turned off. In such a case, disconnect the power cord, and wait at least 45 minutes. After the projector has sufficiently cooled down, please make confirmation of the attachment state of the lamp and lamp cover, and then turn the power on again.

For the **SECURITY** indicator, see SECURITY INDICATOR in the SECURITY menu (📖91).

For the **SHADE** indicator, see the section "Temporarily shading the screen" (📖36).

The **FILTER** indicator shows the condition of the air filter. Utilize this feature to keep the interior of the projector in good condition.

FILTER indicator	Description
Turned off	<b>The air filter is clean.</b> No need to clean up.
Lighting In Orange	<b>The air filter is going to be choked.</b> It is recommended to clean it.
Lighting In Red	<b>The air filter is choked.</b> It is required to turn the power off and clean the air filter immediately.

**NOTE** • The **FILTER** indicator might light up in orange or red when something blocks the intake vents even though the air filter is clean.  
• The **FILTER** indicator might light up differently from other indicators or display messages related to cleaning the air filter. Follow the prompt that is displayed earlier.

**Resetting all settings**

When it is hard to correct some wrong settings, the FACTORY RESET function of SERVICE item in OPTION menu (📖73) can reset all settings (except settings such as LANGUAGE, LAMP TIME, FILTER TIME, FILTER MESSAGE, STANDBY MODE, COMMUNICATION, SECURITY and NETWORK) to the factory default.



## Phenomena that may be easy to be mistaken for machine defects

About the phenomenon confused with a machine defect, check and cope with it according to the following table.

Phenomenon	Cases not involving a machine defect	Reference page
Power does not come on.	<b>The electrical power cord is not plugged in.</b> Correctly connect the power cord.	16
	<b>The main power source has been interrupted during operation such as by a power outage (blackout), etc.</b> Please disconnect the power plug from the power outlet, and allow the projector to cool down at least 10 minutes, then turn the power on again.	16
	<b>Either there is no lamp and/or lamp cover, or either of these has not been properly fixed.</b> Please turn the power off and disconnect the power plug from the power outlet, and allow the projector to cool down at least 45 minutes. After the projector has sufficiently cooled down, please make confirmation of the attachment state of the lamp and lamp cover, and then turn the power on again.	111
Neither sounds nor pictures are outputted.	<b>The signal cables are not correctly connected.</b> Correctly connect the connection cables.	10 ~ 14
	<b>Signal source does not correctly work.</b> Correctly set up the signal source device by referring to the manual of the source device.	–
	<b>The input changeover settings are mismatched.</b> Select the input signal, and correct the settings.	26
	<b>AV MUTE function is working.</b> Press AV MUTE button on the remote control.	25
Sound does not come out.	<b>The signal cables are not correctly connected.</b> Correctly connect the audio cables.	10 ~ 14
	<b>The volume is adjusted to an extremely low level.</b> Adjust the volume to a higher level using the menu function or the remote control.	25, 55
	<b>The AUDIO SOURCE/SPEAKER setting is not correct.</b> Correctly set the AUDIO SOURCE/SPEAKER in AUDIO menu.	55

(continued on next page)

**Phenomena that may be easy to be mistaken for machine defects (continued)**

Phenomenon	Cases not involving a machine defect	Reference page
Sound does not come out. (continued)	<p><b>The mode selected for HDMI AUDIO is not suitable.</b> Check each of the two modes provided and select the suitable one for your HDMI™ audio device.</p>	56
	<p><b>The Sound button (🔊) or checkbox is disabled.</b> If you have selected <b>USB TYPE A</b>, turn the sound on from the Thumbnail menu. If you have selected <b>USB TYPE B</b>, remove the check mark from the Sound checkbox in the Options window of “LiveViewer Lite for USB”. If you have selected <b>LAN</b>, remove the check mark from the Sound checkbox in the Option menu of “LiveViewer”.</p>	95, 110
No pictures are displayed.	<p><b>The signal cables are not correctly connected.</b> Correctly connect the connection cables.</p>	10 ~ 14
	<p><b>The brightness is adjusted to an extremely low level.</b> Adjust BRIGHTNESS to a higher level using the menu function.</p>	42
	<p><b>The computer cannot detect the projector as a plug and play monitor.</b> Make sure that the computer can detect a plug and play monitor using another plug and play monitor.</p>	10
	<p><b>The lens shade is closed.</b> Check whether the <b>SHADE</b> indicator is blinking. If it is blinking, press <b>SHADE</b> button on the control panel.</p>	36
	<p><b>The USB TYPE B port is selected as the picture input source even if MOUSE is selected for USB TYPE B.</b> Select USB DISPLAY for USB TYPE B in OPTION menu to project the picture input to the port. Otherwise select other port for picture input.</p>	65
	<p><b>The projector does not recognize the USB storage device inserted into USB TYPE A ports.</b> Use the REMOVE USB function first, remove the USB storage device, and then insert it into the port again. Before removing the USB storage device, be sure to use the REMOVE USB function on the Thumbnail screen, which appears when the <b>USB TYPE A</b> is selected as the input source.</p>	12, 95

(continued on next page)

**Phenomena that may be easy to be mistaken for machine defects (continued)**

Phenomenon	Cases not involving a machine defect	Reference page
The remote control does not work.	<b>The batteries in the remote control are near the end.</b> Replace the batteries.	17
	<b>The ID numbers set in the projector and the remote control are different.</b> Press the <b>ID</b> button with the same ID number as the projector, then perform the desired operation. The ID number set in the projector can be displayed by pressing any of the <b>ID</b> buttons on the remote control for 3 seconds while the lamp is on.	17
Video screen display freezes.	<b>The FREEZE function is working.</b> Press <b>FREEZE</b> button to restore the screen to normal.	36
Colors have a faded- out appearance, or color tone is poor.	<b>Color settings are not correctly adjusted.</b> Perform picture adjustments by changing the COLOR TEMP, COLOR and/or TINT settings, using the menu functions.	43
	<b>COLOR SPACE setting is not suitable.</b> Change the COLOR SPACE setting to AUTO, RGB, SMPTE240, REC709 or REC601.	48
Pictures appear dark.	<b>The brightness and/or contrast are adjusted to an extremely low level.</b> Adjust BRIGHTNESS and/or CONTRAST settings to a higher level using the menu function.	42
	<b>The projector is operating in Eco mode.</b> Set ECO MODE to NORMAL, and set AUTO ECO MODE to OFF, in the SETUP menu.	53
	<b>The lamp is approaching the end of its product lifetime.</b> Replace the lamp.	111, 112
Pictures appear blurry.	<b>The lens cover is attached.</b> Remove the lens cover.	4
	<b>Either the focus and/or horizontal phase settings are not properly adjusted.</b> Adjust the focus using the <b>FOCUS + / -</b> buttons, and/or H PHASE using the menu function.	29, 47
	<b>The lens is dirty or misty.</b> Clean the lens referring to the section <b>Caring for the lens.</b>	115

(continued on next page)

**Phenomena that may be easy to be mistaken for machine defects (continued)**

Phenomenon	Cases not involving a machine defect	Reference page
Some kind of image degradation such as flickering or stripes appear on screen.	<b>When the projector is operating in Eco mode, flickering may appear on screen.</b> Set ECO MODE to NORMAL, and set AUTO ECO MODE to OFF, in the SETUP menu.	53
	<b>The OVER SCAN ratio is too big.</b> Adjust OVER SCAN in the IMAGE menu smaller.	46
	<b>Excessive VIDEO NR.</b> Change the setting of VIDEO NR in the INPUT menu.	48
	<b>The FRAME LOCK function cannot work on the current input signal.</b> Set FRAME LOCK in the INPUT menu to OFF.	50
The sound or image is unstable or is output intermittently.	<b>When LAN, USB TYPE A or USB TYPE B port is selected, some parts of the output may be missing due to signal processing delay.</b> Change the signal or use another port.	26, 55
The computer connected to the <b>USB TYPE B</b> port of the projector does not start up.	<b>The computer cannot start up in the current hardware configuration.</b> Disconnect the USB cable from the computer, then reconnect it after starting up the computer.	11, 12
RS-232C does not work.	<b>The SAVING function is working.</b> Select NORMAL for STANDBY MODE item in the SETUP menu.	54
	<b>The COMMUNICATION TYPE for the CONTROL port is set to NETWORK BRIDGE.</b> Select OFF for COMMUNICATION TYPE item in the OPTION - SERVICE - COMMUNICATION menu.	70
Network does not work	<b>The SAVING function is working.</b> Select NORMAL for STANDBY MODE item in the SETUP menu.	54
	<b>The same network address is set for both wireless and wired LAN.</b> Change the network address setting for wireless or wired LAN.	75, 79

(continued on next page)

**Phenomena that may be easy to be mistaken for machine defects (continued)**

Phenomenon	Cases not involving a machine defect	Reference page
<p>NETWORK BRIDGE function does not work</p>	<p><b>The NETWORK BRIDGE function is turned off.</b> Select NETWORK BRIDGE for COMMUNICATION TYPE item in the OPTION - SERVICE - COMMUNICATION menu.</p>	<p>70</p>
<p>Schedule function does not work</p>	<p><b>The SAVING function is working.</b> Select NORMAL for STANDBY MODE item in the SETUP menu.</p>	<p>54</p>
	<p><b>The internal clock has been reset.</b> Once you turn off the projector in the SAVING mode or the AC power, the current date and time setting is reset. Check the DATE AND TIME setting for WIRELESS SETUP or WIRED SETUP in the NETWORK menu.</p>	<p>76, 80</p>
<p>When the projector is connected to the network, it powers off and on as described below.</p> <p>Powers off ←</p> <p>↓</p> <p><b>POWER</b> indicator blinks in orange a few times</p> <p>↓</p> <p>Goes into standby mode</p>	<p><b>Disconnect the LAN cable and check that the projector is working properly.</b> If this phenomenon occurs after connecting to the network, there may be a loop between two Ethernet switching hubs within the network, as explained below.</p> <ul style="list-style-type: none"> <li>- There are two or more Ethernet switching hubs in a network.</li> <li>- Two of the hubs are doubly connected by LAN cables.</li> <li>- This double connection forms a loop between the two hubs.</li> </ul> <p>Such a loop may have an adverse effect on the projector as well as the other network devices.</p> <p>Check the network connection and remove the loop by disconnecting the LAN cables such that there is only one connecting cable between two hubs.</p>	<p>—</p>

**NOTE** • Although bright spots or dark spots may appear on the screen, this is a unique characteristic of liquid crystal displays, and it does not constitute or imply a machine defect.

## Specifications

Please see the **Specifications** in the **User's Manual (concise)** which is a book.

### **End User License Agreement for the Projector Software**

- Software in the projector consists of the plural number of independent software modules and there exist our copyright or/and third party copyrights for each of such software modules.
- Be sure to read "End User License Agreement for the Projector Software" which is separated document.

#### **DUKANE CORP AV SERVICE DEPT**

2900 Dukane Drive  
St Charles, IL 60174  
800-676-2487 / 630-762-4032  
Fax 630-584-5156  
avservice@dukane.com  
www.dukane.com/av

## Free Manuals Download Website

<http://myh66.com>

<http://usermanuals.us>

<http://www.somanuals.com>

<http://www.4manuals.cc>

<http://www.manual-lib.com>

<http://www.404manual.com>

<http://www.luxmanual.com>

<http://aubethermostatmanual.com>

Golf course search by state

<http://golfingnear.com>

Email search by domain

<http://emailbydomain.com>

Auto manuals search

<http://auto.somanuals.com>

TV manuals search

<http://tv.somanuals.com>