

Projector

8977/8978W/8979WU

User's Manual (detailed) Network Guide

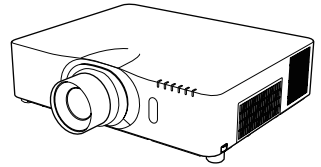

Thank you for purchasing this product.

This manual is intended to explain only the network function. For proper use of this product, please refer to this manual and the other manuals for this product.

⚠ WARNING ▶ Before using this product, be sure to read all manuals for this product. After reading them, store them in a safe place for future reference.

Features

This projector has the network function that brings you the following main features.

- ✓ **Network Presentation** : allows the projector to project computer images transmitted through a network. (15)
- ✓ **Web Control** : allows you to monitor and control the projector through a network from a computer. (16)
- ✓ **My Image** : allows the projector to store up to four still images and project them. (52)
- ✓ **Messenger** : allows the projector to display text sent from a computer through a network. (53)
- ✓ **Network Bridge** : allows you to control an external device through the projector from a computer. (54)

NOTE • The information in this manual is subject to change without notice.
• The illustrations in this manual are for illustrative purposes. They may differ slightly from your projector.
• The manufacturer assumes no responsibility for any errors that may appear in this manual.
• The reproduction, transfer or copy of all or any part of this document is not permitted without express written consent.

Trademark acknowledgment

- Microsoft®, Internet Explorer®, Windows®, Windows Vista® and Aero® are registered trademarks of Microsoft Corporation in the U.S. and/or other countries.
 - Adobe® and Flash® are registered trademarks of Adobe Systems Incorporated.
 - Pentium® is a registered trademark of Intel Corporation.
 - JavaScript® is a registered trademark of Sun Microsystems, Inc.
 - HDMI™, the HDMI logo and High-Definition Multimedia Interface are trademarks or registered trademarks of HDMI Licensing LLC in the United States and other countries.
 - Crestron®, Crestron e-Control®, e-Control®, Crestron RoomView® and RoomView™ are trademarks or registered trademarks of Crestron Electronics, Inc. in the United States and other countries.
 - Trademark PJLink is a trademark applied for trademark rights in Japan, the United States of America and other countries and areas.
- All other trademarks are the properties of their respective owners.

PJLink™

Contents



Caution	4
1. Connection to the network	5
1.1 System requirements	5
1.1.1 Required equipment preparation	5
1.1.2 Hardware and software requirement for computer	5
1.2 Quick connection	6
1.3 Manual network connection setting - Wired LAN -	7
1.3.1 Equipments connection	7
1.3.2 Network settings	7
1.3.3 "Internet Option" setting	10
1.4 Manual network connection setting - Wireless LAN -	11
1.4.1 Preparation for wireless LAN connection	11
1.4.2 Wireless LAN connection set up	12
2. Network Presentation	15
3. Web Control	16
3.1 Projector Web Control	18
3.1.1 Logon	18
3.1.2 Network Information	19
3.1.3 Network Settings	20
3.1.4 Port Settings	23
3.1.5 Mail Settings	25
3.1.6 Alert Settings	26
3.1.7 Schedule Settings	28
3.1.8 Date/Time Settings	31
3.1.9 Security Settings	33
3.1.10 Projector Control	34
3.1.11 Remote Control	40
3.1.12 Projector Status	42
3.1.13 Network Restart	42
3.2 Crestron e-Control®	43
3.2.1 Main window	45
3.2.2 Tools window	47
3.2.3 Info window	49
3.2.4 Help Desk window	50
3.2.5 Emergency Alert	51
4. My Image Function	52
5. Messenger Function	53



6. Network Bridge Function	54
6.1 Connecting devices	54
6.2 Communication setup	55
6.3 Communication port	55
6.4 Transmission method	56
6.4.1 HALF-DUPLEX	56
6.4.2 FULL-DUPLEX	57
7. Other Functions	58
7.1 E-mail Alerts	58
7.2 Projector Management using SNMP	60
7.3 Event Scheduling	61
7.4 Command Control via the Network	64
7.5 Crestron RoomView®	69
8. Troubleshooting	70
9. Warranty and after-sales service	71

Caution

To use the wireless network function of this projector, the designated USB wireless adapter that is sold as an option is required. For precautions according to the standards and laws, refer to the documents that come with the adapter.

[Restriction on plugging and unplugging the USB wireless adapter]

Before you insert or pull out the USB wireless adapter from the projector, turn off the power of the projector and pull out the power cord's plug from the outlet. Do not touch the USB wireless adapter that is connected to the projector while the projector is receiving AC power.

Do not use any extension cable or device when connecting the adapter to the projector.

[Security precautions when using wireless LAN]

It is recommended that security settings, such as SSID and ENCRYPTION, are specified when using wireless LAN communication. If the security settings are not specified, the contents may be intercepted or it may cause unauthorized access to the system. For details on wireless LAN security settings, refer to **3.1 Projector Web Control** or **NETWORK menu** in the **Operating Guide**.

⚠ CAUTION ▶ The optional IEEE802.11b/g/n USB wireless adapter uses the 2.4GHz radio frequency band. You do not need a radio license to use the adapter, but you should be aware of the following:

- DO NOT USE NEAR THE FOLLOWING!
 - Microwave ovens
 - Industrial, scientific or medical devices
 - Designated low power radio stations
 - Premises radio stations

Using the USB wireless adapter near the above may cause radio interference, which would result in a decrease in transmission speed or interruption, and even lead to malfunctioning of devices such as pacemakers.

- Depending on the location where the USB wireless adapter is used, radio wave interference may occur, which may result in a decrease in transmission speed or interruption in communication. In particular, please be aware that using the USB wireless adapter at locations where there is reinforced steel, other types of metals or concrete is likely to cause radio wave interference.

- Available Channels

The USB wireless adapter uses the 2.4GHz radio frequency band, but depending on the country or region you are in, the channels that you can use might be limited. Please consult your dealer for information on the usable channels.

- Bringing the optional USB wireless adapter out of the country or region you reside in and using it there could lead to a violation of the radio laws of that country or region.

1. Connection to the network

1.1 System requirements

1.1.1 Required equipment preparation

The following equipments are required to connect the projector to your computer through the network.

■ **Common** The projector: 1 unit, Computer: minimum 1 set

■ **Depending on how you want to connect**

1) For the wired connection ***1**

LAN cable (CAT-5 or greater): 1 piece

2) For the wireless connection ***2**

- Projector side

IEEE802.11b/g/n USB wireless adapter (option : USB-WL-11N): 1 unit

- Computer side

IEEE802.11b/g/n wireless LAN equipment: 1 unit for each ***3**

***1:** The system for using the network function of the projector requires communication environment conforming 100Base-TX or 10Base-T.

***2:** An access point is required when the wireless LAN connection is used as Infrastructure mode.

***3:** Depending on the type of wireless network device and computer you are using, the projector may not be able to communicate properly with your computer, even if the computer is equipped with a built-in wireless LAN function.

To eliminate communication problems, please use a Wi-Fi certified wireless network device.

1.1.2 Hardware and software requirement for computer

To connect your computer to the projector and use the network function of the projector, your computer needs to meet the following requirements.

✓ **OS:** One of the following.

Windows[®] XP Home Edition /Professional Edition

Windows Vista[®] Home Basic /Home Premium /Business /Ultimate /Enterprise

Windows[®] 7 Starter /Home Basic /Home Premium /Professional /Ultimate /Enterprise

Windows[®] 8

Windows[®] 8 Pro/Enterprise

✓ **CPU:** Pentium 4 (2.8 GHz or higher)

✓ **Graphic card:** 16 bit, XGA or higher

* When using the "LiveViewer" it is recommended that the display resolution of your computer is set to 1024 x 768.

✓ **Memory:** 512 MB or higher

✓ **Hard disk space:** 100 MB or higher

✓ **Web browser:** Internet Explorer[®] 6.0 or higher

✓ **CD-ROM/DVD-ROM drive**

1.1 System requirements (continued)

NOTE • The network communication control is disabled while the projector is in standby mode if the STANDBY MODE item is set to SAVING. Please connect the network communication to the projector after setting the STANDBY MODE to NORMAL. (📖 **SETUP** menu in the **Operating Guide**)

• You can get the latest version of the applications for the network functions of the projector and the latest information for this product from the Hitachi website. (<http://www.hitachi-america.us/projectors> or <http://www.hitachidigitalmedia.com>).

1.2 Quick connection

The “LiveViewer” supports very quick and simple connection to the network. When making use of the network function, it is recommended that you install the “LiveViewer” on your computer. For details, refer to the manual for “LiveViewer”.

In case you don't want to use the “LiveViewer” or you cannot use it by some reason, proceed to the manual setting, the item 1.3 for the wired LAN (📖 **7**) and the item 1.4 for the wireless LAN. (📖 **11**)

1.3 Manual network connection setting - Wired LAN -

This section explains how to set it up manually.

1.3.1 Equipments connection

Connect the projector and a computer with a LAN cable.

* Before connecting with an existing network, contact the network administrator.

Next, check the following computer settings.

1.3.2 Network settings

This is the explanation of network connection settings for Windows® 7 and Internet Explorer.

- 1) Log on to Windows® 7 as administrator authority. Administrator authority is the account, which can access to all functions.
- 2) Open "Control Panel" from "Start" menu.
- 3) Open "View network status and tasks" in "Network and Internet".
With the icons in the "Control Panel" window displayed, click "Network and Sharing Center".

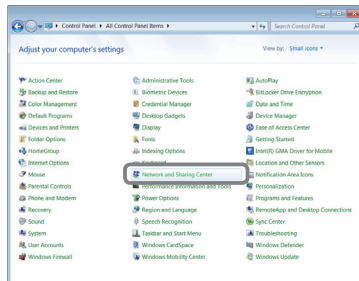

- 4) Click "Change adapter settings" in the menu on the left side of the "Network and Sharing Center" window.

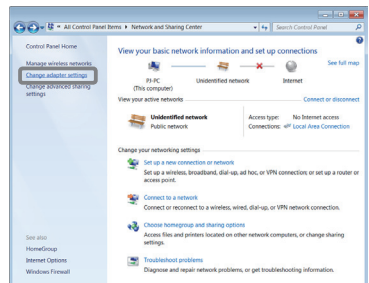

(continued on next page)

1. Connection to the network

1.3 Manual network connection setting - Wired LAN - (continued)

5) Right-click "Local Area Connection" to open the menu, and select "Properties".

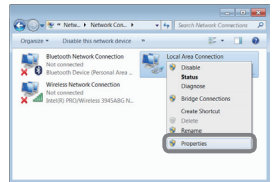

6) Select "Internet Protocol Version 4 (TCP/IPv4)" and click [Properties].

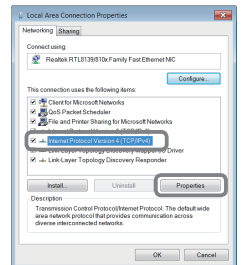

7) Select "Use the following IP address" and configure the IP address, Subnet mask and Default gateway for the computer accordingly. If a DHCP server exists in the network, you can select "Obtain an IP address automatically" and the IP address will be assigned automatically. After setting is complete, click [OK] to close the window.

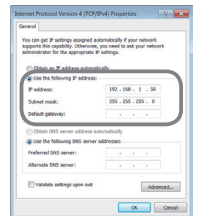

(continued on next page)

1.3 Manual network connection setting - Wired LAN - (continued)

[About IP address]

■ Setting manually

The Network address portion of the IP address setting on your computer must be the same as the setting on the projector. Also, the entire IP address on the computer must not overlap with that of the other devices on the same network, including the projector.

For example

The projector's settings are as follows.

IP address: 192.168.1.254

Subnet mask: 255.255.255.0

(Network address: 192.168.1 in this case)

Therefore, specify the computer's IP address as follows.

IP address: 192.168.1.xxx (xxx shows decimal number.)

Subnet mask: 255.255.255.0

(Network address: 192.168.1 in this case)

Select from 1 to 254 for "xxx" not duplicating with any other equipments.

In this case, since the IP address of the projector is "192.168.1.254", specify a setting between 1 to 253 for the computer.

NOTE • "0.0.0.0" cannot be set to the IP address.

- The projector's IP address can be changed by using the configuration utility via a web browser. (📖22)
- If the projector and the computer exist in the same network (i.e., same network address), you can leave the default gateway field blank.
- When the projector and the computer exist in different networks, the default gateway must be set. Consult to the network administrator in detail.

■ Setting automatically

When a DHCP server exists in the connected network, it is possible to assign an IP address to the projector and computer automatically.

* DHCP is abbreviation for "Dynamic Host Configuration Protocol" and has the function to provide necessary setting for network like IP address from server to client. A server that has DHCP function is called DHCP server.

(continued on next page)

1. Connection to the network

1.3 Manual network connection setting - Wired LAN - (continued)

1.3.3 “Internet Option” setting

1) Click “Internet Options” in “Network and Sharing Center” window to open “Internet Properties” window.

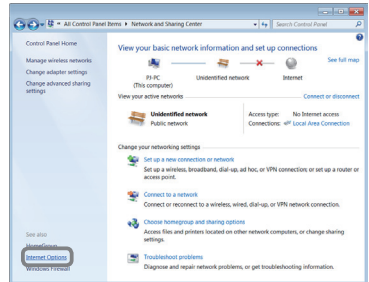

2) Click “Connections” tab and then click [LAN settings] button to open “Local Area Network (LAN) Settings”.

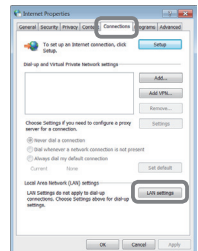

3) Uncheck all boxes in “Local Area Network (LAN) Settings” window.

After setting is complete, click [OK] to close the window.

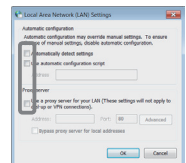

1.4 Manual network connection setting - Wireless LAN -

Using the designated USB wireless adapter (option) on the projector enables the projector and computer to communicate in both the Ad-Hoc and Infrastructure modes.

This section is intended to explain how to set up wireless LAN connection manually.

1.4.1 Preparation for wireless LAN connection

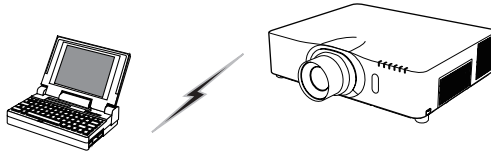

Fig. 1.4.1.a Without an access point communication (Ad-Hoc)

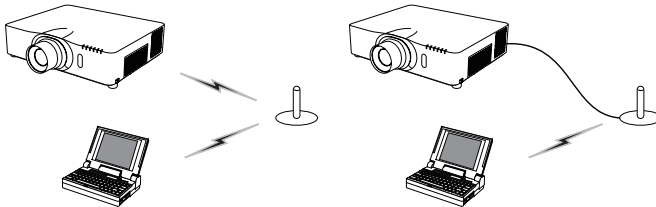

Fig. 1.4.1.b With an access point communication (Infrastructure)

* Ad-Hoc is one of the wireless LAN communication methods without having access point to communicate.

* Infrastructure is one of the wireless LAN communication methods with having access point to communicate. If certain quantities of equipments are used, this mode is efficient.

If communicating with existing network, consult to your network administrator.

First, insert the USB wireless adapter into one of the **USB TYPE A** ports.

( **Connecting with your devices** in the **Operating Guide**)

Then, set up the computer for wireless communication.

When the computer comes with a built-in IEEE802.11b/g/n wireless LAN device, enable it and disable other network connections. If a wireless LAN device is not built into the computer, connect an IEEE802.11b/g/n wireless LAN device and install the device driver. For details, refer to the user's guide for the computer and wireless LAN device.

1. Connection to the network

1.4 Manual network connection setting - Wireless LAN - (continued)

1.4.2 Wireless LAN connection set up

Using wireless LAN utility for Windows® 7 standard.
Wireless LAN initial settings for the projector is as follows.

Connection Control	: Ad-Hoc
SSID	: wireless
Channel	: 1
Encryption rating	: None
IP address	: 192.168.10.254

* You can change these settings via a web browser on your computer or from the menu of the projector. Refer to the item **3.1.3 Network Settings** (📖 21) or **NETWORK** menu in the **Operating Guide**.

1) Select "Change adapter settings" from the menu on the left side of the "Network and Sharing Center" window.

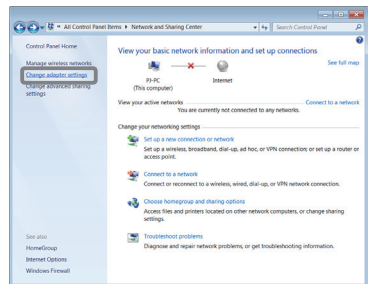

2) Right-click "Wireless Network Connection" to open the menu, and select "Properties".

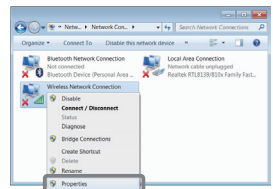

3) Select "Internet Protocol Version 4 (TCP/IPv4)" and click [Properties].

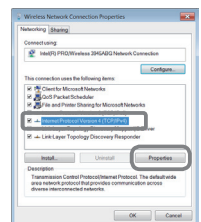

(continued on next page)

1.4 Manual network connection setting - Wireless LAN - (continued)

- 4) Select "Use the following IP address" and configure the IP address, Subnet mask and Default gateway for the computer accordingly.

After setting is complete, click [OK] to close the window.

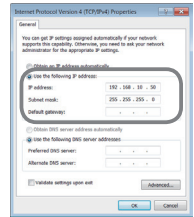

[About IP address]

The Network address portion of the IP address setting on your computer must be the same as the setting on the projector. Also, the entire IP address on the computer must not overlap with that of the other devices on the same network, including the projector.

For example

The projector's settings are as follows.

IP address: 192.168.10.254
 Subnet mask: 255.255.255.0
 (Network address: 192.168.10 in this case)

Therefore, specify the computer's IP address as follows.

IP address: 192.168.10.xxx (xxx shows decimal number.)
 Subnet mask: 255.255.255.0
 (Network address: 192.168.10 in this case)

Select from 1 to 254 for "xxx" not duplicating with any other equipments. In this case, since the IP address of the projector is "192.168.10.254", specify a setting between 1 to 253 for the computer.

NOTE • "0.0.0.0" cannot be set to the IP address.

- The projector's IP address can be changed by using the configuration utility via a web browser. (21)
- If the projector and the computer exist in the same network (i.e., same network address), you can leave the default gateway field blank.
- When the projector and the computer exist in different networks, the default gateway must be set.

(continued on next page)

1. Connection to the network

1.4 Manual network connection setting - Wireless LAN - (continued)

5) Right-click "Wireless Network Connection" to open the menu, and select "Connect / Disconnect".

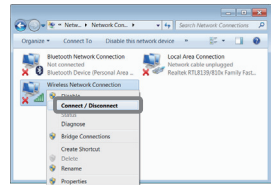

6) From the connectable wireless networks, select the SSID of the projector (set to "wireless" by default), and click [Connect]. If you have enabled encryption, a window asking for input of the encryption key will be displayed. Input the preset key.



7) After connection is established, "Connected" will appear to the right of SSID.



2. Network Presentation

The projector can display or play back the computer screen images and audio data that are transmitted through the network. This Network Presentation feature helps you to smoothly make your presentations and conduct conferences.

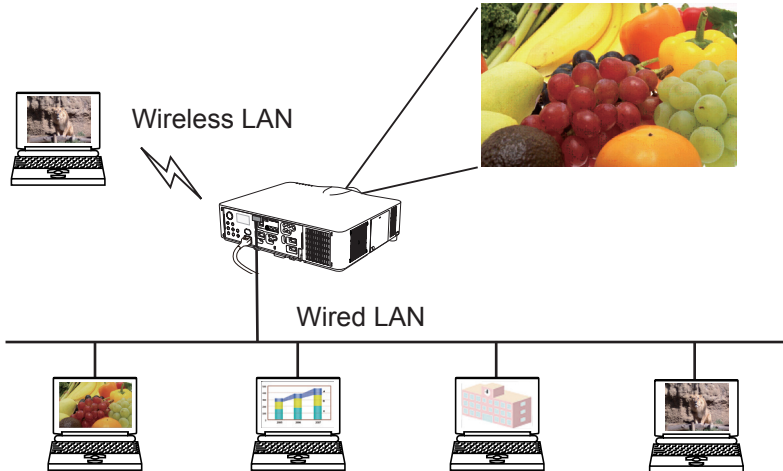

To use Network Presentation, an exclusive application, "LiveViewer" is required. It can be installed from the bundled application CD. You can also download the latest version and relevant information from the Hitachi website (<http://www.hitachi-america.us/projectors> or <http://www.hitachidigitalmedia.com>). For details of Network Presentation and instructions to install the "LiveViewer", refer to the manual for "LiveViewer".

To start the Network Presentation, select the **LAN** port as the input source on the projector and click the Starting Capture button on the "LiveViewer". "LiveViewer" function use depends on the model you are using. If you want to use the latest downloaded "LiveViewer", please refer for the appropriate group item in the "LiveViewer" User's Manual. This model will be in the Group of **G**.

3. Web Control

You can adjust or control the projector via a network from a web browser on a computer that is connected to the same network.

NOTE • Internet Explorer® 6.0 or later is required.

- If JavaScript® is disabled in your web browser configuration, you must enable JavaScript® in order to use the projector web pages properly. See the Help files for your web browser for details on how to enable JavaScript®.
- It is recommended that all web browser updates are installed.
- If data is transferred via wireless and wired LAN at the same time, the projector may not be able to process the data correctly.

Refer to the following for configuring or controlling the projector via a web browser. Make sure that your computer and the projector is connected via network, and then start Web browser.

Enter the projector's IP address into URL input box of the Web browser as the example below, and then press the Enter key or  button.

Example: If the IP address of the projector is set to **192.168.1.10**:

Enter "**http://192.168.1.10/**" into the address bar of the web browser and press the Enter key or click  button.

If a correct URL is input, and the projector and your computer are connected to the same network correctly, the selection window as shown on the right will be displayed. You can choose to use Projector Web Control or Crestron e-Control® as a tool for controlling the projector. Click one of them.

For more details, refer to **3.1 Projector Web Control** ([18](#)) or **3.2 Crestron e-Control®**. ([43](#))

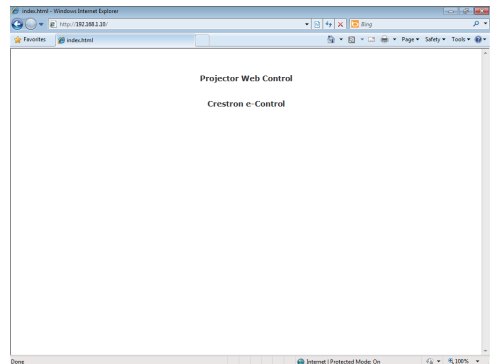

(continued on next page)

NOTE • Do not attempt to control the projector with the projector's menu or remote control, and via Web Control at the same time. It may cause some operational errors in the projector.

- If **Crestron e-Control**[®] in the **Network Settings** (📖22) is set to Disable, the selection window above does not appear, but the Logon window of the Projector Web Control is displayed.
- Crestron e-Control[®] is created using Flash[®]. You need to install Adobe[®] Flash[®] Player on your computer to use Crestron e-Control[®].

3.1 Projector Web Control

3.1.1 Logon

To use the Projector Web Control function, you need to logon with your user name and password.

Below are the factory default settings for user name and password.

User name	Administrator
Password	<blank>

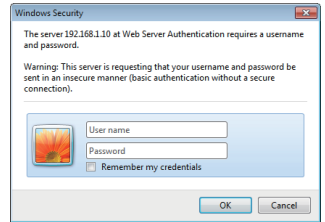

Logon window

Enter your user name and password, and then click the **[OK]**. If you logon successfully, the screen below will be displayed.

Main menu

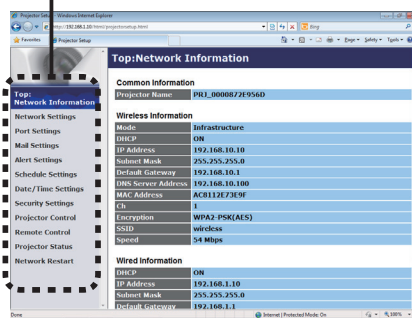

Click the desired operation or configuration item on the main menu.

NOTE • The language used on the Projector Web Control screen is the same as that of the OSD on the projector. If you want to change it, you need to change the OSD language on the projector. (**SCREEN** menu in the **Operating Guide**)

3.1 Projector Web Control (continued)

3.1.2 Network Information

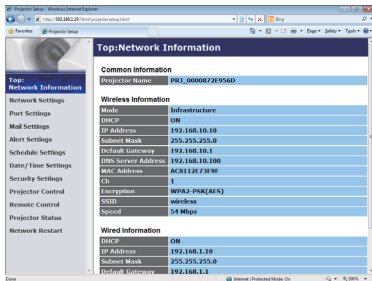

Displays the projector's current network configuration settings.

Item	Description
Common Information	Displays information common to both wireless and wired LAN.
Projector Name	Displays the projector name settings.
Wireless Information	Displays the current settings of wireless LAN.
Mode	Displays the mode of wireless LAN communication.
DHCP	Displays the DHCP setting.
IP Address	Displays the IP address.
Subnet Mask	Displays the subnet mask.
Default Gateway	Displays the default gateway.
DNS Server Address	Displays the DNS server address.
MAC Address	Displays the MAC address.
Ch	Displays the channel used for wireless LAN.
Encryption	Displays the data encryption setting.
SSID	Displays the SSID used by the projector.
Speed	Displays the current wireless LAN transmission speed.
Wired Information	Displays the current wired LAN settings.
DHCP	Displays the DHCP setting.
IP Address	Displays the IP address.
Subnet Mask	Displays the subnet mask.
Default Gateway	Displays the default gateway.
DNS Server Address	Displays the DNS server address.
MAC Address	Displays the MAC address.

3.1 Projector Web Control (continued)

3.1.3 Network Settings

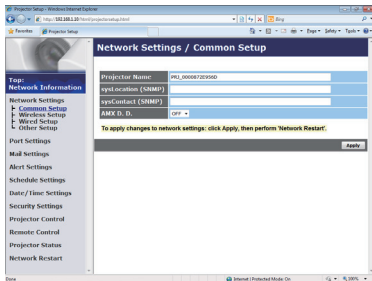

Displays and configures network settings.

Item	Description
Common Setup	Configures the settings common to wireless and wired LAN.
Projector Name	Configures the name of the projector. The length of the Projector Name can be up to 64 alphanumeric characters. Only alphabets, numbers and following symbols can be used. !"#\$%&'()*+,-./:;<=>@[\\]^_`{ }~ and space. Particular projector name is pre-assigned by default.
sysLocation (SNMP)	Configures the location to be referred to when using SNMP. The length of the sysLocation can be up to 255 alphanumeric characters. Only numbers '0-9' and alphabet 'a-z', 'A-Z' can be used.
sysContact (SNMP)	Configures the contact information to be referred to when using SNMP. The length of the sysContact can be up to 255 alphanumeric characters. Only numbers '0-9' and alphabet 'a-z', 'A-Z' can be used.
AMX D.D. (AMX Device Discovery)	Configures the AMX Device Discovery setting to detect the projector from the controllers of AMX connected to the same network. For the details of AMX Device Discovery, visit the AMX web site. <u>URL: http://www.amx.com</u>

(continued on next page)

3.1 Projector Web Control - Network Settings (continued)

Item	Description									
Wireless Setup	Configures the wireless LAN settings.									
Mode	Select "Ad-Hoc" or "Infrastructure".									
IP Configuration	Configures network settings.									
DHCP ON	Enables DHCP.									
DHCP OFF	Disables DHCP.									
IP Address	Configures the IP address when DHCP is disabled.									
Subnet Mask	Configures the subnet mask when DHCP is disabled.									
Default Gateway	Configures the default gateway when DHCP is disabled.									
DNS Server Address	Configures the DNS server address.									
Ch	Select from "1" to "11" a channel to use in the Ad-Hoc mode. <div style="border: 1px solid black; padding: 5px; margin-top: 10px;"> <p>NOTE • Depending on the country where you are the channels may vary. In addition, depending on the country or region where you are may be required to use a wireless network card that confirm to the standards in the respective country or region.</p> </div>									
Encryption	Select data encryption method.									
WEP Key	Input the WEP key. Either ASCII characters or hexadecimal numbers can be used during WEP key input. However, you cannot use a combination of both. The length of the key is defined as follows according to the WEP and character formats.									
	<table border="1" style="width: 100%; border-collapse: collapse;"> <thead> <tr> <th style="width: 33%;">Encryption</th> <th style="width: 33%;">ASCII characters</th> <th style="width: 33%;">HEX numbers</th> </tr> </thead> <tbody> <tr> <td>WEP 64bit</td> <td>5 characters</td> <td>10 characters</td> </tr> <tr> <td>WEP 128bit</td> <td>13 characters</td> <td>26 characters</td> </tr> </tbody> </table>	Encryption	ASCII characters	HEX numbers	WEP 64bit	5 characters	10 characters	WEP 128bit	13 characters	26 characters
Encryption	ASCII characters	HEX numbers								
WEP 64bit	5 characters	10 characters								
WEP 128bit	13 characters	26 characters								
WPA Passphrase	Input WPA Passphrase. Available number of input characters is 8 to 63. Only alphabets, numbers and following symbols can be used. !"#%&'()*+,-./:;<=>?@[\] ^ _ ` { } ~ and space									
SSID	Select an SSID from the list. If you require to set your unique SSID, select [Custom] , then set your own SSID following the rules below. Maximum number of input characters is 32. Only alphabets, numbers and following symbols can be used. !"#%&'()*+,-./:;<=>?@[\] ^ _ ` { } ~ and space.									

(continued on next page)

3.1 Projector Web Control - Network Settings (continued)

Item	Description
Wired Setup	Configures the wired LAN settings.
IP Configuration	Configures network settings.
DHCP ON	Enables DHCP.
DHCP OFF	Disables DHCP.
IP Address	Configures the IP address when DHCP is disabled.
Subnet Mask	Configures the subnet mask when DHCP is disabled.
Default Gateway	Configures the default gateway when DHCP is disabled.
DNS Server Address	Configures the DNS server address.
Other Setup	Configures other network settings.
Crestron e-Control	Set whether to or not to use Crestron e-Control®. If you choose Disable, the Logon window of Projector Web Control and not the selection window will be displayed at first of the Web Control.

Click the **[Apply]** button to save the settings.

- NOTE** • The new configuration settings are activated after restarting the network connection. When the configuration settings are changed, you must restart the network connection. You can restart the network connection from **Network Restart** on the main menu. (📖42)
- If you connect the projector to an existing network, consult a network administrator before setting server addresses.
 - The WEP Key, WPA passphrase and SSID settings will not be set if the invalid characters are used.
 - The projector does not allow both wireless and wired LAN to be connected to the same network. Do not set the same network address for both wireless and wired LAN.

3.1 Projector Web Control (continued)

3.1.4 Port Settings

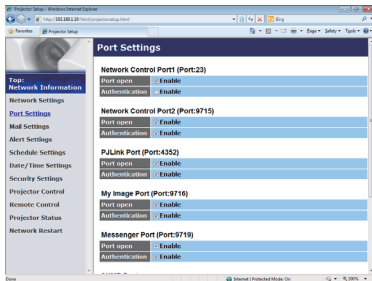

Displays and configures communication port settings.

Item	Description
Network Control Port1 (Port:23)	Configures command control port 1 (Port:23).
Port open	Click the [Enable] check box to use port 23.
Authentication	Click the [Enable] check box when authentication is required for this port.
Network Control Port2 (Port:9715)	Configures command control port 2 (Port:9715).
Port open	Click the [Enable] check box to use port 9715.
Authentication	Click the [Enable] check box when authentication is required for this port.
PJLink™ Port (Port:4352)	Configures the PJLink™ port (Port:4352).
Port open	Click the [Enable] check box to use port 4352.
Authentication	Click the [Enable] check box when authentication is required for this port.
My Image Port (Port:9716)	Configures the My Image Port (Port:9716).
Port open	Click the [Enable] check box to use port 9716.
Authentication	Click the [Enable] check box when authentication is required for this port.
Messenger Port (Port:9719)	Configures the Messenger Port (Port:9719).
Port open	Click the [Enable] check box to use port 9719.
Authentication	Click the [Enable] check box when authentication is required for this port.

(continued on next page)

3.1 Projector Web Control - Port Settings (continued)

Item	Description
SNMP Port	Configures the SNMP port.
Port open	Click the [Enable] check box to use SNMP.
Trap address	Configures the destination of the SNMP Trap in IP format. • The address allows not only IP address but also domain name if the valid DNS server is setup in the Network Settings . The maximum length of host or domain name is up to 255 characters.
Download MIB file	Downloads a MIB file from the projector.
Network Bridge Port	Configures the Bridge port number.
Port number	Input the port number. Except for 41794, 9715, 9716, 9719, 9720, 5900, 5500, 4352 between 1024 and 65535 can be set up. It is set to 9717 as the default setting.

Click the **[Apply]** button to save the settings.

NOTE • The new configuration settings are activated after restarting the network connection. When the configuration settings are changed, you must restart the network connection. You can restart the network connection from **Network Restart** on the main menu. (📖42)

3.1 Projector Web Control (continued)

3.1.5 Mail Settings

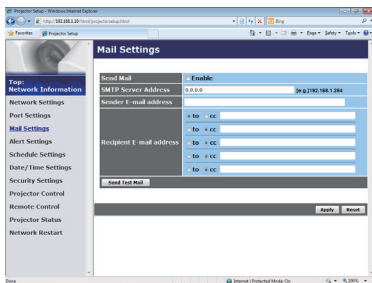

Displays and configures e-mail addressing settings.

Item	Description
Send Mail	Click the [Enable] check box to use the e-mail function. Configure the conditions for sending e-mail under the Alert Settings .
SMTP Server Address	Configures the address of the mail server in IP format. <ul style="list-style-type: none"> The address allows not only IP address but also domain name if the valid DNS server is setup in the Network Settings. The maximum length of host or domain name is up to 255 characters.
Sender E-mail address	Configures the sender e-mail address. The length of the sender e-mail address can be up to 255 alphanumeric characters.
Recipient E-mail address	Configures the e-mail address of up to five recipients. You can also specify the [to] or [cc] for each address. The length of the recipient e-mail address can be up to 255 alphanumeric characters.

Click the **[Apply]** button to save the settings.

NOTE • You can confirm whether the mail settings work correctly using the **[Send Test Mail]** button. Please enable Send mail setting before clicking the **[Send Test Mail]**.

• If you connect the projector to an existing network, consult a network administrator before setting server addresses.

3.1 Projector Web Control (continued)

3.1.6 Alert Settings

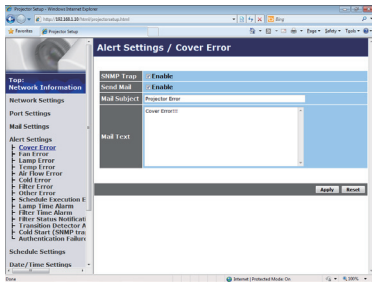

Displays and configures failure & alert settings.

Item	Description
Cover Error	The lamp cover has not been properly fixed.
Fan Error	The cooling fan is not operating.
Lamp Error	The lamp does not light, and there is a possibility that interior portion has become heated.
Temp Error	There is a possibility that the interior portion has become heated.
Air Flow Error	The internal temperature is rising.
Cold Error	There is a possibility that the interior portion has become overcooled.
Filter Error	Filter time over.
Other Error	Other error. If displaying this error, please contact your dealer.
Schedule Execution Error	Schedule Execution error. (📖28)
Lamp Time Alarm	Lamp time over Alarm Time setting.
Filter Time Alarm	Filter time over Alarm Time setting.
Filter Status Notification	The status to clean the air filter is changed.
Transition Detector Alarm	Transition Detector Alarm. (📖SECURITY menu in the Operating Guide)
Cold Start	When the projector is supplied with the power, it works as below. <ul style="list-style-type: none"> • If the STANDBY MODE is set to the NORMAL:the projector's power status changes from "OFF" to "Standby state". • If the STANDBY MODE is set to the SAVING:the projector's power status changes from "Standby state" to "ON (lamp is turned on)". (📖SETUP menu in the Operating Guide)
Authentication Failure	The SNMP access is detected from the invalid SNMP community.

Refer to 📖Troubleshooting in the **Operating Guide** for further detailed explanation of Error except Other Error and Schedule Execution Error.

3.1 Projector Web Control - Alert Settings (continued)

The Alert Items are shown below.

Item	Description
Alarm Time	Configures the time to alert. (Only Lamp Time Alarm and Filter Time Alarm .)
SNMP Trap	Click the [Enable] check box to enable SNMP Trap alerts.
Send Mail	Click the [Enable] check box to enable e-mail alerts. (Except Cold Start and Authentication Failure .)
Mail Subject	Configures the subject line of the e-mail to be sent. The length of the subject line can be up to 100 alphanumeric characters. Using any other character may shorten the subject line. (Except Cold Start and Authentication Failure .)
Mail Text	Configures the text of the e-mail to be sent. The length of the text is up to 1024 alphanumeric characters. Using any other character may shorten the text. (Except Cold Start and Authentication Failure .)

Click the **[Apply]** button to save the settings.

NOTE • The trigger of **Filter Error** e-mail is depending on the **FILTER MESSAGE** setting in the **SERVICE** item of the **OPTION** menu which defines the period until the filter message is displayed on the projector screen. An e-mail will be sent when the usage time of the filter exceeds the time limit that is set. No notification e-mail will be sent if the **FILTER MESSAGE** is set to **TURN OFF**. ([OPTION menu](#) in the **Operating Guide**)

- **Lamp Time Alarm** is defined as a threshold for e-mail notification (reminder) of the lamp time. When the lamp hour exceeds the limit that is configured in the Projector Web Control, an e-mail will be sent.
- **Filter Time Alarm** is defined as a threshold for e-mail notification (reminder) of the filter time. When the filter hour exceeds the limit that is configured in the Projector Web Control, an e-mail will be sent.
- **Filter Status Notification** can be enabled for both or either one of **Status 1** and **2**. These notifications are equivalent to the changing of the **FILTER** indicator on the projector. (**Status 1**: off to orange, **Status 2**: orange to red) Refer to the **Operating Guide** for details of the **FILTER** indicator.

3. Web Control

3.1 Projector Web Control (continued)

3.1.7 Schedule Settings

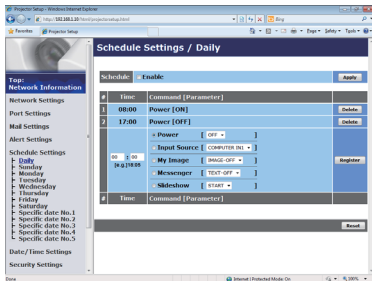

Displays and configures schedule settings.

Item	Description
Daily	Configures the daily schedule.
Sunday	Configures the Sunday schedule.
Monday	Configures the Monday schedule.
Tuesday	Configures the Tuesday schedule.
Wednesday	Configures the Wednesday schedule.
Thursday	Configures the Thursday schedule.
Friday	Configures the Friday schedule.
Saturday	Configures the Saturday schedule.
Specific date No.1	Configures the specific date (No.1) schedule.
Specific date No.2	Configures the specific date (No.2) schedule.
Specific date No.3	Configures the specific date (No.3) schedule.
Specific date No.4	Configures the specific date (No.4) schedule.
Specific date No.5	Configures the specific date (No.5) schedule.

3.1 Projector Web Control - Schedule Settings (continued)

The schedule settings are shown below.

Item	Description
Schedule	Click the [Enable] check box to enable the schedule.
Date (Month/Day)	Configures the month and date. This item appears only when Specific date (No. 1-5) is selected.

Click the **[Apply]** button to save the settings.

The current event settings are displayed on the schedule list. To add additional functions and events, set the following items.

Item	Description
Time	Configures the time to execute commands.
Command [Parameter]	Configures the commands to be executed.
Power	Configures the parameters for power control.
Input Source	Configures the parameters for input switching.
My Image	Configures the parameters for My Image data display. (52)
Messenger	Configures the parameters for Messenger data display. (53)
Slideshow	Configures the Start/Stop parameters for the Slideshow.

Click the **[Register]** button to add new commands to the schedule list.

Click the **[Delete]** button to delete commands from the schedule list.

Click the **[Reset]** button to delete all commands and reset the schedule settings from the schedule list.

3.1 Projector Web Control - Schedule Settings (continued)

- NOTE** • After the projector is moved, check the date and time set for the projector before configuring the schedules.
- The internal clock's time may not remain accurate. Using SNTP is recommended to maintain accurate time.
 - Events "**My Image**" and "**Messenger**" will not be executed appropriately but result in "schedule execution error" status in case lamp does not light or/and display data are not stored in the projector at the scheduled event execution time.
 - Events "**Input Source**" and "**My Image**" will not be executed if security feature is enabled and the projector is locked due to the feature.
 - Certain error state in the projector (such as temperature error, lamp error) will prevent the projector from appropriate execution of scheduled functions/events.
 - If no USB memory device is inserted to the projector or no image data for display exists at the scheduled event time, a schedule execution error occurs against the scheduled Slideshow event.
 - When you start the Slideshow, input source will be automatically switched to the **USB TYPE A**.
 - Image files stored in the root directory of the USB memory device will be displayed for the scheduled Slideshow.
 - Please refer to [🔗](#) **Troubleshooting** in the **Operating Guide** in case scheduled functions/events are not executed appropriately as you've set.

3.1 Projector Web Control (continued)

3.1.8 Date/Time Settings

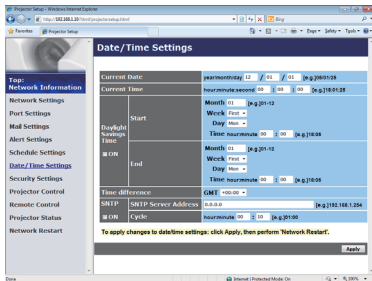

Displays and configures the date and time settings.

Item	Description				
Current Date	Configures the current date in year/month/day format.				
Current Time	Configures the current time in hour:minute:second format.				
Daylight Savings Time	Click the [ON] check box to enable daylight savings time and set the following items.				
Start	Configures the date and time daylight savings time begins.				
Month	Configures the month daylight savings time begins (1~12).				
Week	Configures the week of the month daylight savings time begins (First, 2, 3, 4, Last).				
Day	Configures the day of the week daylight savings time begins (Sun, Mon, Tue, Wed, Thu, Fri, Sat).				
Time	<table border="1"> <tr> <td>hour</td> <td>Configures the hour daylight savings time begins (0 ~ 23).</td> </tr> <tr> <td>minute</td> <td>Configures the minute daylight savings time begins (0 ~ 59).</td> </tr> </table>	hour	Configures the hour daylight savings time begins (0 ~ 23).	minute	Configures the minute daylight savings time begins (0 ~ 59).
hour	Configures the hour daylight savings time begins (0 ~ 23).				
minute	Configures the minute daylight savings time begins (0 ~ 59).				
End	Configures the date and time daylight savings time ends.				
Month	Configures the month daylight savings time ends (1 ~ 12).				
Week	Configures the week of the month daylight savings time ends (First, 2, 3, 4, Last).				
Day	Configures the day of the week daylight savings time ends (Sun, Mon, Tue, Wed, Thu, Fri, Sat).				
Time	<table border="1"> <tr> <td>hour</td> <td>Configures the hour daylight savings time ends (0 ~ 23).</td> </tr> <tr> <td>minute</td> <td>Configures the minute daylight savings time ends (0 ~ 59).</td> </tr> </table>	hour	Configures the hour daylight savings time ends (0 ~ 23).	minute	Configures the minute daylight savings time ends (0 ~ 59).
hour	Configures the hour daylight savings time ends (0 ~ 23).				
minute	Configures the minute daylight savings time ends (0 ~ 59).				

(continued on next page)

3.1 Projector Web Control - Date/Time Settings (continued)

Item	Description
Time difference	Configures the time difference. Set the same time difference as the one set on your computer. If unsure, consult your IT manager.
SNTP	Click the [ON] check box to retrieve Date and Time information from the SNTP server and set the following items.
SNTP Server Address	Configures the SNTP server address in IP format. • The address allows not only IP address but also domain name if the valid DNS server is setup in the Network Settings . The maximum length of host or domain name is up to 255 characters.
Cycle	Configures the interval at which to retrieve Date and Time information from the SNTP server (hour:minute).

Click the **[Apply]** button to save the settings.

NOTE • The new configuration settings are activated after restarting the network connection. When the configuration settings are changed, you must restart the network connection. You can restart the network connection from **Network Restart** on the main menu. (🔗42)

- If you connect the projector to an existing network, consult a network administrator before setting server addresses.
- Once you turn off the projector in the SAVING mode (🔗SETUP menu in the **Operating Guide**) or the AC power, the current date and time setting is reset.
- To enable the SNTP function, the time difference must be set.
- The projector will retrieve Date and Time information from the time server and override time settings when SNTP is enabled.
- The internal clock's time may not remain accurate. Using SNTP is recommended to maintain accurate time.

3.1 Projector Web Control (continued)

3.1.9 Security Settings

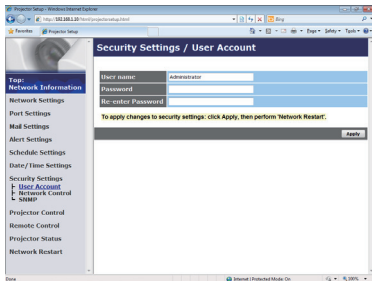

Displays and configures passwords and other security settings.

Item	Description
User Account	Configures the user name and password.
User name	Configures the user name. The length of the text can be up to 32 alphanumeric characters.
Password	Configures the password. The length of the text can be up to 255 alphanumeric characters.
Re-enter Password	Reenter the above password for verification.
Network Control	Configures the Authentication password for Network Control Port1 (Port: 23) , Network Control Port2 (Port: 9715) , PJLink™ Port (Port: 4352) , My Image Port (Port: 9716) , and Messenger Port (Port: 9719) . (📖23, 24)
Authentication Password	Configures the Authentication password. The length of the text can be up to 32 alphanumeric characters.
Re-enter Authentication Password	Reenter the above password for verification.
SNMP	Configures the community name if SNMP is used.
Community name	Configures the community name. The length of the text can be up to 64 alphanumeric characters.

Click the **[Apply]** button to save the settings.

NOTE • The new configuration settings are activated after restarting the network connection. When the configuration settings are changed, you must restart the network connection. You can restart the network connection from **Network Restart** on the main menu. (📖42)

- Only numbers '0-9' and alphabet 'a-z', 'A-Z' can be used.

3. Web Control

3.1 Projector Web Control (continued)

3.1.10 Projector Control

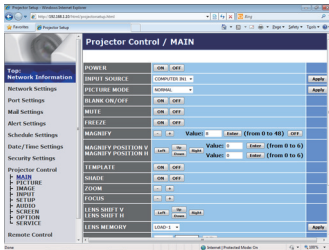

Operations of the projector can be performed with the items on the screen. The categories of the items are shown in the main menu. Most of the items have a submenu. Refer to the table below for details.

NOTE • The setting value may not match with the actual value if the user changes the value manually. In that case, please refresh the page by clicking the [Refresh] button.

Item	Description
MAIN	
POWER	Turns the power on/off.
INPUT SOURCE	Selects the input source.
PICTURE MODE	Selects the picture mode setting.
BLANK ON/OFF	Turns the BLANK screen on/off.
MUTE	Turns the audio mute on/off.
FREEZE	Turns Freeze on/off.
MAGNIFY	Controls the magnify setting. In some input signal sources, it might stop “Magnify” even though it does not reach to maximum setting value.
MAGNIFY POSITION V	Adjusts the vertical magnify position.
MAGNIFY POSITION H	Adjusts the horizontal magnify position.
TEMPLATE	Turns template on/off.
SHADE	Turns the lens shade on(closed)/off(opened).
ZOOM	Adjusts the zoom setting.
FOCUS	Adjusts the focus setting.
LENS SHIFT V	Adjusts the vertical lens shift.
LENS SHIFT H	Adjusts the horizontal lens shift.
LENS MEMORY	Saves, Loads or Clears the lens memory data.
WINDOW CONFIGURATION	Selects the setting of the configuration of 2 windows.
MY IMAGE	Selects MY IMAGE data.
MY IMAGE DELETE	Deletes MY IMAGE data.

(continued on next page)

3.1 Projector Web Control - Projector Control (continued)

Item	Description
PICTURE	
BRIGHTNESS	Adjusts the brightness setting.
CONTRAST	Adjusts the contrast setting.
GAMMA	Selects the gamma setting.
COLOR TEMP	Selects the color temperature setting.
COLOR	Adjusts the color setting.
TINT	Adjusts the tint setting.
SHARPNESS	Adjusts the sharpness setting.
ACCENTUALIZER	Adjusts the ACCENTUALIZER setting.
ACTIVE IRIS	Selects the active iris setting.
MYMEMORY SAVE	Saves the MyMemory data.
MYMEMORY RECALL	Recalls the MyMemory data.
IMAGE	
ASPECT	Selects the aspect setting.
OVER SCAN	Adjusts the over scan setting.
V POSITION	Adjusts the vertical position.
H POSITION	Adjusts the horizontal position.
H PHASE	Adjusts the horizontal phase.
H SIZE	Adjusts the horizontal size.
AUTO ADJUST EXECUTE	Performs the automatic adjustment.
INPUT	
PROGRESSIVE	Selects the progressive setting.
VIDEO NR	Selects the video noise reduction setting.
COLOR SPACE	Selects the color space.
COMPONENT	Selects the COMPONENT port setting.
VIDEO FORMAT - S-VIDEO	Selects the s-video format setting.
VIDEO FORMAT - VIDEO	Selects the video format setting.
HDMI FORMAT - HDMI 1	Selects the HDMI™ format setting of the HDMI 1 port.
HDMI FORMAT - HDMI 2	Selects the HDMI™ format setting of the HDMI 2 port.
HDMI RANGE - HDMI 1	Selects the HDMI™ range setting of the HDMI 1 port.
HDMI RANGE - HDMI 2	Selects the HDMI™ range setting of the HDMI 2 port.

(continued on next page)

3.1 Projector Web Control - Projector Control (continued)

Item	Description
INPUT (continued)	
COMPUTER IN - COMPUTER IN1	Selects the COMPUTER IN1 input signal type.
COMPUTER IN - COMPUTER IN2	Selects the COMPUTER IN2 input signal type.
FRAME LOCK - COMPUTER IN1	Turns the FRAME LOCK-COMPUTER IN1 function on/off.
FRAME LOCK - COMPUTER IN2	Turns the FRAME LOCK-COMPUTER IN2 function on/off.
FRAME LOCK - HDMI 1	Turns the FRAME LOCK-HDMI 1 function on/off.
FRAME LOCK - HDMI 2	Turns the FRAME LOCK-HDMI 2 function on/off.
SETUP	
AUTO KEYSTONE EXECUTE	Performs the automatic keystone distortion setting.
KEYSTONE V	Adjusts the vertical keystone distortion setting.
KEYSTONE H	Adjusts the horizontal keystone distortion setting.
PERFECT FIT	Adjusts the shape of the projected image in each of the corners and sides.
AUTO ECO MODE	Turns on/off the automatic eco mode function.
ECO MODE	Selects the eco mode.
INSTALLATION	Selects the installation status.
STANDBY MODE	Selects the standby mode.
MONITOR OUT - COMPUTER IN1	Assigns the MONITOR OUT when the COMPUTER IN1 input port is selected.
MONITOR OUT - COMPUTER IN2	Assigns the MONITOR OUT when the COMPUTER IN2 input port is selected.
MONITOR OUT - LAN	Assigns the MONITOR OUT when the LAN input port is selected.
MONITOR OUT - USB TYPE A	Assigns the MONITOR OUT when the USB TYPE A input port is selected.
MONITOR OUT - USB TYPE B	Assigns the MONITOR OUT when the USB TYPE B input port is selected.
MONITOR OUT - HDMI 1	Assigns the MONITOR OUT when the HDMI 1 input port is selected.
MONITOR OUT - HDMI 2	Assigns the MONITOR OUT when the HDMI 2 input port is selected.
MONITOR OUT - COMPONENT	Assigns the MONITOR OUT when the COMPONENT input port is selected.
MONITOR OUT - S-VIDEO	Assigns the MONITOR OUT when the S-VIDEO input port is selected.
MONITOR OUT - VIDEO	Assigns the MONITOR OUT when the VIDEO input port is selected.
MONITOR OUT - STANDBY	Assigns the MONITOR OUT in the standby mode.

(continued on next page)

3.1 Projector Web Control - Projector Control (continued)

Item	Description
AUDIO	
VOLUME	Adjusts the volume setting.
AUDIO SOURCE - COMPUTER IN1	Assigns the AUDIO SOURCE - COMPUTER IN1 input port.
AUDIO SOURCE - COMPUTER IN2	Assigns the AUDIO SOURCE - COMPUTER IN2 input port.
AUDIO SOURCE - LAN	Assigns the AUDIO SOURCE - LAN input port.
AUDIO SOURCE - USB TYPE A	Assigns the AUDIO SOURCE - USB TYPE A input port.
AUDIO SOURCE - USB TYPE B	Assigns the AUDIO SOURCE - USB TYPE B input port.
AUDIO SOURCE - HDMI 1	Assigns the AUDIO SOURCE - HDMI 1 input port.
AUDIO SOURCE - HDMI 2	Assigns the AUDIO SOURCE - HDMI 2 input port.
AUDIO SOURCE - COMPONENT	Assigns the AUDIO SOURCE - COMPONENT input port.
AUDIO SOURCE - S-VIDEO	Assigns the AUDIO SOURCE - S-VIDEO input port.
AUDIO SOURCE - VIDEO	Assigns the AUDIO SOURCE - VIDEO input port.
AUDIO SOURCE - AUDIO OUT STANDBY	Assigns the AUDIO SOURCE in the standby mode.
SCREEN	
LANGUAGE	Selects the language for the OSD.
MENU POSITION V	Adjusts the vertical Menu position.
MENU POSITION H	Adjusts the horizontal Menu position.
BLANK	Selects the BLANK screen.
AUTO BLANK	Selects the AUTO BLANK color.
START UP	Selects the start up screen mode.
MyScreen Lock	Turns MyScreen lock function on/off.
MESSAGE	Turns the message function on/off.
TEMPLATE	Selects the template setting.
C.C. - DISPLAY	Selects Closed Caption DISPLAY setting.
C.C. - MODE	Selects Closed Caption MODE setting.
C.C. - CHANNEL	Selects Closed Caption CHANNEL setting.

(continued on next page)

3.1 Projector Web Control - Projector Control (continued)

Item	Description
OPTION	
SOURCE SKIP - COMPUTER IN1	Selects the Source Skip - COMPUTER IN1 setting.
SOURCE SKIP - COMPUTER IN2	Selects the Source Skip - COMPUTER IN2 setting.
SOURCE SKIP - LAN	Selects the Source Skip - LAN setting.
SOURCE SKIP - USB TYPE A	Selects the Source Skip - USB TYPE A setting.
SOURCE SKIP - USB TYPE B	Selects the Source Skip - USB TYPE B setting.
SOURCE SKIP - HDMI 1	Selects the Source Skip - HDMI 1 setting.
SOURCE SKIP - HDMI 2	Selects the Source Skip - HDMI 2 setting.
SOURCE SKIP - COMPONENT	Selects the Source Skip - COMPONENT setting.
SOURCE SKIP - S-VIDEO	Selects the Source Skip - S-VIDEO setting.
SOURCE SKIP - VIDEO	Selects the Source Skip - VIDEO setting.
AUTO SEARCH	Turns the automatic signal search function on/off.
AUTO KEYSTONE	Turns the automatic keystone distortion correction function on/off.
DIRECT POWER ON	Turns the direct power on function on/off.
AUTO POWER OFF	Configures the timer to shut off the projector when no signal is detected.
SHADE TIMER	Selects the shade timer setting.
USB TYPE B	Selects the USB TYPE B setting.
MY BUTTON-1	Assigns the functions for the MY BUTTON-1 button on the included remote control.
MY BUTTON-2	Assigns the functions for the MY BUTTON-2 button on the included remote control.
MY BUTTON-3	Assigns the functions for the MY BUTTON-3 button on the included remote control.
MY BUTTON-4	Assigns the functions for the MY BUTTON-4 button on the included remote control.

(continued on next page)

3.1 Projector Web Control - Projector Control (continued)

Item	Description
OPTION (continued)	
REMOTE RECEIV. - FRONT	Turns the remote receiv. front function on/off.
REMOTE RECEIV. - REAR	Turns the remote receiv. rear function on/off.
REMOTE FREQ. - NORMAL	Turns the remote control signal frequency normal function on/off.
REMOTE FREQ. - HIGH	Turns the remote control signal frequency high function on/off.
REMOTE ID	Selects Remote ID setting.

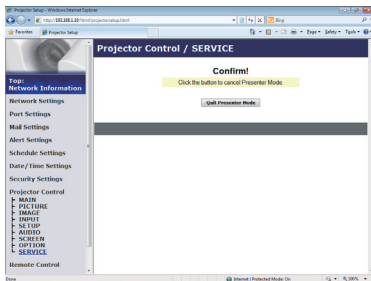

This item is performed when the button is clicked without showing another confirmation message. Click the **[Quit Presenter Mode]**.

Item	Description
SERVICE	
Quit Presenter Mode	Quit compulsorily from the Presenter mode.

3.1 Projector Web Control (continued)

3.1.11 Remote Control

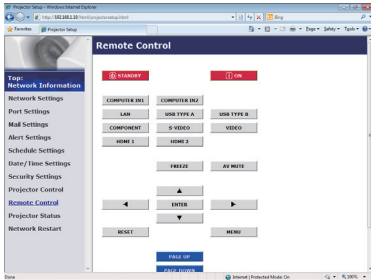

The functions on the bundled remote control are assigned to the Web Remote Control screen.

Do not attempt to control the projector with the projector's remote control and via Web Remote Control at the same time. It may cause some operational errors in the projector.

Item	Description
STANDBY	Assigned the same operation as STANDBY button.
ON	Assigned the same operation as ON button.
COMPUTER IN1	Assigned the same operation as COMPUTER IN1 button.
COMPUTER IN2	Assigned the same operation as COMPUTER IN2 button.
LAN	Assigned the same operation as LAN button.
USB TYPE A	Assigned the same operation as USB TYPE A button.
USB TYPE B	Assigned the same operation as USB TYPE B button.
COMPONENT	Assigned the same operation as COMPONENT button.
S-VIDEO	Assigned the same operation as S-VIDEO button.
VIDEO	Assigned the same operation as VIDEO button.
HDMI 1	Assigned the same operation as HDMI 1 button.
HDMI 2	Assigned the same operation as HDMI 2 button.
FREEZE	Assigned the same operation as FREEZE button.
AV MUTE	Assigned the same operation as AV MUTE button.
▲	Assigned the same operation as ▲ button.
▼	Assigned the same operation as ▼ button.
◀	Assigned the same operation as ◀ button.
▶	Assigned the same operation as ▶ button.
ENTER	Assigned the same operation as ENTER button.
MENU	Assigned the same operation as MENU button.
RESET	Assigned the same operation as RESET button.
PAGE UP	Assigned the same operation as PAGE UP button.
PAGE DOWN	Assigned the same operation as PAGE DOWN button.
SLIDESHOW	Starts the Slideshow.

(continued on next page)

3.1 Projector Web Control - Remote Control (continued)

- NOTE** • The Web Remote Control does not support repeat function that performs an action while holding a button clicked down.
- Since the repeat function is not available, click the button repeatedly as many times as you require.
 - Even if you hold the button clicked down for a while, the Web Remote Control sends your request command one time only. Release the button, then click it again.
 - When the **[STANDBY]** or **[ON]** button is pushed, a message window comes up to confirm the operation. To control the power, push **[OK]**, otherwise push **[Cancel]**.

3. Web Control

3.1 Projector Web Control (continued)

3.1.12 Projector Status

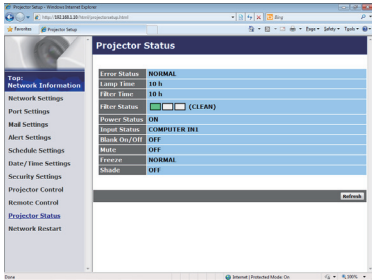

Displays the settings and status of the projector.

Item	Description
Error Status	Displays the current error status.
Lamp Time	Displays the usage time for the current lamp.
Filter Time	Displays the usage time for the current filter.
Filter Status	Displays the current cleanliness level of the air filter.
Power Status	Displays the current power status.
Input Status	Displays the current input signal source.
Blank On/Off	Displays the current BLANK screen on/off status.
Mute	Displays the current audio mute on/off status.
Freeze	Displays the current Freeze status.
Shade	Displays the current Shade status.

3.1.13 Network Restart

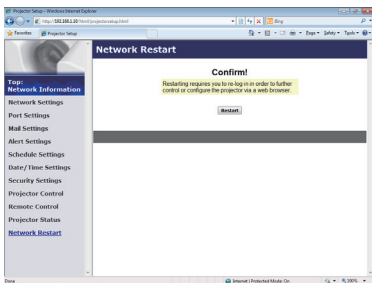

Restarts the projector's network connection.

Item	Description
Restart	Restarts the projector's network connection in order to activate new configuration settings.

NOTE • Restarting requires you to re-log on in order to further control or configure the projector via a web browser. Wait 30 seconds or more after clicking the **[Restart]** button to log on again.

3.2 Crestron e-Control®



The Main window as shown above is displayed at first. However, if you have enabled User Password on the Tools window (📖48), a dialog prompting you to enter the password as shown on the right will be displayed, and no operation is enabled until you have entered the password. After entering the preset password, the dialog disappears and the Main window will be displayed. As shown below, you can open a window by clicking the corresponding tab at the top right of the window.

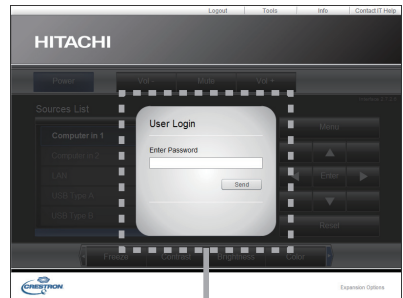

User Password dialog

Tab	Description
Logout	Logs out from e-Control®. This tab appears only when User Password of the Tools window is enabled.
Tools	Opens Tools window. (📖47)
Info	Opens Info window. (📖49)
Contact IT Help	Opens Help Desk window. (📖50)

3.2 Crestron e-Control® (continued)

NOTE • If **Crestron e-Control®** in the **Network Settings** (📖22) is set to Disable, Crestron e-Control® cannot be used to operate the projector. Enable Crestron e-Control® and close the web browser. Next, restart the web browser, followed by entering the projector's IP address.

- Only English is supported on Crestron e-Control®.
- If the connection is terminated, the "Loading..." screen will appear. Check the connection between the projector and the computer, then return or refresh the Web page.

3.2 Crestron e-Control® (continued)

3.2.1 Main window

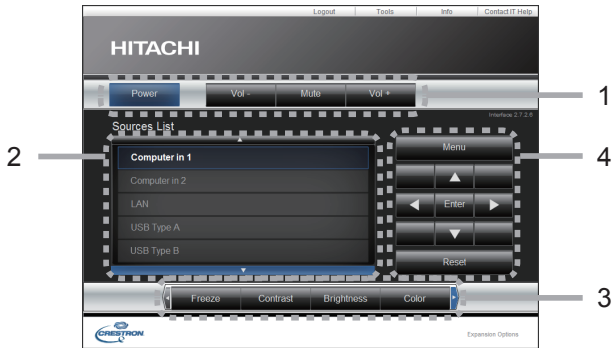

You can operate the basic controls of the projector on this screen.

NOTE • If the projector is in the standby mode, only the **[Power]** button can be operated.

1 Click a button and operate as follows.

Button	Description
Power	Turns the power on/off.
Vol - / Vol +	Adjusts the volume setting of the audio output.
Mute	Turns the audio mute on/off.

2 Sources List

You can click a button to switch the input channel. The cursor will move according to the currently selected input port.

Button	Description
Computer in1	Selects input from COMPUTER IN1 port.
Computer in2	Selects input from COMPUTER IN2 port.
LAN	Selects input from LAN port.
USB Type A	Selects input from USB TYPE A ports.
USB Type B	Selects input from USB TYPE B port.
HDMI 1	Selects input from HDMI 1 port.
HDMI 2	Selects input from HDMI 2 port.
Component	Selects input from COMPONENT port.
S-Video	Selects input from S-VIDEO port.
Video	Selects input from VIDEO port.

3.2 Crestron e-Control® - Main window (continued)

3 Click a button and operate as follows. To show the hidden buttons, click the ◀ / ▶ icons at the left and right ends.

Button	Description
Freeze	Turns Freeze on/off.
Contrast	Adjusts the contrast setting.
Brightness	Adjusts the brightness setting.
Color	Adjusts the color setting.
Sharpness	Adjusts the sharpness setting.
Magnify	Controls the magnification setting using the [+] / [-] buttons. Use the [▲] [▼] [◀] [▶] buttons to move to the area you want to magnify.
Auto	Performs the automatic adjustment.
Blank	Turns the BLANK screen on/off.

4 Click the button and operate in the same way as the bundled remote control.

Button	Description
Menu	Assigned the same operation as MENU button.
Enter	Assigned the same operation as ENTER button.
Reset	Assigned the same operation as RESET button.
▲	Assigned the same operation as ▲ button.
▼	Assigned the same operation as ▼ button.
◀	Assigned the same operation as ◀ button.
▶	Assigned the same operation as ▶ button.

3.2 Crestron e-Control® (continued)

3.2.2 Tools window

Configures the settings between the projector and Crestron® control system. Click the **[Exit]** button to return to the Main window.

- NOTE**
- If two-byte characters are used, the input text or numbers cannot be set correctly.
 - All items on this window cannot be left blank.

1 Crestron® Control

Configures the settings of Crestron® control system devices.

Item	Description
IP Address	Configures the IP address of the control system.
IP ID	Configures the IP ID of the control system.
Port	Specifies the port number used for communication by the control system.

To apply the settings, click the **[Send]** button.

2 Projector

Configures the network settings of the projector.

Item	Description
Projector Name	Configures the name of the projector. The length of the Projector Name can be up to 64 alphanumeric characters.
Location	Configures the location name of the projector. You can specify a Location name up to 32 alphanumeric characters.
Assigned To:	Configures the user name for the projector. You can specify a user name up to 32 alphanumeric characters.

The usable symbols are space and the following: !"#%&'()*+,-./:;<=>?[^_`{|}~

To apply the settings, click the **[Send]** button.

3.2 Crestron e-Control® - Tools window (continued)

3 Projector (continued)

Configures the network settings of the projector.

Item	Description
DHCP	Enables DHCP.
IP Address	Configures the IP address when DHCP is disabled.
Subnet Mask	Configures the subnet mask when DHCP is disabled.
Default Gateway	Configures the default gateway when DHCP is disabled.
DNS Server	Configures the DNS server address when DHCP is disabled.

To apply the settings, click the **[Send]** button.

4 User Password

Configures the User Password. To prompt the entry of User Password before starting e-Control®, select the checkbox.

Item	Description
New Password	Configures the password. You can specify a password up to 26 alphanumeric characters. The usable symbols are space and the following: !"#\$%&'()*+,-./:;<=>?@[\\]^_`{ }~
Confirm	Reenter the above password for verification. If the password is incorrect, an error message is displayed.

To apply the settings, click the **[Send]** button.

5 Admin Password

Configures the Admin Password. To prompt the entry of Admin Password before displaying the Tools window, select the checkbox.

Item	Description
New Password	Configures the password. You can specify a password up to 26 alphanumeric characters. The usable symbols are space and the following: !"#\$%&'()*+,-./:;<=>?@[\\]^_`{ }~
Confirm	Reenter the above password for verification. If the password is incorrect, an error message is displayed.

To apply the settings, click the **[Send]** button.

3.2 Crestron e-Control® (continued)

3.2.3 Info window

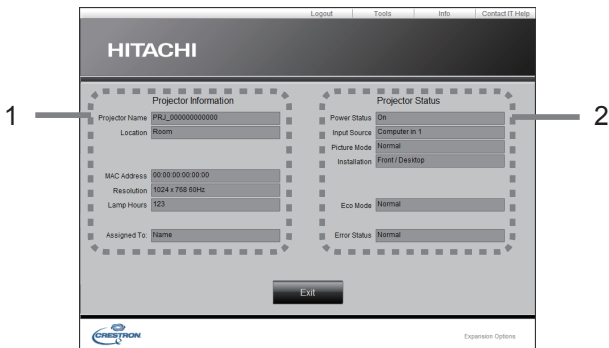

Displays the settings and status of the projector.
Click the **[Exit]** button to return to the Main window.

1 Projector Information

Item	Description
Projector Name	Displays the projector name settings.
Location	Displays the location name of the projector.
MAC Address	Displays the wired LAN MAC address of the projector.
Resolution	Displays the resolution and vertical frequency of the signal input selected on the projector.
Lamp Hours	Displays the usage time for the current lamp.
Assigned To:	Displays the user name for the projector.

2 Projector Status

Item	Description
Power Status	Displays the current power status.
Input Source	Displays the current input signal source.
Picture Mode	Displays the current picture mode setting.
Installation	Displays the current installation setting.
Eco Mode	Displays the current eco mode setting.
Error Status	Displays the current error status.

NOTE • Projector Name, Location and the user name for Assigned To: may appear truncated if they are too long.

3.2 Crestron e-Control® (continued)

3.2.4 Help Desk window



Sends/receives messages to/from the administrator for Crestron RoomView® Express.

Button	Description
Send	Sends a message.
	Check the received message.

3.2 Crestron e-Control® (continued)

3.2.5 Emergency Alert

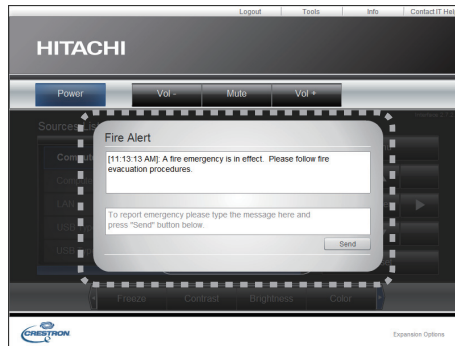

When the administrator for Crestron RoomView® Express sends out an alert message, it will be displayed on the screen.

You can reply to the alert message via a chat format. Input a message in the box below the alert message, and click the **[Send]** button.

NOTE • For details of Emergency Alert, refer to the manual of Crestron RoomView® Express.

- The alert message from Crestron RoomView® is displayed on the screen of the projector in a way similar to the real-time text of the Messenger function. (53) If another real-time text is currently being displayed, it will be overwritten by the alert message. However, if the priority of the real-time text is set to high, it will not be overwritten by the alert message, and the latter will not appear on the screen of the projector. For details, refer to the manual for the application of the Messenger.

4. My Image Function

4. My Image Function

The projector can display still images that are transferred via the network.

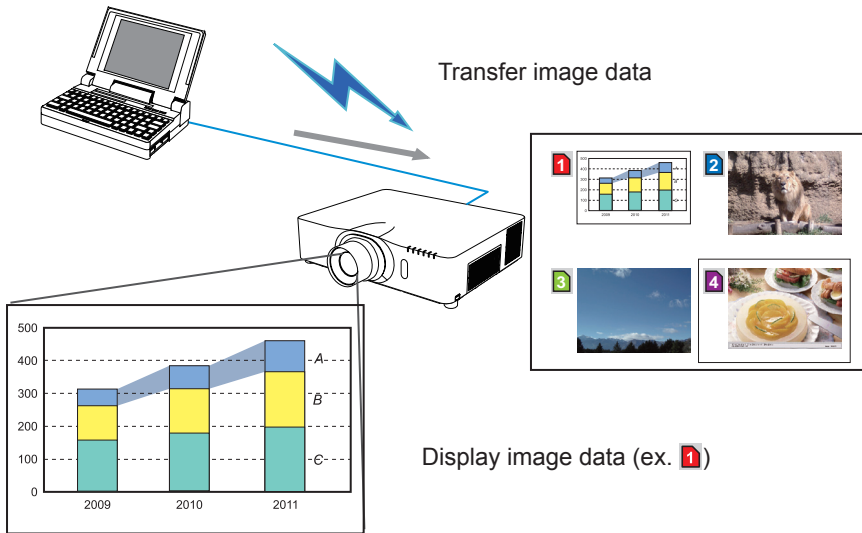

MY IMAGE transmission requires an exclusive application for your computer.

Use the application to transfer the image data.

It can be downloaded from the Hitachi web site (<http://www.hitachi-america.us/projectors> or <http://www.hitachidigitalmedia.com>).

For information on the necessary settings and operations for the computer and projector, refer to the manual for the application.

To display the transferred image, select the MY IMAGE item in the NETWORK menu. For more information, please see the description of the MY IMAGE item of the NETWORK menu. (📖 **NETWORK menu** in the **Operating Guide**)

NOTE • It is possible to allocate the image file up to 4 in the maximum.

- Using **MY BUTTON** that registered MY IMAGE can display transferred image. (📖 **OPTION menu** in the **Operating Guide**)

- The image file also can be displayed by using schedule function from the web browser. Refer to item **7.3 Event Scheduling** (📖 **61**) in detail.

- If you display MY IMAGE data on screen while you are using the USB Display function, the application for the USB Display will be closed. To restart the application, exit the MY IMAGE function, and then the software in the projector, LiveViewerLiteForUSB.exe, will run again. (📖 **USB Display** in the **Operating Guide**)

- If data is transferred via wireless and wired LAN at the same time, the projector may not be able to process the data correctly.

5. Messenger Function

The projector can display text data transferred via the network on the screen and play back audio data inside the projector.

The text data can be displayed on the screen in two ways that displays the text transferred from the computer on real time, and the other chooses and displays the text data from the ones once stored in the projector.

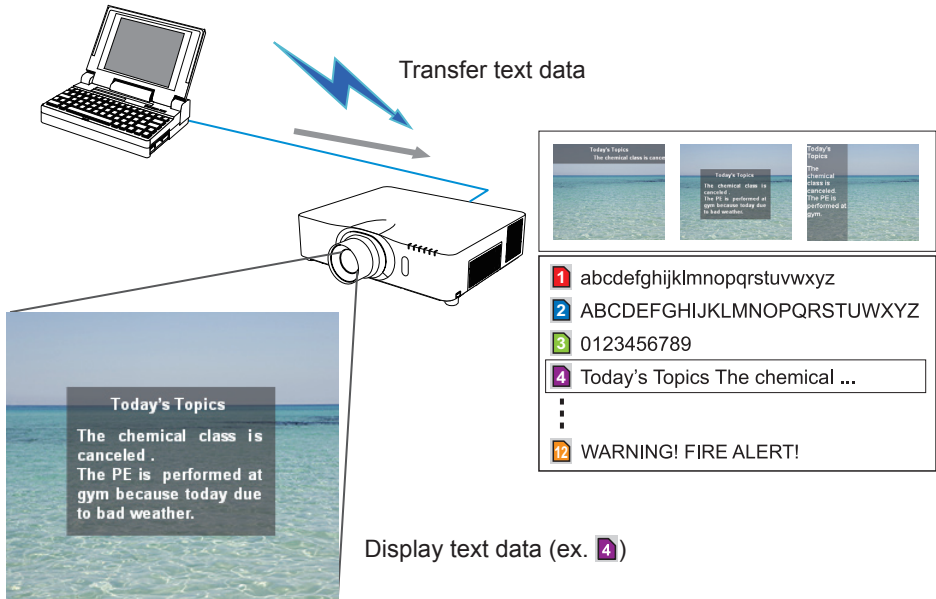

Messenger function requires an exclusive application for your computer. To edit, transfer and display the text data, use the application. You can download it from the Hitachi web site (<http://www.hitachi-america.us/projectors> or <http://www.hitachidigitalmedia.com>). For information on the necessary settings and operations for the computer and projector, refer to the manual for the application.

- NOTE** • It is possible to store the text data up to 12 in the maximum.
- Using **MY BUTTON** that registered MESSANGER can turn the displaying messenger text on/off. (**OPTION menu** in the **Operating Guide**)
 - The text file also can be displayed by using schedule function via the web browser. Refer to item **7.3 Event Scheduling** (**61**) for the detail.
 - If data is transferred via wireless and wired LAN at the same time, the projector may not be able to process the data correctly.

6. Network Bridge Function

This projector is equipped with the NETWORK BRIDGE function to perform mutual conversion of a network protocol and a serial interface.

By making use of the NETWORK BRIDGE function, a computer that is connected to the projector via wireless or wired LAN is able to control an external device via RS-232C communication using the projector as a network terminal.

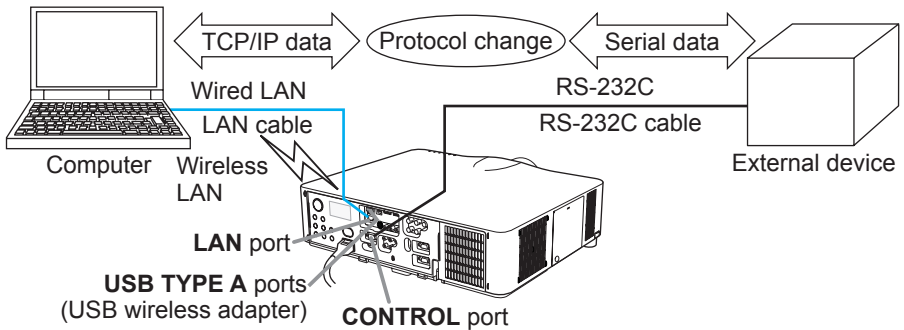

6.1 Connecting devices

- 1) Connect the projector's **LAN** port to the computer's LAN port with a LAN cable, or insert the USB wireless adapter into one of the **USB TYPE A** ports.
- 2) Connect the projector's **CONTROL** port and the device's RS-232C port with an RS-232C cable, for RS-232C communication.

NOTE • Before connecting the devices, read the manuals for the devices to ensure the connection. For RS-232C connection, check the specifications of each port and use the suitable cable. (📖 **Connection to the ports** in the **Operating Guide - Technical**)

6.2 Communication setup

To configure the setup of the communication using NETWORK BRIDGE for the projector, use items in the COMMUNICATION menu. Open the menu of the projector and select the OPTION - SERVICE - COMMUNICATION menu.

( **OPTION menu > SERVICE > COMMUNICATION** in the **Operating Guide**)

- 1) In the COMMUNICATION TYPE menu, select NETWORK BRIDGE (WIRELESS or WIRED depending on the type of connection you use) for the **CONTROL** port.
- 2) Using the SERIAL SETTINGS menu, select the proper baud rate and parity for the **CONTROL** port, according to the specification of the RS-232C port of the connected device.

Item	Condition
BAUD RATE	4800bps/9600bps/19200bps/38400bps
PARITY	NONE/ODD/EVEN
Data length	8 bit (fixed)
Start bit	1 bit (fixed)
Stop bit	1 bit (fixed)

- 3) Using the TRANSMISSION METHOD menu, set up the proper method for the **CONTROL** port according to your use.

NOTE • The OFF is selected for the COMMUNICATION TYPE as the default setting.

- Using the COMMUNICATION menu, set up the communication. Remember that an unsuitable setup could cause malfunction of communication.
- When either one of the NETWORK BRIDGE settings is selected in the COMMUNICATION TYPE menu, RS-232C commands cannot be received from the **CONTROL** port.

6.3 Communication port

For the NETWORK BRIDGE function, send the data from the computer to the projector with using the **Network Bridge Port** that is configured in the **Port Settings** of web browser. ( 23)

NOTE • Except for 41794, 9715, 9716, 9719, 9720, 5900, 5500, 4352 between 1024 and 65535 can be set up as the **Network Bridge Port** number. It is set to 9717 as the default setting.

6.4 Transmission method

The transmission method can be selected from the menus, only when the NETWORK BRIDGE is selected for the COMMUNICATION TYPE.

(**OPTION menu > SERVICE > COMMUNICATION** in the **Operating Guide**)

HALF-DUPLEX ↔ FULL-DUPLEX

6.4.1 HALF-DUPLEX

This method lets the projector make two way communication, but only one direction, either transmitting or receiving data, is allowed at a time. The method does not allow the projector to receive the data from the computer while waiting for response data from an external device. After the projector receives the response data from an external device or the response limit time is past, the projector can receive the data from the computer.

That means that the projector controls transmitting and receiving the data to synchronize the communication.

To use the HALF-DUPLEX method, set up the RESPONSE LIMIT TIME following the instructions below.

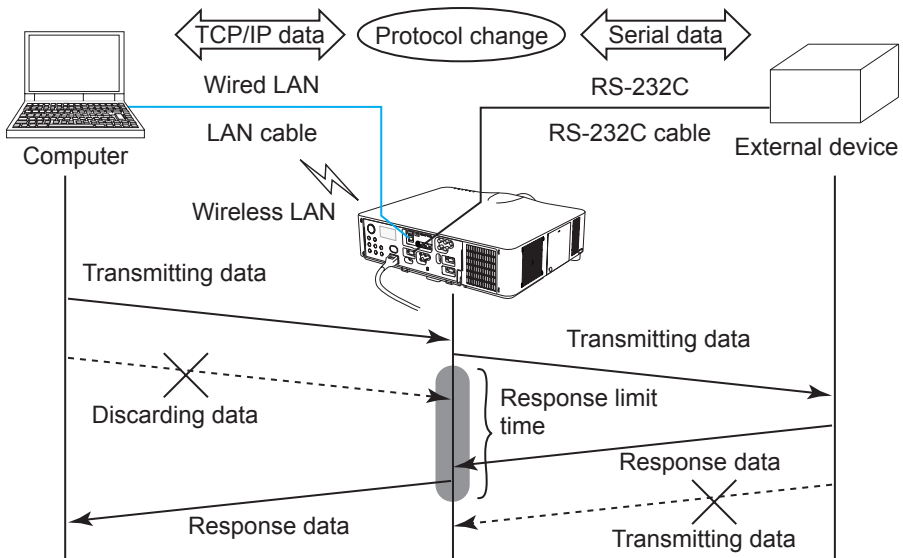

Using the RESPONSE LIMIT TIME menu, set the waiting time for response data from an external device. (**OPTION menu > SERVICE > COMMUNICATION** in the **Operating Guide**)

OFF ↔ 1s ↔ 2s ↔ 3s (↔ OFF)

6.4 Transmission method (continued)

NOTE • With using the HALF-DUPLEX method, the projector can send out 254 byte data as maximum at once.

- If it is not required to monitor the response data from an external device and the RESPONSE LIMIT TIME is set to OFF, the projector can receive the data from the computer and send it out to an external device continuously. The OFF is selected as the default setting.

6.4.2 FULL-DUPLEX

This method lets the projector make two way communication, transmitting and receiving data at the same time, without monitoring response data from an external device.

With using this method, the computer and an external device will send the data out of synchronization. If it is required to synchronize them, set the computer to make the synchronization.

NOTE • In case that the computer controls to synchronize transmitting and receiving the data, it may not be able to control an external device well depending on the processing status of the projector.

7. Other Functions

7.1 E-mail Alerts

The projector can automatically send an alert message to the specified e-mail addresses when the projector detects a certain condition that is requiring maintenance or detected an error.

- NOTE**
- Up to five e-mail addresses can be specified.
 - The projector may be not able to send e-mail if the projector suddenly loses power.

Mail Settings (📖25)

To use the projector's e-mail alert function, please configure the following items through a web browser.

Example: If the IP address of the projector is set to **192.168.1.10**:

- 1) Enter "**http://192.168.1.10/**" into the address bar of the web browser, and select Projector Web Control from the selection window.
- 2) Enter your user name and password, and then click the **[OK]**.
- 3) Click the **[Mail Settings]** and configure each item. Refer to item **3.1.5 Mail Settings (📖25)** for further information.
- 4) Click the **[Apply]** button to save the settings.

- NOTE**
- Click the **[Send Test Mail]** button in the **[Mail Settings]** to confirm that the e-mail settings are correct. The following mail will be delivered to the specified addresses.

Subject line	:Test Mail	<Projector name>
Text	:Send Test Mail	
	Date	<Testing date>
	Time	<Testing time>
	IP Address	<Projector IP address>
	MAC Address	<Projector MAC address>

7.1 E-mail Alerts (continued)

- 5) Click the **[Alert Settings]** on the main menu to configure the E-mail Alerts settings.
- 6) Select and configure each alert item. Refer to item **3.1.6 Alert Settings** (📖26) for further information.
- 7) Click the **[Apply]** button to save the settings.

Failure/Warning e-mails are formatted as follows:

Subject line	: <Mail title>	<Projector name>
Text	: <Mail text>	
	Date	<Failure/Warning date>
	Time	<Failure/Warning time>
	IP Address	<Projector IP address>
	MAC Address	<Projector MAC address>

7.2 Projector Management using SNMP

The SNMP (Simple Network Management Protocol) enables to manage the projector information, which is a failure or warning status, from the computer on the network. The SNMP management software will be required on the computer to use this function.

NOTE • It is recommended that SNMP functions be carried out by a network administrator.
• SNMP management software must be installed on the computer to monitor the projector via SNMP.

SNMP Settings (📖24)

Configure the following items via a web browser to use SNMP.

Example: If the IP address of the projector is set to **192.168.1.10**:

- 1) Enter "**http://192.168.1.10/**" into the address bar of the web browser, and select Projector Web Control from the selection window.
- 2) Enter your user name and password, and then click the **[OK]**.
- 3) Click the **[Port Settings]** on the main menu.
- 4) Click the **[Download MIB file]** to download a MIB file.

NOTE • To use the downloaded MIB file, specify the file by your SNMP manager.

- 5) Click the **[Enable]** check box to open the **SNMP Port**. Set the IP address to send the SNMP trap to when a Failure/Warning occurs.

NOTE • A Network Restart is required after the **SNMP Port** configuration settings have been changed. Click **[Network Restart]** on the main menu and click the **[Restart]** button. Then configure the following items.

- 6) Click the **[Security Settings]** on the main menu.
- 7) Click the **[SNMP]** and set the community name on the screen that is displayed.

NOTE • A Network Restart is required after the **Community name** has been changed. Click **[Network Restart]** on the main menu and click the **[Restart]** button. Then configure the following items.

- 8) Configure the settings for Trap transmission of Failures/Warnings. Click the **[Alert Settings]** on the main menu and select the Failure/Warning item to be configured.
- 9) Click the **[Enable]** check box to send out the SNMP trap for Failures/Warnings. Clear the **[Enable]** check box when SNMP trap transmission is not required.
- 10) Click the **[Apply]** button to save the settings.

7.3 Event Scheduling

The scheduling function enables to setup scheduled events including power on / power off. It enables to be “self-management” projector.

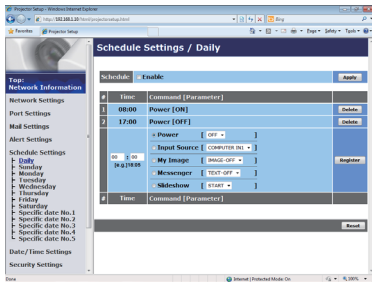

NOTE • You can schedule the following control events: Power, Input Source, My Image, Messenger, Slideshow. (📖29)

- The power on event has the lowest priority among the all events that are defined at the same time.

- There are 3 types of Scheduling, 1) daily 2) weekly 3) specific date. (📖28)

- The priority for scheduled events is as follows 1) specific date 2) weekly 3) daily.

- Up to five specific dates are available for scheduled events. Priority is given to those with the lower numbers when more than one event has been scheduled for the same date and time (e.g., ‘Specific date No. 1’ has priority over ‘Specific date No. 2’ and so on.

- Be sure to set the date and time before enabling scheduled events. (📖31)

Once you turn off the projector in the SAVING mode (📖SETUP menu in the **Operating Guide**) or the AC power, the current date and time setting is reset.

7.3 Event Scheduling(continued)

Schedule Settings (📖28)

Schedule settings can be configured from a web browser.

Example: If the IP address of the projector is set to **192.168.1.10**:

- 1) Enter "**http://192.168.1.10**" into the address bar of the web browser, and select Projector Web Control from the selection window.
- 2) Enter your user name and password, and then click the **[OK]**.
- 3) Click the **[Schedule Settings]** on the main menu and select the required schedule item. For example, if you want to perform the command every Sunday, please select the **[Sunday]**.
- 4) Click the **[Enable]** check box to enable scheduling.
- 5) Enter the date (month/day) for specific date scheduling.
- 6) Click the **[Apply]** button to save the settings.
- 7) After configure the time, command and parameters, click the **[Register]** to add the new event.
- 8) Click the **[Delete]** button when you want to delete a schedule.

There are three types of scheduling.

- 1) Daily: Perform the specified operation at a specified time every day.
- 2) Sunday ~ Saturday: Perform the specified operation at the specified time on a specified day of the week.
- 3) Specific date: Perform the specified operation on the specified date and time.

NOTE • In standby mode, the **POWER** indicator will flash green for approx. 3 seconds when at least 1 "Power ON" schedule is saved.
• When the schedule function is used, the power cord must be connected to the projector and the outlet. The schedule function does not work when the breaker in a room is tripped. The power indicator will lights orange or green when the projector is receiving AC power.

7.3 Event Scheduling(continued)

Date/Time Settings (📖31)

The Date/Time setting can be adjusted via a web browser.

Example: If the IP address of the projector is set to **192.168.1.10**:

- 1) Enter “**http://192.168.1.10**” into the address bar of the web browser, and select Projector Web Control from the selection window.
- 2) Enter your user name and password, and then click the **[OK]**.
- 3) Click the **[Date/Time Settings]** on the main menu and configure each item. Refer to item **3.1.8 Date/Time Settings (📖31)** for further information.
- 4) Click the **[Apply]** button to save the settings.

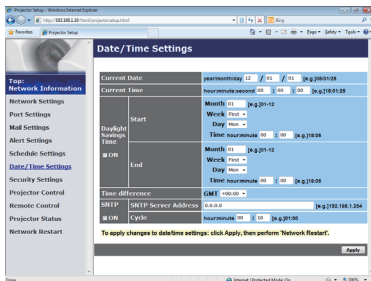

NOTE • The internal clock's time may not remain accurate. Using SNTP is recommended to maintain accurate time. (📖32)

- Once you turn off the projector in the SAVING mode (📖SETUP menu in the Operating Guide) or the AC power, the current date and time setting is reset.

7.4 Command Control via the Network

You can configure and control the projector via the network using RS-232C commands.

Communication Port

The following two ports are assigned for the command control.

TCP #23 (**Network Control Port1 (Port: 23)**)

TCP #9715 (**Network Control Port2 (Port: 9715)**)

NOTE • Command control is available only via the specified port above.

Command Control Settings (📖23)

Configure the following items from a web browser when command control is used.

Example: If the IP address of the projector is set to **192.168.1.10**:

- 1) Enter “**http://192.168.1.10**” into the address bar of the web browser, and select Projector Web Control from the selection window.
- 2) Enter your user name and password, and then click the **[OK]**.
- 3) Click the **[Port Settings]** on the main menu.

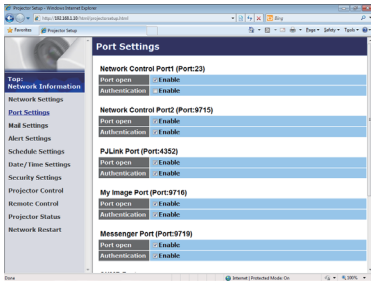

- 4) Click the **[Enable]** check box to open **Network Control Port1 (Port: 23)** to use TCP #23. Click the **[Enable]** check box for the **[Authentication]** setting when authentication is required, otherwise clear the check box.
- 5) Click the **[Enable]** check box to open **Network Control Port2 (Port: 9715)** to use TCP #9715. Click the **[Enable]** check box for the **[Authentication]** setting when authentication is required, otherwise clear the check box.
- 6) Click the **[Apply]** button to save the settings.

7.4 Command Control via the Network (continued)

When the authentication setting is enabled, the following settings are required. (📖33)

- 7) Click the **[Security Settings]** on the main menu.
- 8) Click the **[Network Control]** and enter the desired authentication password.
 - * See NOTE.
- 9) Click the **[Apply]** button to save the settings.

NOTE • The Authentication Password will be the same for **Network Control Port1 (Port: 23)**, **Network Control Port2 (Port: 9715)**, **PJLink™ Port (Port: 4352)**, **My Image Port (Port: 9716)** and **Messenger Port (Port: 9719)**.
• The new configuration settings are activated after restarting the network connection. When the configuration settings are changed, you must restart the network connection. You can restart the network connection from **Network Restart** on the main menu. (📖42)

7.4 Command Control via the Network (continued)

Command Format

Command formats differ among the different communication ports.

● TCP #23

You can use the RS-232C commands without any changes. The reply data format is the same as the RS-232C commands. ([RS-232C Communication](#) in the **Operating Guide - Technical**)

However, the following reply will be sent back in the event of authentication failure when authentication is enabled.

<Reply in the event of an authentication error>

Reply	Error code	
0x1F	0x04	0x00

● TCP #9715

Send Data format

The following formatting is added to the header (0 x 02), Data length (0 x 0D), Checksum (1 byte) and Connection ID (1 byte) of the RS-232C commands.

Header	Data length	RS-232Ccommand	Check Sum	Connection ID
0x02	0x0D	13 bytes	1 byte	1 byte

- Header → 0x02, Fixed
- Data length → RS-232C commands byte length (0x0D, Fixed)
- RS-232C command → RS-232C commands that start with 0xBE 0xEF (13 bytes)
- Check Sum → This is the value to make zero on the addition of the lower 8 bits from the header to the checksum.
- Connection ID → Random value from 0 to 255 (This value is attached to the reply data)

7.4 Command Control via the Network (continued)

Reply Data format

The connection ID (the data is same as the connection ID data on the sending data format) is attached to the RS-232C commands reply data.

<ACK reply>

Reply	Connection ID
0x06	1 byte

<NAK reply>

Reply	Connection ID
0x15	1 byte

<Error reply>

Reply	Error code	Connection ID
0x1C	2 bytes	1 byte

<Data reply>

Reply	Data	Connection ID
0x1D	2 bytes	1 byte

<Projector busy reply>

Reply	Status code	Connection ID
0x1F	2 bytes	1 byte

<Authentication error reply>

Reply	Authentication Error code		Connection ID
0x1F	0x04	0x00	1 byte

7.4 Command Control via the Network (continued)

Automatic Connection Break

The TCP connection will be automatically disconnected after there is no communication for 30 seconds after being established.

Authentication

The projector does not accept commands without authentication success when authentication is enabled. The projector uses a challenge response type authentication with an MD5 (Message Digest 5) algorithm.

When the projector is using a LAN, a random 8 bytes will be returned if authentication is enabled. Bind this received 8 bytes and the Authentication Password and digest this data with the MD5 algorithm and add this in front of the commands to send.

Following is a sample if the Authentication Password is set to "password" and the random 8 bytes are "a572f60c".

- 1) Connect the projector.
- 2) Receive the random 8 bytes "a572f60c" from the projector.
- 3) Bind the random 8 bytes "a572f60c" and the Authentication Password "password" and it becomes "a572f60cpassword".
- 4) Digest this bind "a572f60cpassword" with MD5 algorithm.
It will be "e3d97429adffa11bce1f7275813d4bde".
- 5) Add this "e3d97429adffa11bce1f7275813d4bde" in front of the commands and send the data.
Send "e3d97429adffa11bce1f7275813d4bde"+command.
- 6) When the sending data is correct, the command will be performed and the reply data will be returned. Otherwise, an authentication error will be returned.

NOTE • As for the transmission of the second or subsequent commands, the authentication data can be omitted when the same connection.

7.5 Crestron RoomView®

Crestron RoomView® is a multi-user resource management program provided by Crestron Electronics, Inc. It is an application for managing and controlling the projector and other AV devices collectively.

For details of Crestron RoomView®, refer to the Crestron® website.

URL: <http://www.crestron.com>

The following communication interfaces can be used to manage the entire facility.

- 1) Crestron RoomView® Express / Crestron RoomView® Server Edition
RoomView™ Express and RoomView™ Server Edition are software provided by Crestron Electronics, Inc. They are used for managing all the AV devices, and are also able to communicate with the help desk as well as send out alert messages.

For details of the software, refer to the following website.

URL: <http://www.crestron.com/getroomview>

- 2) Crestron e-Control®

Crestron e-Control® is a system controller that can be operated via a web browser. (📖43)

8. Troubleshooting

Problem	Likely Cause	Things to Check	Reference Page Number
Can't communicate	Weak radio signal	<ul style="list-style-type: none"> • Bring the computer and projector closer together. • Radio waves won't go through concrete and metal (steel doors, etc.) 	–
	Cannot communicate due to configure wireless / encryption settings.	If there is a wireless configuration utility loaded on your computer, check its settings. Please refer the manual of your configuration utility.	–
	The computer and/or projector's network settings are not configured correctly.	Check the network configurations of the computer and projector.	–
	The same network address is set for both wireless and wired LAN.	Change the network address setting for wireless or wired LAN.	21, 22
	<Only for wireless LAN> The USB wireless adapter is not inserted into the projector.	Insert the optional USB wireless adapter.	–
	<Only for wireless LAN> There is closely another projector or other that has the same wireless setting.	Try changing of SSID and IP Address.	21
Others - Information from the projector to computer is not correct or completed - The projector does not respond	Communication between the projector and computer is not working well. NETWORK Functions of the projector is not working well.	Try "NETWORK RESTART" in SERVICE menu under the NETWORK menu.	In the Operating Guide

9. Warranty and after-sales service

If a problem occurs with the equipment, please read **8. Troubleshooting** (📖70) section first and review all suggested check points. After that, please contact your dealer or service company, if you still have the problem. They will tell you what warranty condition is applied.

DUKANE CORP AV SERVICE DEPT
2900 Dukane Drive
St Charles, IL 60174
800-676-2487 / 630-762-4032
Fax 630-584-5156
avservice@dukane.com
www.dukane.com/av

Free Manuals Download Website

<http://myh66.com>

<http://usermanuals.us>

<http://www.somanuals.com>

<http://www.4manuals.cc>

<http://www.manual-lib.com>

<http://www.404manual.com>

<http://www.luxmanual.com>

<http://aubethermostatmanual.com>

Golf course search by state

<http://golfingnear.com>

Email search by domain

<http://emailbydomain.com>

Auto manuals search

<http://auto.somanuals.com>

TV manuals search

<http://tv.somanuals.com>