

# ***DUKANE***

## **Model DVP303A**

### **User's Manual**



### **Digital Visual Presenter**



# Table of Contents

<b>1</b>	<b><i>INTRODUCTION</i></b>	<b>2</b>
1-1	INTRODUCTION	2
1-2	CERTIFICATION	2
1-3	WARNING	2
1-4	SAFETY INSTRUCTION	2
1-5	SPECIFICATION	4
<b>2</b>	<b><i>PACKAGE CONTENT</i></b>	<b>5</b>
<b>3</b>	<b><i>PRODUCT OVERVIEW</i></b>	<b>6</b>
3-1	FRONT/TOP VIEW	6
3-2	CONTROL PANEL	6
3-3	REAR VIEW	7
3-4	INFRARED REMOTE CONTROL	8
<b>4</b>	<b><i>INSTALLATION</i></b>	<b>9</b>
4-1	SETTING UP THE DIGITAL PRESENTER	9
4-2	POWERING ON THE DIGITAL PRESENTER	9
4-3	POSITIONING AND TURNING ON THE LAMPS	9
<b>5</b>	<b><i>USING THE DIGITAL PRESENTER</i></b>	<b>10</b>
5-1	GETTING STARTED	10
5-2	USING THE OSD MENU	10
5-3	BASIC OPERATION	11
5-4	USING THE MOUSE	14
5-5	USING USB AND RS232	14
5-6	ADVANCED SETTINGS	14
5-7	SPS SETTINGS AND OPERATION	15
5-8	STORAGE AFTER USE	17
<b>6</b>	<b><i>Q&amp;A</i></b>	<b>18</b>

# 1 Introduction

---

## 1-1 Introduction

This equipment generates and uses radio-frequency energy and, if not installed and used in accordance with the instruction manual, may cause interference to radio and television reception. It has been tested and found to comply with the limits for a class A computing device in accordance with the specifications in Subpart J of Part 15 of FCC Rules, which are designed to provide reasonable protection against such interference when operated in a commercial environment. If this equipment does cause interference to radio or television reception, the user may try to correct the interference by one or more of the following measures:

- ◆ Reorient the receiving antenna for the radio or television.
- ◆ Relocate the equipment with respect to the receiver.
- ◆ Plug the equipment into a different power outlet so the equipment and receiver are on different branch circuits.
- ◆ Fasten cables using mounting screws to ensure adequate EMI controls.

## 1-2 Certification

FCC, CE LVD

## 1-3 Warning

**Please carefully read the user manual before operating the product.**

### **EN 55022 (CE radiation) Warning**

This product is intended for use in a commercial, industrial, or educational environment. It is not intended for residential use.

This is a Class A product. In a domestic environment it may cause radio interference, in which case the user may be required to take adequate measures. The typical use is in a conference room, meeting room or auditorium.

## 1-4 Safety Instruction

Always follow these safety instructions when setting up and using the Digital Presenter:

1. Do not place the Digital Presenter on an unstable trolley, stand or table.
2. Do not use the Digital Presenter near water or sources of heat.
3. Use attachments only as recommended.
4. Use the type of power source indicated on the Digital Presenter. If you are not sure of the type of power available consult your dealer or local electricity company.
5. Insert the Digital Presenter's three-pin grounded plug into a properly grounded socket. If you have a two-pin socket, contact an electrician to replace it. Do not handle the plug with wet hands.
6. Always take the following precautions when handling the plug. Failure to do so may result in sparks or fire.
  - ◆ Ensure the plug is free of dust before inserting it into a socket.
  - ◆ Ensure that the plug is inserted into the socket securely.

7. Do not overload wall outlets. Do not use extended extension leads or multi-way plug boards. Fire or electric shock may be possible.
8. Do not block any cabinet opening with any kind of objects.
9. Never allow liquid of any kind to spill into the Digital Presenter.
10. Except as specifically instructed in this User's Manual, do not attempt to service this product yourself. Opening or removing covers may expose you to dangerous voltages and other hazards. Refer all servicing to qualified service personnel.
11. Unplug the Digital Presenter during thunderstorms or if it is not going to be used for an extended period. Do not place the Digital Presenter or remote control on top of heat-emitting equipment or heated objects such as a car, etc.
12. In the following situations unplug the Digital Presenter from the wall outlet and refer servicing to qualified service personnel:
  - ◆ If the power cable or plug becomes damaged or frayed.
  - ◆ If liquid has been spilled into it or it has been exposed to rain or water ventilation is provided.

## 1-5 Specification

### Image

Pick-up Device	1/3" progress scan CCD
Effective Pixels	1077 ( H ) x 788 ( V )
Frame Rate	15 Frames/sec
White Balance	Auto/Manual
Exposure	Auto/Manual
Image Mode	Photo/Text//Gary/Film/Slide
Freeze	Yes
Analog RGB Output	XGA 75Hz SVGA 75Hz
H.Sync. Signal	60K/47KHz, TTL level, Positive Polarity
V.Sync. Signal	75Hz, TTL level, Positive Polarity
Image Signal Level	0.77Vpp

### Optics

Lens	12X (f=5.4~64.8mm); F1.8~2.7
Shooting Area	400 mmX300 mm (max.) 36 mm X 27 mm (min.)
Zooming	12X Optical 4X Digital
Focusing	Auto/Manual
Power Source	AC90~240V
Consumption	15Watts (Lamp off) 30Watts (Lamp on )

### Lighting

Lamp type.	Cold cathode lamp
Backlight	Built in
Size	A4 / 268mm x 208mm

### Input

VGA Input	HD-SUB 15 Pins Female
Mouse Port	Standard PS2 Mouse
RS232C	D-SUB 9 Pins Male

### Output

VGA Output	HD-SUB 15 Pins Female x 2
DVI	Digital & Analog Receptacle Connector
USB	Standard USB Socket (Type )
DC12V Output	DC jack, 500mA

### Dimension

Operating	640 mm (L) X 350 mm (W) X 650 mm (H)
Folded	510 mm (L) X 350 mm (W) X 130 mm (H)
Weight	About 4.5KG

## **2\_\_Package Content**

---

**Make sure that the package contains the following items**

- ◆ Digital Presenter
- ◆ User's manual CD
- ◆ Remote controller
- ◆ Power cable
- ◆ VGA cable
- ◆ USB cable
- ◆ RS232 cable
- ◆ Slide Holder
- ◆ Negative Holder

## 3 Product Overview

### 3-1 Front/Top View

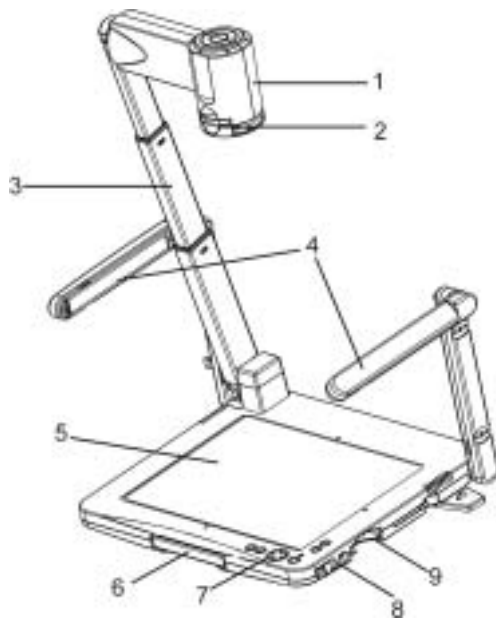











Figure: 3 - 1

1. Camera head
2. Attach Lens
3. Camera arm
4. Lamps
5. Base light in platform
6. Handle
7. Control panel
8. Lamp Lock
9. Remote controller slot

### 3-2 Control panel

- 1  (Power button): Turn on/off the Digital Presenter.
- 2 Select button:
  - 2.1 AF: Auto Focus.
  - 2.2 Adjust: Switch the function mode between Focus and Brightness, R, B.
  - 2.3 ◀ Or ▶: To adjust the value of the function mode,
  - 2.4  /  (SOURCE): SWITCH between different signal sources.
  - 2.5  /  (PHOTO / TEXT): Adjust the image of Photo and Text.
- 3  (LAMP): Turn on/off the lamps and base light.
- 4 AWB: Auto WB.
- 5 Lamp Release: Push the latch to release the lamp arm.
- 6  (ZOOM OUT): Make the image smaller.
- 7  (ZOOM IN): Make the image larger.
- 8 Hot Key :
  - 8.1  (LAMP) +  (ZOOM OUT):
    - 8.1.1 Switch to SVGA: The LED indicator will twinkle orange light 1 times.
    - 8.1.2 Switch to XGA: The LED indicator will twinkle orange light 3 times.

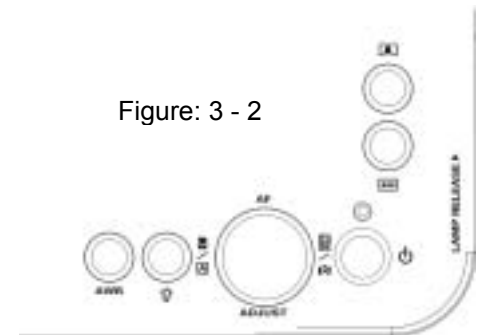

Figure: 3 - 2



### 3-3 Rear View

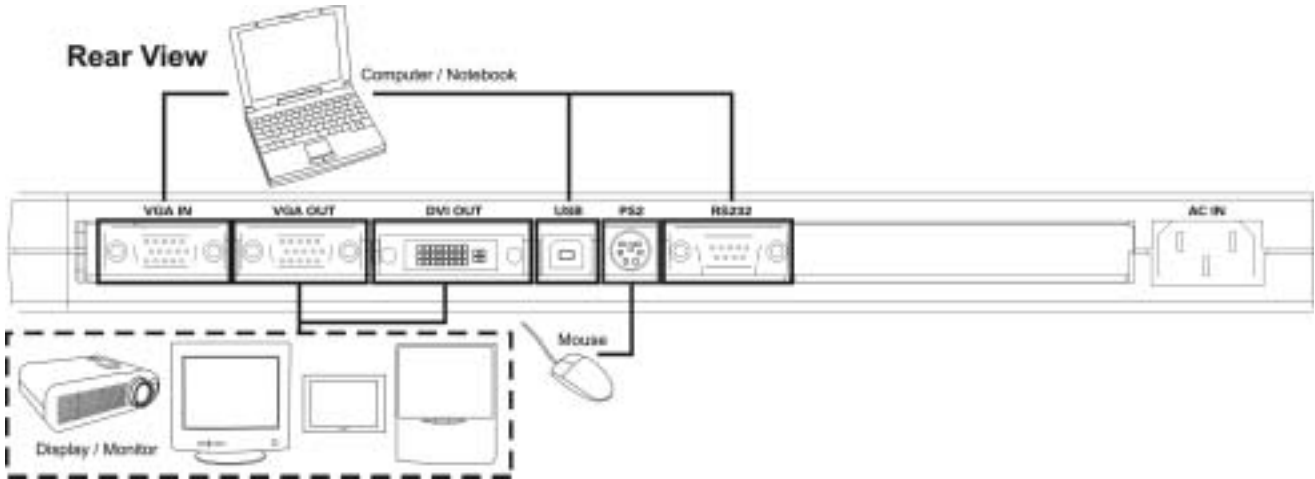

Figure: 3 - 3

#### 1 **VGA INPUT**

Connect the connector to the VGA output connector of another VGA output device. When an input device is selected, the image is shown through the VGA IN connector.

#### 2 **VGA OUTPUT**

Connect The connector to the input connector of a display device.

#### 3 **DVI OUT (DVI-I)**

Digital Video connector: Output digital and analog signal format

#### 4 **USB (Support for USB 1.1)**

Use the connector to connector a USB cable for transmitting via the USB port.

#### 5 **PS2 Mouse**

Connect a PS/2 mouse to this port when user wants to access the menu or cursor function.

#### 6 **Serial Control Input (RS232)**

Use this port to connect the Digital Presenter to an external RS232 device, such as a remote control system for classroom teaching or conferences.

#### 7 **AC IN**

Use this to connect the power cable (100 - 240V) for the power input.

### 3-4 Infrared Remote Control



Figure: 3 – 4

Button	Description	Button	Description	Button	Description
1. Power	Turn on and off the Digital Presenter.	8. Zoom Out	Make the image smaller.	15. Play	Replay the stored image.
2. AF	Auto Focus	9. Focus +	Move the focus to a nearer area.	16. Del	Delete the stored image.
3. Freeze	Keep the current image display on the screen.	10. Focus -	Move the focus to a further area.	17.Lamp	Switch the lamp mode.
4. Capture	Capture an image.	11. BRT+	Make the display brighter.	18.Flip	Turn the image up and down by 180°.
5. Selection Button (▲▼◀▶)	Select a function or item.	12. BRT-	Make the display darker.	19.Source	Select the image input source.
6. Menu	Enter the main menu.	13. Gamma	Switch the image mode. (Photo/Text).	20. Enter	Confirm your selection
7. Zoom In	Make the image larger.	14. AWB	Auto White Balance.		

Table: 3-1

## 4 Installation

### 4-1 Setting Up the Digital Presenter

1. Pull up the arm. Adjust the position and height (the height should be 48.5 cm for operation) of the arm by moving the 3-section joint.
2. Turning the camera head toward the platform.



Figure: 4-1

Note: The angle of the camera head is limited. Do not turn it forcefully when it reaches the maximal angle.

### 4-2 Powering on the Digital Presenter

Note: Before using the Digital Presenter, make sure that you have connected it to the computer, video source or other output devices. See Figure: 3-3, Rear View for the position of connector jacks.

1. Connect the power cable to the AC IN jacks.
2. Press  (the Power button) for about 1 second to power on the Digital Presenter. The red LED (flashing until the presenter is started) turns to green.

### 4-3 Positioning and Turning on the Lamps

You can use the lamps on the both sides of the Digital Presenter for auxiliary lighting by following some simple steps:

1. Press and slide the latches to release the lamp lock (see P.7).
2. Pull up the lamp arms.
3. Rotate the folded lamp to face the platform as the arrow shows. (Refer to figure 4-1)

Note: The angle of the lamp arm/lamp head is limited. Do not turn it forcefully when it reaches the maximal angle.

4. Turn on the lamps by pressing the  (Lamp) button on the Control panel or Lamp button on the remote control.
5. You can adjust the lamp arms outward slightly for better lighting.

## 5 Using the Digital Presenter

This chapter shows you the basic and advanced functions of the Digital Presenter as and how to use the menu, the mouse, and the Presenter USB/RS232 interface.

### 5-1 Getting Started

#### For Presenting Printed Materials:

1. Power on the Digital Presenter. (The lamp arm should be ready before you turn on the power)
2. Place the document or object on the platform. While observing the image on the monitor, adjust the zoom or arm to obtain the optimal size.
3. Press the AF (Auto Focus) button to focus document or object.

#### For Viewing Transparencies:

1. Start the menu by pressing the Menu button on the remote control.
2. Select Lamp → Backlight
3. Place the object on the stage. While observing the image on the monitor, adjust the zoom or arm to obtain the optimal size.

#### For Viewing remote object:

1. Pull out the Close-Up Lens, as shown in Figure 5-1.
2. Rotate the camera head.
3. While observing the image on the monitor, adjust the zoom or arm to obtain the optimal size.

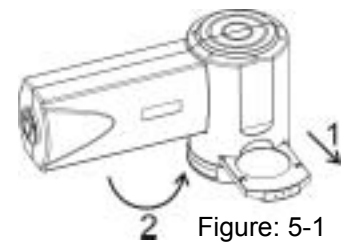

Figure: 5-1

### 5-2 Using the OSD Menu

#### Showing the Main Menu

Option 1: Connect a PS2 mouse to the rear connector of the PRESENTER machine. Right click to show the main menu.

Option 2: Open the Main Menu by pressing the Menu button on the remote control.

#### Starting/Exiting the Menu

To start the menu:

Option 1: Press the Menu button on the remote control to start or exit the menu.

Option 2: When you are using a PS2 mouse, right click to start or exit the menu.

To exit the menu: The menu will be automatically turned off when not being activated for 30 seconds.

#### Adjusting and Confirming the Settings

Move your mouse to highlight the option you want to select. If you are using the remote control, show the Main Menu and highlight the option you want to select by pressing ▲, ▼, ◀, or ▶ buttons.

Option 1: If you want to confirm a setting press the Enter button on your remote control or click the mouse to confirm the option you choose.

Option 2: If you want to exit the setting press the Menu button on your remote control or click the right button on your mouse to return to the previous menu.

## OSD Menu









Layer 1	Layer 2	Layer 3
 Display	Gamma	Photo / Text
	Image	Normal
		Gary
		Film
		Slide
Layer 1	Layer 2	
 Source	Presenter / VGA In	
Layer 1	Layer 2	Layer 3
 Storage	Capture	Processing
	Playback	
	Delete	
	Delete All	Enter / Exit
Layer 1	Layer 2	Layer 3
 Setting	Auto Exposure	Off / On
	Language	English / Deutsch / Francais / Italiano / Espanol / Русский / 中繁 / 中简
	Output Format	SVGA / XGA
	Pointer Color	R / G / B / W / B
	Drawing Type	Frame / Line
	AC Frequency	50Hz / 60Hz
	SPS-OFF	Enter Password
	Factory Reset	Enter / Exit (PSxxx / VSxxx)

Table: 5-1

### 5-3 Basic Operation

#### Zoom, to make the image larger or smaller:

Option 1: Press the  (Zoom In) or  (Zoom Out) button on the control panel to make the image larger or smaller.

Option 2: Press the Zoom In () or Zoom Out () button on your remote control to make the image larger or smaller.

Note: The optical zoom will be automatically switched to the digital zoom at the last step of the optical zoom.

#### Auto Focus

The Auto Focus function of the Digital Presenter automatically adjusts the camera focus to the correct value. The function will be performed once as you switch on the PRESENTER (Power On).

You may execute the AF (Auto Focus) function by pressing the Auto Focus button.

Option 1: Press the keypad "AF" for executing the AF function.



Option 2: Using the remote controller "AF" button for auto focus function.



Besides, the digital presenter will execute Auto Focus when user adjusting the zoom in/out.

## Focus

In some cases, you may have to adjust the focus manually.



To adjust the focus manually:

Option 1: Press  on the control panel to enter the "Focus" mode. Adjust the focus with the Adjust buttons ( ) until you see a clear image.

Option 2: If you are using your remote control, adjust the focus with the Focus - () and Focus + () buttons until you see a clear image.

## Brightness

To adjust the brightness of the image Presenter:

Option 1: Press  on the control panel to enter the "Brightness" mode. Adjust the brightness value with the Adjust buttons ( ) until you are satisfied with the image brightness.

Note: You may also adjust the lamps for proper lighting or turn on/off the lamps.

## Gamma

Select Gamma to set different gamma.

Select Gamma for different image sharpness.

When you select Photo, the image is displayed in true colors.

When you select Text, the contrast of the image becomes sharp. The Text mode is particularly useful when you present a text that contains small fonts or is slightly blurred. It is recommended to use the Photo mode in general conditions.

## Image

Select Image to adjust the image output of your Presenter.

The Normal mode, which is the default setting, will enhance the color display.

When you select Gary, the image is displayed in black and white.

Note: Your presenter will automatically adjust the image size, brightness, color, lamps, and AF, based on your selection of Slide or Film modes.

You may select Film for a negative effect (each color is turned to its opposite). If you do so, the lamps are switched to backlights.

The Slide mode is offered to view slides. In such a mode, the lamps are switched to backlights.

You may place slides or negatives as follows:

1. Place a slide or negative in the slide or negative holder, as shown in Figure 5-2.
2. Insert the slide or negative holder into the slot above the lens.



Figure: 5-2

## Storage

You may use this function to capture the current image display and save it in the internal memory of the Digital Presenter.

### **To capture an image:**

Option 1: If you are using the mouse, click the "Storage". Click "Capture" to capture the current image display. When the "image capturing" function is in progress, "Processing" will be shown just at the place of "Capture" location.

Option 2: If you are using the remote control, press the Capture button to capture the current image display. When the function is in progress, a "Processing ►►" OSD displays at the upper left of the output image.

### **To show the captured image:**

Option 1: If you are using the mouse, click on OSD "Storage". Click "Playback" to show the Index screen, where your image storage is displayed in thumbnails and sorted by the image number. Move the mouse; the blue selection box on the image index changes accordingly. Whenever the box is on a thumbnail, you may see the large image by clicking the mouse.

Option 2: If you are using the remote control, press the Play button to show the Index screen, where you may move the blue selection box on the screen and select an image file by using the four directional buttons. By pressing the Enter button on the remote control, you may see the large image of your thumbnail selection.

At this time, you may navigate through other image files one by one, by using the Left and Right buttons on the remote control or the mouse.

### **To delete the captured image:**

Option 1: If you use the mouse to perform the "Delete Image" function, you may not delete any image file unless you have selected the file and enlarged it. Click the OSD "Storage" and then "Delete" to delete the image. The next file will be selected on the screen.

Option 2: Press "Play" on your remote control to enter the Image Index screen. Select an image file by using the four directional buttons and press the Del button on the remote control to delete it.

If you have enlarged an image file, you may also delete it by pressing the Del button on the remote control. If you do so, the next file will be shown on the screen.

### **To save the image to storage media:**

Press the Menu button to enter the Storage menu. Navigate to "Save" to save the image to the media you have selected.

### **To delete all images:**

Option 1: If you are using the mouse, click the OSD "Storage". Then click the "Delete All" functional item. A "Delete all images" dialog box pops up asking you to confirm your deletion. If you do want to delete all the images, move your mouse to "OK" and click; otherwise, move your mouse to "Cancel" and click to cancel the operation.

Option 2: If you are using the remote control, press Menu to open the menu. Highlight "Storage" and press the Enter button. Highlight "Delete All" with the up and down buttons. Press Enter to pop up the "Delete all images" dialog box asking you to confirm. If you want to delete all such files, press Enter; otherwise, press Menu.

### **Freeze:**

Use Freeze to keep the image on screen. After you enable the Freeze mode, the image freeze on the screen even when you take the object away from the stage.

**Flip:**



Press "Flip" on the Remote Controller Select to rotate the image by 180°.

**Lamp:**

Press "Lamp" on the Remote Controller to turn on and off the lamps and the backlight.

**Source:**

Option 1: Use Source on the remote control to switch the image input device (Presenter/VGA In).

Option 2: Use the  /  (Source) button on the control panel to switch the image input device (Presenter/VGA In).

For example, when you select VGA In, the Digital Presenter will switch from camera display to the image sent from the PC output port. You can press Source again to switch between VGA In and Presenter.

## 5-4 Using the Mouse

You can also control the Digital Presenter by a PS2 mouse (see the figure 3-3 on p.8 for PS2 connection). For example, you can move the cursor to adjust the settings or use the cursor as a pointer for Presenter.

**Mouse Keys**

The left key functions as Enter. The right key is used for activating the menu. The central key/bar (when available) is for moving your selection on the menu.

## 5-5 Using USB and RS232

**USB**

You can transmit images to computer via USB interface. To enhance USB transmission, make sure that your PC supports USB protocol (the Digital Presenter is based on USB 1.1).

**RS232**

RS232, a kind of serial protocol, facilitates remote control functions. For example, you can control the Digital Presenter installed in a conference room from a PC in another building via RS232.

---

Note: See the rear panel (p.8) for USB and RS232 connection.

## 5-6 Advanced Settings

Usually you do NOT need to change the settings introduced in this section in basic operation. The following functions are listed in Setting on the main menu.

Note: To resume the default settings, refer to the chart in "Using the Menu." Alternatively, you can select Factory Reset to set all the values as default.

**AE (Auto Exposure):**

AE enable have the best exposing effect of the image automatically. The default value is on. If you select off, the Auto exposure is disabled.

Note: When you turn off Auto Exposure, You need to adjust the brightness manually.



## Language:

Use this function to select an OSD language from several options. There are 8 kinds of languages English, Deutsch, Francais, Italiano, Eapanol, Русский, 中繁, 中简.

## Output Format:

Use Output Format to choose the output mode: XGA (1024 x 768), or SVGA (800 x 600). The default setting is XGA.

## Pointer Color:

Adjust the color of the indication cursor by using the selection buttons (▲ ▼). R (Red) → G (Green) → B (Blue) → White → Black, the default setting is Red.

## Remark setting:

You may select "Box" or "Line" as the indication cursor. The default setting is "Box". If you use the mouse, the function is available by clicking the left button.

## AC Freq:

Please check your power system frequency (50 or 60HZ) and set it to avoid the flickering from fluorescent lamp.

## Factory Reset:

Use this function to reset all values to the factory default. Select Enter to confirm and Exit to skip. And it will show firmware version: "PNxxx/VNxxx." (On the last row of this OSD)

## 5-7 SPS Settings and Operation

- 1 Setting: Enter the password with your remote control, follow the step: "▲ "+" "◀ "+" ▶" to initiate the SPS setting procedure.
- 2 There are three groups available: Setting1~3. For example, if you want to set the Setting 1, do as follows:

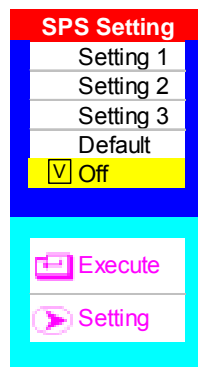

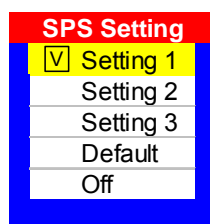

- 2.1 Press ▲▼ to open a screen and select the parameter group you want to specify. Press "Enter" to select Setting 1. Press ▶ on the remote control to enter the next layer.



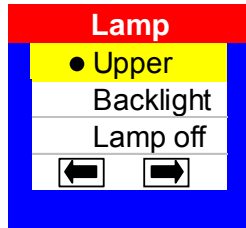

2.2 Select the Lamp status, as shown in the following figure:



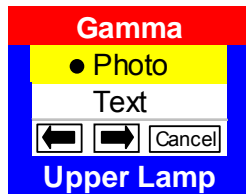

2.3 If you select Upper (Upper Lamp), press  on your remote control until  is highlighted. Press Enter to show Gamma options. Select one, as shown in the following figure.



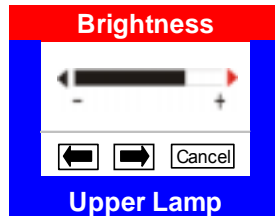

2.4 If you select Photo, press  on your remote control until  is highlighted. Press Enter to show Brightness. Adjust the value, as shown in the following figure.



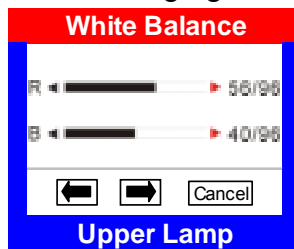

2.5 When you complete with the Brightness, press  on your remote control until  is highlighted. Press Enter to show White Balance. Adjust the R or B value, as shown in the following figure.

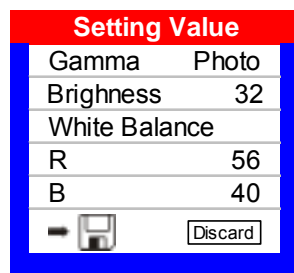

2.6 When you complete with the R and B values for the White Balance, press  on your remote control until  is highlighted. Press Enter to show the Setting Value window, where values you have selected until now are listed. You may choose to save such values or cancel, as shown in the following figure:



2.7 Proceed with your setting or stop doing so:

2.7.1 If you have selected Save  in Step 2.6, a "Save complete" messages appears for three seconds. Then the screen to the one as shown in 2.2. You may select  or press Menu on the remote control to return to Layer 1; or, select  to configure another lamp.

2.7.2 If you have selected Discard in Step 2.6, a "Discard your settings" message appears. Then the screen returns to the one as shown in Step 2.2.

2.8 Operation:

2.8.1 If you have your SPS settings ready, you may change the SPS-Off to the one you want after the presenter has been switched on. In such a way, the Lamp parameters may be loaded for service.

2.8.2 SPS Off: If you turn off the SPS mechanism, the set of Lamp parameters at your last presentation will be used.

2.9 Notice:

2.9.1 When the SPS Setting 3 is selected on the menu, you can still adjust the brightness and WB to meet the varied surrounding condition. However, your modification will not be saved; that is, the values you have specified in your SPS selection will be loaded the next time the presenter is switched on.

2.9.2 The Default setting is the SPS setting by factory default.

## 5-8 Storage after Use

1. Fold the arm and the camera head until they touch the stage.
2. Turn the camera until it is parallel with the stage.
3. Turn the upper lamps toward the supporting arms.
4. Insert the remote control into the slot on the right of the Digital Presenter.
5. Fold them to both sides of the Digital Presenter until they lock in both sides.

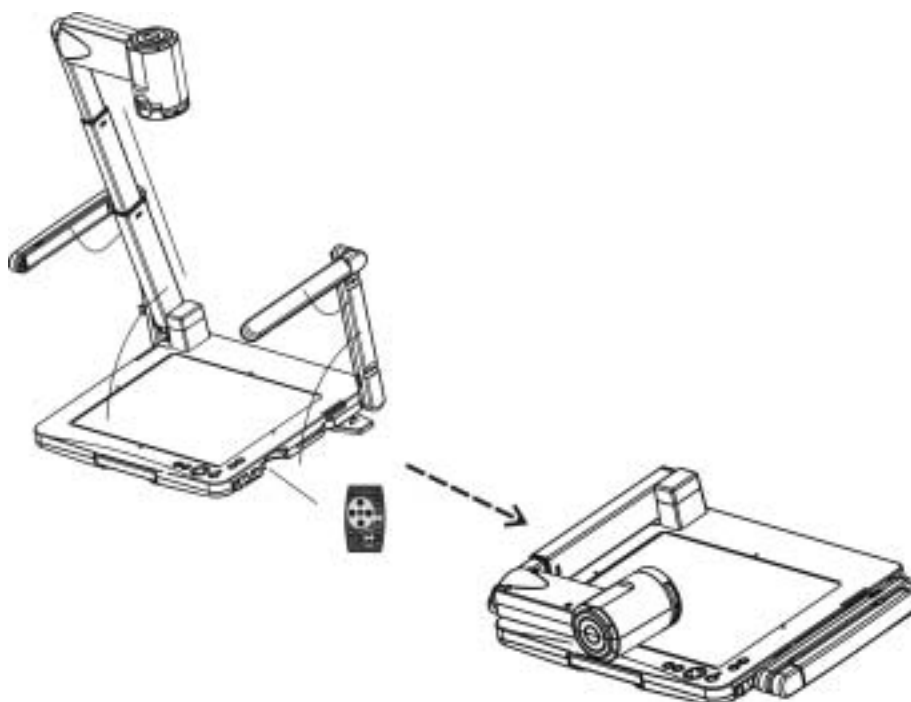

Figure: 5-3

## 6 Q & A

---

**1 Q: The (  ) system indicator does not come on.**

A: No power is coming on.

Check that the power cord is connected securely both at the power outlet and the PS.

**2 Q: No image appears on the screen.**

A:

I. Make sure the power is installed correctly and securely.

II. Make sure all of the cables are installed correctly and securely.

**3 Q: The image or parts of the image are blurred or not in focus.**

A: The lens focusing is maybe not correct or the image sampling is not in the best condition.  
Press the AF (Auto Focus) on the remote control or the control panel.

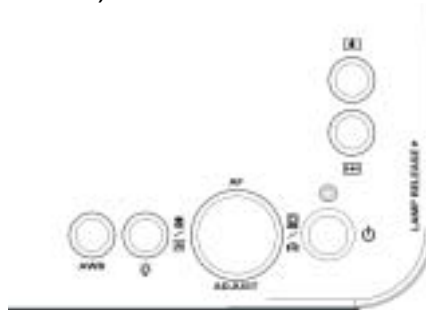

**4 Q: Image is too dark or too bright.**

A: Adjusting brightness setting on the remote controller.

**5 Q: Remote controller did not work.**

A: Please check the battery.



Audio Visual Products

---

Dukane Corporation  
Audio Visual Products Division  
2900 Dukane Drive  
St. Charles, IL 60174-3395  
E-mail: avsales@dukcorp.com

Phone: (630) 762-4040  
Orders: (800) 676-2485  
Fax: (630) 584-5156  
Parts & Service: (800) 676-2487  
Fax: (630) 584-0984

**DUKANE**

## Free Manuals Download Website

<http://myh66.com>

<http://usermanuals.us>

<http://www.somanuals.com>

<http://www.4manuals.cc>

<http://www.manual-lib.com>

<http://www.404manual.com>

<http://www.luxmanual.com>

<http://aubethermostatmanual.com>

Golf course search by state

<http://golfingnear.com>

Email search by domain

<http://emailbydomain.com>

Auto manuals search

<http://auto.somanuals.com>

TV manuals search

<http://tv.somanuals.com>