

S T A R F I R E

OPERATIONS MANUAL DUKANE

MODELS

SF6000

SF5510

SF4030

SF4010

SF3010

SF3000

HD 4010



5 YEAR LIMITED WARRANTY

This Dukane audio visual product is warranted to the original purchaser under a 5 year limited warranty – – in normal use and service – – against defects in material and workmanship. DUKANE CORPORATION EXPRESSLY DISCLAIMS ALL OTHER WARRANTIES, EXPRESSED OR IMPLIED, INCLUDING ALL WARRANTIES OF MERCHANTABILITY AND FITNESS FOR A PARTICULAR PURPOSE.

During the warranty period, Dukane Corporation will repair or replace (at the Manufacturer's option) any such defective parts (except for lamps, which are subject to whatever warranties the manufacturer may provide) without charge to the purchaser for parts or labor when the product is returned, prepaid and insured, with proof of purchase date. This remedy of repair or replacement is exclusive of all other remedies that the purchaser may have. This exclusive remedy is void if the product has been damaged by accident or unreasonable use, neglect, or improper service or other causes not arising out of defects in material or workmanship.

Dukane Corporation disclaims all liability for incidental or consequential damages of any kind, including all damages arising out of any interruptions in operation of the product and all damages to software.

No person, firm or representative is authorized to assume any obligation or make any warranty on behalf of the Dukane Corporation other than as stated above.

**THIS LIMITED WARRANTY IS VALID FOR U.S.A. AND CANADA.
FOR OTHER LOCATIONS, LOCAL WARRANTIES APPLY.**

Audio Visual Products

2900 Dukane Drive • St. Charles, IL 60174-3395
Phone: 1-800-676-2487 • Fax: 630-584-0984
E-mail: avserdpt@dukcorp.com • Internet: www.dukcorp.com/av

DUKANE

IMPORTANT SAFETY INSTRUCTIONS

When using your overhead projector, basic safety precautions should always be followed, including the following:

1. Read and understand all instructions before using.
2. Close supervision is necessary when any projector is used by or near children. Do not leave projector unattended while in use.
3. Care must be taken as burns can occur from touching hot parts.
4. Do not operate projector with a damaged cord or if the projector has been dropped or damaged — until it has been examined by a qualified service technician.
5. Position the cord so that it will not be tripped over, be pulled or contact hot surfaces.
6. If an extension cord is necessary, a cord with a current rating at least equal to that of the projector should be used. Cords rated for less amperage than the projector may overheat.
7. Always unplug projector from electrical outlet before cleaning and servicing and when not in use. Never yank cord to pull plug from outlet. Grasp plug and pull to disconnect.
8. Let projector cool completely before putting away.
9. To protect against the risk of electric shock, do not immerse this projector in water or other liquids.
10. To avoid the risk of electric shock, do not disassemble this projector, but take it to a qualified service technician when some service or repair work is required. Incorrect reassembly can cause electric shock when the projector is used subsequently.
11. The use of an accessory attachment not recommended by the manufacturer may cause a risk of fire, electric shock or injury to persons.
12. Connect this projector to a grounded outlet.
13. Disconnect this unit from its source of supply before replacing the projection lamp.

Additional lamp safeguards: never handle lamps with bare fingers; periodically inspect lamps, when they're turned off, for signs of blistering or blackening; insure proper action of the cooling system; turn off the projector immediately if the image becomes abnormally dim; never operate a projector with the lamp housing open; and make sure that the lamp itself is properly seated.

SAVE THESE INSTRUCTIONS

**Thank you for choosing a
Starfire® Series
Portable/Professional
Overhead Projector.**

The sleek, low-profile Starfire Overhead Projectors are available in your choice of 3000, 4000/3200, 5500/4400 and 6000 ANSI lumens. Features of each model vary and can include a single, triple or triple/wide-angle lens; built-in AC outlets; and even an electronic "soft start" power supply that improves the projected image, extends the lamp life and reduces operating costs.

Because operation of all units is very similar, this manual covers all models in the Dukane Starfire Series.

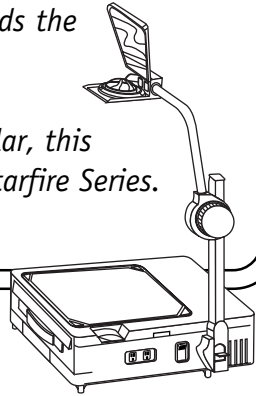

Audio Visual Products

2900 Dukane Drive • St. Charles, IL 60174-3395
Phone: 1-800-676-2487 • Fax: 630-584-0984
E-mail: avserdpt@dukane.com • Internet: www.dukane.com

DUKANE

TABLE OF CONTENTS

Page

LIFETIME LIMITED WARRANTY	Inside Cover
SPECIFICATIONS	1
ELECTRICAL SAFETY GROUNDING INSTRUCTIONS	1
INDEX OF FUNCTIONAL PARTS	2-3
SF MODEL SETUP and FOLDUP	4-5
HD MODEL SETUP	6
OPERATION	7
Image Adjustment	7
High/Low Lamp Switch	8
Lamp Changer	8
LAMP REPLACEMENT	9
CLEANING	10
SERVICING	10
Shipping Information	10
Service	10
No Charge Warranty Repair	10
TROUBLESHOOTING	11
INFORMATION ON LAMP WARRANTY	11
SF MODEL OPTIONAL ACCESSORIES	12
HD MODEL OPTIONAL ACCESSORIES	13

SPECIFICATIONS

SF MODEL Dimensions	5.6" H x 16.4" W x 17.8" D (Folded) 32" H x 16.4" W x 17.8" D (Opened)
HD MODEL Dimensions	8.5" H x 16.4" W x 17.8" D (Folded) 32" H x 16.4" W x 17.8" D (Opened)
Aperture	6000, 5510 — 11.2" x 11.2" (A4) 3000, 3010, 4010, 4030 — 10.5" x 10.5"
Lens	3000 — Single Element, 293mm (11.5") 3010, 4010, 5510 — Three Element, 327mm (13.0") 4030, 6000 — Four Element, 280mm (11.0")
Lamp	3000, 3010 — 360W, ENX 4010, 4030, 5510, 6000 — 410 W, FXL
Elevation	Up to 20 Degrees
Focus	Rack and Pinion
Power	3000, 3010 — 120V, 60Hz, 4.4A 4010, 5510 — 120V, 60Hz, 9.8A 4030, 6000 — 120V, 60Hz, 10.3A
SF MODEL Power Cord	3-Wire Grounded, 10 Ft.
HD MODEL Power Cord	3-Wire Grounded, 10 Ft.
Safety	Safety Interlock System, Automatic Thermal Cutoff
SF MODEL Weight	19 Lbs.
HD MODEL Weight	22Lbs.

ELECTRICAL SAFETY GROUNDING INSTRUCTIONS

This Class I product uses a three-wire power cord that grounds the product for your protection. Do not DEFEAT or REMOVE the grounding pin. If an extension cord is used, it must also be a three-wire type with an ampere rating equal to or greater than the product's rating. The plug must be connected to a properly grounded three-terminal power receptacle. Connection to any other type of receptacle should be done only by a qualified electrician in accordance with local and/or national electrical codes.

INDEX OF FUNCTIONAL PARTS

A number of terms are used frequently in this instruction booklet. The OVERHEAD PROJECTOR will be easier to operate if you become familiar with the terms for the functional parts listed below:

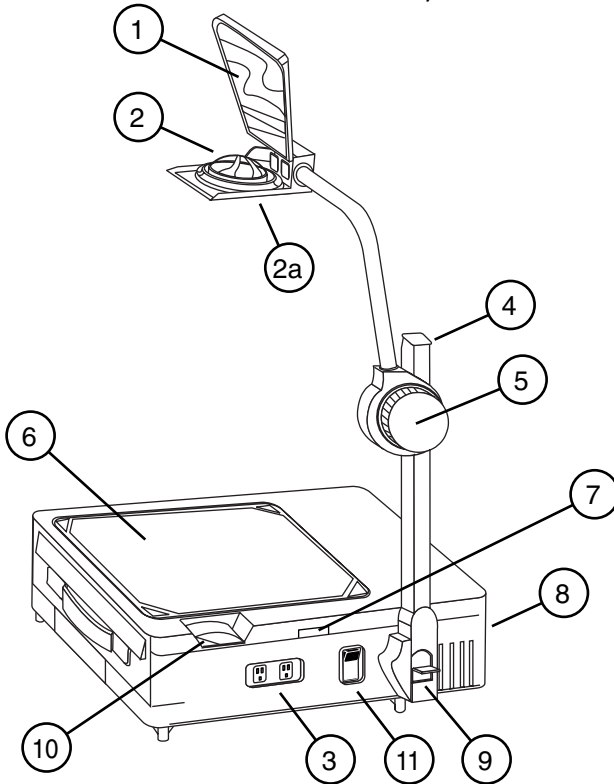

- 1. Mirror;** use to direct projected image
- 2. Projection Head;** rotates 180° to allow projection in different directions or onto different screens
- 2a.** Rotate in 4th element magnification lens (Models 6000 and 4030) for enlarged image from same distance
- 3. 120V AC Outlet;** for use with LCD panel/computer connection (4010, 4030, 5510, 6000 models only — 5A MAX!)
- 4. Mast;** rack & pinion focusing mechanism
- 5. Focus Knob;** turn to focus projected image
- 6. Stage;** place presentation media here for projection
- 7. Stage Latch;** release for lamp access
- 8. Base Housing**
- 9. Locking Collar;** push down to release mast (foldaway design)
- 10. Power Switch**
- 11. High/Low Switch;** (4010, 4030, 5510, 6000 models only)

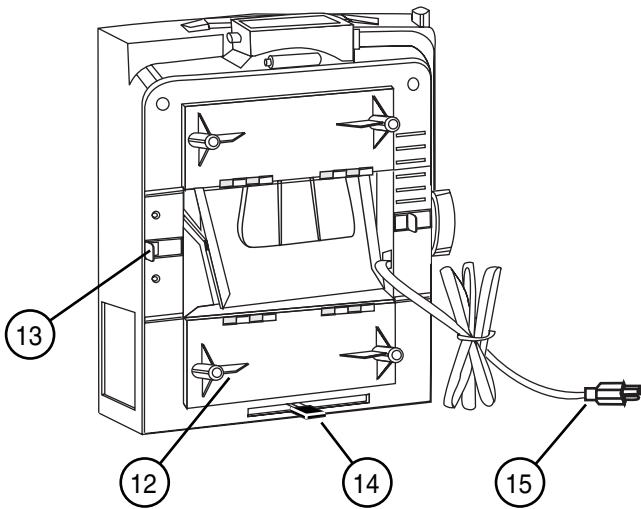

12. Door Leg Assembly; close for foldaway design, cord storage

13. Door Latch (one each side); keeps doors closed

14. Lamp Change Lever; slide for replacement/reserve lamp

15. Power Cord; stored in the unit's base

Models 6000 and 4030 also feature a soft start power supply which extends lamp life, reduces operating costs and ensures a smoother, flicker-free image.

SETUP INSTRUCTIONS SF MODELS

1. Set unit on projection table in the vertical position (handle up).
2. Slide bottom door latches out and swing both doors around to magnet latches. Pull out the entire power cord. Leave doors **open**.
3. Tip unit over to rest on its legs. (Doors act as feet for the unit).
4. Turn focus knob clockwise until it stops at the end of the mast.
5. Rotate mast up until it locks into place.
6. Rotate the projection head assembly counterclockwise to the working position.
7. Open mirror.

STEP 1 —

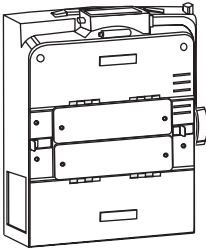

STEP 2 —

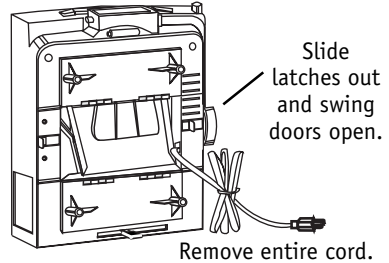

STEP 3 —

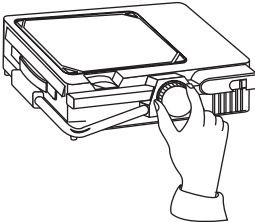

STEP 4 —

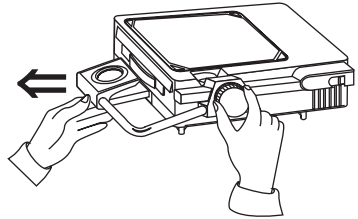

STEP 5 —

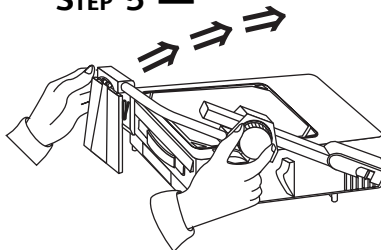

STEP 6 —

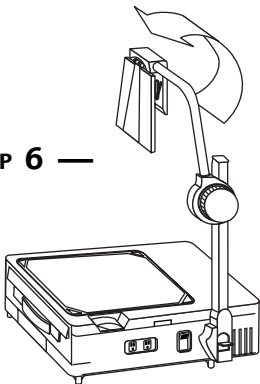

STEP 7 —

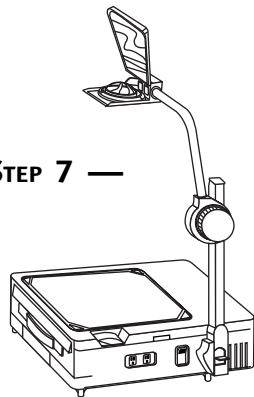

FOLDUP INSTRUCTIONS

Perform Setup Steps in reverse order.

- Unlock/lower mast by pushing down on lock collar as shown.

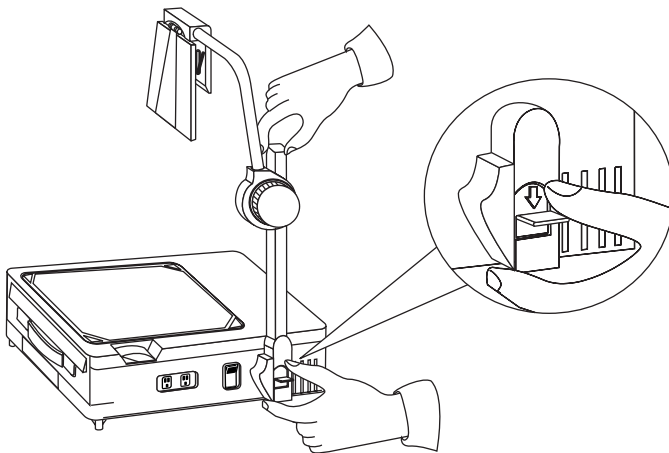

SETUP INSTRUCTIONS HD MODELS

1. Set unit on projection table and pull out the power cord from cord storage compartment.
2. Turn focus knob clockwise until it stops at the end of the mast.
3. Rotate mast up until it locks into place.
4. Rotate the projection head assembly counterclockwise to the working position.
5. Open mirror.

STEP 1 —

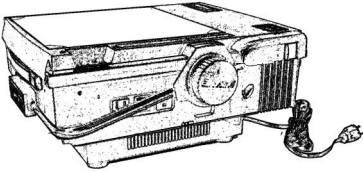

STEP 2 —

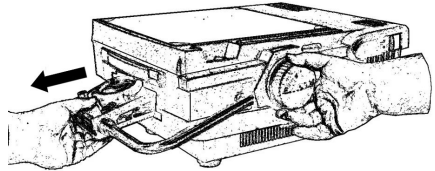

STEP 3 —

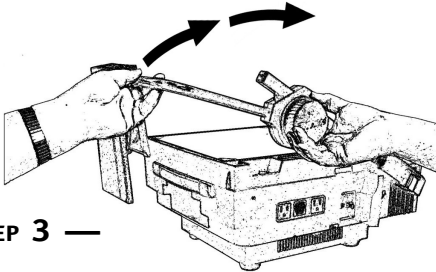

STEP 4 —

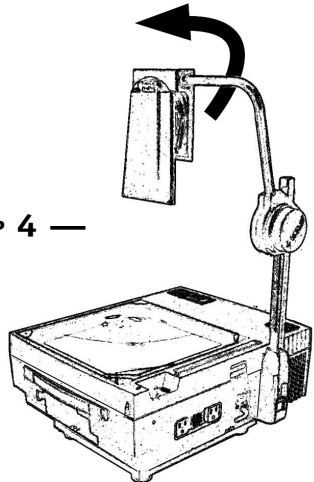

STEP 5 —

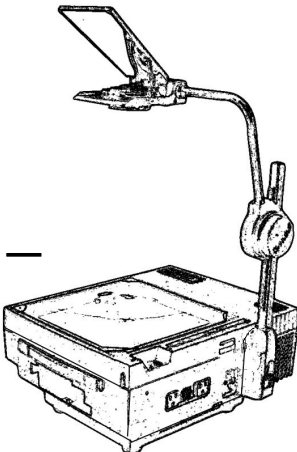

OPERATION

Place the projector on a stable surface that is desk or table height. Make sure that the side vent is not blocked. Plug the power cord into a standard 120V AC outlet. Push the power button to turn the projector on.

I = ON
O = OFF

Place a transparency on the stage. Adjust the focus by turning the focus knob. You may alternate between the wide angle (SF6000 & 4030) and standard lens by rotating the 4th element lens towards or away from the projection head (some adjustment on screen-to-projector distance may be necessary).

Image Adjustment

- A. Position the projected image on screen (height location) by adjusting mirror angle.
- B. Correct the image tilt or change projection direction by rotating the lens/mirror assembly as required.

STEP A —

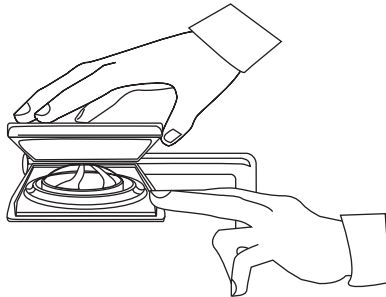

STEP B —

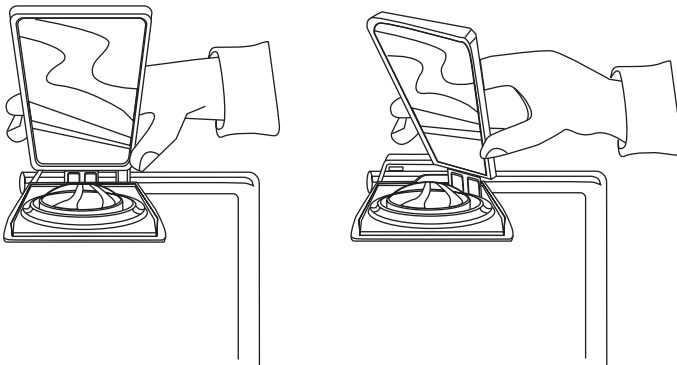

High/Low Lamp Switch

When using with an LCD panel, use the projector at its brightest lumen output (Models 6000, 5510, 4030, 4010).

Reduce light output (High/Low switch) to extend lamp life. Ideal when using regular transparencies.

Lamp Changer

The lamp changer allows you to quickly replace a failed lamp. Turn the power switch "OFF." Simply push slightly, then slide the lamp changing lever towards the side labeled "RESERVE."

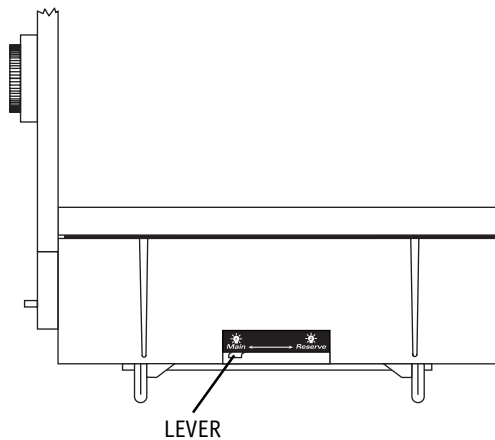

CAUTION: If the OHP is brought directly from a cold to a warm location or it is placed in a very humid room, moisture may condense on electrical and optical parts in the unit. If this occurs, wait for OHP to reach room temperature before turning it "ON."



CAUTION

Do not overload 120V AC outlets with accessories that exceed a total of 5 amps.

LAMP REPLACEMENT

Your projector uses:

3000, 3010 — 360W, ENX.

4010, 4030, 5510, 6000 — 410W, FXL.



WARNING

Lamp and adjacent metal parts are hot. Allow lamp to cool before replacing. Glass components may shatter. Handle carefully.

To Remove an Exhausted Lamp:

1. Remove the lamp by squeezing the lamp retainer clip and remove lamp.
2. Avoid touching the new lamp — oily skin can cause discoloration of the lamp capsule or reflector.
3. Push the new lamp down into socket until firmly seated and the reflector lines up with the aperture. Re-engage the lamp retainer clip.

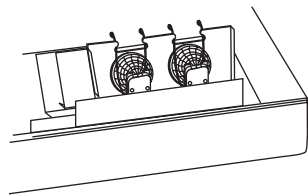
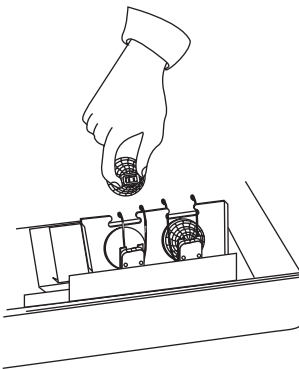
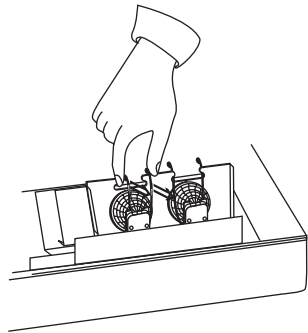
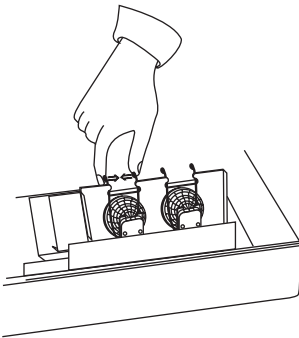

CLEANING

For best performance, keep your projector free of dust and surface dirt. Keep covered when not in use.

Daily Cleaning: Use a soft, lint-free cloth to remove dust from stage glass, projection lens and magnifier lens (6000 and 4030 models only). Lens cleaner may also be used on these components.

Projection Mirror: Do not attempt to clean this mirror with cleaning agents — use a soft lens brush to remove dirt.

Fresnel Lens: Use a soft, lint-free cloth or soft brush to remove dust. Use of cleaning agents may damage optics. Disassembly is not recommended.

SERVICING

Shipping Information

If it becomes necessary to return a unit, please use the original packing material or pack securely to insure safe shipment.

Service

Service and parts are available from Dukane or from an approved service station. Contact the Dukane Service Department at 1-800-676-2487 to order parts or for the nearest service station. Service manuals are also available at a nominal cost.

No Charge Warranty Repair

Your unit must be taken or sent to Dukane or to an approved service station with your sales receipt.

TROUBLESHOOTING

Symptom	Probable Cause	Solution
Neither lamp or fan operate	<ul style="list-style-type: none"> a. Unit unplugged b. No power at wall outlet c. Stage lid not closed d. Mirror box not lowered, (interlock switch not activated) e. Blown fuse 	<ul style="list-style-type: none"> a. Plug unit into outlet b. Verify outlet has power c. Close stage lid d. Open bottom doors and insure mirror box lowers e. Call service
No lamp, fan runs	<ul style="list-style-type: none"> a. Burned-out lamp b. Lamp changer not engaged c. Lamp not seated in receptacle 	<ul style="list-style-type: none"> a. Replace lamp b. Slide changer arm into position c. Seat lamp
New lamp installed, lamp still not on, fan runs	<ul style="list-style-type: none"> a. Defective lamp b. Defective electrical system 	<ul style="list-style-type: none"> a. Try another new lamp b. Call service
No fan, lamp on	<ul style="list-style-type: none"> a. Fan is obstructed b. Fan motor has burned out 	<ul style="list-style-type: none"> a. Call service b. Call service

Call Service at 1-800-676-2487.

INFORMATION ON LAMP WARRANTY

Projection lamps are warranted by the lamp manufacturer and not by the equipment manufacturer. If you have a lamp which you believe to be defective, contact the manufacturer of that particular lamp for the appropriate warranty replacement.

A BULB, Inc.
 134 Golden Gate Ave., Suite B
 San Francisco, CA 94102
 1-888-882-2852

WIKO Ltd.
 10490 W. 164th Place
 Orland Park, IL 60462-5495
 1-800-524-1754

Osram-Sylvania Products, Inc.
 100 Endicott St.
 Danvers, MA 01923
 1-888-677-2627

General Electric Company
 1501 South 19th Street
 Mattoon, IL 61938
 1-800-435-2677

OPTIONAL ACCESSORIES SF MODELS

ENX LAMP
360W/82V
456-188
(Models 3000/3010)



FXL LAMP
410W/82V
456-192
(Models 4010, 4030, 5500, 6000)



SOFT SHOULDER BAG
(PADDED)
128-46



ROLL FILM
ADAPTER KIT
438-814



HARD-SIDED
CARRYING CASE
185-398



ATA SHIPPING CASE
185-397



ACETATE ROLL (50')
310-6



PROTECTIVE
DUST COVER
128-61

To order
accessories,
please call
1-800-676-2487.

OPTIONAL ACCESSORIES HD MODELS

<p>ENX LAMP 360W/82V 456-188 (Models 3000/3010)</p>  <p>FXL LAMP 410W/82V 456-192 (Models 4010, 4030, 5500, 6000)</p>	 <p>SOFT SHOULDER BAG (PADDED) 128-1</p>	 <p>ROLL FILM ADAPTER KIT 438-814</p>
 <p>HARD-SIDED CARRYING CASE 185-385</p>	 <p>ATA SHIPPING CASE 185-397</p>	

**To order
accessories,
please call
1-800-676-2487.**

Part # 401-545-05

Free Manuals Download Website

<http://myh66.com>

<http://usermanuals.us>

<http://www.somanuals.com>

<http://www.4manuals.cc>

<http://www.manual-lib.com>

<http://www.404manual.com>

<http://www.luxmanual.com>

<http://aubethermostatmanual.com>

Golf course search by state

<http://golfingnear.com>

Email search by domain

<http://emailbydomain.com>

Auto manuals search

<http://auto.somanuals.com>

TV manuals search

<http://tv.somanuals.com>