

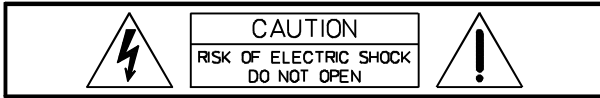

DSP 244

24 BIT DIGITAL SOUND SYSTEM PROCESSOR

IMPORTANT SAFETY INSTRUCTIONS



WARNING: TO REDUCE THE RISK OF FIRE OR ELECTRIC SHOCK,
DO NOT EXPOSE THIS APPLIANCE TO RAIN OR MOISTURE.
AVIS: RISQUÉ DE CHOC ELECTRIQUE. NE PAS OUVRIR.



The lightning flash with arrowhead symbol, within an equilateral triangle is intended to alert the user to the presence of uninsulated "dangerous voltage" within the product's enclosure that may be of sufficient magnitude to constitute a risk of electric shock to persons.



The exclamation point within an equilateral triangle is intended to alert the user to the presence of important operating and maintenance (servicing) instructions in the literature accompanying the appliance.

1. Read these instructions.
2. Keep these instructions.
3. Heed all warnings.
4. Follow all instructions.
5. Do not use this apparatus near water.
6. Clean only with a damp cloth.
7. Do not block any of the ventilation openings.
Install in accordance with the manufacturer's instructions.
8. Do not install near any heat sources such as radiators, heat registers, stoves, or other apparatus that produce heat.
9. Only use attachments/accessories specified by the manufacturer.
10. Refer all servicing to qualified service personnel. Servicing is required when the apparatus has been damaged in any way, such as power-supply cord or plug is damaged, liquid has been spilled or objects have fallen into the apparatus, the apparatus has been exposed to rain or moisture, does not operate normally, or has been dropped.

For US and CANADA only:

Do not defeat the safety purpose of the grounding-type plug. A grounding type plug has two blades and a third grounding prong. The wide blade or the third prong are provided for your safety. When the provided plug does not fit into your outlet, consult an electrician for replacement of the obsolete outlet.

IMPORTANT SERVICE INSTRUCTIONS

CAUTION: These servicing instructions are for use by qualified personnel only. To reduce the risk of electric shock, do not perform any servicing other than that contained in the Operating Instructions unless you are qualified to do so. Refer all servicing to qualified service personnel.

1. Security regulations as stated in the EN 60065 (VDE 0860 / IEC 65) and the CSA E65 - 94 have to be obeyed when servicing the appliance.
2. Use of a mains separator transformer is mandatory during maintenance while the appliance is opened, needs to be operated and is connected to the mains
3. Switch off the power before retrofitting any extensions, changing the mains voltage or the output voltage.
4. The minimum distance between parts carrying mains voltage and any accessible metal piece (metal enclosure), respectively between the mains poles has to be **3 mm** and needs to be minded at all times.
The minimum distance between parts carrying mains voltage and any switches or breakers that are not connected to the mains (secondary parts) has to be **6 mm** and needs to be minded at all times.
5. Replacing special components that are marked in the circuit diagram using the security symbol (Note) is only permissible when using original parts.
6. Altering the circuitry without prior consent or advice is not legitimate.
7. Any work security regulations that are applicable at the location where the appliance is being serviced have to be strictly obeyed. This applies also to any regulations about the work place itself.
8. All instructions concerning the handling of **MOS** - circuits have to be observed.

Note:  **SAFETY COMPONENT (HAS TO BE REPLACED WITH ORIGINAL PART ONLY)**

CONTENTS

TABLE OF CONTENTS	PAGE
SAFETY AND SERVICE INSTRUCTIONS	1-2
1. INTRODUCTION	1-4
1.1 DSP 244 Features	1-4
1.2 Unpacking and warranty	1-4
2. CONTROLS AND CONNECTIONS	2-1
2.1 Front panel	2-1
2.2 Rear panel	2-3
3. INSTALLATION AND CONNECTIONS	3-1
3.1 Balanced input / output configuration	3-1
3.2 Unbalanced input / output configuration	3-1
4. FIRST OPERATION	4-1
4.1 Switching the power on	4-1
4.2 Level settings	4-1
5. QUICK START	5-1
6. CONFIGURATIONS OF THE DSP 244	6-1
6.1 Stereo 2 Way	6-2
6.2 Stereo 2 Way / Mono Sub + Fullrange	6-2
6.3 3 Way + Fullrange	6-3
6.4 3 Way / Mono Sub + Fullrange	6-3
6.5 3 Way / Independent Sub + Fullrange	6-4
6.6 4 Way	6-4
6.7 2-IN-4	6-5
7. OPERATION	7-1
7.1 Program Selection	7-2
7.2 Edition	7-2
7.3 Store Programs and Program Names	7-4
7.4 Modifying Factory-Preset-Programs	7-5
8. PARAMETERS	8-1
8.1 Parameter Access	8-2
8.1.1 Parameter Access-Table	8-2
8.1.2 Parameter Link-Table	8-3
8.2 Description of Parameters	8-3
9. OPTION-FUNCTIONS	9-1
9.1 Setting the LCD-Contrast	9-1
9.2 Edit Mode Selection	9-1
9.3 Compressor and Limiter Threshold Unit	9-2
9.4 VU Level Meter Display Mode	9-2
9.5 Edit Protection	9-2
9.6 Temperature Unit settings	9-3
9.7 MIDI RX / TX Channel settings	9-3
9.8 Send Parameters	9-4
9.9 RS-232 To MIDI data transmission	9-4
9.10 NRS 90246 Contact Closure Interface settings	9-5
9.11 NRS 90247 RS-485 Interface Settings	9-6
9.11 Display of the Software Revision Number	9-6
10. SPECIFICATIONS	10-1
10.1 Specifications	10-1
10.2 MIDI	10-2
10.3 Retrofitting Instructions	10-5
10.3.1 Installation manual for the input transformer (NRS 90244)	10-5
10.3.2 Installation manuals for interface cards	10-6
10.4 Block diagram	10-7
10.5 Flow diagram	10-8
10.6 Dimensions	10-9
10.7 Warranty	10-10

INTRODUCTION

1. INTRODUCTION

First of all, we would like to thank you for and congratulate you on buying the DYNACORD Digital Sound System Processor DSP 244. To ensure an optimum in the performance of the appliance and to prevent any damage resulting from erroneous or inadvertent handling or operation, please read this owner's manual carefully, before operating the DSP 244.

1.1 DSP 244 FEATURES

Providing 48-bit filter algorithms, 24-bit AD/DA conversion and a dynamic range of 115 dB, the DSP 244 sets new standards for digital loudspeaker controllers and processors. The DSP 244 is an universal Digital Sound System Processor that provides 2 inputs and 4 outputs; plus internal summing of the inputs 1 and 2. Via matrix it is possible to assign the outputs to any input or to the sum of the inputs. It is further possible to establish the following configurations: Stereo or Dual 2-Way systems, 3-Way + Direct and 4-Way systems, each with Mono Sub-channel, but also full range systems.

High and low-pass filters are provided for the frequency crossover functions in all operation modes. The selection includes Linkwitz-Riley, Butterworth and Bessel type filters with switchable slopes between 6, 12, 18 and 24 dB/oct. A huge number of additional filters offers extremely flexible correction of the frequency response. Each input incorporates a 5-band equalizer, allowing to assign high and low-pass, high and low-shelving or parametric peak-dip filters to its individual filter sections. Next to the frequency crossover filters, four additional filters are employed in each output channel, which also can be set to work as high or low-pass, high or low-shelving filters, parametric peak-dip filters, or all-pass filters. Additional filtering is provided through 2. order high-passes for the realization of B-6 alignment, or special LPN-filters (Low-Pass Notch filters) for correcting the frequency and phase responses of optimally vented woofer cabinets. Each channel additionally provides a delay, a polarity switch, a programmable level control and a digital compressor / limiter while the master delays are located in the input channels.

The user can choose between two operation modes: the "No Edit Mode" allows to simply select the required combination of loudspeaker systems from the factory preset program list. Afterwards, the appliance is optimally matched to the sound system and can be operated instantly. The "Full Edit Mode" on the other hand offers access to all parameters, allowing to freely program and store basically any setting. A total number of 80 memory addresses - 50 preset and 30 freely assignable user-programs - are available.

Within the DSP 244, AD/DA conversion is taken care of by linear 24-bit converters; where the AD-section employs 128 times oversampling, gain-ranging Sigma-Delta converters. The DA-section offers 128 times oversampling Sigma-Delta converters. The overall signal processing is performed by two 24-bit Motorola signal processors.

Additional features are:

- FLASH memory for software and preset updates via serial interfaces
- PC-based operation and configuration software running under Windows '95 / Windows '98
- Standard MIDI-interface and RS-232 interface
- RS-485 interface or switching contacts optionally available
- Back-lit graphic-display with 122 x 32 dots
- Inputs and outputs are electronically balanced, XLR-type connectors
- Input transformer-balancing is optionally available
- Input / Output level controls, Output-Mute switch, channel function indicators SUB, LO, MID, HI
- Input / Output meter instruments, compressor and clipping LEDs

Within this owner's manual many of the DSP 244's extensive features are explained in detail. Keep the manual stored at a safe place to have it at hand for any further reference.

1.2 UNPACKING AND WARRANTY

Carefully open the packaging and take out the DSP 244. Remove the protective foil from the plexiglas of the LC-display. Next to this owner's manual, the appliance is shipped together with mains cord and warranty card. Please make sure that the warranty card has been completed. Only with a fully completed warranty certificate any possible warranty claims can be granted. The appliance comes with a 36 months warranty which is valid starting with the original date of purchase; respectively when receiving the device from your dealer. Please keep the warranty certificate, the original invoice and also the original packaging at a safe place for any eventual shipping.

2. CONTROLS AND CONNECTIONS

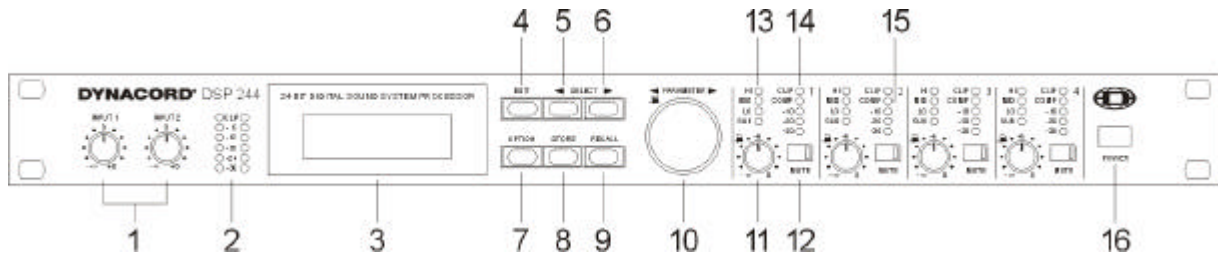

2.1 FRONT PANEL

1, Control INPUT 1 / INPUT 2

Rotary controls to set the input levels of the inputs 1 and 2 of the DSP 244.

The input signal can be amplified by up to 6 dB (control set to its clockwise margin) or attenuated by any degree. Set the level as high as possible without clipping to achieve the highest possible S/N ratio. Checking your settings is possible via the reading of the two level meter instruments.

2, Level meters

The level meter instruments are meant for optical monitoring of the input signal levels, individually showing the peak value of the correspondent input signal. The input control should be set to a position so that the meter instruments indicate a level between -6 and -12 dB. To prevent internal clipping, make sure that the clip-LEDs are not lit. Two different indication modes can be selected: "Peak Hold"-function or "Slow Mode".

3, Graphic display

In the PLAY mode this 122 x 32 dots LC-display shows the name of the program, its number, name and description of the chosen loudspeaker systems, as well as the momentary active configuration. In EDIT mode the display shows the function blocks including their individual parameters and parameter values. Additionally and depending on the actually chosen mode, the display also indicates option menus, status messages, short operational notes, etc.

4, EDIT-key

This key allows to enter the EDIT mode. After pressing the button, the first or the last modified parameter of the active program is displayed. Other parameters are selected through the use of the SELECT-keys. The individual value of the momentary displayed parameter can be altered by means of the rotary encoder. For further information, please refer to chapter 7.2, "EDITING".

5, SELECT-key <

While in EDIT mode, pressing the key selects the corresponding previous parameter. In the Option mode, it is used to select the corresponding previous "Option Page" and in the Store mode, pressing this key switches between program number and name editing.

6, SELECT-key >

While in EDIT mode, the key is used to select the corresponding next parameter. In the Option mode, it serves to select the corresponding next "Option Page" and in the Store mode, pressing this key switches between program number and name editing.

7, OPTION-key

The OPTION-key is used to enter the OPTION menu, allowing the user to alter and check appliance-related settings. For further details, please refer to chapter 9, "OPTION FUNCTIONS".

CONTROLS AND CONNECTIONS

8, STORE-key

This key allows the user to store edited programs in one of the user-definable program presets (U01 - U30) or to copy programs from one preset to another. For further information, please refer to chapter 7.4, "STORE PROGRAMS AND PROGRAM NAMES".

9, RECALL-key

Pressing this key lets you enter the PROGRAM SELECTION mode where you can select factory or user-definable program presets through using the rotary encoder. By pressing the RECALL-key, the selected program is acknowledged and gets loaded.

For further information, please refer to chapter 7.1, "PROGRAM SELECTION".

10, Rotary encoder with push-button function

While in PROGRAM SELECTION mode, rotating the encoder selects the desired program. It is activated by pressing the RECALL-key. In EDIT mode, the encoder lets you alter parameter setting or leaf through function blocks. Simultaneously dialing the encoder while keeping it pressed increases the speed in which the parameter values are changed. For further details, please refer to the chapter "OPERATION" starting on page 7-1.

11, OUTPUT-controls 1 - 4

These rotary controls are used to set the output levels of channels 1 to 4, allowing to match the DSP 244 to the input levels of the devices chained in sequence. Correctly setting these controls results in an improved S/N ratio. In most cases, good results are achieved when setting the controls to their center position (-6). The digital output gain control should be used when higher output levels are needed. Use the rotary controls OUTPUT 1 - 4 to attenuate the output levels. It is not recommended to use the digital output gain control for massive attenuation, since this would decline the dynamic range of the D/A-converters.

The rotary controls also provide push-button-functionality, which, in the EDIT mode is used to switch between function blocks, channel-related; i. e.: pressing a rotary control switches to the corresponding output channel. For further details, please refer to chapter 7.2, "EDITING".

12, MUTE-keys 1 - 4

These keys allow to mute the output signal of the corresponding output channels. Pressing a key once switches the mute-function ON; the key's red LED lights. Pressing the button again switches the mute-function OFF; the key's LED is dimmed again.

13, Channel function indicators SUB, LO, MID, HI

These LEDs indicate, which frequency band the corresponding channel is set to. If a channel is configured for full range operation, all its function-LEDs are simultaneously lit.

14, Level meter indicators OUTPUT 1 - 4

These LEDs indicate the peak level of the corresponding outputs. The DSP 244 should be operated in a range, so that the clip-LEDs are not lit. Otherwise, this could lead to internal clipping. The indicators can be set to "Peak-Hold" or "Slow-Mode".

15, Compressor indicators OUTPUT 1 - 4

The COMP-LEDs light, when the compressor / limiter of the corresponding channel is activated; e. g.: when the audio signal level exceeded the previously set threshold and therefore the output level is compressed or limited.

16, POWER ON/OFF-switch

This switch turns the DSP 244's mains power on or off.

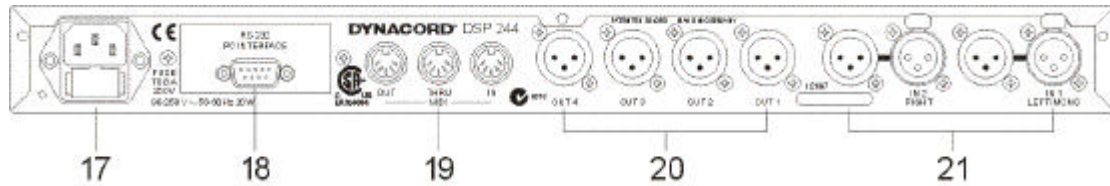

2.2 REAR PANEL

17, Mains connector

Connect the supplied mains cord to the mains connector. The DSP 244 is capable of handling mains voltages between 90 V AC to 250 V AC, so that switching the mains on the appliance is not necessary.

18, RS-232 Interface

This is the data communication interface between the DSP 244 and a PC. It allows unit configuration and editing by using the DSP 244 Editor software.

At this position installation of optional interface boards is possible, also. Available are: a RS-485 interface and a card for the connection of switching contacts (switches, relays) for remote program selection. For further details about the cards and their installation, please refer to the chapters "OPTION FUNCTIONS", starting on page 9-5 and "RETROFITTING INSTRUCTIONS", starting on page 10-6.

19, MIDI IN / THRU / OUT connectors

These sockets allow to control several DSP 244 via a single master unit. Exchanging memory contents in both directions is possible as well. Via MIDI, data communication between the DSP 244 and a computer's desktop is possible as well, providing that a standard MIDI-interface has been installed in your PC / Notebook.

20, OUT 1 - 4 connectors

These are the 4 balanced outputs of the DSP 244. The signals of these sockets supply different frequency bands, depending on the appliance's configuration (2-WAY, 3-WAY, 4-WAY). Please make sure that your power amplifiers and/or loudspeaker systems are always connected to the correct output channel. The individual configuration of the output channels is displayed through the "channel status indicators" on the front panel.

The pin-assignment of the inputs and outputs is explained in detail in chapter 3.

21, IN 1 / IN 2 connectors

These are the 2 balanced inputs of the DSP 244. Each input employs a Direct Out connector which allows to feed the unaltered input signal to another DSP 244 or to any other device that needs to be operated with the unaltered source signal. In stereo or dual mode as well as in the monaural sub woofer mode, both connectors (LEFT / RIGHT) have to be connected accordingly. For all other operation modes using only the IN 1 (MONO) connector is sufficient. The pin-assignment of the inputs and outputs is explained in detail in chapter 3. Connection-examples for different configurations are provided in chapter 6.

INSTALLATION AND CONNECTIONS

3. INSTALLATION AND CONNECTIONS

Correct connections is a vital factor in achieving the best results with the DSP 244. Before switching on the power you have to connect the supplied European standard mains cord to the DSP 244 and your mains wall outlet. The power supply unit of the DSP 244 automatically adapts to supply voltages in a range of 90 to 250 VAC, so that the appliance can be operated with different, country-specific mains voltages.

To prevent any trouble occurring from high temperatures inside the appliance, it is advisable not to use the DSP 244 in environments with ambient temperatures exceeding 40°C; sufficient air-flow is also always important. One HU is necessary for rack-installation. Normally, in this case, there are no special measures for ventilation necessary. Like with any other LF-signal processing unit, it is not recommended to install or operate the DSP 244 directly above or below any device that generates a massive magnetic field; e. g. power amplifiers. In this way the risk of unwanted interference is reduced to a minimum.

Before switching the DSP 244's power on, make sure that all necessary connections have been established. So, make the required input and output connections in advance and in accordance to the desired configuration.

IMPORTANT:

- Always use correctly shielded audio cables.
- To prevent loosing treble frequencies, especially input cords should not exceed a length of 10 m

3.1 Balanced INPUT/OUTPUT configuration

For best results, the DSP 244 is operated using its balanced inputs and outputs. In this configuration, the cable's non-inverting conductor (+) needs to be assigned to pin 2 of the XLR-type connector while the inverting conductor (-) is assigned to the connector's pin 3. The shielding has to be connected to pin 1. If the input channels supply transformers for galvanic isolation, the cable screen should not be connected to the ground plain of the transmitting device.

3.2 Unbalanced INPUT/OUTPUT configuration

It is also possible to operate the appliance in unbalanced input/output configuration. Therefore, the cable's "HOT" conductor has to be connected to pin 2 and the screen to pin 1 of the XLR-type connector.

To prevent the level being attenuated by 6dB, you have to short-circuit pins 1 and 3 of the XLR-type connector. In case this measure leads to interference noise, removing this connection is recommended.

The following shows examples for balanced and unbalanced pin-assignments of audio cables, like they can be used with the DSP 244.



4. FIRST OPERATION

4.1 SWITCHING THE POWER ON

Using the POWER-switch (16) the DSP 244's power is switched on. Upon initializing is complete, the last program that had been active before turning off the appliance is recalled. For now, the display shows:

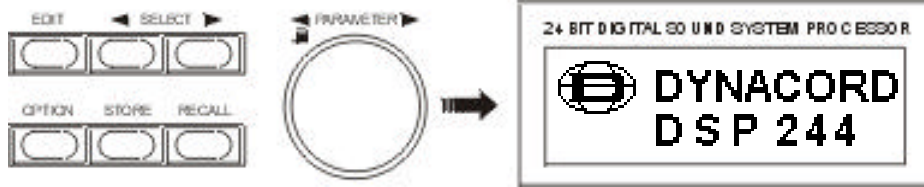

Now, the DSP 244 is ready for operation. The display shows for instance:

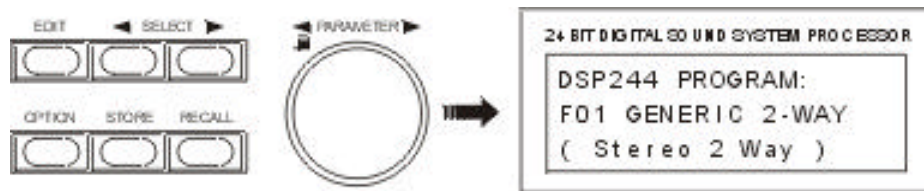

Here, you have entered the factory preset program F01, which is an universal program for the 2-way operation. The configuration is stereo 2-way - the initial state of the DSP 244 when shipped from the factory. In case the appliance had been operated before, any other program might appear on the display.

For setting the DSP 244 in accordance to the configuration of your sound system, the best way to start is to select a factory preset program from the list that matches your actual system configuration (see chapter 7.1, PROGRAM SELECTION). You can copy this program to a user-definable preset and alter the settings according to your personal preferences (see chapter 7.4, STORE PROGRAMS AND PROGRAM NAMES, and chapter 7.2, EDITING).

4.2 LEVEL SETTINGS

To simultaneously achieve maximum headroom and minimal noise, the DSP 244 has to be properly integrated into the gain structure of the entire audio system.

You can set the desired input level of the DSP 244 using the two INPUT controls (1). Therefore, operate the system at the highest signal level that is to be expected in the further operation. Slowly turn the INPUT control (1) clockwise, while continuously monitoring the level meters (2) for peak readings. The optimal value for program peaks lies between -12dB and -6dB. The CLIP-LED's indicate clipping of the AD-converter and should not light at all or at least only very briefly. When driving the DSP 244 below the mentioned range, its outstanding S/N ratio is not optimally used, resulting in probably audible system noise.

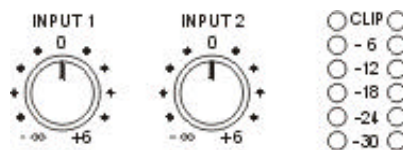

QUICK START

5. QUICK START

This paragraph describes in an overview the most important steps for a trouble-free operation of the DSP 244 in your PA-system. For a more detailed description of specific functions and parameters, please refer to the corresponding paragraph in the handbook.

MAINS CONNECTION

Plug in the supplied mains cord. Since the integrated power supply is capable of handling AC voltages between 90 V and 250 V, 50 / 60 Hz, within these limits no adjustments or switching is necessary.

AUDIO CONNECTIONS

Before integrating and operating the DSP 244 in your PA-system, you should determine which system configuration you are using. Chapter 6, CONFIGURATIONS OF THE DSP 244, provides you with a complete description of all possible configurations including their specific input and output assignments. Connect the appliance according to the chosen configuration. Do not feed in any audio signal yet.

POWER-ON OPERATION

After installing the DSP 244 in your PA-system setup and before operating it for the first time, please set the input controls INPUT1 / INPUT2 all the way counterclockwise, so that at this moment no audio signal is fed to the audio outputs. The appliance is factory-pre-set to the program F01 which is a universal preset for stereo 2-way operation. In case the appliance had previously been operated, it can start-up with any other program or configuration.

PROGRAM SELECTION

Together with the DSP 244 you receive a listing of all available factory presets. In case you are using a DYNACORD loudspeaker system that is listed, just select the corresponding program number and your PA-system is optimally configured.

If your loudspeaker system is not listed try a Generic preset together with a suitable configuration. Generic presets are available for all 7 configurations, offering preference settings that provide good results with any system setup.

For direct program selection press RECALL, select the desired program using the rotary encoder and to confirm your selection, press RECALL again (see also chapter 7.1, PROGRAM SELECTION).

LEVEL SETTING

Turn the input controls INPUT1 / INPUT2 clockwise, so that the level meters indicate values between -12dB and -6dB; whilst there has to be only a little or no distortion at all. This guarantees best results for the S/N ratio.

CHANGING PARAMETERS

The DSP 244 is factory preset to the NO EDIT mode; e. g. parameter changes are not possible. You have to enter FULL EDIT mode to be able to edit parameters (see also chapter 9.2, OPERATION MODE SELECTION).

Editing factory pre-set programs is not possible. If you want to change the parameters of a factory pre-set program, you have to copy the program to a user definable preset in advance (U01 - U30) and save this preset under a different name (see chapter 7.4, MODIFYING FACTORY PRESET PROGRAMS).

Now you are able to change the parameter values in the EDIT menu; as described in chapter 7.2, EDITING.

X-OVER SETTINGS

In the Edit menu select the desired output channel by pressing the corresponding OUTPUT control. Then use the rotary encoder to select HIPASS XOVER in the display. Here you can set the low-cut frequency for the selected channel. Using the SELECT keys, you are able to select the parameters "Type" or "f" and edit their values through the use of the rotary encoder. After you are done, use the left SELECT key to re-position the cursor to the function block in the top line.

Using the rotary encoder you can now select LOPASS XOVER in the display. Here you are able to adjust the high-cut frequency for the selected channel. Proceed as described above for the low-cut setting.

Pressing another OUTPUT control selects the control's corresponding channel and you are able to edit the parameter settings of this output channel. Again, proceed following the descriptions above.

Parameters are not linked in the Full Edit mode. Thus, you have to make sure that related low and high-cuts are set to the same values and filter characteristics.

LOUDSPEAKER EQUALIZATION

The DSP 244 embodies 4 EQs per channel for each output channel allowing to optimally match the frequency response for the connected loudspeaker components; similar to the factory preset programs. In case you want to program the EQs matching your own set of loudspeaker systems, you should know the exact frequency response of each component to be able to utilize the channel EQs efficiently.

In the EDIT menu, select the desired output channel by pressing the corresponding OUTPUT control. Then, by using the rotary encoder select CHANNEL EQ1 in the display. Here you are able to edit the first filter of this channel. Through use of the right SELECT key you are able to select the parameter "Type" and change its setting with the rotary encoder. Available for "Type" are:

- PEQ (parametric Peak-Dip-Filter)
- LOSLV (Low Shelving Equalizer)
- HISLV (High Shelving Equalizer)
- LOPASS (Lo-Pass)
- HIPASS (Hi-Pass)
- ALLPASS (All-Pass for phase correlation correction)

All other parameters depend on the selected filter type. A complete overview is provided in chapter 8, PARAMETERS. The SELECT keys allow the selection of any parameter and the corresponding values are edited using the rotary encoder.

After you are done, use the left SELECT key to re-position the cursor to the function block in the top line.

Using the rotary encoder you can now select next EQ sections to adjust its frequency response according to your liking.

Pressing another OUTPUT control selects the control's corresponding output channel.

DELAY ALIGNMENT

Using the channel delays, it is possible to compensate construction-related delays of loudspeaker systems or delays that result from different positions of loudspeaker cabinets. Nevertheless, herefore, it is necessary to know the distance between cabinets as precise as possible.

Select the desired output channel in the Edit menu by pressing the corresponding OUTPUT control. Using the rotary encoder you can now select CHANNEL DELAY in the display. The parameters "Delay" or "Unit" are now accessible through the use of the SELECT keys and the rotary encoder can be used to alter their values. Afterwards, use the left SELECT key to re-position the cursor to the function block in the top line.

Pressing another OUTPUT control selects the control's corresponding output channel.

QUICK START

COMPRESSOR / LIMITER SETTINGS

A compressor / limiter automatically reduces level peaks above a certain threshold and therefore provides reliable protection against power amplifier clipping and damaging the connected loudspeaker systems. In most cases it is absolutely sufficient to set the compressor's threshold to the modulation limit of the connected power amplifier.

Select the desired output channel in the Edit menu by pressing the corresponding OUTPUT control. Using the rotary encoder you can now select COMPRESSOR in the display. Now, the SELECT keys can be used to select individual parameters. Their values are altered through the use of the rotary encoder. Afterwards, use the left SELECT key to re-position the cursor to the function block in the top line.

Using the rotary encoder you are now able to select LIMITER in the display. Proceed in the same way as described for the compressor to make the limiter's parameter settings for the selected channel.

Pressing another OUTPUT control selects the control's corresponding output channel.

MATCHING THE FREQUENCY RESPONSE

Using the Master EQs in the input channels of the DSP 244, the PA-system can be easily matched to various environmental and acoustical conditions. In many cases, a graphic equalizer which normally is employed to perform this task is not needed any longer.

In the Edit menu, use the rotary encoder to select MASTER EQ1 in the display. Here you can adjust the first filter of the selected input. Using the right SELECT key, you are able to select the parameter "Type" and alter its setting through the use of the rotary encoder. Available are:

- PEQ (parametric Peak-Dip-Filter)
- LOSLV (Low Shelving Equalizer)
- HISLV (High Shelving Equalizer)
- LOPASS (Lo-Pass)
- HIPASS (Hi-Pass)

All other parameters depend on the selected filter type. A complete overview is provided in chapter 8, PARAMETERS. Using the SELECT keys, you are able to select all parameters and alter their values through the use of the rotary encoder.

Afterwards, use the left SELECT key to re-position the cursor to the function block in the top line.

The rotary encoder can now be used to select another Master EQ to proceed with the shaping of the frequency response. The rotary encoder also serves for selecting the second input channel.

6. CONFIGURATIONS OF THE DSP 244

The DSP 244 offers 7 pre-defined configurations. A configuration is a basic setting that includes the routing of inputs and outputs, the function of the outputs (Sub, Lo, Mid, Hi, Fullrange), as well as the kind and amount of parameters. These 7 configurations are:

- Stereo 2 Way
- Stereo 2 Way / Mono Sub + Fullrange
- 3 Way + Fullrange
- 3 Way / Mono Sub + Fullrange
- 3 Way / Independent Sub + Fullrange
- 4 Way
- 2-In-4

If you do not want to use one of the pre-defined configurations, you have also the possibility to operate the DSP 244 in Full Edit mode. This mode offers access to all parameters and basically any input/output routing can be programmed. Additionally, the output assignment (output function - Sub, Lo, Mid, Hi, Fullrange) is also freely definable. For further information, please refer to the chapters 8, PARAMETERS, and 9, OPTION FUNCTIONS.

- Full Edit

The active configuration is defined by the selected program; i. e.: each program is based on a specific configuration which is also displayed next to the program number and program name.

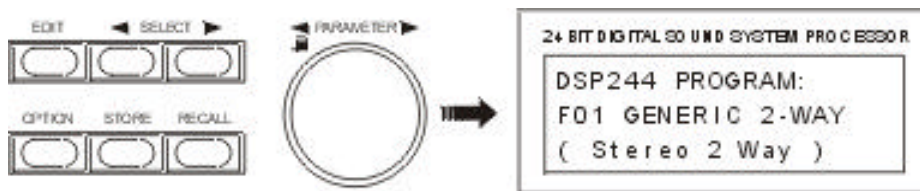

In general, all configurations offer identical signal processing blocks. Five filters are available for either one of the two input signals. These filters can be selected individually and used as parametric EQ's, Low- / High-Shelving filters or Lo-Pass- / Hi-Pass filters. It is further possible to individually assign the delay's total delay time of 5.4 seconds to both input channels, to the sum of the two channels, and/or to the 4 outputs. Each output employs two X-Over filters (Hi-Pass / Lo-Pass). Linkwitz-Riley, Butterworth or Bessel filters (6, 12, 18, 24 dB/oct. slope) can be selected. Each output channel provides 4 additional filters which can be used as parametric EQs, Low- / High-shelving filters, or Lo-Pass and Hi-Pass filters, but also as All-Pass filters. In addition to a gain control for adjusting the output level and a polarity switch, each output is monitored by a digital compressor / limiter with adjustable threshold, attack and release.

In the following chapters you will find a more detailed description of the different configurations.

CONFIGURATIONS OF THE DSP 244

6.1 Stereo 2 Way

This configuration generally represents a 2-way stereo frequency crossover, where IN 1 serves as the left input channel and IN 2 as the right input channel. OUT 1 is the left Low-range output and OUT 2 is the left High-range output. OUT 3 and OUT 4 are the corresponding right Low-range and High-range output channels. The parameters of the inputs 1 and 2 as well as the ones of the Low-range and High-range outputs are always set to identical values; i. e.: the left and right channels are linked. The following figures illustrate the input / output routing of a typical STEREO 2-WAY installation.

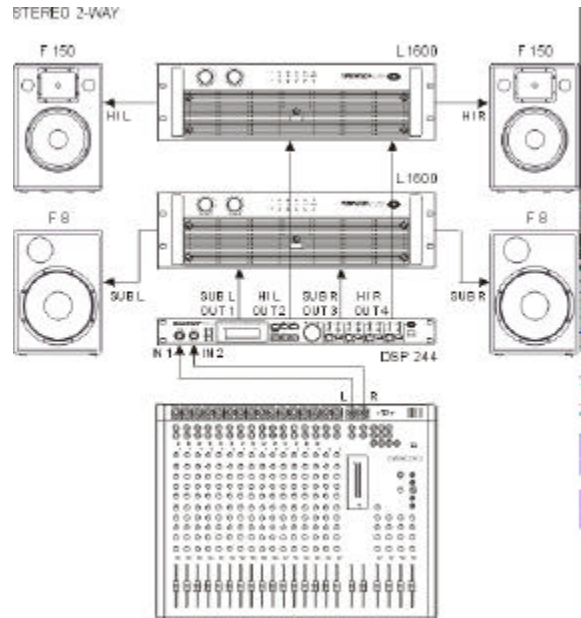
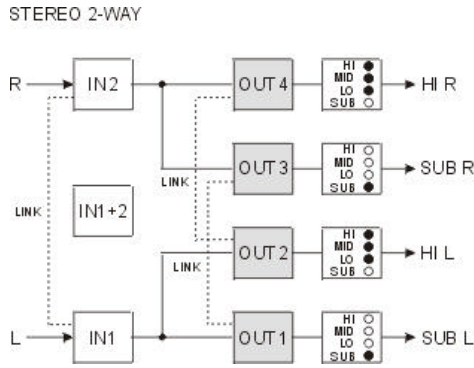

6.2 Stereo 2 Way / Mono Sub + Fullrange

This configuration represents a 2-way frequency crossover with monaural sub-channel and additional Fullrange output. OUT 1 is the sub-channel that is fed by the summed audio signals of the inputs IN 1 and IN 2. OUT 2 and OUT 3 are the left and right High-range output channels. OUT 4 is a Fullrange output that is also fed by the summed signal of the inputs IN 1 and IN 2. For example, this output signal can be used to provide sound reinforcement in adjacent rooms. The parameters of the inputs 1 and 2 as well as the ones of the two High-range outputs are always set to identical values; i. e.: the left and right channels are linked. The following signal flow diagram is meant to illustrate the input / output routing scheme. The figure on the right bottom shows a typical configuration with monaural sub woofer and additional Fullrange installation.

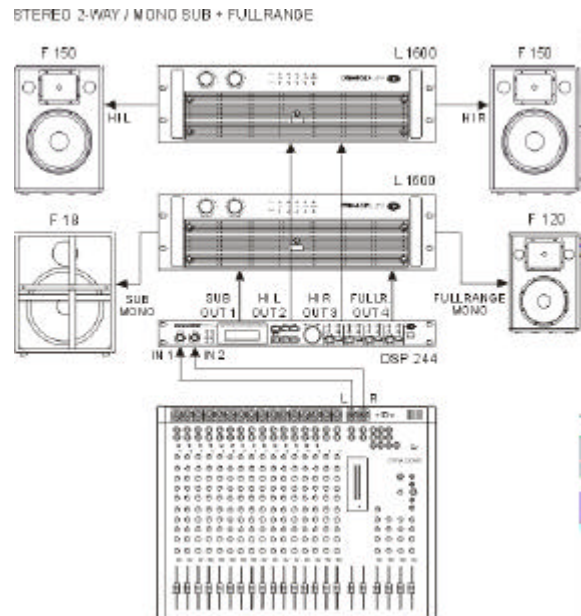
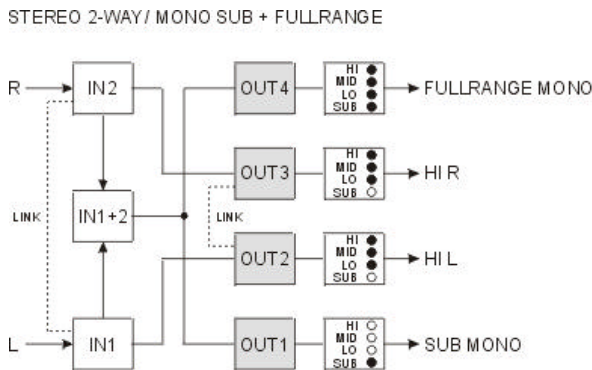

6.3 3 Way + Fullrange

The 3-Way + Fullrange configuration is a 3-way monaural x-over with additional full range output where IN 1 serves as input channel. OUT 1 is the Sub-range channel, OUT 2 the Mid-range channel, OUT 3 the High-range channel, and OUT 4 is the Fullrange channel. OUT 4 can be used for example for monitoring, delayed full range-systems or to provide separate sound reinforcement in adjacent rooms. The internal structure of the 3-Way + Fullrange configuration is shown in the following signal flow diagram. An example of a typical 3-Way + Fullrange configuration is shown in the figure on the right bottom. Two DSP 244s are necessary for stereo operation.

3-WAY + FULLRANGE

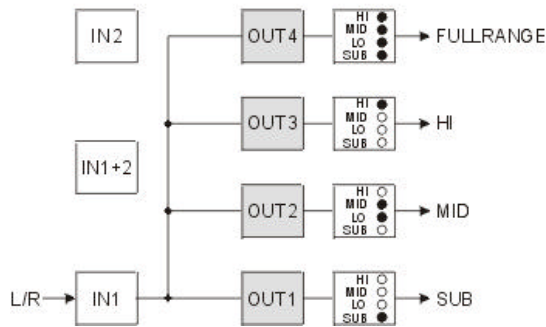

3-WAY + FULLRANGE

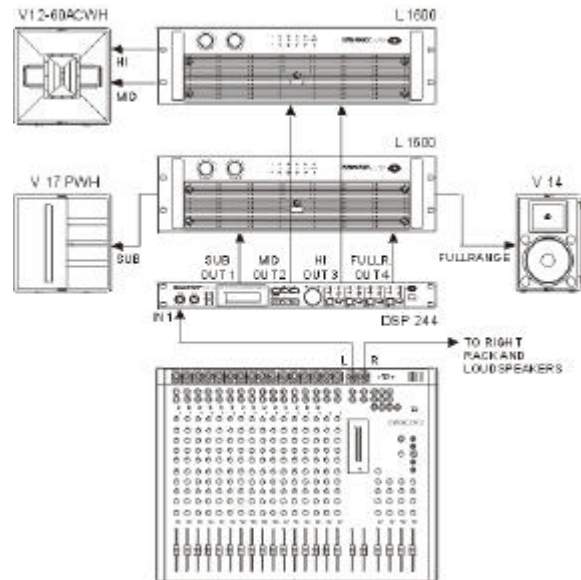

6.4 3 Way / Mono Sub + Fullrange

This configuration also represents a 3-way frequency crossover with additional full range output, with the difference that the Sub-range channel OUT 1 is fed by the summed mono signal of the inputs IN 1 and IN 2. The outputs OUT 2 ... OUT 4 get their signal-feed from the input channel IN 1. OUT 2 is the Mid-range channel, OUT 3 the High-range channel, and OUT 4 the Fullrange channel. OUT 4 can be used for instance for monitoring, delayed full range-systems or to provide separate sound reinforcement in adjacent rooms. The internal structure of the 3-Way / Mono Sub + Fullrange configuration is shown in the following signal flow diagram. An example of a typical system configuration for this structure is shown next to the diagram. Two DSP 244s are necessary for stereo operation.

3-WAY / MONO SUB + FULLRANGE

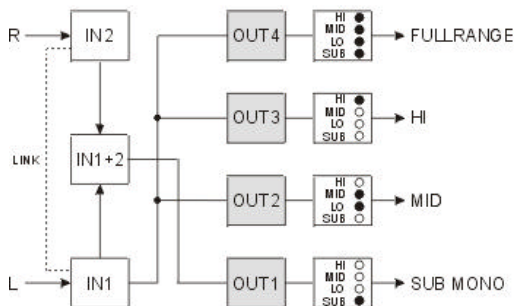

3-WAY / MONO SUB + FULLRANGE

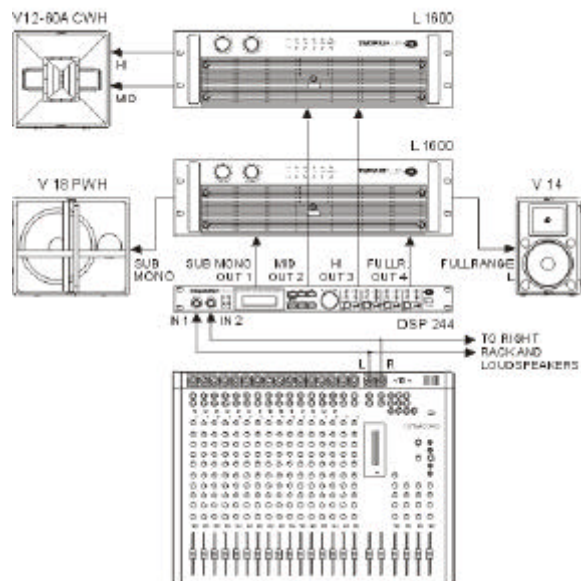

CONFIGURATIONS OF THE DSP 244

6.5 3 Way / Independent Sub + Fullrange

As well as the two previous configurations, this configuration also represents a 3-way frequency crossover with additional full range output, with the difference that the Sub-range channel OUT 1 gets its signal-feed from the input channel IN 2. Thus, it is independent from the other output channels. The audio signal for the outputs OUT 2 ... OUT 4 is fed from the input channel IN 1. OUT 2 is the Mid-range channel, OUT 3 the High-range channel, and OUT 4 the Fullrange channel. OUT 4 can be used for instance for monitoring, delayed full range-systems or to provide separate sound reinforcement in adjacent rooms. The internal structure of the 3-Way / Independent Sub + Fullrange configuration is shown in the following signal flow diagram. An example of a typical system configuration for this structure is shown next to the diagram. Two DSP 244s are necessary for stereo operation.

3-WAY / INDEPENDENT SUB + FULLRANGE

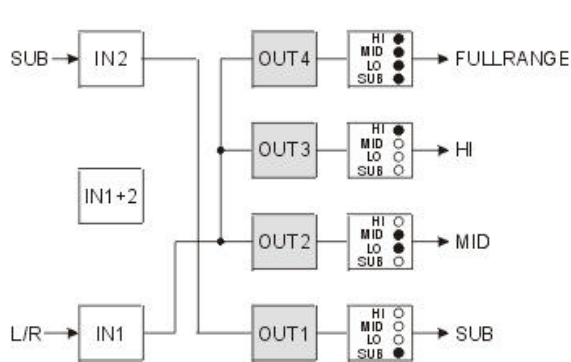

3-WAY / INDEPENDENT SUB + FULLRANGE

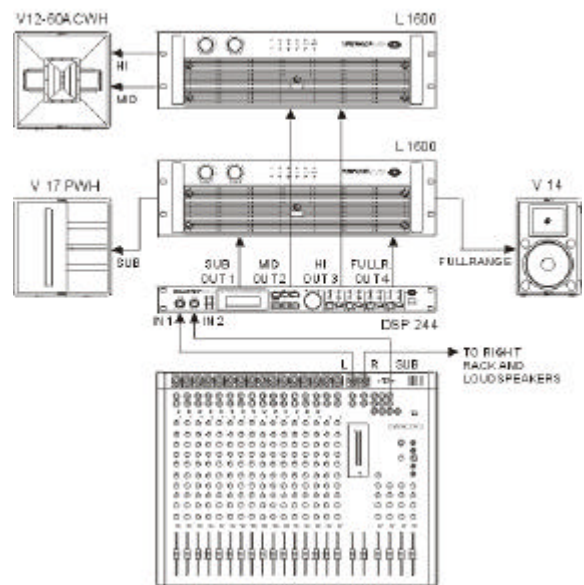

6.6 4 Way

The 4-Way configuration is a monaural 4-way frequency x-over. All outputs are fed by the input channel IN 1. OUT 1 is the Sub-range channel, OUT 2 the Low-range channel, OUT 3 the Mid-range channel, and OUT 4 the High-range channel. The internal structure of the 4-Way configuration is shown in the following signal flow diagram. An example of a typical system configuration for this structure is shown in the figure on the right bottom. Two DSP 244s are necessary for stereo operation.

4-WAY

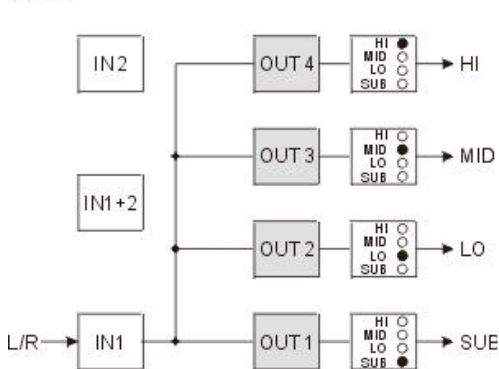

4-WAY

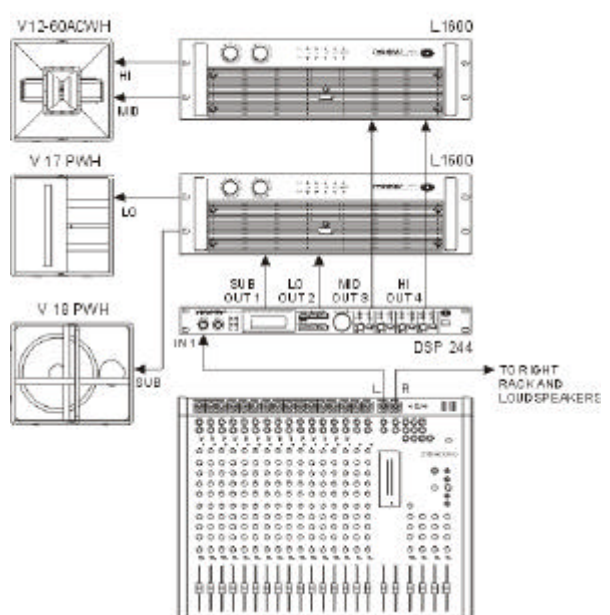

6.7 2-IN-4

In this configuration, all 4 outputs are configured for full range operation. OUT 1 and OUT 2 get their signal-feed from the input channel IN 1 while OUT 3 and OUT 4 are fed from the input channel IN 2. This structure is suitable for instance for the equalization of full range (wide-band) loudspeaker systems or passive multi-way systems. The following signal flow diagram shows the assignment of the inputs and outputs. An example of a typical multi-channel, full range sound reinforcement system configuration is shown in the figure next to the diagram.

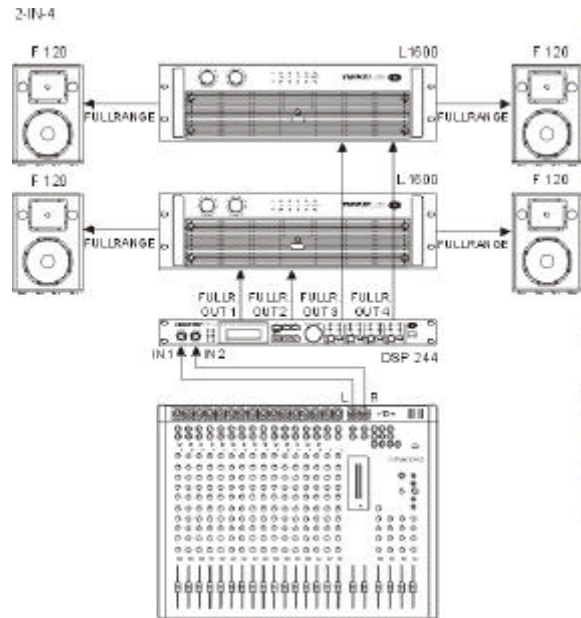
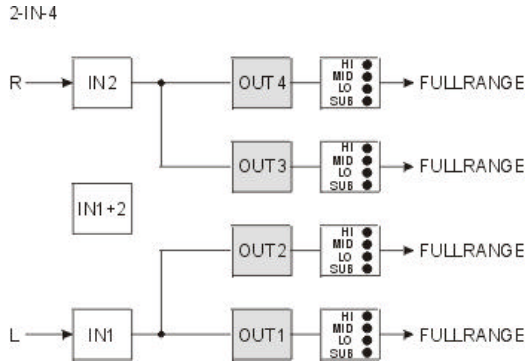

OPERATION

7. OPERATION

The rotary encoder with push-button function for fast editing of parameter values, 6 function keys, and the push-button function of the output level controls OUT 1 - 4 are the main controls of the DSP 244.

With EDIT, OPTION, STORE and RECALL you are able to branch off to and also return from the corresponding menus. The SELECT keys are used to choose between the different menu-pages or to select individual parameters. The rotary encoder lets you alter the parameter values. Within the Edit menu you can also use the push-button function of the controls OUT 1 - 4 to directly select the parameters of the corresponding channel.

The following figure shows the different menu levels and explains how to select them.

Initial state after power-on operation

- Last used program with program number and configuration

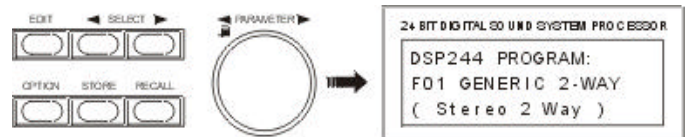

Program selection

- Activated through RECALL
- Program selection via rotary encoder or SELECT keys
- Program activated through RECALL

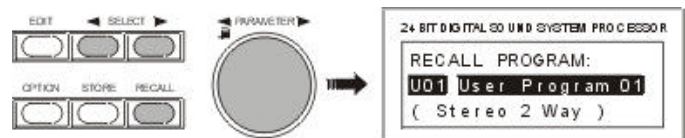

Edit menu

- Activated through EDIT
- Function block selection via rotary encoder
- Parameter selection with SELECT keys
- Parameter changes via rotary encoder
- Exit with EDIT

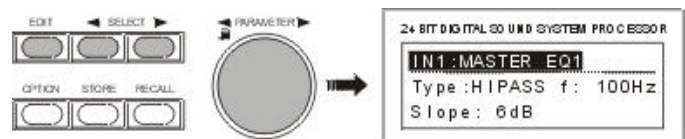

Store menu

- Activated through STORE
- Saving and copying of programs
- Entering a program name
- Exit with STORE

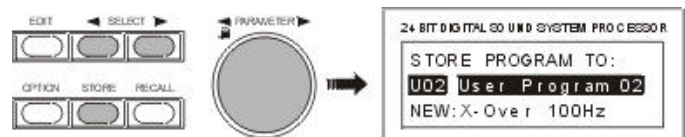

Option menu

- Activated through OPTION
- Appliance-related settings
- Selection of the operation mode
- Interface parameters
- Password / Lock
- Exit with OPTION

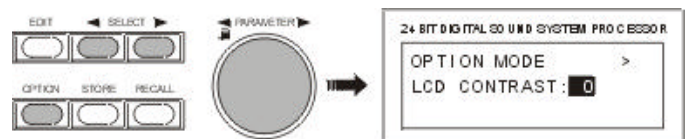

7.1 PROGRAM SELECTION

The DSP 244 offers 30 user-definable program presets (U01 - U30) and up to 50 factory pre-programmed presets (F01-F50). Altogether you have the possibility to choose from this selection of up to 80 different programs.

CAUTION: A program also defines the configuration and therefore also assignment of the inputs and outputs of the DSP 244. When changing a program you have to keep in mind that also the wiring has to be changed, if for instance a Low-range output becomes a High-range output. Thus, an according message appears on the display, every time a program change is performed that also includes a change of the momentary configuration.

1. After pressing the RECALL key (9) you are located in the program selection menu.
2. For selecting the desired program preset you can either use the rotary encoder (10) or the SELECT keys (5) and (6). The display instantaneously shows the new program name and the according configuration.

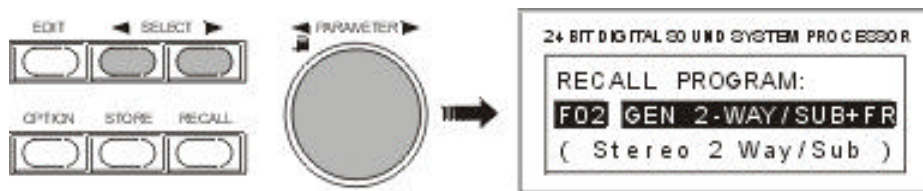

3. Activate the program by pressing the RECALL key (9). A safety dialog appears, asking you if you really want to activate the selected program. In case the new program's configuration differs from the one that had been previously selected, an additional dialog on the display informs you about this circumstance and about the possibility to probably change the wiring to prevent faulty operation and the connected loudspeaker systems from being damaged.

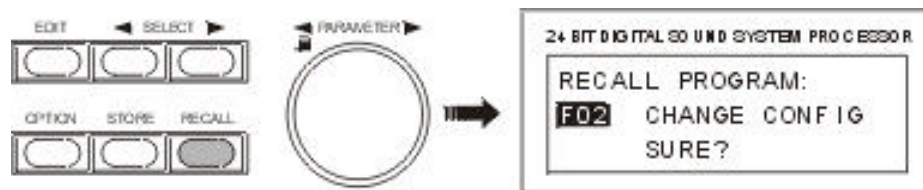

4. By pressing the RECALL key (9) again, the program selection is being acknowledged. Pressing any other key cancels the selection. Depending on your action, either the new program is activated or the previous program stays in memory.

7.2 EDITING

The EDIT menu allows you to change the setting of parameters. A detailed description of all possible settings is provided in chapter 8, PARAMETERS. The selection of accessible parameters depends on the actual EDIT mode. For further information, please refer to chapter 9.5, OPERATION MODE SELECTION.

1. Press the EDIT key (4).
2. You are located in the Edit menu. The display shows either the first menu-page of the active program or the last page that you made changes to, including all accessible parameters. A menu-page always consists of the channel (IN1, IN2, IN1+2, OUT1, OUT2, OUT3, OUT4), the function block (EQ, X-OVER, DELAY, ROUTING, LEVEL, etc.), and the corresponding parameters (e. g. Type, f, Q, Gain in case of an EQ). The momentary selected function block or parameter is marked by a black line.

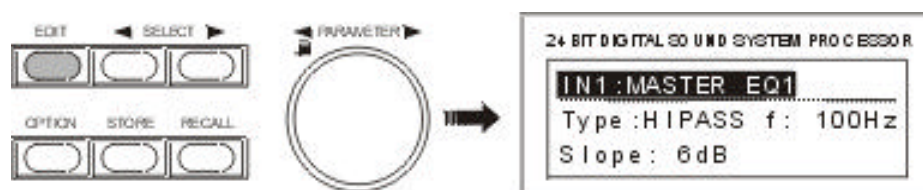

OPERATION

- Whenever the function block in the first line is selected, you are able to select another function block by using the rotary encoder (10). Pressing one of the controls OUT 1 - 4 lets you directly select the function blocks of the corresponding output channel.
- Using the SELECT keys (5) and (6) you are able to select the desired parameter and the rotary encoder (10) lets you alter the value of the selected parameter. Keeping the rotary encoder pressed while turning it, increases the speed of the value changes (enhanced step-width).
- The set value is displayed and the change is instantaneously audible via the connected loudspeaker systems. An **E** appears in the top right corner of the display, informing you that the selected program is being edited.

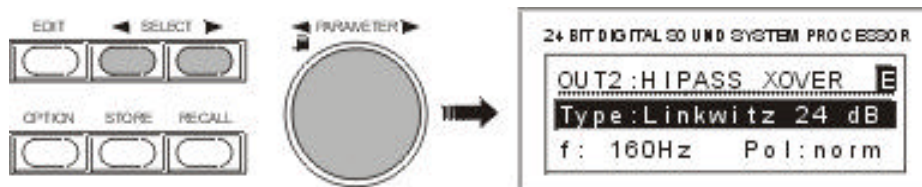

In case you do not want to change any other parameters, please proceed with step 7.

- The next or previous parameter is selected, using the SELECT keys (5) and (6). The display might show the following:

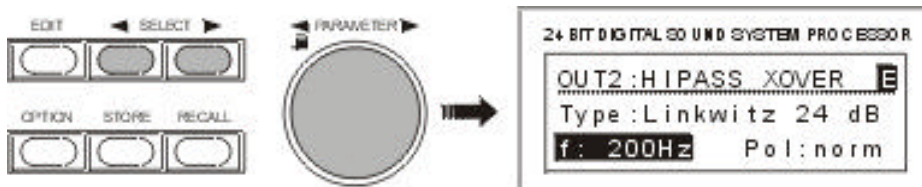

If needed, steps 3 to 6 can be repeated as often as necessary.

- Pressing the EDIT key (4) again quits the Edit menu.

CAUTION! Your changes to the program that is in memory are not stored yet and therefore will be lost with the next program change command.

- The display now shows the program number, the program name and the corresponding configuration. The **E** in the top right corner indicates that parameters are being edited, but the changes have not yet been saved. You are now faced with different possibilities to continue:

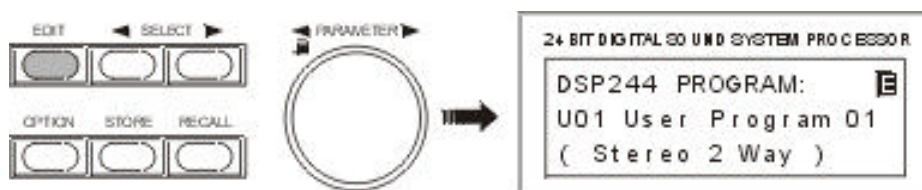

- For saving the edited program, proceed with chapter 7.3.
- For further altering the parameter values, return to step 1.
- For recalling the original program, press RECALL (9). This cancels the function and discards all previous parameter value changes of the selected program.

NOTE: In the Edit menu, pressing the STORE key (8) lets you directly jump to the Store menu to save your program under a new name and in a new location.

7.3 STORE PROGRAMS AND PROGRAM NAMES

Whether you want to store an edited program, alter the name of a program, or copy a program from one preset location to another - in all cases the necessary procedure is the same.

Pressing the STORE key (8) always starts and executes the saving procedure. You can also quit the Store menu without saving your result by pressing any other key.

1. Press the STORE key (8) to start saving a program .

For instance, the display might look like this:

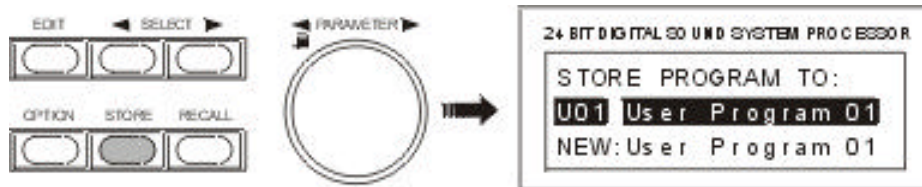

2. For saving the program without changing its name in the actual preset, proceed with step 6. If you only want to change the program's name and keep its location, proceed with step 4.
3. Use the rotary encoder (10) to select the desired preset location.

For instance, the display might look like this:

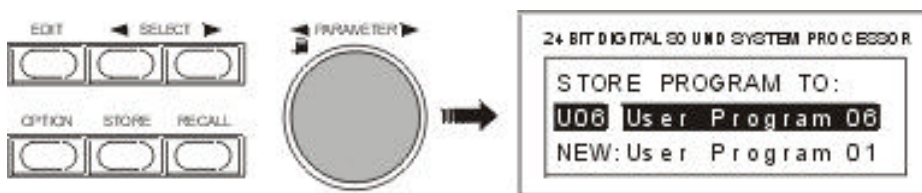

Please, proceed with step 6 if you do not want to change the program's name.

4. Use the SELECT keys (5) and (6) to position the cursor to the first or the last character of the program name. Now, the display indicates:

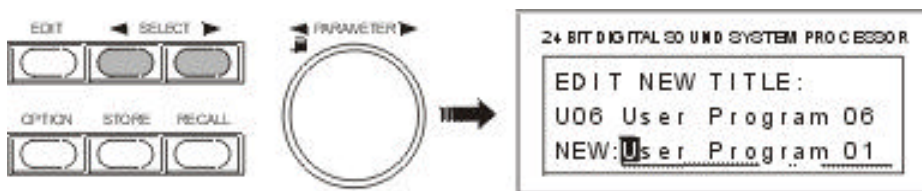

5. Use the rotary encoder (10) to select the desired character at the cursor position. Pressing the rotary encoder enters a blank character at the actual cursor position. Use the SELECT keys (5) and (6) to move the cursor between characters to be entered; e. g. "X-Over 200 Hz". Program names can be up to 16 characters long.
6. Press STORE (8) to acknowledge the selected program number and name. A safety dialog is displayed asking you, if you want to save these changes.

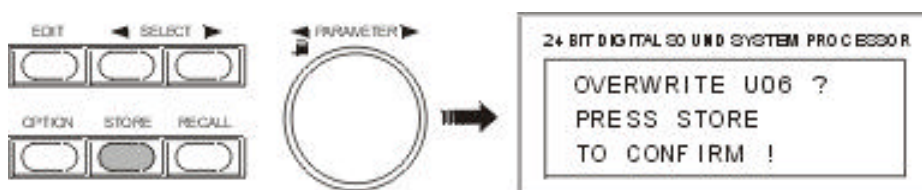

7. The saving procedure is executed by pressing the STORE key (8) again.

OPERATION

CAUTION! The program that was previously stored in this preset location is being erased! Please make sure, that the selected destination program number matches the number you want to save the program under. Pressing any other key cancels the saving procedure.

After saving is complete, the Store menu is automatically quitted and the display might look for instance like this:

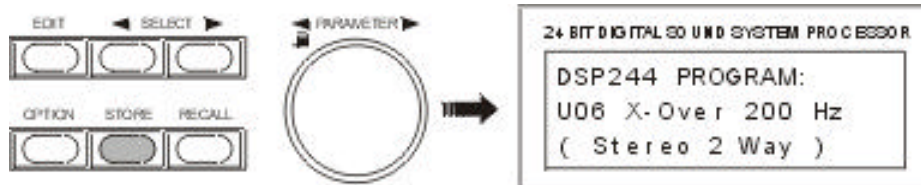

7.4 MODIFYING FACTORY PRESET PROGRAMS

The easiest and quickest way to achieve good results with the DSP 244 is the use of a factory preset program. Factory preset programs are carefully designed, factory-pre-set programs that are stored non-volatile in the FLASH memory of the DSP 244. Just select the preset that matches your loudspeaker combination and the DSP 244 automatically sets all parameters to their optimal values matching your components. Afterwards, your sound reinforcement system is ready for operation immediately.

If you want to make your own settings or re-adjustments, this can be done in the Standard or Full-Edit modes at any time. To apply changes to a factory preset, it first has to be copied to a user-definable preset location and the name has to be changed too. This is necessary to eliminate the chance that programs are mistaken by each other.

1. In the Recall menu, select the program that you want to edit from the list of factory preset programs. Press RECALL (9) to load the preset into RAM; see also chapter 7.1, PROGRAM SELECTION.
2. Press the STORE key (8) to copy the program to a user-definable preset location, like explained in the paragraph 7.3.
3. Now, you can change the parameter values as desired. Enter the program's new name and save it in a user-definable preset location, like explained in the paragraph 7.3.

8. PARAMETERS

Depending on its configuration and operation mode, the DSP 244 offers a selection of more or less different parameters. The parameters are assigned to the input channels IN1, IN2, IN1+2 and to the 4 output channels OUT1, OUT2, OUT3, OUT4. The channel number is indicated in the top left corner of the display while the function block (MASTER EQ, MASTER DELAY, CHANNEL EQ, etc.) is shown next to the channel number.

The corresponding parameters appear in the second and third line of the display. A typical "parameter display" looks like this:

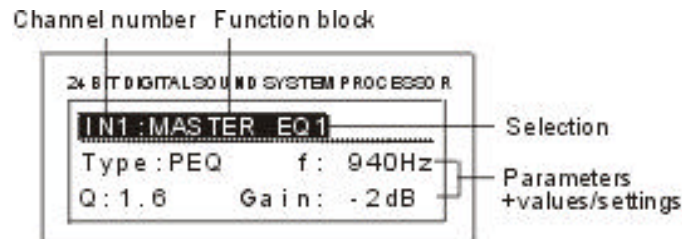

The function blocks are arranged in the following sequence:

IN1: MASTER EQ1
 IN1: MASTER EQ2
 IN1: MASTER EQ3
 IN1: MASTER EQ4
 IN1: MASTER EQ5
 IN1: MASTER DELAY

IN2: MASTER EQ1
 IN2: MASTER EQ2
 IN2: MASTER EQ3
 IN2: MASTER EQ4
 IN2: MASTER EQ5
 IN2: MASTER DELAY

IN1+2: MASTER DELAY

OUT1: ROUTING
 OUT1: CHANNEL EQ1
 OUT1: CHANNEL EQ2
 OUT1: CHANNEL EQ3
 OUT1: CHANNEL EQ4
 OUT1: HIPASS XOVER
 OUT1: LOPASS XOVER
 OUT1: CHANNEL DELAY
 OUT1: COMPRESSOR
 OUT1: LIMITER
 OUT1: LEVEL

OUT2: ROUTING
 OUT2: CHANNEL EQ1
 OUT2: CHANNEL EQ2
 OUT2: CHANNEL EQ3
 OUT2: CHANNEL EQ4
 OUT2: HIPASS XOVER
 OUT2: LOPASS XOVER
 OUT2: CHANNEL DELAY
 OUT2: COMPRESSOR
 OUT2: LIMITER
 OUT2: LEVEL

OUT3: ROUTING
 OUT3: CHANNEL EQ1
 OUT3: CHANNEL EQ2
 OUT3: CHANNEL EQ3
 OUT3: CHANNEL EQ4
 OUT3: HIPASS XOVER
 OUT3: LOPASS XOVER
 OUT3: CHANNEL DELAY
 OUT3: COMPRESSOR
 OUT3: LIMITER
 OUT3: LEVEL

OUT4: ROUTING
 OUT4: CHANNEL EQ1
 OUT4: CHANNEL EQ2
 OUT4: CHANNEL EQ3
 OUT4: CHANNEL EQ4
 OUT4: HIPASS XOVER
 OUT4: LOPASS XOVER
 OUT4: CHANNEL DELAY
 OUT4: COMPRESSOR
 OUT4: LIMITER
 OUT4: LEVEL

All parameters, their adjustment ranges, and all additional information about use and effect of the different functions are explained in detail in the following chapters.

PARAMETERS

8.1 PARAMETER ACCESS

Depending on the actual configuration, only certain parameters are relevant. To provide a better overview and prevent erroneous operation, in the STANDARD Edit mode only those parameters are accessible. Additionally and to further improve operational comfort, corresponding parameters are linked. For Instance, in the Stereo 2-Way configuration, the Master EQs, the Master delays, the outputs OUT1 / OUT3 and OUT2 / OUT4, and the X-Over parameters are linked for mutual setting.

For information about the parameters that are accessible with a certain configuration and parameters that are linked, please refer to the following tables.

8.1.1 PARAMETER ACCESS-TABLE

	STANDARD Mode ¹⁾							FULL EDIT Mode
	Stereo 2 Way	Stereo 2 Way / Mono Sub + Fullrange	3 Way + Fullrange	3 Way Mono Sub + Fullrange	3 Way Independ. Sub + Fullrange	4 Way	2-In-4	Full Edit
ROUTING	NO	NO	NO	NO	NO	NO	NO	YES
IN2 EQs	YES	YES	NO	YES	YES	NO	YES	YES
IN2 Delay	YES	YES	NO	YES	YES	NO	YES	YES
IN1+2 Delay	NO	YES	NO	YES	NO	NO	NO	YES
Label	NO	NO	NO	NO	NO	NO	NO	YES
OUT1 HIPASS XOVER	NO	NO	NO	NO	NO	NO	YES	YES
OUT1 LOPASS XOVER	YES	YES	YES	YES	YES	YES	YES	YES
OUT2 HIPASS XOVER	YES	YES	YES	YES	YES	YES	YES	YES
OUT2 LOPASS XOVER	NO	NO	YES	YES	YES	YES	YES	YES
OUT3 HIPASS XOVER	NO	YES	YES	YES	YES	YES	YES	YES
OUT3 LOPASS XOVER	YES	NO	NO	NO	NO	YES	YES	YES
OUT4 HIPASS XOVER	YES	YES	YES	YES	YES	YES	YES	YES
OUT4 LOPASS XOVER	NO	NO	NO	NO	NO	NO	YES	YES

YES: Parameter is available

NO: Parameter is not available

¹⁾ STANDARD Mode can be selected in the DSP 244 Editor software

8.1.2 PARAMETER LINK-TABLE

	STANDARD Mode ¹⁾							FULL EDIT Mode
	Stereo 2 Way	Stereo 2 Way / Mono Sub + Fullrange	3 Way + Fullrange	3 Way Mono Sub + Fullrange	3 Way Independ. Sub + Fullrange	4 Way	2-In-4	Full Edit
IN1 / IN2 EQ	YES	YES	NO	YES	NO	NO	NO	NO
IN1 / IN2 Delay	YES	NO	NO	NO	NO	NO	NO	NO
IN1 / IN2 / IN1+2 Delay	NO	YES	NO	NO	NO	NO	NO	NO
OUT1 / OUT3 ²⁾ OUT2 / OUT4	YES	NO	NO	NO	NO	NO	NO	NO
OUT2 / OUT3 ²⁾	NO	YES	NO	NO	NO	NO	NO	NO

YES: Parameters are linked

NO: Parameters are not linked

The corresponding x-over frequencies and filter characteristics of the XOVER are additionally linked.

¹⁾ STANDARD Mode can be selected in the DSP 244 Editor software

²⁾ is true for CHANNEL EQ, COMPRESSOR, LEVEL, XOVER, but not for "Mute"

8.2 DESCRIPTION OF PARAMETERS

The following provides you with a description of all function blocks that can appear in any selected mode including all available parameters, value ranges, and settings. Additional information about the affect of each parameter is provided through the corresponding setting example. When entering the EDIT mode, either the first parameter of the actual program or the parameter that you have edited last are displayed.

MASTER EQ1-5

Both input channels of the DSP 244 employ a 5-Band parametric EQ, each, which provide extreme flexibility in the programming of full range equalization to match the sound reinforcement system to different acoustic conditions and venues which in most cases makes the need for post-mix graphic equalization unnecessary.

Parameter		Settings / Value range	Default
Type		BYPASS, PEQ, LOSLV, HISLV, HIPASS, LOPASS	BYPASS
PEQ	f	20Hz - 20kHz	1.00 kHz
	Q	0.4 - 20.0	0.7
	Gain	-12dB - +12dB	+0dB
LOSLV	f	20Hz - 20kHz	1.00 kHz
	Slope	6dB, 12dB	6dB
	Gain	-12dB - +12dB	+0dB
HISLV	f	20Hz - 20kHz	1.00 kHz
	Slope	6dB, 12dB	6 dB
	Gain	-12dB - +12dB	+0dB
LOPASS	f	20Hz - 20kHz	1.00 kHz
	Slope	6dB, 12dB	6 dB
	Q	0.4 - 2.0 (for 12dB/octave slope only)	0.7
HIPASS	f	20Hz - 20kHz	1.00 kHz
	Slope	6dB, 12dB	6 dB
	Q	0.4 - 2.0 (for 12dB/octave slope only)	0.7

PARAMETERS

Type describes the selected filter type. When selecting BYPASS, no effect is applied. PEQ provides a parametric Peak Dip Filter with programmable frequency, quality, and gain. LOSLV / HISLV stand for Low Shelving or High Shelving Equalizer, respectively. Their parameters are: frequency (f), slope, and gain. The parameters of the LOPASS / HIPASS filters are frequency and slope.

f (frequency) sets the center-frequency of parametric EQ-types and the cutoff frequency of shelving and Hi-Pass / Lo-Pass filters.

The value of the parameter **Q** determines the quality or bandwidth of parametric EQs. Higher Q-values result in a narrow banded filter while smaller Q-values result in an increased bandwidth. The following examples are meant to give you an idea of the effect of the Q-parameter to make correct adjustments for your own purposes. The Q-parameter also describes the quality and therefore the graph of the Hi-Pass and Lo-Pass filters.

Gain sets the degree of amplification or attenuation of the parametric EQ or the low shelving and high shelving equalizers. The stepwidth is 1 dB. The response of the filter at different gain settings are shown in the diagram below.

The **Slope** parameter describes the steepness or order of the filter for the low shelving or high shelving equalizers as well as for the Lo-Pass and Hi-Pass filters. Different slope settings for the transition band are possible. Together with the Q-parameter this provides the possibility to program the Hi-Pass filter for so called B6-alignment; i. e. an increase in the response in the cutoff frequency range.

The following examples are meant to show you the effect of different parameter settings. The DSP 244 editor software allows you to make your own adjustments via PC or notebook computer and monitor the resulting frequency response on the computer screen.

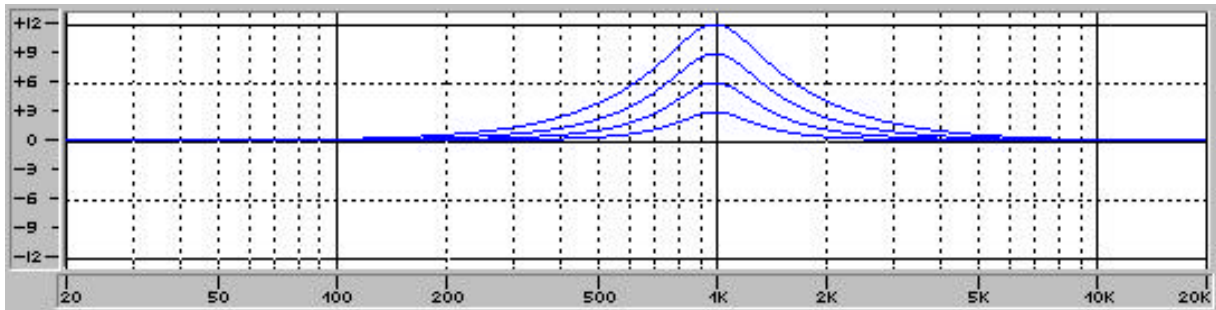

PEQ: $f = 1\text{kHz}$, $Q = 2.0$ Gain = +3dB, +6dB, +9dB, +12dB

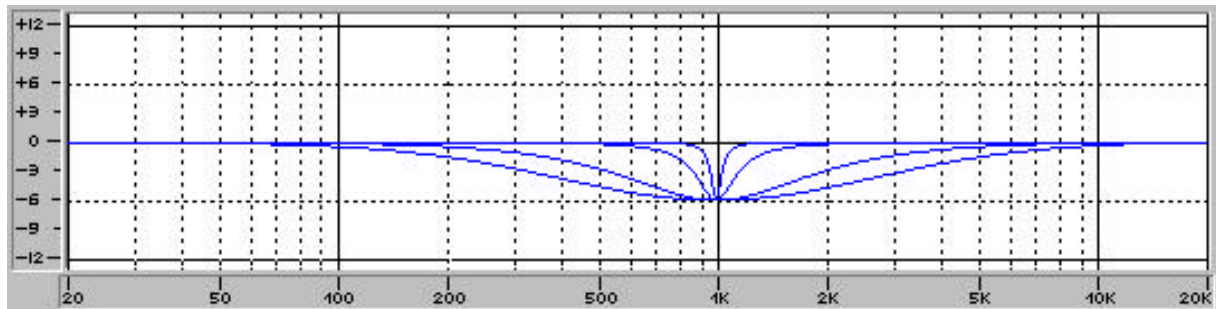

PEQ: $f = 1\text{kHz}$, Gain = -6dB $Q = 0.5, 1.0, 5.0, 20.0$

PARAMETERS

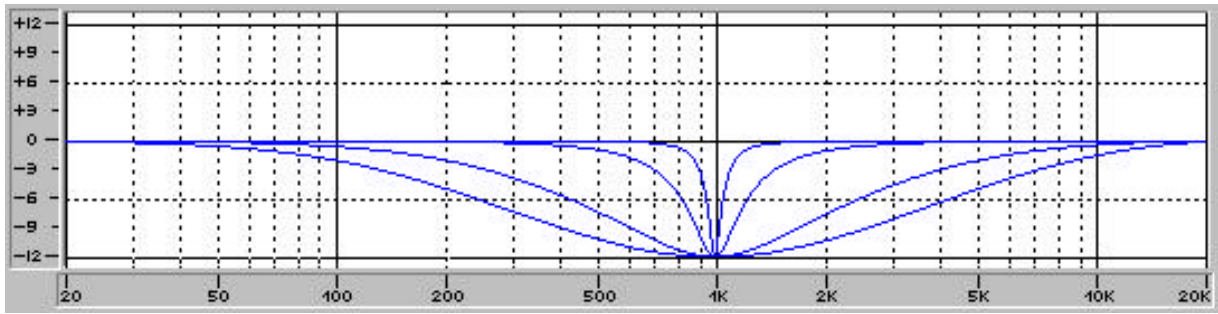

PEQ: $f = 1\text{kHz}$, Gain = -12dB $Q = 0.5, 1.0, 5.0, 20.0$

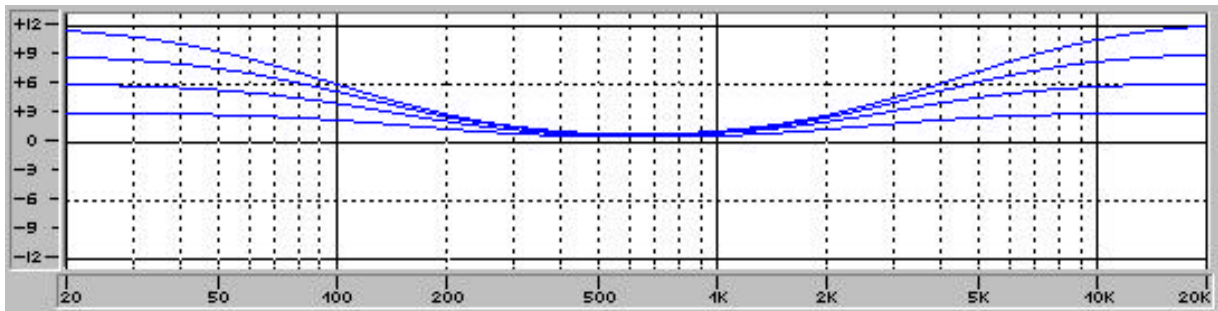

Low Shelving Filter (LOSLV): $f = 200\text{Hz}$, Slope = 6dB Gain = +3dB, +6dB, +9dB, +12dB
 High Shelving Filter (HISLV): $f = 2000\text{Hz}$, Slope = 6dB Gain = +3dB, +6dB, +9dB, +12dB

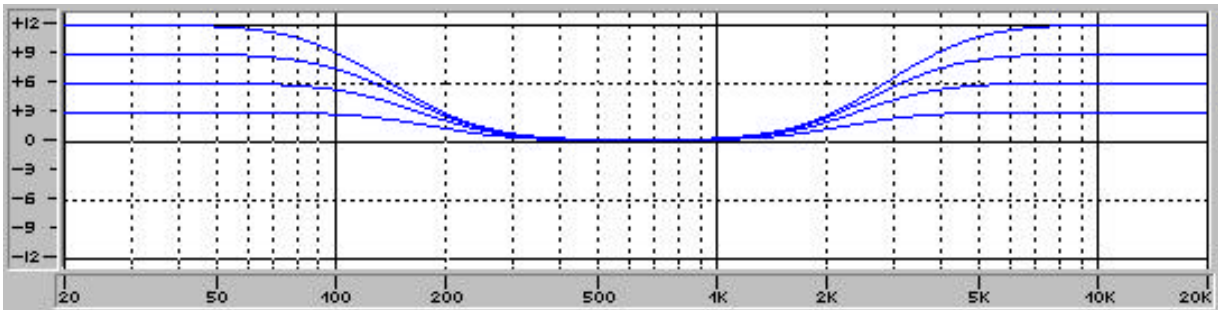

Low Shelving Filter (LOSLV): $f = 200\text{Hz}$, Slope = 12dB, Gain = +3dB, +6dB, +9dB, +12dB
 High Shelving Filter (HISLV): $f = 2000\text{Hz}$, Slope = 12dB, Gain = +3dB, +6dB, +9dB, +12dB

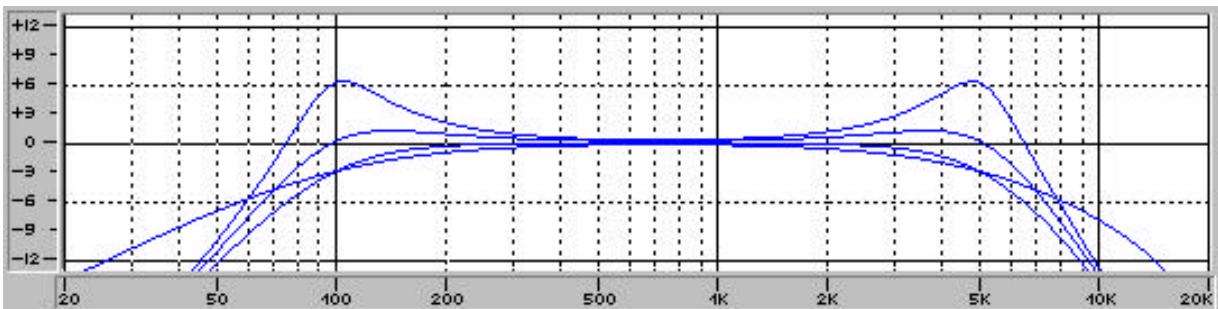

Hi-Pass Filter (HIPASS): $f = 100\text{Hz}$, Slope = 6dB, 12dB $Q = 0.7, 1.0, 2.0$
 Lo-Pass Filter (LOPASS): $f = 5000\text{Hz}$, Slope = 6dB, 12dB $Q = 0.7, 1.0, 2.0$

PARAMETERS

MASTER DELAY

These delay lines are located in the inputs IN1, IN2 and in the summed input signal IN1+2; all x-over channels are affected.

For instance, this allows to feed different PA-towers at open air concerts with delayed signals.

The delay times are displayed in milliseconds and microseconds while the equivalent distances (unit) are displayed in feet, inches, meters or centimeters. The environmental temperature appears as additional parameter whenever distances are displayed. Thus, up to 3 parameters are available.

Parameter	Settings / Value range	Default
Delay	2 ms - 900 ms 1927 μ s - 900000 μ s 2 feet - 1014 feet 26 inch - 12169 inch 1 m - 309 m 66 cm - 30910 cm	2 ms
Unit	ms, μ s, feet, inch, m, cm	ms
Temp	-20°C - 60°C -4°F - 140°F	20°C

The **Delay** parameter determines the delay time of the corresponding channel or the distance between different loudspeaker clusters.

Unit allows the user to select between time or distance display. Distances are automatically converted into delay times plus the calculation additionally includes the influence of the environmental temperature.

Temp allows you to enter a value for the momentary environmental temperature. This parameter appears only when the selected display-unit is distance. The affect of the environmental temperature on the resulting delay time is automatically included in the calculation.

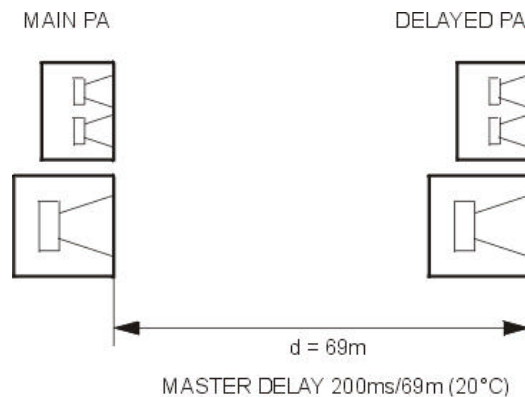

ROUTING

Any combination of input channels can be assigned to the outputs of the DSP 244. The routing defines which input signal is fed to either one of the output channels (OUT1, OUT2, OUT3, OUT4). Besides routing the signals of the two input channels IN1 and IN2 to one of the outputs, it is also possible to assign the summed, monaural audio signal of both inputs IN1+2 to one of the outputs.

Parameter	Settings / Value range	Default
Source	IN1, IN2, IN1+2	IN1 (OUT 1/2) IN2 (OUT 3/4)
Label	SUB, LO, MID, HI, LO-MID, LO-MID-HI, SUB-LO-MID-HI	SUB

Label allows the setting of the channel-function indicators - SUB, LO, MID, HI - on the front panel of the appliance. These LEDs indicate the individual frequency range which the corresponding channel is actually configured for. The LEDs are meant for indication purposes only - no parameters are changed.

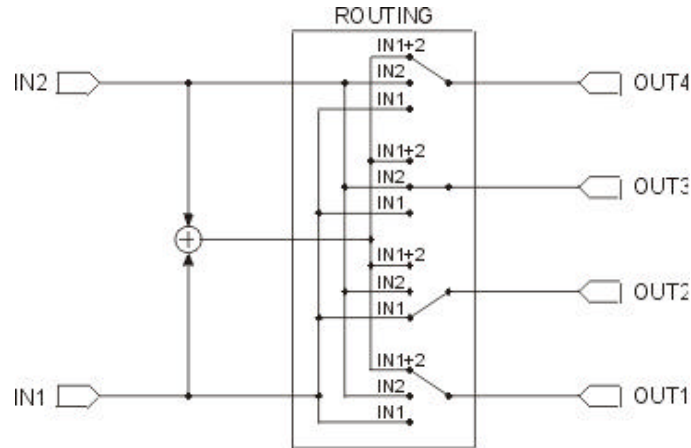

CHANNEL EQ1-4

The four output channels of the DSP 244 employ a 4-band parametric EQ each which allow to program additional equalization for the individual frequency ranges. This guarantees the optimum frequency response that is matched to the connected loudspeaker components.

Parameter		Settings / Value range	Default
Type		BYPASS, PEQ, LOSLV, HISLV, HIPASS, LOPASS, ALLPASS	BYPASS
PEQ	f	20Hz - 20kHz	1.00 kHz
	Q	0.4 - 20.0	0.7
	Gain	-12dB - +12dB	+0dB
LOSLV	f	20Hz - 20kHz	1.00 kHz
	Slope	6dB, 12dB	6 dB
	Gain	-12dB - +12dB	+0dB
HISLV	f	20Hz - 20kHz	1.00 kHz
	Slope	6dB, 12dB	6 dB
	Gain	-12dB - +12dB	+0dB
LOPASS	f	20Hz - 20kHz	1.00 kHz
	Slope	6dB, 12dB	6 dB
	Q	0.4 - 2.0 (for 12dB/octave slope only)	0.7
HIPASS	f	20Hz - 20kHz	1.00 kHz
	Slope	6dB, 12dB	6 dB
	Q	0.4 - 2.0 (for 12dB/octave slope only)	0.7
ALLPASS	f	20Hz - 20kHz	1.00 kHz
	Order	1st, 2nd	1st
	Q	0.4 - 2.0	0.7

Type describes the selected filter type. When selecting BYPASS, no effect is applied. PEQ provides a parametric Peak Dip Filter with programmable frequency, quality, and gain. LOSLV / HISLV stand for Low Shelving or High Shelving Equalizer, respectively. Their parameters are: frequency (f), slope, and gain. The parameters of the LOPASS / HIPASS filters are frequency and slope. The ALLPASS filter can be used to compensate phase differences at the x-over frequency.

f (frequency) sets the center-frequency of parametric EQ-types and the cutoff frequency of shelving and Hi-Pass / Lo-Pass filters. With the Allpass filter this is the frequency at which the phase is shifted by 90° (1st order Allpass) or by 180° (2nd order Allpass).

The value of the parameter **Q** determines the quality or bandwidth of parametric EQs. Higher Q-values result in a narrow banded filter while smaller Q-values result in a wider bandwidth.

The Q-parameter also describes the quality and therefore the graph of the Hi-Pass and Lo-Pass filters.

The Q-parameter is also found in the 2nd order Allpass filter. It is used to set the phase response in the transition band (lower Q-settings result in flat phase response while higher Q-settings produce a steeper phase response; see also examples).

PARAMETERS

Gain sets the degree of amplification or attenuation of the parametric EQ or the low shelving and high shelving equalizers. The setting is performed in steps with 1 dB-stepwidth.

The **Slope** parameter describes the steepness or order of the filter for the low shelving or high shelving equalizers.

By setting the low shelving equalizer's slope to 12 dB and the filter frequency to the resonance frequency of the loudspeaker cabinet, the Slope parameter also lets you create a special LPN filter (Low Pass Notch filter). This is possible, since the frequency response of speaker cabinets' lower frequencies drops by 12 dB/oct., starting from their resonance frequency. A LPN filter compensates and shifts this polarization in the transmission down towards lower frequencies. The picture below shows typical frequency responses of a cabinet with LPN filter (A) and one without LPN filter (B).

Slope also describes the filter curve of the Lo-Pass and Hi-Pass filters. Different slope settings for the transition band are possible. Together with the Q-parameter this provides the possibility to program the Hi-Pass filter for so called B6-alignment; i. e. an increase in the response in the cutoff frequency range.

The **Order** parameter determines whether a 1st order or 2nd order Allpass filter is used. A 1st order Allpass filter shifts the phase by 180° and its cutoff frequency is 90°. A 2nd order Allpass filter shifts the phase by 360° and its cutoff frequency is 180°. Additionally, a 2nd order Allpass filter provides the Q-parameter (quality) which allows setting the phase response of the transition range (lower Q-settings result in flat phase response while higher Q-settings produce a steeper phase response; see also examples).

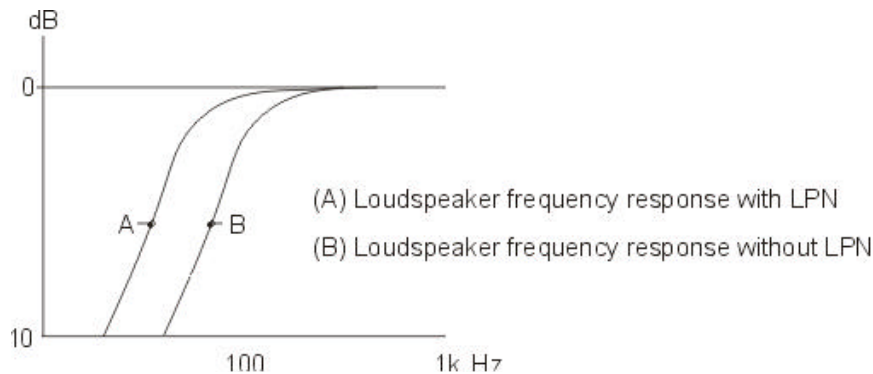

Examples for the settings of different filter types are provided in the paragraph MASTER EQ1-5. You are also able to program your own settings of the DSP 244 via PC or notebook computer and monitor the resulting frequency response on the computer screen. The following example shows the phase response of Allpass filters with different parameter settings.

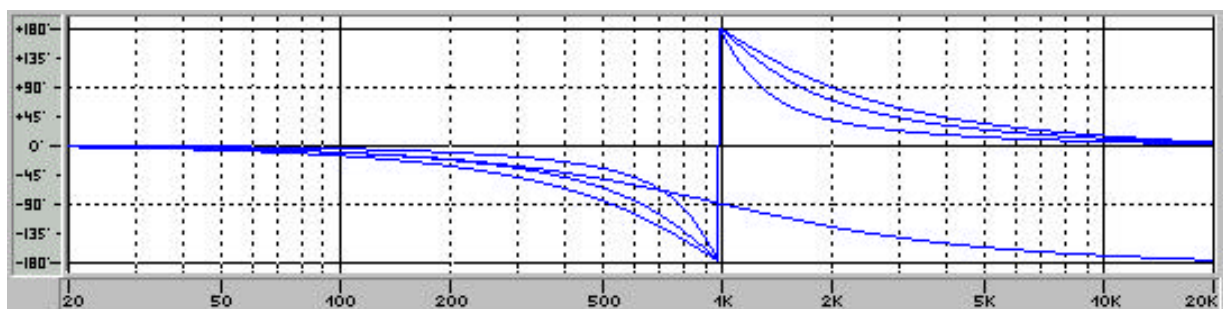

ALLPASS: $f = 1\text{kHz}$, Order = 1st, 2nd Q = 0.7, 1.0, 2.0

HIPASS X-OVER

The frequency crossover filter consists of a low pass filter in one channel and a high pass filter in the adjacent channel. Here, the frequency x-over filter's Hi-Pass parameters are set. The parameters of the corresponding Lo-Pass should be set to the same values. An x-over filter provides the parameters "Type" and "f".

Parameter	Settings / Value range	Default
Type	thru, 6 dB, 12dB Q0.5, 12dB Q0.6, 12dB Q0.7, 12dB Q0.8, 12dB Q1.0, 12dB Q1.2, 12dB Q1.5, 12dB Q2.0 Bessel 12 dB, Butter 12 dB, Linkwitz 12 dB, Bessel 18 dB, Butter 18 dB, Bessel 24 dB, Butter 24 dB, Linkwitz 24 dB	thru
f	20Hz - 20kHz	1.00 kHz
Pol	norm, inv	norm

The **Type** parameter defines the filter characteristics of the x-over Hi-Pass filter. Different slopes and filter responses (6dB, 12dB with different Q values, Bessel, Butterworth, Linkwitz-Riley) are available and the filter can be bypassed. The corresponding Lo-Pass filter should be set to the same characteristics.

The **f** parameter (frequency) sets the x-over Hi-Pass filter's cutoff frequency. The corresponding Lo-Pass filter should be set to the same cutoff frequency.

Pol defines the polarity of the corresponding channel. Depending on the characteristic of the frequency crossover filter, inverting the polarity of a channel's signal may become necessary; i. e.: set a negative polarity. Some filter types generate phase responses that lead to significant level reduction in the overall audio signal at the crossover frequency. This negative effect can be eliminated by inverting the polarity of the output that carries the low-frequency signal.

The following table provides you with a list of all filter types for which a channel's signal has to be inverted for the corresponding filter pair.

- Bessel 12 dB
- Butterworth 12 dB
- Bessel 18 dB
- Bessel 24 dB

In the Standard Edit Mode, depending on the selected type of filter, channel inversion is automatically set.

LOPASS X-OVER

The frequency crossover filter consists of a low pass filter in one channel and a high pass filter in the adjacent channel. Here, the frequency x-over filter's Lo-Pass parameters are set. The parameters of the corresponding Hi-Pass should be set to the same values. An x-over filter provides the parameters "Type" and "f".

Parameter	Settings / Value range	Default
Type	thru, 6 dB, 12dB Q0.5, 12dB Q0.6, 12dB Q0.7, 12dB Q0.8, 12dB Q1.0, 12dB Q1.2, 12dB Q1.5, 12dB Q2.0 Bessel 12 dB, Butter 12 dB, Linkwitz 12 dB, Bessel 18 dB, Butter 18 dB, Bessel 24 dB, Butter 24 dB, Linkwitz 24 dB	thru
f	20Hz - 20kHz	1.00 kHz
Pol	norm, inv	norm

The **Type** parameter defines the filter characteristics of the x-over Lo-Pass filter. Different slopes and filter responses (6dB, 12dB with different Q values, Bessel, Butterworth, Linkwitz-Riley) are available and the filter can be bypassed. The corresponding Hi-Pass filter should be set to the same characteristics.

PARAMETERS

The **f** parameter (frequency) sets the x-over Lo-Pass filter's cutoff frequency. The corresponding Hi-Pass filter should be set to the same cutoff frequency.

Pol defines the polarity of the corresponding channel. Depending on the characteristic of the frequency crossover filter, inverting the polarity of a channel's signal may become necessary; i. e.: set a negative polarity. Some filter types generate phase responses that lead to significant level reduction in the overall audio signal at the crossover frequency. This negative effect can be eliminated by inverting the polarity of the output that carries the low-frequency signal.

The following table provides you with a list of all filter types for which a channel's signal has to be inverted for the corresponding filter pair.

- Bessel 12 dB
- Butterworth 12 dB
- Bessel 18 dB
- Bessel 24 dB

In the Standard Edit Mode, depending on the selected type of filter, channel inversion is automatically set.

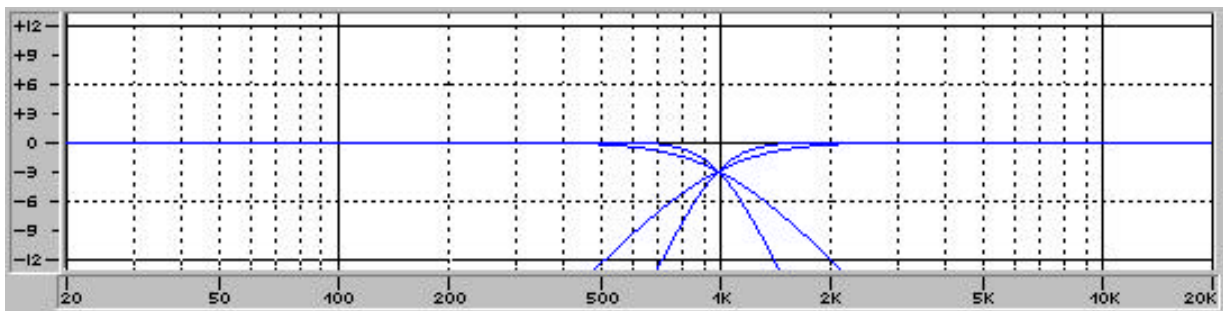

X-OVER: f = 1kHz Type = Butterworth 12dB, Butterworth 24

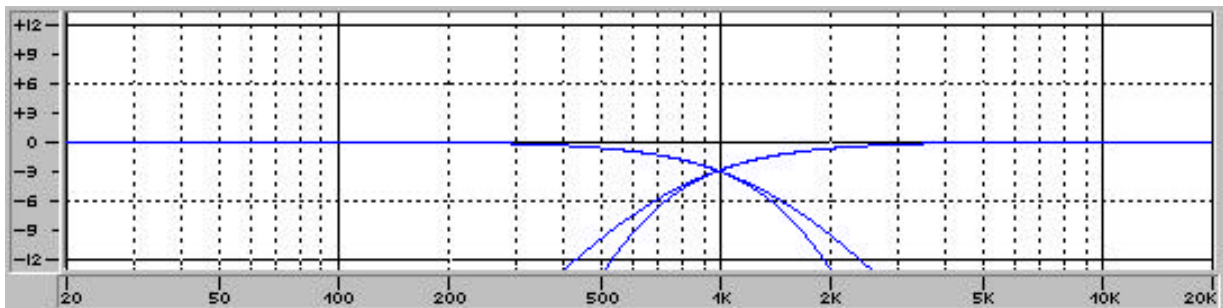

X-OVER: f = 1kHz Type = Bessel 12dB, Bessel 24d

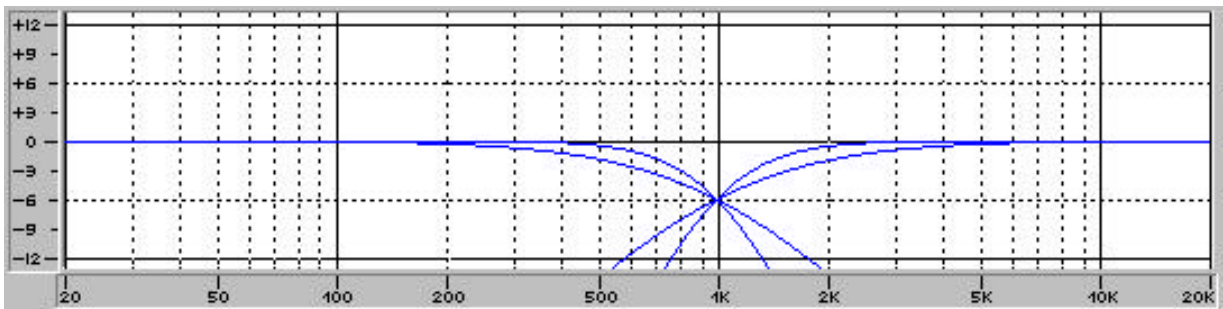

X-OVER: f = 1kHz Type = Linkwitz-Riley 12dB, Linkwitz-Riley 24dB

CHANNEL DELAY

These delays are provided in the output channels OUT1 - OUT4. They are used to compensate differences in loudspeaker dispersion plains that can be cabinet imminent or result from the positioning of individual loudspeaker cabinets or arrays.

The delay time or acoustical distance is displayed in milliseconds, microseconds, feet, inches, meters, or centimeters. The environmental temperature appears as additional parameter whenever distances are displayed. Thus, up to 3 parameters are available.

Parameter	Settings / Value range	Default
Delay	0 ms - 900 ms 0 μ s - 900000 μ s 0 feet - 1014 feet 0 inch - 12169 inch 0 m - 309 m 0 cm - 30910 cm	0 ms
Unit	ms, μ s, feet, inch, m, cm	ms
Temp	-20°C - 60°C -4°F - 140°F	20°C

The **Delay** parameter determines the delay time of the corresponding channel or the distance between different loudspeaker clusters.

Unit allows the user to select between time or distance display. Distances are automatically converted into delay times plus the calculation additionally includes the influence of the environmental temperature.

Temp allows you to enter a value for the momentary environmental temperature. This parameter appears only when the selected display-unit is distance. The affect of the environmental temperature on the resulting delay time is automatically included in the calculation.

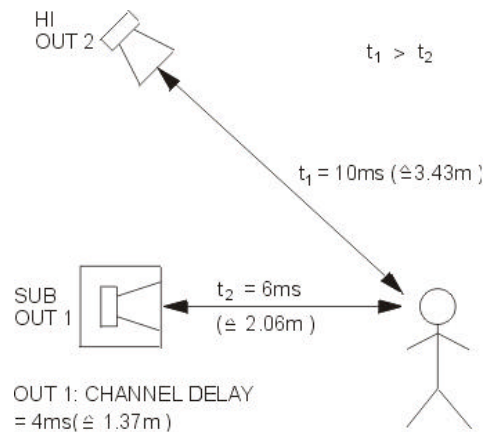

PARAMETERS

COMPRESSOR

The compressor automatically reduces level peaks above a certain threshold and therefore provides reliable protection against power amplifier clipping and damaging the connected loudspeaker systems.

Parameter	Settings / Value range	Default
Thrsh	0.27V - 8.70V	8.70V
Rat	1/1.0, 1/1.4, 1/2.0, 1/4.0, 1/8.0	1/2.0
Attack	0ms - 99ms	5 ms
Rel	50ms - 999ms	250 ms

The **Thrsh** parameter (Threshold) defines the level at which the compressor starts operating. Signal levels below this value are not influenced. As soon as levels reach or exceed the threshold value, the signal is compressed according to the set value of the Ratio parameter.

Ratio - **Rat** - determines the compression ratio - the amount which the incoming signal is compressed. For instance, a ratio of "1/4.0" means that a level change of 4 dB at the input results in a level change of only 1 dB at the output; provided that the input level exceeds the threshold level.

Attack defines the time interval, after which the compressor starts to operate. With short attack settings, the compression starts nearly instantly while with longer attack times, part of the audio signal's impulse can pass unaltered.

Release -**Rel**- sets the compressor's release time, after the signal level has dropped again below the threshold value. When the signal's level drops below the threshold, the audio signal's gain is processed to return to its original value. This signal processing follows an exponential curve, so that the volume change is appropriate for the human hearing. When selecting a release value that is too short, the signal level rises too fast, which also results in pumping. On the other hand, too long release times often lead to a dramatic loss in dynamic.

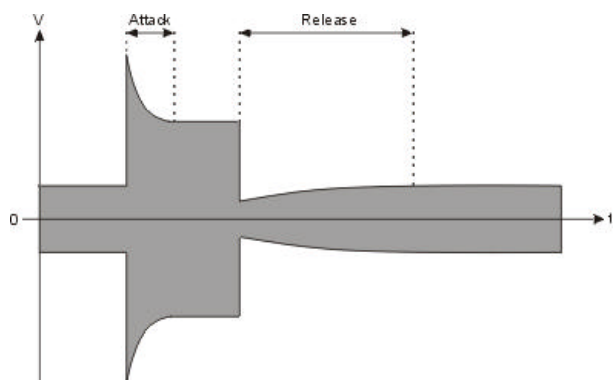
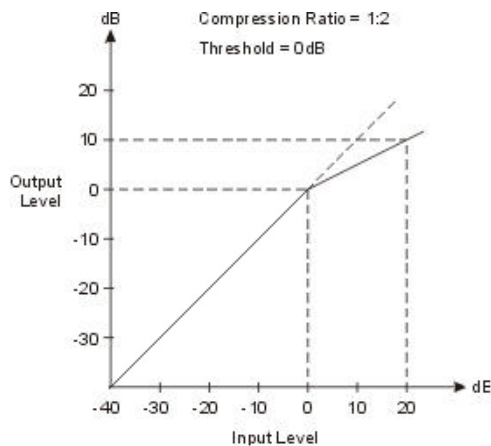

LIMITER

The limiter provides additional protection against the occurrence of clipping and overload conditions. The maximum level of the audio signal is limited to the set threshold value. The short attack times guarantee that even sudden peak levels are effectively attenuated.

Parameter	Settings / Value range	Default
Thrsh	0.27V - 8.70V	8.70V
Release	50ms - 999ms	100ms

The **Thrsh** parameter (Threshold) defines the level at which the limiter starts operating. Signal levels below this value are not influenced. As soon as levels reach or exceed the threshold value, they are automatically limited to this value. Normally, the limiter threshold should be set to a value that is some dBs above the compressor threshold. This provides the best protection against loudspeaker damage as a result from sudden peak levels.

Release defines the limiter's release time, after the signal level has dropped again below the threshold value. When the signal's level drops below the threshold, the audio signal's gain is processed to return to its original value. This signal processing follows an exponential curve, so that the volume change is appropriate for the human hearing. When selecting a release value that is too short, the signal level rises too fast, which also results in pumping. On the other hand, too long release times often lead to a dramatic loss in dynamic.

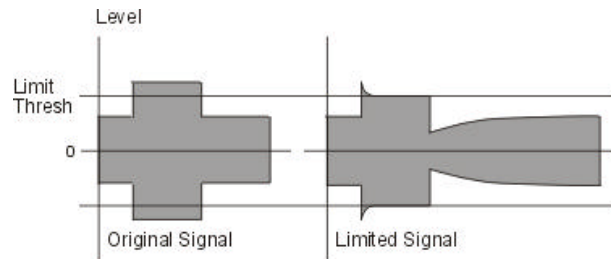
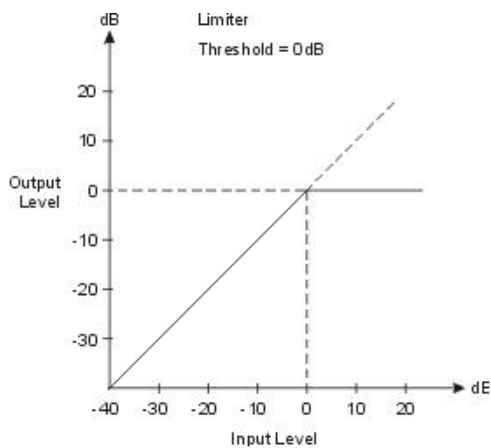

LEVEL

Each output channel employs a digital level control and a polarity switch. These controls provide the possibility to compensate volume differences and phase shift between the different x-over channels.

Parameter	Settings / Value range	Default
Level	Off, -30.0 dB - +6.0 dB	0.0 dB
Polarity	normal, inverted	normal

The **Level** parameter sets the output level of the corresponding output channel. The setting can be performed in steps of 0.5dB.

Polarity defines the polarity of the audio signals of the outputs 1 - 4 . This parameter is also accessible in the HIPASS X-OVER or LOPASS X-OVER display windows. The corresponding descriptions provide you with additional information about the correct setting of a channel's polarity.

OPTION

9. OPTION FUNCTIONS

The "option programs" offer several additional, important information and preference settings for the DSP 244.

Using the SELECT keys you can choose between the following functions:

- LCD CONTRAST setting
- EDIT MODE selection
- COMPR & LIMIT THRESH UNIT - setting of the compressor's and limiter's threshold unit
- VU MODE - level meter display mode setting
- LOCK CODE - edit protection
- TEMPERATURE UNIT settings
- MIDI RX / TX CHANNEL settings
- SEND EDITED PARAMS - parameter transmission
- RS232 TO MIDI transmission
- CONTACT INTERFACE - NRS 90246 Contact Closure Interface settings
- NRS 90247 RS-485 Interface Settings
- SOFTWARE REV - display of the internal software revision number

Press OPTION (7) to activate the option programs.

The last used option program appears on the display; e. g.:

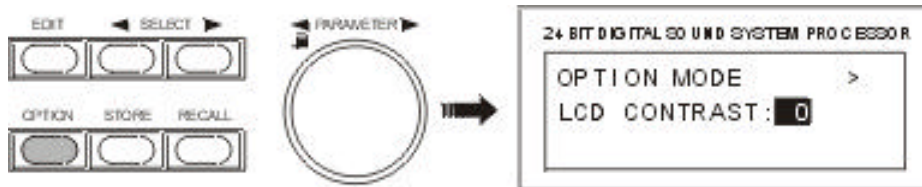

Use the two SELECT keys (5 and 6) to select the desired option page and set the corresponding values using the rotary encoder (10).

You can leave the OPTION mode by pressing OPTION (7) again, or you can press any other MODE key (i. e. pressing the EDIT key switches to Edit mode).

9.1 SETTING THE LCD CONTRAST

The LCD contrast or viewing angle can be set in a range of -10 (bottom view) and +10 (top view).

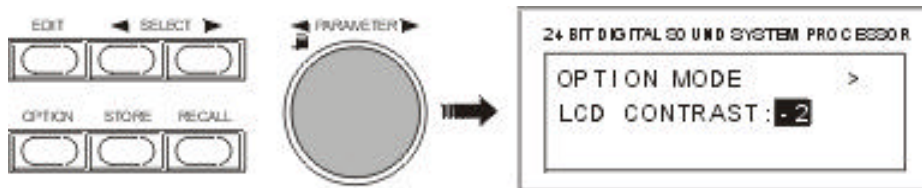

9.2 EDIT MODE SELECTION

This page allows you to choose the operation mode which the DSP 244 is operated in. The display shows the following selection menu:

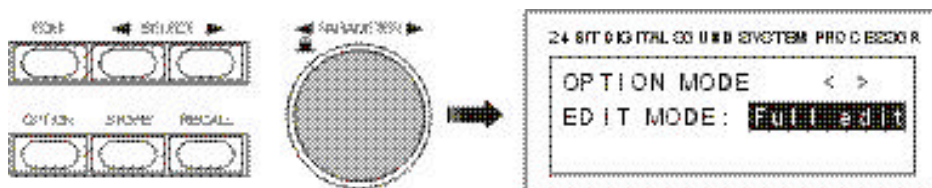

When you select **No edit**, editing and program selection is not possible.

In **Full edit** mode, all parameter settings are accessible.

9.3 COMPRESSOR AND LIMITER THRESHOLD UNIT

This function allows setting the unit of the compressor and limiter threshold.

Volts:

The threshold value is displayed in volts.

dBu (0.775 V):

The threshold value is displayed in dBu (0dBu = 0.775V).

dB from Clip:

Threshold setting in dB relative to full modulation.
(0 dB = full modulation).

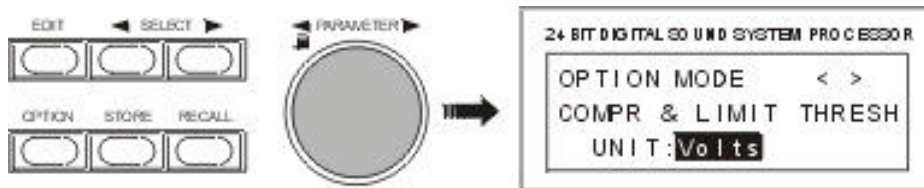

9.4 VU LEVEL METER DISPLAY MODE

Normal fast:

The peak hold function is off; the levels are displayed with a short drop rate of approximately 600 dB/s.

Peak hold:

The peak hold function is on for a more convenient level setting.

Slow decay:

With this setting, levels are displayed with a long drop rate of approximately 60 dB/s; i. e.: with lower signal levels the meter instruments drop slower.

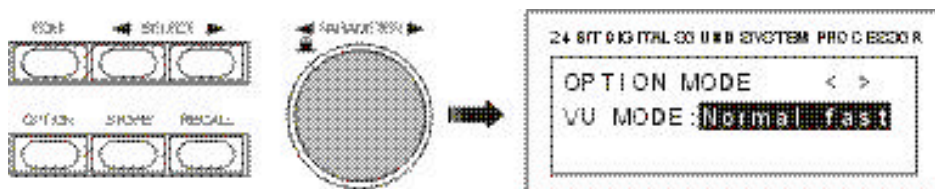

9.5 EDIT PROTECTION

The DSP 244 offers the possibility for edit-protection. Once this protection mode is enabled, internal settings cannot be altered unless the required code-number is entered first. In this way, the appliance is effectively protected against inadvertent or faulty operation.

NOTE:

The rotary controls INPUT 1 / 2 and OUTPUT 1-4 are analog level controls. Edit protection does not restrain the functioning of these controls. Secure the front panel using the PA 1 Plexiglas cover to prevent inadvertent erroneous operation.

To activate edit-protection, you have to select the "LOCK CODE" page in the OPTION mode. Use the rotary encoder to enter your personal password code-number. Acknowledge your entry by pressing the STORE key.

OPTION

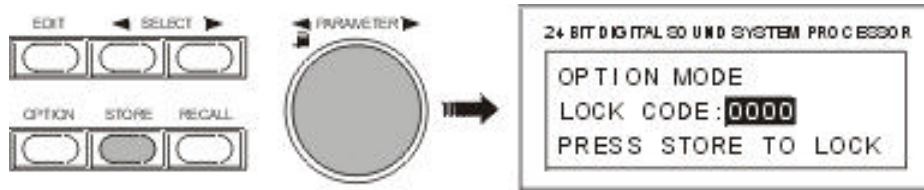

The following safety dialog appears: ARE YOU SURE? PRESS STORE TO CONFIRM !
Press the STORE twice to acknowledge this dialog.

When trying to change one of the appliance's settings, SYSTEM IS LOCKED! appears on the display, indicating that the DSP 244's operating system is blocked for entries via the numeric keys or the rotary encoder.

To disable edit-protection, select the "LOCK CODE" page in the OPTION mode again. The display shows:

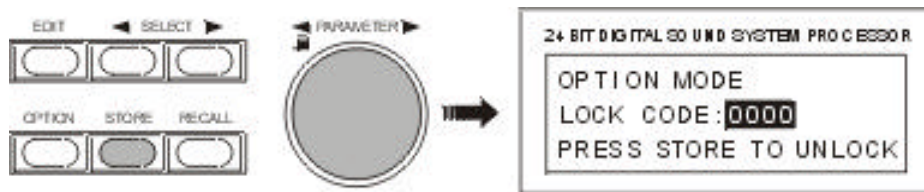

Enter the correct password code number and press STORE to acknowledge the entry. Afterwards, edit-protection is disabled and all parameter values are again freely accessible for alteration.

9.6 TEMPERATURE UNIT settings

This function allows the user to select the unit for the temperature settings. Temperature values are used in the master and channel delays, which enables the DSP 244 to automatically include temperature-related affects in the computing of delay times.

Celsius:

Temperatures are displayed in degrees Celsius (°C).

Fahrenheit:

Temperatures are displayed in degrees Fahrenheit (°F).

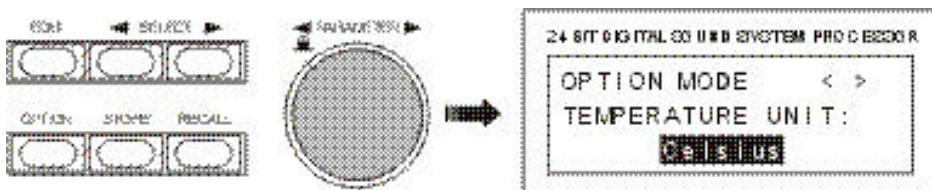

9.7 MIDI RX / TX CHANNEL settings

Here you can set the channels for sending and receiving MIDI DATA. The setting also applies to sending and receiving SYSTEM EXCLUSIVE DATA (SysEx).

You can select one of the following settings for the MIDI RX CHANNEL:

Off:

No MIDI DATA is received. The DSP 244 cannot be controlled by MIDI commands.

Omni:

The DSP 244 receives MIDI DATA from all 16 MIDI channels.

1 - 16:

The DSP 244 only receives incoming MIDI DATA on the selected MIDI channel 1 to 16.

You can select one of the following settings for the MIDI TX CHANNEL:

Off:

No MIDI DATA is transmitted.

1 - 16:

The DSP 244 transmits MIDI DATA via the selected MIDI channel 1 to 16.

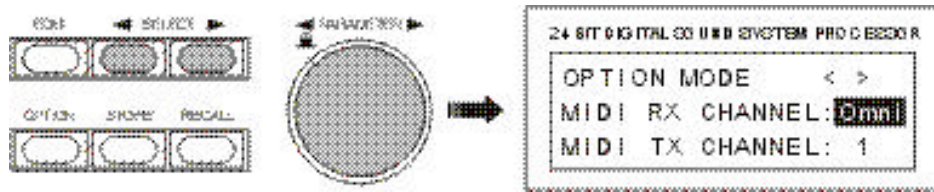

9.8 SEND PARAMETERS

During editing or when sending a program change command, the DSP 244 is capable of transmitting its parameters in real time via the serial port(s). A complete parameter dump of the new program is automatically carried out during program changes. This ensures that settings of receiver and sender are identical. The function also provides the possibility to control additional DSP 244 (Master-Slave-Operation) or to send data to the DSP 244 Editor which then are displayed on the PC-screen.

This page allows you to adjust whether data is being transmitted, and if so, which interface is going to be used.

Off:

No data is transmitted.

To MIDI:

During editing and program change, data is transferred via the previously set MIDI-transmission channel (MIDI TX CHANNEL). This allows to control a single or several connected DSP 244 slave units from one master. All parameters and program changes are simultaneously set for the slave and master units. Before connecting several units, always make sure that they all are adjusted to identical programs and parameter settings.

To RS232:

During editing and program change, data is transmitted via the RS-232 port. In case that you have connected a PC with the DSP 244 Editor software installed, you are able to monitor changes in the setting on the PC-screen.

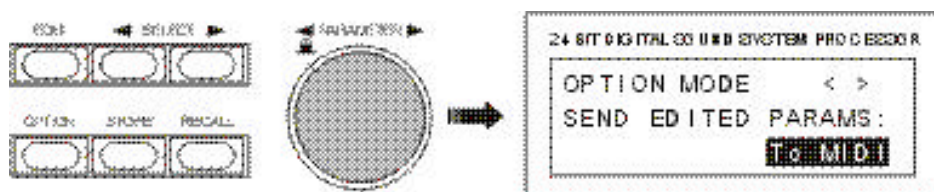

9.9 RS-232 TO MIDI data transmission

This function provides the possibility to pass data that is received over the RS-232 port on to the MIDI OUT port, which offers the opportunity to create a so called "RS-232 to MIDI Bridge" from the master unit. Whenever several DSP 244 are included in a MIDI chain, connect the DSP 244 master via RS-232 interface to your computer, and control the master (via RS-232) as well as the DSP 244 slaves (via MIDI) from the PC.

OPTION

Off:

No RS-232 data is transmitted via MIDI ports.

On:

Data that is received from the RS-232 port is passed on to linked units via the MIDI port and is transmitted using the previously selected MIDI transmission channel (MIDI TX CHANNEL).

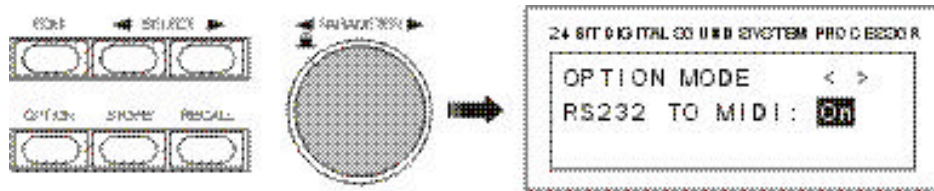

9.10 NRS 90246 CONTACT CLOSURE INTERFACE settings

Amongst others, the DSP 244 is prepared for retrofitting an optional NRS 90246 Contact Closure Interface, which can be used instead of the RS-232 interface. The Contact Closure Interface offers eight control inputs that can be used for program change commands or Soft-Mute.

The Contact Closure interface is equipped with a 9-pole D-SUB terminal strip (male).

The pin-assignment is:

Pins 1 - 8 : Control contacts

Pin 9: Ground

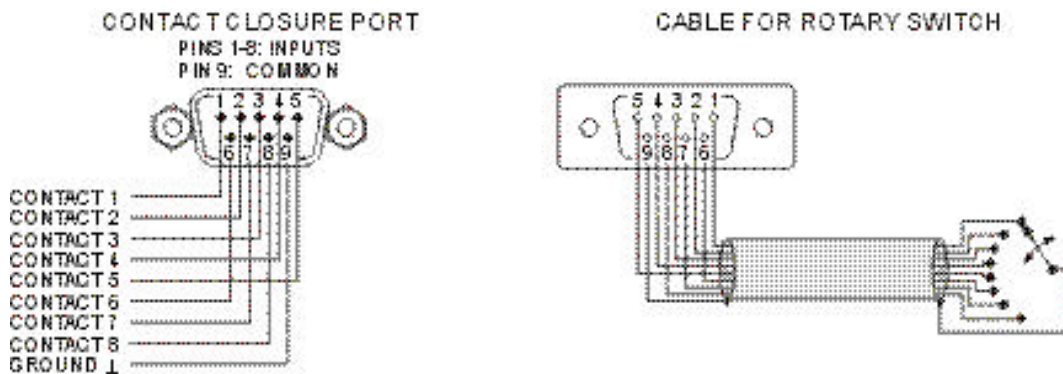

You are able to connect switches, rotary switches or relays, which are controlled through closing the corresponding contact. While the control input 1 has the highest priority, control input 8 has the lowest; i. e. always the function of the lowest closed contact is activated.

The retrofitted interface is automatically recognized by the DSP 244 during power on and the corresponding menu appears in the option programs. This menu allows to program and assign the functions of individual control contacts. The two SELECT keys provide the possibility to select one of the two parameters: CNTCT (contact) or PGM (program). Setting are made using the rotary encoder.

CNTCT: 1

Here you are able to select the control input (1 - 8) for programming.

PGM: U01

In this case, the selected control input is used for program change commands. You are able to select user-programs U01 to U30 or factory-presets F01 to F50.

PGM: Mute

This setting allows to use the selected control input for Soft-Mute. Upon closing of the corresponding contact, the DSP 244 outputs are muted - upon opening, the signal is "softly" switched on again. The "Mute" parameter is listed at the end of the program chart, after F50.

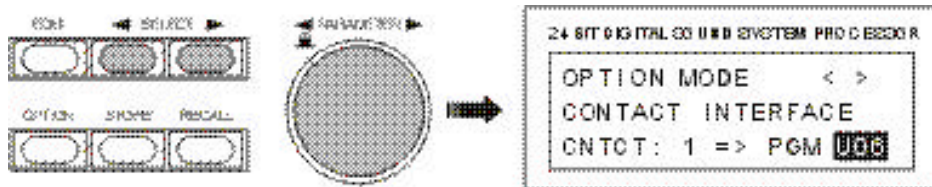

9.11 NRS 90247 RS-485 INTERFACE SETTINGS

Amongst other available options, retrofitting the NRS 90247, RS-485 interface in the DSP 244 instead of the RS-232 interface is possible as well. The RS-485 interface allows configuring, controlling and monitoring up to 31 DSP 244 from a PC. In that case, assigning individual RS-485 IDs to each DSP 244 is necessary.

The Group-ID can only be edited via the PC-software. RS-485 IDs are set in the following menu.

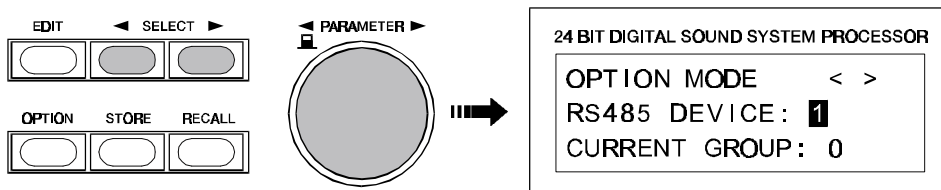

9.12 DISPLAY OF THE SOFTWARE REVISION NUMBER

The display shows the software revision of the DSP 244 host processor; e. g. Version 2.01.

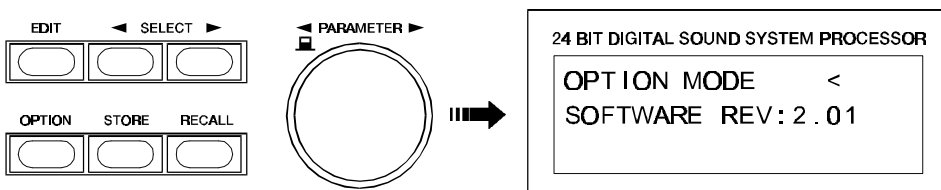

SPECIFICATIONS

10. SPECIFICATIONS

10.1 TECHNICAL SPECIFICATIONS

Mains voltage	90 - 250 V AC / 50 - 60 Hz
Power consumption	20 watts
Safety class	I
Inputs	2 x XLR IN, electronically balanced, transformer optional available 2 x XLR OUT (Direct Out)
Input voltage (nominal)	1.55 V / + 6 dBu
Max. input voltage	24.5 V / + 30 dBu
Input impedance	20 kohms
Common mode rejection	> 70 dB (1kHz)
AD-conversion	24-bit, Sigma-Delta, 128 times oversampling, linear phase
Outputs	4 x XLR OUT, electronically balanced
Output voltage (nominal)	1.55 V / + 6 dBu
Max. output voltage	8.7 V / + 21 dBu
Output impedance	< 100 ohms
Min. load impedance	600 ohms
DA-conversion	24-bit, Sigma-Delta, 128 times oversampling
Frequency response	20 Hz - 20 kHz (- 0.5 dB)
S/N ratio	115 dB (typical)
Distortion without transformer	< 0.01 %
Distortion with transformer	< 0.05 %
Frequency crossovers	6, 12, 18, 24 dB/oct. slope; Butterworth, Bessel, Linkwitz-Riley
Filters	26 parametric equalizers Low-Shelving equalizer, LPN (Lowpass-Notch) switchable Hi-Shelving equalizer, 6 / 12 dB slope switchable, Lo-Cut filter (B-6 alignment switchable), Hi-Cut filter, All-Pass filter
Compressor / limiter	4 digital compressors / limiters
Delay	3 master delays (2 ms - 900 ms) 4 channel delays (0 ms - 900 ms) delay-increment 21 µsec.
Data format	24-bit linear AD / DA conversion, 48-bit processing
Sampling rate	48 kHz
MIDI IN / OUT / THRU	Data Dump, Master / Slave operation/ Remote Control
Display	122 x 32 Dots, graphic LC-Display with LED-background lighting
Dimensions	483 x 43.6 x 374 (W x H x D in mm), 19", 1 HU
Weight	5 kg / 11 lbs
Locking function	protection against inadvertent operation via function-lock
Accessories	PA 1 plexiglas cover 1 HU
Options	NRS 90244 Input transformer NRS 90247 RS-485 interface NRS 90246 Contact Closure interface

Subject to changes without prior notice!

10.2 MIDI

This chapter provides information (all implemented MIDI transmission commands) for the experienced software programmer that wants to design new software for the DSP 244. The implementation chart is relevant for the software revision V1.0 or higher.

MIDI data transfer is possible, only when a MIDI channel is activated (OMNI, 1 - 16). See also chapter 9.7, MIDI RX / TX CHANNEL settings.

10.2.1 GENERAL MIDI COMMANDS

Program Change	MIDI-Byte	Description
	0xCn (hex) 0xxx xxxx (bin)	n = MIDI Channel 0 - 15 1 .. 30 = User Programs U01 .. U30 31 .. 80 = Factory Presets F01 .. F50 0 = Recall current program

10.2.2 MIDI SYSTEM EXCLUSIVE IMPLEMENTATION

Identity Request (recognized)	MIDI-Byte	Description
	F0 (hex) 7E 0n 06 01 F7	System Exclusive Universal System Exclusive Non-real time header n = MIDI Channel 0 - 15 (7F = All Channels) General Information Identity Request End of SysEx Message

This command tells the DSP 244 to return its ID-number.

Identity Reply (transmitted when Identity Request is received)	MIDI-Byte	Description
	F0 (hex) 7E 0n 06 02 30 18 DEV_CODE REVISION F7	System Exclusive Universal System Exclusive Non-real time header n = MIDI Channel 0 - 15 (7F = All Channels) General Information Identity Reply DYNACORD ID: No 48 DSP 244 ID: No 24 Reserved 3 Byte Device Code Revision: 4 Digit ASCII Code End of SysEx Message

The DSP 244 sends this ID-Code as a reply to an Identity Request. Transmitted are the DYNACORD ID-No. 48, the DSP 244 UNIT-ID No. 24, a 3-Byte Unit-Code and the Revision No.

MIDI

Serial Link (recognized + transmitted)	MIDI-Byte	Beschreibung
	F0 (hex) 30 0n 18 01 DATA CHECKS F7	System Exclusive DYNACORD ID: No 48 n = MIDI Channel 0 - 15 (7F = All Channels) DSP 244 ID: No 24 Function ID: Serial Link / Parser ASCII Code Line for Command Parser (up to 120 Byte) Checksum for DATA (7 Bit, 2's Complement) End of SysEx Message

Further details concerning the Command Parser ASCII Code are shown in the following tables.

Device Commands						
UNIT-ID	Tree				Value	Unit
/ID1/						
	COMMAND/					
		STORE			1 ... 30	
		LOAD			1 ... 80	
		DUMP			0 ... 30	
		DEVICE ?				

Com Port Configuration						
COMCONF	Tree				Value	Unit
	LINEFEED				ON/OFF	
	PROMPT				ON/OFF	
	ECHO				ON/OFF	

Command Parser Code Table						
UNIT-ID	Tree				Value	Unit
/ID1/						
	IN1/					
		DELAY			1.927... 900.0	ms
		EQ1/				
			FREQ		20 ... 20000	Hz
			GAIN		-12 ... 12	dB
			QUAL		0.4 ... 20.0	
			SLOPE		6,12	dB/Octave
			TYPE		BYPASS,PEQ,LOSLV, HISLV,HIPASS,LOPASS	
		EQ2/ ... EQ5/			see EQ1/	
	IN2/				see IN1/	
	INSUM/					
		DELAY			1.927 ... 900.0	ms
	OUT1/					
		EQ1/				
			FREQ		20 ... 20000	Hz
			GAIN		-12 ... 12	dB
			QUAL		0.4 ... 20.0	
			SLOPE		6,12 *)	dB/Octave
			TYPE		BYPASS,PEQ,LOSLV, HISLV,HIPASS,LOPASS, ALLPASS	
		EQ2/ ... EQ4/			see EQ1/	
		XOVER/				
			HIPASS/			
			FREQ/		20 ... 20000	Hz
			TYPE/		THRU,6DB,12DBQ0.5, 12DBQ0.6,12DBQ0.7, 12DBQ0.8,12DBQ1.0, 12DBQ1.2,12DBQ1.5, 12DBQ2.0, LINKW12DB,BESSEL12DB BUTTER12DB,BESSEL18DB BUTTER18DB,LINKW24DB, BESSEL24DB,BUTTER24DB	
			LOPASS/		see HIPASS/	
		DELAY			0 ... 900.0	ms
		POLARITY			NORMAL,INVERTED	
		LEVEL			OFF, -30 ... 6 dB	dB
		LEVREL			-36 ... +36	dB
		ROUTING			IN1,IN2,IN1+2	
		MUTE			1,0	
		COMPRESSOR/				
			RATIO		1OVER1.0,1OVER1.4, 1OVER2.0,1OVER4.0, 1OVER8.0	
			THRESH		-30 ... 0	dB
			ATTACK		0 ... 99	ms
			RELEASE		50 ... 999	ms
		LIMITER/				
			THRESH		-30 ... 0	dB
			RELEASE		50 ... 999	ms
		LEDS/				
			SUB		ON, OFF	
			LO		ON, OFF	
			MID		ON, OFF	
			HI		ON, OFF	
	OUT2/ ... OUT4/				see OUT1/	
	MISC/					
		DELAY_IN_UNIT			US,MS,FEET,INCH,M,CM	
		DELAY_OUT_UNIT			US,MS,FEET,INCH,M,CM	
		TEMPERATURE			-4 ... 140	°F
		TEMPERATURE_UNIT			CELSIUS,FAHRENHEIT	
		PROGNAME			Up to 16 Characters (ASCII Code <= 7Fh)	
/ID2/ ... /ID32/					see /ID1/	

*) For Type = Allpass: Slope = 6: First Order Allpass
Slope = 12: Second Order Allpass

Example: /ID3/ OUT1/ XOVER/ HIPASS/ FREQ 1500

RETROFITTING INSTRUCTIONS

10.3 RETROFITTING INSTRUCTIONS

CAUTION: These servicing instructions are for use by qualified personnel only. To reduce the risk of electric shock, do not perform any servicing other than that contained in the Operating Instructions unless you are qualified to do so. Refer all servicing to qualified service personnel.

10.3.1 Installation manual for the input transformer (NRS 90244, EDP-No. 112757):

Contents NRS 90244:

1 x Input transformer RK279

1 x Screw M2,5 x 6

Installation instructions NRS 90244:

1. Switch the DSP 244's power off and unplug the mains cord.
2. Remove the cover plate after unscrewing 2 screws on the top, 4 on the sides, and 3 on the rear.
3. To be able to install the transformer you have to remove the printed board assembly 80448 (Analog Board). Loosening the printed board assembly 80449 (Digital Board) is also necessary. Loosen all screws of the Digital Board 80448 (16 screws on the rear plate which hold the sockets, 9 on the bottom plate) and of the printed board assembly 80449 (5 screws on the bottom plate). Detach the connections between the two printed board assemblies. Slightly lift the printed board 80448 and carefully pull it in the direction to the front of the appliance until the sockets are out of the rear plate. Now, you can turn the printed board assembly 80448 so that the needed contacts for installing the transformer are accessible.
4. Remove the two resistors of the specific input channel (IN 1: R104 / R105, IN 2: R204 / R205).
5. Clean the holes for the transformer from soldering tin by suction (7 holes per transformer).
6. Insert the transformer for IN 1 into the holes at position T101 or for IN 2 at position T201.
7. Fix the transformer onto the printed board assembly by using the supplied screw.
8. Solder the contacts of the transformer on the printed board assembly (7 soldering points per transformer).
9. Re-install all printed board assemblies in the opposite manner of their removal. Make sure that all wire connections are re-connected and that all fixing screws are tightened in place.
10. Re-attach the cover plate and tighten its screws.

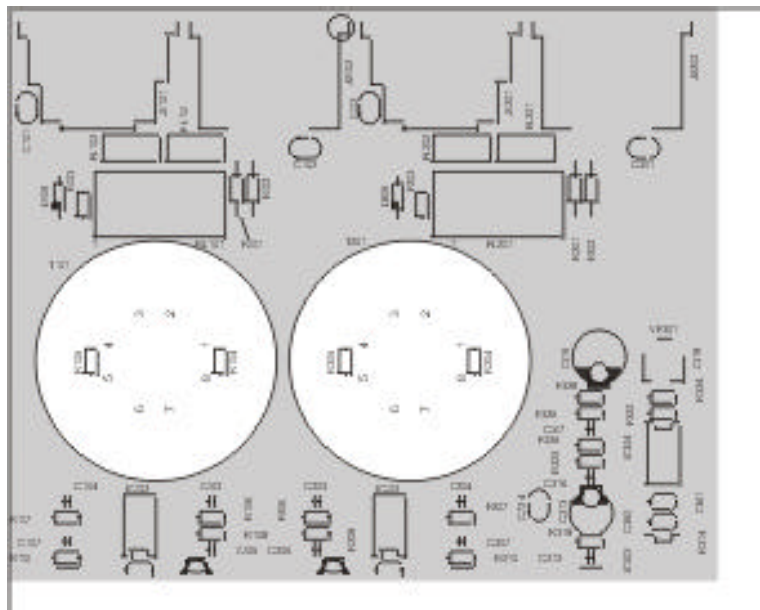

10.3.2 Installation manuals for interface cards:

Contact Closure Interface (NRS 90246, EDP-No. 112766)
RS-485 Interface (NRS 90247, EDP-No. 112767)

Contents NRS 90246:

1 x Information sheet NRS 90246
1 x Printed board assembly Contact Closure (83114)
1 x Rear plate blinding
4 x Screws M3 x 6

Contents NRS 90247:

1 x Information sheet NRS 90247
1 x Information sheet "Important Information"
1 x Printed board assembly RS-485 (83115)
1 x Rear plate blinding
4 x Screws M3 x 6

Installation instructions NRS 90246, NRS 90247:

1. Switch the DSP 244's power off and unplug the mains cord.
2. Remove the cover plate after unscrewing 2 screws on the top, 4 on the sides, and 3 on the rear.
3. Loosen the blinding on the rear plate (2 screws on the rear).
4. Install the extension kit's printed board assembly at the correct destination (see figure below).
5. First, tighten the screws at the rear plate (A) and then the two screws that fix the printed board assembly in place at the bottom plate (B).
6. Using the 26-pole flat wire cable (C), establish the connections between the printed board assembly of the extension kit and the Analog Board (printed board assembly 80448).
7. Re-attach the cover plate and tighten its screws. Re-insert the mains cord and switch the appliance's power on. The newly installed interface is automatically recognized.
8. Now, you are able to make all necessary software settings for the interface in the OPTION mode (see also chapter 9, OPTION FUNCTIONS).

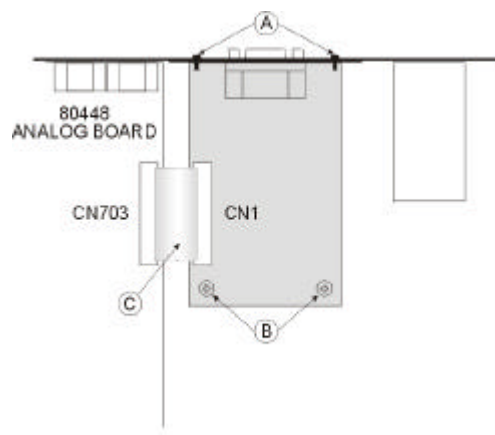

Position of the NRS 90246, NRS 90247 in the DSP 244

BLOCKDIAGRAMM / BLOCK DIAGRAM

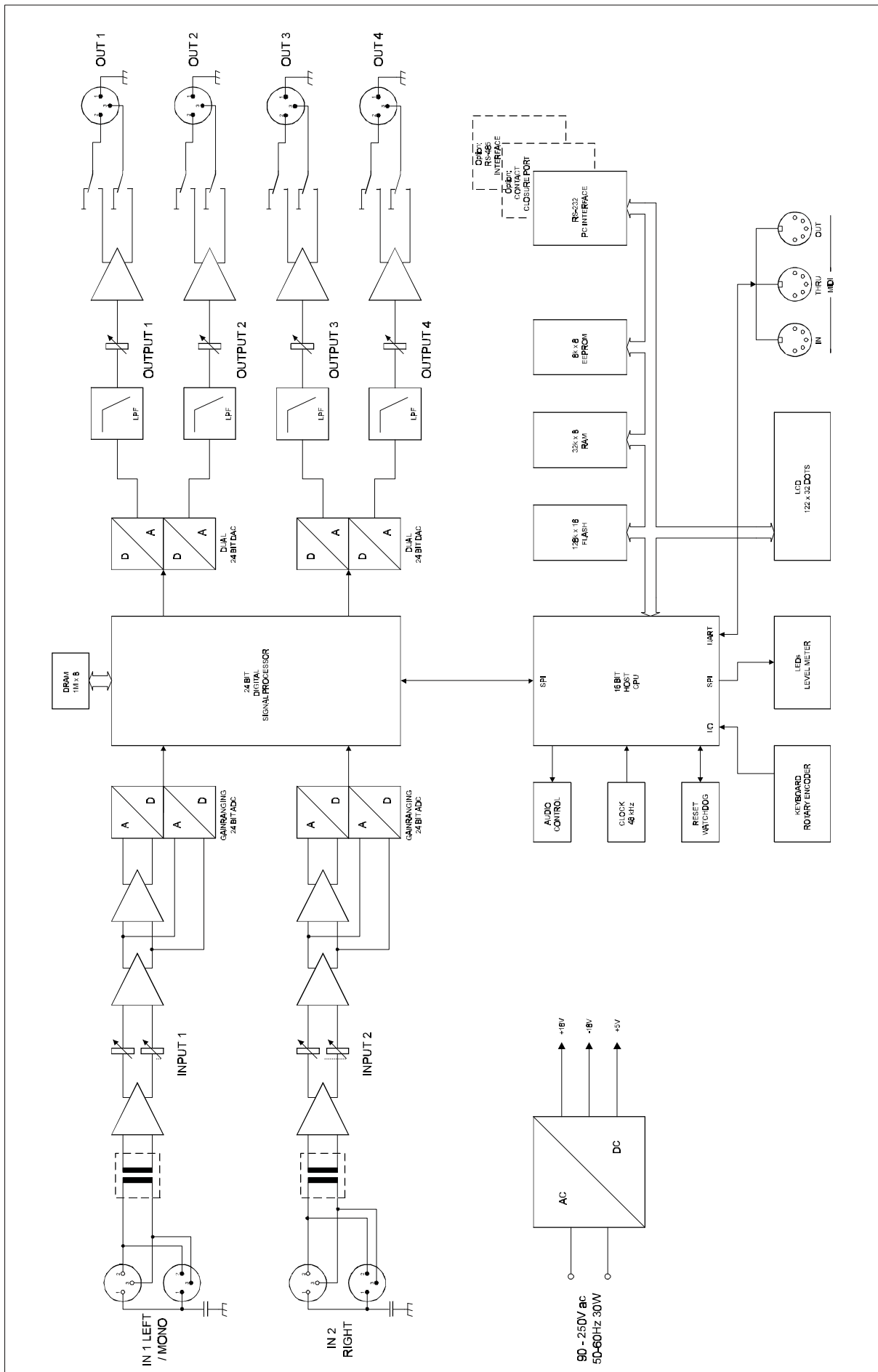

FLUSSDIAGRAMM / FLOW DIAGRAM

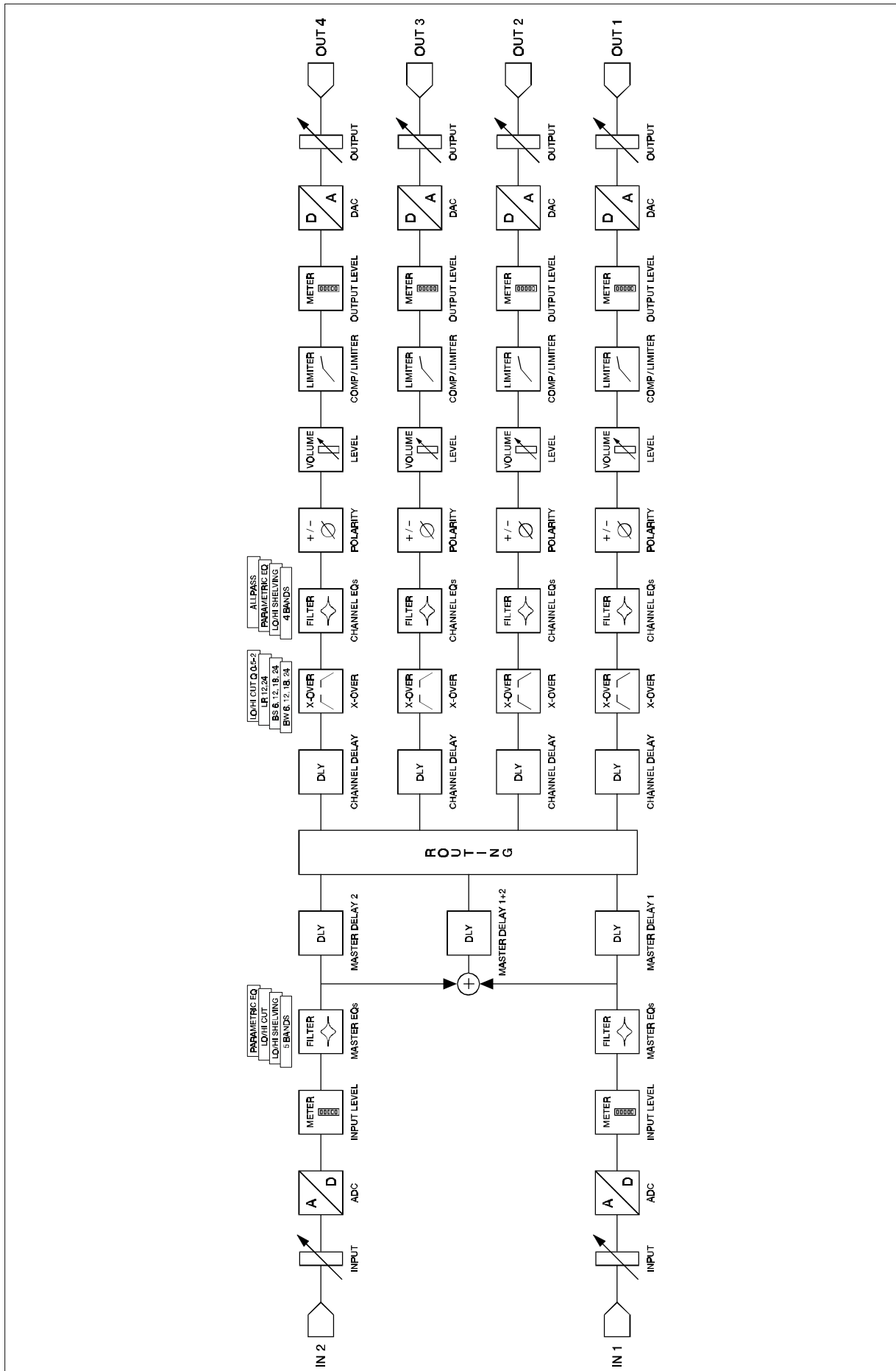

ABMESSUNGEN / DIMENSIONS

Abmessungen / Dimensions (in mm)

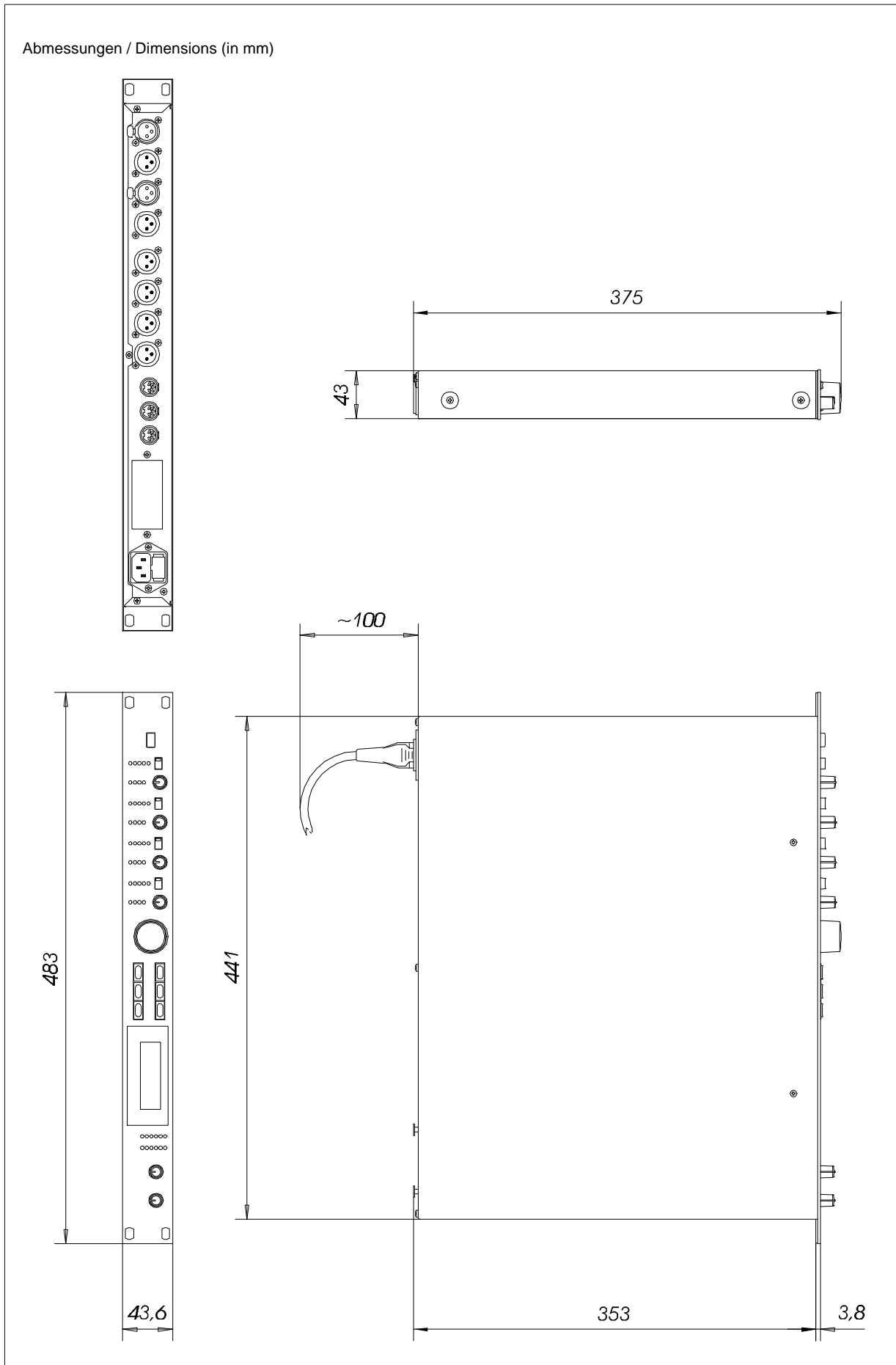

GARANTIE

Das Werk leistet Garantie für alle nachweisbaren Material- und Fertigungsfehler für die Dauer von 36 Monaten ab Verkauf.

Garantieleistungen werden nur dann anerkannt, wenn gültige, d.h. vollständig ausgefüllte Garantieunterlagen vorliegen.

Von der Garantie ausgenommen sind alle Schäden, die durch falsche oder unsachgemäße Bedienung verursacht werden. Bei Fremdeingriffen oder eigenmächtigen Änderungen erlischt jeder Garantieanspruch.

WARRANTY

The manufacturer's warranty covers all substantial defects in materials and workmanship for a period of 36 months from the date of purchase.

Liability claims are accepted solely, when a valid – correctly and completely filled out – Warranty Registration form is presented by the original owner of the product. The warranty does not cover damage that results from improper or inadequate treatment or maintenance. In case of alteration or unauthorized repairs, the warranty is automatically terminated.

GARANTIE

La garantie constructeur couvre tous les défauts matériels et de main d'œuvre pour une période de 36 mois à compter de la date d'achat. La garantie ne sera reconnue que si la Carte de Garantie, correctement et complètement remplie, est présentée par l'acheteur d'origine du produit. Les dommages dus à un mauvais maniement de l'appareil, à un traitement ou une maintenance incorrects ou inadéquats ne sont pas garantis. Toute modification ou intervention effectuée par une personne non qualifiée entraîne la résiliation automatique de la garantie.



GmbH • Hirschberger Ring 45 • 94315 Straubing • Telefon (09421) 706-0 • Telefax (09421) 706-265

Änderungen vorbehalten. Subject to change without prior notice. Printed in Germany 28. 10. 2001 / 356 273

REV. 5

Internet: [http:// www.dynacord.de](http://www.dynacord.de)

Free Manuals Download Website

<http://myh66.com>

<http://usermanuals.us>

<http://www.somanuals.com>

<http://www.4manuals.cc>

<http://www.manual-lib.com>

<http://www.404manual.com>

<http://www.luxmanual.com>

<http://aubethermostatmanual.com>

Golf course search by state

<http://golfingnear.com>

Email search by domain

<http://emailbydomain.com>

Auto manuals search

<http://auto.somanuals.com>

TV manuals search

<http://tv.somanuals.com>