



1080p Upconvert DVD Player

DX-UPDVD2

USER GUIDE

Download from [Www.Somanuals.com](http://www.Somanuals.com). All Manuals Search And Download.

1080p Upconvert DVD Player

Contents

| | |
|------------------------------------|----|
| Important safety instructions..... | 2 |
| Features | 6 |
| Setting up your DVD player | 11 |
| Using your DVD player..... | 14 |
| Troubleshooting..... | 22 |
| Maintaining | 22 |
| Specifications..... | 23 |
| Legal notices | 24 |
| 90-day limited warranty | 25 |

Important safety instructions

- 1 Read these instructions.
- 2 Keep these instructions.
- 3 Heed all warnings.
- 4 Follow all instructions.
- 5 Do not use this apparatus near water.
- 6 Clean only with a dry cloth.
- 7 Do not block any ventilation openings. Install in accordance with the manufacturer's instructions.
- 8 Do not install near any heat sources such as radiators, heat registers, stoves, or other apparatus (including amplifiers) that produce heat.

- 9 Do not defeat the safety purpose of the polarized or grounding-type plug. A polarized plug has two blades with one wider than the other. A grounding type plug has two blades and a third grounding prong. The wide blade or the third prong are provided for your safety. If the provided plug does not fit into your outlet, consult an electrician for replacement of the obsolete outlet.
- 10 Protect the power cord from being walked on or pinched particularly at plugs, convenience receptacles, and the point where they exit from the apparatus.
- 11 Only use attachments/accessories specified by the manufacturer.
- 12 Use only with the cart, stand, tripod, bracket, or table specified by the manufacturer, or sold with the apparatus. When a cart is used, use caution when moving the cart/apparatus combination to avoid injury from tip-over.
- 13 Unplug this apparatus during lightning storms or when unused for long periods of time.
- 14 Refer all servicing to qualified service personnel. Servicing is required when the apparatus has been damaged in any way, such as power-supply cord or plug is damaged, liquid has been spilled or objects have fallen into the apparatus, the apparatus has been exposed to rain or moisture, does not operate normally, or has been dropped.
- 15 To reduce the risk of fire or electric shock, do not expose this device to rain, moisture, dripping, or splashing, and no objects filled with liquids, such as vases, shall be placed on it.
- 16 An apparatus with a three-prong, grounding-type plug is a Class I apparatus, which needs to be grounded to prevent possible electric shock. Make sure that you connect this Class I device to a grounding-type, three-prong outlet.
- 17 The wall plug is the disconnecting device. The plug must remain readily operable.
- 18 Batteries should not be exposed to excessive heat such as sunshine, fire, or the like.



Caution: *Danger of explosion if the battery is incorrectly replaced. Replace only with the same or equivalent type.*

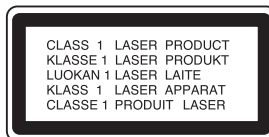

Warning: *This product employs a laser system. To ensure correct use of this product, read this owner's manual carefully and retain it for future reference. Should your player require maintenance, contact qualified service personnel.*

Making adjustments to controls or performing procedures other than those specified herein may result in hazardous radiation exposure.

To prevent direct exposure to the laser beam, do not try to open the enclosure. Visible laser radiation when open. DO NOT STARE INTO THE BEAM.

Introduction

To ensure correct use of your player, read this owner's manual carefully and retain for future reference.

About the symbol

The  symbol may appear on your TV display during operation and indicates that the function is not permitted by your player or specific media.

Notes:

- *Do not use irregularly shaped CDs (for example, heart-shaped or octagonal). Doing so may result in malfunctions.*
- *Depending on the recording software and the finalization, some recorded discs (CD-R/RW or DVD±R/RW) may not be playable.*
- *DVD-R/RW, DVD+R/RW, and CD-R/RW discs recorded using a personal computer or a DVD or CD recorder may not play if the disc is damaged or dirty or if there is dirt or condensation on your player's lens.*
- *If you record a disc using a personal computer, even if it is recorded in a compatible format, there are cases in which it may not play because of the settings of the application software used to create the disc. (Check with the software publisher for more detailed information.)*
- *Your player requires discs and recordings to meet certain technical standards in order to achieve optimal playback quality. Pre-recorded DVDs are automatically set to these standards. There are many different types of recordable disc formats (including CD-R containing MP3 or WMA files), and these require certain pre-existing conditions (see above) to ensure compatible playback.*
- *You should note that permission is required in order to download MP3 or WMA files and music from the Internet. Our company has no right to grant such permission. Permission should always be sought from the copyright owner.*

Regional code

Your player has a regional code (1) printed on the back of the case. Your player can play only DVDs labeled with the same regional code (1) or **ALL**.

Notes:

- *Most DVDs have a globe with one or more numbers in it clearly visible on the cover. This number must match your player's regional code or the DVD cannot play.*
- *If you try to play a DVD with a different regional code from your player, the message "Check Regional Code" appears on the TV screen.*

This product incorporates copyright protection technology that is protected by U.S patents and other intellectual property rights. Use of this copyright protection technology must be authorized by Macrovision, and is intended for home and other limited viewing uses only unless otherwise authorized by Macrovision. Reverse engineering or disassembly is prohibited.

Manufactured under license from Dolby Laboratories. "Dolby" and the double-D symbol are trademarks of Dolby Laboratories.



Disposal of your old appliance

1. When this crossed-out wheeled bin symbol is attached to a product, it means the product is covered by the European Directive 2002/96/EC.
2. All electrical and electronic products should be disposed of separately from the municipal waste stream via designated collection facilities appointed by the government or the local authorities.
3. The correct disposal of your old appliance will help prevent potential negative consequences for the environment and human health.
4. For more detailed information about disposal of your old appliance, please contact your city office, waste disposal service, or the shop where you purchased the product.



Other considerations

Notes:

- *The top and rear panels of your player may become warm after a long period of use. This is not a malfunction.*
- *When your player is not in use, make sure that you remove the disc and turn off the power.*
- *If you do not use your player for an extended period, it may not function correctly. Turn on your player and use it occasionally.*
- *Do not place foreign objects in the disc tray.*
- *If you place your player near a TV, radio, or VCR, the playback picture may become poor and the sound may be distorted. In that case, place the player away from the TV, radio, or VCR.*
- *If the pickup on your player has moisture condensation, the player may not operate correctly. If this is the case, remove the disc and leave it on for two or three hours. That will allow the player to warm up and evaporate any moisture. If you leave the player plugged in, moisture condensation will seldom occur.*

Features

Front panel

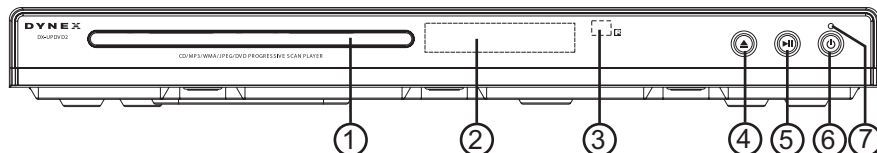

| Item | Description | Function |
|------|-----------------------|---|
| 1 | Disc tray | Place a disc on the tray when it opens. |
| 2 | Display window | Shows the current status of your player. |
| 3 | Remote control sensor | Point the remote control at this sensor to control playback. |
| 4 | ▲ (OPEN/CLOSE) button | Press to open or close the disc tray. |
| 5 | ▶ (Play/Pause) | Press to begin playback. Press again to pause playback. Press again to resume playback. |
| 6 | ⏻ (standby/power) | Press to turn your player on or off. |
| 7 | Power indicator | Turns red on standby and green when the player is turned on. |

Back panel

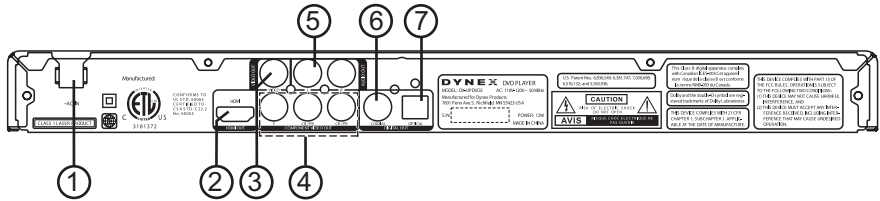



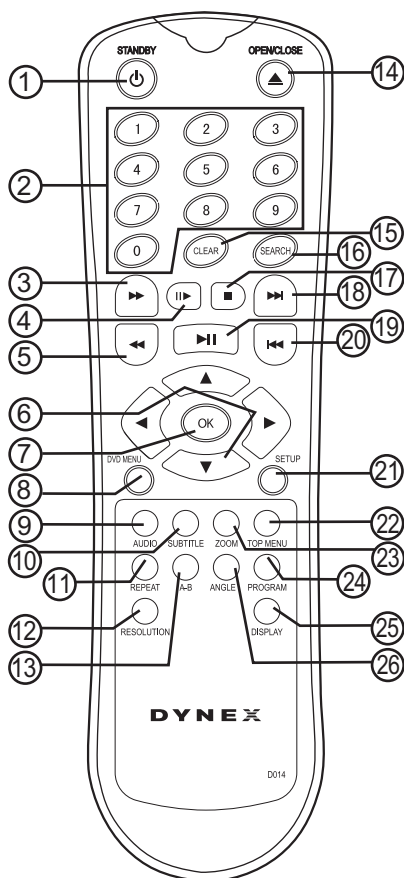

| Item | Description | Function |
|------|--------------------------------|--|
| 1 | AC power cable | Plug this cable into an AC power outlet. |
| 2 | HDMI OUTPUT | Connect to the HDMI input jack on a TV (if available). |
| 3 | Composite video output | Connect to the composite video input jack on a TV (if available). |
| 4 | Component output (Y Cb Cr) | Connect to the component video input jacks on a TV (if available). |
| 5 | Audio output (left/right) | Connect to the audio input jacks (left and right) of a TV, amplifier, or other equipment. |
| 6 | Coax (digital) audio output | Connect to the digital audio coaxial jack on an external amplifier, such as a Dolby Digital decoder. |
| 7 | Optical (digital) audio output | Connect to the digital optical audio input jack on an external amplifier, such as a Dolby Digital decoder. |

Remote control

Remote control



| Item | Button | Function |
|------|--|--|
| 1 | STANDBY/  | Press to turn your player on or off. |
| 2 | 0 - 9 number buttons | Press to select numbered options in a menu or to select audio tracks or JPEG pictures. |
| 3 |  (fast forward) | Press to fast forward the DVD or CD. Press repeatedly to step through the fast forward speeds. |
| 4 |  (step) | Press repeatedly to step forward frame by frame in a video. |

| Item | Button | Function |
|------|---|--|
| 5 | ◀◀ (fast reverse) | Press to fast reverse the DVD or CD. Press repeatedly to step through the fast reverse speeds. |
| 6 | ◀ (Left arrow) ▲ (Up arrow) ▶ (Right arrow) ▼ (Down arrow) | Press to select menu options or adjust settings. |
| 7 | OK | Press to make or confirm menu selections. |
| 8 | DVD MENU | Press to open the DVD menu. |
| 9 | AUDIO | Press to select an audio language or audio channel. |
| 10 | SUBTITLE | Press to select a subtitle language, if available. |
| 11 | REPEAT | Press during playback to step through repeat options, including repeat current chapter, repeat current title, repeat entire disc, and off. |
| 12 | RESOLUTION | Press to change the vertical resolution. |
| 13 | A-B | Press once to set the start of a repeat loop. Press again to set the end of the repeat loop and start repeat playback. Press again to cancel repeat. |
| 14 | OPEN/CLOSE  | Press to open and close the disc tray. |
| 15 | CLEAR | Press to clear any information that was input incorrectly. |
| 16 | SEARCH | Press to enter the <i>Search</i> menu. When the <i>Search</i> menu opens, press the direction keys to select the title/chapter/track number or time setting to which you want to go, then press OK to start playback. |
| 17 | ■ (stop) | Press to stop playback. Playback begins from this point when you press PLAY . Press STOP twice to begin playback from the beginning. |
| 18 | ▶▶■ (next) | Press to advance to the next chapter (DVD) or track (CD). |
| 19 | ▶ (play/pause) | Press to start playback. Press again to pause playback. Press once more to resume playback. |

| Item | Button | Function |
|------|-----------------------|--|
| 20 | I◀◀ (previous) | Press to return to the previous chapter (DVD) or track (CD). |
| 21 | SETUP | Press to open and close the setup menu. |
| 22 | TOP MENU | Press to open the top DVD menu (available on some discs). |
| 23 | ZOOM | Press to zoom in on the DVD image. |
| 24 | PROGRAM | Press to enter the <i>Program</i> menu and set up a playlist of tracks/chapters. Press the direction buttons to move around the menu. Input numbers by pressing the numeric buttons. In DVD mode, input Title and Chapter numbers. In CD mode, input track numbers. Press CANCEL to delete the number you just input. Select CLEAR and press OK to delete the entire playlist. Select PLAY and press OK to start program playback. |
| 25 | DISPLAY | Press to open the on-screen display, which provides current status information and where you can change settings and options. |
| 26 | ANGLE | Press to step through alternate angles to watch DVD playback, if available. |

Installing remote control batteries

To install the remote control batteries:

- 1 Remove the battery cover.

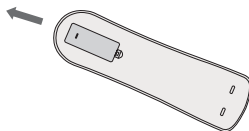

- 2 Insert two AAA batteries into the battery compartment. Make sure that you match the + and – symbols on the batteries with the + and – symbols in the battery compartment.

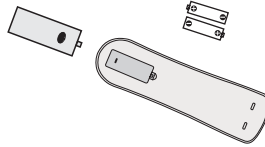

- 3 Replace the cover.

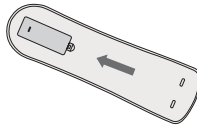

Notes:

- Do not mix batteries of different types.
- Do not mix old and new batteries.
- Remove batteries when the charge is depleted.
- Battery chemicals can cause a rash. If the batteries leak, clean the battery compartment with a cloth. If chemicals touch your skin, wash immediately.
- If the remote control is not going to be used for an extended period of time, remove the batteries.

Setting up your DVD player

Unpacking and setting up

Package contents:

- DVD player (1)
- Remote control (1)
- Batteries (What size batteries?) (2)
- Audio/Video cable (1)
- User Guide (1)
- Quick Start Guide (1)
- Digital Television Transition (1)

If you need to replace any of these items, call our help line mentioned in the Warranty section of this guide.

Carefully remove all of the components from the carton and make sure that you have all of the necessary components before you dispose of the carton.

- Remove all packing materials from the individual components.
- Do not remove any labels or stickers on the back panel of your player.
- Place your player in the location you want. Your player is designed to be used on a level, stable, flat surface, such as a table, desk, shelf, or stand convenient to a power outlet, out of direct sunlight, and away from sources of excess heat, dust, moisture, or vibration.
- Unwind the AC power cord and extend the cord to its full length, then plug it into the back of your player.

Making connections

Easy DVD hook-up guide: For the best possible picture, follow these guidelines and use the best cables your TV accepts:

- Normal—Composite video
- Better—Component video
- Best—HDMI video

HD DVD playback: Enjoy your entire DVD collection in brilliant high definition format. This DVD player upconverts DVDs to your HDTV's native resolution, whether it's 480i, 480p, 720p, 1080i, and 1080P.

HDMI output: Use this output for HD conversion and experience stunning HD images and crisp digital audio.

Composite connection

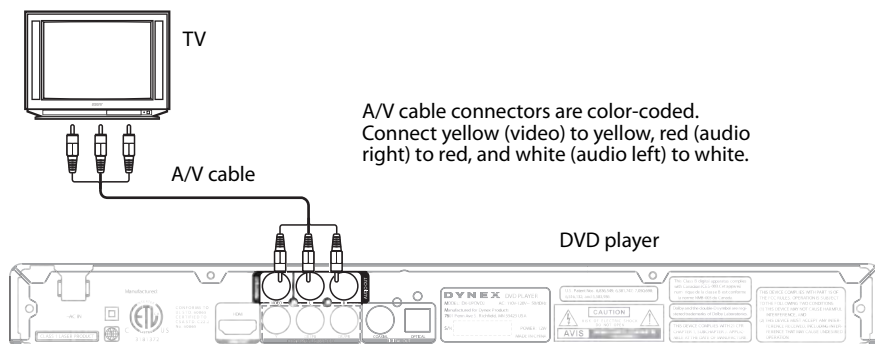

Component connection

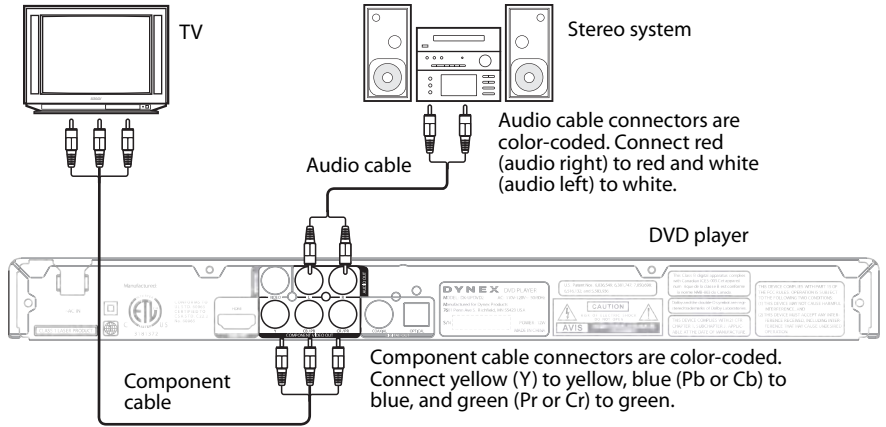

HDMI connection



Component connection with digital audio

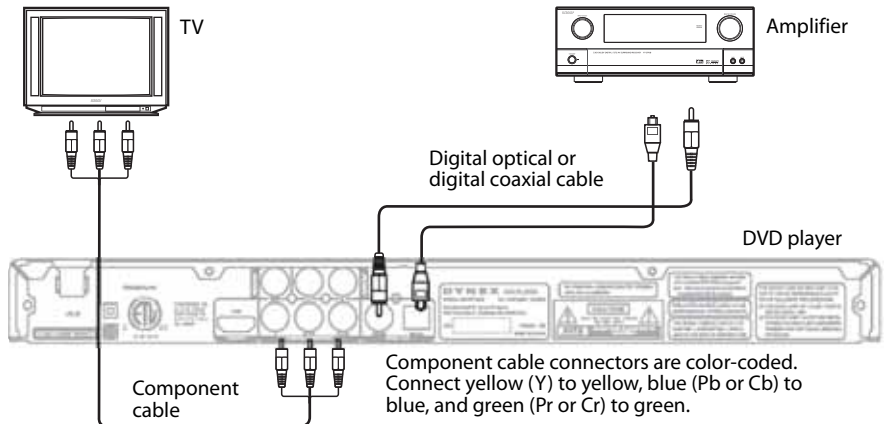

Using your DVD player

Power source

Use the polarized AC line cord provided for operation on AC power. Insert the AC cord plug into a standard 120 V 60 Hz polarized AC outlet.



If you cause a static discharge when touching your player and your player fails to function, unplug your player from the AC outlet and plug it back in. Your player should return to normal operation.

Warnings:

- *The player uses a polarized AC plug with one wide blade and one narrow blade. The plug will only fit into matching polarized power outlets. This is a safety feature to reduce the possibility of electric shock. If the plug will not fit in your power outlets, you probably have outdated, non-polarized outlets which should be changed by a qualified, licensed electrician. Do not file the wide blade on the plug or use an adapter to make the plug fit into your outlet.*
- *Never connect the AC cord plug to other than the specified voltage (120 V 60 Hz). Use the attached power cord only.*











Turning your player on and off

To turn your player on and off:

- 1 Plug the power cord into an AC power outlet.
- 2 Press the **STANDBY**/ button to turn on your player.
- 3 Press the **STANDBY**/ button again to turn off your player.

Playing a disc

To play a disc:

- 1 Turn on your player and your TV.
- 2 Press **OPEN/CLOSE** () to open the disc tray.
- 3 Load the disc into the tray, with the label side up.
- 4 Press **OPEN/CLOSE** () to close the tray. Playback starts automatically. If playback does not start, press  (play/pause) on the remote control or the player to start the playback.
 - To stop the playback, press  (stop). The player notes the stopped point, depending on the disc.
 - Press  (play/pause) to resume playback (from the stopped point). To start playback from the beginning of the disc, press  (stop) again, then press  (play/pause). Your player starts playback at the beginning of the disc.
 - During playback, press  (fast forward) to fast forward through the disc. Each time the  (fast forward) button is pressed, the fast forward motion speed changes. Press  (play/pause) to resume normal playback.

- During playback, press ◀◀ (fast reverse) to fast reverse through the disc. Each time the ◀◀ (fast reverse) button is pressed, the fast reverse motion speed changes. Press ▶▶ (play/pause) to resume normal playback.
 - During playback, press ◀◀◀ (previous) to return to the start of the previous chapter. Each time you press this key you can skip a chapter, back to the start of the disc.
 - During playback, press ▶▶▶ (next) to skip the current chapter and play the next chapter.
 - During playback, press ▶▶ (step) repeatedly to step forward frame by frame in the video. Press ▶▶▶ (play/pause) to resume normal playback.
- 5 Press **OPEN/CLOSE** (⏏) to open the tray, then remove the disc.
 - 6 Press **OPEN/CLOSE** (⏏) to close the disc tray, or press **STANDBY** (⏻). The disc tray closes automatically and the player turns off.

Note: The Ⓞ symbol may appear on your TV display during playback. This symbol indicates that the function you selected is not permitted by your player or specific media.

Playback options

Remote control functions

The following functions are applicable only to DVD discs. If other disc formats are played, screen display and operation will be different.

- **CLEAR**—This button can be used to clear any incorrect information that may have been input.
- **SEARCH**—Press this button one time and the screen will display search menu. Press it a second time to cancel the search function. In the search menu you can press ▲ (Up) or ▼ (Down) to highlight the item what you want, then press **OK** to confirm.
- **DVD MENU**—Press this button to display the root menu, then select an item according to your preference. (This key is only valid on DVDs with multi-layer menus.)
- **SETUP**—Press this button to display the on-screen setup menu.
- **AUDIO**—Press this button to change the audio mode (such as Audio 1/2-AC 3 2 CH English, or Audio 2/2- AC 3 5.1 CH English)

Note: When press this button repeatedly, you must wait approximately three seconds.

- **SUBTITLE**—Press this button and the screen displays "SUBTITLE 01/XX XXXXX." "01" indicates the ordinal number of this language, "XX" indicates total number of languages available, and "XXXXXX" is the language. (The number of languages available depends on the DVD).
- **ZOOM**—Press this button to zoom in on the picture. Each time you press the button, the magnification level will change.
- **TOP MENU**—Press this button to display the title menu (available on some DVDs).
- **REPEAT**—Press once to repeat a Chapter. Press twice to repeat a Title. Press three times to repeat All. Press four times to cancel repeat.
- **A-B REPEAT**—Press once to select a starting point to repeat, then press again to set the end point. The selected section will be repeated. Press a third time to cancel.

- **PROGRAM**—Press to display the program information window. Press the number buttons to input the program number what you want. When finished, move the cursor to select the **Start** logo. The program starts playback and the screen displays "Program." To cancel, press **■** (stop), then press **OK**.
- **ANGLE**—Press to view the action from different angles (not available on all DVDs).
- **RESOLUTION**—Press to set the video output resolution. Options include: 480i, 480p, 720p, 1080i, 1080p, and Auto.
Note: Setting a resolution your TV cannot support could result in an unstable picture or a loss of picture. Check your TV manual for more information.
- **DISPLAY**—Press to display information about the disc, such as title elapsed, title remain, chapter elapsed, chapter remain, and display off.

JPEG disc playback

When playing a JPEG disc, a navigation menu is displayed automatically.

In the menu, press **▲** (Up) or **▼** (Down) to select a file, then press **OK**. The file will be played in a slideshow.

- Press **◀◀** (previous) or **▶▶** (next) to select the previous or the next picture.
- Press **▶||** (play/pause) to pause the current picture, then press **OK** to return to normal playing.
- Press **ZOOM** to zoom in on a picture. When the picture is zoomed, press **◀◀** (fast reverse) or **▶▶** (fast forward) to select different enlargement ratio, or press the **▲** (Up), **▼** (Down), **◀** (Left), or **▶** (Right) buttons to move the enlarged picture.
- Press **PROGRAM** to select a slideshow transition. You can set transition effects for each picture.
- To rotate an image, press the **▲** (Up), **▼** (Down), **◀** (Left), or **▶** (Right) buttons to invert, mirror, rotate left, or rotate right. These operations are allowed only when a picture is being displayed normally and will be cancelled automatically when a new picture is displayed.

Using the menus

To use the **General Setup Page**:

- 1 Press **SETUP**. The *General Setup Page* opens.

| General | Audio | Video | Preference |
|--------------------------|-------|-------|------------|
| •• General Setup Page •• | | | |
| Angle Mark | On | | |
| OSD Language | ENG | | |
| Screen Saver | On | | |
| Playback Memory | On | | |
| Go to General Setup Page | | | |

- 2 Press the ▲ (Up), ▼ (Down), ◀ (Left), or ▶ (Right) buttons to move the cursor and highlight a selection, then press **OK** to confirm your selection. Options include:
 - **Angle Mark**—You can turn this option **On**, which lets you select a particular camera angle by pressing **ANGLE** when playing a DVD that offers multiple angles.
 - **OSD (on screen display) Language**—You can select the language for the setup menus and on-screen display.
 - **Screen Saver**—You can choose to have an animated picture on the screen whenever the DVD player is idle for a certain time.
 - **Playback Memory**—You can choose to view a disc from the point where it was stopped. Unlike the resume function, the playback memory function is effective even if the DVD is removed from the player.
- 3 Press ◀ (Left) to return to the previous menu.
- 4 Press **SETUP** to exit the on-screen menus.

To use the Audio Setup Page:

- 1 Press **SETUP**. The *General Setup Page* opens.

| General | Audio | Video | Preference |
|--------------------------|-------|-------|------------|
| •• General Setup Page •• | | | |
| Angle Mark | On | | |
| OSD Language | ENG | | |
| Screen Saver | On | | |
| Playback Memory | On | | |
| Go to General Setup Page | | | |

- 2 Press the ◀ (Left), or ▶ (Right) buttons to select **Audio**. The *Audio Setup Page* opens.

| General | Audio | Video | Preference |
|------------------------|-------|-------|------------|
| •• Audio Setup Page •• | | | |
| Digital Audio Output | Bit | | |
| HDMI Audio | Auto | | |
| Dynamic Range | | | |
| Go to Audio Setup Page | | | |

- 3 Press the ▲ (Up), ▼ (Down), ◀ (Left), or ▶ (Right) buttons to move the cursor and highlight a selection, then press **OK** to confirm your selection. Options include:
 - **Digital Audio Output**—Sets the audio outputs. This DVD player produces two kinds of audio output, Bitstream or PCM. This surround sound format is output to a Dolby Digital/DTS decoder through the coaxial and optical jacks on the back of the player.
 - **HDMI Audio**—You can set the HDMI audio source. When in PCM mode, all the audio signals through HDMI are output in PCM format. When in AUTO mode, if the

setting of Digital Audio Output is Bitstream and your TV supports Bitstream data, the output will be in Bitstream format. If not, the output will be in PCM format.

- **Dynamic Range**—This function is generally used when playing programs at night, in order to avoid disturbing others. This setting lets you dynamically lower the volume and still keep the original tone quality. This is the range, measured in decibels (dB), between the loudest and the quietest sound registers in a soundtrack.

4 Press ◀ (Left) to return to the previous menu.

5 Press **SETUP** to exit the on-screen menus.

To use the Video Setup Page:

1 Press **SETUP**. The *General Setup Page* opens.

| General | Audio | Video | Preference |
|--------------------------|-------|-------|------------|
| •• General Setup Page •• | | | |
| Angle Mark | On | | |
| OSD Language | ENG | | |
| Screen Saver | On | | |
| Playback Memory | On | | |
| Go to General Setup Page | | | |

2 Press the ◀ (Left), or ▶ (Right) buttons to select **Video**. The *Video Setup Page* opens.

| General | Audio | Video | Preference |
|------------------------|-------|-------|------------|
| •• Video Setup Page •• | | | |
| Resolution | 480p | | |
| TV Display | wide | | |
| Go to Video Setup Page | | | |

3 Press the ▲ (Up), ▼ (Down), ◀ (Left), or ▶ (Right) buttons to move the cursor and highlight a selection, then press **OK** to confirm your selection. Options include:

- **Resolution**—Lets you select the resolution output of the player to match your TV.
- **TV Display**—Sets the aspect ratio of the video output.

Notes:

- *No matter which display format is selected, a picture recorded in standard 4:3 format always displays in the 4:3 aspect ratio.*
- *The display format of DVD titles may vary. Refer to the information that accompanies your specific DVD title.*
- *If the DVD title is recorded in 16:9 wide display format while the TV is a standard 4:3 screen, horizontal compression of the image will result.*
- *Some DVD titles may be recorded in special formats. In such cases, the DVD titles will always appear on the screen in their original format, regardless of which TV display format you select.*

4 Press ◀ (Left) to return to the previous menu.

5 Press **SETUP** to exit the on-screen menus.

To use the Preferences Setup Page:

1 Press **SETUP**. The *General Setup Page* opens.

| General | Audio | Video | Preference |
|--------------------------|-------|-------|------------|
| •• General Setup Page •• | | | |
| Angle Mark | On | | |
| OSD Language | ENG | | |
| Screen Saver | On | | |
| Playback Memory | On | | |
| Go to General Setup Page | | | |

- 2 Press the ◀ (Left), or ▶ (Right) buttons to select **Preference**. The *Preferences Setup Page* opens.

| General | Audio | Video | Preference |
|-----------------------|-------|-------|------------|
| •• Preference Page •• | | | |
| Audio | ENG | | |
| Subtitle | Off | | |
| Disc Menu | ENG | | |
| Parental | | | |
| Password | | | |
| Default | | | |
| Go to Preference Page | | | |

- 3 Press the ▲ (Up), ▼ (Down), ◀ (Left), or ▶ (Right) buttons to move the cursor and highlight a selection, then press **OK** to confirm your selection. Options include:
- **Audio**—Lets you set the preferred audio language as the default when playing a DVD. (If the DVD supports the language)
 - **Subtitle**—Lets you set the preferred subtitle language as the default when playing a DVD. (If the DVD supports the language)
 - **Disc Menu**—Lets you set the preferred menu language as the default when playing DVD. (If the DVD supports the language).
 - **Parental**—The parental control function works in conjunction with the different censorship classes assigned to DVDs. These classes help to control the types of DVDs that the family watches, There are up to eight censorship classes for DVDs.
Note: If you change this set, you must input a password. (Initial password: 000000)
 - **Password Change**—Lets you change the Parental Control password. Type six numerals as the new password. Be sure remember the new password. When setting the parental control function you must input the new password.
Note: (Initial password: 000000)
 - **Default**—Resets to all the manufacturer's original settings for this DVD player
Press **OK** to perform the reset.
- 4 Press ◀ (Left) to return to the previous menu.
- 5 Press **SETUP** to exit the on-screen menus.

Troubleshooting

Check the following guide for the possible causes and solutions for a problem before contacting the nearest service center or dealer for repairs.

| Symptom | Solution |
|---|---|
| No power | Make sure that the DVD player is plugged in and that the AC power connection is secure. |
| No picture | <ul style="list-style-type: none"> • Make sure that the connection between the DVD player and the TV is secure. • Make sure that the TV is in good working condition. • Press the RESOLUTION button repeatedly until the picture returns to normal. |
| No sound | <ul style="list-style-type: none"> • Make sure that the connection between the player and other devices is secure. • Make sure that the TV and amplifier are in good working condition and setup correctly. |
| DVD will not play | <ul style="list-style-type: none"> • Make sure that the disc is correctly inserted. • Clean the disc. |
| The remote control does not work | <ul style="list-style-type: none"> • Remove obstacles between the remote control and the player. • Aim the remote control at the sensor on the front panel of the player. • Check the batteries and replace them if necessary. |
| Picture is distorted | <ul style="list-style-type: none"> • Check the disc for dirt and scratches. Clean or replace the disc. • Unplug the player, wait ten seconds, then plug it back in and turn it on. |
| The control buttons on the player do not work | <ul style="list-style-type: none"> • Power surges or other electrical phenomena may have disabled the buttons. • Unplug the player, wait ten seconds, then plug it back in and turn it on. |

Maintaining

Care and handling of discs

Handling discs

Do not touch the playback side of the disc. Hold the disc by the edges so that fingerprints do not get on the surface. Never stick paper or tape on the disc.

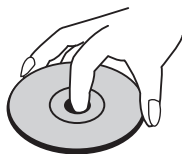

Storing discs

After playing, store the disc in its case. Do not expose the disc to direct sunlight or sources of heat and never leave it in a parked car exposed to direct sunlight.

Cleaning discs

Fingerprints and dust on the disc can cause poor picture quality and sound distortion. Before playing, clean the disc with a clean cloth. Wipe the disc from the center out.



Do not use strong solvents such as alcohol, benzene, thinner, commercially available cleaners, or anti-static spray intended for older vinyl records.

Note: Never operate this player immediately after moving it from a cold location to a warm location. Leave it for two or three hours without operating it. If you use this product in such a situation, it may damage discs or internal parts.

Resetting your player

Reset your player if you observe any of the following symptoms:

- When your player is plugged in, but the power will not turn on or off.
- When the display window is not working.
- When your player does not operate normally.

To reset your player:

- Unplug the power cord for 30 minutes, then plug in the power cord again. This should reset your player.

Specifications

System and outputs

| | | |
|------------------------------|--|---------------------|
| VF Signal system | NTSC | |
| Frequency response | CD: 20 Hz~20 KHz (EIAJ) DVD: 20 Hz~44 KHz (96 KHz)(Sample result) 20 Hz~22 KHz (48 KHz)(Sample result) | |
| Audio S/N ratio | > 90 dB | |
| Audio | MPEG LAYER2 standard | |
| Audio output (analog audio) | Electric level output: 1.8 ± 0.2 V | Resistance: 10 Kohm |
| Audio output (digital audio) | Electric level output: 0.5 V p-p | Resistance: 75 ohm |

| | |
|-----------------------------|---|
| Video output | Electric level output: (1.0 ± 0.2) V p-p Resistance: 75 ohm Unbalanced negative |
| Component video (Y, Cb, Cr) | Electric level output: 0.7 V p-p Resistance: 75 ohm |

General

| | |
|-----------------------|--|
| Power | 110~120 V 50/60 Hz |
| Power consumption | 12 W |
| Dimensions (LxWxH) | 14.17 x 8.46 x 1.61 inches (360 x 215 x 41 mm) |
| Weight | 3.53 lbs. (1.6 kg) |
| Operating temperature | 41°F to 95°F (5°C to 35°C) |
| Operating humidity | 5% to 90% |

Legal notices

FCC Part 15

This device complies with Part 15 of the FCC Rules. Operation of this product is subject to the following two conditions: (1) this device may not cause harmful interference, and (2) this device must accept any interference received, including interference that may cause undesired operation.

This equipment has been tested and found to comply within the limits for a class B digital device, pursuant to Part 15 of the FCC Rules. These limits are designed to provide reasonable protection against harmful interference in a residential installation. This equipment generates, uses, and can radiate radio frequency energy and, if not installed and used in accordance with the instructions, may cause harmful interference to radio communications. However, there is no guarantee that interference will not occur in a particular installation. If this equipment does cause harmful interference to radio or television reception, which can be determined by turning the equipment off and on, the user is encouraged to try to correct the interference by one or more of the following measures:

- Reorient or relocate the receiving antenna.
- Increase the separation between the equipment and receiver.
- Connect the equipment into an outlet on a circuit different from that to which the receiver is connected.
- Consult the dealer or an experienced radio/TV technician for help.

FCC warning

Changes or modifications not expressly approved by the party responsible for compliance with the FCC Rules could void the user's authority to operate this equipment.

Notices

Specifications and features are subject to change without notice or obligation.

For service and support call (800) 305-2204.

90-day limited warranty

Dynex Products ("Dynex") warrants to you, the original purchaser of this new **DX-UPDVD2** ("Product"), that the Product shall be free of defects in the original manufacture of the material or workmanship for a period of 90 days from the date of your purchase of the Product ("Warranty Period"). This Product must be purchased from an authorized dealer of Dynex brand products and packaged with this warranty statement. This warranty does not cover refurbished Product. If you notify Dynex during the Warranty Period of a defect covered by this warranty that requires service, terms of this warranty apply.

How long does the coverage last?

The Warranty Period lasts for 90 days from the date you purchased the Product. The purchase date is printed on the receipt you received with the product.

What does this warranty cover?

During the Warranty Period, if the original manufacture of the material or workmanship of the Product is determined to be defective by an authorized Dynex repair center or store personnel, Dynex will (at its sole option): (1) repair the Product with new or rebuilt parts; or (2) replace the Product at no charge with new or rebuilt comparable products or parts. Products and parts replaced under this warranty become the property of Dynex and are not returned to you. If service of Products and parts are required after the Warranty Period expires, you must pay all labor and parts charges. This warranty lasts as long as you own your Dynex Product during the Warranty Period. Warranty coverage terminates if you sell or otherwise transfer the Product.

How to obtain warranty service?

If you purchased the Product at a retail store location, take your original receipt and the Product to the store you purchased it from. Make sure that you place the Product in its original packaging or packaging that provides the same amount of protection as the original packaging. If you purchased the Product from an online web site, mail your original receipt and the Product to the address listed on the web site. Make sure that you put the Product in its original packaging or packaging that provides the same amount of protection as the original packaging.

To obtain in-home warranty service for a television with a screen 25 inches or larger, call 1-888-BESTBUY. Call agents will diagnose and correct the issue over the phone or will have an Dynex-approved repair person dispatched to your home.

Where is the warranty valid?

This warranty is valid only to the original purchaser of the Product in the United States, Canada, and Mexico.

What does the warranty not cover?

This warranty does not cover:

- Customer instruction
- Installation
- Set up adjustments
- Cosmetic damage
- Damage due to acts of God, such as lightning strikes
- Accident
- Misuse
- Abuse
- Negligence
- Commercial use
- Modification of any part of the Product
- Plasma display panel damaged by static (non-moving) images applied for lengthy periods (burn-in).

This warranty also does not cover:

- Damage due to incorrect operation or maintenance
- Connection to an incorrect voltage supply
- Attempted repair by anyone other than a facility authorized by Dynex to service the Product
- Products sold as is or with all faults
- Consumables, such as fuses or batteries
- Products where the factory applied serial number has been altered or removed

REPAIR REPLACEMENT AS PROVIDED UNDER THIS WARRANTY IS YOUR EXCLUSIVE REMEDY. DYNEX SHALL NOT BE LIABLE FOR ANY INCIDENTAL OR CONSEQUENTIAL DAMAGES FOR THE BREACH OF ANY EXPRESS OR IMPLIED WARRANTY ON THIS PRODUCT, INCLUDING, BUT NOT LIMITED TO, LOST DATA, LOSS OF USE OF YOUR PRODUCT, LOST BUSINESS OR LOST PROFITS. DYNEX PRODUCTS MAKES NO OTHER EXPRESS WARRANTIES WITH RESPECT TO THE PRODUCT, ALL EXPRESS AND IMPLIED WARRANTIES FOR THE PRODUCT, INCLUDING, BUT NOT LIMITED TO, ANY IMPLIED WARRANTIES OF AND CONDITIONS OF MERCHANTABILITY AND FITNESS FOR A PARTICULAR PURPOSE, ARE LIMITED IN DURATION TO THE WARRANTY PERIOD SET FORTH ABOVE AND NO WARRANTIES, WHETHER EXPRESS OR IMPLIED, WILL APPLY AFTER THE WARRANTY PERIOD. SOME STATES, PROVINCES AND JURISDICTIONS DO NOT ALLOW LIMITATIONS ON HOW LONG AN IMPLIED WARRANTY LASTS, SO THE ABOVE LIMITATION MAY NOT APPLY TO YOU. THIS WARRANTY GIVES YOU SPECIFIC LEGAL RIGHTS, AND YOU MAY ALSO HAVE OTHER RIGHTS, WHICH VARY FROM STATE TO STATE OR PROVINCE TO PROVINCE.

Contact Dynex:

For customer service please call 1-800-305-2204

www.dynexproducts.com

Distributed by Best Buy Purchasing, LLC

7601 Penn Avenue South, Richfield, Minnesota, U.S.A. 55423-3645

© 2009 Best Buy Enterprise Services, Inc.

All rights reserved. DYNEX is a trademark of Best Buy Enterprise Services, Inc. Registered in some countries. All other products and brand names are trademarks of their respective owners.

DYNEX™

www.dynexproducts.com (800) 305-2204

© 2009 Best Buy Enterprise Services, Inc. All rights reserved.

DYNEX is a trademark of Best Buy Enterprise Services, Inc. Registered in some countries.

All other products and brand names are trademarks of their respective owners.

Distributed by Best Buy Purchasing, LLC

7601 Penn Ave. South, Richfield, MN 55423 U.S.A.

ENGLISH
09-0463

Free Manuals Download Website

<http://myh66.com>

<http://usermanuals.us>

<http://www.somanuals.com>

<http://www.4manuals.cc>

<http://www.manual-lib.com>

<http://www.404manual.com>

<http://www.luxmanual.com>

<http://aubethermostatmanual.com>

Golf course search by state

<http://golfingnear.com>

Email search by domain

<http://emailbydomain.com>

Auto manuals search

<http://auto.somanuals.com>

TV manuals search

<http://tv.somanuals.com>