

DYNE X TM ●●●

42" Plasma TV

DX-PDP42-09

USER GUIDE

Dynex DX-PDP42-09

42" PDP TV

Contents

Introduction	2
Safety information	4
Features	5
Accessories	5
Front and right side	5
Back	6
Left side	6
Remote control	7
Installing remote control batteries	7
Using the remote control	7
Setting up your TV	8
Connecting an antenna or cable TV	8
Connecting external equipment	9
Using your TV	13
Turning the TV on and off	13
Changing channels	13
Adjusting the volume	13
Selecting the video source	13
Memorizing receivable channels	14
Selecting the aspect ratio	14
Using the on-screen menus	15
Changing the SETUP menu settings	15
Changing video settings	21
Changing audio settings	21
Changing TV settings	22
Maintaining your TV	22
Cleaning the screen	22
Cleaning the cabinet	22
Troubleshooting	22
Operation	22
Video problems	22
Audio problems	23
PC mode problems	23
Specifications	23
Legal notices	23
One-year limited warranty	25

Introduction

Congratulations on your purchase of a high-quality Insignia product. Your DX-PDP42-09 represents the state of the art in television design, and is designed for reliable and trouble-free performance.

CHILD SAFETY

It makes a difference how and where you use your flat panel display

As you enjoy your new product, keep these safety tips in mind

The issue

The home theater entertainment experience is a growing trend, and larger TVs are popular purchases. However, TVs are not always supported on the proper stands or installed according to the manufacturer's recommendations. We and the consumer electronics industry are committed to making home entertainment enjoyable and safe.

TVs that are inappropriately placed on dressers, bookcases, shelves, desks, speakers, chests, or carts may fall over and cause injury.

Tune into safety

- One size of TV stand does **not** fit all. Use only a TV stand rated for the weight of your TV.
- Carefully read and understand all enclosed instructions for proper use of this product.
- Don't let children climb on or play with entertainment system furniture and TVs.
- Don't place TVs on furniture that can easily be used as steps, such as a chest of drawers.
- Remember that children can become excited while watching a program, especially on a "larger-than-life" TV. Make sure that you place or install the TV where it cannot be pushed, pulled over, or knocked down.
- Make sure that you route all cords and cables so that they cannot be pulled or grabbed by curious children.



Wall mounting

If you decide to wall mount your TV:

- One size of wall mount does **not** fit all. Use only a wall mount rated for the weight of your TV and that has been recommended by this TV manufacturer, listed in this manual, or otherwise listed by an independent laboratory (such as UL, CSA, or ETL) as suitable for your TV.
- Always follow all instructions supplied by the TV and wall mount manufacturers.
- If you have any doubts about your ability to safely wall mount your TV, get help from a professional installer.
- Make sure that the wall where you are mounting the TV is appropriate. Some wall mounts are not designed to be mounted to walls backed with steel studs or cinder blocks. If you are unsure, ask a professional installer.
- TVs can be heavy. At least two people are required for safe wall mount installation.



Safety information



Warning

To reduce the risk of electric shock, do not remove the cover or back. There are no user-serviceable parts inside. Refer servicing to qualified service personnel.

To reduce the risk of fire or electric shock, do not expose your TV to rain or moisture.

Caution

To prevent electric shock, match the wide blade on the power cord plug to the wide slot on an electric outlet. If the plug does not fit, consult a licensed electrician to replace the obsolete outlet. Do not modify the power cord plug, or you will defeat this safety feature.



This symbol indicates that dangerous voltage constituting a risk of electric shock is present within your TV. This label is located on the back of your TV.



This symbol indicates that there are important operating and maintenance instructions in the literature accompanying your TV.

Warnings

Use of controls or adjustments or performance of procedures other than those specified herein may result in hazardous radiation exposure.

The TV should be connected to an AC power outlet with a protective grounding connection.

To prevent injury, this apparatus must be securely attached to the floor/wall in accordance with the installation instructions.

Always place the TV on the floor or a sturdy, level, stable surface that will support the weight of the unit.

Installing the TV requires special skill that should only be performed by qualified service personnel.

Customers should not attempt to do the work themselves. Insignia bears no responsibility for improper mounting or mounting that results in accident or injury.

Caution

The AC power plug is used as the disconnect device, so the AC power plug shall always remain readily operable.

Read instructions

Read all of the safety and operating instructions before you use your TV.

Retain instructions

Retain safety and operating instructions for future reference.

Follow warnings and instructions

Follow all warnings on your TV and in the operating instructions. Follow all operating and use instructions.

Water and moisture

Do not use your TV near water. For example, do not use it near a bath tub, wash bowl, kitchen sink, laundry tub, in a wet basement, or near a swimming pool.

Cleaning

Unplug your TV before cleaning. Do not use liquid or aerosol cleaners. Use only a damp cloth to clean the exterior of your TV.

Ventilation

Slots and openings in the cabinet and the back or bottom are provided for ventilation, reliable operation, and protection from overheating. These openings must not be blocked or covered. Do not block the

openings by placing your TV on a bed, sofa, rug, or other similar surface. Do not place your TV near or over a radiator or heat register. Do not place your TV in a built-in installation, such as a bookcase or rack, unless you provide correct ventilation or follow the manufacturer's instructions.

Heat

Make sure that your TV is located away from heat sources such as radiators, heat registers, stoves, or other products (including amplifiers) that produce heat.

Grounding or polarization

Do not defeat the safety purpose of the polarized or grounding-type plug. A polarized plug has two blades with one wider than the other. A grounding type plug has two blades and a grounding prong. The wide blade or grounding prong are provided for your safety. If the plug does not fit, contact an electrician to replace the obsolete outlet.

Power cord protection

Route power cords so that they are not likely to be walked on or pinched by items placed on or against them. Pay particular attention to cords at plugs, convenience receptacles, and the point where they exit from your TV.

Attachments

Use only attachments recommended by Insignia.

Stand

Do not place your TV on an unstable cart, stand, tripod, bracket, or table. Your TV may fall, causing serious personal injury and serious damage to your TV. Use only with a cart, stand, tripod, bracket, or table recommended by the manufacturer, or sold with your TV. If you mount your TV to the wall, follow the manufacturer's instructions and use a mounting accessory recommended by the manufacturer. Your TV and cart combination should be moved with care. Quick stops, excessive force, and uneven surfaces may cause your TV and cart combination to overturn.



Lightning

For added protection for your TV's receiver during a lightning storm, or when it is left unattended and unused for long periods of time, unplug it from the power outlet and disconnect the antenna or cable system. This helps prevent damage to your TV from lightning and power line surges.

Servicing

Do not attempt to service your TV yourself because opening or removing covers may expose you to dangerous voltage or other hazards. Refer all servicing to qualified service personnel.

Replacement parts

When replacement parts are required, make sure that the service technician uses replacement parts specified by the manufacturer that have the same characteristics as the original part. Unauthorized substitutions may result in fire, electric shock, personal injury, or other hazards.

Overloading

Do not overload power outlets and extension cords because this can result in a risk of fire or electric shock.

Object and liquid entry

Never push objects of any kind into your TV through openings because objects may touch dangerous voltage points or short out parts that could result in a fire or electric shock. Never spill liquid of any kind on your TV.

Damage requiring service

Unplug this TV from the power outlet and refer servicing to qualified service personnel under the following conditions:

- When the power supply cord or plug is damaged or frayed.

- If liquid has been spilled or objects have fallen into your TV.
- If your TV has been exposed to rain or water.
- If your TV does not operate normally by following the operating instructions. Adjust only those controls that are covered by the operating instructions because incorrect adjustment of other controls may result in damage and will often require extensive work by a qualified technician to restore your TV to its normal operation.
- If your TV has been dropped or damaged in any way.
- When your TV exhibits a distinct change in performance.

Safety check

After completing any service or repair to this TV, ask the service technician to perform routine safety checks to determine that your TV is in correct operating condition.

Power source

Operate your TV only from the type of power source indicated on the marking label. If you are not sure of the type of power supplied to your home, consult your TV dealer or local power company.

Screen protection

Your TV's screen is made of glass. Do not drop your TV or hit the glass screen. If the screen breaks, be careful of broken glass.

Outdoor antenna grounding

If an outside antenna or cable system is connected to your TV, make sure that the antenna or cable system is grounded to provide some protection against voltage surges and built-up static charges. Article 810 of the National Electrical Code, ANSI/NFPA No. 70, provides information with respect to correct grounding of the mast and supporting structure, grounding of the lead-in wire to an antenna discharge unit, size of grounding conductors, location of the antenna-discharge unit, connection to grounding electrodes, and requirements for the grounding electrode.

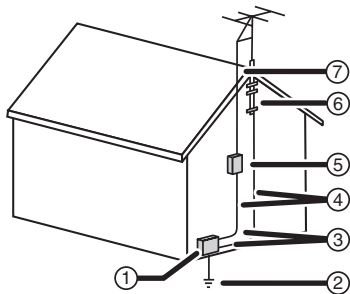

1	Electric service equipment
2	Power service grounding electrode system
3	Ground clamps
4	Grounding conductors
5	Antenna discharge unit
6	Grounding clamp
7	Antenna lead-in wire

Note to CATV system installer

This reminder is provided to call the CATV system installer's attention to Article 820-40 of the NEC that provides guidelines for correct grounding and in particular, specifies that the cable ground must be connected to the grounding system of the building as close to the point of cable entry as practical.

End of life directives

Your new TV contains materials which can be recycled and reused. At the end of your TV's life, specialized companies can dismantle the discarded TV to concentrate the reusable materials and to minimize the amount of materials to be disposed of. Dispose of your old TV according to local regulations.

Features

Accessories

Make sure that the following accessories are provided in the package:

- Remote control and batteries (2 × AAA)
- Composite video cable
- Audio cable
- Power cord
- User Guide
- Quick Start Guide

Front and right side

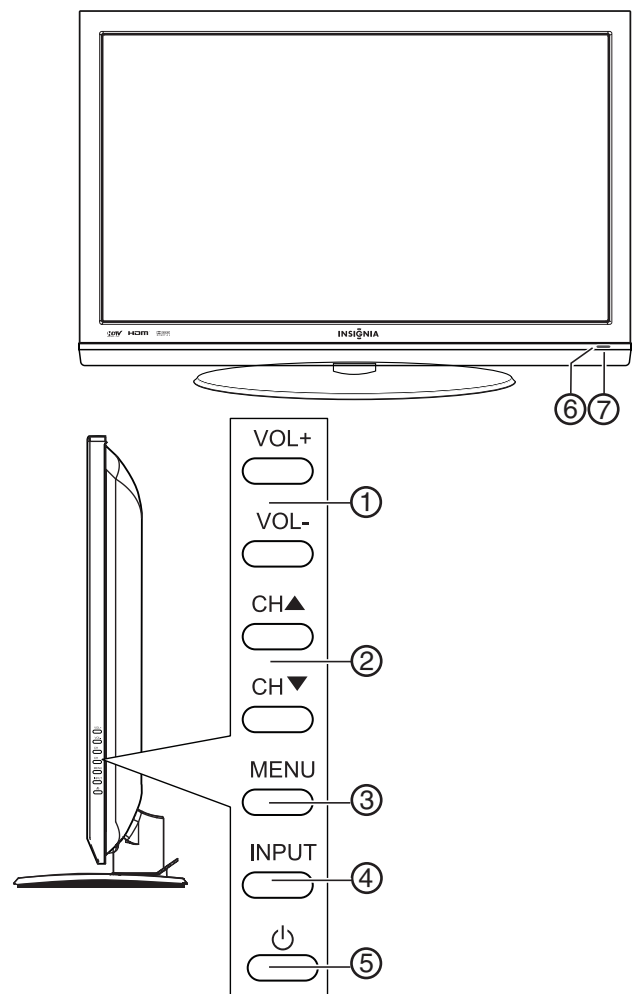

#	Item	Description
1	VOL +/VOL -	Press to increase or decrease the volume.
2	CH ▲ /CH ▼	Press to change to a higher or lower channel.
3	MENU button	Press to open the on-screen menu.

#	Item	Description
4	INPUT button	Press to select the AV signal input. You can select: <ul style="list-style-type: none"> • TV (CABLE/AIR) • VIDEO1 (REAR) • S-VIDEO1 (REAR) • VIDEO2 (SIDE) • YPbPr1 • YPbPr2 • HDMI1 (REAR) • HDMI2 (REAR) • PC (VGA).
5	⏻ (power) button	Press to turn your TV on or off.
6	Power/Standby indicator	Lights when your TV is plugged into a power outlet. When your TV is on, the indicator is blue. When your TV is in standby mode, the indicator is red.
7	IR sensor	Receives signals from the remote control. Do not block.

Back

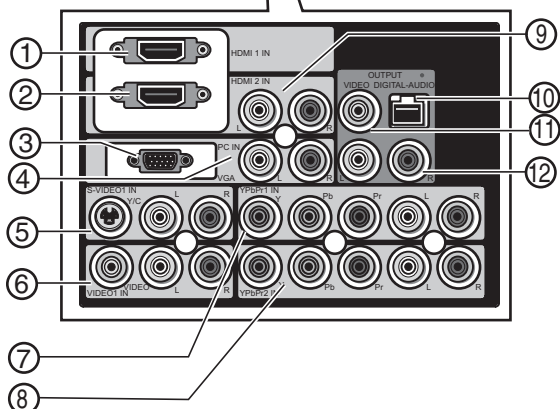
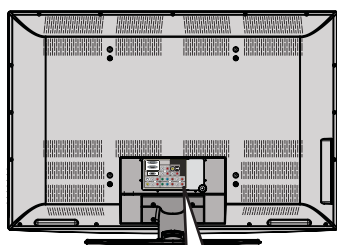

#	Description	Function
1	HDMI 1 IN	Connect an HDMI cable to this connector. Supports HD video and digital audio. Does not support 480i. Accepts DVI video using an adapter or HDMI-to-DVI cable (not included).
2	HDMI 2 IN	Connect an HDMI cable to this connector. Supports HD video and digital audio. Does not support 480i. Accepts DVI video using an adapter or HDMI-to-DVI cable (not included).
3	PC IN VGA	Connect a VGA (D-sub) cable from your PC to this connector (analog PC).
4	PC IN AUDIO L/R	Connect left (white) and right (red) audio cables to the L and R jacks.
5	S-VIDEO1 IN (S-Video and L/R audio)	Connect an S-Video cable and connect left (white) and right (red) audio cables to the L and R jacks.

#	Description	Function
6	VIDEO1 IN (composite video and L/R audio)	Connect a video cable (analog composite video - 480i) to this jack (yellow). Connect left (white) and right (red) audio cables to the L and R jacks.
7	YPbPr1 IN , AUDIO L, and AUDIO R	Connect component video cables to the Y, Pb, and Pr jacks and audio left (white) and right (red) cables to the L and R jacks.
8	YPbPr2 IN , AUDIO L, and AUDIO R	Connect component video cables to the Y, Pb, and Pr jacks and audio left (white) and right (red) cables to the L and R jacks.
9	HDMI audio in	Connect left (white) and right (red) audio cables to the L and R jacks.
10	Optical digital audio output	Connect an optical cable from this jack to the optical audio input jack of a digital 5.1 audio system.
11	Composite video output	Connect a video cable (yellow) to this jack and to a VCR to record the TV program.
12	Audio output	Connect left (white) and right (red) audio cables from these L and R jacks to the audio input jacks of a stereo amplifier or receiver.

Left side

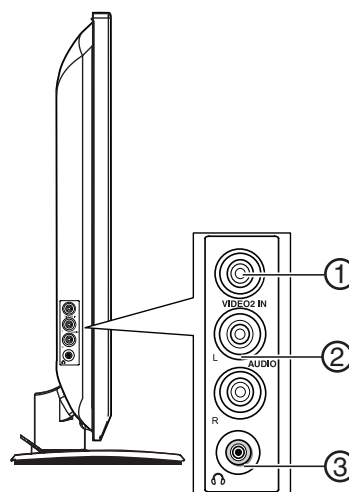

#	Description	Function
1	VIDEO2 IN (composite video)	Connect analog composite video (480i) to this jacks.
2	AUDIO IN (Audio L/R)	Connect the audio for composite video or S-Video to these jacks.
3	⌂ (Headphone jack)	Connect to an external headphone for private listening.

Remote control

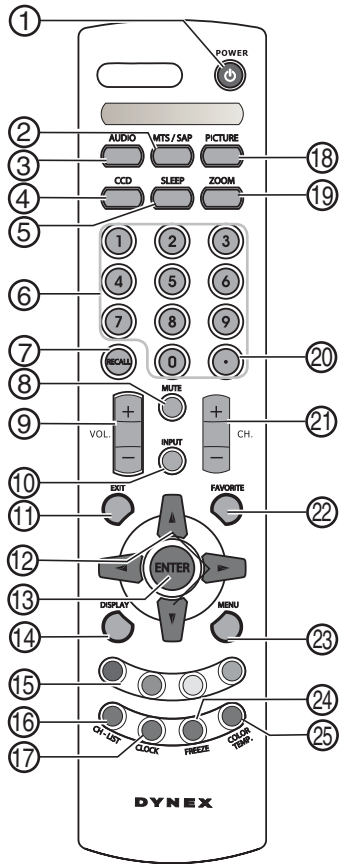

#	Button	Description
13	ENTER	Press ENTER to confirm your settings.
14	DISPLAY	Press to display a variety of current channel and input source information.
15	Red, green, yellow, and blue buttons	In TV mode, press to directly access four presets from your Favorite List.
16	CH-LIST	Press to display the channel list.
17	CLOCK	Press to display the current time on the screen.
18	PICTURE	Press to cycle through the available preset picture modes. Choices include Vivid, Normal, Cinema, Sport, and User.
19	ZOOM	Press to cycle through the available aspect ratios of the picture. Choices include NORMAL, FULL, WIDE, and CINEMA.
20	●	In HDTV mode, press with 0~9 buttons to select a digital sub-channel.
21	CH +/-	Press to change the channel.
22	FAVORITE	Press to display your favorite channels list.
23	MENU	Press to open the on-screen TV menus.
24	FREEZE	Press to freeze the current picture. Press again to resume normal viewing.
25	COLOR TEMP.	Press to cycle through the available color temperature presets. Choices include Cool, Warm, and Normal.

#	Button	Description
1	POWER	Press to turn your TV on or off.
2	MTS/SAP	Press repeatedly to cycle through the available MTS/SAP sound options, including SAP, MONO, and STEREO.
3	AUDIO	Press to cycle through the available preset audio modes, including Surround, Live, Dance, Techno, Classic, Soft, Rock, Pop, and Off.
4	CCD	Press to cycle through the available closed caption options, including: • Analog— CC1, CC2, CC3, CC4, TT1, TT2, TT3, TT4, or Off. • Digital— Service1, Service2, Service3, Service4, Service5, Service6, and Off.
5	SLEEP	Press to cycle through the available preset times before your TV turns off. Options include 0, 5, 10, 15, 30, 45, 60, 90, 120, 180, and 240 minutes.
6	Number buttons	Press to enter channel numbers directly.
7	RECALL	Press to return to the previous channel.
8	MUTE	Press to mute the sound. Press again to restore the sound.
9	VOL +/-	Press to adjust the volume.
10	INPUT	Press to open the <i>Input Source</i> menu showing the available input sources for your TV. Press ▲ or ▼ to select the source you want, then press ENTER to confirm.
11	EXIT	Press to exit the on-screen menus.
12	Navigation arrows	Press to navigate the on-screen menus.

Installing remote control batteries

To install the remote control batteries:

- 1 Remove the battery cover on the back side of the remote control.
- 2 Insert two 1.5 V AAA batteries into the battery compartment. Make sure that you match the + and – symbols on the batteries with the + and – symbols in the battery compartment.
- 3 Replace the cover.

Notes

*Do not mix batteries of different types.
 Do not mix old and new batteries.
 Remove batteries when the charge is depleted.
 Battery chemicals can cause a rash. If the batteries leak, clean the battery compartment with a cloth. If chemicals touch your skin, wash immediately.
 If the remote control is not going to be used for an extended period of time, remove the batteries.*

Using the remote control

To use the remote control:

- Point the remote control directly at your TV, within a 60° angle horizontally (30° to either side) and within 30° vertically of the remote control sensor on the front of your TV, and within 16.4 feet (5 m) of your TV.

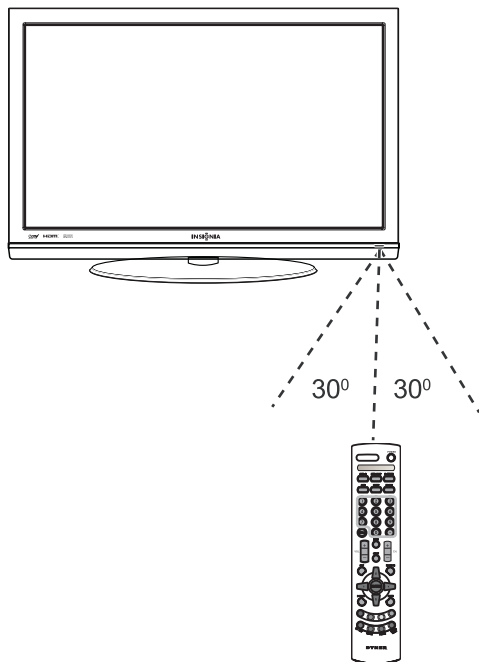
**Caution**

Do not expose the remote control to liquids, direct sunlight, or shock. Do not mix batteries of different types.

Notes

Objects between the remote control and the remote control sensor may block the remote control signal.

The range of the remote control may be diminished if direct sunlight or other strong light is shining on the remote control sensor. In this case, change the angle of the lighting, move your TV, or operate the remote control closer to the remote control sensor.

Setting up your TV

Connecting an antenna or cable TV

The antenna requirements for good color TV reception are more important than those for black and white reception. For this reason, a good quality outdoor antenna or cable TV is strongly recommended. The following is a brief explanation of the type of connection that is provided with the various antenna systems.

Connecting an outside antenna

Antenna cables come in two types: 75 ohm and 300 ohm.

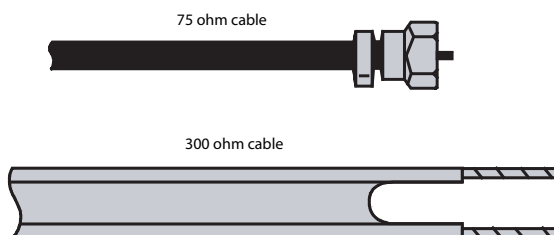

- If your antenna cable has a 75 ohm connector, connect the cable to the coaxial **AIR/CABLE IN** jack on the back of your TV.
- If your antenna cable has a 300 ohm connector, connect the cable to a 300-75 ohm adapter (not included), connect the adapter to a 75 ohm cable, then connect the other end of the 75 ohm connector to the coaxial jack on the back of your TV.

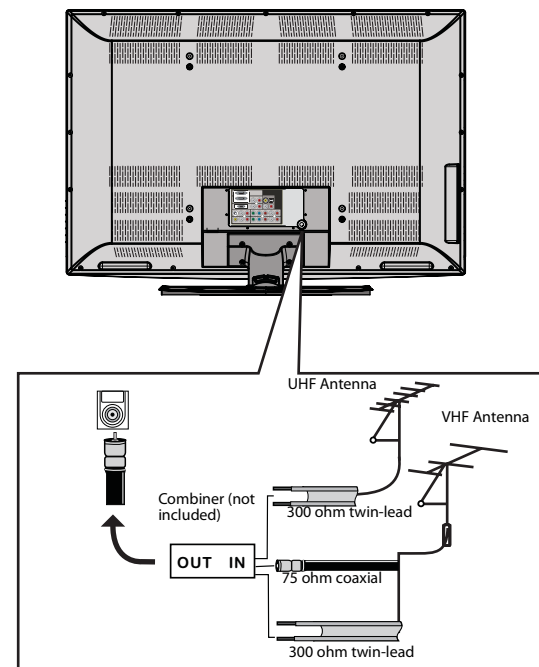
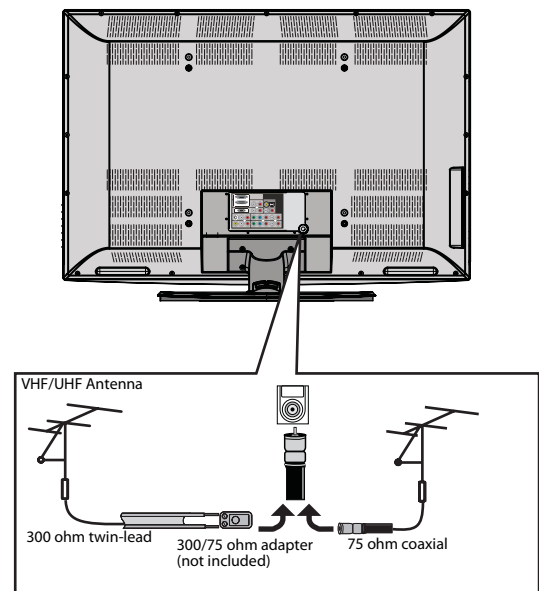

Connecting cable TV

Your TV has a 75 ohm **AIR/CABLE IN** jack for connecting cable TV. Some cable TV providers scramble the signals for "premium" (pay) channels. To view these channels, you need a converter/descrambler box.

If you do not have a converter/descrambler box, you can connect your cable TV directly to your TV. If you have a converter/descrambler box, you can connect your cable TV using an RF switch (not supplied). For more information about connecting a converter/descrambler box, contact your cable TV provider.

To connect cable TV without a converter/descrambler box:

- 1 Connect one end of a 75 ohm cable to the **AIR/CABLE IN** jack on the back of your TV.
- 2 Connect the other end of the cable to the cable TV wall outlet.

To connect cable TV with a converter/descrambler box:

- Use the following illustration to connect a converter/descrambler box. (The RF switch and the signal splitter are not provided.)

Set the RF switch to the A position to watch unscrambled channels controlled by your TV remote control. Set the RF switch to the B position to watch scrambled channels controlled by the converter/descrambler controls.

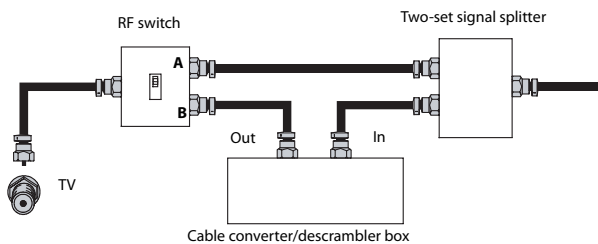

To connect digital cable TV

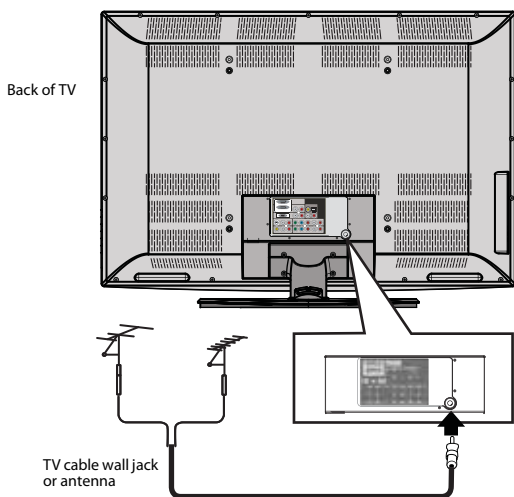

To connect your antenna or digital cable TV through your VCR

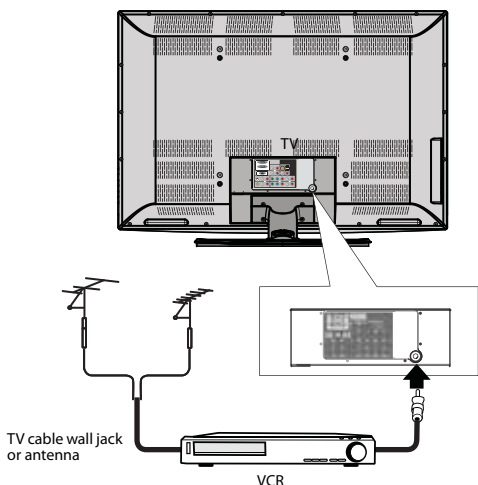

Connecting external equipment

Connecting a VCR

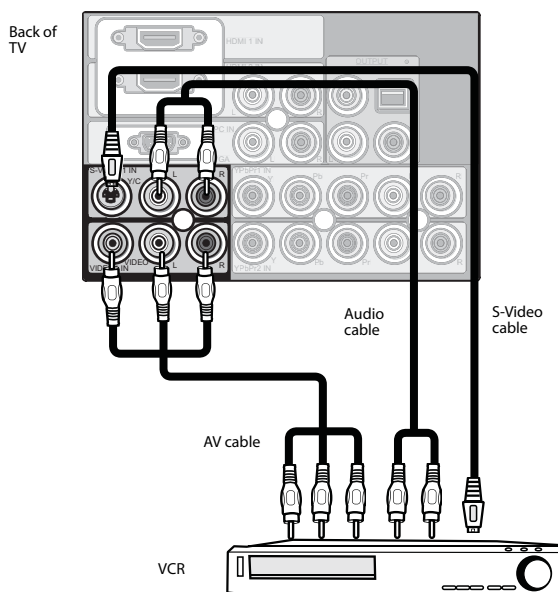

To connect a VCR:

- 1 Plug an RCA composite video cable (yellow) into the video out jack of the VCR, then into the **VIDEO1 IN** (yellow) jack on the back of your TV.
- OR -
Plug an S-Video cable into the S-Video out jack of the VCR, then into the **S-VIDEO1 IN** jack on the back of your TV.
- 2 Plug RCA audio cables into the VCR's audio output jacks, then into the **VIDEO1 IN** (for video cable), or **S-VIDEO1 IN** (for S-Video cable) **AUDIO L** (white) and **AUDIO R** (red) jacks on the back of your TV.
- 3 Press **POWER** to turn on your TV.
- 4 Press **INPUT**, press **▲** or **▼** to select **VIDEO1** or **S-VIDEO1**, then press **ENTER** to confirm.

Connecting a VCR for recording

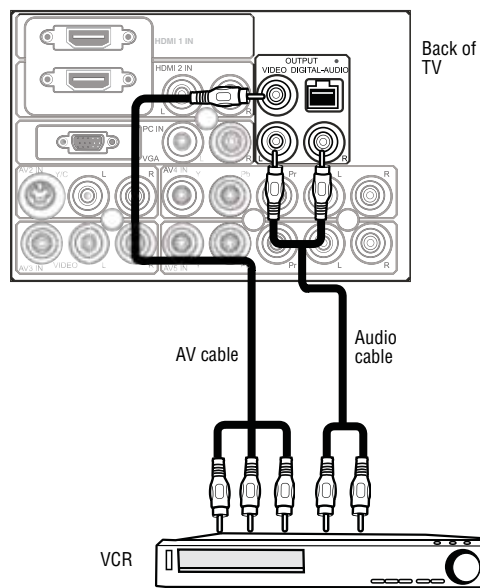

To connect a VCR for recording:



- 1 Plug an RCA composite video cable (yellow) into the **VIDEO OUTPUT** jack on the back of the TV, then into the VCR's composite video input jack.

- Plug RCA audio cables into the **AUDIO L** (white) and **AUDIO R** (red) output jacks on the back of your TV, then into the VCR's audio (L and R) input jacks.
- Press  to turn on your TV.

Note

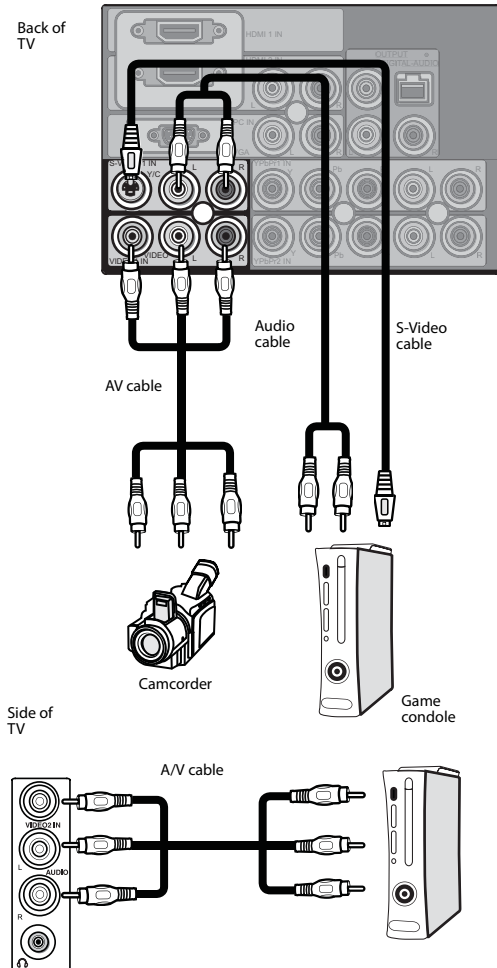
Only analog TV programs (480i) can be output through the TV's **VIDEO OUTPUT** jack.

Connecting a video camera or game console**To connect video camera or game console:**



- Plug an RCA composite video cable (yellow) into the video out jack of the video camera or game console, then into the **VIDEO1 IN** (yellow) jack on the back of your TV or the **VIDEO2 IN** jack on the side of your TV.
- OR -
Plug an S-Video cable into the S-Video out jack of the video camera or game console, then into the **S-VIDEO1 IN** jack on the back of your TV.
- Plug RCA audio cables into the video camera or game console's audio output jacks, then into the **VIDEO1 IN** (for video cable on the back), **VIDEO2 IN** (for video cable on the side), or **S-VIDEO1 IN** (for S-Video cable) **AUDIO L** (white) and **AUDIO R** (red) jacks on the back of your TV.
- Press  to turn on your TV.
- Press **INPUT**, press  or  to select **VIDEO1**, **VIDEO2**, or **S-VIDEO1**, then press **ENTER** to confirm.

Connecting a DVD player**Note**

You can also connect the output from a digital set-top box to the **YPbPr** jacks.

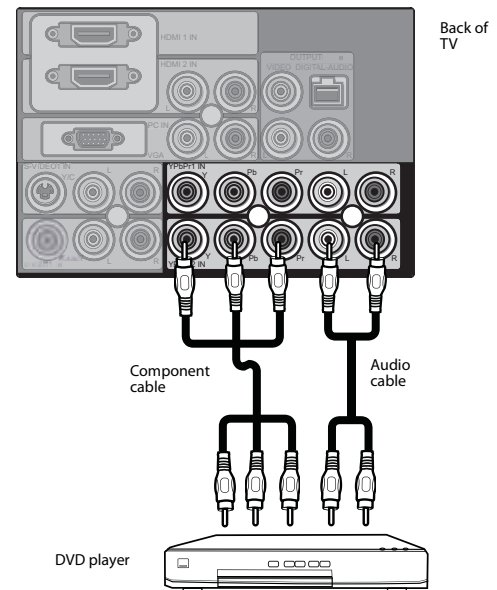
The component out jacks of your DVD player may be labeled **YPbPr** or **YCbCr**. For an explanation, see your DVD player's user guide.

**To connect a DVD player:**

- Plug component video cables (green = Y, blue = Pb, and red = Pr) into the component out jacks of the DVD player, then into the **YPbPr1 IN** or **YPbPr2 IN** jacks on the back of your TV.
- Plug RCA audio cables into the DVD player's audio output jacks, then into the **YPbPr1 IN** or **YPbPr2 IN** **AUDIO L** (white) and **AUDIO R** (red) jacks on the back of your TV.
- Press  to turn on your TV.
- Press **INPUT**, press  or  to select **YPbPr1** or **YPbPr2**, then press **ENTER** to confirm.

Connecting a digital cable TV box or satellite receiver

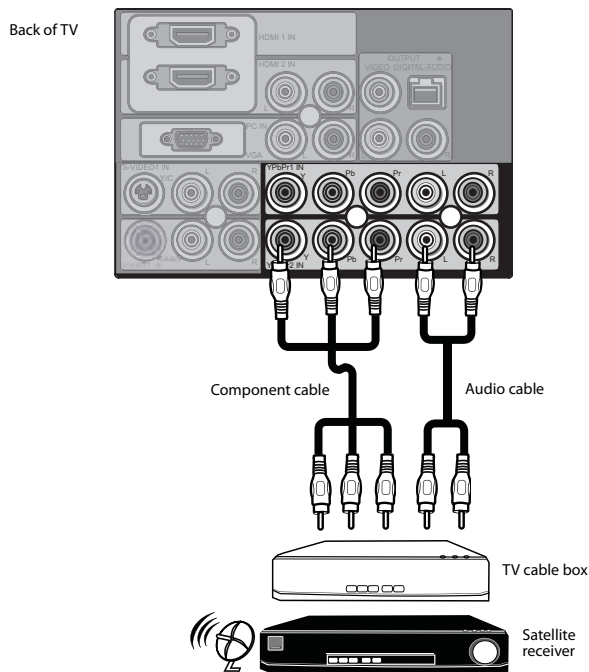

To connect a digital cable TV box or satellite receiver:

- 1 Plug component video cables (green = Y, blue = Pb, and red = Pr) into the component out jacks of the cable TV box or satellite receiver, then into the **YPbPr1 IN** or **YPbPr2 IN** jacks on the back of your TV.
- 2 Plug RCA audio cables into the audio output jacks of the cable TV box or satellite receiver, then into the **YPbPr1 IN** or **YPbPr2 IN** **AUDIO L** (white) and **AUDIO R** (red) jacks on the back of your TV.
- 3 Press **POWER** to turn on your TV.
- 4 Press **INPUT**, press **▲** or **▼** to select **YPbPr1** or **YPbPr2**, then press **ENTER** to confirm.

Connecting AV equipment with an HDMI cable

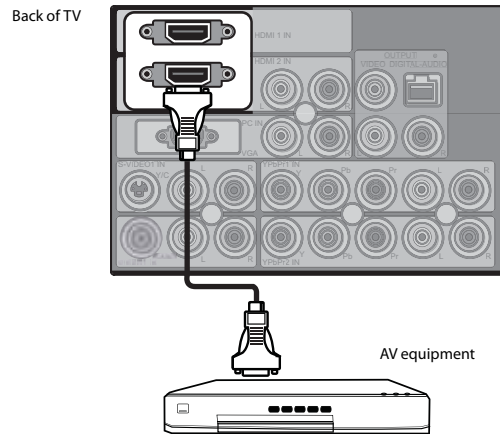

To connect AV equipment with an HDMI cable:

- 1 Plug an HDMI cable into the HDMI out jack of the AV equipment, then into the **HDMI1 IN** or **HDMI2 IN** jacks on the back of your TV.
- 2 Press **POWER** to turn on your TV.
- 3 Press **INPUT**, press **▲** or **▼** to select **HDMI1** or **HDMI2** (rear), then press **ENTER** to confirm.

Note

The HDMI cable provides both video and audio signals, so it is not necessary to connect additional audio cables for sound.

Connecting AV equipment with a DVI connector

This connection can be used to connect a digital video source, such as a PC, digital-capable DVD, or digital set-top box, to your TV.

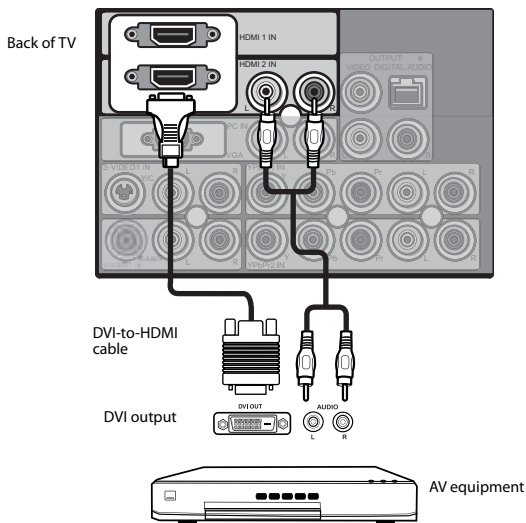

To connect AV equipment with an HDMI-to-DVI cable:

- 1 Plug the DVI connector of an HDMI-to-DVI cable into the DVI out jack of the AV equipment, then plug the HDMI connector into the **HDMI 1 IN** or **HDMI 2 IN** jacks on the back of your TV.
- 2 Plug RCA audio cables into the audio output jacks of the AV equipment, then into the **HDMI AUDIO L** (white) and **AUDIO R** (red) jacks on the back of your TV.
- 3 Press **POWER** to turn on your TV.
- 4 Press **INPUT**, press **▲** or **▼** to select **HDMI1** or **HDMI2** (rear), then press **ENTER** to confirm.

Note

To connect your TV to the AV equipment's DVI output, you need an HDMI-to-DVI cable or an HDMI adapter (not supplied) and audio cables.

Connecting a PC

For information on connecting a PC to your TV with a DVI cable, see "Connecting AV equipment with a DVI connector" on Page 12.

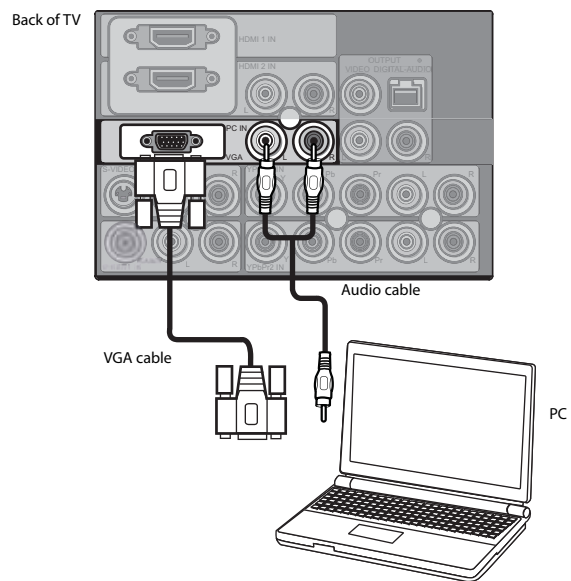

To connect a PC:

- 1 Plug a VGA (D-sub 15-pin) cable into the VGA (RGB) output jack on your PC, then into the **PC IN VGA** jack on the back of your TV.
- 2 Plug an audio cable into the audio output jack on your PC, then into the **PC IN AUDIO L** (white) and **AUDIO R** (red) jacks on the back of your TV.
- 3 Turn on your TV and the PC.
- 4 Press **INPUT**, press **▲** or **▼** to select **PC (VGA)**, then press **ENTER** to confirm.

Notes

In PC mode, there may be noise associated with the resolution, vertical pattern, contrast, or brightness. If noise is present, change the PC output to another resolution, change the refresh rate to another rate, or adjust the brightness and contrast on the **VIDEO** menu until the picture is clear.

Avoid keeping a fixed image on the screen for a long period of time. The fixed image could become permanently imprinted on the screen.

Depending on your graphics card, some resolution settings may not allow the image to be positioned on the screen correctly.

The screen resolution of your TV is optimized during for the display modes listed below. If the signal from the PC is a standard resolution, the screen is adjusted automatically. If the signal from the system is not standard, adjust the screen resolution by referring to your video card user guide, otherwise there may be no picture.

Resolution	Vertical frequency (Hz)	Horizontal frequency (kHz)
640 × 400	85	37.9
720 × 400	85	37.9
640 × 480	60	31.5
	72	37.9
	75	37.5
	85	43.3
800 × 600	56	35.1
	60	37.9
	72	48.1
	75	46.9
	85	53.7
1024 × 768	60	48.4
	70	56.5
	75	60.0

Connecting an audio receiver or Dolby Digital 5.1 sound system

You can connect your TV's audio to a digital amplifier or home theater system.

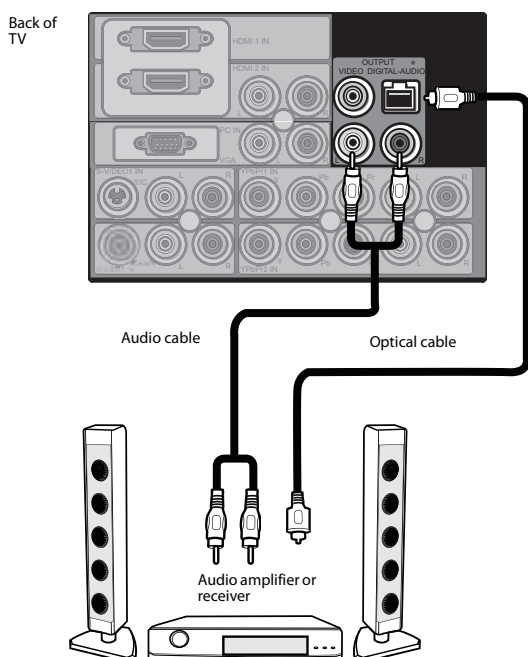

To connect to an audio receiver or Dolby Digital 5.1 sound system:

- 1 Plug RCA audio cables into the **OUTPUT AUDIO L** (white) and **AUDIO R** (red) jacks on the back of your TV, then into the **AUDIO L** (white) and **AUDIO R** (red) input jacks on the audio receiver.

- OR -

Plug an optical cable into the **DIGITAL AUDIO OUTPUT** jack on the back of your TV, then into to optical input jack on your Dolby Digital 5.1 sound system.

- 2 Press  to turn on your TV.

Arranging the cables

After connecting the cables, bundle the cables using the cable guide as shown.

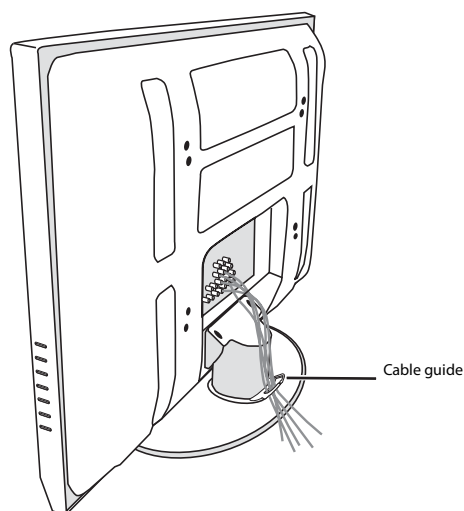

Using the swivel base

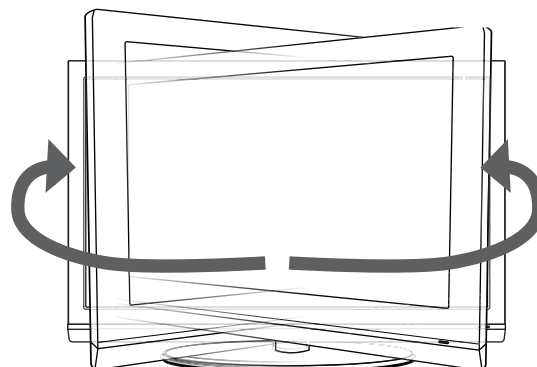

The viewing angle of your TV may be adjusted approximately 60° to the left or right as shown.



Using your TV

Turning the TV on and off

To turn your TV on and off:

- 1 Press  (power) on the TV or remote control. The **POWER/STANDBY** indicator turns blue and your TV turns on.
- 2 To turn off your TV, press  (power). The TV goes to Standby mode and the Power/Standby indicator turns red.

Note

If you are going to be away for an extended time, disconnect the power cord from the power outlet.

Changing channels



To change channels:

- Press **CH +** or **CH -** on the front of your TV or on the remote control.

To enter a channel number directly:

- Press the number buttons on the remote control. In digital TV mode, a main (major) channel can have one or more sub (minor) channels. Press the number buttons to enter the main channel, press the **•** button (to the left of the 0 button), then press the number button for the sub-channel. For example, if you want to watch channel 5.2, press **5**, press the **•** button, then press **2**.

To select a channel from the channel list:

- 1 Press **CH-LIST**. The channel list displays on the screen.
- 2 Press  or  to select the channel you want, then press **ENTER** to go to that channel.

To go to the previous channel:

- Press **RECALL**.

Adjusting the volume



You can adjust the volume using the controls on your TV's side panel or the remote control.

To adjust the volume:

- 1 Press **VOL+** or **VOL-** to increase or decrease the volume.
- 2 Press **MUTE** to mute the sound. To restore the sound, press this button again, or the **VOL+** or **VOL-**.

Selecting the video source

To select the video source for your TV:

- 1 Press **INPUT** to display the *Input Source List*.
- 2 Press  or  to select the source you want (initially select **TV**), then press **ENTER**.

Memorizing receivable channels

Channel scan creates a list of receivable channels for the current input (antenna or cable). You need to run channel scan for each RF input to create a list of available channels from both inputs.

To scan for receivable channels:

- 1 Press **MENU**. The main (*Video*) menu opens.

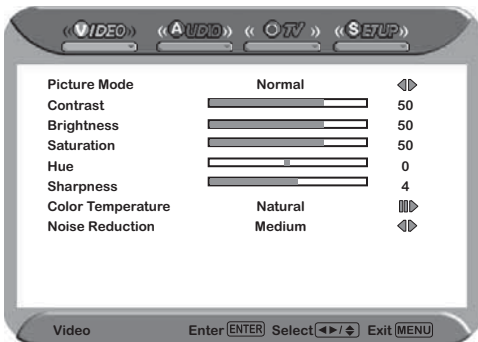

- 2 Press **◀** or **▶** to select the **TV** menu icon. The *TV Menu* opens.

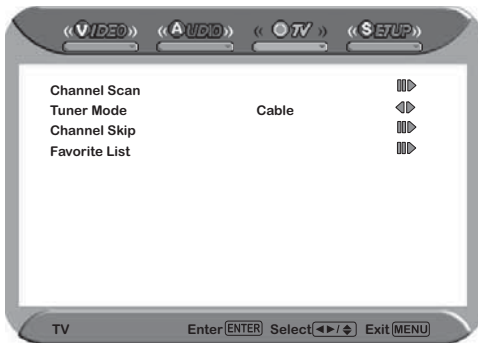

- 3 Press **▼** to select **Channel Scan**, then press **ENTER**. Channel Scan automatically creates a list of receivable channels. Press **MENU** at any time to interrupt the memorization process (the list will not be created if the scan is interrupted).

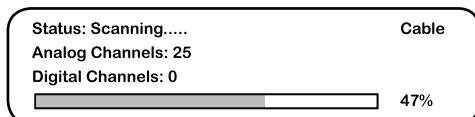

- 4 Press **ENTER** to display the received channel list, then press **▲** or **▼** to select a channel.
- 5 Press **ENTER** to show the channel detail information.

Channel List	Channel Detail
5-2 RFS-2	California's Gold
9-1 KOED-HD	
9-2 KOED-SD	
8 CCT	
12	
13	
15	

For digital main channels, which might include many subchannels (for example 9-1 or 9-2) that show programs at the same time, press **●** with 0-9 buttons to select digital channel (for example, 9.1).

Selecting the aspect ratio

The Wide Screen feature lets you view 4:3 or 16:9 images in wide screen mode. Press **ZOOM** repeatedly to cycle through the available screen formats.

NORMAL—Content with 4:3 aspect is displayed centered on screen with pillar bars on right and left.



Note

NORMAL is not available when you are watching a 720p, 1080i, or 1080p source.

WIDE—Content in this mode stretches horizontally to fill the entire width of the screen while at least 95% of the image width is visible.



ZOOM—The image is typically wide format embedded in a 4:3 aspect frame with bars on the top and bottom.



CINEMA—Cinema zoom mode is used for viewing anamorphic content in wide 2.35:1 format (such as on Star Wars DVD disc) on 16:9 screens.

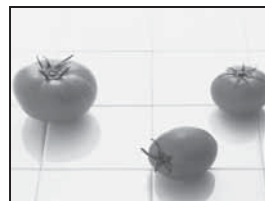

Using the on-screen menus

Your TV's OSD (on-screen display) may differ slightly from that shown in this manual.

Use your remote control to navigate in the on-screen menus.

To use the on-screen menus:

- 1 Press **MENU**. The main (*Video*) menu opens.

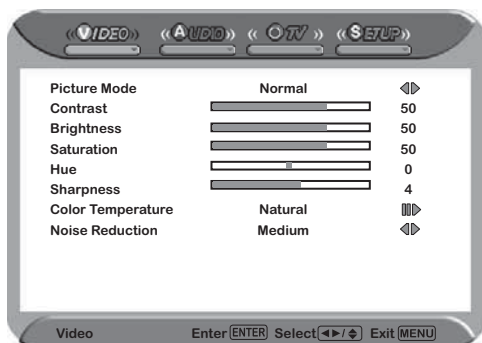

- 2 Press **◀** or **▶** to select the icon for the menu you want. The selected menu opens (for example the *TV* menu).

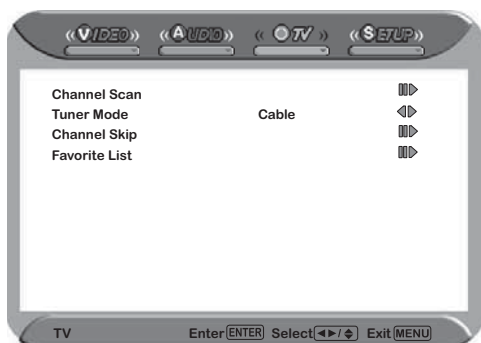

- 3 Press **▲** or **▼** to select the option you want to change, or the sub-menu you want to access.
- 4 Press **◀** or **▶** to change the setting of the selected option, or press **ENTER** to enter the selected sub-menu.
- 5 Press **MENU** to exit a sub-menu, or press **EXIT** to close the menus and return to normal viewing.

Changing the *SETUP* menu settings

To change the *SETUP* menu settings:

- 1 Press **MENU**. The main (*Video*) menu opens.

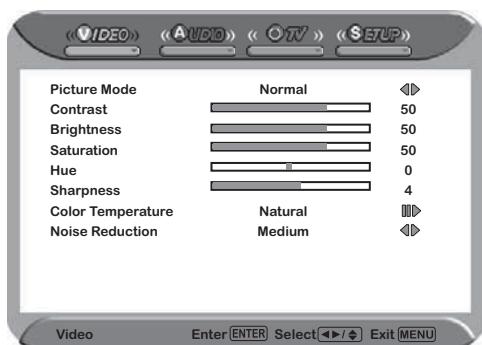

- 2 Press **◀** or **▶** to select **SETUP**. The *Setup* menu opens.

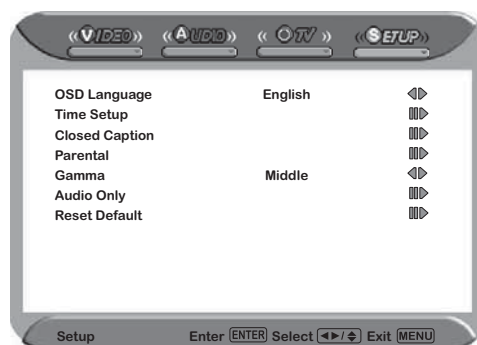

- 3 Press **▲** or **▼** to select the option you want to change, or the sub-menu you want to access. Options and sub-menus include:
 - **OSD Language**— Lets you select an alternate language for the on-screen menus. Choices include **English**, **French**, and **Spanish**.
 - **Time Setup**— Opens a sub-menu that lets you set time options. See "To change the time settings:" on page 15.
 - **Closed Caption**— Opens a sub-menu that lets you set closed captioning options. See "To set the closed caption options:" on page 16.
 - **Parental**— Opens a sub-menu that lets you set parental control options.
 - **Gamma**— Lets you set the TV's gamma correction, which fine tunes both brightness and the red/green/blue ratio. Settings include **Middle**, **Dark**, and **Bright**.
 - **Audio Only**— Lets you turn off the picture. You can cancel Audio Only by pressing any button on remote control.
 - **Reset Default**— Lets you reset the TV settings to factory default. Press **ENTER** to reset.
- 4 Press **◀** or **▶** to change the setting of the selected option, or press **ENTER** to enter the selected sub-menu.
- 5 Press **MENU** to exit a sub-menu, or press **EXIT** to close the menus and return to normal viewing.

Changing time settings

To change the time settings:

- 1 Press **MENU**. The main (*Video*) menu opens.

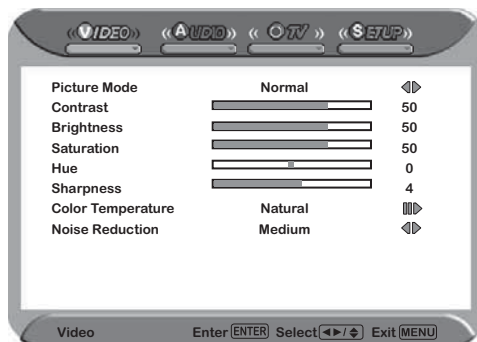

- 2 Press **◀** or **▶** to select **SETUP**. The *Setup* menu opens.

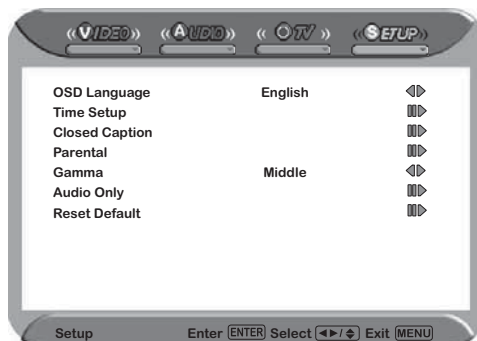

- 3 Press ▲ or ▼ to select **Time Setup**, then press **ENTER**. The *Time Setup* sub-menu opens.

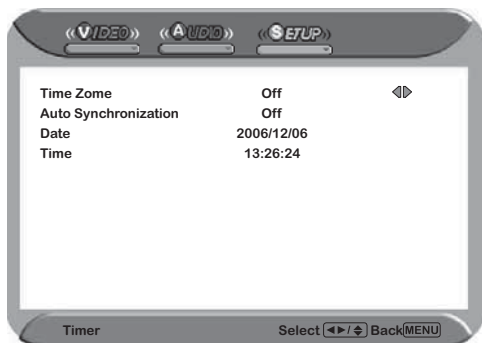

- 4 Press ▲ or ▼ to select one of the time setup options, then press ◀ or ▶ to change the setting. Options include:
- **Time Zone**—Cycles through the available time zones in the U.S., including Eastern Time, Indiana, Central Time, Mountain Time, Arizona, Pacific Time, Alaska, and Hawaii.
 - **Auto Synchronization**—Lets you choose to have the TV time set automatically based on the TV/cable system time. Options are **On** or **Off**.
 - **Date**—Press ◀ or ▶ to move to each setting, then press the number buttons (9~0) to set the current date.
 - **Time**—Press ◀ or ▶ to move to each setting, then press the number buttons (9~0) to set the current time.
- 5 Press **MENU** to exit a sub-menu, or press **EXIT** to close the menus and return to normal viewing.

Setting closed caption options

To set the closed caption options:

- 1 Press **MENU**. The main (*Video*) menu opens.

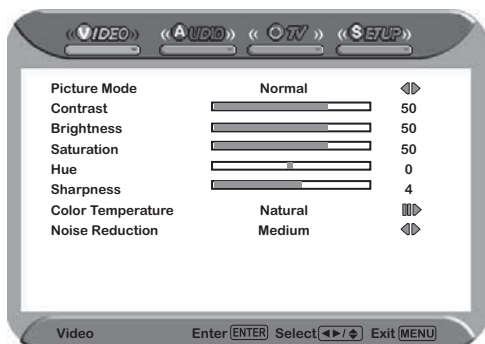

- 2 Press ◀ or ▶ to select **SETUP**. The *Setup* menu opens.

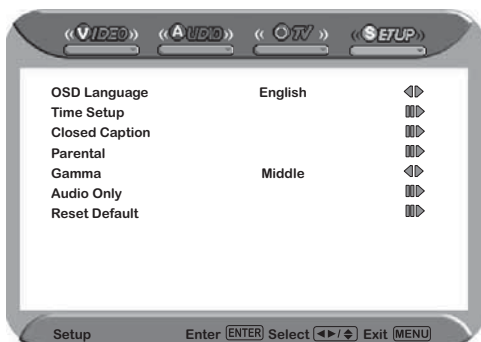

- 3 Press ▲ or ▼ to select **Closed Caption**, then press **ENTER**. The *Closed Caption* sub-menu opens.

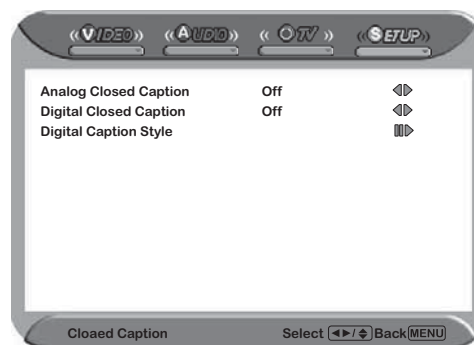

- 4 Press ▲ or ▼ to select the option you want to change, or the sub-menu you want to access. Options and sub-menus include:
- **Analog Closed Caption**—Press ◀ or ▶ to select the type of analog closed captions that are shown. Options include
 - **CC1/CC2/CC3/CC4**—Shows a printed version of the dialog and sound effects of the program being viewed.
 - **T1/T2**—Shows station information using half or all of the screen.
 - **T3/T4**—Shows extended data for the station selected, including network name, program name, program length, and so on.
 - **Digital Closed Caption**—Press ◀ or ▶ to select the type of digital closed captions that are shown. Options include **Service1**, **Service2**, **Service3**, **Service4**, **Service5**, **Service6**, and **Off**.
 - **Digital Caption Style**—Press **ENTER** to open this sub-menu, which lets you make changes to the closed captioning style. Press ◀ or ▶ to cycle through the available settings for each option. Options include:
 - **Caption Style**—Sets the style of the closed caption.
 - **Font Size**—Sets the word size.
 - **Font Color**—Selects a typeface for the text.
 - **Font Opacity**—Specifies the opacity of the text color.
 - **Background Color**—Selects a background color.
 - **Background Opacity**—Selects the opacity for the background color.
 - **Window Color**—Selects a color for the window.
 - **Window Opacity**—Selects the opacity for the window.
- 5 Press **MENU** to exit a sub-menu, or press **EXIT** to close the menus and return to normal viewing.

Setting parental control options

To change the parental control settings:

- 1 Press **MENU**. The main (*Video*) menu opens.

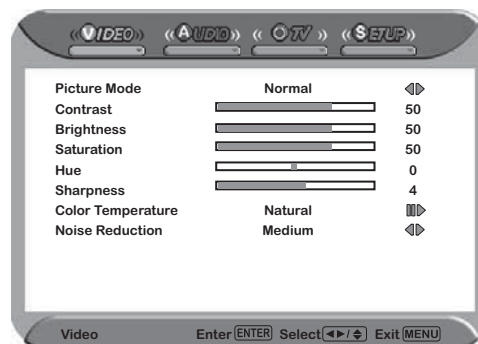

- 2 Press ◀ or ▶ to select **SETUP**. The *Setup* menu opens.

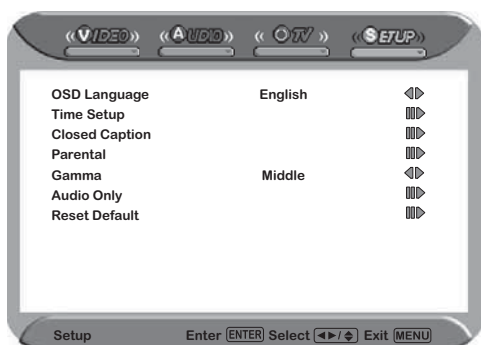

- 3 Press ▲ or ▼ to select **Parental**, then press **ENTER**. The password screen opens.

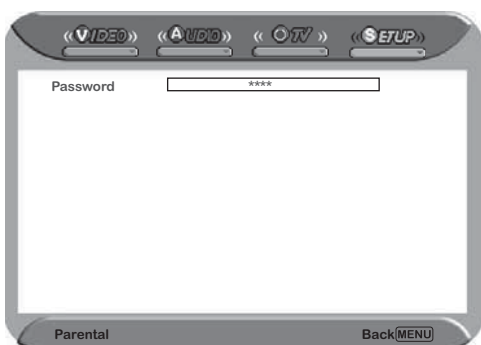

- 4 Enter your four-digit password (the factory preset password is **0000**). The *Parental* sub-menu opens.

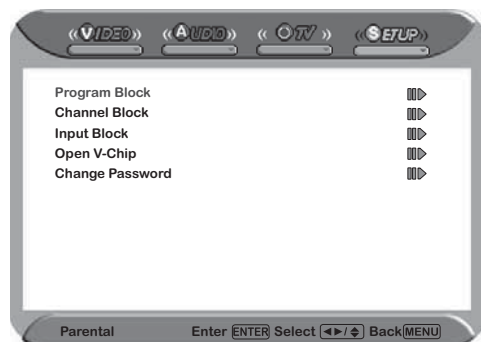

- 5 Press ▲ or ▼ to select one of the sub-menu options, then press **ENTER** to enter the sub-menu. Options include:

- **Program Block**—Lets you block programs, based on content.
- **Channel Block**—Lets you block the channels you select.
- **Input Block**—Lets you block the input type you select.
- **Open V-Chip**—Lets you block programs based on downloadable ratings. (Only available in the U.S., where Open V-Chip ratings are available.)
- **Change Password**—Lets you change your parental control password.

- 6 Press **MENU** to exit a sub-menu, or press **EXIT** to close the menus and return to normal viewing.

Setting program blocking

Rating guidelines are provided by broadcasting stations. Most television programs and television movies can be blocked by TV rating or individual categories. Movies that have been shown in theaters or direct-to-video movies use the movie rating system (MPAA) only.

TV parental guidelines ratings

Rating	Description
TV-Y	All children
TV-Y7	Children over seven years of age
TV-G	General audiences
TV-PG	Parental guidance suggested
TV-14	Parents strongly cautioned
TV-MA	Mature audiences only

Some of the age-based TV parental guidelines ratings also have content-based ratings.

Rating	Description
FV	Fantasy violence
L	Adult language
S	Sexual situations
V	Violence
D	Sexually suggestive dialog

US MPAA ratings

Rating	Description
G	General audiences
PG	Parental guidance suggested. Some material may not be suitable for children.
PG-13	Parental guidance strongly suggested. Some material may not be suitable for children under 13 years of age.
R	Restricted. Not suitable for children under 17 years of age unless accompanied by a parent or guardian.
NC-17	Not suitable for children under 17 years of age.
X	Adults only
N/A	Not rated

Canadian English ratings

Rating	Description
C	Children
C8+	Children 8 years and above
G	General audience
PG	Parental guidance suggested
14+	14 years old and above
18+	Adult programming
E	Exempt - Not rated

Canadian French ratings

Rating	Description
G	Children
8ans+	Children 8 years and above
13ans+	Children 13 years and above
16ans+	Children 16 years and above
18ans+	Adult programming
EXEMPT	Not rated

To set up program blocking:

- 1 Press **MENU**. The main (*Video*) menu opens.

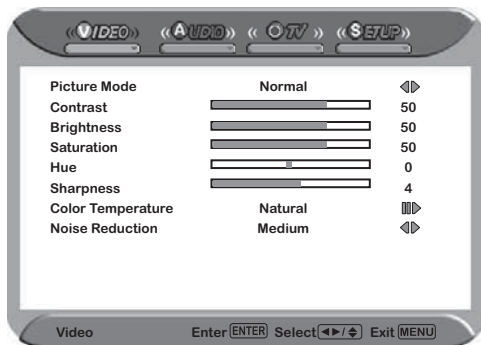

- 2 Press **◀** or **▶** to select **SETUP**. The *Setup* menu opens.

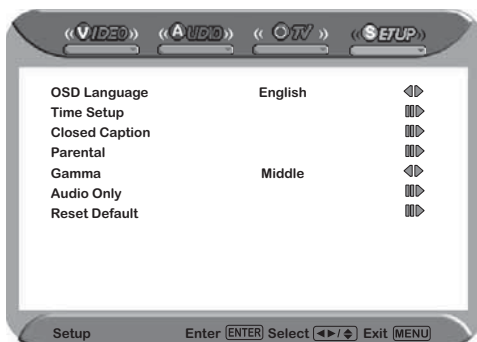

- 3 Press **▲** or **▼** to select **Parental**, then press **ENTER**. The password screen opens.

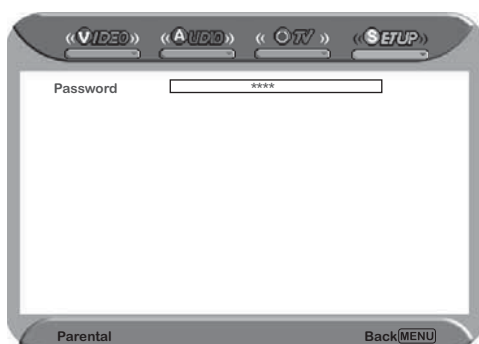

- 4 Enter your four-digit password (the factory preset password is **0000**). The *Parental* sub-menu opens.

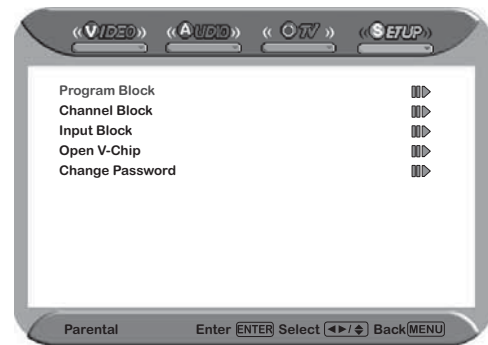

- 5 Press **▲** or **▼** to select **Program Block**, then press **ENTER** to enter the sub-menu. The *Program Block* sub-menu opens.

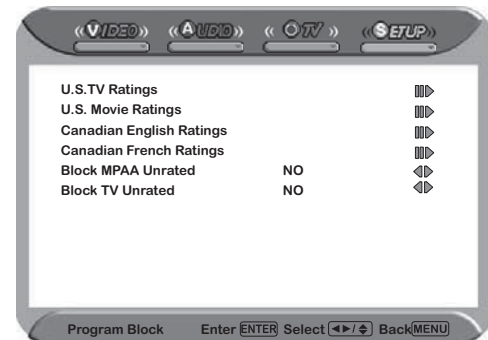

- 6 Press **▲** or **▼** to select sub-menu you want to access or the option you want to change. Options and sub-menus include:
 - **U.S. TV Ratings**—Opens a sub-menu that lets you block TV programs, based on content.
 - **U.S. Movie Ratings**—Opens a sub-menu that lets you block movies, based on content.
 - **Canadian English Ratings**—Opens a sub-menu that lets you block programs, based on the Canadian (English) rating system.
 - **Canadian French Ratings**—Opens a sub-menu that lets you block programs, based on the Canadian (French) rating system.
 - **Block MPA A Unrated**—Lets you block movies that are unrated. Options are **No** and **Yes**.
 - **Block TV Unrated**—Lets you block TV programs that are unrated. Options are **No** and **Yes**.
- 7 If you open one of the ratings sub-menus, press **▲**, **▼**, **◀**, or **▶** to select the rating you want to block, then press **ENTER** to block the rating.
A lock icon appears in the box opposite any rating you block. When you block a rating, all ratings below that rating are also blocked.
- 8 Press **MENU** to exit a sub-menu, or press **EXIT** to close the menus and return to normal viewing.

Setting channel blocking

To set up channel blocking:

- 1 Press **MENU**. The main (*Video*) menu opens.

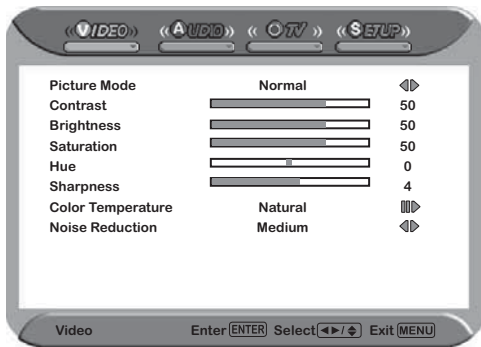

- 2 Press **◀** or **▶** to select **SETUP**. The *Setup* menu opens.

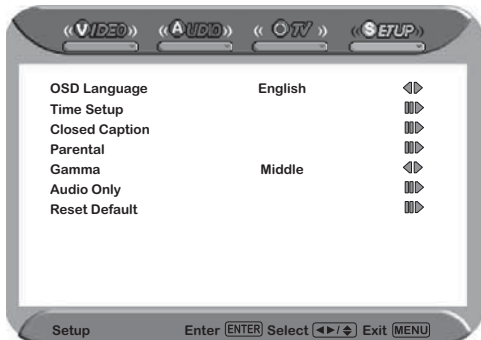

- 3 Press **▲** or **▼** to select **Parental**, then press **ENTER**. The password screen opens.

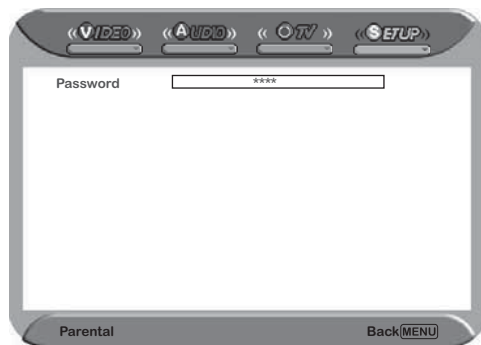

- 4 Enter your four-digit password (the factory preset password is **0000**). The *Parental* sub-menu opens.

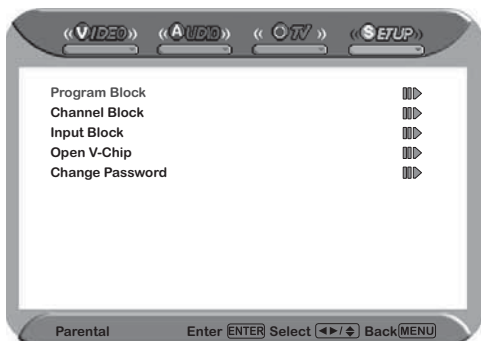

- 5 Press **▲** or **▼** to select **Channel Block**, then press **ENTER** to enter the sub-menu. The *Channel Block* sub-menu opens.

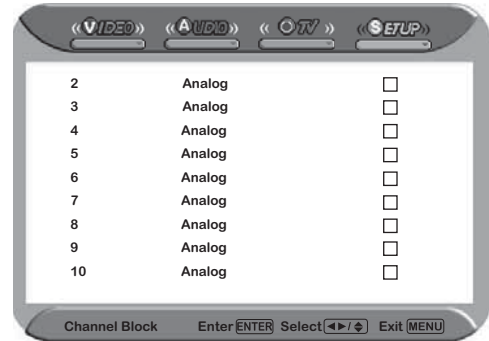

- 6 Press **▲** or **▼** to select the channel you want to block, then press **ENTER** to block the channel. A lock icon appears in the box opposite any channel you block.
- 7 Press **MENU** to exit the sub-menu, then press **EXIT** to close the menus and return to normal viewing.

Setting input blocking

To set up input blocking:

- 1 Press **MENU**. The main (*Video*) menu opens.

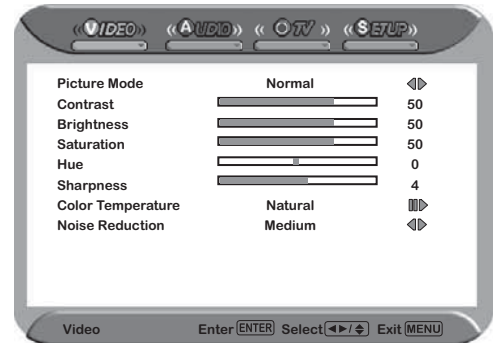

- 2 Press **◀** or **▶** to select **SETUP**. The *Setup* menu opens.

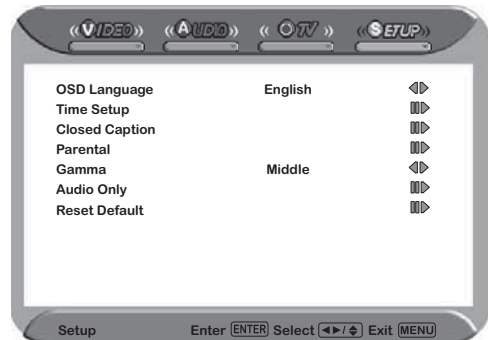

- 3 Press **▲** or **▼** to select **Parental**, then press **ENTER**. The password screen opens.

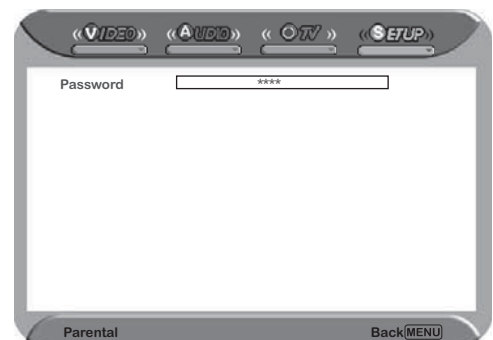

- 4 Enter your four-digit password (the factory preset password is **0000**). The **Parental** sub-menu opens.

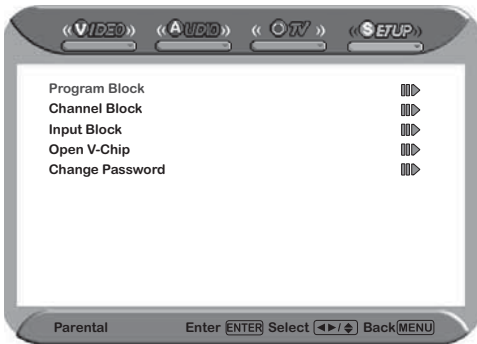

- 5 Press **▲** or **▼** to select **Input Block**, then press **ENTER** to enter the sub-menu. The **Input Block** sub-menu opens.

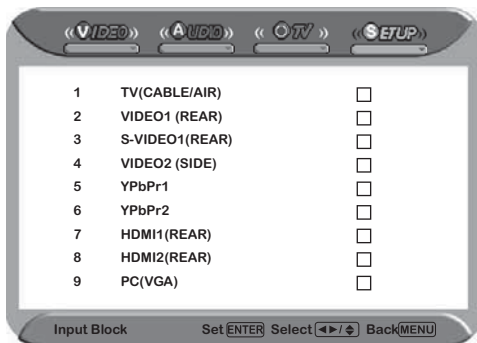

- 6 Press **▲** or **▼** to select the input source you want to block, then press **ENTER** to block the input. A lock icon appears in the box opposite any input source you block.
- 7 Press **MENU** to exit the sub-menu, then press **EXIT** to close the menus and return to normal viewing.

Setting blocking based on downloadable ratings

The Open V-Chip function is automatically downloaded while watching DTV channels. this may take several seconds. The rating name (for example **Humor Level**, **Intelligence Level**, and so on) and rating level (for example, **DH**, **MH**, **H**, and so on) may be different, depending on the information provided by the broadcasting station.

To set up downloadable rating blocks:

- 1 Press **MENU**. The main (*Video*) menu opens.

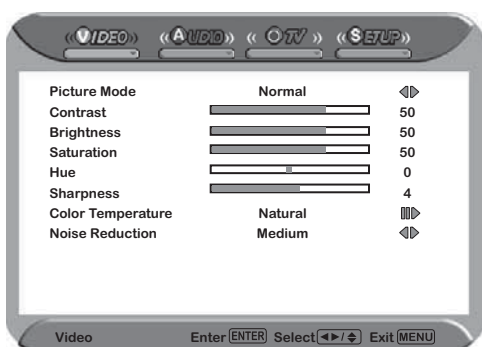

- 2 Press **◀** or **▶** to select **SETUP**. The **Setup** menu opens.

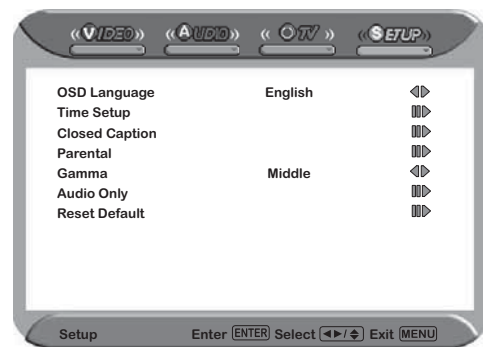

- 3 Press **▲** or **▼** to select **Parental**, then press **ENTER**. The password screen opens.

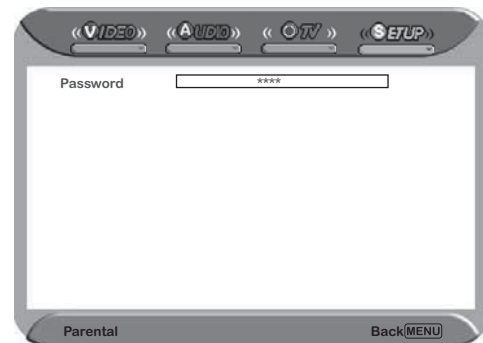

- 4 Enter your four-digit password (the factory preset password is **0000**). The **Parental** sub-menu opens.

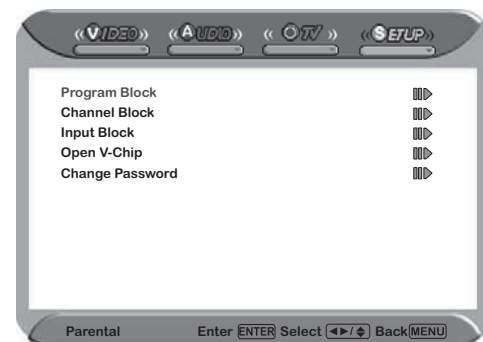

- 5 Press **▲** or **▼** to select **Open V-Chip**, then press **ENTER** to enter the sub-menu. The **Open V-Chip** sub-menu opens.

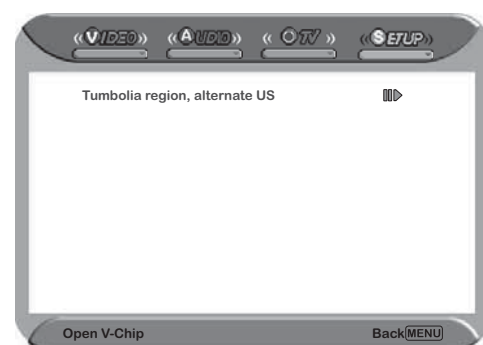

- 6 Press **▲** or **▼** to select the downloadable rating you want to block, then press **ENTER** to block that rating. A lock icon appears in the box opposite any rating you block.
- 7 Press **MENU** to exit the sub-menu, then press **EXIT** to close the menus and return to normal viewing.

Changing video settings

To change the video settings:

- 1 Press **MENU**. The main (Video) menu opens.

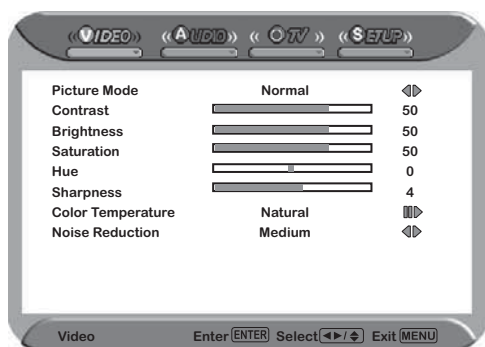

- 2 Press **▲** or **▼** to select the option you want to change, or the sub-menu you want to access. Options and sub-menus include:

- **Picture Mode**—Cycles through the available preset picture modes. Choices include **Vivid**, **Normal**, **Cinema**, **Sport**, and **User**.

Note

If you select the **User** mode, you can individually set the items shown below.

- **Contrast**—Adjusts the difference between the brightest and darkest areas of the picture.
- **Brightness**—Adjusts the overall brightest of the picture.
- **Saturation**—Adjusts the overall color intensity of the picture.
- **Hue**—Adjusts the balance between the green and red color of the picture.
- **Sharpness**—Adjusts the overall focus of the picture.
- **Color Temperature**—Press **ENTER** to open a sub-menu where you can cycle through the available preset color temperature modes. Choices include **Warm**, **Cool**, and **Normal**.
- **Noise Reduction**—Cycles through the available preset modes designed to reduce noise from connected equipment. Choices include **Off**, **Low**, **Strong**, and **Medium**.
- **VGA**—Only available in VGA mode. Opens a sub-menu where you can adjust the VGA settings of your TV. Choices include:
 - **Auto Adjust**—Press **ENTER** to automatically adjust the settings to optimize the VGA picture.
 - **H. Position**—Adjusts the horizontal position of the picture.
 - **V. Position**—Adjusts the vertical position of the picture.
 - **Clock**—Adjusts the width of the picture based on the VGA mode.
 - **Phase**—Adjusts the signal phase, which can improve image clarity and stability based on the VGA mode.

- 3 Press **◀** or **▶** to change the setting of the selected option, or press **ENTER** to enter the selected sub-menu.
- 4 Press **MENU** to exit a sub-menu, or press **EXIT** to close the menus and return to normal viewing.

Changing audio settings

To change the audio settings:

- 1 Press **MENU**. The main (Video) menu opens.

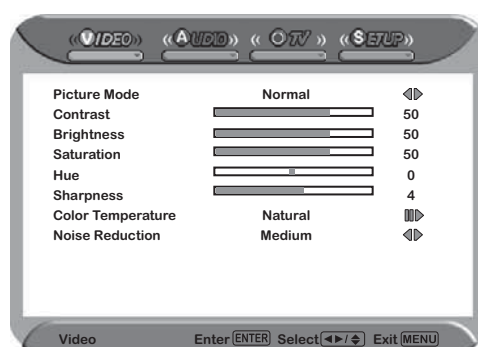

- 2 Press **◀** or **▶** to select the Audio menu icon. The **Audio** menu opens.

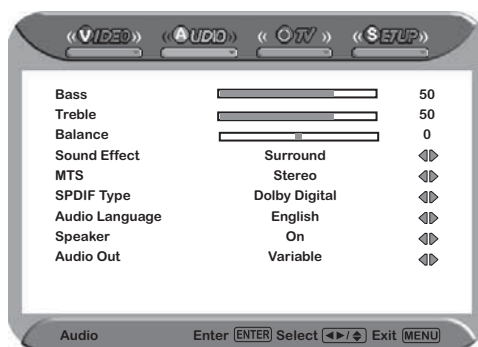

- 3 Press **▲** or **▼** to select the option you want to change. Options include:

- **Bass**—Adjusts the relative intensity of the lower-pitched sounds.
- **Treble**—Adjusts the relative intensity of the higher-pitched sounds.
- **Balance**—Adjusts the relative volume of speakers (left to right) in a multi-speaker system.
- **Sound Effect**—Cycles through the available preset sound effect modes. Choices include **Surround**, **Live**, **Dance**, **Techno**, **Classic**, **Soft**, **Rock**, **Pop**, and **Off**.
- **Speaker**—Lets you turn the TV speakers **On** or **Off** (to listen to the audio through an external amplifier/receiver and speakers).
- **MTS** (Multi-channel TV Sound)(DTV only)—Cycles through the available sound modes. Choices include **Stereo**, **SAP**, and **Mono**.
- **SPDIF** (DTV only)—Lets you select the digital sound format. Choices include **PCM** (external audio from AUDIO OUT (L/R)), **Off**, and **Dolby Digital** (external audio from DIGITAL AUDIO OUT).
- **Audio Language** (DTV only)—Cycles through the available audio languages. Choices include **English**, **Spanish**, and **French**.
- **Audio Out**—This option can be set only when the Speaker option is set to OFF. Options are:
 - **Variable**—The audio output from your external audio system can be controlled by the TV's remote control.
 - **Fixed**—The audio output from your external audio system can be controlled by the external audio system's remote control.

- 4 Press **◀** or **▶** to change the setting of the selected option.
- 5 Press **EXIT** to close the menus and return to normal viewing.

Changing TV settings

To change the TV settings:

- 1 Press **MENU**. The main (*Video*) menu opens.

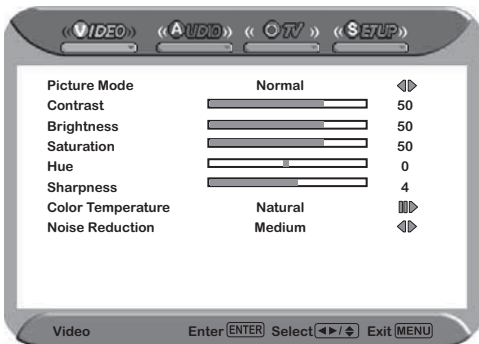

- 2 Press **◀** or **▶** to select the TV menu icon. The *TV* menu opens.

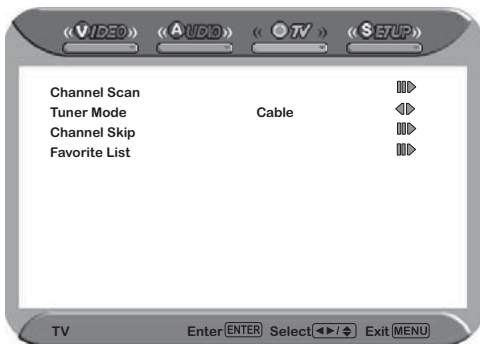

- 3 Press **▲** or **▼** to select the option you want to change or the sub-menu you want to open. Options include:
 - **Channel Scan**—Press **ENTER** to automatically scan for receivable channels and create a channel list.
 - **Tuner Mode**—Toggles between the available tuner modes. Choices are **AIR** and **Cable**.
 - **Channel Skip**—Press **ENTER** to open the *Channel Skip* sub-menu. When the sub-menu opens, press **▼** to select the channels you want, then press **ENTER** repeatedly to hide (with a check mark in the box), or show (without a check mark) the channel. Repeat as necessary.
 - **Favorite List**—Press **ENTER** to open the *Favorite List* sub-menu. When the sub-menu opens, press **▼** to select the channels you want on your favorite list, then press **ENTER** to show (with a check mark in the box), or hide (without a check mark) the channel. Repeat as necessary.
- 4 Press **◀** or **▶** to change the setting of the selected option.
- 5 Press **EXIT** to close the menus and return to normal viewing.

Maintaining your TV

Careful and regular cleaning can extend the amount of time you can enjoy your new TV.

Caution

Make sure that you turn the power off and unplug the power cord before you begin any cleaning.

Cleaning the screen

Wet a soft cloth in a mixture of luke warm water and a little fabric softener or dishwasher detergent. Wring the cloth until it's almost dry, and then use it to wipe the screen.

Make sure the excess water is off the screen, and then let it air dry before you turn on your TV.

Cleaning the cabinet

Wipe the front panel and other exterior surfaces of your TV with a soft, dry, lint-free cloth. Never use a solvent or alcohol to clean your TV. Do not spray insecticide near your TV. Such chemicals may cause damage and discoloration to the exposed surfaces.

Troubleshooting

Operation

Problem	Solution
Remote control does not work	<ul style="list-style-type: none"> • Remove obstacles between the remote control and the player. • Point the remote control at your TV's IR sensor. Install fresh batteries.
Power turns off suddenly	<ul style="list-style-type: none"> • Make sure that the sleep timer is not set. • Check the power control settings.

Video problems

Problem	Solution
No picture or sound	<ul style="list-style-type: none"> • Check all cable connections. • Make sure that your TV is turned on. • Try another channel. It may be a broadcast problem. • Check your antenna connection, location, or direction. • Make sure that the power connection is okay. Check the wall power outlet.
Picture appears slowly when your TV is turned on	<ul style="list-style-type: none"> • It is normal for the image to be muted during the startup process. If the picture does not appear after five minutes, call your Insignia service center.
Picture is satisfactory, but no sound	<ul style="list-style-type: none"> • Check the volume level and mute setting.
No color, poor color, or poor picture	<ul style="list-style-type: none"> • Check the picture control and adjust color. • Make sure you have provided a sufficient distance between the TV and VCR. • Try another channel. The problem may be the broadcast. • Make sure the video cables are connected correctly. • Check the power saving feature and restore the brightness of your TV. • Check the program's color features. The problem may be that it is a black and white movie.
Poor reception on some channels	<ul style="list-style-type: none"> • Check the antenna and its connection. If there are problems, correct them. If all connections are tight, the problem may be with a faulty antenna or cable. • The station or your cable TV provider may be experiencing problems. • Check for sources of interference. • Re-orient your antenna for better reception.
Stripes or bars on picture	<ul style="list-style-type: none"> • Check for interference from other electronic devices, such as radios and televisions, and keep magnetic or electronic devices away from your TV. • Check your antenna connection, location, or direction.

Audio problems

Problem	Solution
Picture okay, but no sound	<ul style="list-style-type: none"> • Press the volume control to increase the volume. • Press MUTE to make sure that your TV is not muted. • Try another channel. The problem may be with the broadcast. • Make sure that the audio cables are installed correctly.
No output from one of the speakers	<ul style="list-style-type: none"> • Adjust the balance in the <i>AUDIO</i> menu.
Unusual sound from inside the TV	<ul style="list-style-type: none"> • A change in ambient humidity or temperature may result in an unusual noise when the product is turned on or off. This does not indicate a fault with the product.

PC mode problems

Problem	Solution
The signal is out of range	<ul style="list-style-type: none"> • Adjust the resolution, horizontal frequency, or vertical frequency. • Check the input source.
Vertical bar or stripe on the background, horizontal noise, or incorrect position	<ul style="list-style-type: none"> • Adjust the clock, phase, or horizontal/vertical position, or try Auto to configure these options.
The screen color is unstable or a single color	<ul style="list-style-type: none"> • Check the signal cable to make sure that it is connected correctly. • Reinstall your PC's video card.

Specifications

Plasma panel	Panel size	42-inch plasma
	Aspect ratio	16:9
	Brightness	1500 cd/m ²
	Contrast ratio	10,000:1
	Max. resolution	1024 × 768
	Maximum colors	16.7 million
Input connector	Video/Audio (L/R) in	2
	S-Video/Audio (L/R) in	1
	YPbPr/Audio (L/R)	2
	VGA/Audio (L/R)	1
	HDMI/Audio (L/R)	2
	Audio out (L/R)	1
	Optical	1
	Headphone	1
Power source		100-240V AC, 50/60 Hz
Power consumption		310 W Standby <1 W
Dimensions		41.26 × 28.5 × 10.7 inches (1048 × 724.4 × 272 mm)
Weight		51.81 lbs. (23.5 kg)

Legal notices

FCC Part 15

This device complies with Part 15 of the FCC Rules. Operation of this product is subject to the following two conditions: (1) this device may not cause harmful interference, and (2) this device must accept any interference received, including interference that may cause undesired operation.

This equipment has been tested and found to comply within the limits for a class B digital device, pursuant to Part 15 of the FCC Rules. These limits are designed to provide reasonable protection against harmful interference in a residential installation. This equipment generates, uses, and can radiate radio frequency energy and, if not installed and used in accordance with the instructions, may cause harmful interference to radio communications. However, there is no guarantee that interference will not occur in a particular installation. If this equipment does cause harmful interference to radio or television reception, which can be determined by turning the equipment off and on, the user is encouraged to try to correct the interference by one or more of the following measures:

- Reorient or relocate the receiving antenna.
- Increase the separation between the equipment and receiver.
- Connect the equipment into an outlet on a circuit different from that to which the receiver is connected.
- Consult the dealer or an experienced technician for help.

One-year limited warranty

Insignia Products ("Insignia") warrants to you, the original purchaser of this new **NS-PDP42-09** ("Product"), that the Product shall be free of defects in the original manufacture of the material or workmanship for a period of one (1) year from the date of your purchase of the Product ("Warranty Period"). This Product must be purchased from an authorized dealer of Insignia brand products and packaged with this warranty statement. This warranty does not cover refurbished Product. If you notify Insignia during the Warranty Period of a defect covered by this warranty that requires service, terms of this warranty apply.

How long does the coverage last?

The Warranty Period lasts for 1 year (365 days) from the date you purchased the Product. The purchase date is printed on the receipt you received with the Product.

What does this warranty cover?

During the Warranty Period, if the original manufacture of the material or workmanship of the Product is determined to be defective by an authorized Insignia repair center or store personnel, Insignia will (at its sole option): (1) repair the Product with new or rebuilt parts; or (2) replace the Product at no charge with new or rebuilt comparable products or parts. Products and parts replaced under this warranty become the property of Insignia and are not returned to you. If service of Products or parts are required after the Warranty Period expires, you must pay all labor and parts charges. This warranty lasts as long as you own your Insignia Product during the Warranty Period. Warranty coverage terminates if you sell or otherwise transfer the Product.

How to obtain warranty service?

If you purchased the Product at a retail store location, take your original receipt and the Product to the store you purchased it from. Make sure that you place the Product in its original packaging or packaging that provides the same amount of protection as the original packaging. If you purchased the Product from an online web site, mail your original receipt and the Product to the address listed on the web site. Make sure that you put the Product in its original packaging or packaging that provides the same amount of protection as the original packaging.

To obtain in-home warranty service for a television with a screen 25 inches or larger, call 1-888-BESTBUY. Call agents will diagnose and correct the issue over the phone or will have an Insignia-approved repair person dispatched to your home.

Where is the warranty valid?

This warranty is valid only to the original purchaser of the product in the United States and Canada.

What does the warranty not cover?

This warranty does not cover:

- Customer instruction
- Installation
- Set up adjustments
- Cosmetic damage
- Damage due to acts of God, such as lightning strikes
- Accident
- Misuse
- Abuse
- Negligence
- Commercial use
- Modification of any part of the Product, including the antenna
- Plasma display panel damaged by static (non-moving) images applied for lengthy periods (burn-in).

This warranty also does not cover:

- Damage due to incorrect operation or maintenance
- Connection to an incorrect voltage supply
- Attempted repair by anyone other than a facility authorized by Insignia to service the Product
- Products sold as is or with all faults
- Consumables, such as fuses or batteries
- Products where the factory applied serial number has been altered or removed

REPAIR REPLACEMENT AS PROVIDED UNDER THIS WARRANTY IS YOUR EXCLUSIVE REMEDY. INSIGNIA SHALL NOT BE LIABLE FOR ANY INCIDENTAL OR CONSEQUENTIAL DAMAGES FOR THE BREACH OF ANY EXPRESS OR IMPLIED WARRANTY ON THIS PRODUCT, INCLUDING, BUT NOT LIMITED TO, LOST DATA, LOSS OF USE OF YOUR PRODUCT, LOST BUSINESS OR LOST PROFITS. INSIGNIA PRODUCTS MAKES NO OTHER EXPRESS WARRANTIES WITH RESPECT TO THE PRODUCT, ALL EXPRESS AND IMPLIED WARRANTIES FOR THE PRODUCT, INCLUDING, BUT NOT LIMITED TO, ANY IMPLIED WARRANTIES OF AND CONDITIONS OF MERCHANTABILITY AND FITNESS FOR A PARTICULAR PURPOSE, ARE LIMITED IN DURATION TO THE WARRANTY PERIOD SET FORTH ABOVE AND NO WARRANTIES, WHETHER EXPRESS OR IMPLIED, WILL APPLY AFTER THE WARRANTY PERIOD. SOME STATES, PROVINCES AND JURISDICTIONS DO NOT ALLOW LIMITATIONS ON HOW LONG AN IMPLIED WARRANTY LASTS, SO THE ABOVE LIMITATION MAY NOT APPLY TO YOU. THIS WARRANTY GIVES YOU SPECIFIC LEGAL RIGHTS, AND YOU MAY ALSO HAVE OTHER RIGHTS, WHICH VARY FROM STATE TO STATE OR PROVINCE TO PROVINCE.

Contact Insignia:

For customer service please call 1-877-467-4289

www.insignia-products.com

Distributed by Best Buy Purchasing, LLC

7601 Penn Avenue South, Richfield, Minnesota, U.S.A. 55423-3645

© 2008 Best Buy Enterprise Services, Inc.

All rights reserved. INSIGNIA is a trademark of Best Buy Enterprise Services, Inc. Registered in some countries. All other products and brand names are trademarks of their respective owners.

DYNEX™

ENGLISH 08-1151

www.dynexproducts.com (800) 305-2204

Distributed by Best Buy Purchasing, LLC
7601 Penn Ave. South, Richfield, MN 55423 U.S.A.

© 2008 Best Buy Enterprise Services, Inc. All rights reserved.

DYNEX is a trademark of Best Buy Enterprise Services, Inc. Registered in some countries. All other products and brand names are trademarks of their respective owners.

Free Manuals Download Website

<http://myh66.com>

<http://usermanuals.us>

<http://www.somanuals.com>

<http://www.4manuals.cc>

<http://www.manual-lib.com>

<http://www.404manual.com>

<http://www.luxmanual.com>

<http://aubethermostatmanual.com>

Golf course search by state

<http://golfingnear.com>

Email search by domain

<http://emailbydomain.com>

Auto manuals search

<http://auto.somanuals.com>

TV manuals search

<http://tv.somanuals.com>