



7" and 9" Dual-Screen Portable DVD Players

DX-D7PDVD and DX-D9PDVD

Before using your new product, please read these instructions to prevent any damage.

USER GUIDE

Download from Www.Somanuals.com. All Manuals Search And Download.

Dynex DX-D7PDVD and DX-D9PDVD Dual-Screen Portable DVD Players

Contents

Important safety instructions	3
Features	4
Package contents	4
DVD player (7" and 9")	4
Navigation controls	5
Monitor	6
Virtual remote control	7
Setting up your player	8
Connecting to AC power	8
Installing your player in a vehicle	8
Connecting to a 12V car power outlet	9
Connecting headphones	10
Connecting a TV or monitor	10
Using your player	11
Playing a DVD or audio CD	11
Controlling DVD or audio CD playback	11
Adjusting the volume	11
Viewing DVD information	12
Viewing audio CD information	13
Opening the DVD main menu	13
Selecting a viewing angle	13
Selecting an audio language	14
Enlarging the display image	14
Repeating a chapter, title, or DVD	15
Repeating a track or CD	15
Selecting a subtitle language	16
Viewing photos	16
Using the Setup menu	17
Troubleshooting	18
Maintaining	19
Cleaning your player	19
Handling discs	19
Cleaning discs	19
Specifications	19
Legal notices	20
90-Day limited warranty	21

Important safety instructions

- 1 Read these instructions.
- 2 Keep these instructions.
- 3 Heed all warnings.
- 4 Follow all instructions.
- 5 Do not use this apparatus near water.
- 6 Clean only with a dry cloth.
- 7 Do not block any ventilation openings. Install in accordance with the manufacturer's instructions.
- 8 Do not install near any heat sources such as radiators, heat registers, stoves, or other apparatus (including amplifiers) that produce heat.
- 9 Do not defeat the safety purpose of the polarized or grounding-type plug. The wide blade is provided for your safety. If the provided plug does not fit into your outlet, consult an electrician for replacement of the obsolete outlet.
- 10 Protect the power cord from being walked on or pinched particularly at plugs, convenience receptacles, and the point where they exit from the apparatus.
- 11 Only use attachments/accessories specified by the manufacturer.
- 12 Unplug this apparatus during lightning storms or when unused for long periods of time.
- 13 Refer all servicing to qualified service personnel. Servicing is required when the apparatus has been damaged in any way, such as power-supply cord or plug is damaged, liquid has been spilled or objects have fallen into the apparatus, the apparatus has been exposed to rain or moisture, does not operate normally, or has been dropped.
- 14 To reduce the risk of fire or electric shock, do not expose this device to rain, moisture, dripping, or splashing, and no objects filled with liquids, such as vases, shall be placed on it.
- 15 The AC adapter or vehicle charger are the disconnecting devices. The plugs must remain readily operable.

Features

Package contents

Your box should contain:

- 7" or 9" main DVD player
- 7" or 9" extra monitor
- Headrest mount (2)
- Carry bag
- Headphones (2)
- AC adapter
- Vehicle charger
- AV/DC cable
- AV cable
- *Quick Setup Guide*

DVD player (7" and 9")

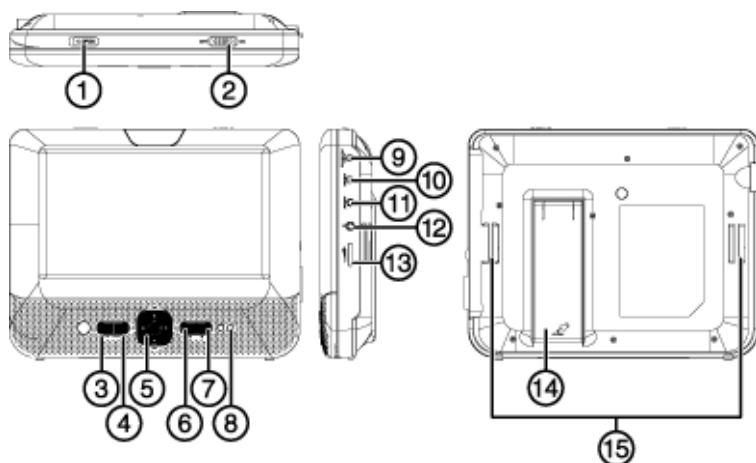

#	Component	Description
1	OPEN switch	Slide this switch (▲) to the left to open the disc tray.
2	ON/OFF switch	Slide to turn your DVD player on or off.
3	SETUP button	Press to open or close the <i>Setup</i> menu.
4	FUNC button	Press to enter or exit the virtual remote control.
5	Navigation controls	See "Navigation controls" on page 5.
6	▶ (play/pause) button	Press to begin playback. Press again to pause playback.

#	Component	Description
7	■ (Stop) button	Press to stop disc playback.
8	Power indicator	Lights when your player is powered and turned on.
9	DC IN jack	Connect the AC adapter or vehicle charger to this jack.
10	DC OUT jack	Connect the extra monitor to this jack using the AV/DC cable.
11	AV OUT jack	Connect the extra monitor to this jack using the AV/DC cable, or connect a remote monitor, TV, or amplifier to this jack using the supplied AV cable and an RCA cable (not supplied).
12	🎧 (headphone) jack	Plug headphones into this jack. Note: When headphones are plugged in, the internal speakers are muted.
13	+ [volume icon] (volume control)	Rotate this knob to adjust the volume.
14	Stand	Pull out to set up your player on a desktop or table.
15	Strap slots	Slide the mounting straps through these slots when installing the player in a vehicle.

Navigation controls

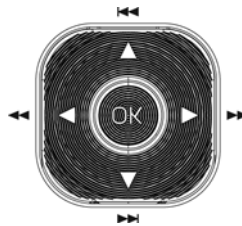

Control	Description
▲/⏪	In Menu mode, press to move up in a list or menu. In playback mode, press to go to the previous title, chapter, or track.
▼/⏩	In Menu mode, press to move down in a list or menu. In playback mode, press to go to the next title, chapter, or track.
◀/⏮	In Menu mode, press to move left. In playback mode, press to fast reverse the playback.
▶/⏭	In Menu mode, press to move right. In playback mode, press to fast forward the playback.
OK	In menu mode, press to confirm a selection.

Monitor

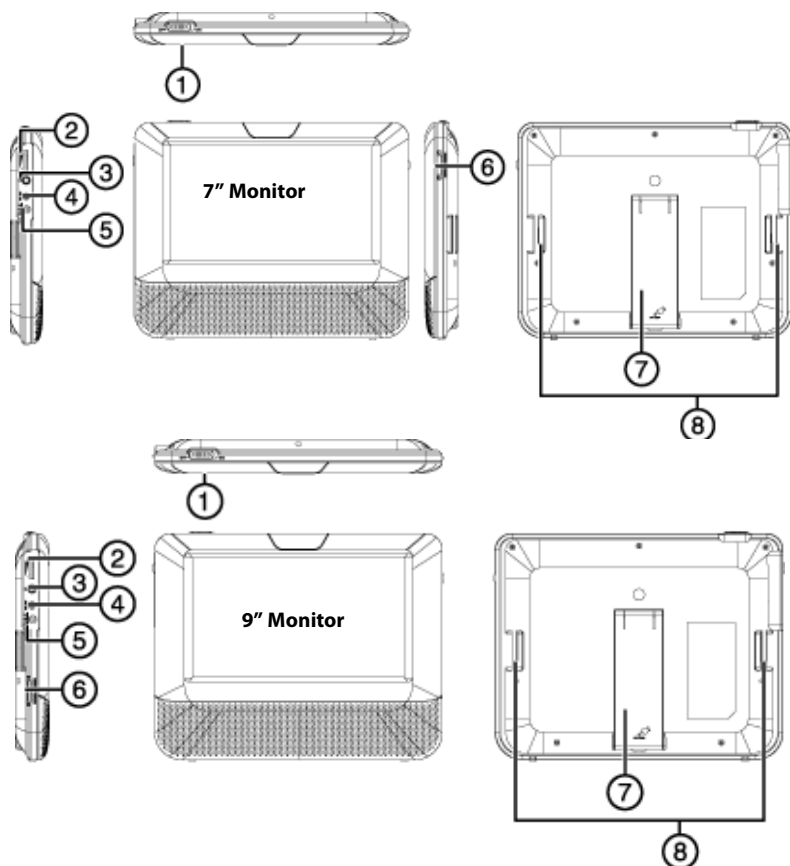

#	Component	Description
1	ON/OFF switch	Slide to turn the monitor on or off.
2	+ (volume control)	Rotate this knob to adjust the volume.
3	(headphone) jack	Plug headphones into this jack. Note: When headphones are plugged in, the speakers are muted.
4	AV IN jack	Connect the AV OUT jack on your DVD player to this jack using the AV/DC cable.
5	DC IN jack	Connect the DC OUT jack on your DVD player to this jack using the AV/DC cable.

#	Component	Description
6	Brightness +/-	Rotate this knob to adjust the brightness.
7	Stand	Pull out to set your player on a desk or table.
8	Strap slots	Slide the mounting straps through these slots when installing the player in a vehicle.

Virtual remote control

You must use the navigation control buttons on the player to navigate through the virtual remote control.

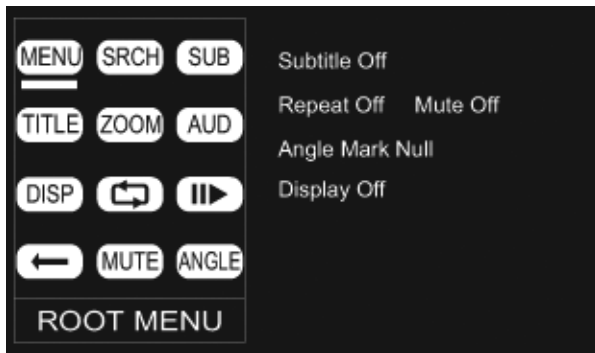

Virtual Button	Description
MENU	Select once to open the main DVD menu. This option works only if the DVD has a main menu. In the root menu, select FUNC. on the player to open the DVD title menu. This option works only if the DVD has a title menu.
SRCH (search)	Select to search the chapter, title, or track.
SUB (Subtitle)	Select to turn subtitles on and off, or select to select the subtitle language. This option works only if the DVD has subtitles.
TITLE	Select to display the DVD title information.
ZOOM	Select to enlarge the display image. You can enlarge the image 2, 3, or 4 times the normal size.
AUD (audio)	Select to select the DVD audio language. This option works only if the DVD has multiple audio languages.
DISP (display)	Select to display information about the disc, such as title, chapter number, track number, and time.
↻ (repeat)	Select to repeat the current title, chapter, or all.

Virtual Button	Description
▶▶ (slow)	Select repeatedly to slow the playing speed to 1/2, 1/4, 1/8, or 1/16 of normal.
◀ (return)	Select to return to the main menu.
MUTE	Select to mute the volume. Select again to unmute the volume.
ANGLE	Select to change the display angle. This option works only if the DVD has multiple display angles available.

Setting up your player

Connecting to AC power

To connect to AC power:

- Plug one end of the AC adapter into the **DC IN** jack on the side of your player, then plug the other end into an AC outlet.

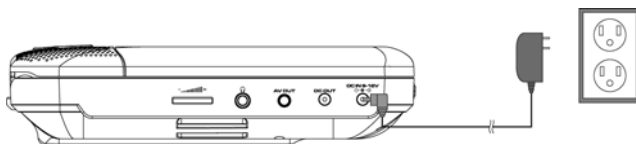

Installing your player in a vehicle

To install your player in a vehicle:

- 1 Loosen the straps of the mounting plate as shown below, fit the DVD player or monitor to the mount in "front" position.

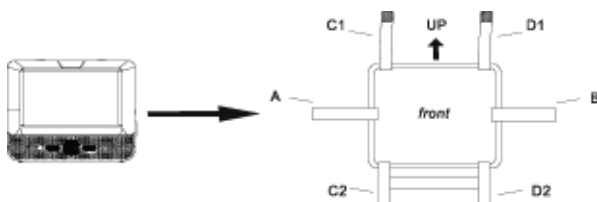

- 2 Slide the horizontal straps A and B through the slots on the back of the DVD player or monitor, then fold and secure them on to the back of the mounting plate until the Velcro attaches.

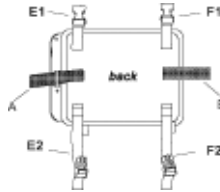

- 3 Bring straps C1, C2, D1, and D2 in front of the DVD player or monitor and attach to the Velcro as shown.



- 4 Fit the straps E1, E2, F1, and F2 around the headrest and secure the two buckles. Pull the straps tight as shown.

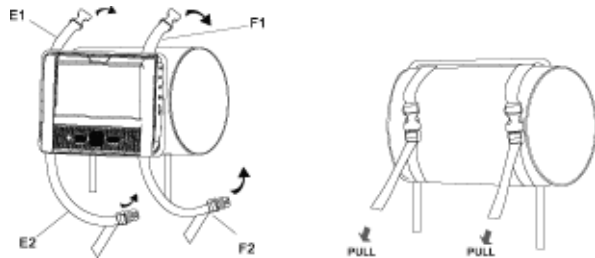

Connecting to a 12V car power outlet

To connect to a 12V car power outlet:

- 1 Plug one end of the vehicle charger into the **DC IN** jack on the side of your player.

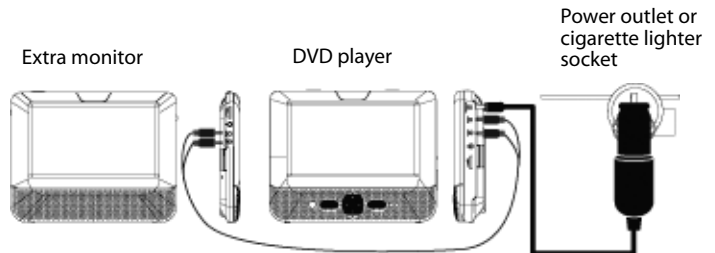

- 2 Plug the other end of the adapter into a 12V vehicle power outlet or vehicle cigarette lighter socket.
- 3 Using the AV/DC cable, connect the **AV OUT** and **DC OUT** jacks on the DVD player to the **AV IN** and **DC IN** jacks on the extra monitor.
- 4 Turn on your player.

Note

The vehicle charger cord is 5.9 feet (1.8 m) long.

Connecting headphones

To connect headphones:

- Plug headphones into the **Headphone** jack. When headphones are plugged into the **Headphone** jack, no sound comes from the built-in speakers.

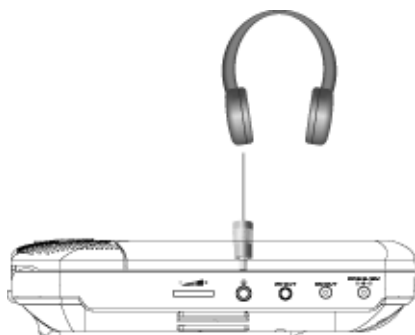

Connecting a TV or monitor

You can connect your player to a TV or monitor so you can watch DVDs or view photos on the TV or monitor.

To connect a TV or monitor:

- 1 Plug the end of the supplied AV cable that has one black connector into the **AV OUT** jack on your player.

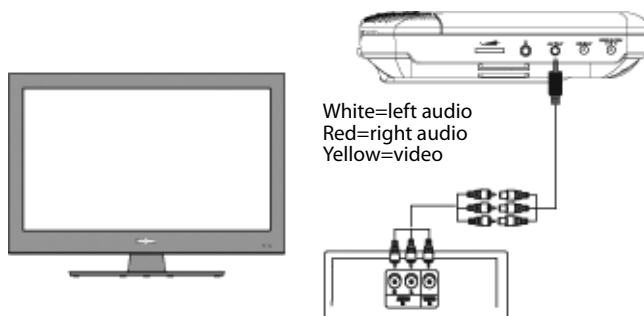

- 2 Plug the connectors on an RCA cable adapter (not included) into the connectors on the other end of the supplied AV cable. Make sure that the colors on the connectors match.
- 3 Plug the other end of the RCA cable into the **AV** jacks on the TV or monitor. The white connector goes into the left audio jack. The red connector goes into the right audio jack. The yellow connector goes into the video jack.

Using your player

Playing a DVD or audio CD

Note

Most DVDs and your player have region codes that help control illegal distribution of DVDs. The region code for your player is **1**. You can only play DVDs with a region code of **1**. The region code for a DVD is printed on the DVD or the DVD packaging.

To play a disc:

- 1 Make sure that your player is connected to power.
- 2 Slide the **ON/OFF** switch to the ON position.
- 3 Slide the **OPEN** switch. The disc tray opens. For the location of the **OPEN** switch, see "DVD player (7" and 9")" on page 4.
- 4 Place a disc, label side up, in the disc tray, then close the tray. The disc starts playing automatically.

Controlling DVD or audio CD playback

To control disc playback:

- Press **■(STOP)** once to stop playback. Your player remembers where you stopped. If you press **▶▶**, your player starts playing at the point where you stopped.
- Press **■(STOP)** twice to stop playback. If you press **▶▶**, your player starts playing at the beginning of the disc.
- Press **▶▶** to pause playback. Press this button again to resume playback.
- Press **▶▶▶** to fast-forward the disc. Each time you press this button, the fast-forward speed changes from 2 to 4 to 8 to 16 to 32 times the normal speed.
- Press **◀◀◀** to fast-reverse the disc. Each time you press this button, the fast-reverse speed changes from 2 to 4 to 8 to 16 to 32 times the normal speed.
- Press **▶▶ (NEXT)** to go to the next title, chapter, or track.
- Press **◀◀ (PREV)** to go to the previous title, chapter, or track.

Adjusting the volume

To adjust the volume:

- Rotate the volume control knob on the right side of your player.

Viewing DVD information

To view DVD information:

- 1 During playback, press **FUNC.** to enter the virtual remote control.
- 2 Move the cursor to **DISP** and press **OK**. The following display appears.

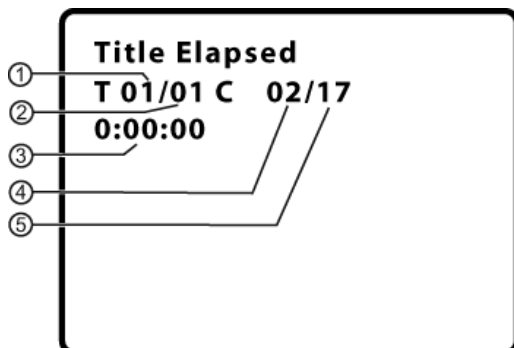

1	Current title number.
2	Total number of titles.
3	Elapsed playing time for the current title.
4	Current chapter number.
5	Total number of chapters.

- 3 Press **OK** one or more times to view specific DVD information when the panel says "press OK to display information."

You can view:

- **Title Elapsed**—Shows the elapsed playing time for the title.
- **Title Remain**—Shows the remaining playing time for the title.
- **Chapter Elapsed**—Shows the elapsed playing time for the chapter.
- **Chapter Remain**—Shows the remaining playing time for the chapter.
- **Display Off**—Turns off the information display.

Note

The information display automatically turns off if you do not press **OK** within eight seconds.

Viewing audio CD information

To view audio CD information:

- 1 During playback, press **FUNC.** to enter the virtual remote control.
- 2 Move the cursor to **DISP** and press **OK**. The following display appears.



- 3 Press **OK** one or more times to view specific DVD information when the panel says "press OK to display information."

You can view:

- **Single Elapsed**—Shows the currently playing track and the elapsed playing time for the track.
- **Single Remain**—Shows the currently playing track and the remaining playing time for the track.
- **Total Elapsed**—Shows the currently playing track and the elapsed playing time for the CD.
- **Total Remain**—Shows the currently playing track and the remaining playing time for the CD.

Note

The information display automatically turns off if you do not press **OK** within eight seconds.

Opening the DVD main menu

To open the DVD menu:

- 1 During playback, press **FUNC.** to enter the virtual remote control.
- 2 Move the cursor to **MENU**, then press **OK**. If the DVD has a main menu, the menu opens.

Note

Contents of DVD main menus vary from DVD to DVD. Some DVDs only let you start playback from the main menu.

Selecting a viewing angle

Some DVDs are recorded with multiple viewing angles for some scenes. When a scene has multiple viewing angles, the angle icon  appears on the screen.

To select a viewing angle:

- 1 Press **SETUP** to enter the *Setup* menu, then set **Angle Mark** to **ON**. See "Using the Setup menu" on page 17 for more information.

- 2 During playback, the angle display appears showing the current angle and the total number of angles. In the following example, the current angle is 1 and the total number of angles is 3.

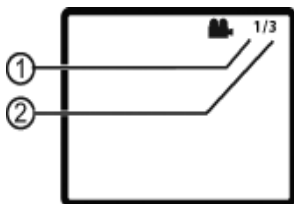

1	Current angle number.
2	Total number of angles.

- 3 Press **FUNC.** to enter the virtual remote control.
- 4 Move the cursor to **ANGLE** and press **OK** when the panel says "press OK to change viewing angle."

Selecting an audio language

Some DVDs are recorded with multiple audio languages.

Note

Some DVDs only let you select an audio language from the DVD main menu.

To select an audio language:

- 1 During playback, press **FUNC.** to enter the virtual remote control.
- 2 Move the cursor to **AUD** and press **OK**. The audio display appears showing the current audio language and the total number of audio languages available.
- 3 Press **OK** one or more times to select the audio language you want when the panel says "press OK to select language."

Enlarging the display image

To enlarge the display image:

- 1 During playback, press **FUNC.** to enter the virtual remote control.

- 2 Move the cursor to **ZOOM** and press **OK**. The following display appears.



1	Current amount of enlargement.
---	--------------------------------





- 3 Press **OK** one or more times to enlarge the image two, three, or four times when the panel says "press OK to enlarge image."
 4 Press **OK** a fourth time to return to normal viewing.

Repeating a chapter, title, or DVD

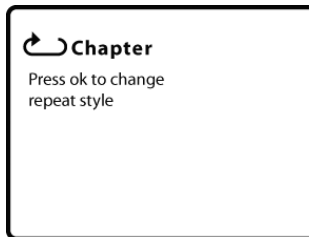
To repeat a chapter, title, or DVD:

- 1 During playback, press **FUNC.** to enter the virtual remote control.
 2 Move the cursor to  and press **OK**. The following display appears.



- 3 Press **OK** one or more times to select:
-  Chapter—Repeats the currently playing chapter.
 -  Title—Repeats the currently playing title.
 -  All—Repeats all the chapters and titles.
 -  Off—Turns off the repeat function.

Repeating a track or CD

To repeat a track or CD:

- 1 During playback, press **FUNC.** to enter the virtual remote control.
 2 Move the cursor to  and, when the panel says "press OK to repeat," press **OK** repeatedly to select:
- **Track**—Repeats the currently playing track.
 - **All**—Repeats the entire CD.
 - **Off**—Turns off the repeat function.

Selecting a subtitle language

Some DVDs are recorded with subtitle languages that appear as text on the screen.

To select a subtitle language:

- 1 During playback, press **FUNC.** to enter the virtual remote control.
- 2 Move the cursor to **SUB**, then press **OK**. The subtitle display appears showing the current subtitle language and the total number of subtitle languages. In the following example, the current subtitle language is 1 and the total number of subtitle languages is 2.

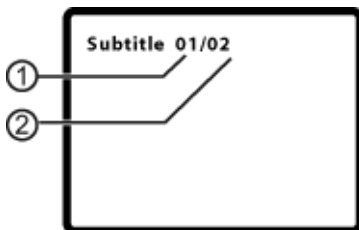

1	Current subtitle language number.
2	Total number of subtitle languages.

- 3 Press **OK** one or more times to select a different subtitle language when the panel says "press OK to select subtitle language."
- 4 To turn off subtitles, press **SUB** until **Subtitle Off** appears.

Notes

- The subtitle display turns off if you do not press **OK** within eight seconds.
- Some DVDs only let you select a subtitle language from the DVD main menu.



Viewing photos

You can view photos copied as JPEG files to a CD on your DVD player.

To view photos:

- 1 Insert the CD containing the photos into the disc tray. Your DVD player reads the CD and starts displaying the photos.
- 2 To control playback:
 - Press **◀◀** or **▶▶** and **OK** to select a JPEG file from the menu.
 - Press **◀◀** or **▶▶** to rotate the picture clockwise.
 - Press **▶▶** to reverse the picture horizontally and press **◀◀** to reverse the picture vertically.

To use the Function toolbar to view photos:

- 1 Press **FUNC.** The virtual toolbar opens.
- 2 Press **◀◀** or **▶▶** to select one of the following functions:
 -  –to return to the main menu.
 -  –To repeat one or all of the photos.
 -  –To zoom in or zoom out on the image.
- 3 Press **FUNC.** to exit the toolbar.

Using the Setup menu

Your player has a Setup menu you can use to adjust settings for your player.

To use the Setup menu:

- 1 Press **SETUP**. The *Setup Menu - Main Page* opens with **General Setup** highlighted.

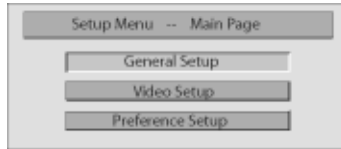

- 2 Press **◀◀** or **▶▶** to select the menu page you want, then press **OK**.
- 3 Press **▲** or **▼** to select an option.
- 4 Press **◀◀◀** or **▶▶▶** to change the setting, then press **OK** to confirm your selection.
- 5 Repeat Step 2 through Step 4 to change other menu options.
- 6 Press **SETUP** to exit.

Setup menu pages

Page	Options
General Setup Page	<p>TV Display—Selects the aspect ratio. You can select:</p> <ul style="list-style-type: none"> • Normal/PS—Select this option when the player is connected to a normal TV (4:3 aspect ratio). Wide-screen images are shown on the screen, but with some parts cropped automatically. • Normal/LB—Select this when the player is connected to a normal TV (4:3 aspect ratio). Wide-screen images are shown on the screen with a black band on the top and bottom. • Wide displays the video image full-screen when your player is connected to a widescreen TV (16:9 aspect ratio). <p>Angle Mark—If this option is turned on and the DVD you are watching has multiple viewing angles, the icon appears in scenes that have multiple viewing angles.</p> <p>OSD Language—Selects the language for the <i>Setup</i> menu. You can select English, French, or Spanish.</p> <p>Screen Saver—When this option is turned on, your player displays a screen saver when the same image stays on the screen for five minutes.</p> <p>Last Memory—When this option is turned on and you open the disc tray, your player remembers where you stopped. If you close the tray with the same disc loaded, your player starts playing at the point where you stopped.</p>
Video Setup Page	<p>TV Type—Selects the TV type. Options are PAL (typically Europe) or NTSC (typically USA). The default is NTSC.</p> <p>Panel Quality—Select to adjust the following:</p> <ul style="list-style-type: none"> • Brightness—Increases the brightness to add more light to dark areas of the picture or decreases the brightness to add more dark to light areas of the picture. • Contrast—Increases the picture level to adjust the white areas of the picture or decreases the picture level to adjust the black areas of the picture. • Hue—Increases the color level to add more green to skin tones or decreases the color level to add more purple to skin tones. • Saturation—Adjusts the color saturation.

Page	Options
Preference Page	<p>Audio—Selects the audio language. If the language you select is not recorded on the DVD, your player plays the default audio language.</p> <p>Subtitle—Select the subtitle language. If the language you select is not recorded on the DVD, your player displays the default subtitle language.</p> <p>Disc Menu—Selects the DVD menu language. If the language you select is not recorded on the DVD, your player displays the default language.</p> <p>Parental—Blocks DVD playback based on ratings. Select this option to set the parental control level. Options include: KID SAFE, G, PG, PG 13, PGR, R, Nc17, and ADULT. The default is ADULT. The password is pressing FUNC. four times.</p> <p>Default—Reset all settings except the password and parental controls back to the factory default.</p>

Troubleshooting

Problem	Solution
No sound or distorted sound.	<ul style="list-style-type: none"> Adjust the volume. Make sure that headphones are not plugged in. When headphones are plugged in, the internal speakers are turned off. Make sure that all cables are inserted correctly into the appropriate jacks.
Cannot fast-forward or fast-reverse through a movie.	<ul style="list-style-type: none"> You cannot fast-forward through opening credits and warning information at the beginning of a movie. Some DVDs do not allow rapid scanning or skipping of titles or chapters.
The  (do not) icon appears on the screen.	<p>The action you tried cannot be done because:</p> <ul style="list-style-type: none"> The DVD software does not allow it. The DVD does not support the feature (for example the Subtitle feature). The feature is not available at the current point on the DVD. You entered a title or chapter number that is out of range.
Picture is distorted.	<ul style="list-style-type: none"> During fast-forwarding or fast-reversing, distortion is normal. The DVD may be damaged. Try another DVD.
Disc does not play.	<ul style="list-style-type: none"> Make sure that the disc is inserted with the label side up. Make sure that the disc is compatible with your player. Your player can play DVDs and audio CDs.
Play starts, then stops immediately.	<ul style="list-style-type: none"> Make sure that the region code for a DVD matches the region code for your player. Your player's region code is 1. The DVD's region code is on the DVD or the DVD packaging. Make sure that the disc is not dirty. If condensation has formed inside your player, let your player dry out.

Maintaining

Cleaning your player

Clean the outside of your player with a clean cloth, slightly dampened with water.

Caution

Do not use liquid cleaners or aerosol cleaners because they may damage your player.

Handling discs

Discs

- Do not touch the surface of a disc. Handle a disc by its edge.
- Do not attach paper or tape to the disc.



- Do not use irregularly shaped discs, such as heart-shaped or star-shaped discs, because they may cause your player to malfunction.
- Do not expose a disc to direct sunlight or heat sources.
- Clean a disc by wiping the disc from the center out with a cleaning cloth.
- Remove a disc from your player and store it in its case after playing.
- Some playback operations of discs may be intentionally limited by software producers. Because your player plays discs according to the disc contents the software producers designed, some playback features may not be available. Also refer to the instructions supplied with the discs.

Cleaning discs

- Before playback, wipe the disc outwards from the center with a clean cloth.



Specifications

Specifications subject to change without notice.

Compatible discs	DVDs (Region 1) and CDs (non-MP3)
Signal system	PAL or NTSC
LCD	7 inches or 9 inches

Frequency response	20 Hz to 20 kHz
Audio S/N	Better than 60 dB
Dynamic range	Better than 80 dB
Laser	Semiconductor
Wave length	650 nm/795 nm
Power source	DC 9 V-12 V
Operating temperature	32° to 104°F (0° to 40°C)
Weight	7" DVD player: 1.31 lbs. (0.594 kg) Extra monitor: 0.75 lbs. (0.340 kg) 9" DVD player: 1.79 lbs. (0.814 kg) Extra monitor: 1.09 lbs. (0.498 kg)
Dimensions (W × H × D)	7" DVD player: 8.35 × 6.58 × 1.58 in. (212 × 167 × 40 mm) Extra monitor: 8.35 × 6.58 × 0.98 in. (212 × 166.5 × 25 mm) 9" DVD player: 9.73 × 7.55 × 1.65 in. (247 × 191.6 × 41.9 mm) Extra monitor: 9.71 × 7.55 × 1.18 in. (246.5 × 191.6 × 30 mm)

Legal notices

FCC Part 15

This device complies with Part 15 of the FCC Rules. Operation of this product is subject to the following two conditions: (1) this device may not cause harmful interference, and (2) this device must accept any interference received, including interference that may cause undesired operation.

This equipment has been tested and found to comply within the limits for a class B digital device, pursuant to Part 15 of the FCC Rules. These limits are designed to provide reasonable protection against harmful interference in a residential installation. This equipment generates, uses, and can radiate radio frequency energy and, if not installed and used in accordance with the instructions, may cause harmful interference to radio communications. However, there is no guarantee that interference will not occur in a particular installation. If this equipment does cause harmful interference to radio or television reception, which can be determined by turning the equipment off and on, the user is encouraged to try to correct the interference by one or more of the following measures:

- Reorient or relocate the receiving antenna.
- Increase the separation between the equipment and receiver.
- Connect the equipment into an outlet on a circuit different from that to which the receiver is connected.
- Consult the dealer or an experienced radio/TV technician for help.

FCC warning

Changes or modifications not expressly approved by the party responsible for compliance with the FCC Rules could void the user's authority to operate this equipment.

Canada ICES-003

This Class B digital apparatus complies with Canadian ICES-003. Cet appareil numérique de la classe B est conforme à la norme NMB-003 du Canada.

Dolby License Notice and Trademark Acknowledgement

Manufactured under license from Dolby Laboratories. Dolby and the double-D symbol are trademarks of Dolby Laboratories.

90-Day limited warranty

Dynex Products ("Dynex") warrants to you, the original purchaser of this new **DX-D7PDVD** or **DX-D9PDVD** ("Product"), that the Product shall be free of defects in the original manufacture of the material or workmanship for a period of 90 days from the date of your purchase of the Product ("Warranty Period"). This Product must be purchased from an authorized dealer of Dynex brand Products and packaged with this warranty statement. This warranty does not cover refurbished product. If you notify Dynex during the Warranty Period of a defect covered by this warranty that requires service, terms of this warranty apply.

How long does the coverage last?

The Warranty Period lasts for 90 days from the date you purchased the Product. The purchase date is printed on the receipt you received with the Product.

What does this warranty cover?

During the Warranty Period, if the original manufacture of the material or workmanship of the Product is determined to be defective by an authorized Dynex repair center or store personnel, Dynex will (at its sole option): (1) repair the Product with new or rebuilt parts; or (2) replace the Product at no charge with new or rebuilt comparable products or parts. Products and parts replaced under this warranty become the property of Dynex and are not returned to you. If service of products and parts are required after the Warranty Period expires, you must pay all labor and parts charges. This warranty lasts as long as you own your Dynex Product during the Warranty Period. Warranty coverage terminates if you sell or otherwise transfer the Product.

How to obtain warranty service?

If you purchased the Product at a retail store location, take your original receipt and the Product to the store you purchased it from. Make sure that you place the Product in its original packaging or packaging that provides the same amount of protection as the original packaging. If you purchased the Product from an online web site, mail your original receipt and the Product to the address listed on the web site. Make sure that you put the Product in its original packaging or packaging that provides the same amount of protection as the original packaging.

To obtain in-home warranty service for a television with a screen 25 inches or larger, call 1-888-BESTBUY. Call agents will diagnose and correct the issue over the phone or will have an Dynex-approved repair person dispatched to your home.

Where is the warranty valid?

This warranty is valid only to the original purchaser of the Product in the United States, Canada, and Mexico.

What does the warranty not cover?

This warranty does not cover:

- Customer instruction
- Installation
- Set up adjustments
- Cosmetic damage
- Damage due to acts of God, such as lightning strikes
- Accident
- Misuse
- Abuse
- Negligence
- Commercial use
- Modification of any part of the Product
- Plasma display panel damaged by static (non-moving) images applied for lengthy periods (burn-in).

This warranty also does not cover:

- Damage due to incorrect operation or maintenance
- Connection to an incorrect voltage supply
- Attempted repair by anyone other than a facility authorized by Dynex to service the Product
- Products sold as is or with all faults
- Consumables, such as fuses or batteries
- Products where the factory applied serial number has been altered or removed

REPAIR REPLACEMENT AS PROVIDED UNDER THIS WARRANTY IS YOUR EXCLUSIVE REMEDY. DYNEX SHALL NOT BE LIABLE FOR ANY INCIDENTAL OR CONSEQUENTIAL DAMAGES FOR THE BREACH OF ANY EXPRESS OR IMPLIED WARRANTY ON THIS PRODUCT, INCLUDING, BUT NOT LIMITED TO, LOST DATA, LOSS OF USE OF YOUR PRODUCT, LOST BUSINESS OR LOST PROFITS. DYNEX PRODUCTS MAKES NO OTHER EXPRESS WARRANTIES WITH RESPECT TO THE PRODUCT, ALL EXPRESS AND IMPLIED WARRANTIES FOR THE PRODUCT, INCLUDING, BUT NOT LIMITED TO, ANY IMPLIED WARRANTIES OF AND CONDITIONS OF MERCHANTABILITY AND FITNESS FOR A PARTICULAR PURPOSE, ARE LIMITED IN DURATION TO THE WARRANTY PERIOD SET FORTH ABOVE AND NO WARRANTIES, WHETHER EXPRESS OR IMPLIED, WILL APPLY AFTER THE WARRANTY PERIOD. SOME STATES, PROVINCES AND JURISDICTIONS DO NOT ALLOW LIMITATIONS ON HOW LONG AN IMPLIED WARRANTY LASTS, SO THE ABOVE LIMITATION MAY NOT APPLY TO YOU. THIS WARRANTY GIVES YOU SPECIFIC LEGAL RIGHTS, AND YOU MAY ALSO HAVE OTHER RIGHTS, WHICH VARY FROM STATE TO STATE OR PROVINCE TO PROVINCE.

Contact Dynex:

For customer service please call 1-800-305-2204
www.dynexproducts.com

Distributed by Best Buy Purchasing, LLC
7601 Penn Avenue South, Richfield, Minnesota, U.S.A. 55423-3645
© 2013 BBY Solutions, Inc.

All rights reserved. DYNEX is a trademark of BBY Solutions, Inc. Registered in some countries. All other products and brand names are trademarks of their respective owners.

DYNEX™

www.dynexproducts.com (800) 305-2204

Distributed by Best Buy Purchasing, LLC
7601 Penn Ave. South, Richfield, MN 55423 U.S.A.
© 2013 BBY Solutions, Inc. All rights reserved.

DYNEX is a trademark of BBY Solutions, Inc. Registered in some countries.
All other products and brand names are trademarks of their respective owners.

V2 ENGLISH 12-1341

Free Manuals Download Website

<http://myh66.com>

<http://usermanuals.us>

<http://www.somanuals.com>

<http://www.4manuals.cc>

<http://www.manual-lib.com>

<http://www.404manual.com>

<http://www.luxmanual.com>

<http://aubethermostatmanual.com>

Golf course search by state

<http://golfingnear.com>

Email search by domain

<http://emailbydomain.com>

Auto manuals search

<http://auto.somanuals.com>

TV manuals search

<http://tv.somanuals.com>