

# 4CH Digital Video Recorder

## INSTRUCTION MANUAL

MODEL: CDR 0440

Ver. 160410



# SAFETY PRECAUTIONS



## EXPLANATION OF SYMBOLS



This symbol is intended to alert the user to the presence of important operation and maintenance (servicing) instructions in the literature accompanying the appliance.



This symbol is intended to alert the user to the presence of unprotected "dangerous voltage" within the product's enclosure that may be strong enough to cause a risk of electric shock persons.

### WARNING

To reduce a risk of fire or electric shock, do not expose this product to rain or moisture.

### CAUTION

Changes or modifications not expressly approved by the manufacturer may void the user's authority to operate this equipment.

### CAUTION

Danger of explosion if battery is incorrectly replaced.

Replace only with the same or equivalent type recommended by the manufacturer.

**The bellow safety precautions must be followed.**



**WARNING**

- Do not use if the unit emits smoke, strange sounds is heard, or odor is emitted.
- Make sure the power cable is not damaged.
- Make sure there is no dust accumulation on the power plug or the outlet.
- Disassembly prohibited
- Do not place any foreign objects inside the unit.
- Do not place a container holding water or other liquids above the unit when it is connected to power.
- Do not allow the unit to get wet.
- Do not use during thunder/thunder storms.
- Do not place in an unstable position.
- Do not expose to shock or vibration.
- Do not use this unit in areas where it is exposed to the possibility of explosion.



**CAUTION**

- Do not pull on the power cable when removing the power plug from the outlet.
- Do not touch the power plug with wet hands.
- Do not sit on.
- Make sure the cables are connected properly.
- Do not place heavy objects on connected units.
- Never move this unit while the power is turned on.
- Do not block the cooling fans or air ducts.
- Do not expose to extreme temperatures or humidity changes.

## Precautions for supplied AC Adaptor



### CAUTION

- Never disassemble or modify.
- Never get the adaptor wet.



### CAUTION

- Use only the supplied AC adapter.
- Do not connect to other appliances.
- Do not connect this unit with the AC adapter in areas reachable to children or where pets move freely.
- Never touch the AC adapter with wet hands.
- If the unit emits smoke, strange sounds or smells immediately remove the AC adapter from the outlet.
- Do not use during thunder/thunder storms.



### CAUTION

- Make sure the cable is connected properly.
- Preventing damage to a cable

# Main features

- H.264 Video compression



- TRIPLEX operation (recording, playback, and networking)

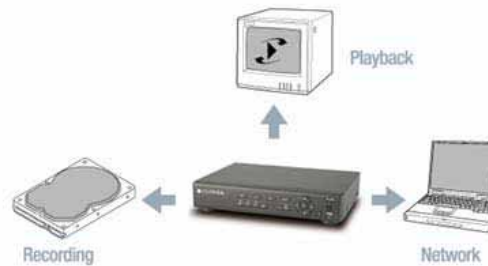

- Instant and convenient data backup & firmware upgrade using USB flash drive
- Simple user interface

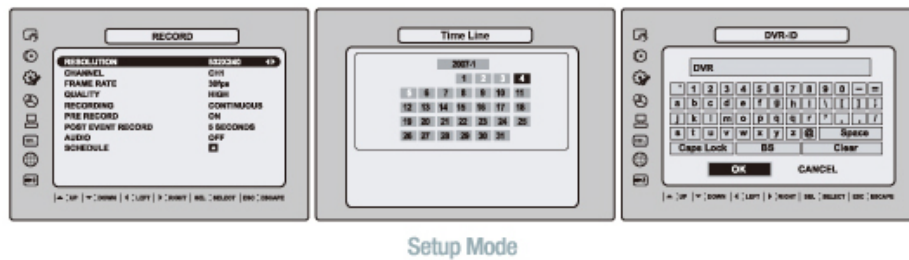

- Individual channel setting and operation
- Motion detection

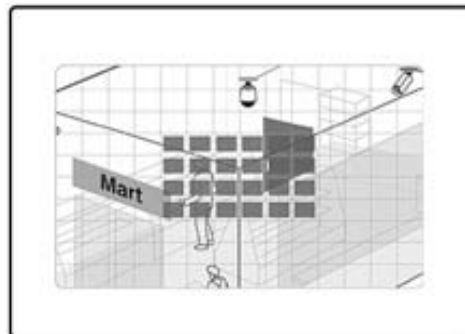

# System components and Installation

## Requirements for installation and safety

This chapter is for the requirements for safe installation and use.

This kit should be installed on a flat table or in a rack.

The location in which the DVR is installed in the room is very important for proper operation of the system.

When the DVR is installed too closely together or the location is poorly ventilated, the DVR may not operate properly and maintenance of the DVR may be difficult. Make sure that the air should be sufficiently circulated within the system operating room and the cover of the main system must be tightly fastened to prevent malfunction.

There are high voltage parts inside. Do not open the cover during operation.

The DVR must be installed in a place that meets the following environmental conditions.

- Operating temperature: 5°C ~ 40°C (41°F ~ 104°F)
- Operating humidity: 30% ~ 90% RH
- Input voltage: DC +12V 5A
- Power usage: About 25Watts
- Frequency: 60Hz/50Hz

## Main replacement parts

- Hard disk (When HDD is factory-installed.): 1 year (25°C environment)
- Cooling fan: 1 year (25°C environment)
- Battery: 2 years (25°C environment)

### CAUTION

During the operation of this product, the fluctuation of input voltage must be within 10% of the rated voltage and the external power outlet must be grounded, otherwise, it may cause electric shock or malfunction of the product.

Do not connect heat-generating appliances to the same power outlet in which the product is plugged, otherwise it may cause a fire or malfunction of the product.











The use of an Automatic Voltage Regulator (AVR) is highly recommended to ensure that stable power is supplied.

### CAUTION

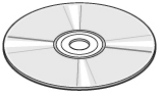
HDD that is installed in DVR can be changed with a new one. However we guarantee that the new HDD must be the same brand and model.

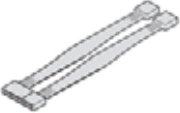
# Components of DVR Package

The package contains the main unit and its components as specified below. When you purchase the package, please check to ensure the components specified below are included.

DVR Set	
Remote Control	
Battery 1.5V (AAA x 2EA)	
Adaptor and Power cable	
Client Software CD	
User Guide	
HDD Power & SATA Cable	
HDD Screws	
Audio Cable (for 16ch)	
Mouse (Option)	

## Basic function of the MOUSE



① : Left button: SELECT function

② : Right button: ESC function

① : Double click: Go to sub menu

## Mounting the HARD DISK

1. Unfasten the cover of the unit.

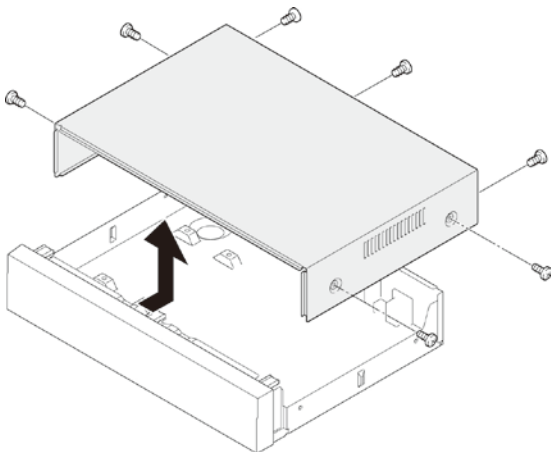

2. Fix the supplied HDD mounting bracket to the hard disk using the supplied mounting bracket screws.
3. Connect the supplied SATA cable and power cable to the hard disk and fix the hard disk to the unit using the supplied HDD fixing screws.

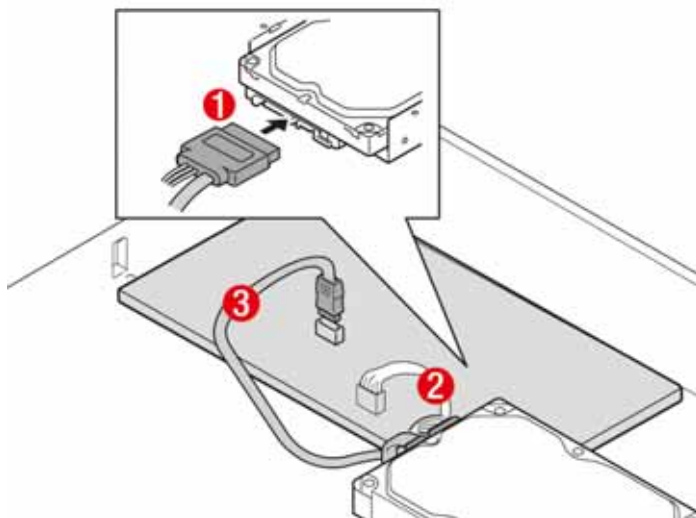



# SPECIFICATIONS

ITEM		4CH	8CH	16CH	
	Channel, Input Level	4CH, Composite	8CH, Composite	16CH, Composite	
	Input	Signal Format	NTSC/PAL		
Video		Video Loss Check	Yes		
	Output	Main Monitor Output	1 CH BNC, 1CH VGA: Selectable		
		Signal Format	NTSC/PAL & VGA		
Audio		Input & Output	4 CH Line input & 1 CH Line output		
		Audio Codec	G.711(ADPCM)		
Alarm		Sensor Input ((NC/NO Selectable)	4	4	4
		Alarm Output	1 Alarm out by Alarm, Motion, Video Loss		
		Compression	H.264		
		Multi-operation	TRIPLEX (Playback/Record/Network)		
			352x240	352x240	352x240
		NTSC	-	704x240	704x240
	Resolution		704x480	704x480	704x480
			352x288	352x288	352x288
Record		PAL	-	704x288	704x288
			704x576	704x576	704x576
		Recording quality grade	NETWORK, ECONOMY, NORMAL, HIGH, FINE.		
		Recording Mode	Continuous / Schedule / Motion/ Sensor/ Manual		
		Motion Detection	Motion detection setup by Grid		
		Pre Recording	1 fps for 5 seconds before an event		
		Post Recording	10 seconds to 3 minutes after an event		
Display		Frame Rate ( /Sec)	NTSC: 30fps/ch, 60 fields / PAL: 25fps/ch, 50 fields		
		Multi-Decoding	1, 4	1, 4, 9	1, 4, 9, 16
Playback	Playback Speed	Single channel	× 2, 4, 8		
		Multi-channels	× 2, 4		
		Search Mode	Timeline, Event, Archive, Log		
		Interface Type	Serial ATA I		
	HDD	Max. Capacity of 1 HDD	1TB		
Storage		Internal HDD Number	1	1	1
		File system	NaFS		
	Backup	USB Flash drive	Video & Still Image		
		Network	Video & Still Image		
		Menu Display	GUI		
User I/F		Input Method	Front buttons, Remote control, Mouse Control		
		PTZ control & Keyboard DVR control	1 RS-485		

	Termination	Yes
	Dynamic DNS	Yes (Free DDNS)
Network	Network Interface	10/100 base-TX Ethernet (RJ-45)
Network	Client Software (1:1)	Live, Search, Backup, PTZF Camera Control
Access	Web viewer (1:1)	Live, Search, Backup, PTZF Camera Control
	Multi-sites Monitoring System (1:n)	Live, Search, Backup, PTZF Camera Control
	DLS (Day Light Saving)	Yes
	Internal Beep	By Alarm, Motion, Video Loss, HDD error
Features	Multi-Language	Yes
	S/W Upgrade	USB Flash drive
	Water - mark	Yes (Exclusive viewer)
Power	Power	DC 12V 3A(for 4CH), DC 12V 5A(for 8,16CH)
Weight	Unit Weight (Gross weight)	1.6 Kgs (3.1 Kgs) / 3.5 Lbs (6.8 Lbs)
Dimension	Unit Dimension (W x H x D)	340 mm x 262 mm x 63 mm / 13.4" x 10.3" x 2.5"

## Compatible HDD Models

<b>Seagate</b>	ST31000340SV(Surveillance)	1 TB	7200 RPM	32 MB
<b>Seagate</b>	ST3500830SCE	500 GB	7200 RPM	8 MB
<b>Seagate</b>	ST3250410AS(Barracuda)	250 GB	7200 RPM	16 MB
<b>Seagate</b>	ST3250310SV(Surveillance)	250 GB	7200 RPM	8 MB
<b>Seagate</b>	ST3160815AS(Barracuda)	160 GB	7200 RPM	8 MB
<b>Seagate</b>	ST3500418AS(Barracuda)	500 GB	7200 RPM	16 MB
<b>Seagate</b>	ST3500410AS(Barracuda)	500 GB	7200 RPM	16 MB
<b>Seagate</b>	ST3250318AS(Barracuda)	250 GB	7200 RPM	8 MB
<b>Seagate</b>	ST3100528AS(Barracuda)	1 TB	7200 RPM	32 MB
<b>HITACHI</b>	HDS721010KLA330	1 TB	7200 RPM	32 MB
<b>HITACHI</b>	HDS721050CLA362	500 GB	7200 RPM	16 MB
<b>HITACHI</b>	HDP725050GLA360	500 GB	7200 RPM	16 MB
<b>HITACHI</b>	HDS721032CLA362	320 GB	7200 RPM	16 MB
<b>HITACHI</b>	HDT721025SLA380	250 GB	7200 RPM	8 MB
<b>HITACHI</b>	HDS721025CLA382	250 GB	7200 RPM	8 MB
<b>HITACHI</b>	HDP725025GLA380	250 GB	7200 RPM	8 MB
<b>HITACHI</b>	HDT721010SLA360	1 TB	7200 RPM	16 MB
<b>Western Digital</b>	WD10EACS	1 TB	7200 RPM	16 MB
<b>Western Digital</b>	WD5000AACS	500 GB	7200 RPM	16 MB
<b>Western Digital</b>	WD2500AAKS	250 GB	7200 RPM	16 MB

**<NOTICE>** The brands and models of all HDD should be the same. If the brands and models of each HDD are different with others, the DVR may not recognize HDD.

# INDEX

<b>1. NAME &amp; FUNCTION .....</b>	<b>14</b>
1-1. Front panel .....	14
1-2. Remote control .....	15
1-3. Rear panel and connection.....	16
1-4. Selecting the type of monitor (TV monitor and VGA monitor).....	19
<b>2. SETTING UP THE DVR.....</b>	<b>20</b>
2-1. Setup – Main Screen .....	20
2-2. Setup – Display Mode .....	22
2-3. Setup – Recording Mode .....	24
2-3-1. Recording Schedules .....	26
2-4. Setup – Device Mode.....	26
2-4-1. ALARM-OUT.....	28
2-4-2 PTZ Setup.....	28
2-4-3. Motion Zone Setup.....	29
2-5. Setup – Storage Mode.....	30
2-6. Setup – System Mode .....	31
2-7. Setup – SECURITY Mode.....	34
2-8. Setup – Network Mode.....	36
2-8-1. Ports .....	37
2-8-2. Network Types .....	38
2-8-2-1. LAN.....	38
2-8-2-2. DHCP.....	39
2-8-2-3. ADSL (PPPoE) .....	39

2-8-3. Saving Setup of Network setup .....	39
2-9. Setup - CONFIG Mode .....	40
<b>3. SAVING SETUP .....</b>	<b>42</b>
<b>4. LIVE, SEARCH, AND PLAYBACK.....</b>	<b>42</b>
4-1. Live Viewing Screen .....	42
4-2. SEARCH Screen .....	45
4-2-1. TIME-LINE Search .....	46
4-2-2. Event Search.....	46
4-2-3. Go To First Time .....	47
4-2-4. Go To Last Time .....	47
4-2-5. Go To Specific Time .....	47
4-2-6. Log Search.....	48
4-2-7. Archive Search .....	48
4-3. Play mode.....	49
<b>5. PTZ CONTROL .....</b>	<b>50</b>
<b>6. BACK UP .....</b>	<b>52</b>
6-1. Still Image backup onto USB flash memory .....	52
6-2. Video backup onto USB flash memory .....	52
6-3. Transferring still images or video from the ARCHIVE list.....	53
6-4. Playback of Backup Video.....	54
<b>7. UPGRADING FIRMWARE .....</b>	<b>55</b>
<b>8. NETWORK ACCESS USING THE EXCLUSIVE NETWORK VIEWER .....</b>	<b>56</b>
8-1. PC requirements.....	56

<b>8-2. Installing the network viewer .....</b>	<b>56</b>
<b>8-3. Live monitoring mode and functions. ....</b>	<b>57</b>
<b>8-4. Bi directional audio .....</b>	<b>59</b>
<b>8-5. Remote search mode and functions .....</b>	<b>59</b>
<b>8-6. PC System configuration.....</b>	<b>62</b>
<b>9. NETWORK – BY AN WEB-BROWSER VIEWER .....</b>	<b>64</b>
<b>10. NETWORK – BY MOBILE PHONE VIEWER.....</b>	<b>66</b>
<b>APPENDIX: HOW TO CONNECT NETWORK.....</b>	<b>68</b>
<b>A. How to set IP address of the DVR and open TCP port of the router? .....</b>	<b>68</b>
<b>B. How to access DVR from Remote PC? .....</b>	<b>70</b>

# 1. NAME & FUNCTION

## 1-1. Front panel

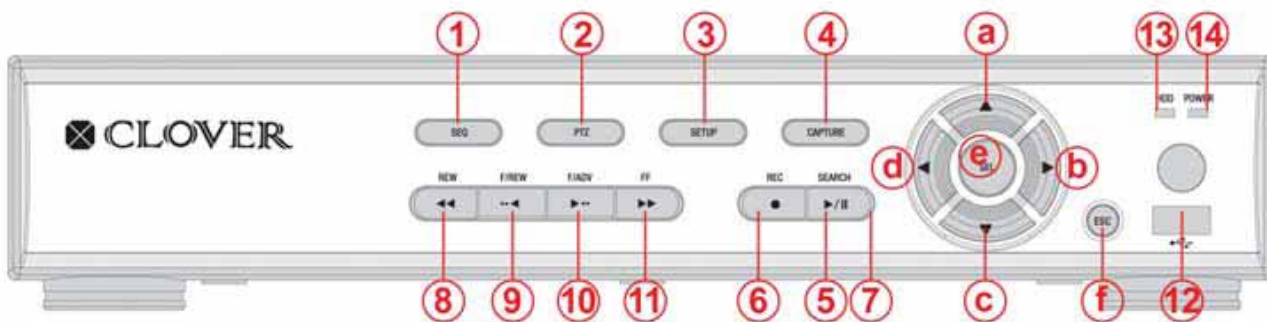

- 
- ① **SEQ:** To start auto sequencing of the screen in full screen mode. (Toggle)
  - ② **PTZ:** To control PTZ operation
  - ③ **SETUP:** To launch SETUP menu.
  - ④ **CAPTURE:** To start operations of backup in live or playback mode.
  - ⑤ **SEARCH:** To go to the search menu.
  - ⑥ **REC:** To start and stop manual recording.
  - ⑦ **PLAY/PAUSE:** To play or to pause the footage in playback mode.
  - ⑧ **REW:** To rewind the footage at 1x, 2x, 4x, and 8x speed during playback.
  - ⑨ **F/REW :** **During playback** - To move the playback position 60 seconds backward.  
**During pause** - To move the playback position 1 frame backward.
  - ⑩ **F/ADV:** **During playback** - To move the playback position 60 seconds forward.  
**During pause** - To move the playback position moves 1 frame forward.
  - ⑪ **FF:** To fast forward the footage at 1x, 2x, 4x, and 8x speeds during playback.
  - ⑫ **USB port:** To connect USB Thumb drive to backup data.
  - ⑬ **HDD:** The indicator blinks during recording and playback.
  - ⑭ **POWER:** The indicator blinks when the AC adaptor is connected.

### Direction button

#### During setting

- a To move the cursor Upward.
- b To move the cursor to the Right or to change the setting values.
- c To move the cursor Down.
- d To move the cursor to the Left or to change the setting values.

#### During Live/playback & Entering password

- a To select camera 1 or To enter No. 1
- b To select camera 2 or To enter No. 2.
- c To select camera 3 or To enter No. 3.
- d To select camera 4 or To enter No. 4.
- e To select full screen or quad screen view in live/playback or To select desired menu item or to store the setup value.
- f To return to previous menu screen or To exit from playback.

## 1-2. Remote control

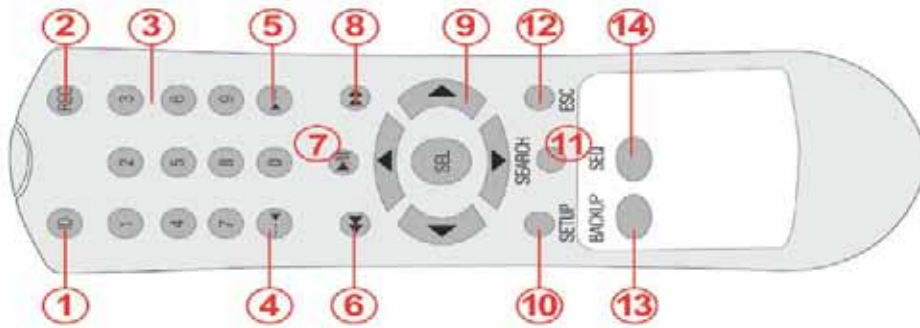

- 
- ① **ID:** When a remote control ID number is set in DVR, press it before number.
  - ② **REC:** To start and stop manual recording.
  - ③ **Number:** To select channel (1, 2, 3, & 4) or to enter DVR ID number.
  - ④ **F/REW:** **During playback** - To move the playback position 60 seconds backward.  
**During pause** - To move the playback position 1 frame backward.
  - ⑤ **F/ADV:** **During playback** - To move the playback position 60 seconds forward.  
**During pause** - To move the playback position moves 1 frame forward.
  - ⑥ **REW:** To rewind the footage at 1x, 2x, 4x, and 8x speed during playback.
  - ⑦ **PLAY/PAUSE:** To play or to pause the footage in playback mode.
  - ⑧ **FF:** To fast forward the footage at 1x, 2x, 4x, and 8x speeds during playback.
  - ⑨ **Control button:** Press to move the menu items or select channel.
  - ⑩ **SETUP:** To launch SETUP menu.
  - ⑪ **SEARCH:** To go to the search menu.
  - ⑫ **ESC:** **During setting** - To return to previous menu screen.  
**During playback** - To exit from playback.
  - ⑬ **BACKUP:** To start operations of backup in live or playback mode. (The same function button as CAPTURE on the front panel of DVR.)
  - ⑭ **SEQ:** To start auto sequencing of the screen in full screen mode. (Toggle)

### ■ Operation range

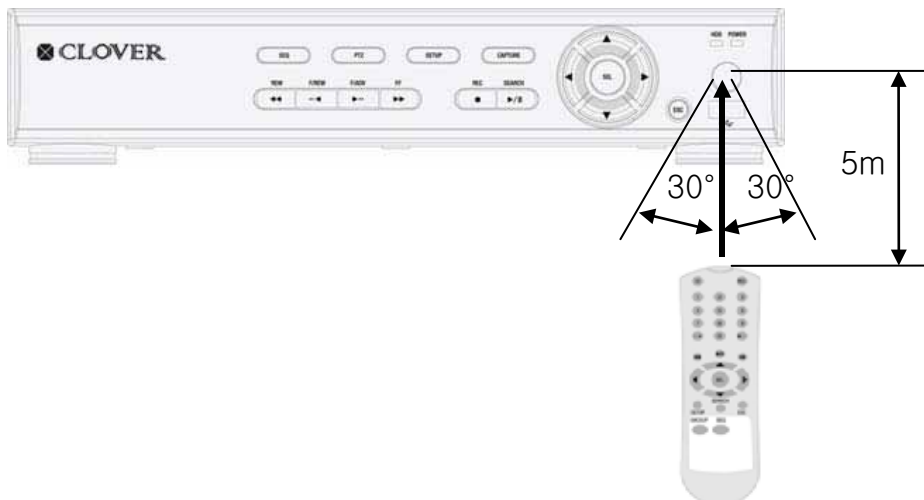

## 1-3. Rear panel and connection

### 1-3-1. Basic connections

- Do not power this system on before all the connections are completed.
- Make sure all the connections are properly. Faulty connection may result in the system being damaged.
- The DC plug of the AC adaptor is easy to be unplugged. Please make sure that the plug is removed.

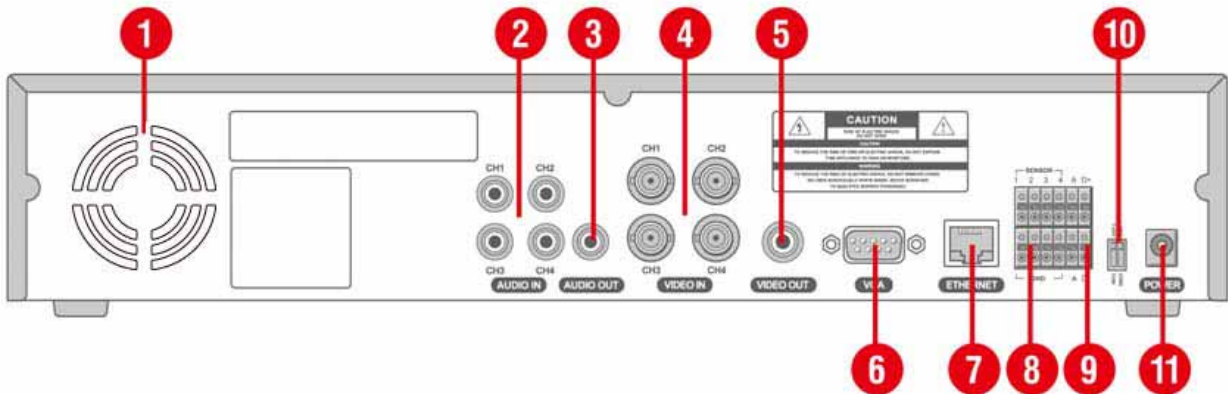

4CH

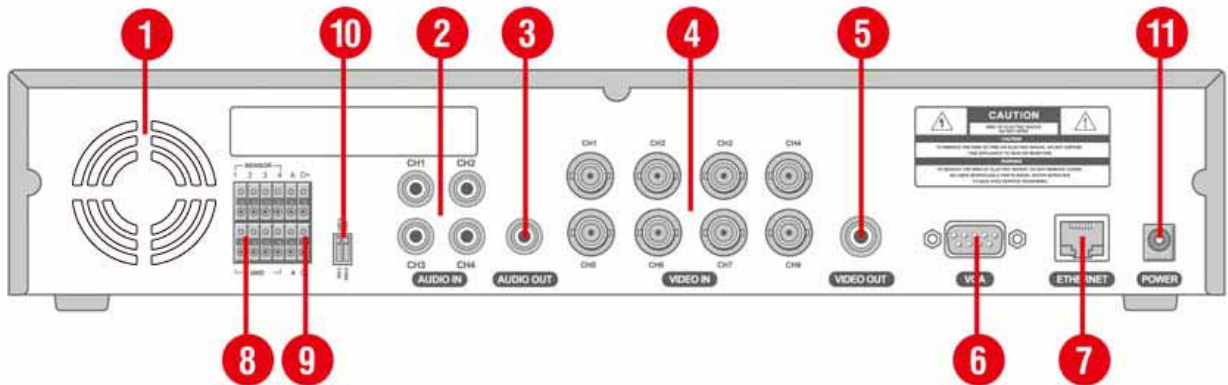

8CH

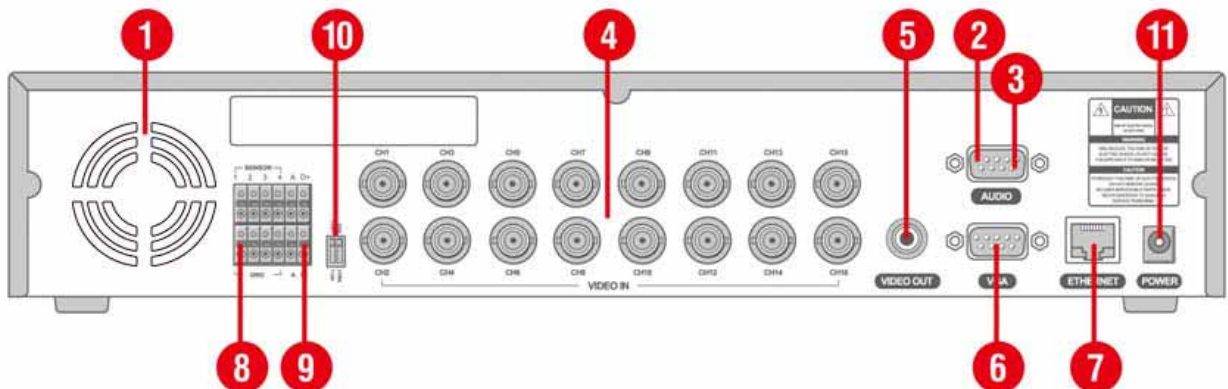

16CH



- 
- ① Cooling fan
  - ② AUDIO IN: Audio input terminal (\* Use the audio cable which is provided with the 16ch dvr package)
  - ③ AUDIO OUT: Audio output terminal (\* Use the audio cable which is provided with the 16ch dvr package)
  - ④ VIDEO IN: Video input terminal
  - ⑤ VIDEO OUT: Video output terminal
  - ⑥ VGA: VGA (Video Graphics Array) output terminal. Connects to the PC VGA monitor.
  - ⑦ ETHERNET: Network terminal
  - ⑧ SENSOR IN & ALARM OUT: External sensor terminal & External alarm out terminal
  - ⑨ RS-485
  - ⑩ TERMINATION ON/OFF: Termination ON/OFF switch  
CVBS/VGA: System video output format switch
  - ⑫ POWER: DC12V input terminal

### 1-3-2. Network connections

- **LAN Connection – Using the cross cable, without a switching hub**

Connect to the system directly, using a cross type network cable

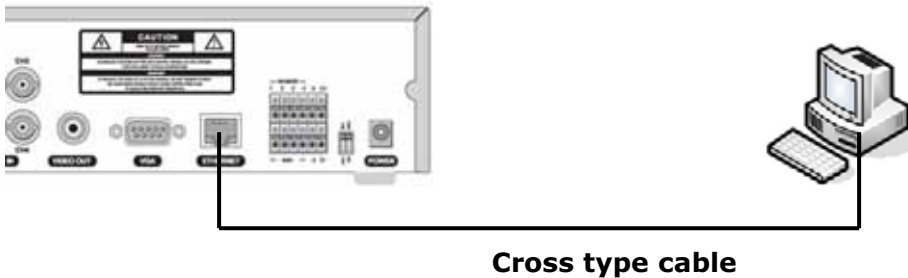

- **LAN Connection – Using a switching hub**

Connect to the system, using a hub (Switching hub) and an Ethernet cable (10BASE-T/100BASE-TX CAT 5 LAN cable)

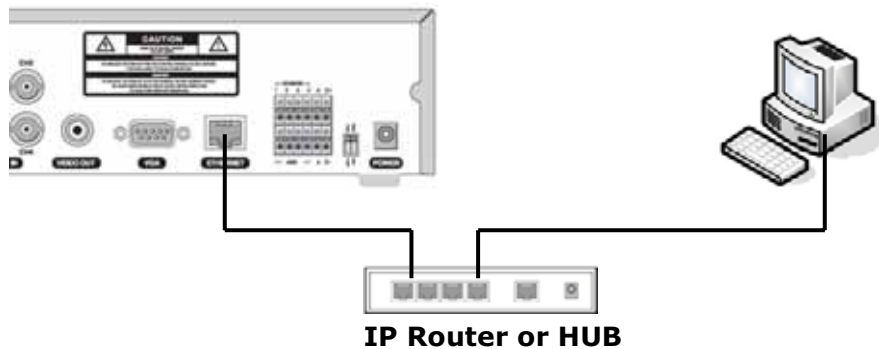

- **Internet (ADSL) Connection**

Connect to the system, using an Router or ADSL modem and an Ethernet cable (10BASE-T/100BASE-TX CAT 5 LAN cable)

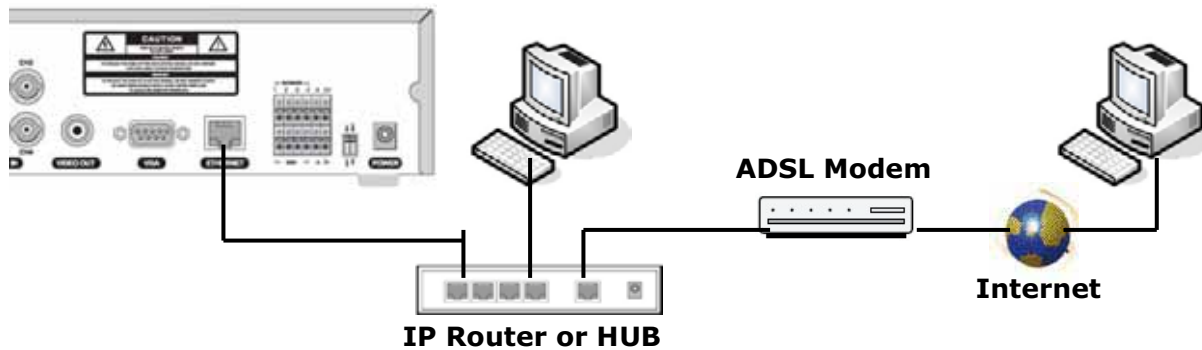

#### NOTICE

If you have a IP line with one IP address (whether it is dynamic IP or fixed IP), but you have more than one internet device (such as PC/PCs and a DVR); to use Router (It is different from a simple Network Hub); you must set up the Router to work with DVR; and you must use a network capable PC within the local Router network to do the setup. Whether you are using an existing Router or a new Router, you must go through the Port Forwarding portion of the setup.

#### 1-3-3. Sensor and alarm connections

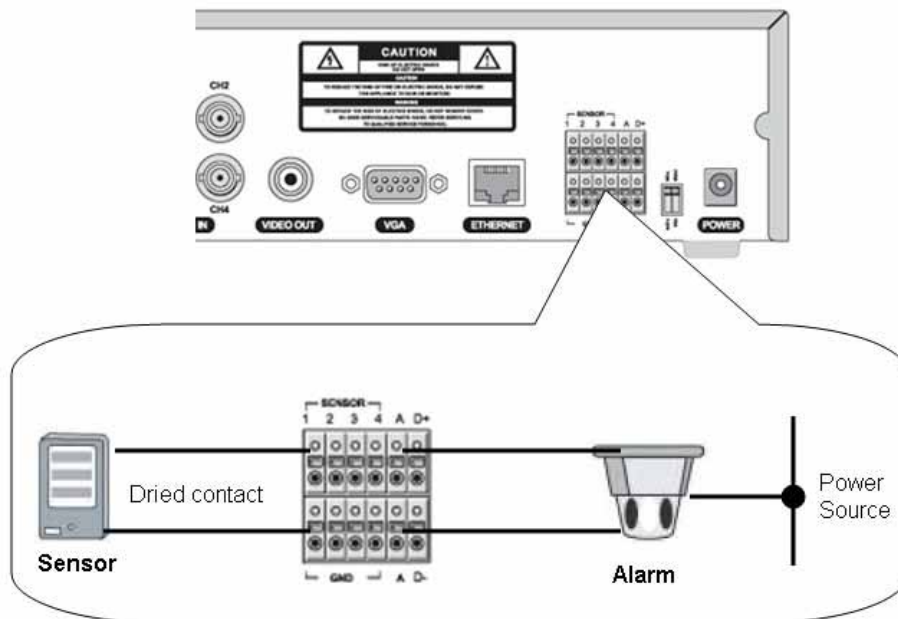

**SENSOR INPUT:** Connect two signal lines of sensor (infrared ray sensor, heat perception sensor, magnetic sensor) to the desired sensor number.

#### NOTICE

SENSOR inputs need dried contact only. Do not input any electric signal.

---: Not operational

N/O: Normally open type sensor. When magnetic sensor is closed, sensor sends a signal.

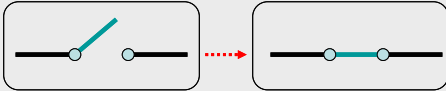

N/C: Normally closed type sensor. When magnetic sensor is opened, sensor sends a signal.

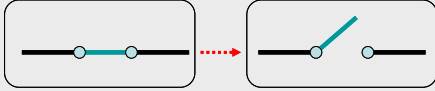

**ALARM OUTPUT:** Use **Maximum current: 0.5A/125VAC, Maximum voltage: 1A/30VDC**. When controlling lamp and AC operated equipment, control it using separate outside relay. During normal operation the control output contact is maintained at “Open” status, and during control output the output contact is changed to Closed(short)” status.

## 1-4. Selecting the type of monitor (TV monitor and VGA monitor)

1-4-1. CVBS: Select CVBS to connect general TV monitor

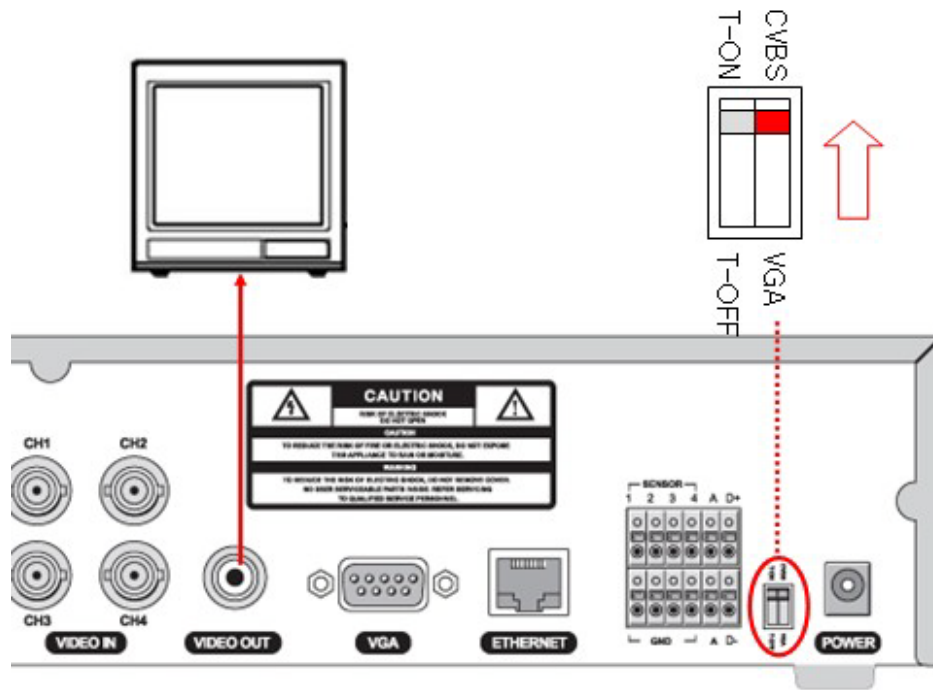

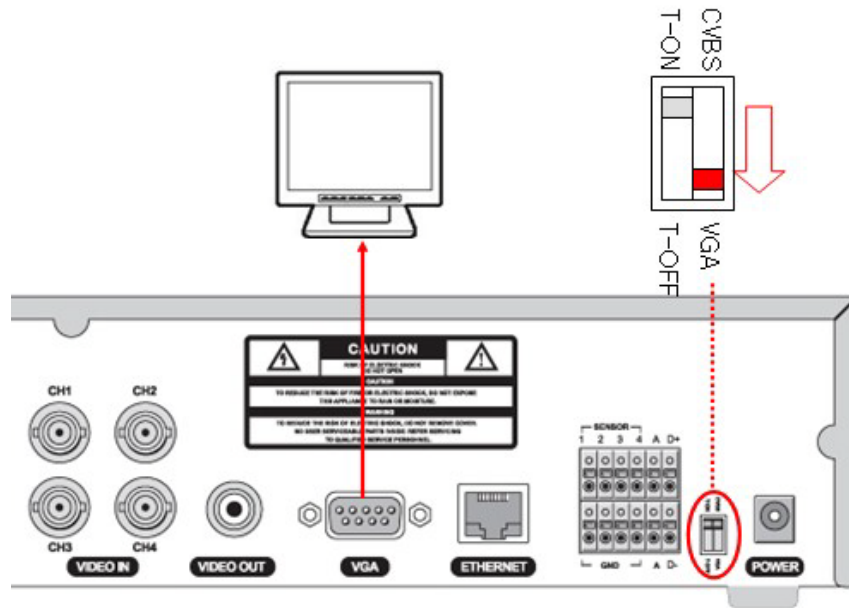

- The general TV monitor terminal and the computer VGA monitor terminal can not be used simultaneously.

## 2. Setting up the DVR

The following sections detail the initial setup of a DVR.

### 2-1. Setup – Main Screen

To enter the setup menu, select MENU and SETUP on the screen using the mouse or press the SETUP

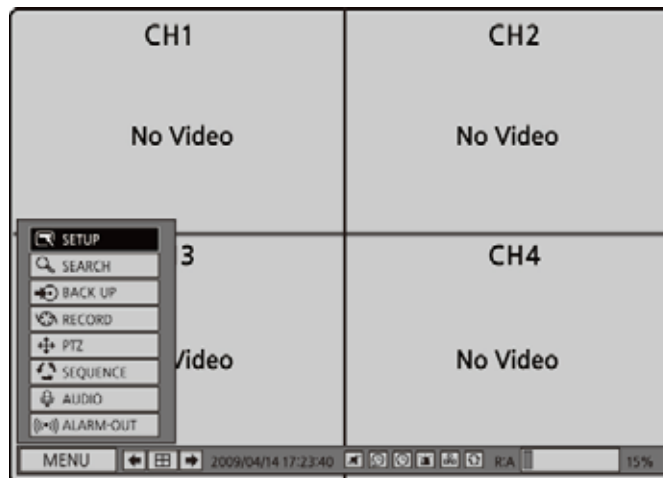

button on the front panel. Then select a user type. User can select one of user types (ADMIN, USER1, USER2, USER3) using the control button (◀ ▲ ▶ ▼) on the front panel and press SEL button.

Then password input screen will be displayed. User can select a password using the control button (◀ ▲ ▶ ▼) and select OK to enter the setup menu. The factory default password is 11111111.

It is highly recommended to assign a new password to protect the system. User can assign a new password in SECURITY setup menu.

**Table 2.1.1. Setup menu tree**

- DISPLAY
  - OSD
  - SEQUENCE
  - SEQ-DWELL TIME
  - OSD CONTRAST
  - CHANNEL
    - NAME
    - COVERT
    - BRIGHTNESS
    - CONTAST
    - HUE
    - SATURATION
- RECORD
  - RESOLUTION
  - CHANNEL
    - FRAME RATE
    - QUALITY
    - RECORDING
    - ELECTRIC LIGH CONTROL
    - SENSOR RECORDING
    - PRE RECORD
    - POST EVENT RECORD
    - AUDIO
    - SCHEDULE
- DEVICE
  - ALARM OUT
  - PTZ
  - CHANNEL
    - MOTION ZONE
    - MOTION SENSITIVITY
  - KEY TONE
  - REMOTE CONTROL ID
  - SENSOR
    - TYPE
- STORAGE
  - OVERWRITE
  - DISK FORMAT
  - DISK INFO
  - RECORDING LIMIT
  - RECORDING LIMIT DAYS

## ■ SYSTEM

- DVR-ID
- DESCRIPTION
- LANGUAGE
- DATE FORMAT
- SET DATE & TIME
- CLIENT ACCESS
- BANDWIDTH SAVING
- SEND EMAIL
- NTP

## ■ SECURITY

- USER AUTHENTICATION (ADMIN, NETWORK, USER1, USER2, USER3)
- USER PASSOWRD

## ■ NETWORK

- PORT
- WEB PORT
- NETWORK TYPE (LAN, DHCP, ADSL)
- DDNS
  - DDNS SERVER NAME
  - DDNS INTERVAL

## ■ CONFIG

- SAVE SETUP TO A USB
- LOAD SETUP FROM A USB
- LOAD DEFAULT
- LOAD FACTORY DEFAULT

## 2-2. Setup – Display Mode

Press the SETUP button and enter the password. The setup menu is displayed as picture below. Select DISPLAY icon and press SEL button to enter the setup menu item. Navigate through the menu items using the control button (◀ ▲ ▶ ▼) and change the value of the menu item using the control button

(◀ ▲ ▶ ▼). To return to setup menu screen, press the ESC button.

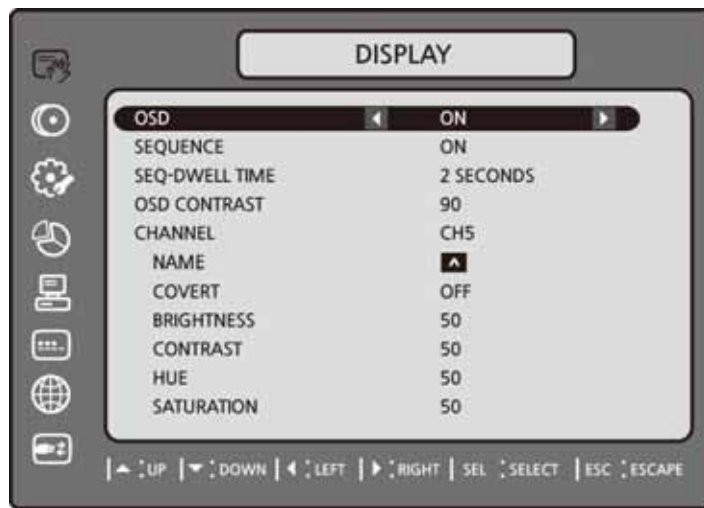
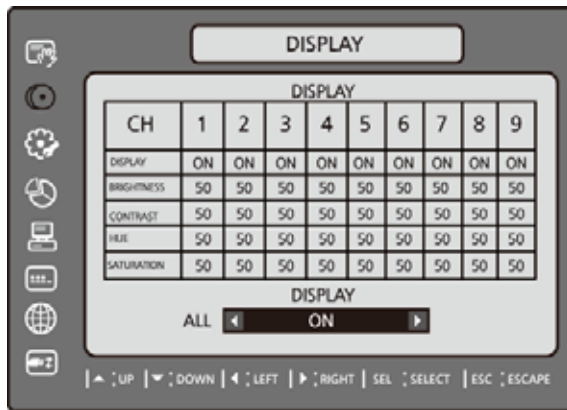

Figure 2.2.1. Display mode setup screen

Table 2.2.1. Menu items in DISPLAY mode setup

Item	Description
<b>OSD</b>	<p>Enable/disable on-screen-display.</p> <p>Select ON and press SEL button, then user are able to control OSD display bar up or down using the control button (◀ ▲ ▶ ▼).</p>
<b>SEQUENCE</b>	Enable/disable sequential display of video in full screen mode.
<b>SEQ-DWELL TIME</b>	Set the dwell time of each, quad or 9 channels display in sequential display mode.(1-60seconds)
<b>OSD CONTRAST</b>	Set the visibility level of the On Screen Display (OSD).(20-100)
<b>CHANNEL</b>	<p>Select a channel for applying the following settings using the control button (◀ ▲ ▶ ▼). Press SEL button to change the setting value of all channels at once. Once you select an item, then press SEL to set value for all channels.</p> <p>(DISPLAY, BRIGHTNESS,CONTRAST,HUE,SATURATION)</p>



<b>NAME</b>	Set the channel name. Press SEL button and set the channel name and select OK using the control button (◀ ▲ ▶ ▼).
<b>COVERT</b>	Enable/disable display of the video channel in live display mode.
<b>BRIGHTNESS</b>	Change the brightness value of the specified channel.(0-100)
<b>CONTRAST</b>	Change the contrast value of the specified channel. (0-100)
<b>HUE</b>	Change the hue value of the specified channel. (0-100)
<b>SATURATION</b>	Change the saturation value of the specified channel. (0-100)

### 2-3. Setup – Recording Mode

Press the SETUP button and enter the password. The setup menu is displayed as picture below. Select RECORD icon and press SEL button to enter the setup menu item. Navigate through the menu items using the control button (◀ ▲ ▶ ▼) and change the value of the menu item using the control button (◀ ▲ ▶ ▼). To return to setup menu screen, press the ESC button.



Figure 2.3.1. Recording mode setup screen

Table 2.3.1. Menu items in Recording mode setup

Menu item	Description
<b>RESOLUTION</b>	Set the resolution to either 704x480, 704x240, or 352x240 for NTSC. (For PAL: 704*576/ 704*288/ 352*288)
<b>CHANNEL</b>	Select a channel for applying the following settings using the control button (◀ ▲ ▶ ▼). Press SEL button to change the setting value of all channels at once. Once you select an item, then press SEL to set value



for all channels.

(FRAME RATE, QUALITY, RECORDING, PRE REC, POST EVT REC)

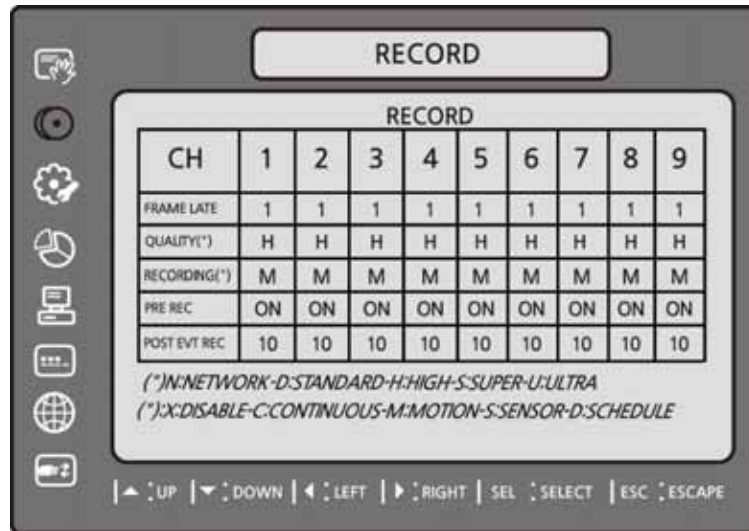

---

### FRAME RATE

Set the frame rate for the specified channel. The sum of the frame rate values from each channel cannot exceed the maximum frame rates for a specific recording resolution.

**Typical values of the maximum frame rate for video are**

**120/100 fps version**

120/100fps: 352\*240(NTSC)/352\*288(PAL)

60/50fps: 704\*240(NTSC)/704\*288(PAL)

30/25 fps: 704\*480(NTSC)/704\*576(PAL)

---

### QUALITY

Select the recording quality for the specified channel. Options are: Network, Standard, High, Superior and Ultra.

---

### RECORDING

Assign the recording mode for each channel. Options are: Continuous, By Motion, By Sensor, By Schedule or Disable.

---

### ELECTRIC LIGHT CONTROL

Enable/Disable electric light control. When alarm output is connected to an electric light for the motion detection signal, user needs to set ELECTRIC LIGHT CONTROL to ON. Then the motion detection signal will not be activated for 2-3seconds after alarm output is turned off.

---

### SENSOR RECORDING

Enable setting up to 4 sensors of 9 sensors for the specified channel using the control button (◀ ▲ ▶ ▼).

---

### PRE RECORD

Enable/disable pre-event recording. Pre-event recording time is 3 seconds and only intra-frames are recorded for pre-event recording.

---

### POST EVENT RECORD

Set the post event recording time duration for the specified channel. (10-30 seconds)

---

### AUDIO

Enable/disable audio recording for the specified channel.

- Fixed-available on only from channel 1 to channel 4.
- 

### SCHEDULE

Set the recording schedule. Press SEL to go to schedule setup screen.

---

### 2-3-1. Recording Schedules

To setup a recording schedule, select SCHEDULE in the RECORD menu. Navigate through the items using the control button (◀ ▲ ▶ ▼).

Once the channel 1 is selected, SCHEDULE-CH1 screen is displayed. Select ALL or each day using the control button (◀ ▲ ▶ ▼) and set the recording mode using the SEL button repeatedly.

C: CONTINUOUS recording

M: MOTION recording

S: SENSOR recording

-: Does not record

[ALL]: Move the cursor to ALL and select a recording mode C, M or S using the SEL button to set the same setting for every day.

[SUN to SAT]: Move the cursor to SUN to SAT and select a recording mode C, M or S using the SEL button to set the same setting for the whole day.

[Vertical Bar “|”]: Move the cursor to ALL and move the cursor to the specific time using the control button (◀ ▲ ▶ ▼). And select a recording mode C, M or S using the SEL button to set the same setting.

[SEL]: The recording mode can be selected by pressing repeatedly the SEL button.

[COPY FROM] [COPY TO]: Set the channel 1 schedule and select COPY TO using the control button (◀ ▲ ▶ ▼), select CH2 using the control button (◀ ▲ ▶ ▼) and press the SEL button. Then the CH1 schedule is copied to CH2.

To return to setup menu screen, press the ESC button.

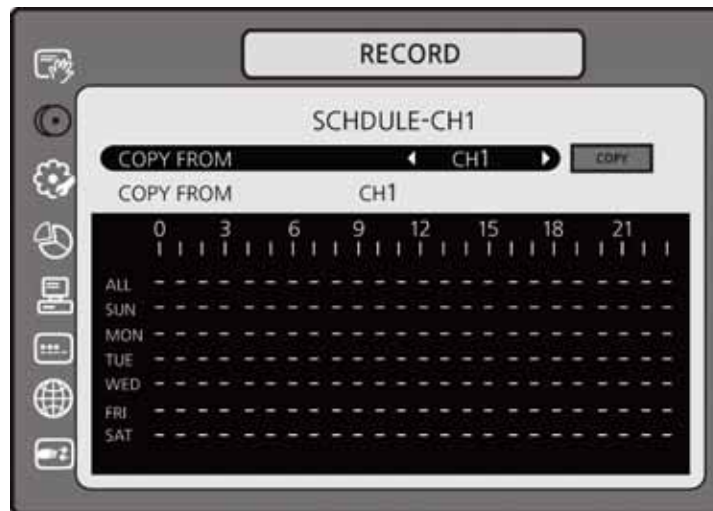

Figure 2.3.2. Schedule recording setup screen

### 2-4. Setup – Device Mode

Press the SETUP button and enter the password. The setup menu is displayed as picture below. Select DEVICE icon and press SEL button to enter the setup menu item. Navigate through the menu items using the control button (◀ ▲ ▶ ▼) and change the value of the menu item using the control button (◀ ▲ ▶ ▼). To return to setup menu screen, press the ESC button.



**Figure 2.4.1. Device mode setup screen**

**Table 2.4.1. Menu items in Device Setup screen**

Item	Description
<b>ALARM OUT</b>	Set the sensor, motion, and video loss for each alarm.
<b>PTZ</b>	Set the PTZ camera speed, number, type and ID.
<b>CHANNEL</b>	Select specified channel for motion zone setup.
<b>MOTION ZONE</b>	Select either Full Zone or Partial Zone for motion sensing.
<b>MOTION SENSITIVITY</b>	Set the motion sensitivity for the specified channel. Control the motion sensitivity from 1 to 9.
<b>KEY TONE</b>	Enable/disable key tone.
<b>REMOTE CONTROL ID</b>	Select an ID of remote control. 1. Select ID. 2. Press the same number as ID set in DVR on a remote control. 3. Then icon will be displayed on Live screen of DVR that respond to the remote control. The options are from 00 to 99
<b>SENSOR</b>	Select sensor NO from 1 to 4,9,16.
<b>TYPE</b>	Set the type of sensor for the specified channel. Options are: OFF, N/O (normal open), and N/C (normal closed).

## 2-4-1. ALARM-OUT

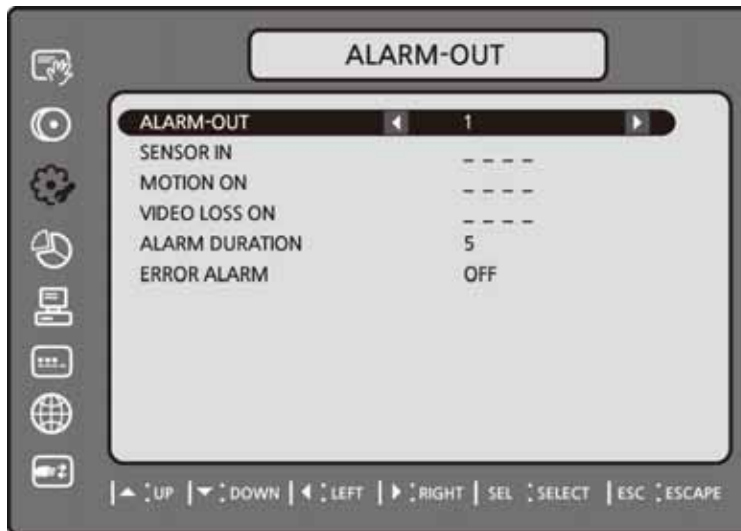

Figure 2.4.2. ALARM-OUT setup screen

Table 2.4.2. Menu item in ALARM-OUT Setup screen

Item	Description
<b>ALARM OUT</b>	Select an alarm out number. Available NO: 4CH(1), 9CH(1), 16CH(1)
<b>SENSOR IN</b>	Enable setting up to 4 cameras of 4/9/16 cameras for each alarm.
<b>MOTION ON</b>	Enable setting up to 4 cameras of 4/9/16 cameras for each alarm.
<b>VIDEO LOSS ON</b>	Enable setting up to 4 cameras of 4/9/16 cameras for each alarm.
<b>ALARM DURATION</b>	Set the alarm dwell time from 5 to 60 seconds.
<b>ERROR ALARM</b>	Set the error type for the alarm activation. The options are OFF, ALL, HDD ERROR and VIDEO LOSS.

## 2-4-2 PTZ Setup

To control the PTZ functions of the camera, connect a controller to the RS-485 port.

- ① Connect the RS-485 cables of PTZ camera to the RS-485 port on the rear panel.

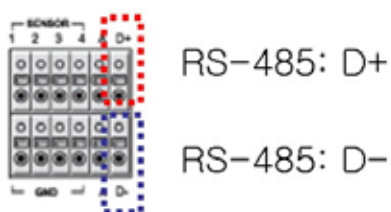

- ② Press SEL button or double click to enter the menu. Then PTZ menu screen is displayed.

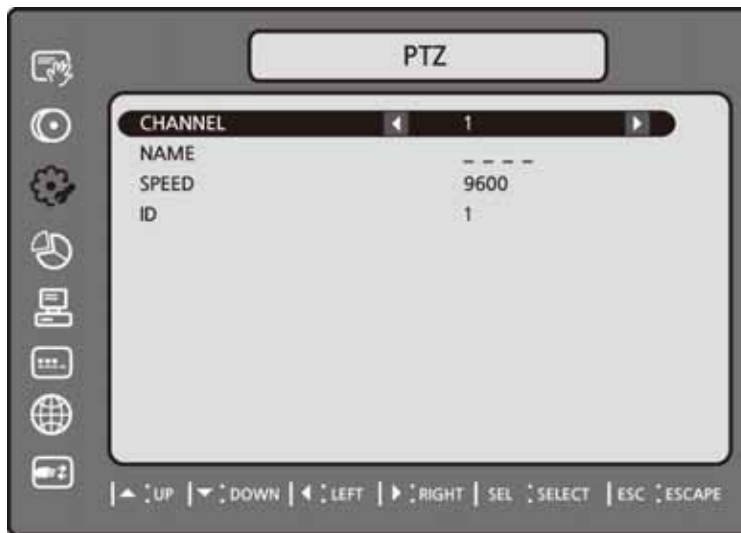

**Figure 2.4.3. PTZ Control Setup Screen**

**Note:** For speed dome cameras that support RS-485, connect them directly to the RS-485 port. If the camera is controlled with RS-232C, use an RS-485 to RS-232C signal converter.

On the PTZ control setup screen, you can select or set the protocol type of the camera that is the same as the one installed on the site. If the camera has a specific camera ID, select the camera ID using the control button (◀ ▲ ▶ ▼).

The following options are available on the PTZ setup screen.

**CHANNEL** (channel number that the PTZ is connected to)

**NAME** (protocol type)

**SPEED** (19200, 14400, 9600, 4800, 2400)

**ID** (0-63)

### 2-4-3. Motion Zone Setup

Select MOTION ZONE using the control button (◀ ▲ ▶ ▼) and select either PARTIAL ZONE or FULL ZONE using the control button (◀ ▲ ▶ ▼). And press the SEL button.

If FULL ZONE is selected, the motion setting screen is not displayed. Only set the level of sensitivity for MOTION SENSITIVITY.

**FULL ZONE:** The motion sensor is active on the whole screen.

**PARTIAL ZONE:** The motion sensor is active in the set detection frame.

Select the sensor detection position using the control button (◀ ▲ ▶ ▼) and press the SEL button.

Then the color of the position which is selected will be changed. Press ESC button to return to the DEVICE setup menu.

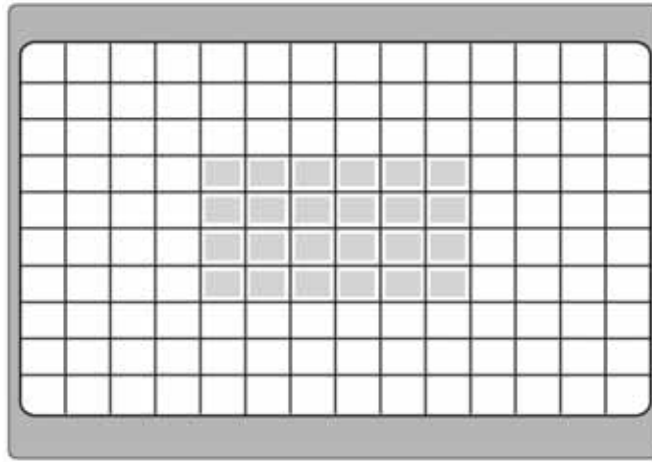

Figure 2.4.4. Motion Zone selection screen

## 2-5. Setup – Storage Mode

Press the SETUP button and enter the password. The setup menu is displayed as picture below. Select STORAGE icon and press SEL button to enter the setup menu item. Navigate through the menu items using the control button (◀ ▲ ▶ ▼) and change the value of the menu item using the control button (◀ ▲ ▶ ▼). To return to setup menu screen, press the ESC button.

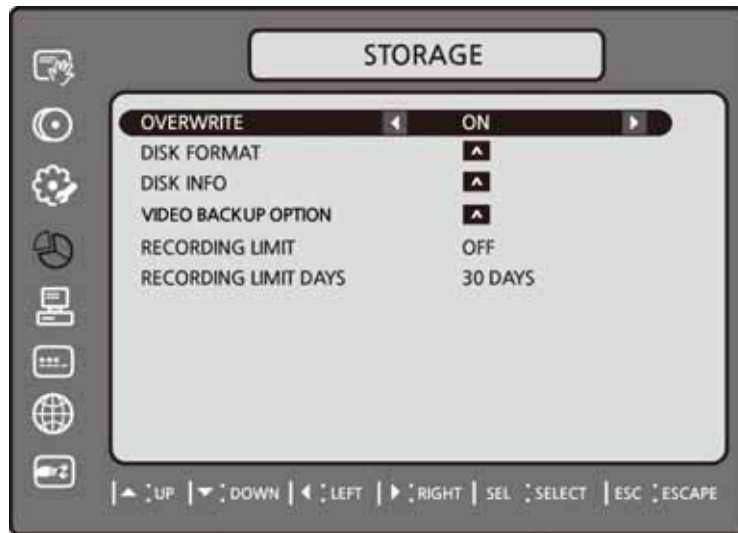

Figure 2.5.1. STORAGE setup screen

Table 2.5.1. Menu items in STORAGE Setup screen

Item	Description
<b>OVERWRITE</b>	When enabled, the DVR will continue recording and overwrite the oldest existing recorded data once the hard drive is full. When disabled, recording will stop once the hard drive is full.
<b>DISK FORMAT</b>	You will have an option YES or NO for the hard drive format. <b>Caution:</b> We recommend that you archive any data that you may need in the future before you format the hard drive.

<b>DISK INFO</b>	Hard drive information
<b>VIDEO BACKUP OPTION</b>	You will have an option REC ON or REC OFF for the recording during the video backup. If set it to REC OFF, the backup speed will be faster.
<b>RECORDING LIMIT</b>	Enable/disable recording limit.
<b>RECORDING LIMIT DAYS</b>	Set the recording limit days.(1- 90 days)

## 2-6. Setup – System Mode

Press the SETUP button and enter the password. The setup menu is displayed as picture below. Select SYSTEM icon and press SEL button to enter the menu item. Navigate through the menu items using the control button (◀ ▲ ▶ ▼) and change the value of the menu item using the control button (◀ ▲ ▶ ▼). To return to setup menu screen, press the ESC button.

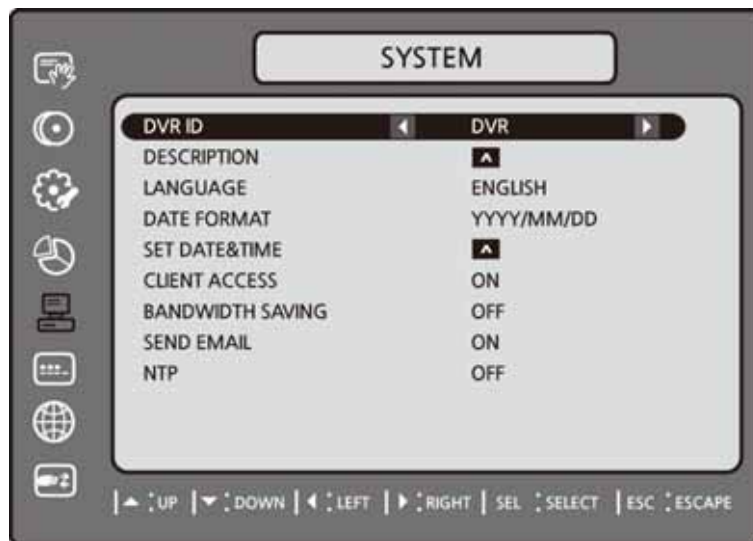

Figure 2.6.1. SYSTEM Setup Screen

Table 2.6.1. Menu items in SYSTEM Setup screen

Item	Description
<b>DVR ID</b>	Press the SEL button and select DVR ID using the control button (◀ ▲ ▶ ▼), and press SEL button. Press OK to apply the selected DVR ID.



---

SPACE / Caps Lock(Select either Capital or Lower letter)

BS(Back space: Erase previous character) / Clear(Erase all characters)

---

**DESCRIPTION**

Press SEL button to view system information.

(Hardware version, Software version, Storage size, IP address and MAC address.)



---

**LANGUAGE**

Select the display language using the control button (◀ ▲ ▶ ▼). Once a language is selected, the display language changes.

---

**DATE FORMAT**

Select the date display format using the control button (◀ ▲ ▶ ▼). Options are:

YYYY/MM/DD MM-DD-YYYY DD-MM-YYYY

---

**SET DATE&TIME**

Move the cursor to the display date and time using the control button (◀ ▲ ▶ ▼) and press SEL button to set the present date and time. Press ESC button to return to SET DATE & TIME setup menu.

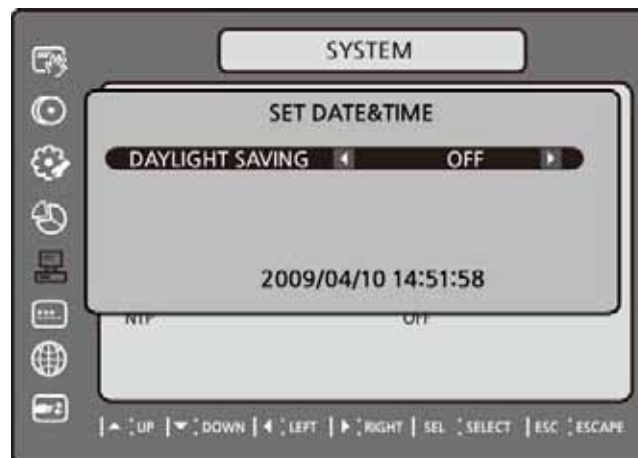

---

**DAY LIGHT SAVING**

Select DAYLIGHT SAVING using the control button (◀ ▲ ▶ ▼),

Select the appropriate daylight saving time zone using the control button (◀ ▲ ▶ ▼).

If choosing EU or OTHERS, set the applicable conditions.

The options are:

**OFF**



## USA

## EU

## OTHERS

1. OFF: Daylight saving is not set.
2. USA: Applies the USA daylight saving time.
3. EU: Applies the EU daylight saving time.
  - Select the GMT AREA using the control button (◀ ▲ ▶ ▼).
  - Set the time difference with the standard time using the control button (◀ ▲ ▶ ▼).
4. OTHERS: If the time zone is neither USA nor E, set the start and end date of the daylight saving period.
  - Select BEGIN or END using the control button (◀ ▲ ▶ ▼) and press the SEL button.
  - Select the item using the control button (◀ ▲ ▶ ▼), select the setting value using the control button (◀ ▲ ▶ ▼) and press the ESC button to return to SET DATE & TIME setup menu.

### CAUTION:

- Do not set the start time to 23:00 for DLS.
- DLS can't be applied, if the date of BEGIN and END is same.

---

<b>CLIENT ACCESS</b>	Enable/Disable remote access through network client software.
<b>BANDWIDTH SAVING</b>	Enable/Disable only key frame transmission. "ON" mode is favorable for use of low network bandwidth. Mostly, set "OFF" for normal use.
<b>SEND EMAIL</b>	Enable/disable the send e-mail function.(ON/OFF)

---

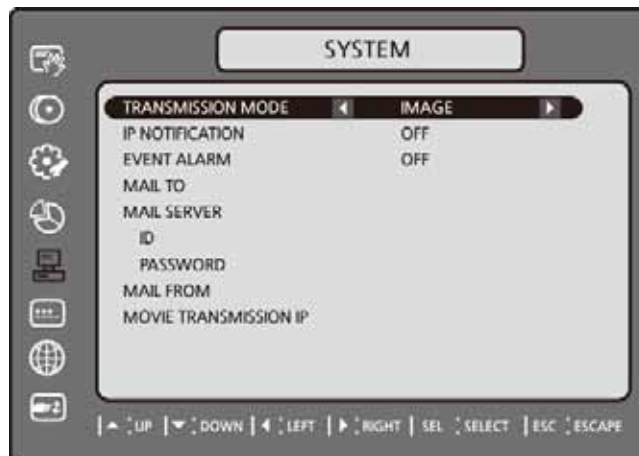

**TRANSMISSION MODE:** Enable sending image of the channel that triggered the alarm when an alarm event is triggered.

**IP NOTIFICATION:** Enable/disable sending e-mail when the IP address of your DVR is changed.

**EVENT ALARM:** Enable/disable sending e-mail reports on the channel that triggered the alarm when an alarm event is triggered.

---

**MAIL TO:** Enter the appropriate email address to enable sending e-mail reports.

**MAIL SERVER:** Enter the appropriate mail server information to enable sending daily e-mail reports.

**ID:** To set the connection user ID for the mail server.

**PASSWORD:** To set the connection password for the mail server.

**MAIL FROM:** To set the mail address sent to the destination host.

---

## **NTP**

NTP is an abbreviation for Network Time Protocol, which is for synchronizing the clocks of computer systems over variable-latency data networks.

---

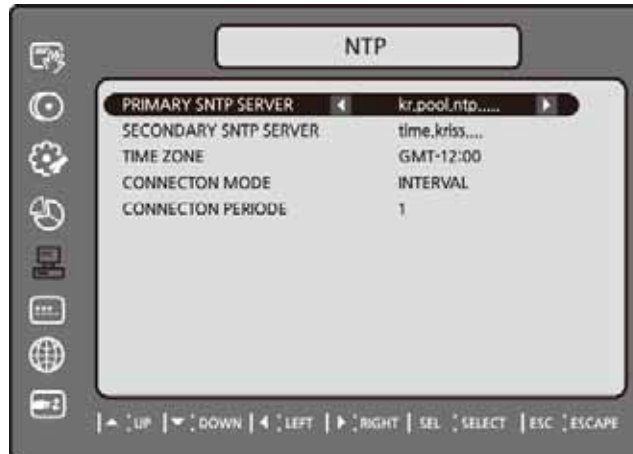

**PRIMARY SNTP SERVER:** Input the address of the primary NTP time server.

**SECONDARY SNTP SERVER:** Input the address of the secondary NTP time server.

**TIME ZONE:** Greenwich Mean Time(GMT) is a term originally referring to mean solar time at the Royal Observatory, Greenwich in London. Because NTP synchronizes with Greenwich Mean Time(GMT) regardless of geography, users must set their own time difference. (Ex. Los Angeles, CA GMT -08:00 / New York, NY GMT -05:00)

**CONNECTON MODE:** Select NTP time server connection mode.

**INTERVAL:** Synchronize the clock by hours which is set on the connection period menu.

**TIME:** Synchronize the clock at the time daily which is set on the connection Period menu.

**CONNECTION PERIOD:** 1~24

---

## **2-7. Setup – SECURITY Mode**

Press the SETUP button and enter the password. The setup menu is displayed as picture below. Select SECURITY icon and press SEL button to enter the setup menu item. Navigate through the menu items using the control button (◀ ▲ ▶ ▼) and change the value of the menu item using the control button (◀ ▲ ▶ ▼). To return to setup menu screen, press the ESC button



Figure 2.7.1. PASSWORD setup screen

Table 2.7.1. Menu Items in PASSWRORD Setup Screen

Item	Description
<b>USER AUTHENTICATION</b>	<p><b>PASSWORD CHECK:</b></p> <p>Select either O or X for the functions such as <b>Setup, Playback(PB), PTZ, Record OFF(R/OFF), and Network(NET)</b>.</p> <p>O: Ask for a password when the given function is selected for all users.</p> <p>X: Does not ask for a password when the given function is selected for all users.</p>
	<p><b>ADMIN, NETOWRK, USER1, USER2, USER3:</b></p> <p>O: It means user can access to the function.</p> <p>X: It means user cannot access to the function.</p>
<b>USER PASSWORD</b>	<p>Options are ADMIN, NETWORK, USER1, USER2 and USER3.</p> <p>Select USER PASSWORD using control button (◀ ▲ ▶ ▼) and press SEL button. Select user type using the control button (◀ ▲ ▶ ▼) and SEL button. Enter the current password and select OK. Enter</p>

the new password and select OK. Enter the same password again to confirm and select OK. Then the message "PASSWORD CHANGED" is displayed.

The factory default password is **11111111**.

## 2-8. Setup – Network Mode

Press the SETUP button and enter the password. The setup menu is displayed as picture below. Select NETWORK icon and press SEL button to enter the setup menu item. Navigate through the menu items using the control button (◀ ▲ ▶ ▼) and change the value of the menu item using the control button (◀ ▲ ▶ ▼). To return to setup menu screen, press the ESC button

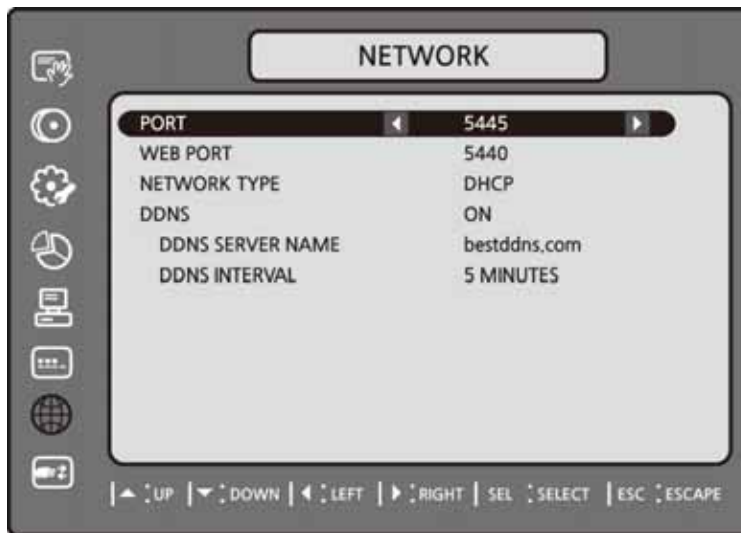

Figure 2.8.1. NETWORK setup screen

Table 2.8.1. Menu items in Network Setup screen

Item	Description
<b>PORT</b>	Port number (Default: 5445)
<b>WEB PORT</b>	Web Sever Port number (Default: 80)
<b>NETWORK TYPE</b>	Select a type of network connection. Options are: LAN, DHCP, ADSL  Note. Other parts of the network setup screen change depending on what network type you select.
<b>DHCP</b>	DVR automatically get IP varying from time to time from network and does not therefore need to be set.
<b>ADSL (PPPoE)</b>	ID: Registered ID is necessary for ADSL connection. Password: Registered password is necessary for ADSL connection.
<b>LAN</b>	IP: Register IP address that is assigned for DVR. Gateway: Register Gateway that is assigned for DVR. Subnet Mask: Register Subnet Mask that is assigned for DVR.

---

**DDNS**

Enable/disable using domain name address through DDNS server.

“ON” mode, DDNS server name appears for domain registration.

**DDNS SERVER NAME:** The DDNS sever name is bestddns.com.

**CAUTION:**

Do not change this sever name. If this is changed, the DDNS service cannot be available.

**DDNS INTERVAL:** Set the connection interval (5-60minutes)

---

## 2-8-1. Ports

When you connect one or more DVRs to a network through an IP sharing device, each device must have a unique TCP port number for access to each unit from outside the LAN. Also, the IP sharing device must be configured for port forwarding so when each port is accessed on the IP sharing device, it will forward to the appropriate DVR.

**Note:** This port number is listed next to the Port menu option in the Network Setup screen. If you plan to access the DVR units only from within the same LAN, the TCP port does not have to be changed.

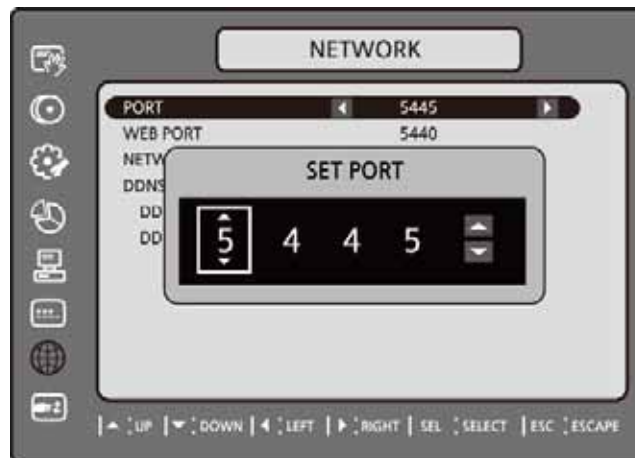

**Figure 2.8.1. Network setup screen – PORT**

### Network access beyond a router

In order to access the DVR remotely beyond a router (firewall), the user must open TCP port for command level, live channels and storage channels. User need to open 2ports numbers.

If the DVR port number is set to 5445, open the TCP port 5445 and 5446 on the router.

If this port is not opened properly, user can not access DVR beyond a router.

### Web viewer and Mobile-phone web viewer Network access beyond Router

In order to access beyond Router (Firewall), user must open 1 TCP port that is set on NETWORK > WEB PORT.

If this port is not open properly, user can not access DVR using direct Web viewer or Mobile-phone web viewer.

(Example: When NETWORK > WEB PORT is set as 80, 80 TCP port of IP address of DVR must be open.)

## 2-8-2. Network Types

### 2-8-2-1. LAN

1. For the use of fixed IP.

(See your network administrator if you do not have this information.)

2. When DVR is installed in IP sharer that is connected with ADSL, a user can assign fixed IP to DVR from IP sharer itself using “DMZ” function out of such sharer.

Input IP set in DMZ on “IP” field and Gateway of ADSL modem on “Gateway” field. Similarly, for Subnet Mask, DNS address, input relevant values in IP sharer.

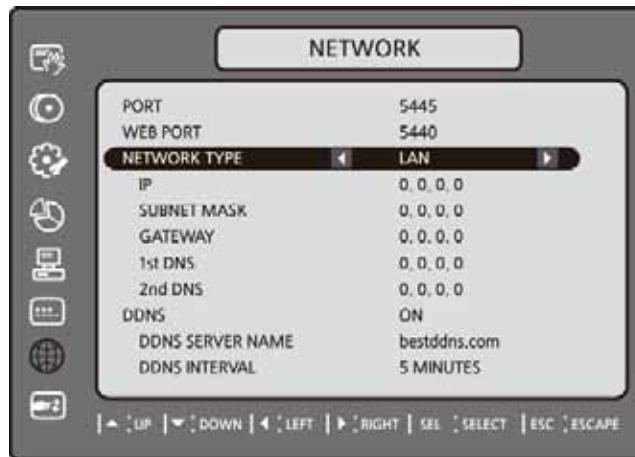
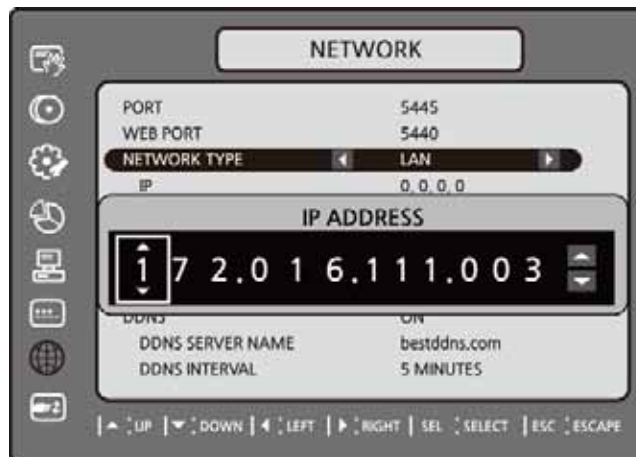

Figure 2.8.2. Network setup screen - LAN

Table 2.8.2. LAN

Item	Description
------	-------------

IP	The fixed IP address of the DVR unit.
----	---------------------------------------



<b>SUBNET MASK</b>	The subnet mask for the LAN
<b>GATEWAY</b>	The IP address of the Gateway
<b>1<sup>st</sup> DNS</b>	The address for the DNS server
<b>2<sup>nd</sup> DNS</b>	The address for the DNS server

### 2-8-2-2. DHCP

An IP address is automatically assigned by the DHCP server, which automatically assigns IP address and other parameters to new devices.

When ADSL or other network being used adopts variable IP method, not fixed IP. This option is used as a way to automatically get IP address.

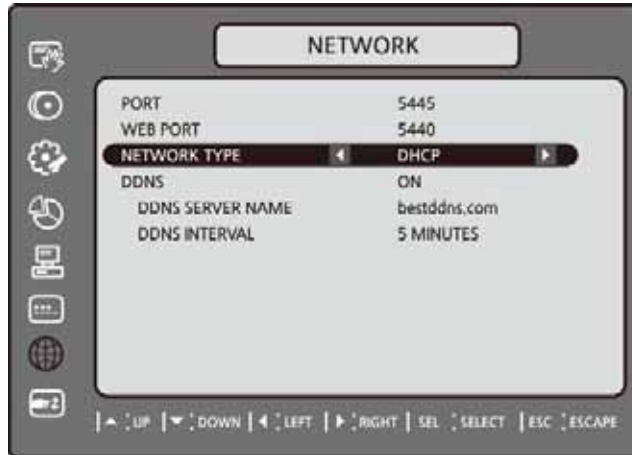

Figure 2.8.3. Network setup screen - DHCP

### 2-8-2-3. ADSL (PPPoE)

To use this ADSL (PPPoE) function when the network type connected DVR is using PPPoE method.

If ADSL type is not using inputting IP and Password like VDSL or if DVR is installed in IP sharer, a user can not select this function. In this case, a user should select DHCP or LAN.

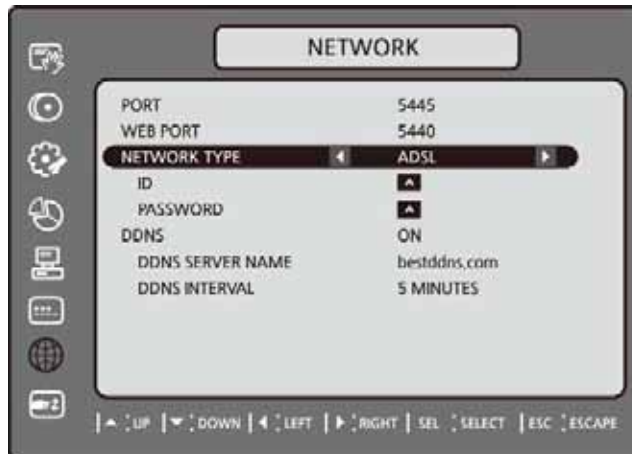

Figure 2.8.4. Network setup screen - ADSL

Table 2.8.3. ADSL

Item	Description
ID	The user ID for the ADSL connection
PASSWORD	The password for the ADSL connection

### 2-8-3. Saving Setup of Network setup

After changing the network configuration, confirmation window will popup. To preserve the setup values that you have selected, select YES. Then system will reboot.

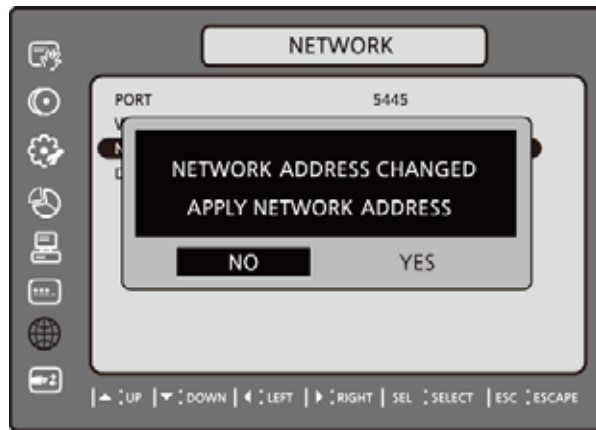

Figure 2.8.5. Network setup screen – SAVE SETUP

## 2-9. Setup - CONFIG Mode

Press the SETUP button and enter the password. The setup menu is displayed as picture below. Select CONFIG icon and press SEL button to enter the setup menu item. Navigate through the menu items using the control button (◀ ▲ ▶ ▼) and change the value of the menu item using the control button (◀ ▲ ▶ ▼). To return to setup menu screen, press the ESC button

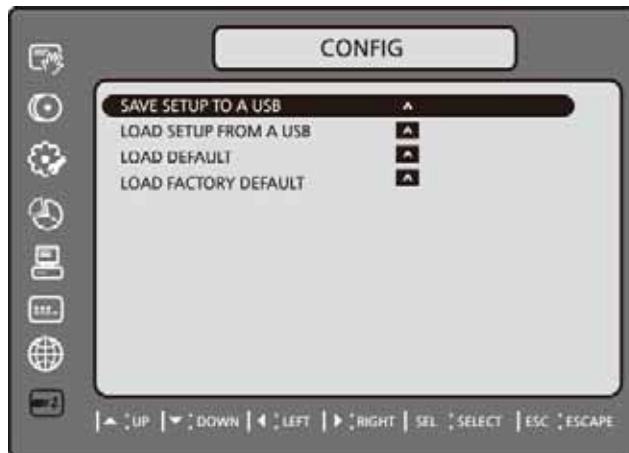

Figure 2.9.1. Config setup screen

Table 2.9.1. Config setup

Item	Description
<b>SAVE SETUP TO A USB</b>	User can save the current configuration (Setting values) of DVR to the USB memory stick. Put the USB stick on the front panel and press SEL to start the saving process.





**LOAD SETUP FROM A USB**

User can upload the configuration of DVR to another DVR using the USB Memory stick. Put the USB stick on the front panel and press SEL to start the loading process.

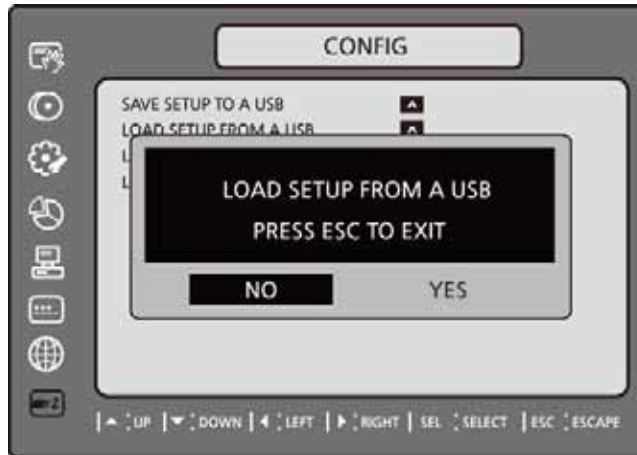

**LOAD DEFAULT**

Select ON to reset the system to the default settings.

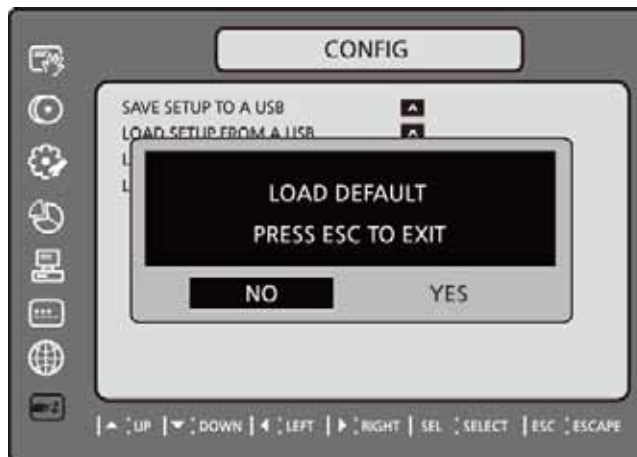

(The follow settings such as **Language, DVR ID, Security User Authentication, Security User P/W, Date format, DLS settings, Network settings, HDD serial number, and HDD ERROR time** will not be included.)

**LOAD FACTORY DEFAULT**

Select ON to reset the system to the factory default settings.

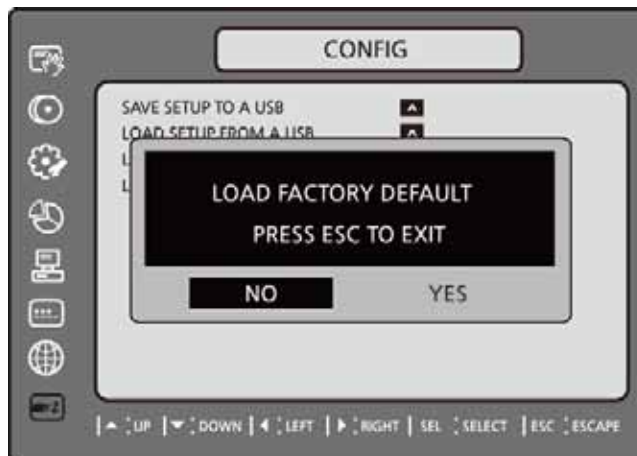

### 3. Saving Setup

To preserve the setup values that you have changed, select YES.

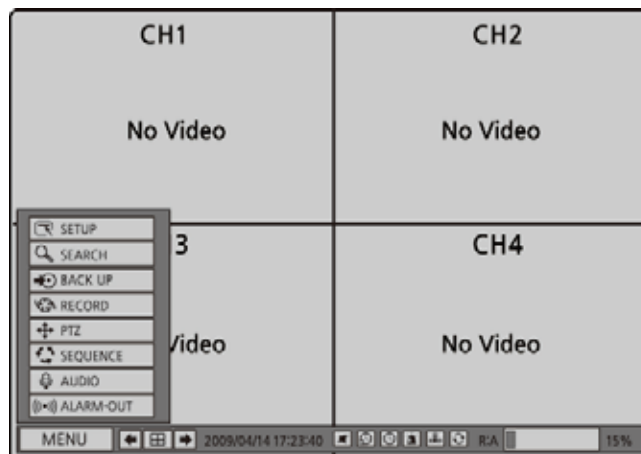
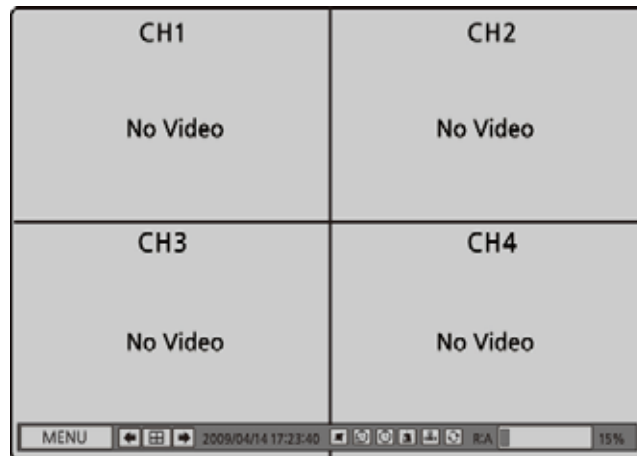

Figure 3.1.1. SAVE SETUP screen

### 4. Live, Search, and Playback

















#### 4-1. Live Viewing Screen

In the Live screen, video inputs from the cameras are displayed as they are configured in the Display Setup screen. Various on-screen display (OSD) symbols, which indicate the status of the DVR, are described in Table 4.1.1.













## Figure 4.1.1. Live Viewing Screen

Table 4.1.1. Status Indicator Icons in Live Viewing Screen

Icon	Description
	Click the MENU on the screen using the mouse to see menu items. Select menu item (SETUP, SEARCH, BACKUP, RECORD, PTZ, SEQUENCE, AUDIO or ALARM-OUT) using the mouse to enable/disable its functions.
	Click the left/right arrow icon to change the current channel on the split screen using the mouse or control button (◀ ▲ ▶ ▼) on the front panel.
	Click the split screen icon to change the current split screen mode using the mouse or SEL button.
2009/04/14 17:23:40	Displays the current date and time.
R:A	Remote control ID display. If no remote ID is set the message "A(all)" is displayed.
 15%	Displays the amount of recording on the hard disk from 0-99%.
	Continuous recording in progress.
	Manual recording in progress. To set the Manual recording mode, press the Record button on the front panel.
	Motion alarm recording in progress.
	Sensor recording in progress.
	Audio mute. To set audio mute, press the Audio button on the front panel.
	Single audio display. To set audio single for highlighted channel only, press the Audio button on the front panel.
	Mixed audio display
	Indicates that alarm is set. To set the alarm function, press the Alarm button on the front panel.
	Indicates that alarm output is activated.
	Alarm indicator. When there is an alarm (sensor or motion alarm) in the video channel, this icon will be highlighted bright red.
	Indicates that a network client is connected to the DVR.
	Indicates that sequencing mode is enabled.

**Table 4.1.2. Button functions in Live Viewing Screen**

Button	Description
<p>SEQ</p> 	<p>Enable/disable the automatic sequential display of channels in full screen, quad, 9-split display mode.</p>
<p>PTZ</p> 	<p>Controls Pan/Tilt/Zoom operations.</p>
<p>SETUP</p> 	<p>Launch the SETUP menu.</p>
<p>BACK UP</p> 	<p>Press to capture video in jpeg format.</p>
	<p>Use the control button (◀ ▲ ▶ ▼) when you want to move to next or previous channel.</p>
	<p>Switch between full, quad, 9 split and 16 split screen.</p>
<p>AUDIO</p> 	<p>Press to select audio mode such as SINGLE, MIX and MUTE. MUTE- All of 4 channels. SINGLE- Highlighted channel only. MIX- All of 4 channels.</p>
<p>ALARM</p> 	<p>Enable/disable alarm operation.</p>
<p>REC</p> 	<p>Perform continuous or manual recording for all channels.</p>
<p>SEARCH</p> 	<p>To enter into the SEARCH menu.</p>
<p>ESC</p> 	<p>To exit from each menu.</p>

## 4-2. SEARCH Screen

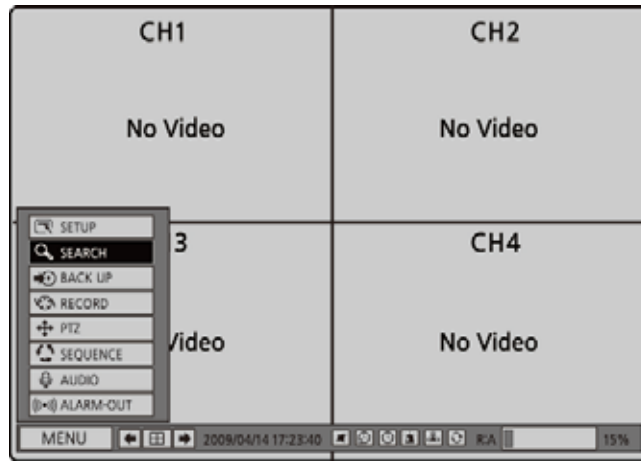

To enter the search screen, select MENU and SEARCH on the screen using the mouse or press SEARCH button on the front panel in live mode.

When you press the SEARCH button, DVR asks for a password as in Figure 4-2-1.

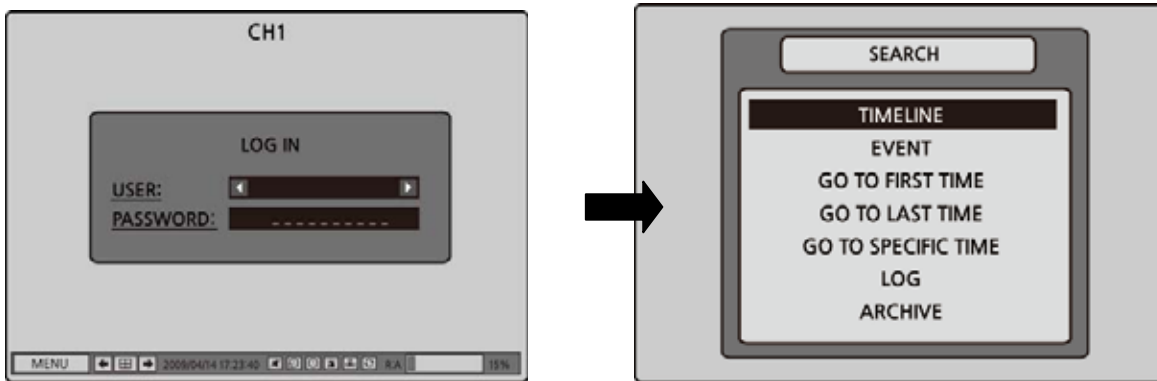

**Figure 4.2.1. Search Screen**

Enter the password using the control button (◀ ▲ ▶ ▼).

There are 7 ways of search menu such as TIMELINE, EVENT, GO TO FIRST TIME, GO TO LAST TIME, GO TO SPECIFIC TIME, LOG, and ARCHIVE on the screen.

### How to search data on the time line using the mouse or front key button



- ① 1 hour segment: 1-hour time bar(Mouse)/ F/REW and F/ADV button(Front key)
- ② 6 minute moving: ◀ 12:00:00 ▶ (Mouse)/ control button ◀ ▶ (Front key)
- ③ **Play: Double click on each channel number or ALL**

## 4-2-1. TIME-LINE Search

The TIME-LINE search window is used to find the stored video by using the time line bar.



Figure 4.2.2. Time-line Search

1. Select the date of the video to begin searching and navigate through the days using the control button (◀ ▲ ▶ ▼).
2. Once you have selected the date, press the SEL button to move to the time line search window.
3. Use the control button (◀ ▲ ▶ ▼) to select a time zone on the 24 hours time table.
4. Select All or a specific channel to search video clip on the time line bar using the control button (◀ ▲ ▶ ▼).
5. Once you select the channel, use the control button (◀ ▲ ▶ ▼) to move to the point you wish to start playing the video clip.
6. Once you have selected the time zone, press the SEL button to playback the recorded video.
7. Press the ESC to return to the SEARCH window.

**Note:** The recording mode is indicated as color on the time line screen.

**V: VIDEO (GREEN)**

**A: AUDIO (BLUE)**

## 4-2-2. Event Search

The Event Search window is used to find stored video. Three categories of search filters can be applied: DATE, CHANNEL and TYPE. Press SEL to select a value and move down to the next category and use the control button (◀ ▲ ▶ ▼) to move up to the categories you have previously entered. The ESC button will return the user to the previous screen.

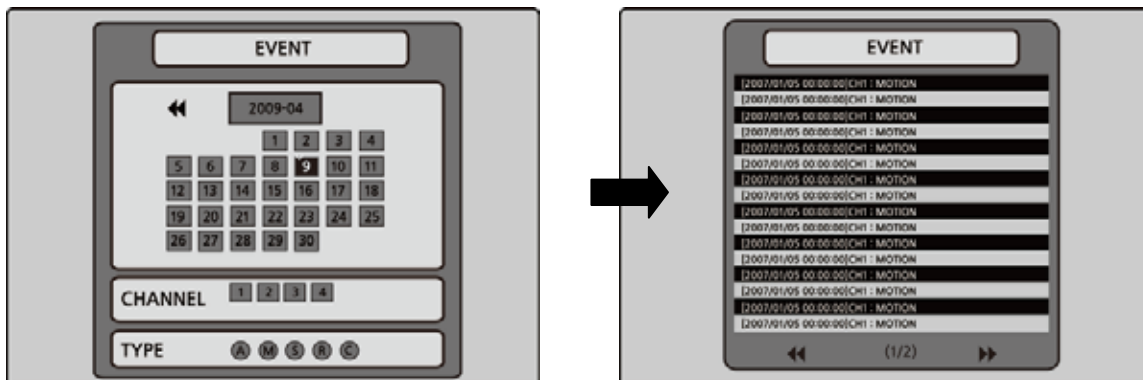

Figure 4.2.3. Event Search screen

1. Select the date of the video to begin searching. Use the control button (◀ ▲ ▶ ▼) to navigate through the days.
2. Once you have selected the date, press SEL to move to the CHANNEL selector.
3. Use the control button (◀ ▲ ▶ ▼) to change the channel selection from ALL to any of the available channels.
4. Once you have selected the channel, press SEL to move to the TYPE selector.
5. Use the control button (◀ ▲ ▶ ▼) to change the type of recording to ALL, MOTION, SENSOR, MANUAL, or CONTINUOUS.
6. Once you have selected the type of recording to search for, press SEL to produce a list of instances that fit your search criteria.
7. Use the control button (◀ ▲ ▶ ▼) to scroll through the on-screen listings.
8. Use the control button (◀ ▲ ▶ ▼) to display a list of events that happened previous to or after the current selection.
9. Once the desired event has been selected, press SEL to start playing back the selected video.
10. Press the BACKUP button to launch the archiving function in playback mode.
11. Press the ESC to return to the SEARCH window.

#### 4-2-3. Go To First Time

You can access the oldest recorded data on the DVR hard drive by selecting GO TO FIRST TIME on the SEARCH window. Press the ESC to return to the SEARCH window.

#### 4-2-4. Go To Last Time

You can access the latest recorded data on the DVR hard drive by selecting GO TO LAST TME on the SEARCH window. Press the ESC to return to the SEARCH window.

#### 4-2-5. Go To Specific Time

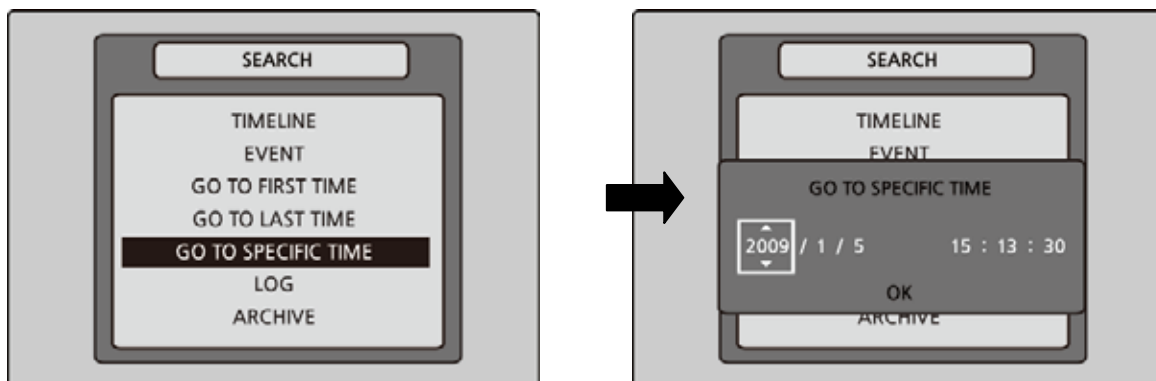

**Figure 4.2.4. Go To Search Screen**

You can search for video data from a specific instance by setting the date and time in the GO TO search window. Use the control button (◀ ▲ ▶ ▼) to move through the date and time values in this menu. Use the control button (◀ ▲ ▶ ▼) to change the date and time value. Move the cursor to OK using the control button (◀ ▲ ▶ ▼) and press the SEL to playback the recorded video.

## 4-2-6. Log Search

You can access the LOG list search screen by selecting LOG on the SEARCH window.

Select a date using the control button (◀ ▲ ▶ ▼) and press SEL to open the LOG list from that date.

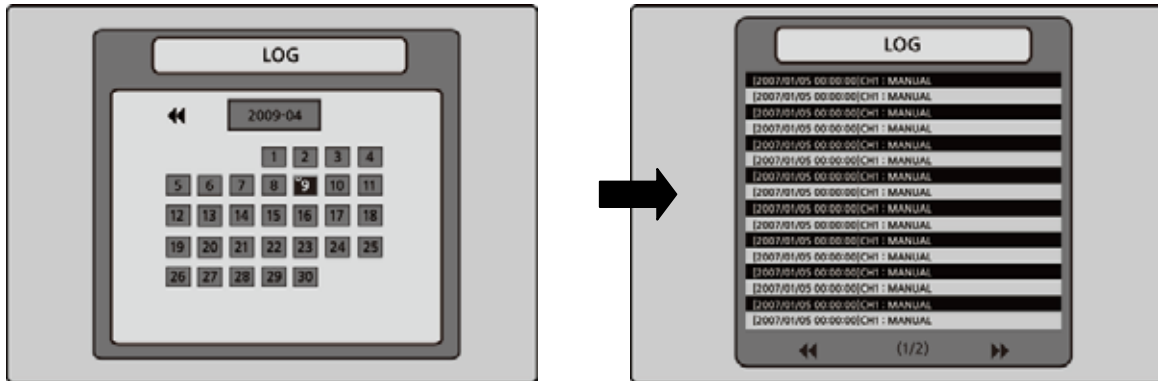

Figure 4.2.5. Log Search Screen

## 4-2-7. Archive Search

The ARCHIVE Search window is used to find previously stored video or images.

1. Select the date to begin searching and navigate through the days using the control button (◀ ▲ ▶ ▼).
2. Once you have selected the date, press SEL to open the list of stored data.
3. Use the control button (◀ ▲ ▶ ▼) to scroll through the on-screen listings.
4. Use the control button (◀ ▲ ▶ ▼) to display a list of stored events that happened previous to or after the current selection.
5. Once the desired event has been selected, press SEL to view the still image or the first frame of the selected video.
6. Press the BACKUP button to launch the archiving function in playback mode.
7. Press the ESC to return to the SEARCH window

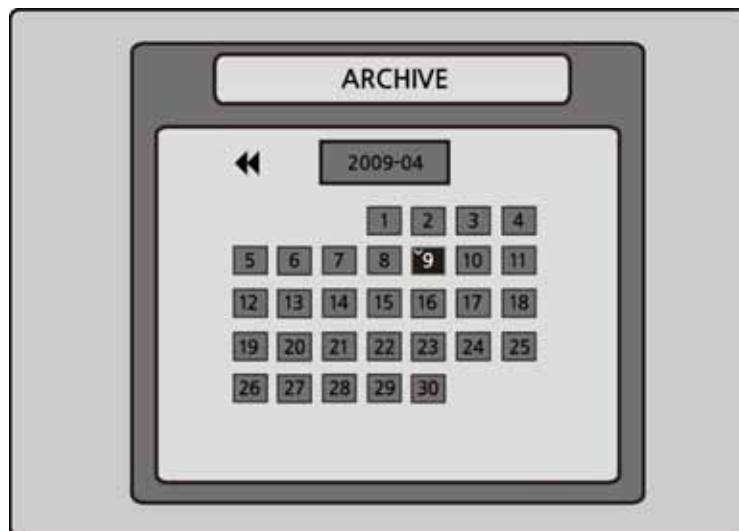

Figure 4.2.6. Archive Search Screen











### 4-3. Play mode

During playback of a recorded event, the mode changes from SEARCH to PLAY. While in PLAY mode, you may return to the SEARCH screen by pressing the ESC button.



**Figure 4.3.1. PLAY Mode Screen**

**Table 4.3.1. Button functions in PLAY Mode**

Button	Description
	Return to the previous menu screen, search window, or exit from the menu
	Press to rewind the footage at 1x, 2x, 4x, and 8x speeds. Reverse playback speed is shown as -1x(normal), -2x (2 times normal), -4x (4 times normal), and -8x (8 times normal) at the bottom right of the screen.
<p>AUDIO</p> 	Jump/Step backward. The playback position moves 60 seconds backward.
<p>SEARCH</p> 	Press to play or pause recorded video.
<p>ALARM</p> 	Jump/Step forward. Playback position moves 60 seconds forward.
	Press to fast forward the footage at 1x, 2x, 4x, and 8x speeds. Playback speed is indicated as +1x, +2x, +4x, and +8x for normal, twice, 4 times, and 8 times of the regular speed at the bottom right of the screen.
<p>BACK UP</p> 	Press to launch the archiving function.
	Press to launch the archiving function using the mouse.

## 5. PTZ Control

To control the PTZ functions of the camera, select MENU and PTZ on the screen using the mouse or press the PTZ button on the front panel.

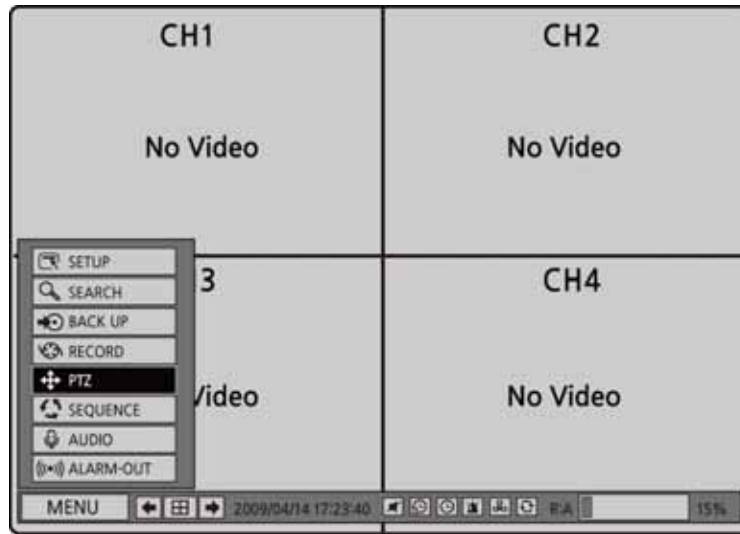

Select the item you wish to control the PTZ camera and control them using the control button (◀ ▲ ▶ ▼). Please refer to the table 5.1.1. for the control.

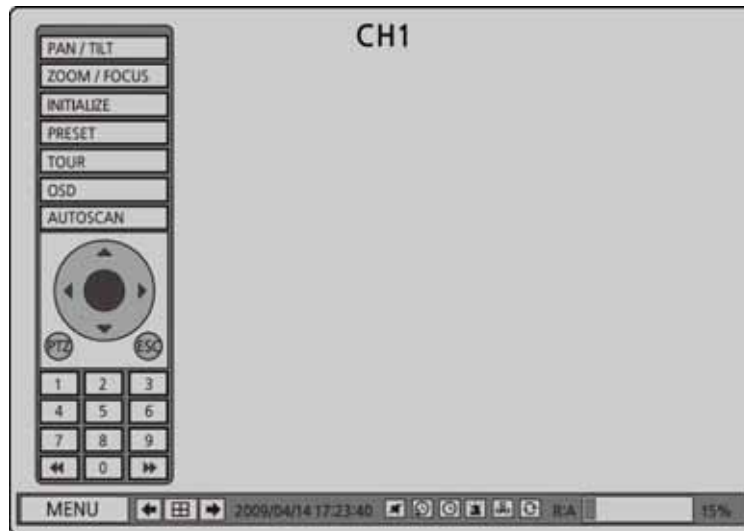

Figure 5.1.1. PTZ Control Screen

Table 5.1.1. Button Functions in PTZ Control

Item	Description
<b>PAN / TILT</b>	Select PAN/TILT using the control button (◀ ▲ ▶ ▼) and press SEL button. Adjust the tilt(UP/DOWN)/pan(LEFT/RIGHT) position using the control button (◀ ▲ ▶ ▼).
<b>ZOOM / FOCUS</b>	Select ZOOM/FOCUS using the control button (◀ ▲ ▶ ▼) and press SEL button. Adjust the zoom(UP/DOWN)/focus(LEFT/RIGHT)position using the control button(◀ ▲ ▶ ▼).

<b>INITIALIZE</b>	Initialize the PTZ settings of the selected camera.
<b>PRESET</b>	Select the PRESET and press the left key (◀) on the control button. Then, number input window will appear. Set the number (3 digits) using the number key and press the SEL to set the preset number for the current position. Press the right key (▶) on the control button and set the number (3 digits) to go to the preset number.
<b>TOUR</b>	Select the TOUR and press the right key (▶) on the control button. Then, number input window will appear. Set the number (1 digit) using the number key and press SEL to make the group number work. Press the left key (◀) on the control button to stop tour. User can set the preset number in the tour group of the OSD menu.
<b>OSD</b>	Select the OSD to enter the menu. Control keys are Right, Left, UP, Down, Select, Far (REW KEY), and Near (FF KEY). Press the ESC button to return to the main menu. Press the PTZ button to escape from the OSD menu.
<b>AUTOSCAN</b>	Press the right key (▶) on the control button to start auto scan Press the left key (◀) on the control button to stop auto scan.
<b>PTZ</b>	Press the PTZ button to escape from the OSD menu.
<b>ESC</b>	Press the ESC button to return to the main menu.
<b>NUMBER</b>	Available only on the TOUR and PRESET menu.
◀◀ ▶▶	Available only on the OSD menu. ◀◀ : Far / ▶▶ : Near

- **Preset/ Tour/ OSD/ Autoscanner function are available on the specific model AP8777 and PMA-200.** (Select it in the NAME of PTZ setup menu)

**Table 5.1.2. Description of RS-485 port**

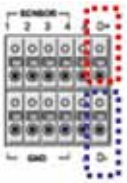
	RS-485: D+	Data +
	RS-485: D-	Data -

## 6. Back up

### 6-1. Still Image backup onto USB flash memory

Still images can be captured and archived onto the USB stick or hard drive in live mode or while playing back recorded video.

In live mode, press the BACKUP button to launch the archive function or select MENU and BACK UP on the screen using the mouse.

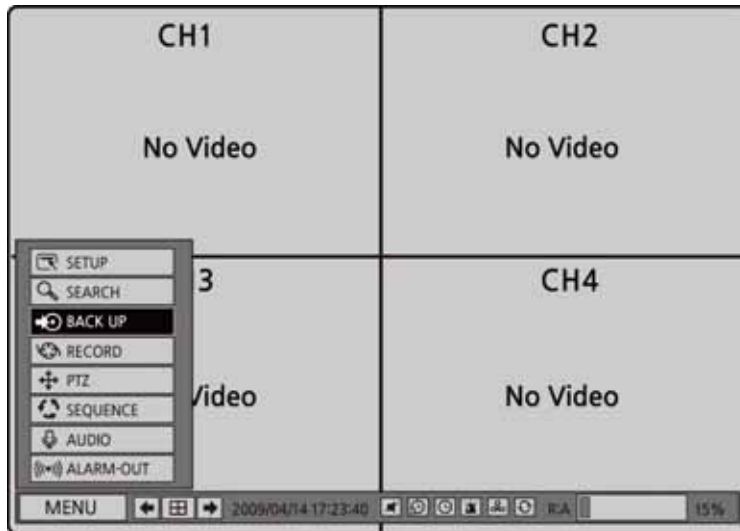

1. When you press BACKUP button, the archiving screen will display as Figure 6.1.1.
2. And the DVR will ask which media you will take for archiving.
3. Once you select the media, the system will start to archive the data to the selected media.

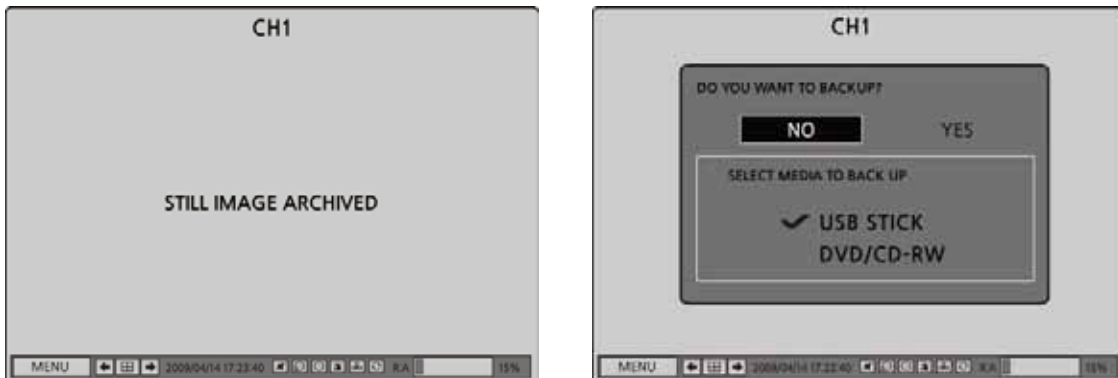

Figure 6.1.1. Still Image Archiving and Backup Screen

### 6-2. Video backup onto USB flash memory

Video can be captured and archived onto the USB stick or hard drive while playing back recorded video.

In playback mode, press the BACKUP button to launch the archiving function.

1. When you press BACKUP button, the DVR will ask whether to archive a Still Image or Video clip.
2. If the user selects VIDEO, the DVR will ask which media you will take for archiving.
3. If the user selects VIDEO, the DVR will ask for the setting of the archiving duration.
4. Once you select the media, the system will start to archive the data to the selected media.

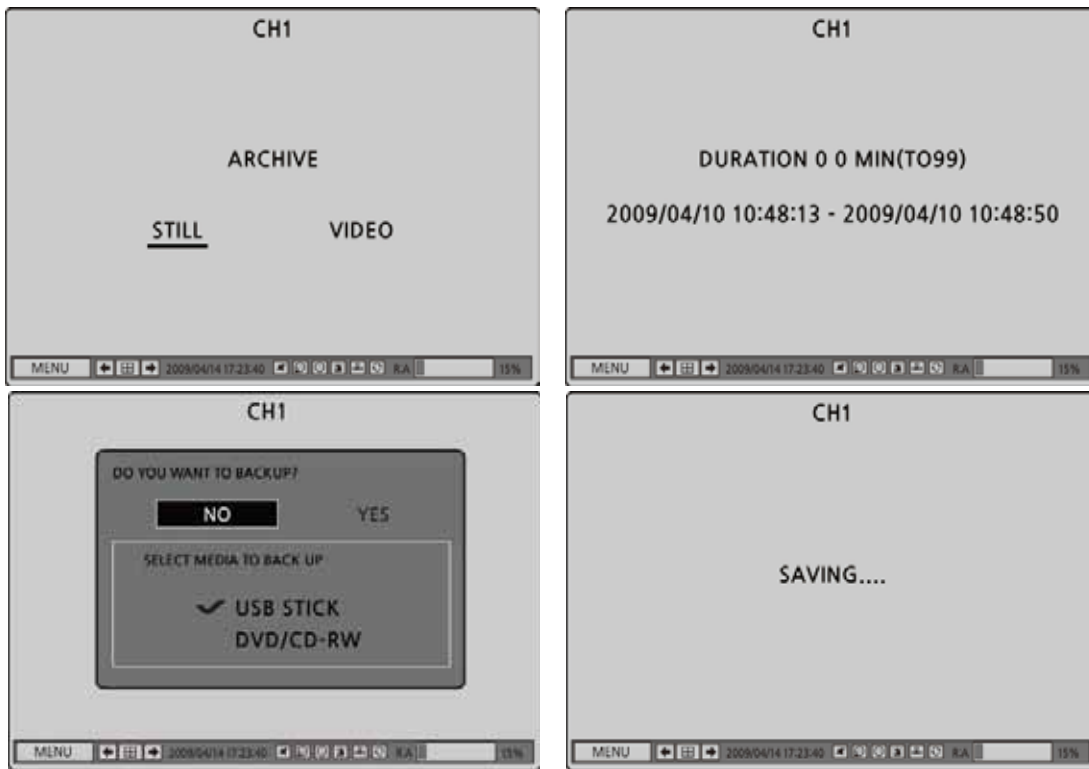

Figure 6.2.1. Video Archiving and Backup Screen

The DVR will convert the corresponding portion of the video into an AVI file.

### 6-3. Transferring still images or video from the ARCHIVE list

The stored data onto hard drive will be found in the ARCHIVE list in SEARCH window.

User can back up still images or video into the storage device from the ARCHIVE list.

1. Select the date to begin searching and navigate through the days using the control button (◀ ▲ ▶ ▼).
2. Once you have selected the date, press SEL to open the list of stored data.
3. Use the control button (◀ ▲ ▶ ▼) to scroll through the on-screen listings.
4. Select a list of stored events that happened previous to or after the current selection.
5. Once the desired event has been selected, press SEL to view the still image or the first frame of the selected video.
6. Press the BACKUP button to launch the archiving function in playback mode.
7. Press the ESC to return to the SEARCH window.

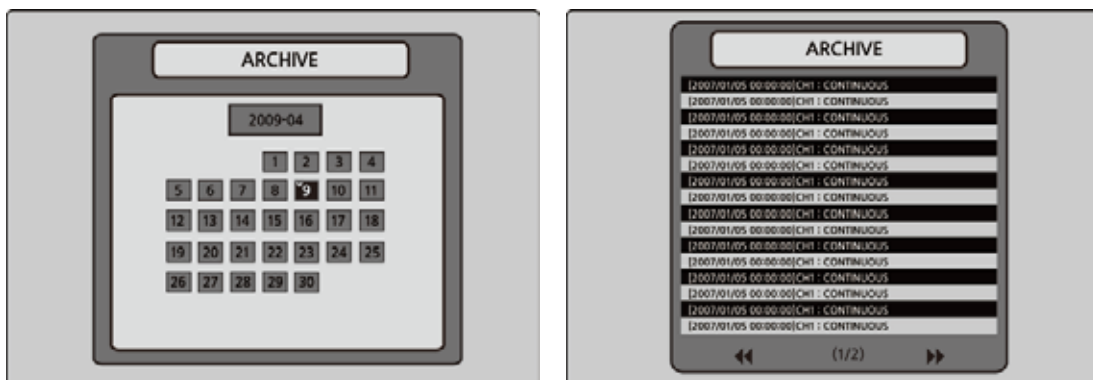

Figure 6.3.1. Archive Search Screen

## 6-4. Playback of Backup Video

- **AVI format:** AVI format video can be played back by Window Media Player™ or other media player that is compatible with AVI format video. If the video cannot be played with standard video software, install FFDSHow (Codec)from the supplied CD-ROM.
- **NSF format:** NSF format video can be played back by the player (the DVR player) that the DVR copies on USB thumb drive with video.

Three files are copied on USB thumb drive

- NSF file: NSF format video file.
- SMI file: Title file of date and time.
- PLAYER: Exclusive video viewer.



## 7. Upgrading Firmware

In order to upgrade, the firmware upgrade file must first be downloaded and copied into the USB memory stick. Create a new folder in the USB memory stick and name it “upgrade”. Copy the firmware upgrade file “apph\_XXXXXX.bin” for 16CH DVR, “apph\_XXXXXX.bin” for 9CH DVR or “apph\_XXXXXX.bin” for 4CH DVR into the “upgrade” folder.

---

### NOTICE

The folder on the USB memory stick must be named “**upgrade**”.

After the firmware upgrade file is copied into the USB memory stick, connect the USB memory stick to the USB port on the front panel and do the followings:

---

1. Press the SETUP button and enter the admin password.
2. Go to SECURITY setup menu and USER PASSWORD. Press SEL and select ADMIN using the control button (◀ ▲ ▶ ▼).
3. Enter the password as “**123412341**”, and press the SEL button.
4. The TEST MODE screen “Diagnostics Vx.xx” will appear.
5. Select USB Upgrade. Then the upgrading will start automatically.
6. After the upgrade is completed, select Boot Application to reboot DVR.

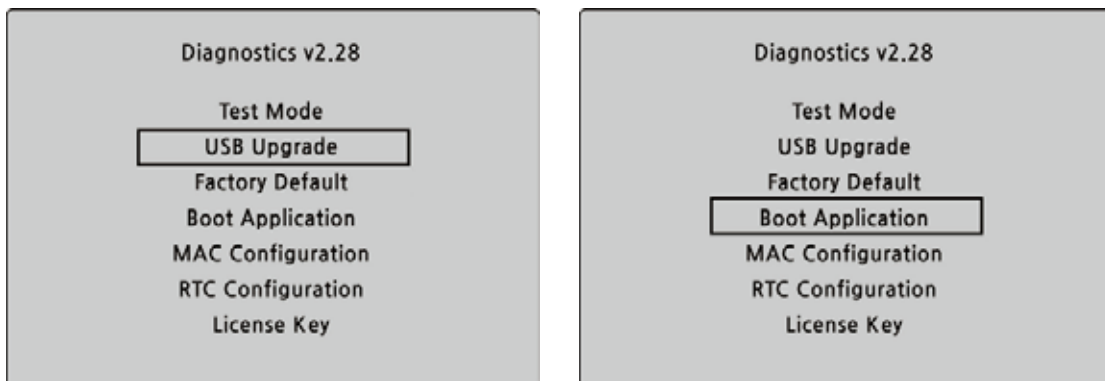

**Figure 7.1.1. Engineering mode screen**

## 8. Network access using the Exclusive network viewer

The DVR provides a live remote monitoring feature. Remote monitoring requires installation of the network viewer on your PC.

### NOTICE

In a high bandwidth network, a maximum of four users can access one DVR simultaneously. In a low bandwidth network it is recommended that only one user access the DVR at a time.

### 8-1. PC requirements

- CPU: Intel Pentium IV 1.4Ghz or higher
- Memory: 512MB (1GB or higher is recommended.)
- VGA memory: 16MB (64MB or higher is recommended.)
- Resolution: 1024x768
- O/S: Windows 2000, XP Professional, XP home
- Direct X: DirectX 8.1 or higher

### 8-2. Installing the network viewer

1. Insert the provided CD in the CD drive and double-click “UMSClient(XXXX).exe”

2. Select a destination folder and click “Next”.

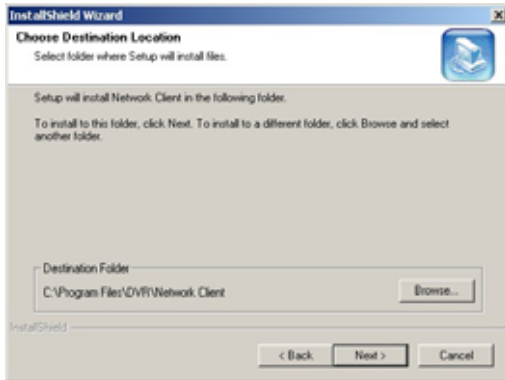

3. Select the type and click “Next”.

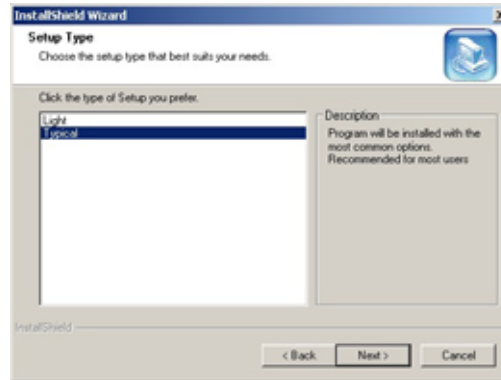

4. Select the program folder and click “Next”.

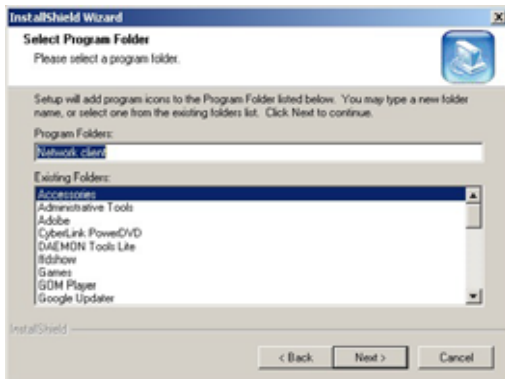

5. The setup status screen is displayed.

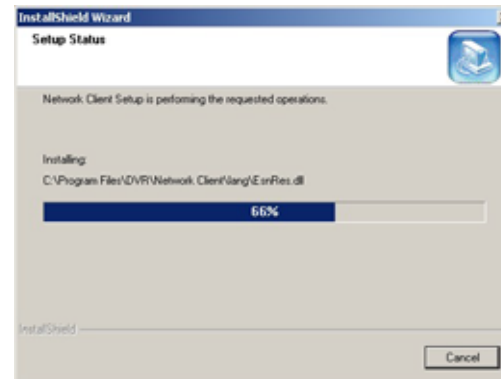



After the installation is completed, “UMS Client” icon is displayed on the desktop.



### 8-3. Live monitoring mode and functions.



Button	Function	Description
	<b>DATE &amp; TIME</b>	Displays the current date and time.
	<b>CONNECT/DISCONNECT</b>	Connect/disconnect network connection..
	<b>SEARCH</b>	Switches the live mode to search mode.
	<b>DISPLAY MODE</b>	Select a channel and screen display mode.
	<b>PAN/TILT/ZOOM/ FOCUS</b>	Control the PAN/TILT/ZOOM/FOCUS features on the remote camera.
	<b>CAPTURE</b>	Capture a still image from live screen.
	<b>PLAY/PAUSE</b>	Play/pause live video.
	<b>ALARM</b>	The ON/OFF button of the alarm output of the DVR. When an alarm of the DVR is output, this button becomes Red.
	<b>SETUP</b>	Display the setup screen of the network viewer.
	<b>HDD USAGE</b>	DVR HDD storage Indicator.
	<b>NETWORK BANDWIDTH</b>	Shows the transferred frames and network bandwidth.

	<b>AUDIO</b>	Adjust the volume. The audio can be turned on or off by clicking the audio icon.
	<b>LOG WINDOW</b>	

### Operations of the display mode of the main screen

- Single channel display - Click the one of channel button or double-click the channel screen.



- QUAD/-screen display - Click the QUAD button to switch to quad-screen display

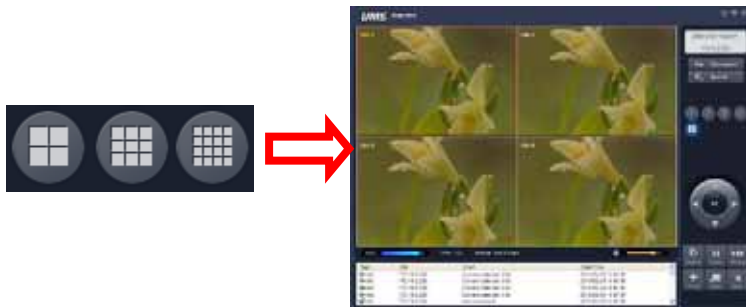

- Full screen display - Click the maximize button to display only screen and hidden the operation panel.



### Image capture of live screen

Still-image of live screen can be captured and saved as BMP or JPEG file.

1. Click the channel to be captured. Then the channel screen is surrounded with a red line.
2. Click the CAPTURE button. Then the IMAGE CAPTURE dialog is displayed.

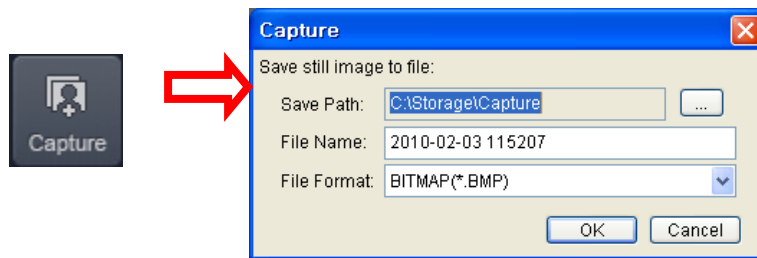

3. Set the conditions and click OK button. Then still-image is saved.







#### 8-4. Bi directional audio

The UMS Client allows for bi directional audio between the client and a dvr unit. On the PC, to use bi directional audio, you will need a sound card of handling a microphone and speakers. On the dvr side, you will need to connect a microphone to the audio in connection, and a pair of amplified speakers to the audio out connection.

#### 8-5. Remote search mode and functions

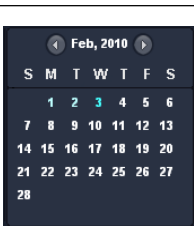
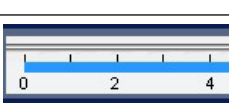

Button	Function	Description
	<b>DATE &amp; TIME</b>	Displays the recording time of the data selected on the time bar at the bottom of the main user interface.
	<b>DISCONNECT</b>	Disconnect network connection..
	<b>LIVE</b>	Switches the search mode to live mode.

	<b>CAPTURE</b>	Capture a still image from live screen.
	<b>MARK IN</b>	Set the start time for video backup.
	<b>MARK OUT</b>	Set the ending time for video backup.
	<b>BACKUP</b>	Backup the selected recorded video as AVI format.
	<b>SEARCH CALENDAR</b>	The calendar shows dates with recorded video in a light blue and the selected date in dark blue.
	<b>TIMELINE BAR</b>	The timeline shows recorded data in dark blue on the bar.
	<b>PLAYBACK BUTTON</b>	The playback buttons.
	<b>DISPLAY MODE</b>	Select a channel and screen display mode.

### Searching and playing video in the remote DVR

Video recorded in the remote DVR or Video recorded on the PC can be searched and played back.

1. Connect the network to the remote DVR and press SEARCH button. Then the mode is changed from the live mode to the search mode.

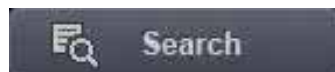

- Searching the video recorded in the remote DVR: Connect the network to the DVR..
- Searching the video recorded in the PC: Do not connect the network to the DVR.

2. Select the date to search the video.

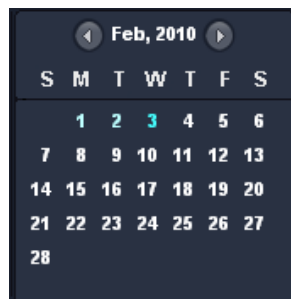

3. Drag the slid on the time scale and drop it between 0 to 24.

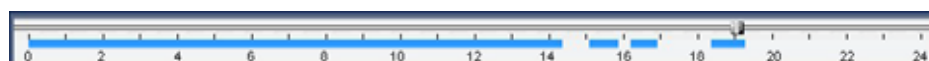

4. Press the PLAY button. Then the video recorded in the remote DVR is played back.



### Backup of video in the remote DVR

Video recorded in the remote DVR can be backed up on the PC HDD as AVI format.

1. Connect the network to the remote DVR and play the video recorded in the remote DVR.
2. Drag the slid on the time scale and drop to the start time for video backup and press the MARK IN button.

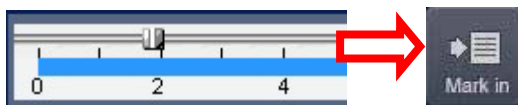

3. Drag the slid on the time scale and drop to the end time for video backup and press the MARK OUT button. Then the marked time is displayed in dark green.



4. AVI Backup dialog is displayed. Click the OK button. Then the marked video is backed up.

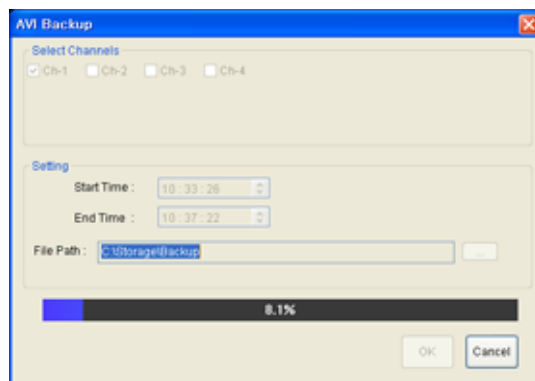

- Start time / Stop time: Backup time can be changed.
- File path: Shows the folder that the backup file is recorded.
- Channel: Shows backup channel..

## 8-6. PC System configuration

Click the SETUP button. Then the Setup dialog is displayed.

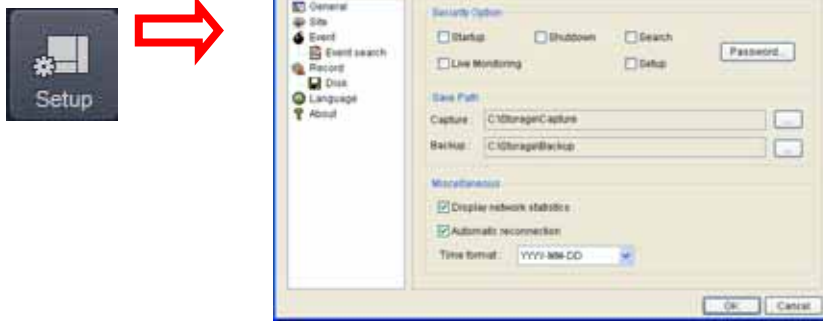

### Setting General

Set the Security Option, Save Path, and Miscellaneous.

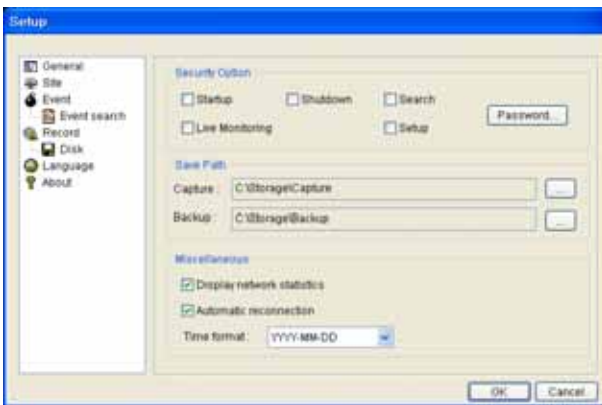

- **Security Option:** Set a password for security options. When you access any of the selected functions, you will need to enter the password.
- **Save Path:** Specify the location to record for backup and still image capture.
- **Automatic reconnection:** If a user selects this function, the client S/W will automatically try to connect to the previously connected IP address if the network connection is lost.
- **Display network statistics:** If a user selects this function, the client S/W will display network status, Bit rate and Frame rate.
- **Time Format:** Change the mode the Client software displays the time.

### Setting Site

The remote DVRs can be added, modified, and removed.

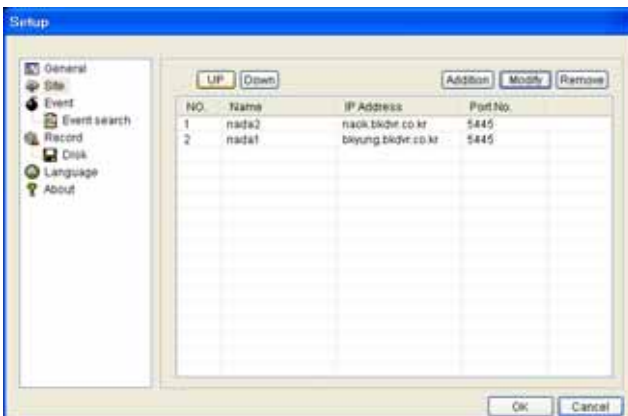

## Setting Event

Set the record path and the size of local disk space for the log files.

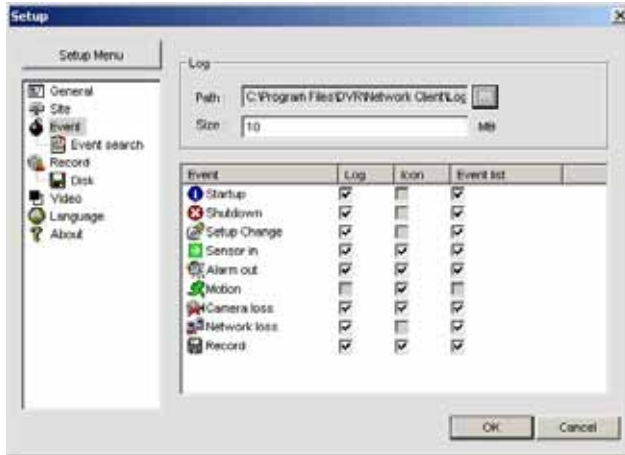

- LOG – Select to save event log into 'log file'.
- ICON – Select to display the event on live video.
- EVENT LIST – Select to show the event in the 'Event List' window of live mode.

Search and check the recorded log data.

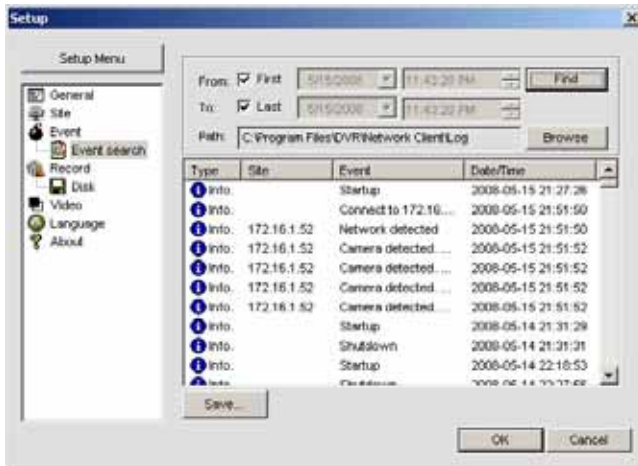

## Setting Record

Set the recording conditions and select channels to record.



Select the local disk to use and the amount of disk space you want to allow the program to use for recording.



## 9. Network – By an web-browser viewer

The DVR provides a live remote monitoring feature by web-browser viewer.

1. Check the IP address of the DVR from SETUP>SYSTEM>DESCRIPTION>IP ADDRESS.



2. Input the IP address or Domain name address that you pre-registered on [www.ddnscenter.com](http://www.ddnscenter.com) on the address field and press “Go”.

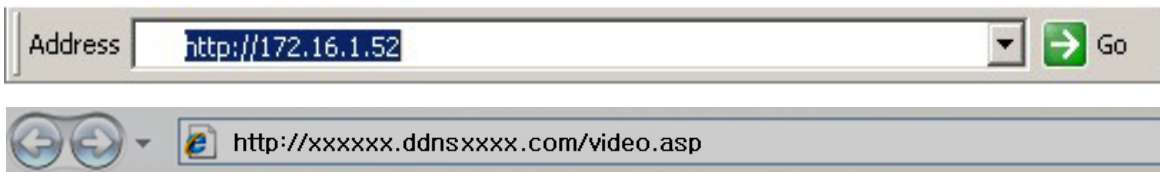

3. Click this bar. Then the dialog box is displayed.



4. Click “Install” to download ActiveX control.



5. Web Browser Viewer is displayed as bellow.



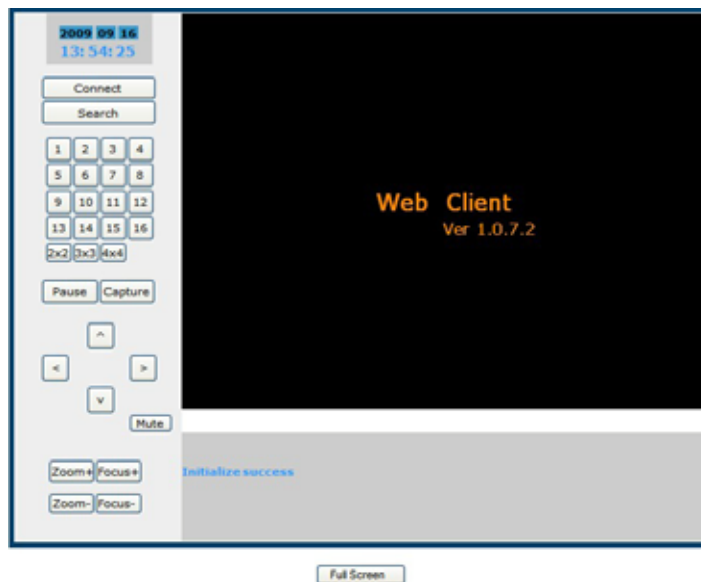

- Click CONNECT button on the Left upper corner of web-viewer. Then “Connect” dialog is displayed. Enter IP address (or Domain name address that you pre-registered on [www.ddnscenter.com](http://www.ddnscenter.com)), Port number and Password and click “Connect”

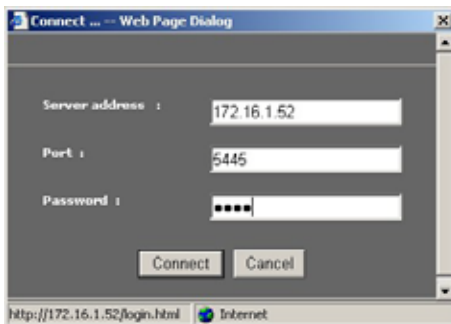

- Server address: Input IP address of the DVR from SETUP>SYSTEM>DESCRIPTION>IP ADDRESS or Domain name address that you pre-registered on [www.ddnscenter.com](http://www.ddnscenter.com)
- Port: Input Port number (The number sets on SETUP>NETWORK>PORT)
- Password: Input Password **“11111111”** (The number sets on SETUP>SYSTEM>NETWORK PASSWORD)

- Then the cameras connected to the DVR are displayed on the screen.

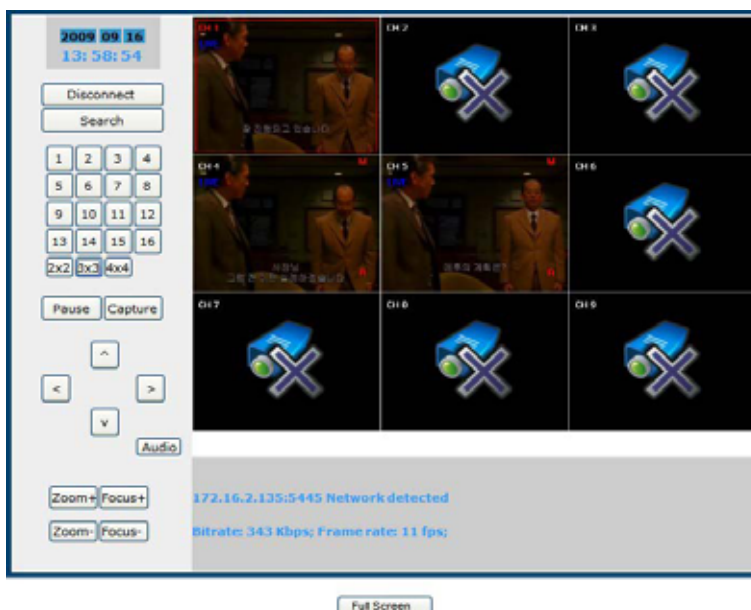

## 10. Network – By Mobile phone viewer

User can access the remote DVR over mobile phone (i-Phone). User doesn't need to install specific exclusive viewer or specific codec on the mobile devices. User can monitor video in jpeg format on the browser.

### Web viewer and Mobile-phone web viewer Network access beyond Router

In order to access beyond Router (Firewall), user must open 1 TCP port that is set on NETWORK > WEB PORT. If this port is not open properly, user can not access DVR using direct Web viewer or Mobile-phone web viewer. (Example: When NETWORK > WEB PORT is set as 80, 80 TCP port of IP address of DVR must be open.)

1. Enter the IP address on the URL address window of web browser on mobile phone as below.

***http://{ip address | domain name}/mview***

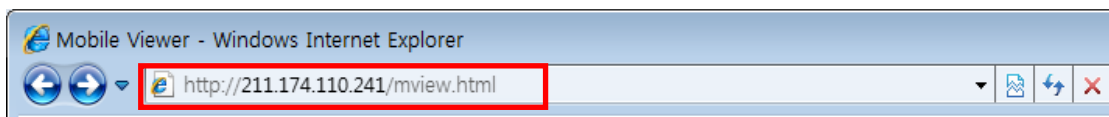

2. THE INITIAL SCREEN / CHANNEL SELECTION: When the user enters the IP address or domain name / user will find the initial screen to select channel as following.



3. Select the channel you want to watch.

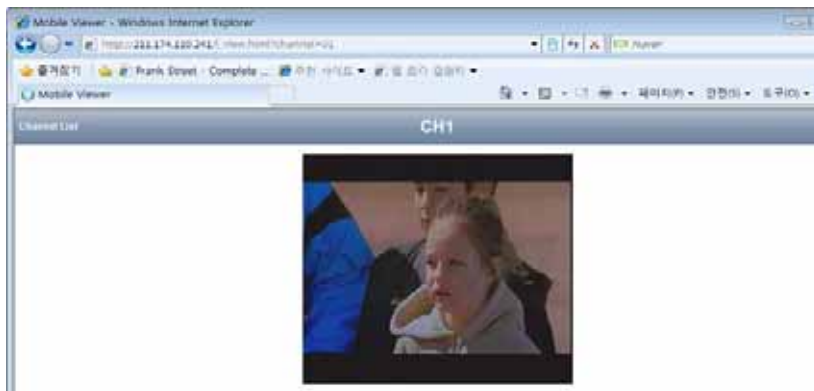

4. Select Channel List to move to another channel

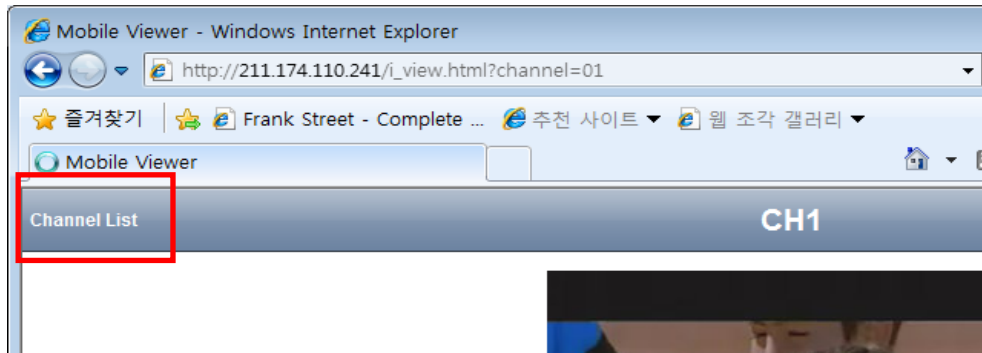

# APPENDIX: How to connect network

## A. How to set IP address of the DVR and open TCP port of the router?

The port forwarding is dependent on the brand and model of the router. The port forwarding is required to allow access to the DVR beyond a router.

1. Connect network cable between DVR and Router or ADSL modem.



2. Default network setting on DVR are
  - Port : 5445, WEB Port : 80, Network : DHCP
3. From PC connected in the same Router, find IP address, Gateway, and Subnet mask by IPCONFIG command in command prompt.

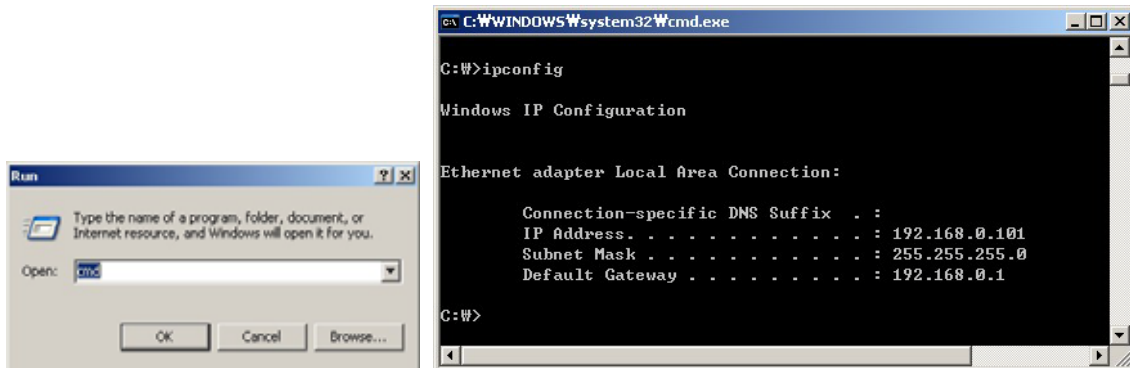

4. But if IP is something else like 192.168.x.xxx., you should change IP address, Subnet, Gateway on the DVR. Go to SETUP>NETWORK>LAN of the DVR and change the IP settings to be like IP: 192.168.XXX.XXX and Gateway: 192.168.XXX.XXX. (Refer to the user's manual of Router.)

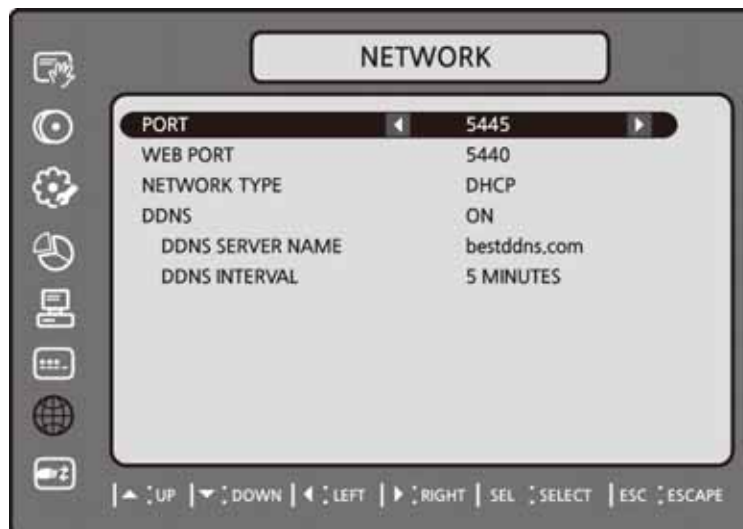

- Open your web browser. Enter the router IP address in the address bar (The router IP address are different with the brand and model.), click GO.

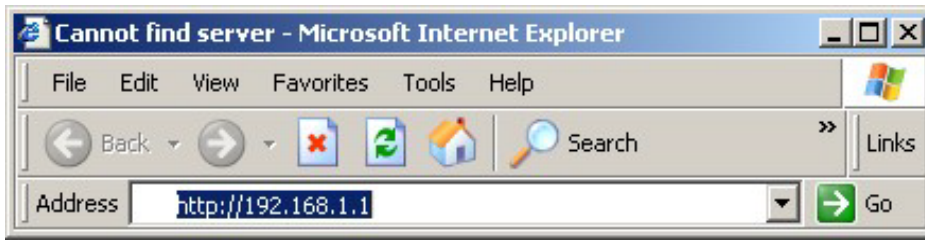

- Enter the user name and password (**admin** is default) and press the **OK** button.

A screenshot of a login dialog box. It has a "User name:" label with a dropdown menu showing "admin". Below it is a "Password:" label with a text box containing six asterisks. There is a checkbox labeled "Remember my password" which is currently unchecked. At the bottom are "OK" and "Cancel" buttons.

- Select the Port Range Forwarding tab.



- Enter the each field.
  - Application: Enter a description of the DVR (Example: store1)
  - Start: Enter the first number of the port you need to port forward (Example: 5445)
  - End: Enter the last number of the port you need to port forward (Example: 5445)
  - Protocol: Select Both.
  - IP address: Enter the IP address of the DVR on SETUP>NETWORK>LAN>IP ADDRESS.
  - Enable: Check the enable box.
- Select the Save settings button located on the bottom of the window. Then Port forwarding is finished.



### Network access beyond a router

In order to access the DVR remotely beyond a router (firewall), the user must open TCP port for command level, live channels and storage channels. User need to open 2ports numbers.

If the DVR port number is set to 5445, open the TCP port 5445 and 5446 on the router.

If this port is not opened properly, user can not access DVR beyond a router.

### Web viewer and Mobile-phone web viewer Network access beyond Router

In order to access beyond Router (Firewall), user must open 1 TCP port that is set on NETWORK > WEB PORT. If this port is not open properly, user can not access DVR using direct Web viewer or Mobile-phone web viewer. (Example: When NETWORK > WEB PORT is set as 80, 80 TCP port of IP address of DVR must be open.)

You can learn how to port forward many kinds of Routers from the bellow site.

[http://www.portforward.com/english/routers/port\\_forwarding/routerindex.htm](http://www.portforward.com/english/routers/port_forwarding/routerindex.htm)

## B. How to access DVR from Remote PC?

### LAN Connection – Using a switching hub

Connect to the system, using a hub (Switching hub) and an Ethernet cable (10BASE-T/100BASE-TX CAT 5 LAN cable)

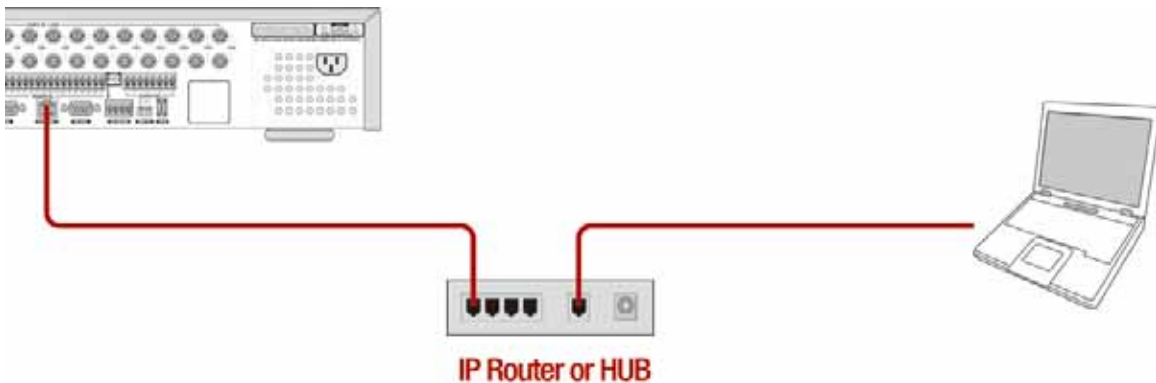

1. Run the pre-install the network client software on the supplied CD. (Refer to Chapter 6. Network access using the Exclusive network viewer)
2. Check the IP address from SETUP>SYSTEM>DESCRIPTION of DVR.
3. Run network client software and click CONNECT button.

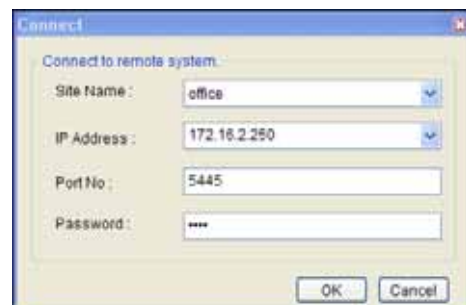

4. Input IP address, Port No., and Password on the connect window. And click OK.



## Internet (ADSL) Connection using DDNS

Connect to the system, using an Router or ADSL modem and an Ethernet cable (10BASE-T/100BASE-TX CAT 5 LAN cable)

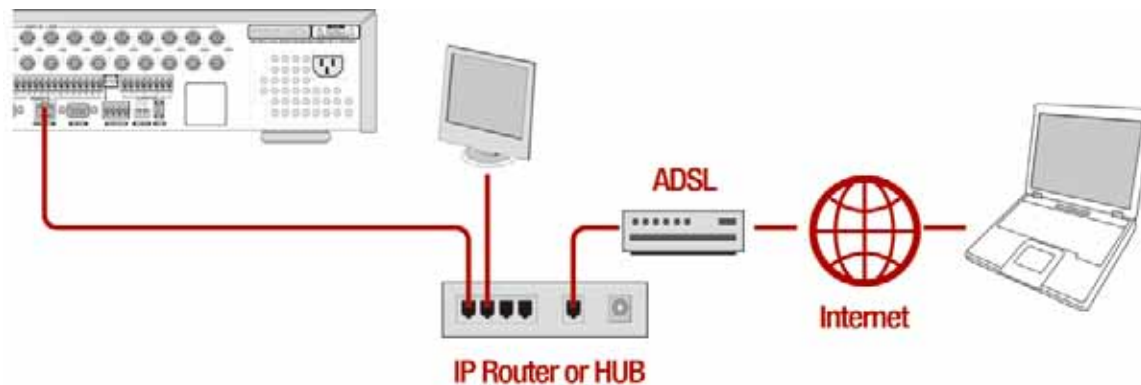

1. Go to SETUP>NETWORK. Set NETWORK TYPE as DHCP and DDNS SERVER as ON. And make sure that DDNS SERVER NAME is ddnscenter.com
2. Go to Setup menu of Router and open TCP port 5445 using Port Forwarding. (Refer to A. How to set IP address of the DVR and open TCP port of the router?)
3. Confirm the Mac address and Serial No. from the label of the rear panel of the DVR.
4. Open the web browser and log on <http://www.ddnscenter.com>

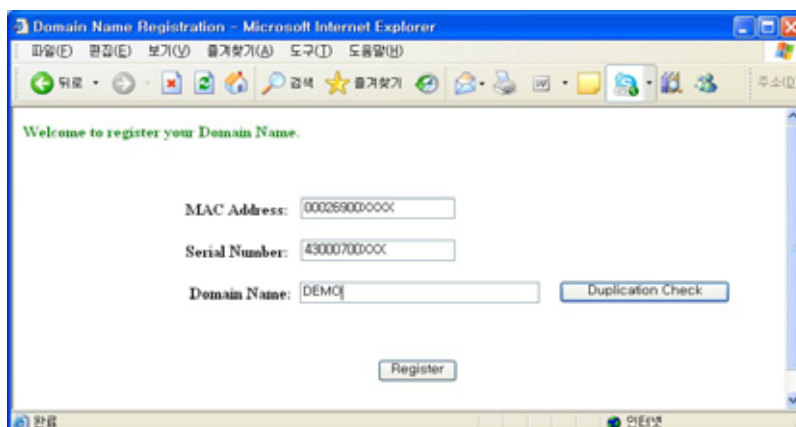

- MAC Address: Input the Mac address (EX. 0002690XXXXX) without a space.
- Serial Number: Input the Serial Number (EX. H0410E1000XXX.) without a space.

5. Domain Name: Input Domain Name for your DVR system
6. Click the DUPLICATION CHECK button to see if the domain name is available.
7. If you see the screen "You can use the Domain name you entered" then click RETURN and click REGISTER button to complete the registration.
8. Run the pre-install the network client software on the supplied CD. (Refer to Chapter 6. Network access using the Exclusive network viewer)



9. Click  button and add the DVR as necessary.

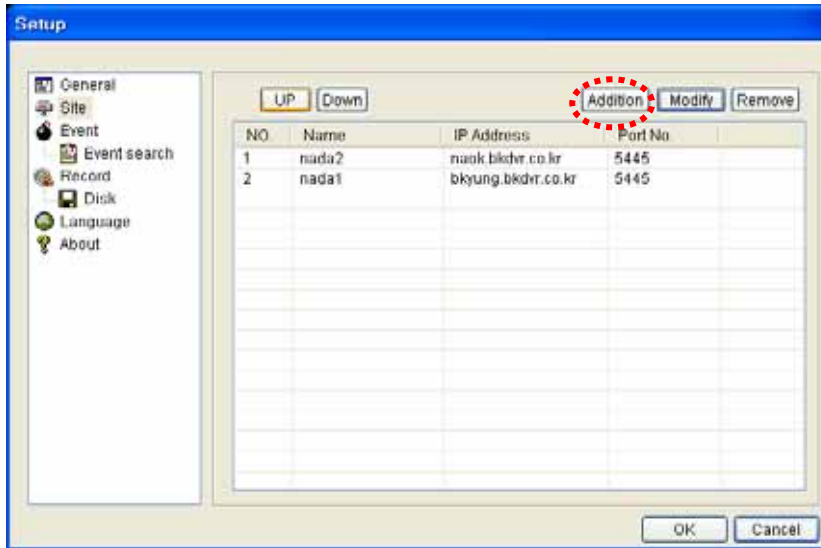

- Site Name: Input the name of the DVR.
- IP Address: Input the Domain Name that is registered on <http://www.ddnscenter.com> (EX. XXXXX.ddnscenter.com)
- Port Number: Input the port number.
- Protocol: Select TCP.
- Password: Input the network password.

Click Connect button. Then the Connect window is displayed.

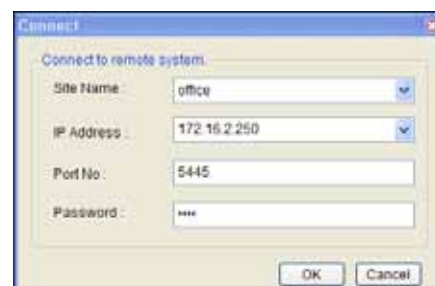



10. Select the site that you will access and click OK.

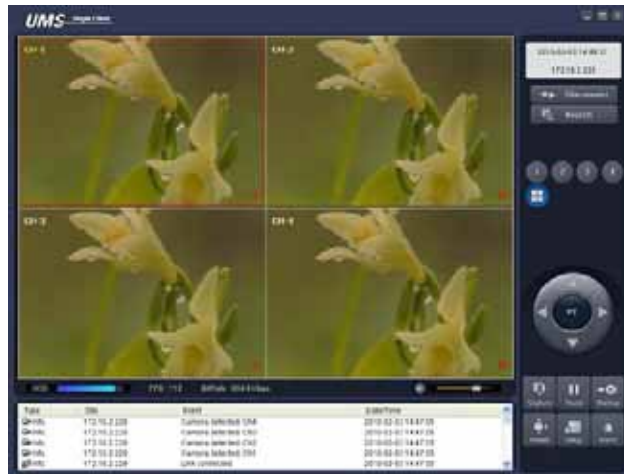

## Free Manuals Download Website

<http://myh66.com>

<http://usermanuals.us>

<http://www.somanuals.com>

<http://www.4manuals.cc>

<http://www.manual-lib.com>

<http://www.404manual.com>

<http://www.luxmanual.com>

<http://aubethermostatmanual.com>

Golf course search by state

<http://golfingnear.com>

Email search by domain

<http://emailbydomain.com>

Auto manuals search

<http://auto.somanuals.com>

TV manuals search

<http://tv.somanuals.com>