

INSTRUCTION MANUAL

STANDALONE 4CH DVR DIGITAL VIDEO RECORDER

MODEL: CDR 4170

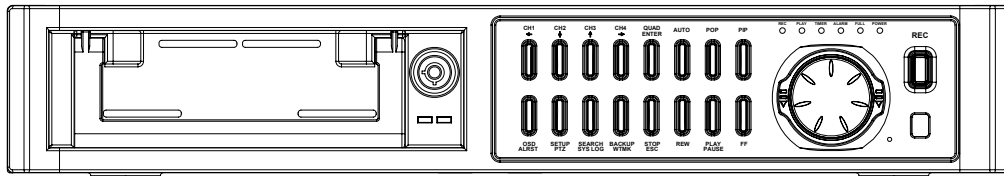

Copyright © 2006 Clover Electronics U.S.A. All Rights Reserved.

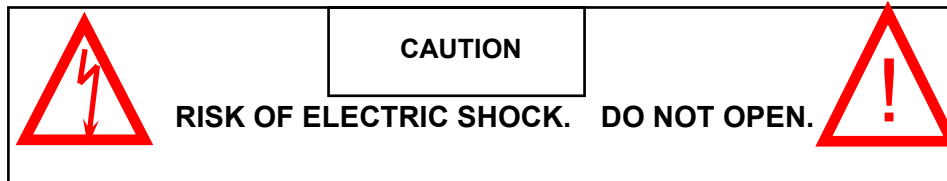

CAUTION! TO REDUCE THE RISK OF ELECTRIC SHOCK, DO NOT REMOVE COVER (OR BACK). NO USER-SERVICEABLE PARTS INSIDE. REFER SERVICING TO QUALIFIED SERVICE PERSONNEL.

Explanation of two Symbols



The lightning flash with arrowhead symbol, within an equilateral triangle, is intended to alert the user to the presence of un-insulated "dangerous voltage" within the product's enclosure that may be of sufficient magnitude to constitute a risk of electric shock to persons.



The exclamation point within an equilateral triangle is intended to alert the user to the presence of important operating and maintenance (servicing) instructions in the literature accompanying the appliance.

THE GRAPHIC SYMBOLS WITH SUPPLEMENTAL MARKING ARE ON THE BOTTOM OF THE SYSTEM.

“WARNING – TO PREVENT FIRE OR SHOCK HAZARD, DO NOT EXPOSE THE UNIT TO RAIN OR MOISTURE”

NOTE :

This equipment has been certified and found to comply with the limits regulated by FCC, EMC and LVD. Therefore, it is designed to provide reasonable protection against interference and will not cause interference with other appliance usage.

However, it is imperative that user follows this manual's guidelines to avoid improper usage which may result in damage to the unit, electrical shock and fire hazard or injury.

In order to improve the feature functions and quality of this product, the specifications are subject to change without notice from time to time.

FCC CLASS B NOTICE**NOTE:**

This equipment has been tested and found to comply with the limits for a Class B digital device, pursuant to Part 15 of the FCC Rules. These limits are designed to provide reasonable protection against harmful interference in a residential installation. This equipment generates, uses and can radiate radio frequency energy and, if not installed and used in accordance with the instruction, may cause harmful interference to radio communications. However, there is no guarantee that interference will not occur in a particular installation. If this equipment does cause harmful interference to radio or television reception, (which can be determined by turning the equipment off and on), the user is encouraged to try to correct the interference by one or more of the following measures:

Increase the separation between the equipment and the camera and/or monitor.

Connect the equipment into an outlet on a circuit different from that to which the other electrical devices are connected.

Consult the dealer or an experienced radio or television technician for help.

CONTENTS

1. GENERAL PRECAUTIONS	1
2. SPECIFICATIONS	3
3. OPERATION	5
3.1 FRONT PANEL	5
3.2 BACK PANEL	9
4. BASIC CONFIGURATION OF THE MONITOR SCREEN	10
4.1 START UP	10
4.2 LIVE SCREEN	11
4.3 RECORDING SCREEN	12
4.4 PLAYBACK SCREEN	13
4.5 RECORD AND PLAYBACK SCREEN	14
4.6 LIVE	15
4.7 RECORDING	16
4.8 PALLYBACK	17
5. SETUP	20
5.1 SETUP DISPLAY TREE	20
5.2 HOW TO SETUP	23
5.3 ALARM	23
5.4 MOTION	24
5.5 SYSTEM	25
5.6 VIDEO	29
5.7 RECORD	30
5.8 DISPLAY	31
5.9 BUZZER	32
5.10 ACCOUNT	32
5.11 DDNS	34
6. INSTALL THE HDD	36
6.1 INSTALL THE HDD1	36
6.2 INSTALL THE HDD2	37
7. PTZ CONTROL	39

8. INSTALLATION	40
8.1 SYSTEM CONFIGURATION DIAGRAM	40
8.2 CAMERA	41
8.3 AUDIO	41
8.4 MONITOR	42
9. NETWORKING	43
9.1 REQUIREMENTS	43
9.2 INSTALLING THE PROGRAM TO THE PC	43
9.3 CONNECTING THE DVR THROUGH GUI (CLDVR)	44
9.4 CLDVR SCREEN	45
9.5 EXPLANATION OF CLDVR FUNCTION	46
9.6 LOCAL VIEWER	54
APPENDIX	
1. RECORDING TIME TABLE (DAYS)	56
2. FACTORY DEFAULT TABLE	58
3. FAQ	60
4. LIMITED 2 YEAR WARRANTY	62
5. HOW TO OBTAIN FACTORY SERVICE	62

1. GENERAL PRECAUTIONS

1. **Read Instructions:** All of the safety and operating instructions should be read and understood before the product is used.
2. **Retain Instructions:** The safety and operating instructions should be retained for future reference.
3. **Heed Warnings:** All warnings on the product and the instruction manual should be followed.
4. **Follow Instructions:** All operating and use instructions should be followed for optimal performance
5. **Cleaning:** Disconnect this video product from the power supply before cleaning. Do not use liquid cleaners or aerosol cleaners. Use a damp cloth for cleaning.
6. **Attachments:** Do not use attachments not recommended by the video product manufacturer as they may cause hazards.
7. **Water and Moisture:** Do not use this product near water - for example, near a bathtub, wash bowl, kitchen sink, wet basement, or near a swimming pool.
8. **Accessories:** Use this product only with a stand, tripod, bracket or table recommended by the manufacturer or sold with the product. Any mounting of the product should follow the manufacturer's instructions.
9. **Ventilation:** This product should never be placed near or over a Radiator or heat register. This product should not be placed in a built-in installation, such as a bookcase or rack, unless proper ventilation is provided or the Manufacturer's instructions have been adhered to.
10. **Power Source:** This product should be operated from the type of Power source indicated by the marking label. If you are not sure of the type of power supply provided to your location, consult your product dealer or your local Power Company.
11. **Power Cord Protection:** Power supply cords should not be routed so that they are likely to be walked on or pinched by items placed on or near them
12. **Lightning:** For added protection, unplug this product from its outlet during a lightning storm. This will prevent damage to the video product due to lightning and power surges.
13. **Overloading:** To avoid the risk of fire and electric shock, do not plug this product into an over-loaded power supply.
14. **Object and Liquid Entry:** Never push objects into the openings of this product as they may touch dangerous voltage points that may result in fire or electric shock. Never spill a liquid of any kind on this product.
15. **Servicing:** Do not attempt to service this product yourself as opening or removing covers may expose you to voltage or other hazards. Refer all servicing to qualified service personnel.
16. **Damage Requiring Service:** Disconnect this product from the power supply and refer servicing to qualified service personnel under the following conditions:
 - a. When the power supply cord or plug is damaged
 - b. If objects have fallen into the product
 - c. If the product has been exposed to rain or liquids
 - d. If the product does not operate normally by following the instruction manual. Adjust only the controls that are covered in the instruction manual as an improper adjustment may

result in damage and will often require extensive work by a qualified service technician to restore the product to its normal operation

- e. If the product has been dropped or the cabinet has been damaged
 - f. When the product displays a distinct change in performance - this indicates a need for service
- 17. Replacement Parts:** When replacement parts are required, be sure the technician uses replacement parts specified by the manufacturer. Unauthorized substitutions may result in fire, electric shock, or other hazards.
 - 18. Safety Check:** Upon completion of any service to this product ask the service technician to perform safety checks to determine that the product is in proper working condition.
 - 19. Grounding or Polarization:** This product is equipped with a three-wire grounding-type plug, a plug having a third (grounding) pin and will only fit into a grounding-type power outlet. This is a safety feature. If you are unable to insert the plug into the outlet, contact your electrician to replace your obsolete outlet. Do not defeat the safety purpose of the grounding-type plug.
 - 20. Power Lines:** An outside antenna system should not be located in the vicinity of overhead power lines or other electric light or power circuits, or where it can fall into such power lines or circuits. When installing an outside antenna system, extreme care should be taken to keep from touching such power lines or circuits as contact with them might be fatal.
 - 21. Wall or Ceiling Mounting:** The product should be mounted to a wall or ceiling only as recommended by the manufacturer.
 - 22. Heat:** The product should be situated away from heat such as radiators, heat registers, stoves, or other products (including amplifiers) that produce heat.

2. SPECIFICATIONS

DVR SPECIFICATIONS

System	NTSC or PAL (Auto Detection)
Video Input	4 Inputs (BNC): 1Vp-p composite, 75ohms
Video Output	2 Outputs (BNC), 4 Looping output (BNC): 1Vp-p composite, 75 ohms
Audio Input	1 Channel (RCA)
Audio Output	1 Channel (RCA)
Alarm Input	4 Ch alarm Inputs: Normally Open (N.O)
Alarm Output	1 Ch alarm Output: Normally Open (N.O) or Normally Close (N.C)
Video Loss Detection	YES
Display Size	NTSC - 720 X 480 PAL - 720 X 576
Video Display	Full, Quad for Playback. Full, Quad, PIP, POP for Live.
Sequencing	YES (Live and Recording mode)
Triplex Mode	Live, Playback, Recording and Networking simultaneously
Recording Resolution	NTSC - 720 X 224 PAL - 720 X 288
Recording Speed	NTSC - 120 IPS PAL - 100 IPS
Video Compression	High quality picture with M-JPEG
Recording Mode	Continuous Recording, Alarm Recording. Motion Recording, Schedule Recording
Playback Format	1 Channel or Quad
Playback	NTSC – 120 IPS PAL - 100 IPS
Search (Playback)	By Time/Date, Event, Recording lists (the whole/the last) and Play button
Play Speed (FF, Rew)	x1, x2, x4, x8, x16
Motion Detection	YES
Multiplex Recording	YES
Hard Disk Storage	IDE Type, Up to 400 GB, 2 Bays (Master: 160GB installed, Slave N/C)

Backup	JPEG & AVI File format through GUI, DVR File format at USB.
Ethernet	RJ-45 Connector for network communication
PAN / TILT	RS-485 Control (Pelco D Protocol)
USB Port	Data Backup, Firmware Update
Jog-Shuttle	YES
Setup	On screen Display setup
User Interface	Menu driven
User Input Device	Front Panel keypad
Timer	Built-in real time clock

Design and specifications are subject to change without notice.

<u>NOTE</u>	<ul style="list-style-type: none"> ■ This product is TRIPLEX (LIVE, PLAY, RECORD) system. While recording, you can Playback and see the Live screen simultaneously. ■ ZOOM function will apply on firmware version #CL042706(S) or later version.
--------------------	---

3. OPERATION

3.1 FRONT PANEL

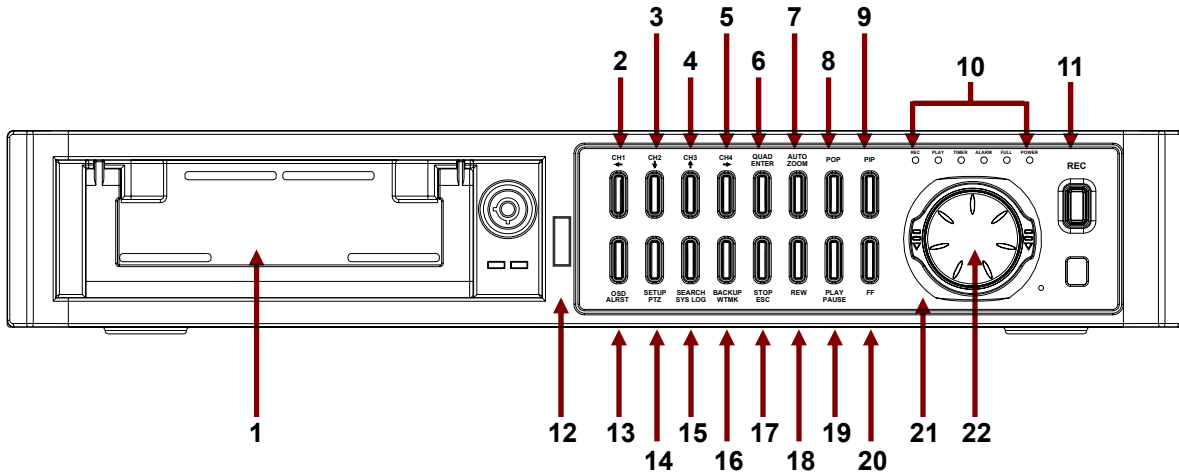

1. HDD RACK	Master HDD: Installed 160GB
2. CH 1 / LEFT	<ul style="list-style-type: none"> - While in Quad mode, press this button momentarily (at least 3 seconds) and channel 1 will appear in full screen. - In full screen mode, channel 1 single screen or on PIP / POP / QUAD screen, press this button once and the screen will freeze. Press this button again to release the frozen picture. - On Playback mode, pressing this button will show the channel 1 single screen. - On SETUP / SEARCH / PTZ / RECORD LISTS mode, this button can be used as ARROW (LEFT) button. - On PASSWORD input mode, pressing this works as number 1.
3.CH 2 / UP	<ul style="list-style-type: none"> - While in Quad mode, press this button momentarily (at least 3 seconds) and channel 2 will appear in full screen. - In full screen mode, channel 2 or on PIP / POP / QUAD screen, press this button once to freeze screen. Press this button again to release the frozen picture. - On Playback mode, pressing this button will show the channel 2 full screen. - On SETUP / SEARCH / PTZ / RECORD LISTS screen, this button can be used as ARROW (UP) button. - On PASSWORD input mode, pressing this works as number 2.

4. CH 3 /DOWN	<ul style="list-style-type: none"> - While in Quad mode, press this button momentarily (at least 3 seconds) and channel 3 will appear in full screen. - In full screen mode, channel 3 single screen or on PIP / POP / QUAD screen, press this button once and the screen will freeze. Press this button again to release the frozen picture. - On Playback mode, pressing this button will show the channel 3 single screen. - On SETUP / SEARCH / PTZ / RECORD LISTS mode, this button can be used as ARROW (LEFT) button. - On PASSWORD input mode, pressing this works as number 3.
5. CH 4 /RIGHT	<ul style="list-style-type: none"> - While in Quad mode, press this button momentarily (at least 3 seconds) and channel 4 will appear in full screen. - In full screen mode channel 4 single screen or on PIP / POP / QUAD screen, press this button once and the screen will freeze. Press this button again to release the frozen picture. - On Playback mode, pressing this button will show the channel 4 single screen. - On SETUP / SEARCH / PTZ / RECORD LISTS mode, this button can be used as ARROW (LEFT) button. - On PASSWORD input mode, pressing this works as number 4.
6. QUAD /ENTER	<ul style="list-style-type: none"> - Press this button in LIVE mode, the monitor should display QUAD screen. - On SETUP / PTZ mode, pressing this button can select item or change the values. - On SEARCH / RECORD LISTS mode, pressing this button will playback the selected data. - Press this button on Playback Zoom mode and channel will change in sequence whenever the button is pressed.
7. AUTO / ZOOM	<ul style="list-style-type: none"> - Press this button in LIVE mode, the monitor displays QUAD screen and a full screen at a time in a continuous sequence – one camera after another. - If the channel (s) has no video signal or channel that is set up dwell time to 0 second, the corresponding channel (s) will be skipped in sequential mode. - The image on the screen will be zoomed up to 2 times when this button is pressed in the Playack mode(Full screen or Quad screen). <p>While replaying, press Auto/Zoom button (available on firmware ver.# CL042706(S) or later version) to zoom in, and the Zoom OSD will be shown on the screen.</p> <ul style="list-style-type: none"> - Repeatedly pressing the ENTER button, the corresponding channel will be displayed. - Press Auto/Zoom button again to exit Zoom mode.
8. POP	<ul style="list-style-type: none"> - Displays one main screen and 3 sub screens.
9. PIP	<ul style="list-style-type: none"> - Displays one full screen and one or two sub screens on the full screen.

10. LED FUNCTION	<ul style="list-style-type: none"> - REC : The LED will blink when the system is in the recording mode. - PLAY : The LED will blink when the system is in the replaying mode. - TIMER : When the SCHEDULE RECORD is set, the LED will blink before it starts RECORDING. - ALARM : The LED is lit when ALARM is set. - HDD FULL : The LED is lit when the space of HDD is less than 1GB. If HDD OVERWRITE is set, the LED won't be lit even though the space of HDD is less than 1GB. - POWER : The LED is lit when the POWER switch is on.
11. REC	<ul style="list-style-type: none"> - Press this button to starts Continuous Recording. - Press and hold this button for about 3 seconds to stop Recording.
12. USB PORT	<ul style="list-style-type: none"> - Save playback data or connect an USB Memory for updating Firmware.
13. OSD / ALRST	<ul style="list-style-type: none"> - Press this button to turn the OSD (On Screen Display) on. Press this button again to turn the OSD off (Except "PLAY" and "REC" sign). - Press this button to reset the system when Alarm or Motion event occurs.
14. SETUP / PTZ	<ul style="list-style-type: none"> - Press this button in the LIVE mode, the SETUP menu will be displayed. - Press and hold this button for about 3 seconds, the PAN/TILT menu will be displayed. Press the STOP/ESC button to return to the QUAD mode.
15. SEARCH / SYS-LOG	<ul style="list-style-type: none"> - Press this button in the LIVE mode, the SEARCH/HDD SET menu will display on the screen. - Press and hold this button for about 3 seconds in the LIVE mode, the SYSTEM LOG menu will display on the screen. - SYSTEM LOG Information. <ul style="list-style-type: none"> R-S : It stands for Recording Start. R-E : It stands for Recording End. P-S : It stands for Playback Start. P-E : It stands for Playback End. S-S : It stands for Setup Start. S-E : It stands for Setup End. PWR : It indicates when the system was powered on. USB : It indicates when the system saved data on the USB memory. - It will create upto 300 log lists.
16. BACKUP / WTMK	<p>This button is used to backup data on USB memory.</p> <p>HOW TO BACKUP DATA ON USB</p> <ul style="list-style-type: none"> - Format the USB with your computer and plug it on USB PORT (See #12). - Press this button when the system is in the playback mode. - It will start to copy recorded data from your DVR right after displaying "PLEASE WAIT...". - Press this button again to stop copy. - It will stop to copy after displaying "PLEASE WAIT..., COPY OK".

	<p>WATERMARK CHECK</p> <ul style="list-style-type: none"> - Press and hold this button for about 3 seconds in the playback mode, the Water Mark OSD will be shown on the screen. To exit, press and hold this button again for about 3 seconds. - The WTMK function : Watermarking is an identification code or bit pattern integrated into the multimedia data to aid copyright owners to identify illegally distributed video, or image data. The Watermark proves preservation of integrity (as well as the chance of being manipulated) for recorded images generated by DVR in terms of the legal purpose or confidential use. The Watermark is usually visible by a detector chip or by special software.
17. STOP / ESC	<ul style="list-style-type: none"> - Pressing the button in the playback mode, it stops replaying and returns to the LIVE mode. - To exit or return to the LIVE or RECORD mode, press this button on PTZ mode, SEARCH/HDD mode, RECORD LISTS, EVENT LISTS, PASSWORD input mode.
18. REW	<ul style="list-style-type: none"> - Activates Rewind feature. Repeatedly pressing this button enables you change speed up to 16 times (x1,x2,x4,x8 &x16 speeds).
19. PLAY / PAUSE	<ul style="list-style-type: none"> - Pressing this button in the LIVE mode, it will replay the first list that is saved on HDD. Press it again to pause. - Pressing Play/ Pause button will continue replay.
20. FF	<ul style="list-style-type: none"> - Fast forwards recorded images at x1, x2, x4,x8 &x16 speeds.
21. SHUTTLE	<ul style="list-style-type: none"> - You can select the playback speed for both forward and reverse by turning the shuttle to the left or right.
22. JOG	<ul style="list-style-type: none"> - Jog dial to the right for forward frame-by-frame playback, or to the left for reverse frame-by-frame playback.

<u>NOTE</u>	<p>Directions for using USB Flash Memory Connection.</p> <p>When copying the recorded images to USB Flash Memory, the system must be in PLAYBACK Mode.</p> <ul style="list-style-type: none"> - Press PLAY to view the recorded data. - Connect USB flash memory unit to the USB connector - Press the BACKUP/WTMK button on the Front Panel. - When you want to stop press STOP button or else it will stop when memory is in full or data stop played.
--------------------	--

<u>NOTE</u>	<p>Recommended USB Memory</p> <ul style="list-style-type: none"> - SanDisk USB Memory
--------------------	--

3.2 BACK PANEL

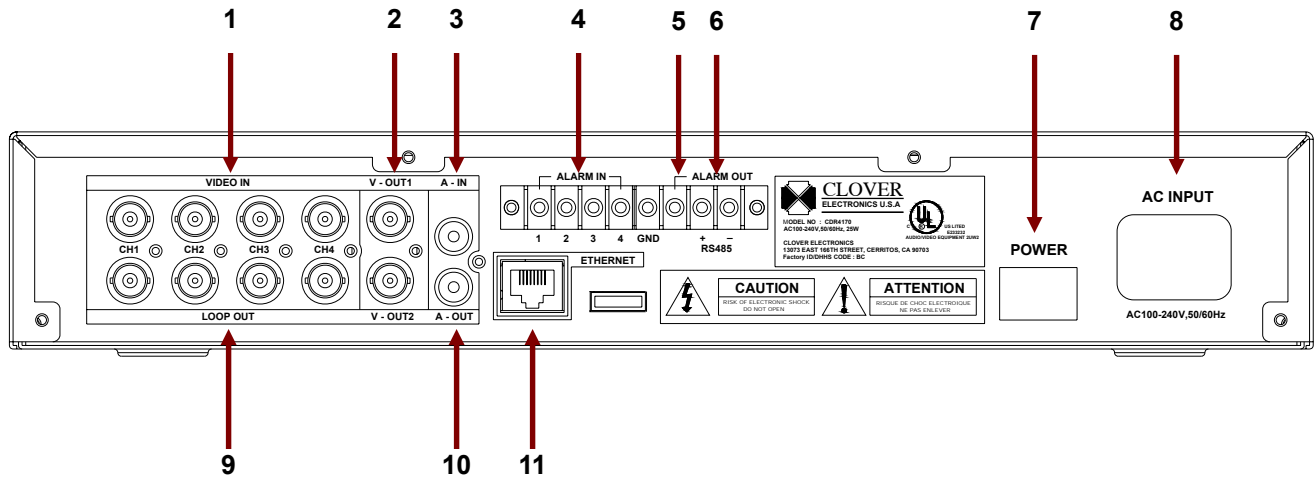

1. VIDEO IN	4- Video Inputs (BNC)
2. VIDEO OUT	2- Video Outputs (BNC)
3. AUDIO IN	Audio Input (RCA)
4. ALARM IN	4- Alarm sensor Input terminal. Connect Normally Open (N.O.) type only.
5. ALARM OUT	Alarm output when Alarm or Motion activates. N.O or N.C available.
6. RS-485	RS-485 terminal for P/T/Z control.
7. POWER	Power on or off.
8. AC INPUT	Socket for AC 110 – 230V Power cord.
9. LOOP OUT	4- Looping outputs (BNC)
10. AUDIO OUT	Audio output (RCA)
11. ETHERNET	RJ-45 jack to connect LAN.

4. BASIC CONFIGURATION OF THE MONITOR SCREEN

4.1 START UP

When the system starts up, the following pictures will be displayed in sequence.

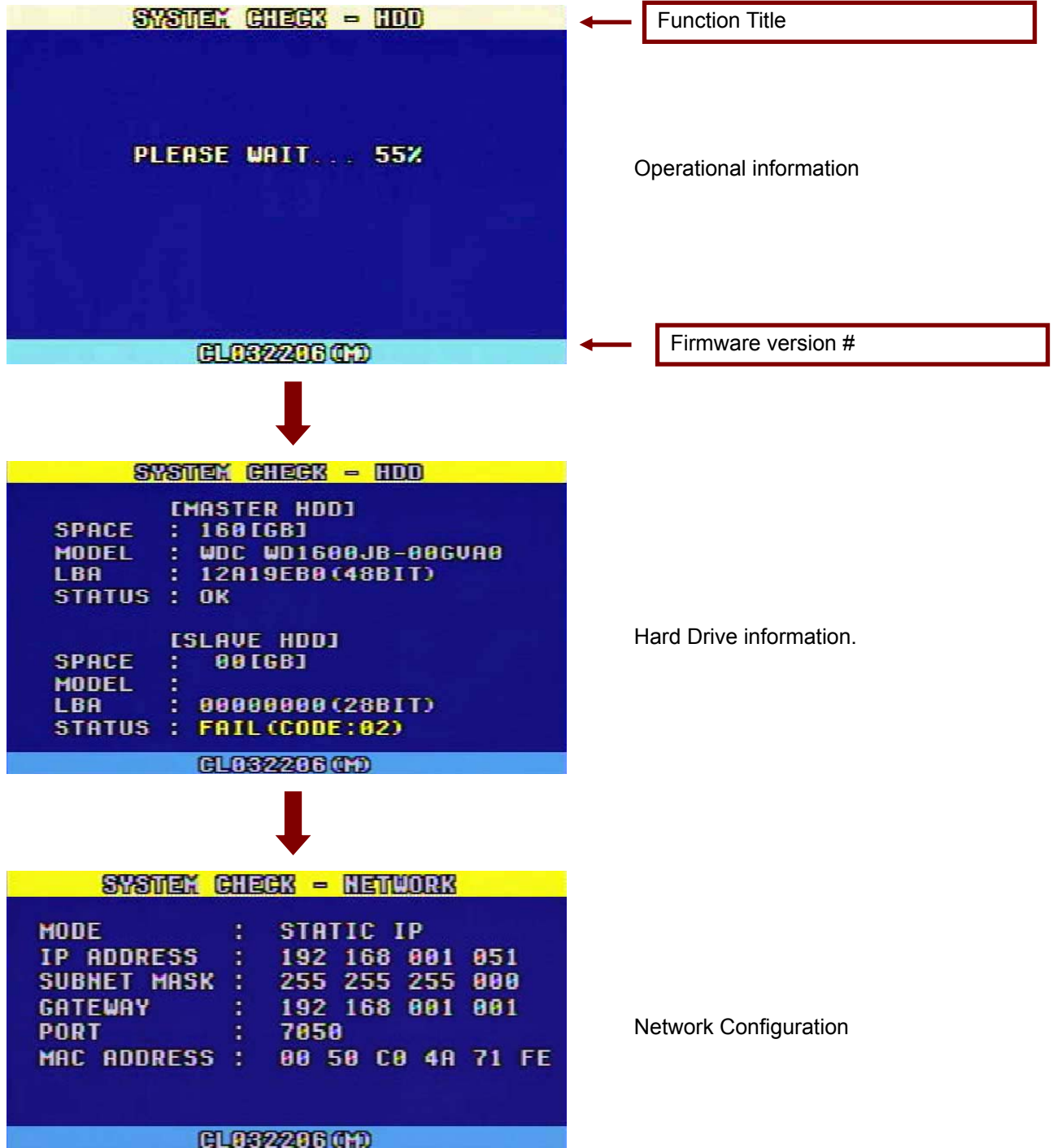

4.2 LIVE SCREEN

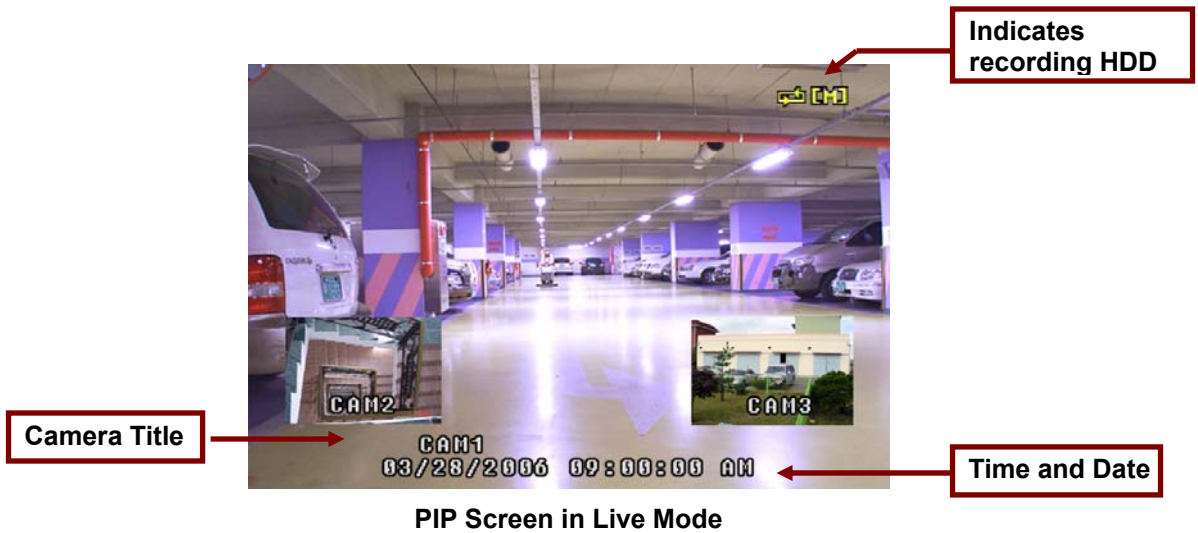



4.3 RECORDING SCREEN



4.4 PLAYBACK SCREEN



Full Screen in Playback Mode



Quad Screen in Playback Mode



Nine Screens in Playback Mode

4.5 RECORD AND PLAYBACK SCREEN



Quad Screen in Record and Playback Mode



Nine Screens in Record and Playback Mode

4.6 LIVE

Live means viewing the present video images from the cameras on the monitor.

4.6.1 Full Screen display

Full screen display is possible in the Live mode or Record mode.

Use channel selection button to choose a corresponding video input.

Refer to 4.2 "Full Screen in LIVE Mode"

4.6.2 Quad Screen

All 4 cameras are viewed on the monitor at the same time in reduced size.

Quad screen is available in the Live mode or Record mode.

Refer to 4.2 "Quad Screen in LIVE Mode"

4.6.3 Sequential Mode Operation

The system will be viewed a full screen at a time in a continuous sequence (one camera after another) by pressing the **AUTO** button. It will available in the **LIVE** and **RECORD** mode.

The dwell time can be adjusted from 0 to 10 seconds (See section 5.6.2 for more details).

Press the **QUAD** button to return to the **QUAD** mode.

4.6.4 PIP screen

The PIP (Picture In Picture) allows you to view two viewing areas simultaneously, one being the main channel, the other being viewed as a sub-picture in the main screen. To change between Single PIP and Dual PIP, repeatedly press the PIP button.

PIP screen is available in the LIVE mode and RECORD mode.

Refer to 4.2 "PIP Screen in the LIVE Mode"

4.6.5 POP screen

The POP divides the screen into 4 screens, with the main channel occupying two-thirds of the screen. Press the POP button to swap the positions of cameras appearing in the POP (Between the Main and Sub screen). To exit the POP mode, press another button.

POP screen is available in the LIVE mode and RECORD mode.

Refer to 4.2 "POP Screen in LIVE Mode"

4.6.6 Freeze screen

Freeze is available in the Live or Quad mode.

In the Full screen mode

- Press the channel button to freeze the current display.
- Press the channel button again or press another channel selection button to release the Freeze function.
- When the FREEZE button is pressed, the FRZ symbol will be shown on the screen.

In the Quad mode

- Press any channel selection button to get a frozen display of corresponding part on the screen.

- Press the same channel selection button to release the freeze function.



4.6.7 OSD On / Off

Available in the LIVE, RECORD or PLAYBACK mode.

When the OSD button is pressed, all the texts except the REC and PB (PLAYBACK) OSD are cleared temporarily.

When the button is pressed again while OSD is in OFF position, the system status will be displayed.

Pressing the OSD button again will bring the system to normal condition.

4.7 RECORDING

4.7.1 Recording Option

- Continuous recording
- Timer recording
- Alarm recording
- Motion recording

NOTE	This system provides Watchdog function. When power goes off during recording and power comes up, it automatically starts to record.
-------------	--

4.7.2 Continuous recording

Recording will start when the **REC** button is pressed. The **REC** indicator will be lit and 'REC' will blink on the screen while the unit is recording.

Press and hold the REC button for 3 seconds to stop recording, and it returns to the LIVE mode.

When the system is in the continuous recording mode, the recording will continue until stop recording.

The whole recording lists are updated hourly up to 1,000 lists on both Master and Slave.

4.7.3 Schedule recording

Recording by scheduled time

The time of record start and finish can be set to hour: minute.

Refer to section 5.7.6 for more information.

4.7.4 ALARM recording

When an alarm signal is received, the system begins to record automatically. The REC button must be pressed to make the recording lists. If not, it does not make any lists.

When the alarm signal is stopped, the system continues recording for the ALARM HOLD TIME and finishes the recording.

The Event REC lists by PIR sensor and MOTION detection can be made up to 300 lists on both Master and Slave HDD.

4.7.5 Motion recording

When the menu of motion properly setup (See section 5.4 for more details) and motion detects, the system begins to record automatically. The REC button must be pressed to make the recording lists. If not, it does not make any lists.

The system continues recording for the MOTION HOLD TIME and finishes the recording.

The Event REC lists by PIR sensor and MOTION detection can be made up to 300 lists on both Master and Slave HDD.

4.8 PLAYBACK

4.8.1 Playback Mode

- Playback from the first recording time by PLAY button.
- Playback by the last record list in SEARCH/HDD SET menu.
- Playback by the whole record lists in SEARCH/HDD SET menu.
- Playback by event record lists in SEARCH/HDD SET menu.
- Playback by Time/Date in SEARCH/HDD SET menu.



SEARCH/HDD SET

4.8.2 Playback from the first recording time

When the **PLAY** button is pressed, it will play from the beginning of the first list. In order to pause during playing, press **PLAY** button. And to keep playing, press **PLAY** button once more.

4.8.3 Playback by the last recording list

When the **SEARCH** button is pressed, the **SEARCH/HDD SET** menu appears on the screen. Select **THE LAST RECORD LIST** and press the **ENTER** button. It will replay from the beginning of the last recorded list.

Press the **ESC** button to return to the **SEARCH/HDD SET** menu.

In order to pause during playing, press the **PLAY** button. And to keep playing, press the **PLAY** button once more.

4.8.4 Playback by the whole Rec lists

When the **SEARCH** button is pressed, the **SEARCH/HDD SET** menu appears on the screen. Select **THE WHOLE REC LISTS** menu by using **UP/DOWN** button and Press the **ENTER** button. **THE WHOLE REC LISTS** appear on the screen.

Choose one list among them and press the **ENTER** button to playback.

If the system is in the continuous recording mode, the recording lists are updated hourly up to 1,000 lists on both Master and Slave HDD.

The **Event REC** lists by **PIR** sensor and **MOTION** detection can be made up to 300 lists as well, and "A" or "M" on the end of lists represents **ALARM** or **MOTION** respectively.

In order to pause during playing, press the **PLAY** button. And to keep playing, press the **PLAY** button once more.

4.8.4 Playback by the Event Rec Lists

When the **SEARCH** button is pressed, the **SEARCH/HDD SET** menu appears on the screen. Select the **EVENT REC LISTS** menu by using **UP/DOWN** button. Press **ENTER** button, and the **EVENT REC LISTS** appear on the screen.

Choose one list among them and press the **ENTER** button to playback.

The **Event REC** lists by **PIR** sensor and **MOTION** detection can be made up to 300 lists, and "A" or "M" on the end of lists represents **ALARM** or **MOTION** respectively.

In order to pause during playing, press the **PLAY** button. And to keep playing, press the **PLAY** button once more.

4.8.5 Playback by the TME/DATE

When the **SEARCH** button is pressed, the **SEARCH/HDD SET** menu appears on the screen. Select the **TIME/DATE** menu by using **UP/DOWN** button. Press the **ENTER** button, and the following window will be displayed.



Set the **TIME/DATE** by using the **UP/DOWN** buttons for changing the values and use the **LEFT/RIGHT** buttons to move to next field.

Press the **ENTER** button to search the recorded image. If the recorded image exists, it automatically plays data and if not, it returns to the **LIVE** mode.

In order to pause during playing, press the **PLAY** button. And to keep playing, press the **PLAY** button once more.

4.8.6 Playback Screen

During playback press the **1, 2, 3** or **4** button (channel selection button) to view the corresponding full screen.

Press the **QUAD** button to view quadrant pictures in the quad mode.

The **OSD ON/OFF** button functions during replaying.

NOTE:

- If the system has two HDDs which are for Master and Slave, select the **PB** item in the **SEARCH/HDD SET** menu and select between **MASTER** and **SLAVE** by using the **ENTER** button for selecting the HDD which contains the recording data you wish to search.
- **If you select one of the recording lists that does not contain the recorded data, the system will playback from the beginning of the first recording list that contains the recorded data (available on firmware ver. #CL060206 or later version).**
- When the system is in the Recording or Playback mode, user can't select the **PB** item.
- It will automatically search the recording data on both HDDs with **TIME/DATE** search function. We recommend you to use this function, if other searching functions are not useful for you.

5. SETUP

5.1 SETUP SCREEN TREE

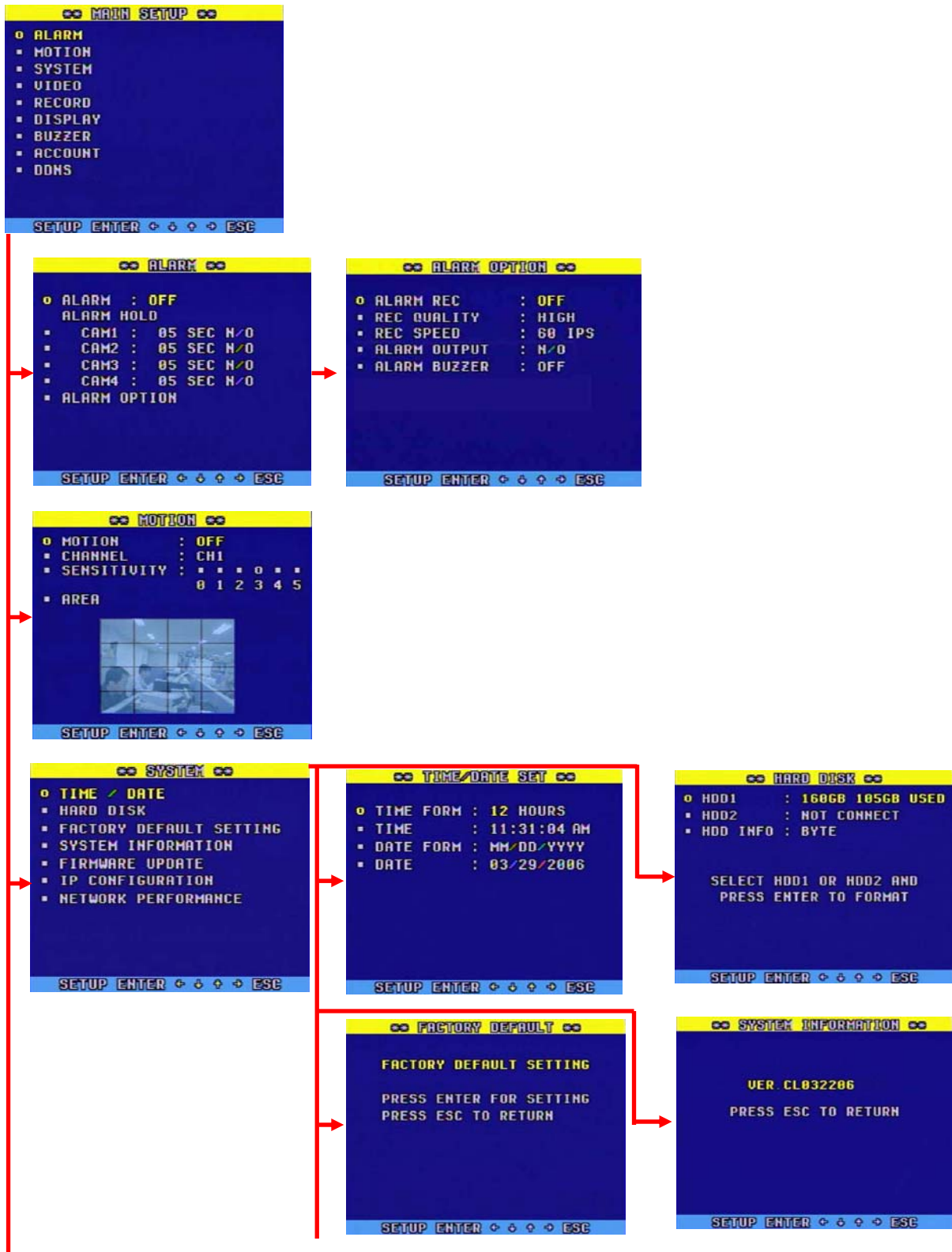

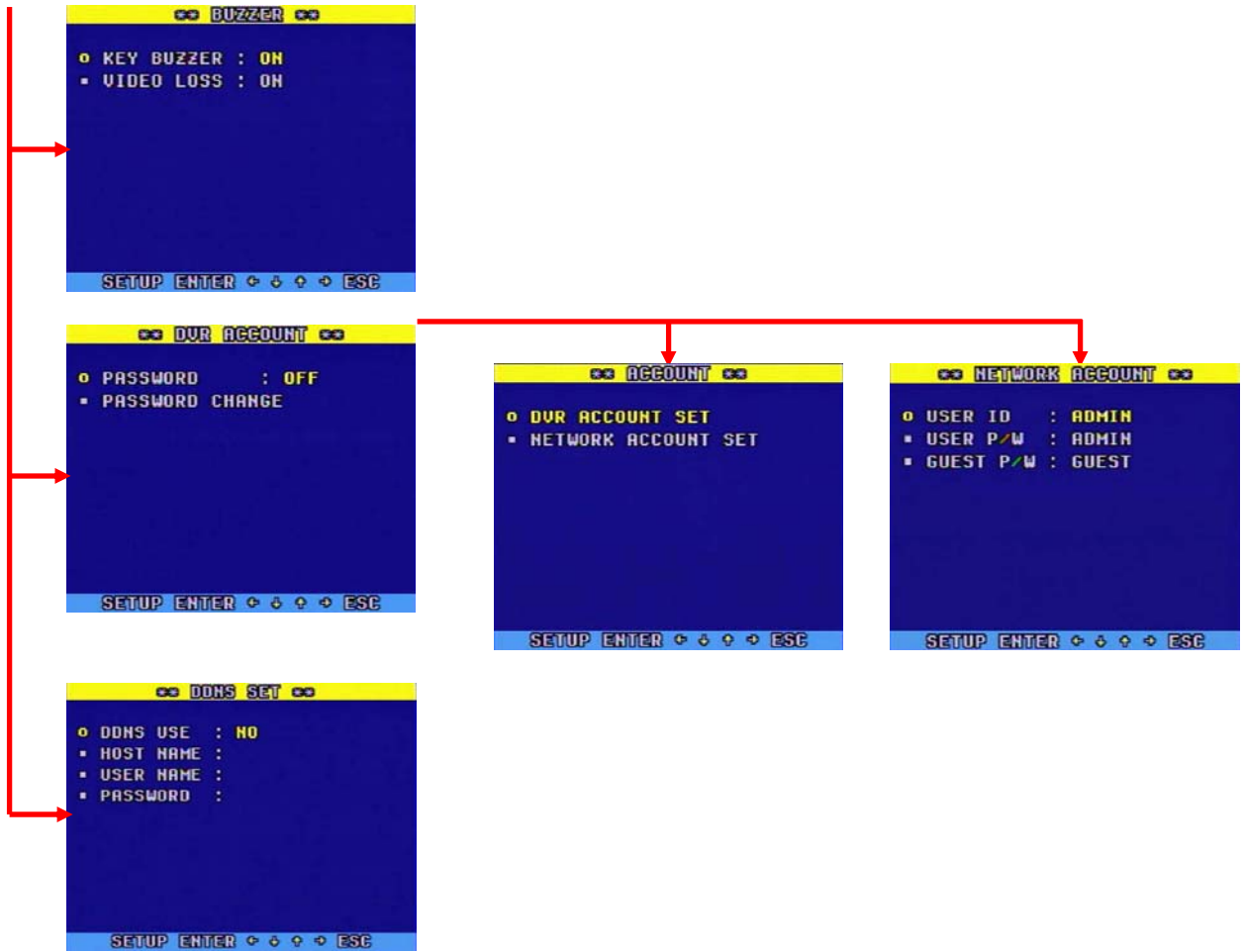

5.2 HOW TO SET UP

- Setup is possible in the **LIVE** mode and partly in the recording mode, not in the playback mode.
- Press the **SETUP** button.
- Choose a setup item by using the **UP/DOWN** buttons and press the **ENTER** button.
- Choose the desired values with the **ENTER** button.
- Press the **ESC** button to exit.

5.3 ALARM

- Choose the **ALARM** in the **MAIN SETUP** menu by using **UP/DOWN** buttons.
- Press the **ENTER** button and the **ALARM** menu will be displayed.
- Press the **ESC** button to exit.

5.3.1 ALARM

- Choose the **ALARM** in the **ALARM** menu with the **UP/DOWN** buttons.
- Select **ON** or **OFF** by pressing the **ENTER** button.
- **ON** should be selected for alarm recording.

5.3.2 ALARM HOLD / INPUT

- Choose the channel by using the **UP/DOWN** buttons.
- Press the **ENTER** button to change the alarm hold time (1 to 15 seconds) by using the **UP/DOWN** buttons.
- Select the **ALARM INPUT** using the **LEFT/RIGHT** buttons and choose **ON** or **OFF** by using the **ENTER** button. **N/O** should be selected, and connected the **N.O** (Normally Open) **PIR** sensor for alarm recording.
- Press the **ESC** button to exit.

5.3.3 ALARM OPTION

- Choose the **ALARM OPTION** in the **ALARM** menu with the **UP/DOWN** buttons.
- Press the **ENTER** button and the **ALARM OPTION** menu will be displayed.

5.3.4 ALARM REC

- Choose the **ALARM REC** in the **ALARM OPTION** menu by using the **UP/DOWN** buttons.
- Select **ON** or **OFF** by pressing the **ENTER** button.
- **ON** should be selected for alarm recording.

5.3.5 REC QUALITY

- Choose the **REC QUALITY** in the **ALARM OPTION** menu by using the **UP/DOWN** buttons.
- Choose one quality among **LOW**, **NORMAL**, **HIGH** and **VERY HIGH** by repeatedly pressing the **ENTER** button.

5.3.6 REC SPEED

- Choose the **REC SPEED** in the **ALARM OPTION** menu by using the **UP/DOWN** buttons.
- Choose one **REC SPEED** among 01, 02, 03, 05, 10, 15, 30 and 60 IPS by repeatedly pressing the **ENTER** button, if the **REC RESOLUTION** in the **RECORD** menu set to 720H or 360H. It will be fixed to 120 IPS if the **REC RESOLUTION** in the **RECORD** menu set to CIF.

5.3.7 ALARM OUTPUT

- Choose the **ALARM OUTPUT** in the **ALARM OPTION** menu by using the **UP/DOWN** buttons.
- Select **N/O** (Normally Open) or **N/C** (Normally Close) by pressing the **ENTER** button.

5.3.8 ALARM BUZZER

- Choose the **ALARM BUZZER** in the **ALARM OPTION** menu by using the **UP/DOWN** buttons.
- Select **ON** or **OFF** by pressing the **ENTER** button.

5.4 MOTION

- Choose the **MOTION** in the **MAIN SETUP** menu by using **UP/DOWN** buttons.
- Press the **ENTER** button and the **MOTION** menu will be displayed.
- Press the **ESC** button to exit.

5.4.1 MOTION

- Choose the **MOTION** in the **MOTION** menu with the **UP/DOWN** buttons.
- Choose one among **OFF**, **OSD** and **OSD+BUZZER** by pressing the **ENTER** button.
- **OSD** or **OSD+BUZZER** should be selected for motion recording.

5.4.2 CHANNEL

- Choose the **CHANNEL** in the **MOTION** menu with the **UP/DOWN** buttons
- Choose a channel among CH1, CH2, CH3 and CH4 by repeatedly pressing the **ENTER** button.

<u>NOTE</u>	The channels should be changed along with the SENSITIVITY and motion AREA .
--------------------	---

5.4.3 SENSITIVITY

- Choose the **SENSITIVITY** in the **MOTION** menu with the **UP/DOWN** buttons.
- Choose a **SENSITIVITY** among **0**, **1**, **2**, **3**, **4** and **5** by using the **LEFT/RIGHT** button. "0" is lowest value and "5" is the highest value.

5.4.4 AREA

- Choose the **AREA** in the **MOTION** menu with the **UP/DOWN** buttons
- Press the **ENTER** button to create the motion detection **AREA**.
- Move the symbol “O” by using the **UP / DOWN / LEFT / RIGHT** buttons and select the area where you would like to create, and press the **ENTER** button.
- To release the motion detection area, press the **ENTER** button after moving the symbol “O” to the same area where you created.
- Press the **ESC** button to exit.



NOTE

The **OSD** or **OSD+BUZZER** and the motion detection **AREA** should be selected for motion recording.

5.5 SYSTEM

- Choose the **SYSTEM** in the **MAIN SETUP** menu by using **UP/DOWN** buttons.
- Press the **ENTER** button and the **SYSTEM** menu will be displayed.
- Press the **ESC** button to exit.

5.5.1 TIME / DATE

- Choose the **TIME/ DATE** in the **SYSTEM** menu with the **UP/DOWN** buttons.
- Press the **ENTER** button, and the **TIME /DATE SET** menu will be displayed.

5.5.1.1 TIME FORMAT

- Choose the **TIME FORMAT** in the **TIME /DATE SET** menu with the **UP/DOWN** buttons.
- Select the **12 HOURS** or **24 HOURS** mode by using the **ENTER** button.

5.5.1.2 TIME

- Choose the **TIME** in the **TIME /DATE SET** menu with the **UP/DOWN** buttons.
- Press the **ENTER** button to make **TIME** changes.
- Select **Hour/Min/Sec** by using the **LEFT/RIGHT** buttons and change the values by using the **UP/DOWN** buttons.

- To apply the setting, press the **ENTER** button.

5.5.1.3 DATE FORMAT

- Choose the **DATE FORMAT** in the **TIME /DATE SET** menu with the **UP/DOWN** buttons.
- Select the **DATE FORMAT** by pressing the **ENTER** button.

There are three formats to display the time and date as follows.

MM / DD / YYYY: For U.S.A.

YYYY / MM / DD: For Asian Countries.

DD / MM / YYYY: For European Countries.

5.5.1.4 DATE

- Choose the **DATE** in the **TIME /DATE SET** menu with the **UP/DOWN** buttons.
- Press the **ENTER** button to make **DATE** changes.
- Select **Month/Day/Year** by using the **LEFT/RIGHT** buttons and change the values by using the **UP/DOWN** buttons.
- To apply the setting, press the **ENTER** button.
- Press the ESC button to exit.

5.5.2 HARD DISK

- **When you install the new Hard Disk Drive (HDD), it should be formatted before recording. Formatting is possible only when the system is in the LIVE mode.**
- **Factory installed a 160GB of HDD as Master (jumper setting) in the removable HDD cradle.**

- Maximum 2 HDDs can be connected to the system
- Choose the **HARD DISK** in the **SYSTEM** menu with the **UP/DOWN** buttons.
- Press the **ENTER** button, and the **HARD DISK** menu will be displayed.
- Refer to section 6.1 in regards to HDD installation.

5.5.2.1 HDD1

- Shows the available space and the used space of **HDD1**.
- Select the **HDD1** in **HDD DISK** menu to format by using the **UP/DOWN** buttons and press the **ENTER** button, and the **HDD FORMAT: YES, NO** will be displayed. If **YES** is selected by using the **LEFT/RIGHT/ENTER** button, it starts to formatting or select **NO** for going back to the previous mode.

5.5.2.2 HDD2

- Shows the available space and the used space of **HDD2**.
- Select the **HDD2** in **HDD DISK** menu to format by using the **UP/DOWN** buttons and press the **ENTER** button, and the **HDD FORMAT: YES, NO** will be displayed. If **YES** is selected

by using the **LEFT/RIGHT/ENTER** button, it starts to formatting or select **NO** for going back to the previous mode.

5.5.2.3 HDD INFO

- Choose the **HDD INFO** in the **HARD DISK** menu by using **UP/DOWN** buttons.
- Select **BYTE, PERCENTAGE** or **OFF** by pressing the **ENTER** button.
- Press the **ESC** button to exit.

BYTE: Indicates the remaining space of HDD in byte.

PERCENTAGE: Indicates the remaining space of HDD in percentage.

OFF: Will not display HDD information.

5.5.3 FACTORY DEFAULT SETTING

- Choose the **FACTORY DEFAULT SETTING** in the **SYSTEM** menu with the **UP/DOWN** buttons.
- Press the **ENTER** button, and the **FACTORY DEFAULT: YES, NO** will be displayed. If **YES** is selected by using the **LEFT/RIGHT/ENTER** button, the system will replace the existing values with the factory default values, or select **NO** for going back to the previous mode.
- Press the **ESC** button to exit.

<u>NOTE</u>	TIME/DATE information does not change. All the DDNS information will be lost. All the SCHEDULE REC setup values will be lost.
--------------------	---

5.5.4 SYSTEM INFORMATION

- Choose the **SYSTEM INFORMATION** in the **SYSTEM** menu with the **UP/DOWN** buttons.
- Press the **ENTER** button to view the **SYSTEM INFORMATION** screen which shows the current Firmware Version number.
- Press the **ESC** button to exit.

5.5.5 FIRMWARE UPDATE

- Choose the **FIRMWARE UPDATE** in the **SYSTEM** menu with the **UP/DOWN** buttons.
- Press the **ENTER** button and the **FIRMWARE UPDATE** menu will be displayed.

There are two ways to update the FIRMWARE through USB memory and the GUI. We, manufacturer recommend you not to update the system without our permission.

This section is not for users, only for manufacturer and distribution center.

5.5.6 IP CONFIGURATION

- Choose the **IP CONFIGURATION** in the **SYSTEM** menu with the **UP/DOWN** buttons.
- Press the **ENTER** button and the **IP CONFIGURATION** menu will be displayed.
- Press the **ESC** button to exit.

5.5.6.1 IP MODE

- Choose the **IP MODE** in the **IP CONFIGURATION** menu with the **UP/DOWN** buttons.
- Choose **DYNAMIC IP** or **STATIC IP** by pressing the **ENTER** button.

DYNAMIC IP: The IP is automatically allocated via router. Therefore the IP address, subnet mask and gateway address will be automatically allocated.

STATIC IP: This has to be set when the **STATIC IP** is used. The subnet mask and gateway address has to be set as well.

5.5.6.2 IP ADDRESS

- Choose the **IP ADDRESS** in the **IP CONFIGURATION** menu with the **UP/DOWN** buttons and press the **ENTER** button.
- Select the digits by using the **LEFT/RIGHT** buttons and change the values with the **UP/DOWN** buttons.
- After completing, press the **ENTER** button to apply the **IP ADDRESS** setting to the system.

5.5.6.3 SUBNET

- Choose the **SUBNET** in the **IP CONFIGURATION** menu with the **UP/DOWN** buttons and press the **ENTER** button.
- Select the digits by using the **LEFT/RIGHT** buttons and change the values with the **UP/DOWN** buttons.
- After completing, press the **ENTER** button to apply the **SUBNETMASK** setting to the system.

5.5.6.4 GATEWAY

- Choose the **GATEWAY** in the **IP CONFIGURATION** menu with the **UP/DOWN** buttons and press the **ENTER** button.
- Select the digits by using the **LEFT/RIGHT** buttons and change the values with the **UP/DOWN** buttons.
- After completing, press the **ENTER** button to apply the **GATEWAY** setting to the system.

5.5.6.5 PORT

- The **PORT** is the TCP address of the program, which is used to connect to the network viewer and has a range of 0000 to 9999.
- Choose the **PORT** in the **IP CONFIGURATION** menu with the **UP/DOWN** buttons and press the **ENTER** button.
- Select the digits by using the **LEFT/RIGHT** buttons and change the values with the **UP/DOWN** buttons.
- After completing, press the **ENTER** button to apply the **PORT** setting to the system.

NOTE:

- Router has to be set as a virtual server (or port forwarding) in order to utilize the DDNS service (See section 5.11 for more details).
- Do not use the public port numbers.
- Four Port numbers (in sequence) including the default port number should be forwarded.
- Ex: Default port number: 5700.
Forwarding ports: 5700 / 5701 / 5702 / 5703.

5.5.6.6 MAC ID

The **MAC ADDRESS** was consigned to each DVR at the factory.

5.5.7 NETWORK PERFORMANCE

- Choose the **NETWORK PERFORMANCE** in the **SYSTEM** menu with the **UP/DOWN** buttons.
- Press the **ENTER** button and the **NETWORK PERFORMANCE** window will be displayed.
- Choose a bandwidth among **0.4, 1, 2, 4, 8** mbps (Mega Bit Per Second) and **MAX** by repeatedly pressing the **ENTER** button.

NOTE:

The connection speed can vary depending on the circumstances and conditions of your Internet and computer. If your system starts to slow down, please adjust the speed to one setting up or down until the best result.

5.6 VIDEO

- Choose the **VIDEO** in the **MAIN SETUP** menu by using **UP/DOWN** buttons.
- Press the **ENTER** button and the **VIDEO** menu will be displayed.
- Press the **ESC** button to exit.

5.6.1 CAMERA TITLE

- Choose the **CAMERA TITLE** in the **VIDEO** menu with the **UP/DOWN** buttons.
- Press the **ENTER** button, and the **CAMERA TITLE** menu will be displayed.
- Select the desired channel by using **UP/DOWN** buttons and press the **ENTER** button to change the title of the desired channel.
- Select the digits by using the **LEFT/RIGHT** buttons and change the values with the **UP/DOWN** buttons.
- After changing the values, press the **ENTER** button.

NOTE

Maximum 8 letters can be set.

5.6.2 DWELL TIME

- Choose the **DWELL TIME** in the **VIDEO** menu with the **UP/DOWN** buttons.
- Press the **ENTER** button, and the **DWELL TIME** menu will be displayed.
- Select the desired channel by using **UP/DOWN** buttons and press the **ENTER** button to change the dwell time of the desired channel.
- After changing the values, press the **ENTER** button.

<u>NOTE</u>	<ul style="list-style-type: none">- Dwell Time can be setup from 0 sec to 10 sec.- If selecting "0", the corresponding channel will automatically be skipped in the sequential mode.
--------------------	---

5.7 RECORD

- Choose the **RECORD** in the **MAIN SETUP** menu by using **UP/DOWN** buttons.
- Press the **ENTER** button and the **RECORD** menu will be displayed.
- Press and hold the **RECORD** button for about 3 seconds to exit.

5.7.1 REC QUALITY

- Choose the **REC QUALITY** in the **RECORD** menu by using **UP/DOWN** buttons.
- Choose one among **LOW**, **NORMAL**, **HIGH** and **VERY HIGH** by pressing the **ENTER** button.

5.7.1 REC RESOLUTION

- Choose the **REC RESOLUTION** in the **RECORD** menu by using **UP/DOWN** buttons.
- Choose one among **720H**, **360H** and **CIF** by pressing the **ENTER** button.

<u>NOTE</u>	If 360H is selected, the volume of saved data will amount to half of 720H.
--------------------	--

5.7.3 REC SPEED

- Choose the **REC SPEED** in the **RECORD** menu by using **UP/DOWN** buttons.
- Choose one among **01**, **02**, **03**, **05**, **10**, **15**, **30** and **60 IPS** (when **720H** or **360H** in the **REC RESOLUTION** is selected) by repeatedly pressing the **ENTER** button. It will be fixed to **120 IPS** if **CIF** is selected.

5.7.4 HDD OVERWRITE

- Choose the **HDD OVERWRITE** in the **RECORD** menu by using **UP/DOWN** buttons.
- Select **ON** or **OFF** by pressing the **ENTER** button.

During "OFF" mode, the system stops recording when the space of HDD is in full. At "ON" mode, the system continues recording by overwriting start from the first index of the recorded file when the space of HDD is in full.

NOTE: If the recording speed or quality is too low, the existing lists can be overwritten.

5.7.5 AUDIO REC

- Choose the **AUDIO REC** in the **RECORD** menu by using **UP/DOWN** buttons.
- Select **ON** or **OFF** by pressing the **ENTER** button.

NOTE: The system does not record when the recording speed is set to less than 4 IPS.

5.7.6 SCHEDULE REC

- Choose the **SCHEDULE REC** in the **RECORD** menu by using **UP/DOWN** buttons.
- Press the **ENTER** button and the **SCHEDULE RECORD SET** menu will be displayed.

5.7.6.1 SCHEDULE REC

- Choose the **SCHEDULE REC** in the **SCHEDULE RECORD SET** menu by using **UP/DOWN** buttons.
- Choose one among **ONCE**, **DAILY** and **OFF** by pressing the **ENTER** button.

5.7.6.2 SCHEDULE REC TIME SETUP

- Select a line where you wish to setup the start and time with the **UP/DOWN** buttons and press the **ENTER** button.
- Select the **START TIME** and **END TIME** by using the **LEFT/RIGHT** buttons and change the values with the **UP/DOWN** buttons.
- After completing, press the **ENTER** button to apply the values to the system.
- To delete, select a scheduled recording line with the **UP/DOWN** buttons and press the **LEFT** or **RIGHT** button. You will be asked whether the scheduled recording line clear or not. Select **YES** or **NO** with the **LEFT/RIGHT** buttons and press the **ENTER** button.

NOTE: The recording schedule time can be set in military hour mode (24 hour)

5.8 DISPLAY

- Choose the **DISPLAY** in the **MAIN SETUP** menu by using **UP/DOWN** buttons.
- Press the **ENTER** button and the **DISPLAY** menu will be displayed.
- Press the **ESC** button to exit.

5.8.1 TITLE DISPLAY

- Choose the **TITLE DISPLAY** in the **DISPLAY** menu by using **UP/DOWN** buttons.
- Select **ON** or **OFF** by pressing the **ENTER** button.

At "ON" mode, the camera title will be shown on the screen.

5.8.2 BORDER LINE

- Choose the **BORDER LINE** in the **DISPLAY** menu by using **UP/DOWN** buttons.
- Select **ON** or **OFF** by pressing the **ENTER** button.

At "ON" mode, the borderline will be shown on the screen.

5.8.3 TIME/DATE

- Choose the **TIME/DATE** in the **DISPLAY** menu by using **UP/DOWN** buttons.
- Select **ON** or **OFF** by pressing the **ENTER** button.

At "ON" mode, the time/date will be shown on the screen.

5.8.4 POSITION

- Choose the **POSITION** in the **DISPLAY** menu by using **UP/DOWN** buttons.
- Select **TOP** or **BOTTOM** by pressing the **ENTER** button.

The time and date will be shown on the top or bottom of the screen depending on selecting **TOP** or **BOTTOM**.

5.9 BUZZER

- Choose the **BUZZER** in the **MAIN SETUP** menu by using **UP/DOWN** buttons.
- Press the **ENTER** button and the **BUZZER** menu will be displayed.
- Press the **ESC** button to exit.

5.9.1 KEY BUZZER

- Choose the **KEY BUZZER** in the **BUZZER** menu by using **UP/DOWN** buttons.
- Select **ON** or **OFF** by pressing the **ENTER** button.

Whenever the buttons are pressed in "ON" mode, the **BUZZER** will sound.

5.9.2 VIDEO LOSS

- Choose the **VIDEO LOSS** in the **BUZZER** menu by using **UP/DOWN** buttons.
- Select **ON** or **OFF** by pressing the **ENTER** button.

At "ON" mode, the buzzer will sound when the video Input signal is interrupted.

5.10 ACCOUNT

- Choose the **ACCOUNT** in the **MAIN SETUP** menu by using **UP/DOWN** buttons.
- Press the **ENTER** button and the **ACCOUNT** menu will be displayed.
- Press the **ESC** button to exit.

5.10.1 DVR ACCOUNT SET

NOTE	If you execute the factory default setting, the existing password will be changed to 11111111.
-------------	--

- Choose the **DVR ACCOUNT SET** in the **ACCOUNT** menu by using **UP/DOWN** buttons.
- Press the **ENTER** button and the **DVR ACCOUNT** menu will be displayed.

5.10.1.1 PASSWORD

- Select the **PASSWORD** in the **DVR ACCOUNT** menu by using **UP/DOWN** buttons.
- Select **ON** or **OFF** by using the **ENTER** button.
- If **ON** is selected, the password has to be entered to get into the following mode. Setup mode, Search mode, Record mode, Record stop mode, PTZ mode and System Log mode.
- **The password must be 8 digits.**

5.10.1.2 PASSWORD CHANGE

- Select the **PASSWORD CHANGE** in the **DVR ACCOUNT** menu by using **UP/DOWN** buttons.
- Press the **ENTER** button and you will be requested to enter the current password as below.



- Enter the current password by using CH1 (number 1), CH2 (number 2), CH3 (number 3) and CH4 (number 4) buttons. If the entered password is incorrect, user cannot create a new password. If the password is correct, you will be requested to enter a new password and to confirm as below.



- Press the **ENTER** button to save the newly created password to the system.

5.10.2 NETWORK ACCOUNT SET

- Select the **NETWORK ACCOUNT SET** in the **ACCOUNT** menu by using **UP/DOWN** buttons.

- Press the **ENTER** button and the **NETWORK ACCOUNT** menu will be displayed.

5.10.2.1 USER ID

- Select the **USER ID** in the **NETWORK ACCOUNT** menu by using **UP/DOWN** buttons.
- Press the **ENTER** button.
- Change the values up to 5 digits with the **UP/DOWN** buttons and move the digits with the **LEFT/RIGHT** button.
- Press the **ENTER** button to save the values to the system.

5.10.2.2 USER P/W

- Select the **USER P/W** in the **NETWORK ACCOUNT** menu by using **UP/DOWN** buttons.
- Press the **ENTER** button.
- Change the values up to 5 digits with the **UP/DOWN** buttons and move the digits with the **LEFT/RIGHT** button.
- Press the **ENTER** button to save the values to the system.

5.10.2.3 GUEST P/W

- Select the **GUEST P/W** in the **NETWORK ACCOUNT** menu by using **UP/DOWN** buttons.
- Press the **ENTER** button.
- Change the values up to 5 digits with the **UP/DOWN** buttons and move the digits with the **LEFT/RIGHT** button.
- Press the **ENTER** button to save the values to the system.

NOTE:

- User ID & P/W (password) given as an administrator are ADMIN, and Guest ID & P/W given as a guest are GUEST.
- The ADMIN can change the values, controlling and monitoring through the GUI, but the GUEST has the limited authority such as monitoring and partly changing the values on the GUI.

5.11 DDNS

- Choose the **DDNS** in the **MAIN SETUP** menu by using **UP/DOWN** buttons.
- Press the **ENTER** button and the **DDNS** menu will be displayed.
- Press the **ESC** button to exit.

5.11.1 DDNS USE

- Select the **DDNS USE** in the **DDNS SET** menu by using **UP/DOWN** buttons.
- Choose one among **CLOVERDDNS**, **DYNDNS.ORG** and **NO** by pressing the **ENTER** button.

CLOVERDNS: DDNS service provided by www.cloverdvr.com.

DYNDNS.ORG: DDNS service provided by www.dyndns.org

NO: No DDNS service

5.11.2 HOST NAME

- Choose the **HOST NAME** in the **DDNS SET** menu with the **UP/DOWN** buttons.
- Press the **ENTER** button to change the values with the **UP/DOWN** buttons and select the digits (up to 8 digits) by using the **LEFT/RIGHT** buttons.
- After changing the values, press the **ENTER** button.

5.11.3 USER NAME

- Choose the **USER NAME** in the **DDNS SET** menu with the **UP/DOWN** buttons.
- Press the **ENTER** button to change the values with the **UP/DOWN** buttons and select the digits (up to 8 digits) by using the **LEFT/RIGHT** buttons.
- After changing the values, press the **ENTER** button.

5.11.4 PASSWORD

- Choose the **PASSWORD** in the **DDNS SET** menu with the **UP/DOWN** buttons.
- Press the **ENTER** button to change the values with the **UP/DOWN** buttons and select the digits (up to 8 digits) by using the **LEFT/RIGHT** buttons.
- After changing the values, press the **ENTER** button.

5.11.5 HOW TO SETUP AND USE DDNS

5.11.5.1 Router

It has to be set as a virtual server (or port forwarding) in order to utilize the DDNS. There are a lot of manufacturers on the market. Please read the provided manual thoroughly before setting or visit our website at www.cloverusa.com in regards to do it.

We, the manufacturer of DVR systems will not support the solution to your individual network issues.

** DDNS (Dynamic Domain Name System) is a method of keeping a domain name linked to a changing IP address. This is a useful feature since many computers do not use a static IP address.

5.11.5.2 REGISTRATION TO THE DDNS SERVER

Visit at www.dyndns.org or www.cloverdvr.com to register.

Registration to DYNDNS.ORG

1. Go to website www.dyndns.com
2. Sign up for new user name and password.
3. After signup new user, check your e-mail and confirm e-mail from dyndns.com
4. G back to www.dyndns.com and log in with ID and Password.
5. After log in on dyndns.com front page, click on my services
6. Click on Add Host Service (Next to Host Level Service)
7. Add Dynamic DNS Host.
8. Select Add Dynamic DNS Host on the Dynamic DNS.
9. Window to input Host Name will pop up. After entering, select the address to dyndns.org.

10. To complete, click Add Host on the bottom.
11. After registration, go to the DDNS SET menu on the DVR.
12. Refer to section 5.11 DDNS in this manual for the next step.

Registration to CLOVERDVR.COM

1. Go to website www.cloverdvr.com
2. Select Insert New User.
3. Enter your ID and Password (up to 8 digits), and press Submit.
4. New ID will be created.
5. Press Go Home.
6. Select View User.
7. Enter your ID and Password and press Submit.
8. Now you can see the ID, Domain and IP address.
9. After registration, go to the DDNS SET menu on the DVR.
10. Enter the registered ID to the HOST NAME and USER NAME in the DDNS SET menu.
11. Refer to section 5.11 DDNS in this manual for the next step.

6. INSTALL THE HDD

6.1 INSTALL THE HDD1

DVR manufacturer already installed a 160GB of HDD1 as MASTER in the removable HDD rack. Just in case, refer to the following explanation on how to install HDD (Hard Disk Drive).

CAUTION The power switch must be turned off before installing.

Removable HDD Rack

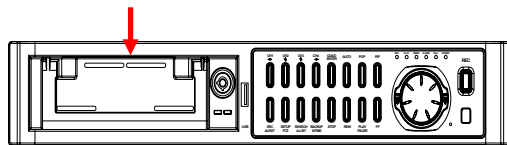

1. Separate the removable HDD rack from the system.
2. Refer to the HDD manufacturer's directions on how to set the jumper for master or slave when assembling.
3. Make sure the power connector and the flat cable are properly connected.



4. Attach the HDD to the removable HDD rack and secure it with the supplied screws as below.

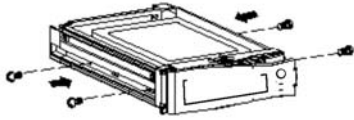

5. Assemble and put the removable HDD rack back in its place.

6. Turn the power on and see if the HDD is being recognized.

NOTE

If the HDD is not recognized after installing, please check the HDD jumper setting, power cable and data cable connection.

6.2 INSTALL THE HDD2

CAUTION

TO INSTALL A HARD DISK DRIVE (HDD) FOR SLAVE, UNPLUG THE AC POWER CORD AS THIS CAN RESULT IN A RISK OF ELECTRIC SHOCK.

The HDD2 (SLAVE) can be installed inside of the system.

The power switch must be turned off and unplug the power cord to prevent an electric shock may happen.

1. Turn the power switch off and unplug the power cord.

2. Remove the cover by using driver.

(Remove the screws on both side and back of the product.)

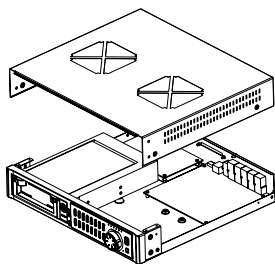

3. Set the jumper setting to SLAVE on the HDD.

There are four holes on the bottom of the system. Attach the HDD2 to the bottom (Refer to the below).

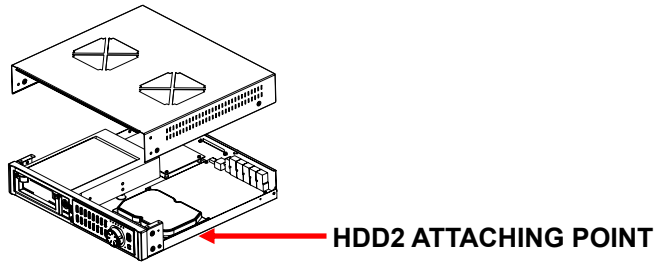

NOTE

Be sure that the jumper setting is correct. If not, the system will not recognize the additional HDD (SLAVE).

4. Secure the HDD with the supplied screws as below.

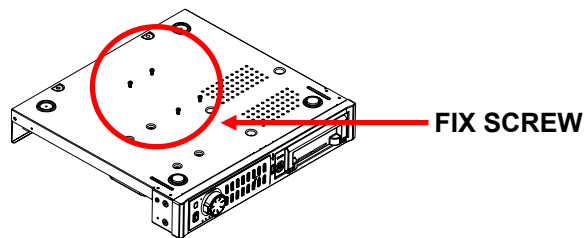

5. Connect the power connector and the flat cable to the HDD.

NOTE

Be sure that the power connector and the flat cable are properly connected.

6. Reassemble the cover.

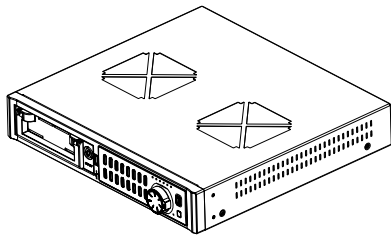

7. Turn the power on and see if the HDD is being recognized.

NOTE

After installing the additional HDD, formatting the new HDD should be performed. See 5.5.2 Hard Drive for more details.

7. PTZ CONTROL

1. Connect Pan/Tilt/Zoom camera's control to RS485(+) / RS485(-) port on the rear of the system.
2. The video output of Pan/Tilt/Zoom camera to the one out of channel you wish to connect.
3. Press and hold the PTZ button for about 3 seconds on the front panel and the PAN/TILT CONTROL screen will be displayed on the monitor.
4. Can select the order for control that user wants to do whenever **ENTER** button is pressed.
MOVE: Change the position of screen shown on Pan/Tilt Zoom camera.
ZOOM: Change zoom in/out value of the screen shown on Pan/Tilt Zoom camera.
FOCUS: Change focus value of the screen shown on Pan/Tilt Zoom camera.
CH SEL: Select the channel that is connect to Pan/Tilt Zoom camera.
5. After finishing setup, Press the **ESC** button to exit.

NOTE	<ul style="list-style-type: none">• Connect only one Pan/Tilt/Zoom camera on the system.• The protocol of P/T/Z camera should be Pelco-D Protocol.• The baud rate of P/T/Z camera must be 2,400bps (bit per second).
-------------	--

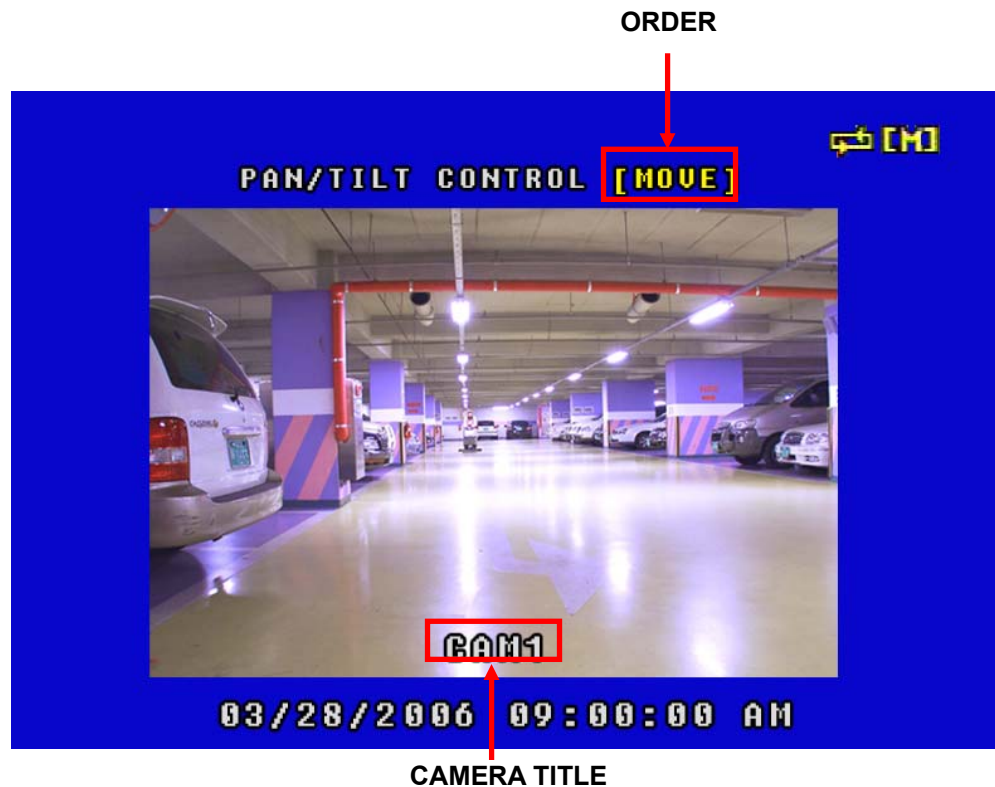

8. INSTALLATION

8.1 System Configuration Diagram

The following illustration is showing the fully installed system.

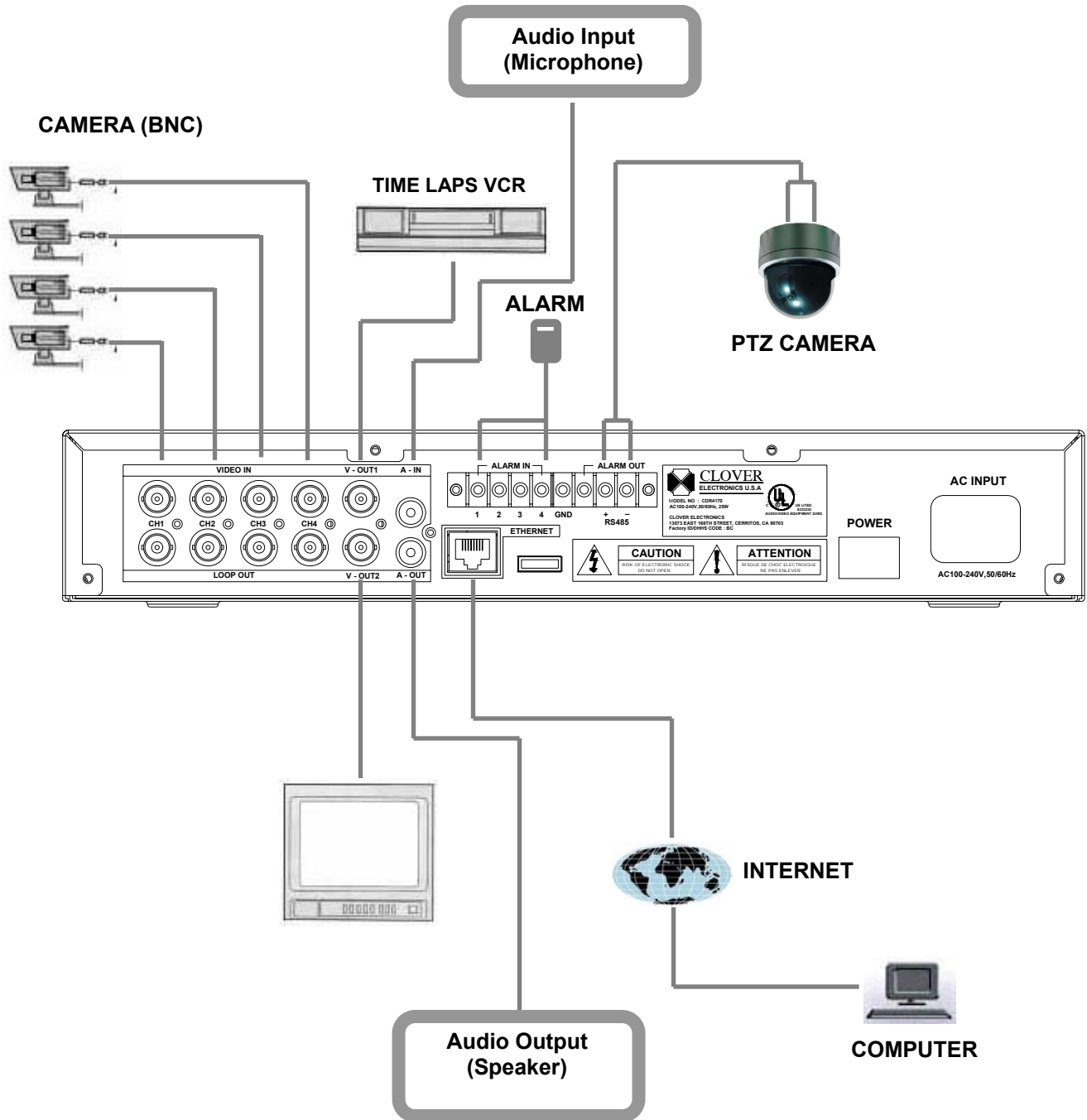

8.2 CAMERA

This product can be installed up to 4 cameras.

Connect cameras to the **VIDEO IN** (BNC) on the back panel of the product.

To connect a PTZ camera, connect the PTZ camera's control line to the RS-485 (+, -) terminal and connect the video output to one out of **VIDEO IN** on the back panel of the product.

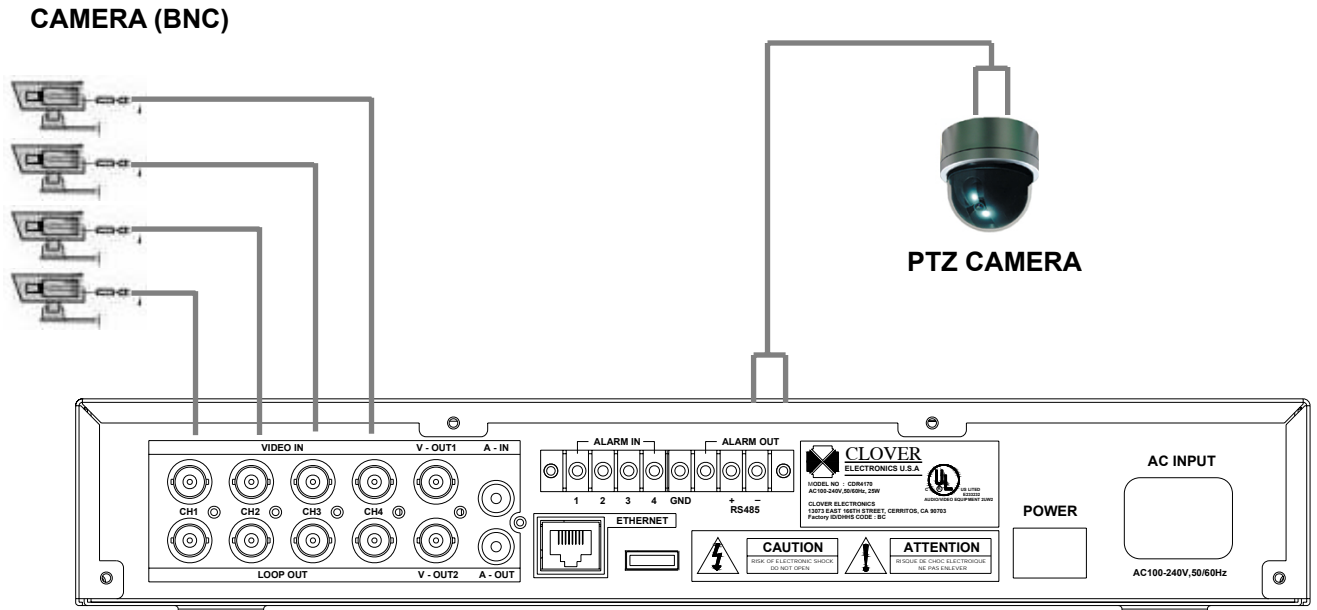

NOTE

A **LOOP OUT** is a looping output trough **VIDEO IN**. Therefore the monitor for looping output can be used only when there is video signal on the **VIDEO IN**.

8.3 AUDIO

The system has one channel audio input and output. If you wish to record and playback audio signal, connect the proper audio device (microphone) to the AUDIO IN (1 Vp-p @600 ohms) and speaker to the AUDIO OUTPUT (See illustration below).

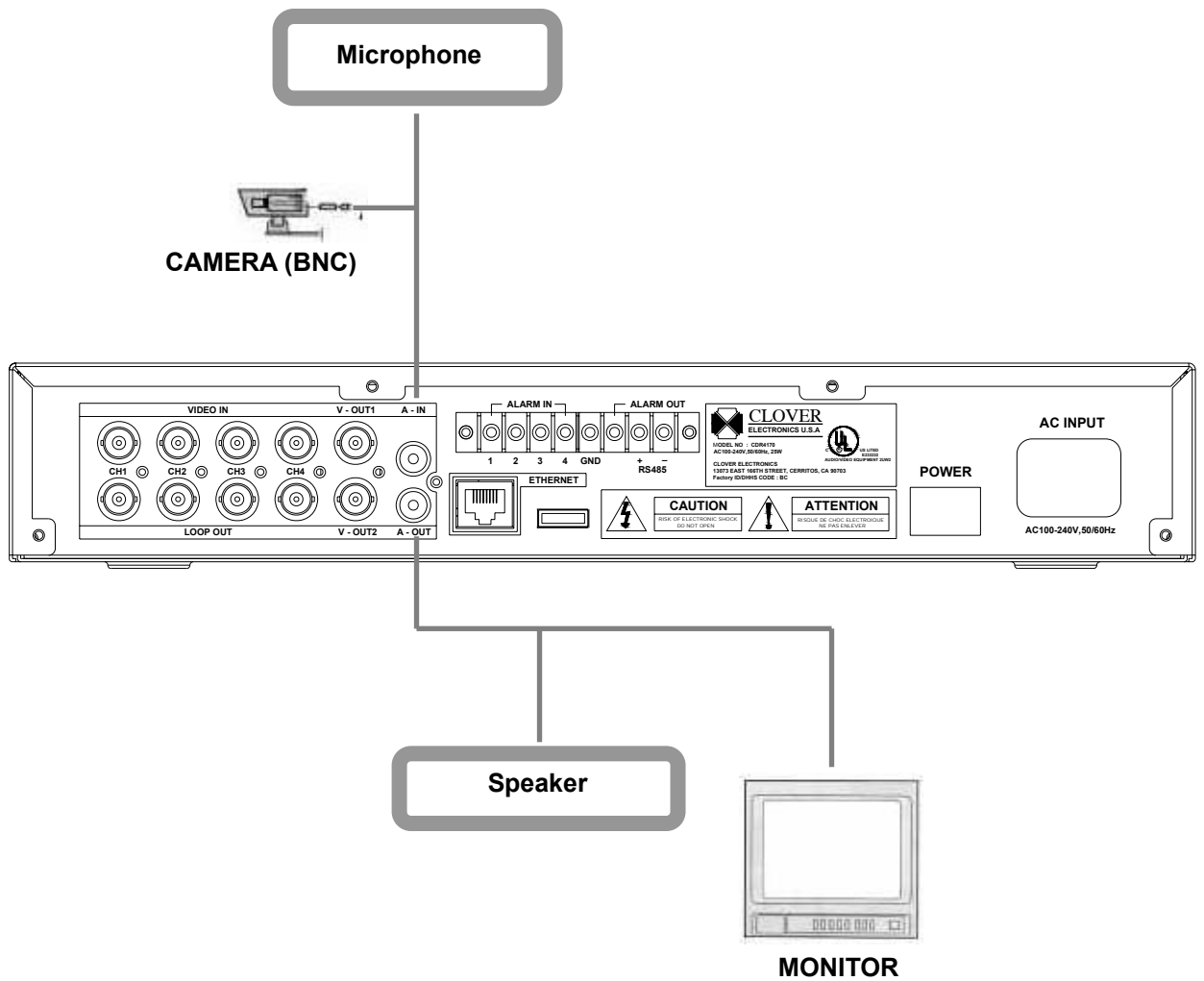

8.4 MONITOR

There are two video outputs (BNC) on the rear panel of this system. Connect monitors, Time Lapse VCR for backup on the tape and etc. depending on your application.

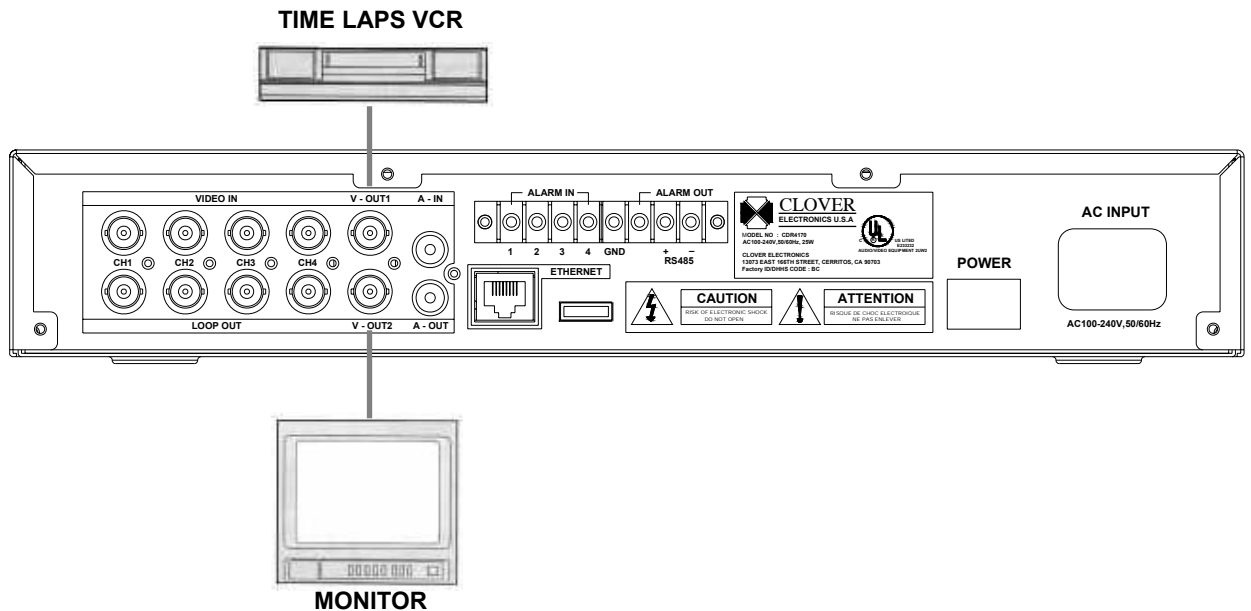

9. NETWORKING

9.1 REQUIREMENTS

- DVR system
- PC

Required Specifications

1. OS: Microsoft Windows 98 / 2000 / XP
 2. CPU: PENTIUM-4 1.0GB or higher
 3. MEMORY: 256MB or higher
 4. 1024x768 Display Resolution
32 Bit Color
 5. Hard Disk Drive: 10 MB (Minimum space to install the program.)
(In order to use SAVE or BACKUP function on the GUI, needs more space of the HDD)
 6. Internet or LAN connection
 7. TCP/IP installed
- Cable
 1. Direct connection to PC: twist cable (cross over).
 2. Connection via hub or router: direct cable.
 - IP address
 - Client program (supplied)

9.2 INSTALLING THE PROGRAM TO THE PC

Install the program into the PC by using program CD (supplied) as follows.

How to install the client program (CLDVR)

1. Start the operating system (Windows 98/2000/XP).
2. Insert the program CD into CD-ROM drive.
3. Open **My Computer**, and then select CD-ROM drive.
4. Select the **CLDVR** folder, and then double click **SetupCLDVR.EXE**. The software installation will begin.
5. After the installation has been completed, the **CLDVR** icon will be created on your desktop screen.
7. Double click the **CLDVR** icon and the **CLDVR GUI** program appears.

How to set Screen Color Resolution

1. Click **Start**, point to **Control Panel** and then click on it.
2. Double-click **Display** icon.
3. In **Display Properties** Window, select **Settings**.
4. Set **Colors** as **True color (32 bit)** and **Screen area** as **1024 by 768 pixels**.

NOTE	A warning message due to a codec installation appears during installing the program. Click "Continue Anyway button".
-------------	---

9.3 CONNECTING THE DVR THROUGH GUI (CLDVR)

Double-click the **CLDVR** icon on your desktop to connect the DVR through **GUI** and the following window will be displayed on the screen.

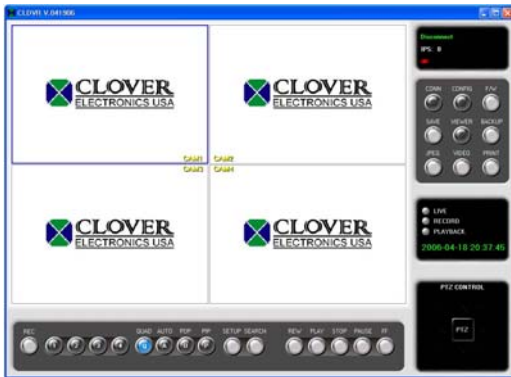

Click **CONFIG** button on the GUI (as shown below).



The following **CONFIG** screen will be shown.



- Enter the **IP/URL**, **Port number** (default: 5700) and **ID** (default: admin), which must be the same as for DVR.

NOTE:

- If the registered Host Name is CLOVER11 at www.dyndns.org, enter clover11.dyndns.org in IP/URL.
- If the registered ID is CLOVER11 at www.cloverdvr.com, enter clover11.cloverdvr.com in IP/URL.
- Please pay attention to port forwarding (refer to section 5.5.6.5 PORT).

- Select the video format depending on broadcasting system in your country (NTSC in USA).
- Click OK button.
- Click the **CONN** button on the GUI and window comes up as below.

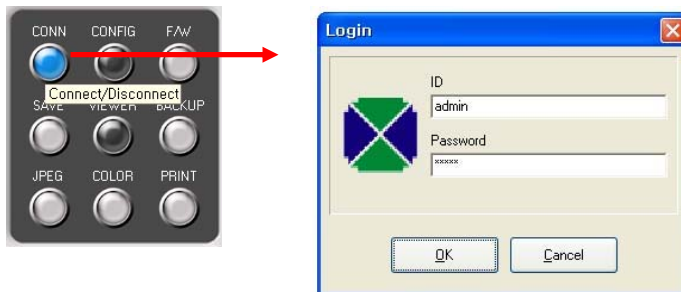

- Enter the **ID** (default: admin) and the **Password** (default: admin), which must be the same as for DVR.

NOTE

Maximum 2 users can connect the DVR through the GUI at the same time.

9.4 CLDVR SCREEN

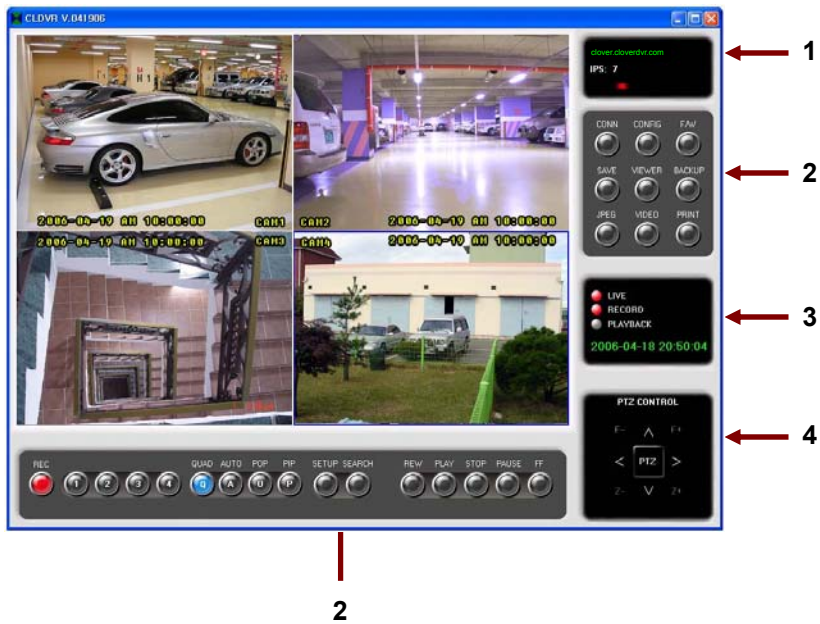

1. CONNECTION STATUS INDICATOR

It indicates that is currently being connected IP address and bandwidth (transmission speed).

2. FUNCTION OF BUTTONS

Refer to next section.

3. LED DISPLAY, CLOCK

The LED is lit depends on mode such as LIVE, PLAYBACK and RECORD. And the clock indicates the present time.

4. PTZ CONTROL

These buttons enable you to control the PTZ camera that is connected to the system.

9.5 EXPLANATION OF CLDVR FUNCTION

9.5.1 FUNCTION OF BUTTONS



1. F/W (FIRMWARE)

The FIRMWARE can be upgraded by pressing the **F/W** button or USB device.



This button is not for users, only for manufacturers and distribution center.

2. SAVE

- Click the **SAVE** button to save the video images that is currently being displayed on the GUI.



- The following pop-up window will appear.

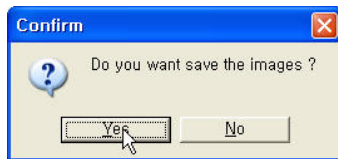

- Click **YES**.
- While saving data, this button will turn red in color.



- Click the **SAVE** button again to stop saving. The button will turn blue in color.



- To view the saved image file, click **VIEWER**>click **OPEN** in **LOCAL VIEWER**>double click **SAVE FILES** in **CLDVR**>double click file list>click **PLAY**.

3. LOCAL VIEWER

- Click the **VIEWER** button and the **LOCAL VIEWER** screen will show up (See Section 9.6 for more details).

4. BACKUP

- Click the **BACKUP** button to save the data of DVR into PC and the following window will be shown below.



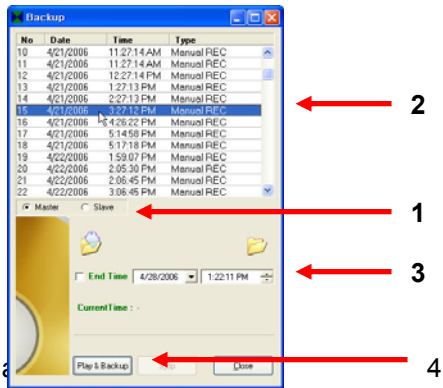

1. Select the HDD (Master or Slave)
 2. Select 1 out of the lists for setting up the **Backup Start Time**.
 3. Setup the **Backup End Time** and click on blank box. If the **End Time** is not selected, the **BACKUP** continues until the **Playback** automatically ends.
 4. Click the **Play&Backup** button, and data will be saved on the **BACKUP** folder.
- If you wish to stop manually, click the **STOP** button.
 - To view the Backup image file, click **VIEWER**>click **OPEN** in **LOCAL VIEWER**>double click **BACKUP FILES** in **CLDVR**>double click file list>click **PLAY**.

5. JPEG

- Click one out of 4 channels and then click the **JPEG** button to save the image in JPEG file format. You can only save the selected channel (one channel).



- To view the saved file, go to the directory of the saved file by using **Windows Explorer** and double click on it.

6. VIDEO ENHANCEMENT

- Click the **VIDEO (VIDEO ENHANCEMENT)** button to enhance the picture quality of each channel such as Brightness, Contrast, Hue (Tint) and Saturation (Color) shown on the GUI screen.



- Select channel you wish to enhance the picture quality.
- Click the **RESET** button to reset the values.
- To exit, click the **CLOSE** button.

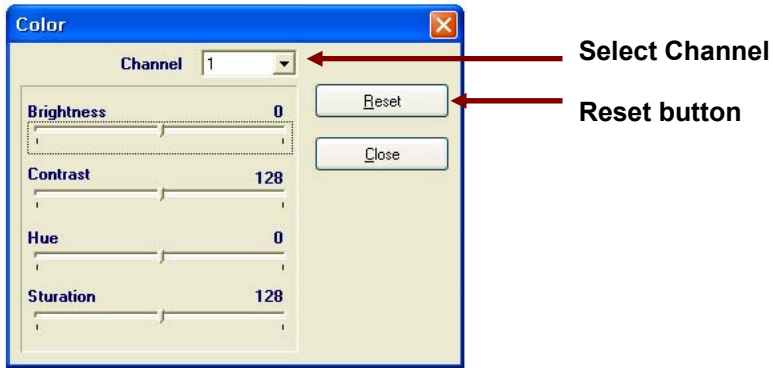

7. PRINT

- Click the **PRINT** button to print the current pictures shown on the GUI and then the following window pops up along with “WAIT...”. Please wait a couple of seconds until the system loads data to print.

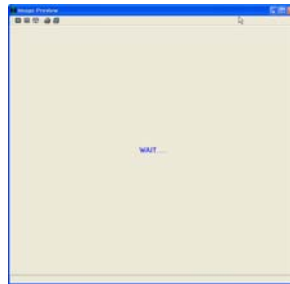

8. REC

- Click the **REC** button to start or stop recording. User can switch **ON** or **OFF** recording from a remote location through the network when the DVR is in the recording mode.



- When the system is in the recording mode, the button will turn red in color.



- If not recording, the button turns green in color.



9. CHANNEL SELECTION BUTTONS

- You can see a channel in full screen by clicking one of the channel selection buttons.

10. QUAD BUTTON

- Click the Quad button to display the quadrant pictures.

11. AUTO BUTTON

- The GUI will be viewed a full screen at a time in a continuous sequence (one camera after another) by clicking this button.
- The dwell time can be set from 1 to 10 seconds in the **SETUP** menu on the GUI.
- The sequencing order: CH1->CH2->CH3->CH4->QUAD.

12. POP

- It stands for Picture of Picture.
- Click the **POP** button, and it will be displayed a medium screen and 3 small screens.

13. PIP

- It stands for Picture In picture.
- Click the **PIP** button, and it will be displayed 3 PIPs on a full screen.

14. SETUP

Click the **SETUP** button on the GUI, and it will be appeared the following window that can change the values in regards to DVR.

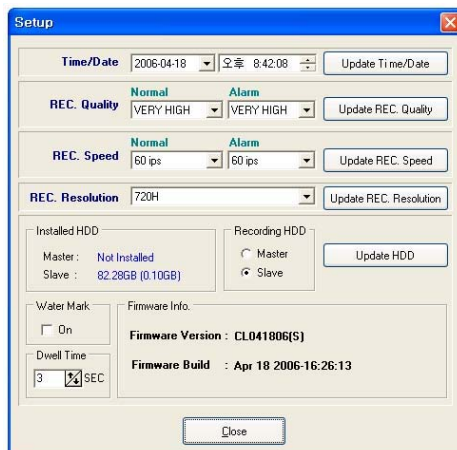

- **Time/Date:** Shows the current time on the computer. After changing the values, press the **Update Time/Date** button on the right side to save the values. This function does not affect the DVR.
- **REC. Quality:** Shows the **REC Quality** values on the DVR. Change the values on the window and press the **Update REC.Quality** button to save them. You can change the values on the DVR related to the Continuous Recording and Alarm Recording.
- **REC. Speed:** Shows the **REC Speed** values on the DVR. Change the values on the window and press the **Update REC. Speed** button to save them. You can change the values on the DVR related to the Continuous Recording and Alarm Recording.
- **REC. Resolution:** Shows the **REC Resolution** values on the DVR. Change the values

on the window and press the **Update REC.Quality** button to save them.

- **Installed HDD and Recording HDD:** Shows currently installed HDD information such as connection information, whole capacity and used space. It shows currently being recorded HDD as well. Do not change the recording HDD as possible as you can.
- **Water Mark (on the GUI):** The **WATER MARK** allows you to verify if an original image has been altered. Click the **WATER MARK ON** to put the **WATER MARK** on the original images. If the **WATER MARK** on the original images is being broken in the playback mode, the images have been altered. If not, the images have not been altered.

This function does not affect the DVR.

- **Dwell. Time:** It can be adjusted from 1 to 10 seconds (See #11. AUTO BUTTON for more details). This function does not affect the DVR.
- **Firmware information:** Current product's firmware version and time when it was updated.

NOTE

If you connect the DVR through the GUI as a guest, you cannot change the values. It allows a guest to monitor only.

15. SEARCH

Click the **SEARCH** button, and it will be displayed the following window.



- **The last record list**
Select **The last record list** on the search window and press OK. It will replay from the beginning of the last list that recorded on HDD.
- **The whole REC Lists**
Select **The whole REC Lists** on the search window and press OK. The following Window will be displayed.

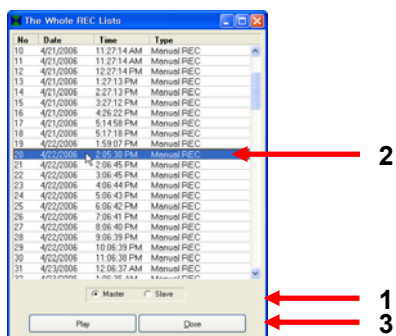

1. Select **HDD** (Master/Slave) you wish to search.
2. Choose one of recording lists, which are updated hourly up to 1,000 lists on both Master and Slave.
3. Click the **Play** button to replay the selected list, or double click the selected list to replay.
4. To stop replaying, press the **STOP** button.

- Event REC Lists

Select the **Event REC Lists** on the search window and press OK. The following Window will be displayed.

1. Select **HDD** (Master/Slave) you wish to search.
2. Choose one of event recording lists, which are updated up to 300 lists on both Master and Slave.
3. Click the **Play** button to replay the selected list, or double click the selected list to replay.
4. To stop replaying, press the **STOP** button.

- Time/Date Search

Select the **Time/Date Search** on the search window and press OK.

The following Window will be displayed.

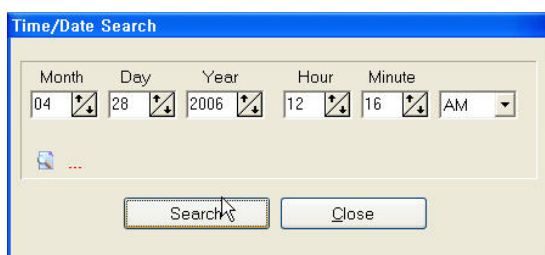

Select the time and date by using UP/DOWN button.

After selection, press the Search button.

After showing the following window, and it will be displayed the recorded images.



16. REW

- Press this button to rewind the recorded images.
- The speed will be increased up to x16 speed when you keep clicking this button.
- The speed is shown below the buttons.



17. PLAY

Press this button to replay from the beginning of the first recording list on HDD.

18. STOP

Press this button to stop replaying.

19. PAUSE

Press this button to pause replaying.

20. FF

- Press this button to fast forward the recorded images.
- The speed will be increased up to x16 speed when you keep clicking this button.
- The speed is shown below the buttons.



9.5.2 PTZ CONTROL

The following picture enables you to control PTZ camera connected to the system.

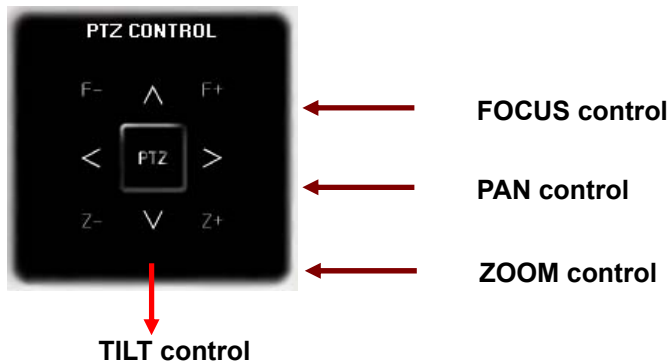

PAN/TILT CONTROL

Press UP key for TILT UP, DOWN key for TILT DOWN, LEFT key for PAN LEFT and RIGHT key for PAN RIGHT.

FOCUS/ZOOM CONTROL

Press “Z+” key for ZOOM IN, “Z-“ key for ZOOM OUT, “F-” key for FOCUS NEAR and “F+“ key for FOCUS FAR.

9.6 LOCAL VIEWER

Local Viewer is to play the **USB** Memory saved file by DVR, **SAVE file** saved by SAVE button and **BACKUP file** saved by BACKUP button on the GUI, and to convert those files to **AVI file format**.

9.6.1 Control Button

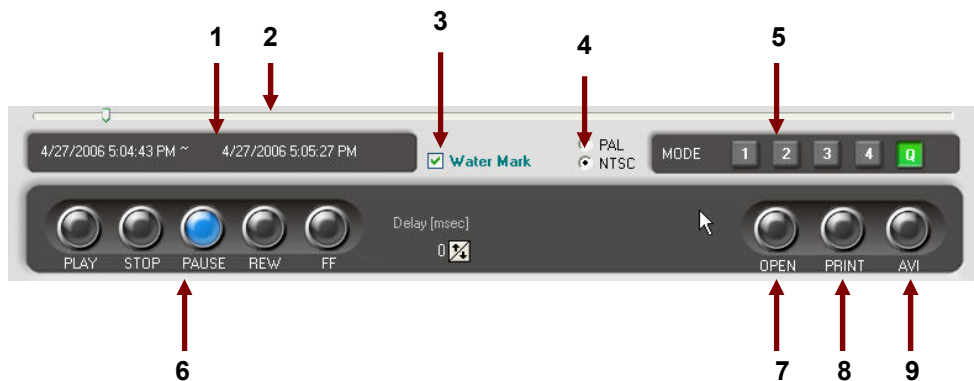

1. It indicates that the TIME /Date of recording file saved by SAVE button, BACKUP button on the GUI and USB Memory.
2. The Bar will be moving forward when the PLAY button on the LOCAL VIEWER is pressed.

3. Click in the box of WATER MARK to put WATER MARK while replaying (See section 9.5.1 #14 setup for more details).
4. Select TV system between NTSC and PAL depending on the broadcasting system in your country (**NTSC in USA**).
5. You can see a channel in full screen by choosing one among **1,2,3** and **4**, and the quadrant pictures by clicking “**Q**”.

6. **PLAY BUTTON**

Click **VIEWER** on the **GUI** – click **OPEN** on the **LOCAL VIEWER** – double click on one folder among **BACKUP**, **SAVE** and **USB** folders in **CLDVR** (in program files) – double click the selected file – click the **PLAY** button to replay. Refer to section 9.5.1 setup in regards to **STOP**, **PAUSE**, **REW** and **FF** button.

7. This button is used to open the files you wish to play.
8. This button is used to print the current image on the **LOCAL VIEWER**.
9. Click the **AVI** Button during replaying, and the **CHOOSE CAMERA** window will appear.

Choose the camera(s) in **CHOOSE CAMERA** window to convert the file(s) to **AVI** file format. The **AVI** button will turn **RED** in color and the Bar will indicate the progress status.

Click the **STOP** button to stop converting the files(s) to **AVI** file format, or it will automatically stop after finishing and the LED will turn off.

TO PLAY THE AVI FILE FORMAT

Open **Windows Explorer** – click the **Program Files** in your computer – click **CLDVR** – click **AVI** files – double click the file you wish to play (Before playing, see if your computer has the software for Windows Media Player).

APPENDIX

1. RECORDING TIME TABLE (DAYS)

1.1 REC RESOLUTION (720H) / REC QUALITY (VERY HIGH)

SPEED	40G HDD	80G HDD	120G HDD	200G HDD
01 IPS	15-Days 19-Hours	31-Days 12-Hours	47-Days 07-Hours	78-Days 19-Hours
02 IPS	7-Days 22-Hours	15-Days 19-Hours	23-Days 17-Hours	39-Days 12-Hours
03 IPS	5-Days 07-Hours	10-Days 12-Hours	15-Days 19-Hours	26-Days 07-Hours
05 IPS	3-Days 05-Hours	6-Days 07-Hours	9-Days 14-Hours	15-Days 19-Hours
10 IPS	1-Days 14-Hours	3-Days 05-Hours	4-Days 19-Hours	8-Days 00-Hours
15 IPS	1-Days 02-Hours	2-Days 02-Hours	3-Days 05-Hours	5-Days 07-Hours
30 IPS	14-Hours	1-Days 02-Hours	1-Days 17-Hours	2-Days 14-Hours
60 IPS	07-Hours	12-Hours	1-Days 00-Hours	1-Days 07-Hours

1.2 REC RESOLUTION (720H) / REC QUALITY (HIGH)

SPEED	40G HDD	80G HDD	120G HDD	200G HDD
01 IPS	21-Days 09-Hours	42-Days 19-Hours	64-Days 02-Hours	106-Days 22-Hours
02 IPS	10-Days 17-Hours	21-Days 09-Hours	32-Days 02-Hours	53-Days 09-Hours
03 IPS	7-Days 05-Hours	14-Days 07-Hours	21-Days 09-Hours	35-Days 17-Hours
05 IPS	4-Days 07-Hours	8-Days 14-Hours	12-Days 22-Hours	21-Days 12-Hours
10 IPS	2-Days 02-Hours	4-Days 07-Hours	6-Days 12-Hours	10-Days 14-Hours
15 IPS	1-Days 09-Hours	2-Days 19-Hours	4-Days 07-Hours	7-Days 02-Hours
30 IPS	17-Hours	1-Days 09-Hours	2-Days 02-Hours	3-Days 12-Hours
60 IPS	09-Hours	17-Hours	1-Days 02-Hours	1-Days 19-Hours

1.3 REC RESOLUTION (720H) / REC QUALITY (NORMAL)

SPEED	40G HDD	80G HDD	120G HDD	200G HDD
01 IPS	26-Days 00-Hours	52-Days 00-Hours	78-Days 02-Hours	130-Days 05-Hours
02 IPS	13-Days 00-Hours	26-Days 00-Hours	39-Days 02-Hours	65-Days 02-Hours
03 IPS	08-Days 17-Hours	17-Days 09-Hours	26-Days 02-Hours	43-Days 09-Hours
05 IPS	5-Days 05-Hours	10-Days 09-Hours	15-Days 14-Hours	25-Days 22-Hours
10 IPS	2-Days 14-Hours	5-Days 05-Hours	7-Days 19-Hours	13-Days 00-Hours
15 IPS	1-Days 17-Hours	3-Days 12-Hours	5-Days 05-Hours	8-Days 14-Hours
30 IPS	22-Hours	1-Days 19-Hours	2-Days 14-Hours	4-Days 09-Hours
60 IPS	09-Hours	22-Hours	1-Days 07-Hours	2-Days 05-Hours

1.4 REC RESOLUTION (720H) / REC QUALITY (LOW)

SPEED	40G HDD	80G HDD	120G HDD	200G HDD
01 IPS	29-Days 19-Hours	59-Days 12-Hours	89-Days 07-Hours	148-Days 22-Hours
02 IPS	14-Days 22-Hours	29-Days 19-Hours	44-Days 14-Hours	74-Days 09-Hours
03 IPS	9-Days 22-Hours	19-Days 17-Hours	29-Days 14-Hours	49-Days 07-Hours
05 IPS	6-Days 00-Hours	11-Days 22-Hours	17-Days 22-Hours	29-Days 19-Hours
10 IPS	3-Days 00-Hours	5-Days 22-Hours	8-Days 22-Hours	14-Days 19-Hours
15 IPS	2-Days 00-Hours	4-Days 00-Hours	6-Days 00-Hours	9-Days 22-Hours

30 IPS	1-Days 00-Hours	2-Days 00-Hours	2-Days 22-Hours	4-Days 22-Hours
60 IPS	12-Hours	1-Days 00-Hours	1-Days 12-Hours	2-Days 12-Hours

1.5 REC RESOLUTION (360H) / REC QUALITY (VERY HIGH)

SPEED	40G HDD	80G HDD	120G HDD	200G HDD
01 IPS	24-Days 22-Hours	49-Days 19-Hours	74-Days 14-Hours	124-Days 09-Hours
02 IPS	12-Days 09-Hours	24-Days 22-Hours	37-Days 07-Hours	62-Days 05-Hours
03 IPS	8-Days 07-Hours	16-Days 17-Hours	25-Days 00-Hours	41-Days 17-Hours
05 IPS	5-Days 00-Hours	10-Days 00-Hours	15-Days 00-Hours	25-Days 00-Hours
10 IPS	2-Days 12-Hours	5-Days 00-Hours	7-Days 12-Hours	12-Days 12-Hours
15 IPS	1-Days 17-Hours	3-Days 07-Hours	5-Days 00-Hours	8-Days 07-Hours
30 IPS	19-Hours	1-Days 17-Hours	2-Days 12-Hours	4-Days 05-Hours
60 IPS	09-Hours	19-Hours	1-Days 07-Hours	2-Days 02-Hours

1.6 REC RESOLUTION (360H) / REC QUALITY (HIGH)

SPEED	40G HDD	80G HDD	120G HDD	200G HDD
01 IPS	33-Days 07-Hours	66-Days 17-Hours	100-Days 00-Hours	166-Days 17-Hours
02 IPS	16-Days 19-Hours	33-Days 17-Hours	50-Days 12-Hours	84-Days 05-Hours
03 IPS	11-Days 05-Hours	22-Days 09-Hours	33-Days 14-Hours	56-Days 00-Hours
05 IPS	6-Days 17-Hours	13-Days 12-Hours	20-Days 05-Hours	33-Days 14-Hours
10 IPS	3-Days 09-Hours	6-Days 17-Hours	10-Days 02-Hours	16-Days 19-Hours
15 IPS	2-Days 02-Hours	4-Days 12-Hours	6-Days 17-Hours	11-Days 02-Hours
30 IPS	1-Days 02-Hours	2-Days 07-Hours	3-Days 09-Hours	5-Days 14-Hours
60 IPS	14-Hours	1-Days 02-Hours	1-Days 17-Hours	2-Days 19-Hours

1.7 REC RESOLUTION (360H) / REC QUALITY (NORMAL)

SPEED	40G HDD	80G HDD	120G HDD	200G HDD
01 IPS	40-Days 14-Hours	81-Days 07-Hours	122-Days 00-Hours	203-Days 05-Hours
02 IPS	20-Days 07-Hours	40-Days 17-Hours	60-Days 22-Hours	101-Days 12-Hours
03 IPS	13-Days 12-Hours	27-Days 02-Hours	40-Days 14-Hours	67-Days 17-Hours
05 IPS	8-Days 02-Hours	16-Days 07-Hours	24-Days 09-Hours	40-Days 15-Hours
10 IPS	4-Days 02-Hours	8-Days 02-Hours	12-Days 05-Hours	20-Days 07-Hours
15 IPS	2-Days 17-Hours	5-Days 09-Hours	8-Days 02-Hours	13-Days 12-Hours
30 IPS	1-Days 09-Hours	2-Days 17-Hours	4-Days 02-Hours	6-Days 19-Hours
60 IPS	17-Hours	1-Days 09-Hours	2-Days 02-Hours	3-Days 09-Hours

1.8 REC RESOLUTION (360H) / REC QUALITY (LOW)

SPEED	40G HDD	80G HDD	120G HDD	200G HDD
01 IPS	46-Days 07-Hours	92-Days 14-Hours	138-Days 22-Hours	231-Days 12-Hours
02 IPS	23-Days 12-Hours	47-Days 00-Hours	70-Days 09-Hours	117-Days 09-Hours
03 IPS	15-Days 14-Hours	31-Days 05-Hours	46-Days 19-Hours	77-Days 22-Hours
05 IPS	9-Days 14-Hours	18-Days 17-Hours	28-Days 02-Hours	46-Days 19-Hours

10 IPS	4-Days 17-Hours	9-Days 09-Hours	14-Days 02-Hours	23-Days 09-Hours
15 IPS	3-Days 02-Hours	6-Days 07-Hours	9-Days 09-Hours	15-Days 14-Hours
30 IPS	1-Days 14-Hours	3-Days 02-Hours	4-Days 17-Hours	7-Days 19-Hours
60 IPS	19-Hours	1-Days 12-Hours	2-Days 07-Hours	3-Days 22-Hours

1.9 REC RESOLUTION (CIF) / REC SPEED (120 IPS)

QUALITY	40G HDD	80G HDD	120G HDD	200G HDD
VERY HIGH	12-Hours	1-Days 02-Hours	1-Days 14-Hours	2-Days 17-Hours
HIGH	17-Hours	1-Days 09-Hours	2-Days 02-Hours	3-Days 12-Hours
NORMAL	22-Hours	1-Days 19-Hours	2-Days 14-Hours	4-Days 09-Hours
LOW	1-Days 00-Hours	2-Days 00-Hours	3-Days 00-Hours	5-Days 00-Hours

2. FACTORY DEFAULT TABLE

1] ALARM

[1] ALARM : OFF

[2] ALARM HOLD / INPUT

- CAM 1 : 05 SEC N/O

- CAM 2 : 05 SEC N/O

- CAM 3 : 05 SEC N/O

- CAM 4 : 05 SEC N/O

[3] ALARM OPTION

[3-1] ALARM REC : OFF

[3-2] REC QUALITY : HIGH

[3-3] REC SPEED : 60 IPS

[3-4] ALARM OUTPUT : N/O

[3-5] ALARM BUZZER : OFF

[3-6] ALARM REC : OFF

2] MOTION

[1] MOTION : OFF

[2] CHANNEL : CH1

[3] SENSITIVITY : 3

[4] AREA : Not setup

3] SYSTEM

[1] TIME/DATE

[1-1] TIME FORM : 12 HOURS

- [1-2] TIME : Time does not get initialization.
- [1-3] DATE FORM : MM/DD/YYYY
- [1-4] DATE : Date does not get initialization.
- [2] HARD DISK
 - [2-1] HDD1 : Shows information on HDD that is connected to HDD1.
 - [2-2] HDD1 : Shows information on HDD that is connected to HDD2.
 - [2-3] HDD INFO : BYTE
- [3] FACTORY DEFAULT SETTING
- [4] SYSTEM INFORMATION : SYSTEM FIRMWARE VERSION
- [5] FIRMWARE UPDATE
- [6] IP CONFIGURATION
 - [6-1] IP MODE : DYNAMIC IP
 - [6-2] IP ADDRESS
 - [6-3] SUBNET
 - [6-4] GATEWAY
 - [6-5] PORT : 5700
 - [6-6] MAC ID : Product's MAC ID
 - [6-7] SERVER : 65.60.84.10
- [7] NETWORK PERFORMANCE
 - [7-1] BANDWIDTH : 2.0 MBPS

4] VIDEO

- [1] CAMERA TITLES
 - [1-1] CAM1 : CAM1
 - [1-2] CAM2 : CAM2
 - [1-3] CAM3 : CAM3
 - [1-4] CAM4 : CAM4
- [2] DWELL TIME
 - [2-1] CAM1 : 01 SEC
 - [2-2] CAM2 : 01 SEC
 - [2-3] CAM3 : 01 SEC
 - [2-4] CAM4 : 01 SEC

5] RECORD

- [1] REC QUALITY : HIGH
- [2] REC RESOLUTION : 720H
- [3] REC SPEED : 60 IPS
- [4] HDD OVERWRITE : ON
- [5] AUDIO REC : ON
- [6] SCHEDULE REC

- [6-1] SCHEDULE REC : OFF
- [6-2] SCHEDULE REC SETTING : No setup data

6] DISPLAY

- [1] TITLE DISPLAY : ON
- [2] BORDER LINE : ON
- [3] TIME / DATE : ON
- [4] POSITION : BOTTOM

7] BUZZER

- [1] KEY BUZZER : ON
- [2] VIDEO LOSS : ON

8] ACCOUNT

- [1] DVR ACCOUNT SET
 - [1-1] PASSWORD : OFF
 - [1-2] PASSWOD CHANGE
DEFAULT PASSWORD IS 11111111
- [2] NETWORK ACCOUNT SET
 - [2-1] USER ID : ADMIN
 - [2-2] USER P/W : ADMIN
 - [2-3] GUEST P/W : GUEST

9] DDNS

- [1] DDNS USE : NO
- [2] HOST NAME : Not setup
- [3] USER NAME : Not setup
- [4] PASSWORD : Not setup

3. FAQ

PARTIAL MALFUNCTION OF SURVEILLANCE SCREEN

1. CERTAIN CHANNEL UNAVAILABLE
 - Check the camera power, connection or cleaning of connection part.
 - In case of camera defect, replace the camera.
2. CERTAIN CHANNEL SHAKERING, BLURING, SPLITTING, etc.
 - Check the camera power, connection or cleaning of connection part.
 - Check the system Setting (NTSC or PAL).
 - In case of camera defect, replace the camera.
3. CERTAIN CHANNEL TOO BRIGHT OR TOO DARK

- Check the brightness and contrast level of the monitor.
- 4. CHANNEL IS IN BLACK & WHITE MODE
 - Check the cameras.

RECORDING RELATED PROBLEMS

1. RECORDING UNAVAILABLE
 - Adjust the camera screen.
 - Check recording speed or recording schedule.
 - Adjust the system.

PLAY AND SEARCH RELATED PROBLEMS

1. No Recorded Data.
 - Check camera input.
 - Check record setup.
2. CERTAIN CHANNEL WITH NO RECORDED DATA
 - Check the record setup.
3. TOO LOW QUALITY RECORDED DATA
 - Check camera input.
 - Check the system Setting (NTSC or PAL).
 - Check the record setup.

MISCELLANEOUS PROBLEMS

1. HDD NOT FOUND
 - Check whether the removable HDD rack is locked.
And check the power LED of the removable HDD rack.
If the green LED is on, the power from the Power Board is working.
 - Check the connection cable (40-PIN Flat Cable) and power connection in the removable HDD rack.
 - In case of no problem is discovered from the above checks, contact your supplier.
2. NOISE FROM THE SYSTEM
 - Check the HDD.
Replace the HDD if possible.
Old HDD's may make the noise when it is running.

Limited 2Year Warranty

This warranty gives the original purchaser specific legal rights and you may also have other rights, which may vary from state to state. If our products do not function because of any defect in material or workmanship, we will repair it for free for 2 year on parts and labor from the date of original purchase. This warranty does not cover modification, abuse, incidental or consequential damages unless the state of owner's residence specially prohibits limitations on incidental or consequential damages.

How to obtain Factory Service

- Original purchaser must fill out the warranty card and mail it to the factory with the model number, serial number and the date of purchase.
- We will repair or replace, and return the system to the owner under this limited warranty.
- Please pack the system carefully and securely using the original packing materials, and send it prepaid and insured to: **13073 E. 166th St, Cerritos, CA 90703.**
- Please include a check for \$30.00 to cover the cost of return postage and handling. If the system is returned within the warranty period, please include a proof of purchase. If the system is out of warranty, you will receive an estimate of the repair cost for your approval before repair work will be started

Free Manuals Download Website

<http://myh66.com>

<http://usermanuals.us>

<http://www.somanuals.com>

<http://www.4manuals.cc>

<http://www.manual-lib.com>

<http://www.404manual.com>

<http://www.luxmanual.com>

<http://aubethermostatmanual.com>

Golf course search by state

<http://golfingnear.com>

Email search by domain

<http://emailbydomain.com>

Auto manuals search

<http://auto.somanuals.com>

TV manuals search

<http://tv.somanuals.com>