

INSTRUCTION MANUAL

Stand-Alone 16 Channel

DIGITAL VIDEO RECORDER

MODEL CDR1650

Ver. 041308, 042909,102609

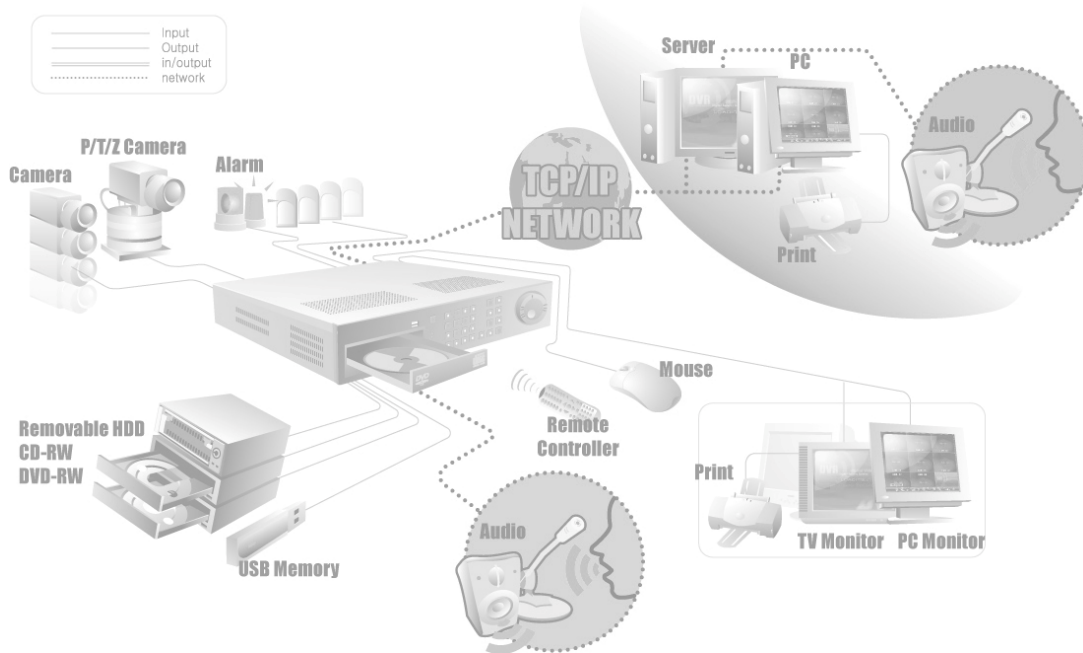

CLOVER
ELECTRONICS U.S.A.

Copyright © 2008 Clover Electronics U.S.A. All Rights Reserved.

CONTENTS

ABOUT THIS MANUAL.....	9
1. UNPACKING.....	11
STAND-ALONE DVR (DIGITAL VIDEO RECORDER) UNIT	12
2.FEATURES	13
3.WHAT TO DO AT THE TIME OF INSTALLATION.....	15
4.SPECIFICATIONS.....	17
5. INSTALLATION	19
5-1. CONTROLS AND CONNECTORS (FOR 8CH & 16CH DVR).....	20
5-2. NOTE FOR INSTALLATION	22
5-3. SYSTEM CONNECTION	23
5-4. INSTALLATION	24
5-4.1. Camera Connection	24
5-4.2. Monitor Connection.....	24
5-4.3. Sensor Connection and RELAY IN &OUT.....	26
5-4.4. RS232C,RS485, RS422 Connection.....	28
5-4.5 Connection to an Ethernet Network.....	29
5-4.6. POWER CONNECTION	30
6.HOW TO OPERATE	31
6-1. GENERAL INFORMATION	33
6-2. OPERATING INTERFACE.....	34
6-3. IR REMOTE CONTROLLER	35
6-4. POWER ON/OFF	36
6-4.1. POWER ON	36
6-4.2. POWER OFF	36
6-4.3. APPEARANCE OR DISAPPEARANCE OF POWER BUTTON	37
6-5. MENU BAR ON/OFF	38
6-6. DISPLAY SCREEN.....	39
6-6.1. FULL SCREEN.....	39

6-6.2. SPLIT SCREENS.....	40
6-7. LIVE	41
6-7.1. FULL SCREEN.....	41
6-7.2. SPLIT SCREEN	41
6-7.3. SEQUENCING SCREENS	42
6-7.4. LIVE AUDIO	43
6-7.5. ZOOM.....	44
6-7.6. OSD ON / OFF.....	45
6-7.7. PAN / TILT	46
6-7.8. SYSTEM STATUS.....	49
6-7.9. POWER LOSS LISTS	50
6-7.10. VIDEO LOSS LIST.....	52
6-8. RECORD	54
6-8.1. Manual (Continuous) recording	54
6-8.2. Manual Event Recording.....	54
6-8.3. Timer Recording.....	55
6-8.4. Timer Event Recording	56
6-8.5. Recording Icons	57
6-9. REPLAY	58
6-9.1. QUICK REPLAY.....	58
6-9.2. REPLAY	58
6-9.2.1. Playback Devices.....	59
6-9.2.2. Set the Start Time	59
6-9.2.3. Replaying	61
6-9.2.4. Disappearance of Replay control buttons	63
6-10. COPY	65
6-10.1. Copying devices.....	65
6-10.2. Set the Copy Start Time (Copying extent)	66
6-10.3. Set the Copy End Time (Copying extent)	68
6-10.4. Copying the recorded data during replaying	69
7.SETUP.....	73
7-1. SETUP	76
7-2. SYSTEM	77

Contents

7-2.1. TIME / DATE	78
7-2.2. SYSTEM CONFIG	80
7-2.2.1. FACTORY DEFAULT	80
7-2.2.2. LOAD CONFIG / BACKUP CONFIG	81
7-2.3. PASSWORD.....	83
7-2.4. IR REMOTE ID.....	84
7-2.5. FIRMWARE UPDATE	85
7-2.6. SYSTEM INFO.....	85
7-3. DISK MANAGER.....	86
7-3.1. HDD WRITE FAIL	87
7-3.2. HDD OVERWRITE.....	87
7-3.3. Format	87
7-4. CAMERA.....	89
7-4.1. Camera ON/OFF.....	90
7-4.2. Camera Name (Camera Title).....	90
7-4.3. Buzzer	91
7-4.4. Relay	91
7-4.5. Pan/Tilt Settings	92
7-4.6 Display.....	96
7-4.7 Sequencing dwell time	96
7-5. AUDIO	97
7-5.1. Audio Recording ON/OFF	97
7-5.2. Microphone Volume	97
7-6. RECORD.....	98
7-6.1. Record ICON Display.....	98
7-6.2. All Manual / Timer recording button	99
7-6.3. All Motion ON / OFF, Sensitivity and Velocity Setting.....	100
7-6.4. All Sensors ON / OFF	101
7-6.5. Size (Recording Resolution).....	101
7-6.6. Recording Speed.....	102
7-6.7. Recording Quality.....	103
7-6.8. Recording Mode.....	104
7-6.8.1. Manual Recording.....	104
7-6.8.2. Manual Event Recording	104

7-6.8.3. Timer Recording (Schedule Recording)	104
7-6.8.4. Timer Event Recording	104
7-6.9. Recording by Motion Detection.....	105
7-6.10. Recording by Sensor (PIR Sensor)	113
7-7. NETWORK.....	116
7-7.1. IP Mode	116
7-7.2. GATEWAY, SUBNET, IP ADDRESS	117
7-7.3. Port.....	118
7-7.3.1 Port Forwarding	118
7-7.4. MAC ID.....	119
7-7.5. MNS (MAC NAME SERVER)	119
7-7.6. DDNS (DYNAMIC DOMAIN NAME SYSTEM).....	121
7-7.7. HOW TO SETUP AND USE THE DDNS.....	123
7-7.7.1. Router.....	123
7-7.7.2. Registration to the DDNS server	123
7-7.8. EMAIL NOTIFICATION	124
7-8. VIDEO ENHANCE	127
7-8.1. VIDEO ENHANCEMENT ON EACH CAMERA.....	128
7-8.2. VIDEO ENHANCEMENT ON VGA OUTPUT.....	129
8.REMOTE HOST PROGRAM	131
8-1. REMOTE PROGRAM OVERVIEW.....	133
8-2. INSTALLING THE PROGRAM TO PC.....	134
8-3. INTERNET EXPLORER.....	135
8-4. REMOTE HOST	137
8-4.1. Setup	139
8-4.2. Connection	141
8-4.3. Capture.....	142
8-4.4. Status	143
8-4.5. Replay	144
8-4.6. COPY	146
8-4.7. Switch the Normal Screen to Full Screen.....	148
8-4.8. Speaker / Microphone	149
8-4.9. Connection mode	150

Contents

8-4.9.1. Terminal mode.....	150
8-4.9.2. Multi mode.....	151
8-4.10. Copy in the Terminal mode	152
8-4.11 E-Map	154
8-4.10.1. Addition of map	154
8-4.10.2. Placement of cameras on the map.....	155
8-4.10.3. Usage of camera position	156
8-4.10.4. Deletion of Camera position.....	156
8-4.12 Pan / Tilt & Preset	157
8-5. PLAYER	158
9.INSTALLATION OF ADDITIONAL HDDS	165
9-1. HDD (HARD DISK DRIVE) INSTALLATION	166
9-2. INSTALLATION OF AN ADDITIONAL HDD.....	167
APPENDIX.....	169
RECORDING TIME TABLE	170
FACTORY DEFAULT SETTINGS	171
FAQ.....	175
I CAN NOT LOGIN.....	176
LIMITED 2YEAR WARRANTY	177
HOW TO OBTAIN FACTORY SERVICE.....	178

About this manual

This is the Instruction Manual for Stand-alone type DVR model **CDR1650**.

This Manual describes how to install and operate the Stand-Alone DVR and provides specifications and features.

Please read this manual thoroughly and follow the installation process before using Stand-alone DVR (Note: Be sure to correctly follow step 3. What to do at the time of installation).

Contact our dealers when you have any queries.

1 Unpacking

Care should be taken when unpacking to avoid damaging the unit.

Please check that the following items are included:

- ▶ Stand-alone DVR unit
- ▶ All Accessories : Bracket, Power Cable, Screws
- ▶ Remote Controller & Battery
- ▶ PS2 Mouse
- ▶ DSUB 26p Connector (Sensor Input, Relay Output Selection)
- ▶ Instruction Manual
- ▶ Host Program (DVR Master) on CD
- ▶ RJ-45 Cable

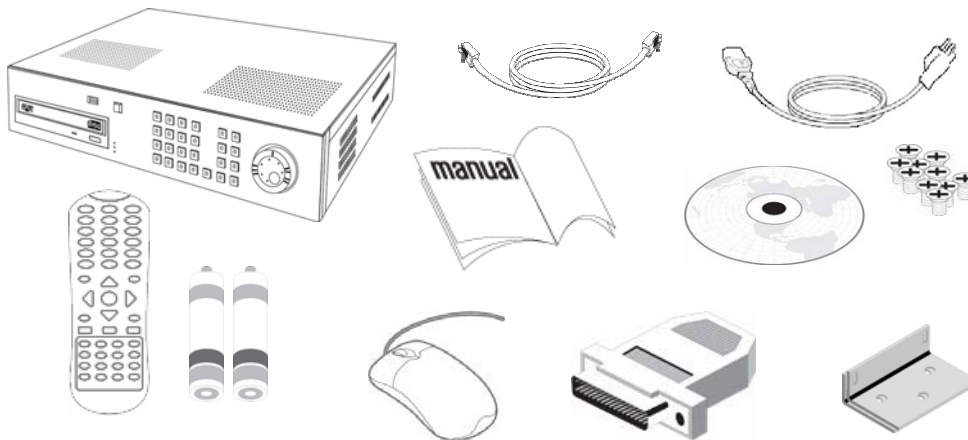

Note: Contact your dealer immediately if any components are missing.

Stand-alone DVR (Digital Video Recorder) Unit

CDR1650 is the most reliable and functional embedded DVR system available today. The system displays 16 channels of live images in Real Time speed, compresses data digitally and records them to the Hard Disk Drive, which can be replayed and searched easily any time.

The **CDR1650** supports easy back up via USB port, DVD R/W, CD R/W and networking in both static & dynamic IP modes.

User can remotely view live images or search the recorded images.

Under emergency situation, the remote operator can control, turn on and turn off the field installed alarms, such as a siren or light.

It is a very user- friendly DVR system. User can control the **CDR1650** by Mouse or Buttons on the front panel or Remote controller.

2

Features

▶ Multi Functional Record

- Powerful, multiple Record Modes available: Manual (Continuous), Timer, and Motion Detection Recording.

▶ User friendly GUI

- A few simple buttons for Easy control.

▶ Automatic System Recovery

- Automatic and Complete System recovery within 10 seconds.

▶ Easy PTZ control via RS port

- No need to use PTZ controller
- PTZ control from remote PC

▶ Networking

- DHCP based automatic network set-up-Easy Network Configuration from Dynamic IP to Dynamic IP
- Up to 10 users can remote access the system through DvrMaster (GUI) or Internet Explorer simultaneously.
- DDNS support

▶ MPEG-4 Algorithm Compression

- The most advanced compression available today.

▶ Multiple Video Display

- Support CCTV monitor or TV and High resolution video display by VGA monitor.

▶ High Resolution

- Real time display 480 Frames/sec.
- Recording speed 480 Frames/sec based on 360x240.
- Programmable display resolution and recording speed on each channel.

▶ 2 Way Audio

- Communicate between the DVR system and client computer through the Internet.

▶ Easy Data Playback in any PC

- Back Up data convertible to AVI file format.

▶ Back UP

- DVD R/W, CD R/W, External HDD, Stick memory, and through network access.

▶ Jog/Shuttle

- Frame by frame playback/playback / Control the playback speed for both forward and reverse by turning the shuttle to left or right.

3 What to do at the time of Installation

Stand-alone DVR should be installed in the following order;

1. Make sure all the required hardware is available.
 - Stand-alone DVR unit (including HDD)
 - Up to 16 cameras (including power source)
 - CCTV or VGA monitor (or TV set)
 - Network cable if connecting to a PC
2. Connect the cameras, the DVR unit and monitor (Refer to [Fig 5-3]).
4. Confirm live video is displayed on the monitor before going to the next step.
5. Select the Setup Menu and set current date and time (Refer to Section 7-2.1 on page 78).
6. Run the FACTORY DEFAULT setting in the SYSTEM menu.
7. Perform HDD formatting.
8. Escape from Setup Menu.
9. Set values for required options.
10. Network cable should be connected to the DVR unit before turning the power on.
Refer to [Fig 5-9] for the cable specification.

4

Specifications

	ITEM	DESCRIPTIONS	
VIDEO SIGNAL	Television System	NTSC	PAL
	Refresh Rate	60 fields/sec	50 fields/sec
	Video Resolution	720x480	720x576
	Video Inputs	16 Cameras	
	Video Input Signal	Composite 1.0 Vp-p 75 Ohms	
	Video Outputs	16 looping, Main monitor, Aux monitor, VGA	
	Video Output Signal	Composite 1.0 Vp-p 75 Ohms	
VIDEO FEATURES	Live	480 Frames/sec display	400 Frames/sec display
	Zoom	2 times digital	
	Sequence	Sequence display in Full screen, 4split or 9split pages	
	Display Format	1 screen(full), Quad pages split, 9 split, 16split	
	Video enhance	Brightness, Contrast control each camera	
AUDIO FEATURES	VGA enhance	Brightness, Contrast, saturation	
	G.723	16ch Input / 1ch Output	
RECORD	Recording Speed	480 Frames/sec	400 Frames/sec
	Recording resolution	720x480,720x240,360x240 (NTSC) / 720x576,720x288,360x288 (PAL)	
	Codec	Mpeg4	
	Recording	Timer, Motion, Alarm, Manual individually set	
	Pre record	0~5 sec	
	Material	3 IDE HDD(Auto overwrite)	
SEARCH	Manual, Timer ,Motion, Alarm, Each Camera, All Camera	Fast x128 , Slow, Forward, Reverse, Frame by Frame	
BACKUP	DVD R/W, CD R/W, HDD, Stick memory, through Network	(DVD R/W Installed) Each Camera, ALL Camera, Time range	
Recorded data lock	Data protect in overwrite HDD	Time range, Back up	
USER INTERFACE	GUI	RGB 24bit full color	
	Operating interface	Mouse, Keypad, IR remote controller, Network	
NETWORK	Ethernet 10/100M Auto	TCP/IP, DHCP, DDNS, MNS server	
PC Program	Remote viewer	Same as DVR monitor (Mouse or Key botton) or Multifit split	
	PC Player	DVD, CD, HDD bay, Stick memory, Internal	
USB	USB 2.0	for external DVD R/W, CD R/W, HDD, Stick memory	
SERIAL	RS232 / RS422 / RS485	16 camera Pan/Tilt, Remote control	
ALARM	Alarm Inputs	16 Inputs	
	Alarm Outputs	4 Relay Output(3A max)	
	Alarm latch up	1 ~ 10 sec	
	Buzzer Out	On/Off	
HDD	IDE(ATA)	3 HDD (1pc of HDD pre-Installed: refer to the retail box)	
POWER	Input Voltage	AC 110V/ 220V(Selectable) 50~60Hz	
	Power consumption	Approx. 80W	
CONNECTORS	Video Inputs	16 BNC	
	Video Outputs	16 BNC(Looping)	
	Main, Aux monitor Output	2 BNC	
	VGA monitor Output	15pin HDSUB	
	Alarm In/Out	26pin HDSUB	
	RS485 /RS422	9pin DSUB	
	Ethernet	RJ45	
	USB	3 USB	
MECHANICAL	Dimension(m/m)	430(W)x375(D)x90(H)	
	Weight	Approx. 22 Lbs	
ENVIRONMENT	Operating Temperature	0 ~ 60° C	
	Humidity	10 ~ 90%	

[Fig 4-1 Specifications]

Design and the specifications are subject to change without notice.

5

Installation

CONTENTS

5-1. CONTROLS AND CONNECTORS (FOR 8CH & 16CH DVR).....	20
5-2. NOTE FOR INSTALLATION.....	22
5-3. SYSTEM CONNECTION	23
5-4. INSTALLATION.....	24
5-4.1. Camera Connection.....	24
5-4.2. Monitor Connection.....	24
5-4.3. Sensor Connection and RELAY IN &OUT.....	26
5-4.4. RS232C,RS485, RS422 Connection.....	28
5-4.5 Connection to an Ethernet (Optional) Network	29
5-4.6. POWER CONNECTION	30

5-1. Controls and Connectors (For 8Ch & 16Ch DVR)

- Front

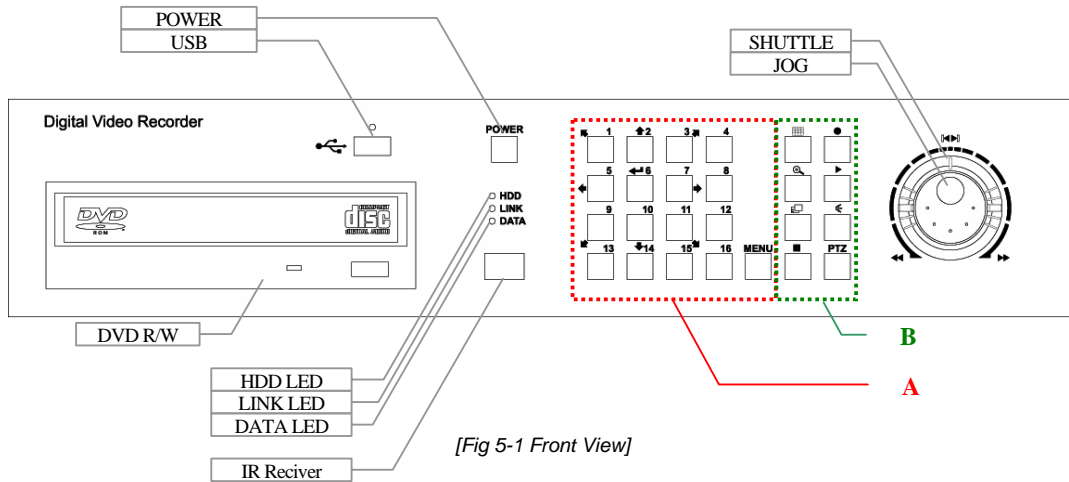

- A

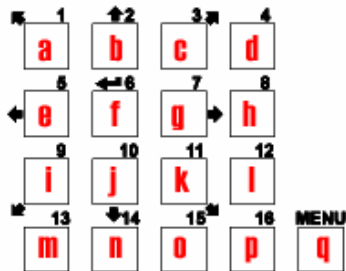

- a. 1 Channel(FULL Screen)
- b. 2 Channel(FULL Screen), UP Key
- c. 3 Channel(FULL Screen)
- d. 4 Channel(FULL Screen)
- e. 5 Channel(FULL Screen), LEFT Key
- f. 6 Channel(FULL Screen), ENTER Key
- g. 7 Channel(FULL Screen), RIGHT Key
- h. 8 Channel(FULL Screen)
- i. 9 Channel(FULL Screen)
- j. 10 Channel(FULL Screen), DOWN Key
- k. 11 Channel(FULL Screen)
- l. 12 Channel(FULL Screen)
- m. 13 Channel(FULL Screen)
- n. 14 Channel(FULL Screen)
- o. 15 Channel(FULL Screen)
- p. 16 Channel(FULL Screen)
- q. MENU

- B

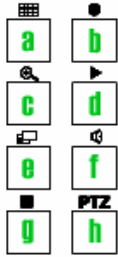

- a. Display (Full / Split)
- b. Emergency Record
- c. Zoom
- d. Quick Replay
- e. OSD On/Off
- f. Audio
- g. Stop (ESC)
- h. PTZ

● Rear

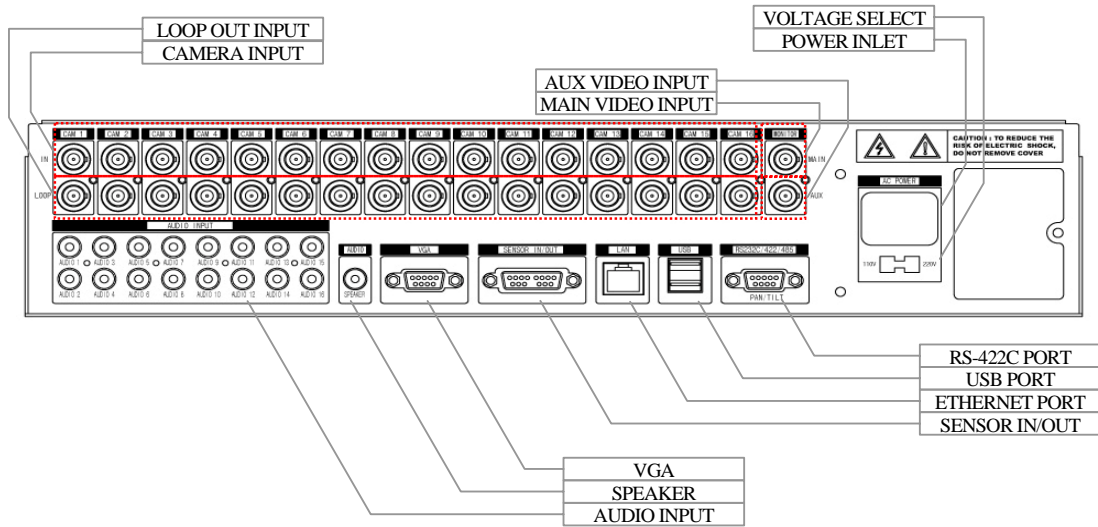

[Fig 5-2 Rear View]

5-2. Note for Installation

- ◆ Install the system according to the instructions described in this manual.
- ◆ This product is designed for indoor use and should not be used outdoors.
- ◆ Avoid any area with high humidity or dust which can shorten lifetime of the unit.
- ◆ Choose a well ventilated area and keep minimum of 10" away from obstructions. Do not place the unit near heat generating devices. Do not place items on top of the unit.
- ◆ Avoid any area with movement as this can interfere with the internal Hard Drive.
- ◆ Use a compatible input/output signal type of cameras and monitor.
- ◆ Contact your dealer if you are having any difficulty.

The Warranty may be voided in case of unauthorized disassembling, abuse or modification.

5-3. System Connection

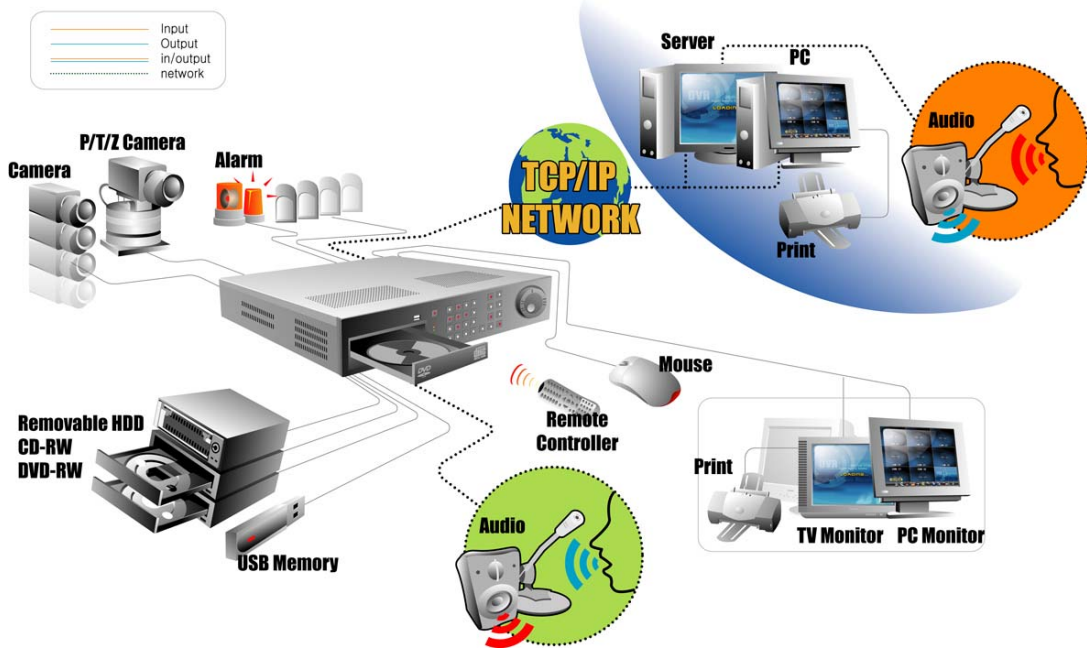

[Fig 5-3 System Connection]

5-4. Installation

5-4.1. Camera Connection

- **Connection of Normal Cameras**

Connect the cameras to the Video Input (BNC connector) on the back of the unit as shown above [Fig. 5-3 System Connection].

- **Connection of Loop Output**

The Camera or video output is available from the Video Output (Loop Output) on the back of the unit. (When BNC jack is connected to the Video Output, the termination resistance (75Ω) is automatically switched to impedance status so the external device must have termination resistance.)

5-4.2. Monitor Connection

- **Connection of Main Monitor**

Connect the composite monitor to "Main" on the upper part of BNC connector

- **Connection of Auxiliary Monitor**

Connect the auxiliary monitor to "Aux" on the lower part of BNC connector. The output of auxiliary monitor port is the same as the main monitor.

▫ **VGA Monitor Connection**

Connect the VGA Monitor's connector to the "DSUB 15 Pin Connector" on the rear of the unit. Output for VGA Monitor is the same as that of the main monitor, however it outputs a better quality signal.

Pin configuration of VGA Connector.

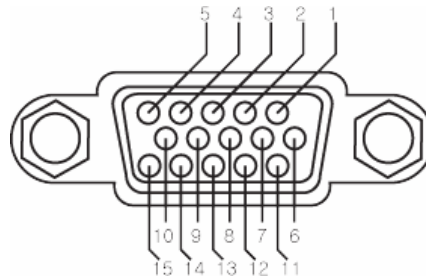

[Fig 5-4 VGA Connector PIN]

Number	Description	Number	Description
1	R(75Ω, 0.7Vp-p)	9	N/C
2	G(75Ω, 0.7Vp-p)	10	GND
3	B(75Ω, 0.7Vp-p)	11	GND
4	N/C	12	N/C
5	GND	13	HSYNC
6	GND	14	VSYNC
7	GND	15	N/C
8	GND		

5-4.3. Sensor Connection and RELAY IN & OUT

▫ SENSOR Connection (SENSOR IN)

Connect up to 16 sensor to ALM (SENSOR) IN. The Sensor should be a contactor type and support N.O. (Normal Open).

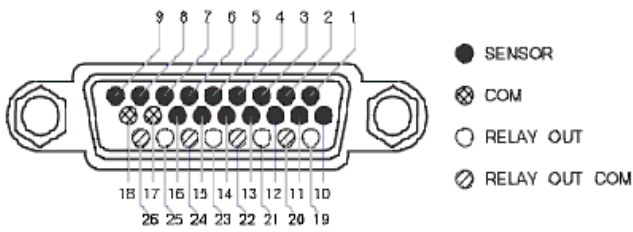

[Fig 5-5 SENSOR IN/OUT PIN]

●	Pin 1	Sensor 1	
●	Pin 2	Sensor 2	
●	Pin 3	Sensor 3	
●	Pin 4	Sensor 4	
●	Pin 5	Sensor 5	
●	Pin 6	Sensor 6	
●	Pin 7	Sensor 7	
●	Pin 8	Sensor 8	
●	Pin 9	Sensor 9	
●	Pin 10	Sensor 10	
●	Pin 11	Sensor 11	
●	Pin 12	Sensor 12	
●	Pin 13	Sensor 13	
●	Pin 14	Sensor 14	
●	Pin 15	Sensor 15	
●	Pin 16	Sensor 16	
⊗	Pin 17	Common	
⊗	Pin 18	Common	
▨	Pin 19	Relay out 1	
○	Pin 20	Relay out 1	Common
▨	Pin 21	Relay out 2	
○	Pin 22	Relay out 2	Common
▨	Pin 23	Relay out 3	
○	Pin 24	Relay out 3	Common
▨	Pin 25	Relay out 4	
○	Pin 26	Relay out 4	Common

▫ **RELAY OUT Connection**

When necessary, use RELAY OUT. The Output of RELAY OUT is a relay contactor type and supports N.O. (Normal Open) & N.C. (Normal Close). The Output capacity is 220V 1A. A higher capacity can cause system failure.

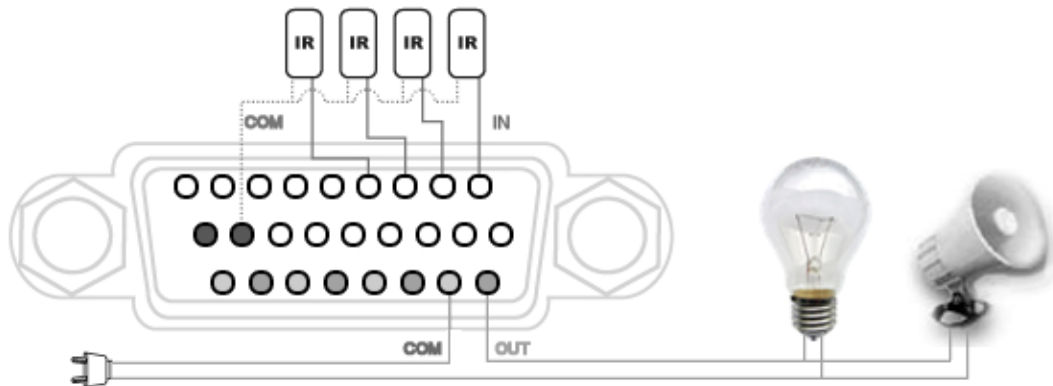

[Fig 5-6 RELAY OUT Connection]

5-4.4. RS232C, RS485, RS422 Connection

- Connect the cable to the "RS232C/RS485/RS422 PORT" on the rear of the unit.
- Specification of the RS232C/RS485/RS422 connector is standard for "DSUB9"
- The Maximum Length of cable is 45 ft with RS232C but RS485 or RS422 is about 300ft.

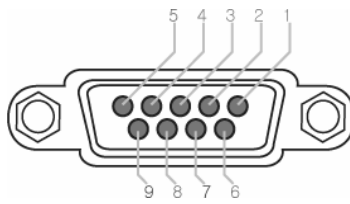

[Fig 5-7]

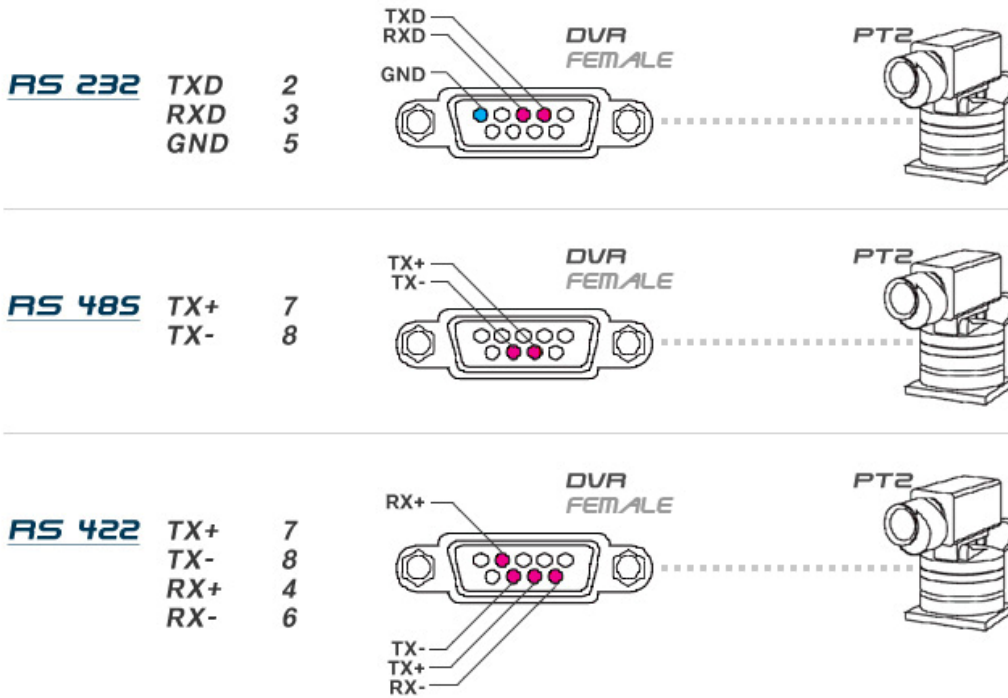

[Fig 5-8]

5-4.5 Connection to an Ethernet Network

▫ Connecting the cable to Ethernet.

Our Ethernet connector is a RJ45 type. The maximum cable length is 300 ft. When you want to use a longer cable, we suggest using repeater.

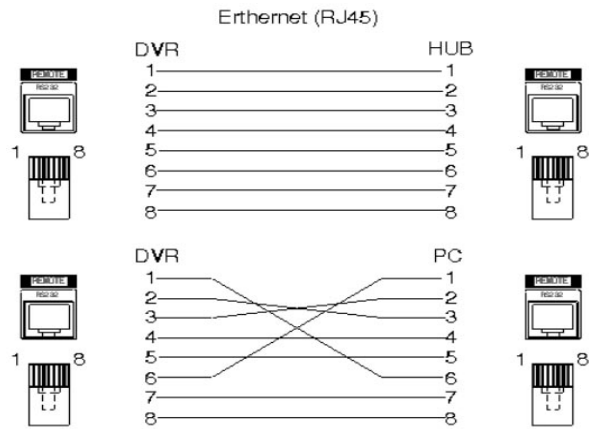

[Fig 5-9]

5-4.6. POWER CONNECTION

Select proper voltage (see fig 5-10) and connect to a reliable power source.

It should not be shared with other electrical equipment on the same line.

Poor performance can occur if the connected voltage is more than 10% plus or minus the required voltage.

Frequent power cuts can cause crucial failures, so if you have an unstable power source we recommend the use of an Uninterrupted Power Supply or other backup power source.

AC Input Voltage is AC110V 50/60Hz or AC220V 50/60Hz. AC power Source vary depends on countries. Factory default setting is AC110V 50/60Hz.

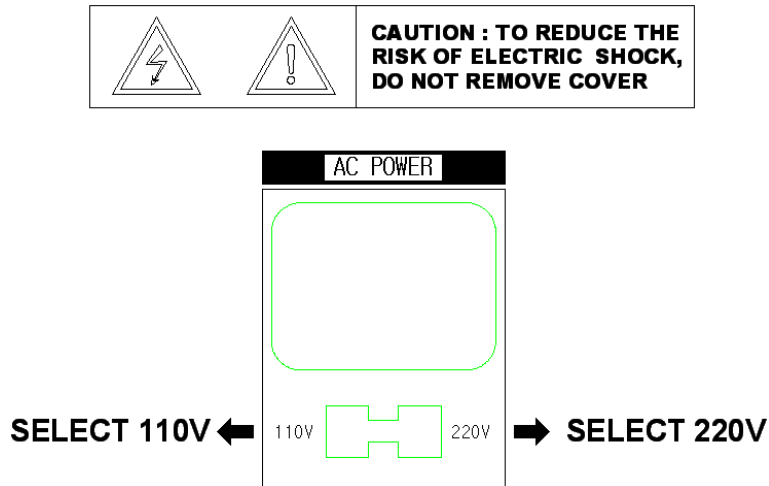

[Fig 5-10 Input power selection]



Note: Before you input the AC power to the system, make sure that the selector switch conforms to the correct input voltage.

6

How to operate

CONTENTS

6-1. GENERAL INFORMATION	33
6-2. OPERATING INTERFACE.....	34
6-3. IR REMOTE CONTROLLER	35
6-4. POWER ON/OFF.....	36
6-4.1. POWER ON	36
6-4.2. POWER OFF	36
6-4.3. APPEARANCE OR DISAPPEARANCE OF POWER BUTTON	37
6-5. MENU BAR ON/OFF	38
6-6. DISPLAY SCREEN	39
6-6.1. FULL SCREEN	39
6-6.2. SPLIT SCREENS.....	40

CONTENTS

6-7. LIVE	41
6-7.1. FULL SCREEN	41
6-7.2. SPLIT SCREEN	41
6-7.3. SEQUENCING SCREENS	42
6-7.4. LIVE AUDIO	43
6-7.5. ZOOM	44
6-7.6. OSD ON / OFF	45
6-7.7. PAN / TILT	46
6-7.8. SYSTEM STATUS	49
6-7.9. POWER LOSS LISTS	50
6-7.10. VIDEO LOSS LIST	52
6-8. RECORD	54
6-8.1. Manual (Continuous) recording	54
6-8.2. Manual Event Recording	54
6-8.3. Timer Recording	55
6-8.4. Timer Event Recording	56
6-8.5. Recording Icons	57
6-9. REPLAY	58
6-9.1. QUICK REPLAY	58
6-9.2. REPLAY	58
6-9.2.1. Playback Devices	59
6-9.2.2. Set the Start Time	59
6-9.2.3. Replaying	61
6-9.2.4. Disappearance of Replay control buttons	63
6-10. COPY	65
6-10.1. Copying devices	65
6-10.2. Set the Copy Start Time (Copying extent)	66
6-10.3. Set the Copy End Time (Copying extent)	68
6-10.4. COPYING THE RECORDED DATA DURING REPLAYING	69

6-1. General Information

- You can operate all functions of the system by use of buttons located on the front panel, remote controller and a mouse. Additionally, you can remotely control this unit via RS422C or the Ethernet port located on the back of the unit.
- System status is indicated by either LED lights on the operator buttons or the monitor.
- The system is protected from any accidental pressing of any operator buttons, but care should be taken when using the functions of HDD Formatting as this can lead to data loss.

6-2. Operating Interface

There are 3 ways to operate the system by pressing the buttons on the front panel or buttons on the remote controller and clicking the mouse. A lot of users mostly prefer to use a mouse on these kinds of products such as DVRs, computers and computer-aided devices. Therefore we would like to describe all the instructions in this manual based on using the mouse.

6-3. IR Remote Controller

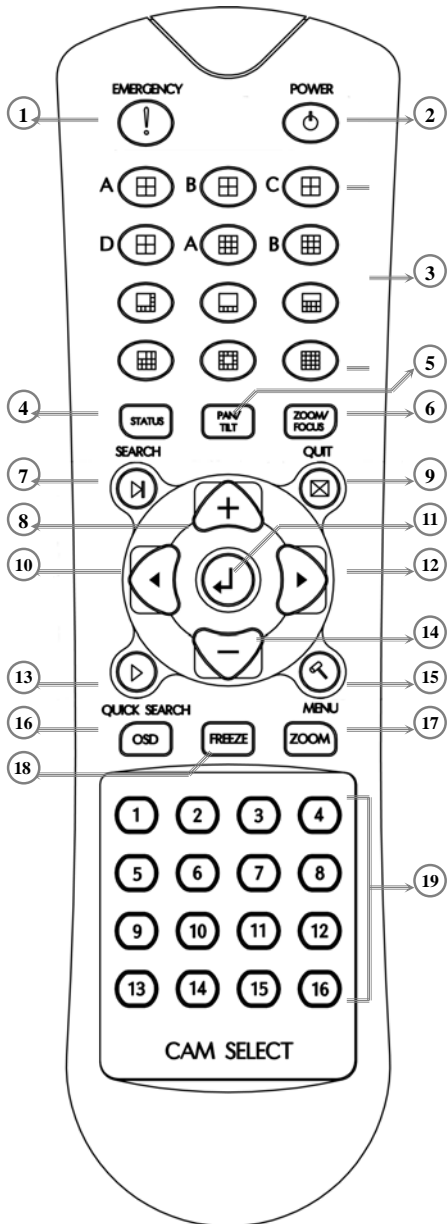

-
- 1. Record
 - 2. Power On/Off
 - 3. Display format (Split)
 - 4. System status
 - 5. Pan / Tilt
 - 6. Zoom / Focus
 - 7. Search for replaying
 - 8. Up
 - 9. Quit
 - 10. Left
 - 11. Enter
 - 12. Right
 - 13. Quick Replay
 - 14. Down
 - 15. Menu (Setup)
 - 16. OSD On/Off
 - 17. Zoom
 - 18. Freeze / IR ID Config
 - 19. No.1~16 Channel (Full Screen)
/ No. 1 ~ 16 IR ID Config
-

[Fig.6-1 IR Remote Controller]

6-4. Power On/Off

6-4.1. POWER ON

On the front panel or the remote controller:

Press the **POWER** button on the front panel for approx. 3 seconds until the LED lights are turned on or just press the **POWER** button on the remote controller.

6-4.2. POWER OFF

On the front panel or the remote controller:

Press the **POWER** button on the front panel for approx. 3 seconds until the LED lights are turned off or just press the **POWER** button on the remote controller and then the following message will be displayed on the screen.



[Fig.6-2 Message of POWER off]

- Press the ENTER (↵) button to turn the power off.

By clicking the mouse:

- Click the **POWER OFF** button on the MENU bar (See Fig.6-3) and then the message (See Fig.6-2) will be displayed on the screen.
- Click the **OK** button to turn the power off.



[Fig.6-3 POWER button on MENU bar]

6-4.3. APPEARANCE OR DISAPPEARANCE OF POWER BUTTON

The Power On/Off button and the Audio buttons (See section 6-7.4) as shown in Fig.6-3-1 will always stay on the MENU bar when the system is not connected through the **DVR Master** (Client Host Program or Internet Explorer). But the Power On/Off button and the Audio buttons on the MENU bar as shown in Fig.6-3-1 will be disappeared on the screen of the DVR and the client's computer when the system is connected through the **DVR Master** and the mouse pointer is on the **DVR Master** (See Fig. 6-3-2).

We designed this function so that users can not turn the power On/Off or control the audio functions on the DVR system through internet.



[Fig.6-3-1 Power & Audio buttons]



[Fig.6-3-2 No Power & Audio buttons]

To appear the buttons (See Fig.6-3-1) on the MENU bar: just move the Mouse-pointer on the screen of the DVR system only, not on the DVR Master.

6-5. Menu Bar On/Off

Right-click on the screen in the LIVE or the RECORD mode and the MENU bar will be appeared. Right-click again and it will be disappeared.



[Fig.6-4 LIVE Screen]

6-6. Display Screen

6-6.1. FULL SCREEN



6-6.2. SPLIT SCREENS

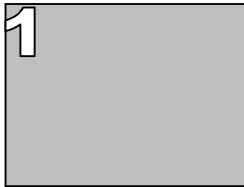

FULL SCREEN

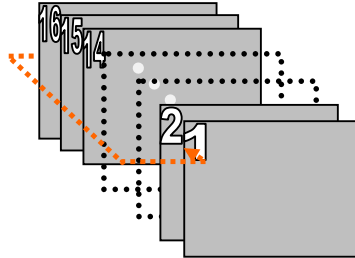

SEQUENCING SCREEN

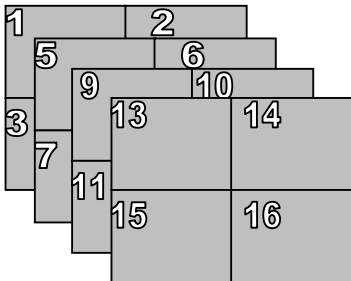

QUAD SCREEN

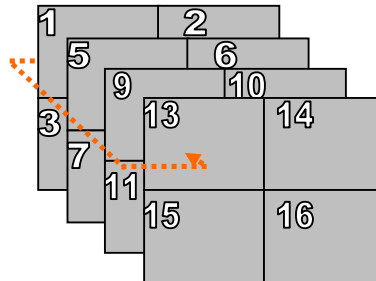

4page SEQUENCING SCREEN

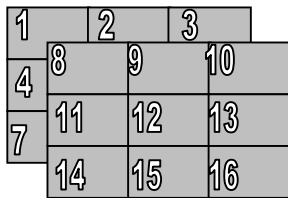

9 SPLIT SCREEN

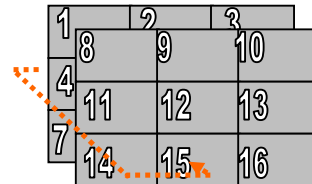

2page SEQUENCING SCREEN

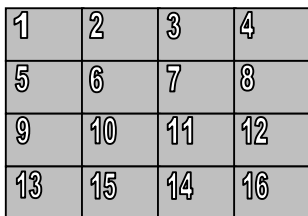

16 SCREEN

6-7. LIVE

6-7.1. FULL SCREEN

- Full SCREEN is available in the LIVE mode or the RECORD mode.
- Click a certain camera's screen in the LIVE mode or in the RECORD mode, then a FULL SCREEN will be displayed.
- Click the FULL screen to return to the SPLIT SCREEN.

6-7.2. SPLIT SCREEN

- SPLIT SCREEN is available in the LIVE mode or the RECORD mode.
- Click the DISPLAY icon on the MENU bar, then the DISPLAY pop-up screen will be displayed (See Fig.6-6).
- Click one of the SPLIT screens on the DISPLAY pop-up screen.



[Fig.6-6 DISPLAY pop-up screen]

6-7.3. SEQUENCING SCREENS

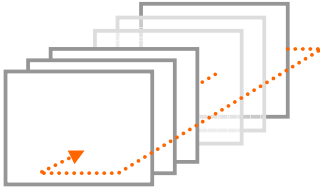



▫ Displaying the cameras in SEQUENCE is available in the LIVE mode or the RECORD mode.

Each of the channels will be displayed in sequence and the dwell time can be adjusted in the camera set up menu (Refer to section 7-4.7).

▫  This ICON is displayed in the upper left hand corner of the screen while the system is in the Sequencing Mode.

▫ Click a Full screen to return to the SPLIT screen while the system is sequencing.

-  : Full screen sequencing
-  : 4 split screen sequencing
-  : 9 split screen sequencing



[Fig. 6-7 LIVE Menu DISPLAY pop-up window]



[Fig. 6-8 SEQUENCING screen]

6-7.4. LIVE AUDIO

- If cameras (up to 16 cameras) have audio function, it will sound in the live mode.
- Click the CHANNEL button you wish to listen on the MENU bar as shown below (See Fig.6-9). The CHANNEL can be changed by clicking the mouse repeatedly.
- Turn the AUDIO (speaker) ON by clicking the SPEAKER icon as shown below (See Fig.6-9). If the ICON turns in red by clicking, it represents that the AUDIO is turned OFF and if it turns in yellow, it represents that the AUDIO is turned ON.
- Adjust the Audio Volume by Clicking the ▲ or the ▼ button when the AUDIO is turned ON.



[Fig. 6-9 Audio buttons]

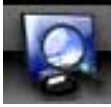

6-7.5. ZOOM

The image on the screen will be zoomed up to 2 times when the ZOOM button is clicked in the LIVE mode (This function is available on the full screen mode only).

- Click the ZOOM button on the MENU bar in the LIVE mode.
- Move the mouse on the ZOOMED screen, and then the 8-directional arrow marks will be appeared as shown below (Fig.6-10).
- Click the  (EXIT) button to return to the LIVE Mode.



[Fig. 6-10 ZOOMED screen]



6-7.6. OSD ON / OFF

OSD ON /OFF is possible in the LIVE mode or RECORD mode.

- Click the **OSD** button on the MENU bar to turn the OSD (On Screen Display) ON or OFF.

When the OSD is in OFF position, all the texts on the screen will be disappeared.



[Fig.6-11 OSD ON SCREEN]

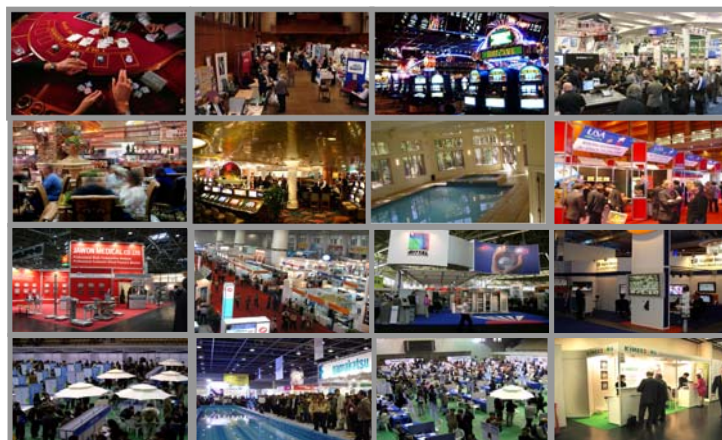

[Fig.6-12 OSD OFF SCREEN]

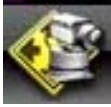

6-7.7. PAN / TILT

- Click the **PAN/TILT** button on the MENU bar in the LIVE mode to access the PAN/TILT cameras.
- Click the  (EXIT) button to return to the LIVE mode.



[Fig.6-13 PAN/TILT button]



[Fig.6-14 PAN/TILT window]

6. How to Operate

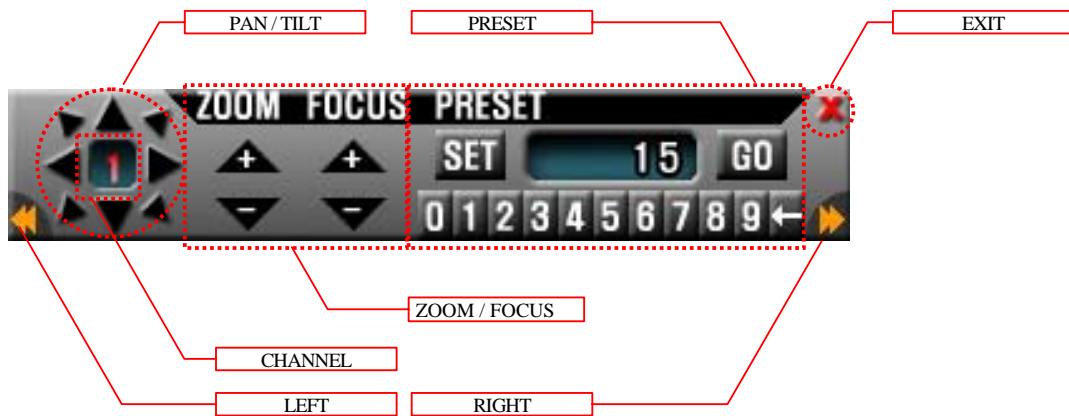

[Fig.6-15 PAN/TILT CONTROL

▫ Channel Selection and Screen Conversion

To change a channel, press the CHANNEL button on the front panel or click the CHANNEL button on the [Fig.6-15 PAN /TILT CONTROL window]. It will be converted a full screen.

To return to the LIVE mode, press the SPLIT button on the front panel or click the  (EXIT) button.

▫ ZOOM / FOCUS

Control the ZOOM and FOCUS of PAN/TILT camera.

Click the ZOOM/FOCUS button on the PAN/TILT CONTROL window [Fig.6-15 PAN / TILT CONTROL window] or press the UP/DOWN/LEFT/RIGHT button on the front Panel.

▫ Button of PAN/TILT Control window

Move the PAN/TILT window as shown in Fig.6-15 by clicking the Left or Right button if necessary.

▫ PAN / TILT

Control the PAN and TILT of PAN/TILT camera.

Click the PAN/TILT Button on the PAN/TILT CONTROL window [Fig.6-15 PAN / TILT CONTROL window] or press the UP/DOWN/LEFT/RIGHT button on the front Panel.

▫ **PRESET**



[Fig.6-15-1 Preset Menu]

It is a function to preset the PTZ camera(s) which you wish to monitor frequently.

Preset Setup

- Select a position of camera you wish to preset and click the SET button in Fig.6-15-1.
- Click the number(s) for the current position of camera.
- Delete the numbers by using ← button.

Preset Execution

Click the number(s) which you preset and click GO button to move the camera.

** If you preset the number again, the previous setup is not available and only current setup is available.*



6-7.8. SYSTEM STATUS

- Click the SYSTEM STATUS button on the MENU bar to see the system status as shown below (Fig.6-16).
- Click the  (EXIT) button to return to the LIVE mode or RECORD mode.



[Fig.6-16 SYSTEM STATUS button]

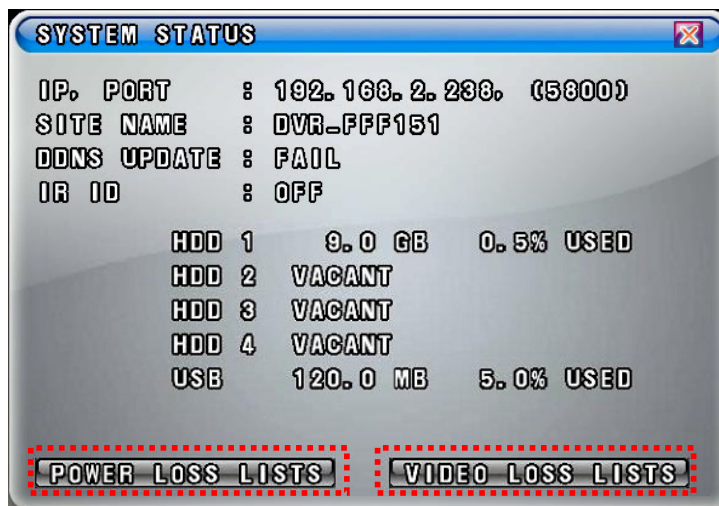

[Fig.6-17 SYSTEM STATUS window]

6-7.9. POWER LOSS LISTS

The list indicates the time/date when the system power was turned OFF.

- Click the POWER LOSS LISTS button on the SYSTEM STATUS window to view the POWER LOSS LISTS.
- Each of the pages contains 10 lists. You can search the pages by clicking the UP/DOWN button.
- Click the  (EXIT) button to return to the LIVE or RECORD mode.



[Fig.6-18 POWER LOSS LISTS window]

▫ CLEAR LISTS button

Click the CLEAR LISTS button to clear the lists, you will be prompted to confirm changes.

When you click the OK button, the POWER LOSS LISTS will be deleted.

To cancel, click the CANCEL button



Fig.6-19 POWER LOSS LISTS Message

6-7.10. VIDEO LOSS LIST

The list indicates the video loss channel and the time/date when the video signal was disconnected.

- Click the VIDEO LOSS LISTS button on the SYSTEM STATUS window to view the VIDEO LOSS LISTS.
- Each of the pages contains 4 lists. You can search the pages by clicking the UP/DOWN button.
- Click the  (EXIT) button to return to the LIVE or RECORD mode.



[Fig.6-20 VIDEO LOSS LISTS window]



[Fig.6-21 VIDEO LOSS window]

▫ CLEAR LISTS button

Click the CLEAR LISTS button to clear the lists, you will be prompted to confirm changes.

When you click the OK button, the VIDEO LOSS LISTS will be deleted.

To cancel, click the CANCEL button



[Fig.6-22 VIDEO LOSS LISTS Message window]







6-8. Record



This system provides Watchdog function.

When power goes off during recording and the power turns on, the system will automatically start recording.







6-8.1. Manual (Continuous) recording

- Click the SETUP icon on the MENU bar in the LIVE mode.
- Click the RECORD button in the SETUP menu and then the RECORD window will be displayed.
- Select the MANUAL RECORDING () between the MANUAL RECORDING () and the TIMER RECORDING () as shown in Fig.6-23. All channels can be set at the same time by clicking the ALL () or each of the channels can be set by clicking the MANUAL RECORDING () on the CAM 1 through CAM 16. The MOTION () and SENSOR () as shown in Fig.6-23 should be turned **OFF** in this recording mode.
- Press the RECORD button on the front panel or click the RECORD icon on the MENU bar.



[Fig.6-23. Manual Recording setup]

6-8.2. Manual Event Recording

- Click the SETUP icon on the MENU bar in the LIVE mode.
- Click the RECORD button in the SETUP menu and then the RECORD window will be displayed.
- Select the MANUAL RECORDING () between the MANUAL RECORDING () and the TIMER RECORDING () as shown in Fig.6-24. All channels can be set at the same time by clicking the ALL () or each of the channels can be set by clicking the MANUAL RECORDING () on the CAM 1 through CAM 16. The MOTION () or SENSOR () as shown in Fig.6-24 should be turned **ON** in









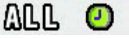

this recording mode.

- Press the RECORD button on the front panel or click the RECORD icon on the MENU bar.



[Fig.6-24 Manual Event Recording setup]











6-8.3. Timer Recording

- Click the SETUP icon on the MENU bar in the LIVE mode.
- Click the RECORD button in the SETUP menu and the RECORD window will be displayed.
- Select the TIMER RECORDING () between the MANUAL RECORDING () and the TIMER RECORDING () as shown in Fig.6-25. All channels can be set at the same time by clicking the ALL () or each of the channels can be set by clicking the TIMER RECORDING () on the CAM 1 through CAM 16. The MOTION () and SENSOR () as shown in Fig.6-25 should be turned **OFF** in this recording mode.
- Choose one among WEEKDAY, SATURDAY and SUNDAY in the TIMER menu by clicking the mouse on () that turns to (). You can choose the value  or  by repeatedly clicking the mouse.
- Select the Starting Time and Ending Time by clicking the mouse, change the values with the mouse's wheel and click the mouse again on the changed values to complete as shown in Fig.6-27. The recording time can be set in military hour mode (24hour).
- Press the RECORD button on the front panel or click the RECORD icon on the MENU bar.



[Fig.6-25 Timer Recording setup]

6-8.4. Timer Event Recording

- Click the SETUP icon on the MENU bar in the LIVE mode.
- Click the RECORD button in the SETUP menu and the RECORD window will be displayed.
- Select the TIMER RECORDING () between the MANUAL RECORDING () and the TIMER RECORDING () as shown in Fig.6-26. All channels can be set at the same time by clicking the ALL () or each of the channels can be set by clicking the TIMER RECORDING () on the CAM 1 through CAM 16. The MOTION () or SENSOR () as shown in Fig.6-26 should be turned **ON** in this recording mode.
- Choose one among WEEKDAY, SATURDAY and SUNDAY in the TIMER menu by clicking the mouse on () that turns to (). You can choose the value () or () by repeatedly clicking the mouse.
- Select the Starting Time and Ending Time by clicking the mouse, change the values with the mouse's wheel and click the mouse again on the changed values to complete as shown in Fig.6-27. The recording time can be set in military hour mode (24hour).
- Press the RECORD button on the front panel or click the RECORD icon on the MENU bar.



[Fig.6-26 Timer Event Recording setup]



[Fig.6-27 Example for Timer Recording]

6-8.5. Recording Icons

The Recording Icons depends on recording modes are displayed in the upper left hand corner of the screen.

- To turn the Recording Icon OFF, click the DISPLAY ON in the RECORD menu and then it will be turned OFF. You can select the value **ON** or **OFF** by repeatedly clicking the mouse.

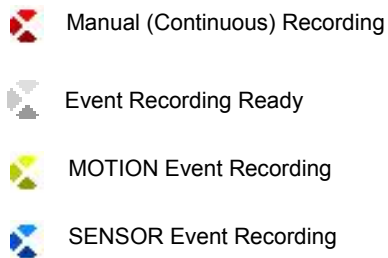

[Fig.6-28 Recording Icons]

6-9. REPLAY

6-9.1. QUICK REPLAY

It is available only by pressing the PLAY button on the front panel or the QUICK SEARCH button on the remote controller.

- Press the PLAY button, then the recent recorded list will be played.

6-9.2. REPLAY



- Click the REPLAY icon on the MENU bar, then the REPLAY window as shown in Fig.6-29 will be displayed.
- Click the  (EXIT) button to return to the previous mode.

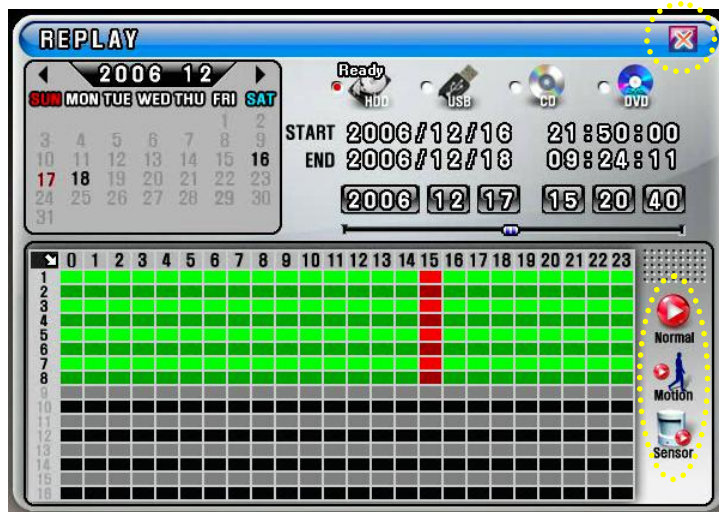

[Fig.6-29 REPLAY window]

6-9.2.1. Playback Devices

In order to playback, plug the USB devices such as external USB HDD, USB memory to the USB port or insert a recorded media (CD-R/W or DVD-R/W) into the DVD-R/W drive.

When the devices are ready to playback, the **Ready** on the corresponding devices will be displayed as shown in Fig.6-30.

- Click the mouse on a device among HDD, USB, CD-R/W and DVD-R/W that is displaying the **Ready** (See Fig.6-30). The corresponding LED will be lit in red when the device is selected.

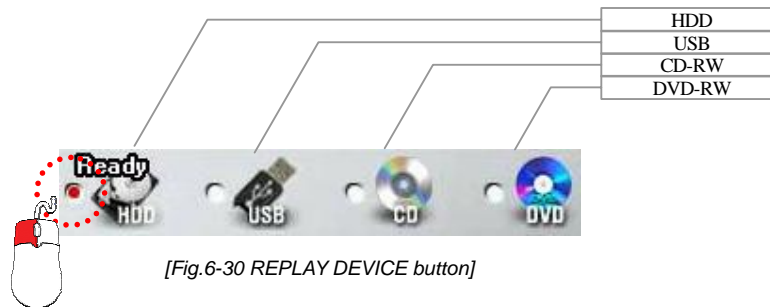

6-9.2.2. Set the Start Time

- Select the Date (year / month / day) on the calendar by clicking the mouse on the highlighted character in black that turns to highlighted character in red (See Fig.6-31). The highlighted character in black indicates the dates and times that contains recorded data, and the highlighted character in red indicates the selected dates and times.
- Select the month (year) by clicking the mouse on the ◀button or ▶ button.

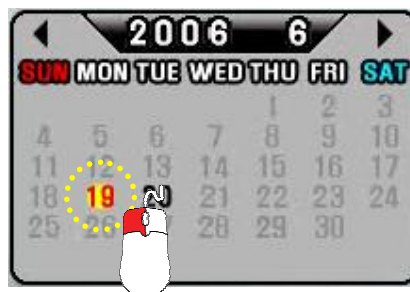

- Select the hour on the Start Time Select Window (See Fig.6-32) by clicking the mouse on the Hour (0 – 23 hour) you wish to start to play.

The green active buttons indicate the HOUR that contains recorded data, and the red active buttons indicate the selected Start HOUR.

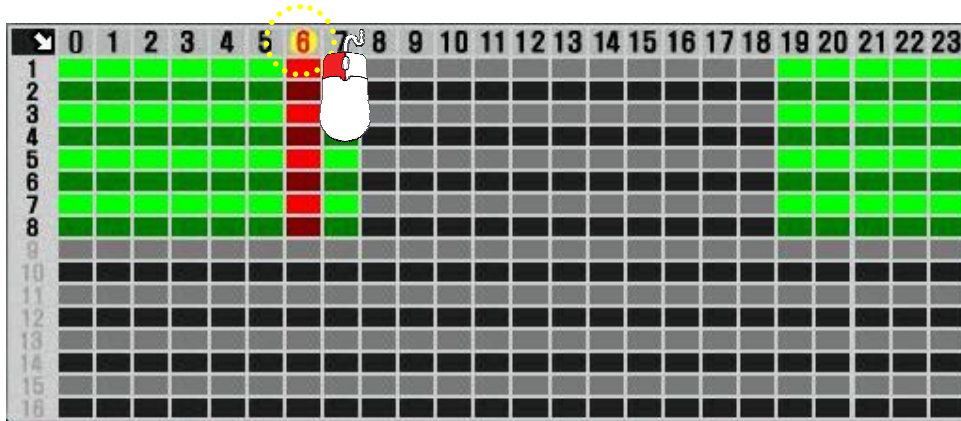

[Fig.6-32 Start Time Select window]

By using the Replay Time set-up buttons:

The time and date can also set on the Replay Time set-up button window (See Fig.6-33).

- Select the values (year/month/date and hour/minute/second) by clicking the mouse, change the values with the mouse's wheel and click the mouse again on the changed values to complete as shown in Fig.6-33.



[Fig.6-33 Replay time set-up button]

By using the Replay Time set-up bar:

The starting time to play can also be set by clicking the slider on the bar and dragging it or clicking the bar.



[Fig.6-34 Replay time set-up bar]

6-9.2.3. Replaying

Replaying start time set-up can be possible within a recording time extent.

- Replay buttons (NORMAL / MOTION / SENSOR)



NORMAL PLAY: Click the button to play all the recorded data.



MOTION PLAY: Click the button to play the recorded data by MOTION only.



SENSOR PLAY: Click the button to play the recorded data by SENSOR only.

- How to control the buttons while replaying





[Fig.6-35 Replay screen]

① Search Slider



It is possible to playback by clicking the slider on the bar and dragging it.



② PLAY / PAUSE

Click the  button to pause.



Click the  button to replay when in the pause mode.

③ REW/FF

During replaying, press the  or  button, or turn the shuttle ring on the front panel for fast rewinding and fast forwarding up to 128 times.

Keep pressing  or  button to accelerate the speed up to 128 times.
(Same as shuttle ring)

④ PREV / NEXT

During replaying, press the  button to view previous frame in still image and press the  button to view the next frame in still image.

⑤ Speaker ON / OFF

Turn speaker ON or OFF.

⑥ Speaker Volume

Adjust the Audio Volume by clicking the ▲ or the ▼ button when the AUDIO is turned ON.

6-9.2.4. Disappearance of Replay control buttons

During replaying, the replay control buttons appear on the bottom of the screen. To disappear, drag the mouse pointer downward until the replay control buttons disappear and to appear, drag the mouse pointer upward until the replay control buttons appear.

- Click the mouse on one out of channels during replaying to view a full screen.
- Click the mouse on the full screen during replaying to return to the split screen.

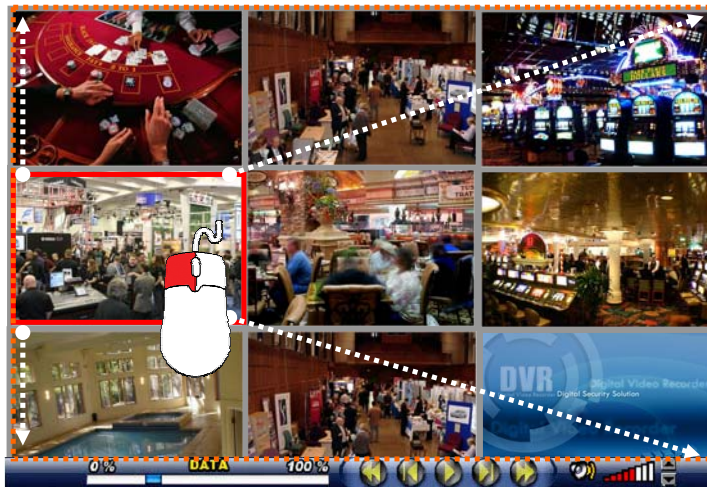

[Fig.6-36 SPLIT screen during replaying]

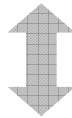

[Fig.6-37 FULL screen during replaying]

6-10. COPY



- Click the COPY icon on the MENU bar, and then the COPY window as shown in Fig.6-38 will be displayed.
- Click the  (EXIT) button to return to the previous mode.

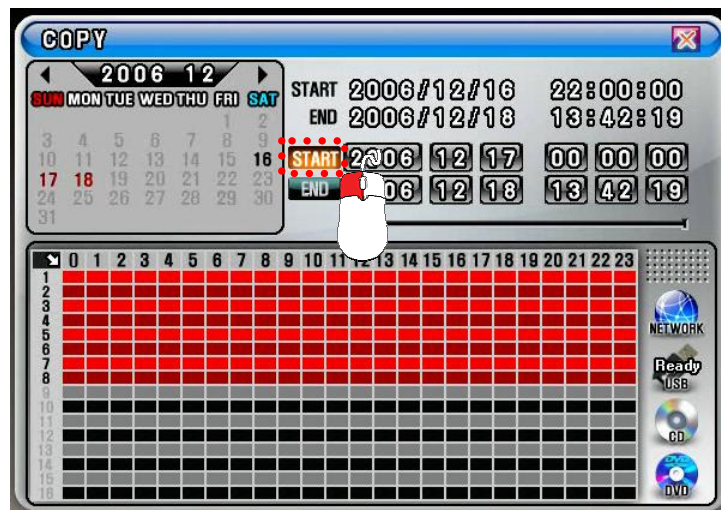

[Fig.6-38 COPY window]

6-10.1. Copying devices

In order to copy the recorded data, plug the USB devices such as external USB HDD, USB memory to the USB port or insert a blank media (CD-R/W or DVD-R/W) into the DVD-R/W drive.

When the devices and Medias are ready to copy, the **Ready** on the corresponding devices and Medias will be displayed as shown in Fig.6-38.

We recommend you to format the USB devices prior to copy the recorded data as follows, but the Medias such as CD-R/W and DVD-R/W don't need to format.

- Connect the USB devices to the DVR
- Click the SETUP icon on the MENU bar, and the SETUP menu will be displayed.
- Click the DISK MANAGER in the SETUP menu, and the DISK MENAGER will be displayed.
- Click the mouse on the USB button in the DISK MANAGER, and you will be asked.
- Click the OK, and then the progressive bar will be shown along with FORMATTING USB....

In regards to blank Medias (CD-R/W and DVD-R/W)

Most Medias can be used with the system, but some of them may be not compatible with. Refer to the included instructions related to Medias or visit the website of DVD/CD DRIVE unit manufacturer for more information.

6-10.2. Set the Copy Start Time (Copying extent)

- Select the Date (year / month / day) on the calendar by clicking the mouse on the highlighted character in red that turns to highlighted character in black (See Fig.6-39). The highlighted character in black indicates the dates and times that contains recorded data, and the highlighted character in red indicates the selected dates and times.
- Select the month (year) by clicking the mouse on the ◀button or ▶ button.
- Select the hour on the Copy Start Time and Channel Selection Window (See Fig.6-40) by clicking the mouse on the Hour (0 – 23 hour) you wish to start to copy. The green active buttons indicate the HOUR that contains recorded data, and the red active buttons indicate the selected Start HOUR.

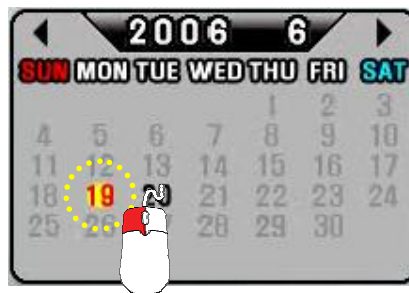

[Fig.6-39 Calendar for Copying]

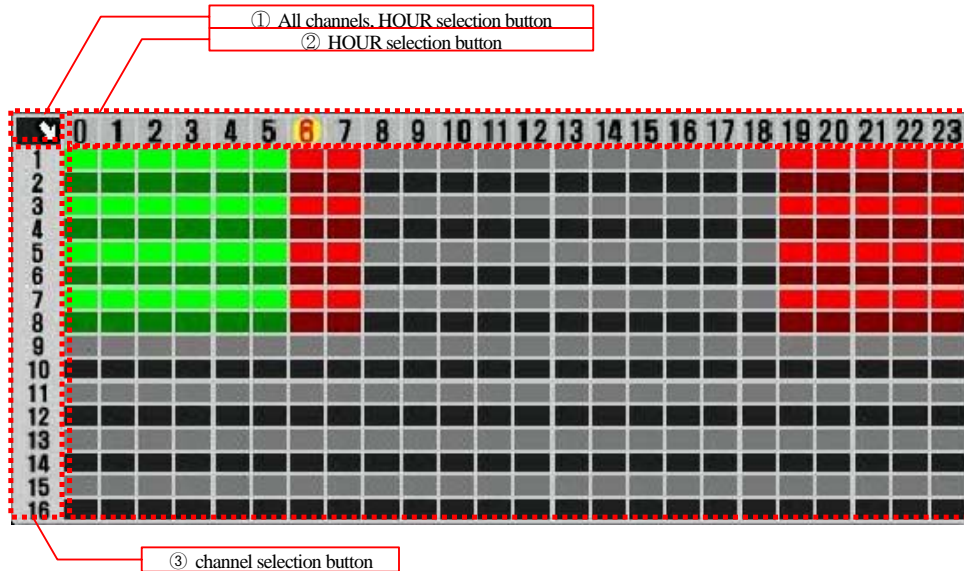

[Fig.6-40 Copy Start time and Channel Selection window]

- ① All channels, HOUR selection button.

Click the arrow button on the upper left corner as shown in Fig.6-40 to set the full extent of the recording and all the channels simultaneously.

- ② HOUR selection button

Select the start time to copy by clicking the mouse on HOUR (0-23: in the military hour). Thereafter the extent of the recording will be saved on.

- ③ Channel selection button

Some channels can be selected by clicking the mouse on the corresponding channels.

By using the Copy Start/End set-up buttons:

The time and date can also set on the Copy Start/End set-up buttons window (See Fig.6-41).

- Select the values (year/month/date and hour/minute/second) by clicking the mouse, change the values with the mouse's wheel and click the mouse again on the changed values to complete as shown in Fig.6-41.



[Fig.6-41 Copy Start/End setup buttons]

By using the Start/End set-up bar:

The starting time to copy can also be set by clicking the slider on the bar and dragging it or just click the bar.



[Fig.6-42 Copy Start/End setup bar]

6-10.3. Set the Copy End Time (Copying extent)

Refer to the above explanation (See section 6.10.2.).

6-10.4. Copying the recorded data during replaying

The system, CDR1650 allows users to copy the recorded data during replaying.

- Start replaying (See section 6-9).
- Right-click on the replaying screen, and the COPY DATA screen will be displayed (See Fig.6-43).
- **To set the starting time and date to copy**, select the values (year/month/date window and hour/minute/second) on the COPY DATA window by clicking the mouse, change the values with the mouse's wheel and click the mouse again on the changed values to complete.
- Select each of channels (1 through 16 in red) or "A" in black for all the channels on the COPY DATA window, and click on the SELECTED button to save.

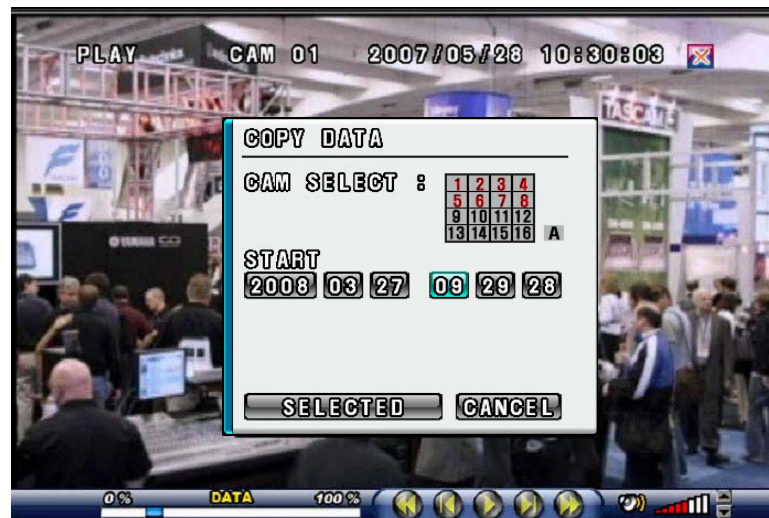

[Fig.6-43 Start Copy Time Setup window]

- **To set the ending time and date to copy**, right-click on the replaying screen again, and the COPY DATA window that contains end time for copying will be displayed (See Fig.6-44). Set the ending time and date to copy as described above.
- To select the COPY MODE, click on the GO TO COPY button (See Fig.6-44), and the COPY window (See Fig.6-38) will be displayed. The time and date (starting time and ending time) to copy can be changed on the COPY window as well (See section 6-10.2).



[Fig.6-44 End Copy Time Setup window]

- Choose one among NETWORK, USB, CD and DVD which are ready to copy (See section 6-10.1).

Select COPY Mode

Only when the devices and Medias are ready to copy, the **Ready** on the corresponding devices and Medias will be displayed.



NETWORK COPY

Save the recorded data in **PC** through the **DVR Master** by Network.

Click the **Network** button on the **DVR Master** to start copy. It is available only on the **DVR Master** (not on the DVR) and the networking should be connected to the DVR.



USB COPY

Save the recorded data in **USB Device**.

Click the **USB Device** button to start copy.



CD-RW COPY

Save the recorded data on **CD-R/W** Medias.

Click the **CD-R/W** button to start copy.



DVD-RW COPY

Save the recorded data on **DVD-R/W** Medias.

Click the **DVD-R/W** button to start copy.

- As soon as one of the above buttons is clicked , copying will start along with displaying the icon shown in Fig.6-45.

The following icon indicates that copying is in process.



[Fig.6-45 Copying Icon]

7

SETUP

CONTENTS

7-1. SETUP	76
7-2. SYSTEM	77
7-2.1. TIME / DATE	78
7-2.2. SYSTEM CONFIG	80
7-2.2.1. FACTORY DEFAULT	80
7-2.2.2. LOAD CONFIG / BACKUP CONFIG	81
7-2.3. PASSWORD	83
7-2.4. IR REMOTE ID	84
7-2.5. FIRMWARE UPDATE	85
7-2.6. SYSTEM INFO	85
7-3. DISK MANAGER	86
7-3.1. HDD WRITE FAIL	87
7-3.2. HDD OVERWRITE	87
7-3.3. Format	87

CONTENTS

7-4. CAMERA	89
7-4.1. Camera ON/OFF	90
7-4.2. Camera Name (Camera Title)	90
7-4.3. Buzzer	91
7-4.4. Relay	91
7-4.5. Pan/Tilt Settings	92
7-4.6 Display	96
7-4.7 Sequencing dwell time	96
7-5. AUDIO	97
7-5.1. Audio Recording ON/OFF	97
7-5.2. Microphone Volume	97
7-6. RECORD	98
7-6.1. Record ICON Display	98
7-6.2. All Manual / Timer recording button	99
7-6.3. All Motion ON / OFF, Sensitivity and Velocity Setting	100
7-6.4. All Sensors ON / OFF	101
7-6.5. Size (Recording Resolution)	101
7-6.6. Recording Speed	102
7-6.7. Recording Quality	103
7-6.8. Recording Mode	104
7-6.8.1. Manual Recording	104
7-6.8.2. Manual Event Recording	104
7-6.8.3. Timer Recording (Schedule Recording)	104
7-6.8.4. Timer Event Recording	104
7-6.9. Recording by Motion Detection	105
7-6.10. Recording by Sensor (PIR Sensor)	113

CONTENTS

7-7. NETWORK	116
7-7.1. IP Mode.....	116
7-7.2. GATEWAY, SUBNET, IP ADDRESS.....	117
7-7.3. Port.....	118
7-7.3.1 Port Forwarding	118
7-7.4. MAC ID.....	119
7-7.5. MNS (MAC NAME SERVER).....	119
7-7.6. DDNS (DYNAMIC DOMAIN NAME SYSTEM).....	121
7-7.7. HOW TO SETUP AND USE THE DDNS.....	123
7-7.7.1. Router.	123
7-7.7.2. Registration to the DDNS server	123
7-7.8. EMAIL NOTIFICATION.....	124
7-8. VIDEO ENHANCE	127
7-8.1. VIDEO ENHANCEMENT ON EACH CAMERA	128
7-8.2. VIDEO ENHANCEMENT ON VGA OUTPUT	129

7-1. SETUP



[Fig.7-1 Setup Icon on MAIN MENU]



It is possible to set up the menus in the LIVE mode and partly in the RECORD mode.

- Click the “SETUP” button on the MENU bar and then the SETUP menu will be displayed.

- Click the  “EXIT” button to return to the previous mode.

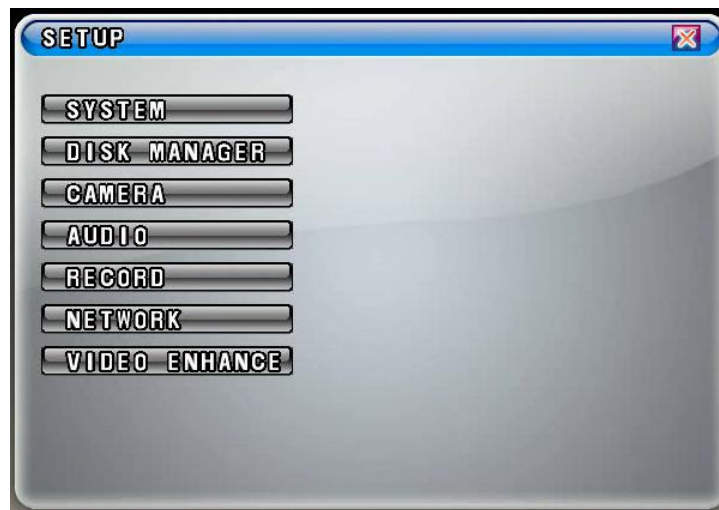

[Fig.7-2 SETUP menu]

7-2. SYSTEM

- Click the “SYSTEM” button in the SETUP menu, and then the SYSTEM menu shown in Fig.7-3 will be displayed.
- Click the  “EXIT” button to return to the SETUP menu.

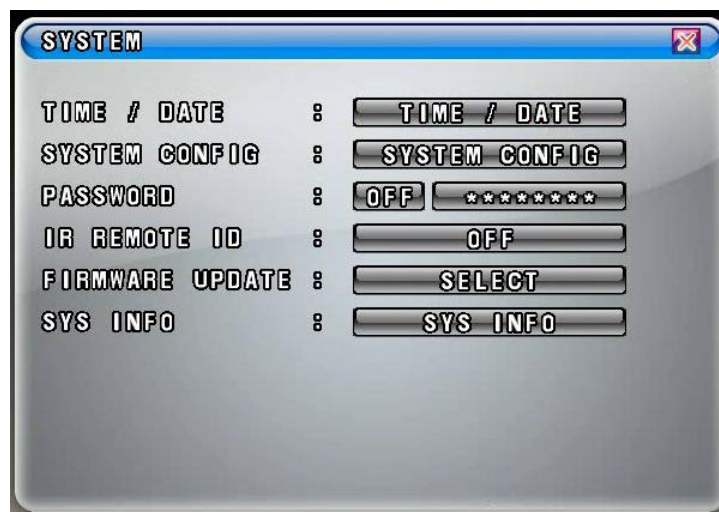

[Fig.7-3 SYSTEM menu]

7-2.1. TIME / DATE

- Click the “TIME/DATE” button in the SYSTEM menu, and then the TIME/DATE menu will be displayed (See Fig.7-4).
- Click the  “EXIT” button to return to the SYSTEM menu.



[Fig.7-4 TIME / DATE menu]

- TIME FORMAT
Click the mouse on the TIME FORMAT button to change and then select 24 HOUR or 12 HOUR by clicking the mouse.

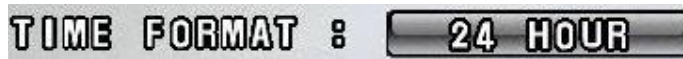

[Fig.7-5 Time Format button]

- TIME Settings
Select the values (AM or PM and hour/minute/second) by clicking the mouse, change the values with the mouse's wheel and click the mouse again on the changed values to complete.

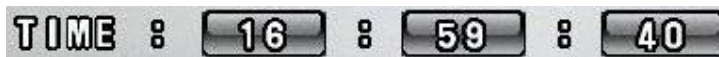

[Fig.7-6 Time Setting]

▫ DATE FORMAT

There are three formats to display the time and date as follow.

- MM / DD / YYYY: For U.S.A.
- YYYY / MM / DD: For Asian countries.
- DD / MM / YYYY: For European countries.

Click the mouse on the DATE FORMAT button to change, and then select a DATE FORMAT among YYYY/MM/DD, DD/MM/YYYY and MM/DD/YYYY.



DATE FORMAT : YYYY/MM/DD

[Fig. 7-7 Date Format button]

▫ DATE Settings

Select the month, date and year by clicking the mouse, change the values with the mouse's wheel and click the mouse again on the changed values to complete.



DATE : 2006 / 12 / 01 FRI

[Fig.7-8 Date Settings button]

▫ DISPLAY

It enables you to display the time and date on the Live screen.

Click the DISPLAY button to set display on or off.



DISPLAY : ON

[Fig. 7-9 Display button]



Note: Setting the new time will cause loss of recording data. After setting the time, HDD should be formatted prior to start recording.

7-2.2. SYSTEM CONFIG

- Click the “SYSTEM CONFIG” button in the SYSTEM menu, and then the SYSTEM CONFIG menu will be displayed (See Fig.7-10).
- Click the  “EXIT” button to return to the SYSTEM menu.

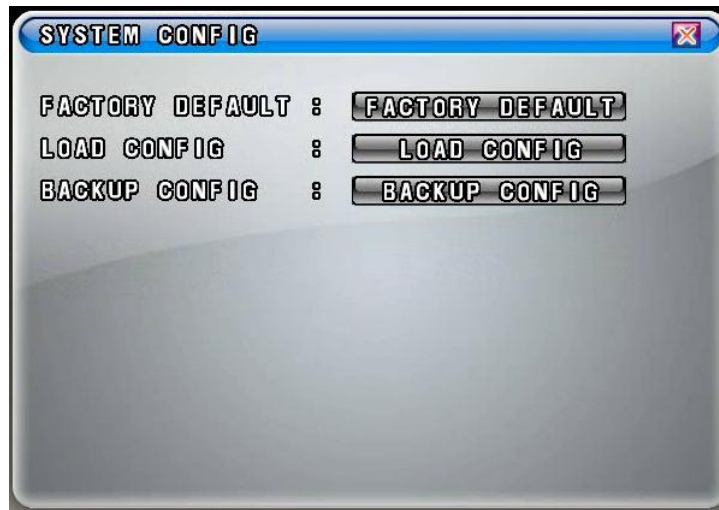

[Fig.7-10 SYSTEM CONFIG]

7-2.2.1. FACTORY DEFAULT

- Click the “FACTORY DEFAULT” button in the SYSTEM CONFIG menu, and you will be asked as shown in Fig.7-12.



[Fig.7-11 Factory Default button]

- Click the “OK” button in Fig.7-12 to reset to the Factory Default Values, and then the system will save the factory default values (settings).
Click the CANCEL button to cancel.

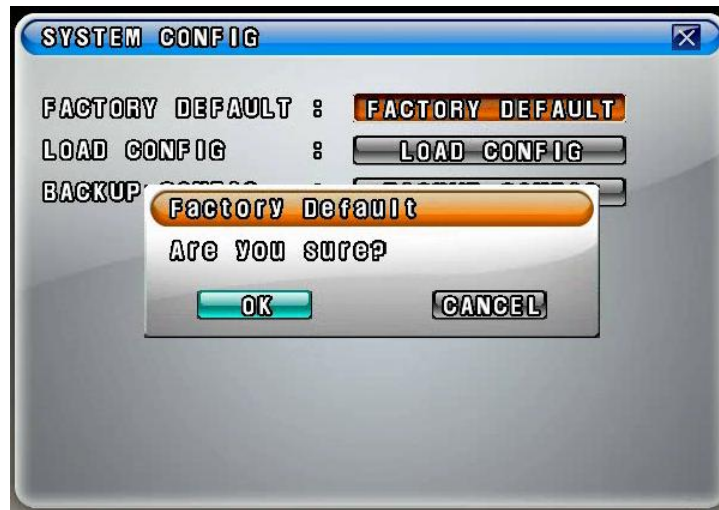

[Fig.7-12 Confirmation window of Factory Default]

7-2.2.2. LOAD CONFIG / BACKUP CONFIG

You can save up to four different settings in the BACKUP CONFIG and load the files in the LOAD CONFIG to change the settings to the system.

▫ LOAD CONFIG

This function is to load the changed settings to the system.

- Click the LOAD CONFIG button and then the LOAD CONFIG window will be displayed (See Fig.7-14).
- Select a backup file among FILE 1, FILE 2, FILE 3 and FILE 4 by clicking the mouse and click the LOAD button to change the settings (See Fig.7-14).
- Click the CANCEL button to cancel.



[Fig.7-13 LOAD CONFIG button]



[Fig.7-14 LOAD CONFIG window]

▫ BACKUP CONFIG

This function is to save the current settings to load the settings to the system. Save the current settings in the BACKUP CONFIG in order to load it to the system in the near future whenever you need to change the settings.

- Click the BACKUP CONFIG button and then the BACKUP CONFIG window will be displayed (See Fig.7-16).
- Select a blank file among FILE 1, FILE 2, FILE 3 and FILE 4 by clicking the mouse and click the BACKUP button to save the current setting (See Fig.7-16).
- To delete, click the mouse on the saved file and click the DELETE button.
- Click the CANCEL button to cancel.



[Fig.7-15 BACKUP CONFIG button]



[Fig.7-16 BACKUP CONFIG window]

7-2.3. PASSWORD

- ON/OFF

Select ON or OFF by clicking the mouse.

If the ON is selected, the password has to be entered to get into the SETUP mode, RECORD mode, COPY mode, REPLAY mode, and when trying to connect the network through the **DVR Master**.

- PASSWORD CHANGE

Click the password “*****” button and then the On Screen Keyboard will be displayed as shown in Fig.7-17. The factory default password is “11111111”.

Delete the existing password with the  button on the On Screen Keyboard. Enter the new password by using the On Screen Keyboard and click the OK button to save.

The password should be 8 digits.

If you executed the factory default setting, the existing password will be changed to “11111111”.



[Fig.7-17 PASSWORD KEYBOARD window]



Note: Don't forget the password.

7-2.4. IR REMOTE ID

Up to 16 DVR systems can be controlled by only one remote controller we provided, but IDs should be assigned on each of the systems. You don't have to assign any ID on the single unit and you can control the system with the provided remote controller without IR REMOTE ID, which is in the OFF mode (Skip this section).

- Click the IR REMOTE ID button and select one among OFF, 1 through 16 to assign an ID on the system by clicking the mouse.

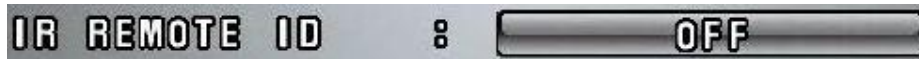

[Fig.7-18 IR REMOTE ID button]

- When an IR Remote ID is assigned In the SYSTEM menu, press the "FREEZE" button and the same channel button on the remote controller as an assigned ID in the SYSTEM menu to match the IDs between the system and the remote controller. And then press the "FREEZE" button one more time for setting an ID.

When the FREEZE button and the channel button are pressed on the remote controller,

- if the channel button is identical to the assigned ID, the DETECT IR ID as shown in Fig.7-19 will be displayed along with the IR ID number.
- if not, the IR ID DENIED as shown in Fig.7-20 will be displayed along with the denied IR ID number.



Fig.7-19 DETECT IR ID Message

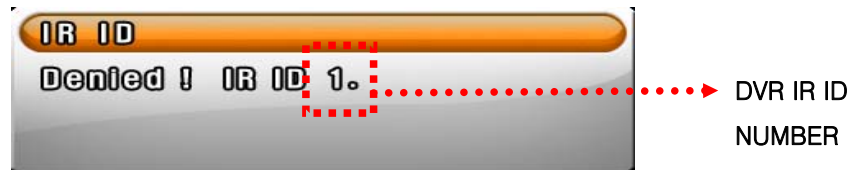

Fig.7-20 IR ID DENIED Message

7-2.5. FIRMWARE UPDATE

There are two ways to update the firmware through **USB memory** and the **DVR Master (GUI)**. We recommend users to update the firmware only in the LIVE mode.

▫ **By USB memory**

- Format the USB with your computer and save the firmware file on it (not including folder).
- Plug it on the USB port on the DVR.
- Click the mouse on the SELECT button in the SYSTEM menu and the FIRMWARE LIST will be displayed.
- Click on the list, and then you will be asked, OK or CANCEL.
- Click the OK button to update the firmware and the system will automatically start rebooting.
- Click the CANCEL button to cancel.

▫ **By DVR Master (GUI)**

Refer to section 8-4.1 ④ Firmware Update on page 140.

7-2.6. SYSTEM INFO

- Click the "SYSTEM INFO" button in the SYSTEM menu and then the SYSTEM INFO that contains the system version and the last updated date will be displayed.
- Click the  (EXIT) button to return to the SETUP menu.

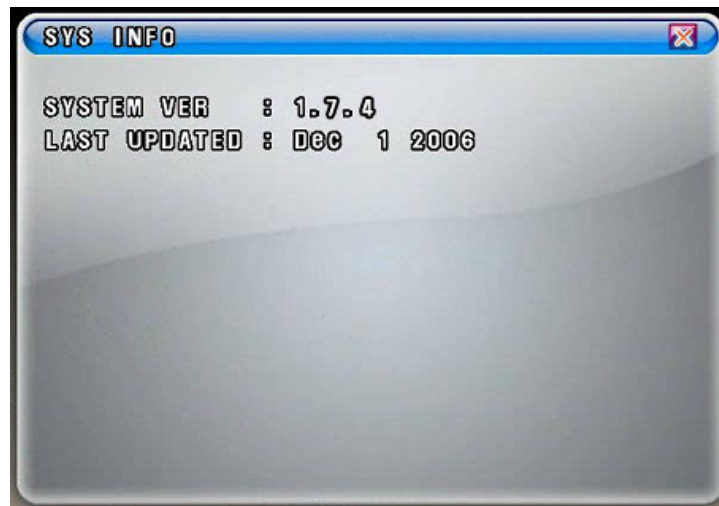

[Fig.7-21 SYSTEM INFORMATION window]

7-3. DISK MANAGER

- Click the “DISK MANAGER” button in the SETUP menu and then the DISK MANAGER window will be displayed (See Fig.7-22).
- Click the  (EXIT) button to return to the SETUP menu.
- A DVD R/W and 3 Hard Disk Drives can be installed, and all information in regards to the drives will automatically display on the DISK MANAGER window.

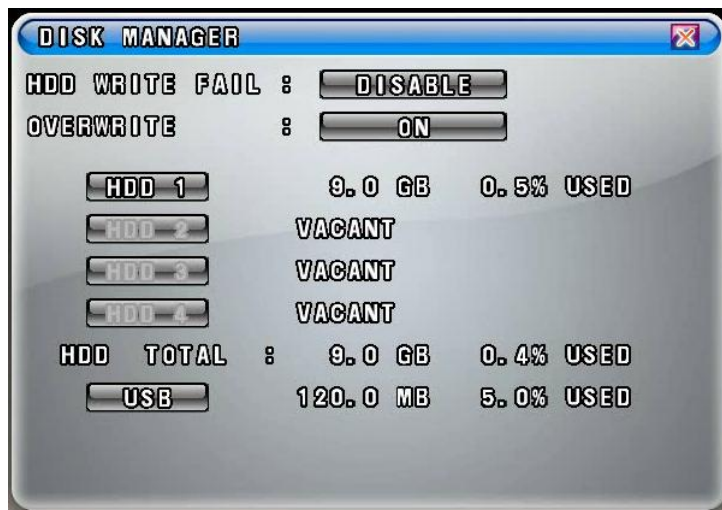

[Fig. 7-22 DISK MANAGER window]

7-3.1. HDD WRITE FAIL

If HDD is in full and the OVERWRITE on the HDD is turned OFF in the recording mode, the system will activate the relay output (See section 5-4.3) for a siren or other device.

- Click the HDD WRITE FAIL button in the DISK MANAGER window and select one among RELAY 1 OUT, RELAY 2 OUT, RELAY 3 OUT, RELAY 4 OUT or DISABLE.



[Fig. 7-23 HDD Write Fail button]

7-3.2. HDD OVERWRITE

- Click the mouse on the OVERWRITE button to select the ON or the OFF. If the ON is selected, the system continues recording by overwriting start from the first index of the recorded file even though the space of HDD is in full. If the OFF is selected, the system will stop recording when the space of HDD is in full.



[Fig. 7-24 Overwrite button]

7-3.3. Format

When you install the new Hard Disk Drives (HDD), it should be formatted before recording. Formatting is possible only when the system is in the LIVE mode.

- Click the "HDD or USB" button to format and then the HDD or USB FORMAT message box will be displayed (See Fig. 7-25).
- Click the "OK" button, and you can see the formatting process of the HDD.
- Click the "CANCEL" button to return to the Disk Manager.

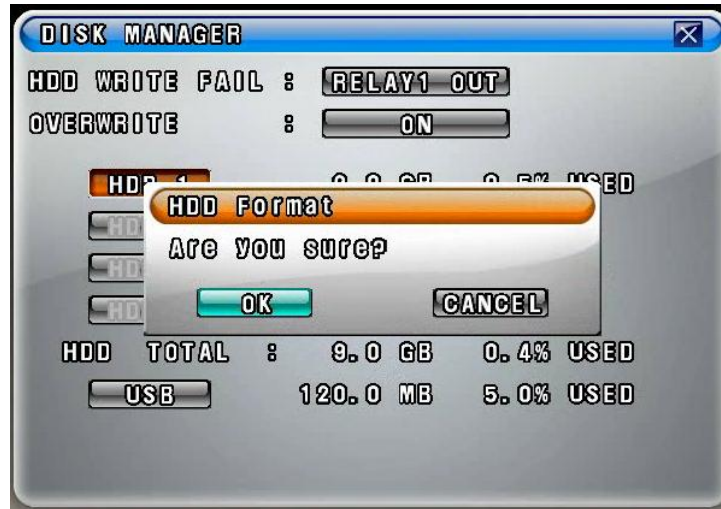

[Fig.7-25 HDD FORMAT window]

7-4. CAMERA

- Click the “CAMERA” button in the SETUP menu and then the CAMERA menu will be displayed (See Fig.7-26). To change the settings in the CAMERA menu, stop recording by clicking the RECORD icon on the MENU BAR. It is possible only in the LIVE mode.
- Click the UP/DOWN button on the right hand side of the menu to switch the page.
- Click the  (EXIT) button to return to the SETUP menu.



[Fig.7-26 CAMERA menu]



7-4.1. Camera ON/OFF

- Click on each of the channels to select the “O” or “X” in the CAMERA menu. If the “O” is selected, the corresponding video channels (CAM 01 through CAM 016) will be displayed on the screen. If the “X” is selected, the corresponding video channels (CAM 01 through CAM 016) won't be displayed.



[Fig.7-27 Camera ON/OFF button]

7-4.2. Camera Name (Camera Title)

- Click the NAME (Camera Title) button in the CAMERA menu and then the On Screen Keyboard will be displayed as shown in Fig.7-28.
- Delete the existing NAME (Camera Title) with the  button on the On Screen Keyboard.
- Enter the new NAME up to 8 characters by using the On Screen Keyboard and click on the OK button to save. Click on the CANCEL button to cancel.
- Click the  (EXIT) button to return to the SETUP menu.

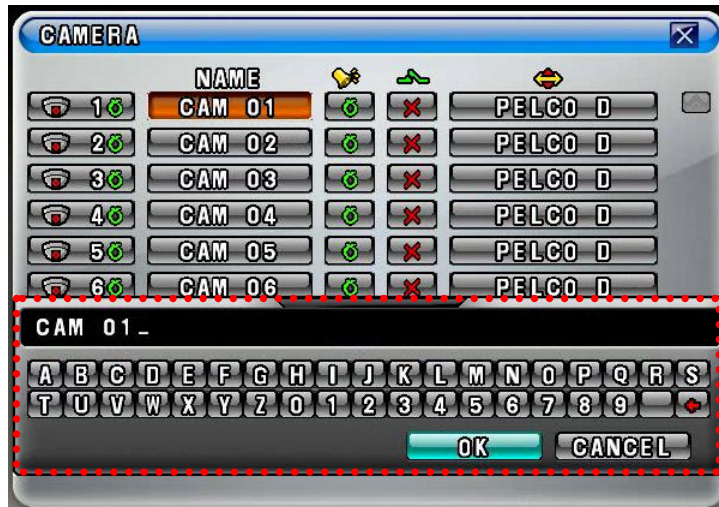

[Fig.7-28 Camera Name Setting Keyboard window]

7-4.3. Buzzer

In order to alert users, the Buzzer will sound at that time video signal lost.

- Click on each of the channels you wish to turn the buzzer “ON” or “OFF”. If the “O” is selected, the buzzer will sound when video signal lost and if the “X” is selected, the buzzer won’t sound.

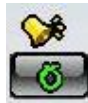

[Fig.7-29 Buzzer button]

7-4.4. Relay

The system will automatically activate sirens or other devices through the Relay Outputs on the rear panel when video signal lost.

- Click on each of the channels you wish to select the Relay Outputs among “OFF”, “1”, “2”, “3” and “4”.



[Fig.7-30 Relay button]



[Fig.7-31 Relay pop-up window]

7-4.5. Pan/Tilt Settings

- Click the PAN/TILT button on the corresponding channels in the CAMERA menu, then the PAN/TILT window will be displayed as shown in Fig.7-33.
- Click the  (EXIT) button to return to the CAMERA menu.



[Fig.7-32 PAN/TILT button]



[Fig.7-33 PAN/TILT window]

- PTZ ID
 - Click the PTZ ID button in the PAN/TILT window, then On Screen Keyboard will show up.
 - Delete the current ID with the  button and choose a number among “0” to “255” by using the On Screen Keyboard, and then click **OK** button to save it. The ID should be identical to one PTZ camera has.
 - Click the “**CANCEL**” button to return to the previous value.



Fig. 7-33-1 PTZ ID

▫ Pan/Tilt Vendor select

Click the “PAN/TILT & REMOTE” button in the PAN/TILT window, then the vendor lists will show up. Select a vendor on the vendor lists by clicking the mouse.



Fig.7-34 PAN/TILT & REMOTE



[Fig.7-35 PAN/TILT Vendor lists]

▫ Model

Click the “MODEL” button in the PAN/TILT window and select the model on the pop-up lists by clicking the mouse.



[Fig.7-36 MODEL button]



[Fig.7-37 PAN/TILT Model pop-up window]

▫ Baud rate

Click the “BAUD RATE” button in the PAN/TILT window and choose a value among 1200bps, 2400bps, 4800bps, 9600bps, 19200bps, 38400bps, 57600bps and 115200bps on the Baud Rate pop-up window by clicking the mouse.



[Fig.7-38 BAUDRATE button]

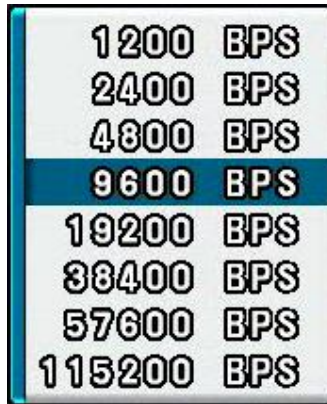

[Fig.7-39 Baud Rate pop-up window]

▫ Data Bits

Click the “DATA BITS” button in the PAN/TILT window and choose a value among 5, 6, 7 and 8 on the Data Bits pop-up window by clicking the mouse.



[Fig.7-40 DATA BITS button]



[Fig.7-41 Data Bits pop-up window]

▫ Stop Bits

Click the “STOP BITS” button in the PAN/TILT window and select 1 or 2 on the Stop Bits pop-up window by clicking the mouse.



[Fig.7-42 STOP BITS button]



[Fig.7-43 Stop Bits pop-up window]

▫ Parity Bit

Click the “PARITY BITS” button in the PAN/TILT window and choose a value among NONE, ODD, EVEN, STICK and ZERO on the Parity Bits pop-up window by clicking the mouse.



[Fig.7-44 PARITY BIT button]



[Fig.7-45 Parity Bit pop-up window]

7-4.6 Display

- Click the DISPLAY button in the CAMERA menu and select the ON or OFF. If the “ON” is selected, the camera name (camera title) in the LIVE mode will be displayed on the screen. If the “OFF” is selected, the camera name (camera title) in the LIVE mode won't be displayed.



[Fig.7-46 Display ON/OFF button]

7-4.7 Sequencing dwell time

- Click the “SEQUENCING DWELL” button in the CAMERA menu and choose a value among 1, 2, 3, 4 and 5seconds on the dwell time pop-up window by clicking the mouse.



[Fig.7-47 Sequencing Dwell Time button]



[Fig.7-48 Sequencing Dwell Time pop-up window]

7-5. AUDIO

- Click on the AUDIO button in the SETUP menu and then the AUDIO menu will be displayed on the screen.
- Click the UP/DOWN button on the right hand side of the menu to switch the page.
- Click the  (EXIT) button to return to the SETUP menu.

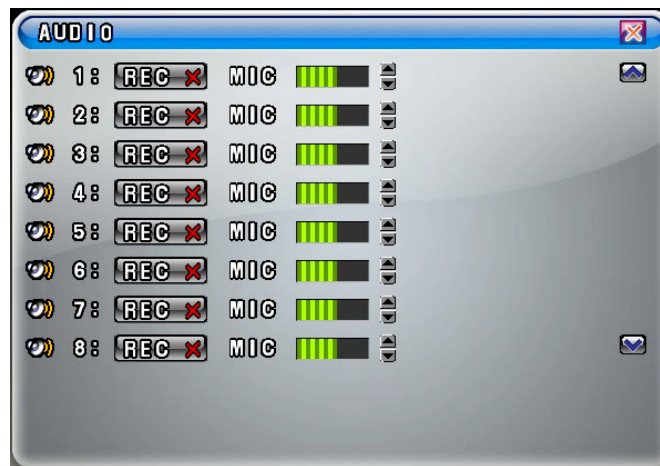

[Fig.7-49 AUDIO menu]

7-5.1. Audio Recording ON/OFF

- Click the REC (audio recording) button in the AUDIO menu and select the “O” or “X” by clicking the mouse. If the “O” is selected, the corresponding channel’s audio will record along with video signal. If the “X” is selected, the corresponding channel’s audio won’t record but video signal will record continuously.



[Fig.7-50 Record ON/OFF button]

7-5.2. Microphone Volume

- Adjust audio volume by clicking the ▲ or ▼ button.



[Fig.7-51 Microphone Volume control button]

7-6. RECORD

- Click the “RECORD” button in the SETUP menu and then the RECORD menu will be displayed as shown in Fig.7-52.
- Click the UP/DOWN button on the right hand side of the menu to switch the page.
- Click the  (EXIT) button to return to the SETUP menu.



[Fig.7-52 RECORD menu]

7-6.1. Record ICON Display

- The Recording Icons depends on recording modes are displayed in the upper left corner of the screen.
- To turn the Recording Icon OFF, click the DISPLAY ON in the RECORD menu and then it will be turned OFF. You can select the value **ON** or **OFF** by repeatedly clicking the mouse.



[Fig.7-53 Record ICON Display button]

7-6.2. All Manual / Timer recording button

- Click the **All Manual / Timer** recording button in the RECORD menu, then the **All Manual / Timer** recording button will be displayed as shown in Fig.7-55.
- Select the Manual Recording button or Timer Recording button for all the channels by clicking the mouse in Fig.7-55.
- See section 6-8.1 through 6-8.5 on page 54 through 57 for more information related to recording.







[Fig.7-54 All Manual / Timer button]



[Fig. 7-55 All Manual / Timer pop-up window]

7-6.3. All Motion ON / OFF, Sensitivity and Velocity Setting

- Click the  button in the RECORD menu, then the ALL MOTION setup pop-up window will be displayed as shown in Fig.7-57.
- By clicking the mouse, select the **ALL  ENABLE** on the pop-up window (See Fig.7-57) to enable the system to start recording by motion detection for all the channels.
- By clicking the mouse, select the **ALL  DISABLE** on the pop-up window (See Fig.7-57) to disable the system to start recording by motion detection for all the channels.
- By clicking the mouse, select the ** SENSITIVITY HIGH** on the pop-up window (See Fig.7-57) and choose one of the sensitivity among **LOW, 1, 2, 3** and **HIGH** for all the channels with the mouse's wheel, and then click it to save.
- See section 6-8.1 through 6-8.5 on page **54 through 57** for more information related to recording.



[Fig.7-56 All Motion Setup button]





[Fig.7-57 All Motion Setup pop-up window]



[Fig.7-58 All Motion Sensitivity setup button]

7-6.4. All Sensors ON / OFF

- Click the  button in the RECORD menu, then the ALL SENSOR setup pop-up window will be displayed as shown in Fig.7-60.
- By clicking the mouse, select the **ALL**  **ENABLE** on the pop-up window (See Fig.7-60) to enable the system to start recording by Sensor (Passive Infrared Sensor) for all the channels.
- By clicking the mouse, select the **ALL**  **DISABLE** on the pop-up window (See Fig.7-60) to disable the system to start recording by Sensor (Passive Infrared Sensor) for all the channels.



[Fig.7-59 All Sensor Setup button]



[Fig.7-60 All Sensor Setup pop-up window]

7-6.5. Size (Recording Resolution)

Select the size of the screen for recording. The larger the size selected, the better display quality is but the larger the data becomes.

- Click the SIZE (Recording Resolution) button on each of the channels in the RECORD menu, then the SIZE (Recording Resolution) pop-up window will be displayed as shown in Fig.7-62.
- Select one of the Resolution among **D1** (720x480), **HALF D1** (720x240) and **CIF** (360x240) on the pop-up window by clicking the mouse.



[Fig.7-61 Record Size button]



[Fig.7-62 Record Size pop-up window]

7-6.6. Recording Speed

- Click the F/S (Frames Per Seconds: Recording Speed) button on each of the channels in the RECORD menu, then the Recording Speed pop-up window will be displayed as shown in Fig.7-64.
- Select one of the Recording Speed among AUTO, 30, 15, 10, 7, 5, 3, 2, 1 and OFF on the pop-up window by clicking the mouse.
- If the AUTO is selected on all the channels, the Recording Speed on all the channels should be the same. If the OFF is selected, the corresponding channel won't be recording.



[Fig.7-63 Record Speed button]

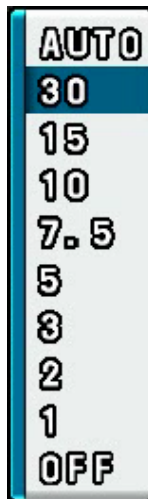

[Fig.7-64 Record Speed pop-up window]

NTSC	30	PAL	25
	15		12
	10		8
	7.5		6
	5		5
	3		3
	2		2
	1		1
	OFF		OFF

[Fig.7-65 Recording Speed for each channel]

7-6.7. Recording Quality

- Click the QUALITY button on each of the channels in the RECORD menu, then the QUALITY pop-up window will be displayed as shown in Fig.7-67.
- Select one of the Recording Quality among LOW, NORMAL, HIGH and BEST on the pop-up window by clicking the mouse.



[Fig.7-66 Record Quality button]



[Fig.7-67 Record Quality pop-up window]

7-6.8. Recording Mode

The factory default setting for Recording is the Manual Recording (or called Continuous Recording), which keeps recording continuously if the OVERWRITE is set ON in the DISK MANAGE menu. This Manual Recording mode is not only one of the most popular Recording modes for users, but also one of the most convenient Recording modes to use.

Users can select one of the following Recording modes depends on their application.

7-6.8.1. Manual Recording

See section 6-8.1 on page 54.

7-6.8.2. Manual Event Recording

See section 6-8.2 on page 54.

7-6.8.3. Timer Recording (Schedule Recording)



See section 6-8.3 on page 55.

7-6.8.4. Timer Event Recording

See section 6-8.4 on page 56.

7-6.9. Recording by Motion Detection

When the menu of motion is properly set up (See section 7-6.3 for all the channels and this section for each of the channels) and detected motion of objects, the system begins recording automatically. The recording icon on the MENU bar should be selected in this recording mode. If not, it won't be recording.

- Click the mouse on the  button for each of the channels in the RECORD menu and then the MOTION menu will be displayed on the screen as shown in Fig.7-68.
- Click the  (EXIT) button to return to the RECORD menu.

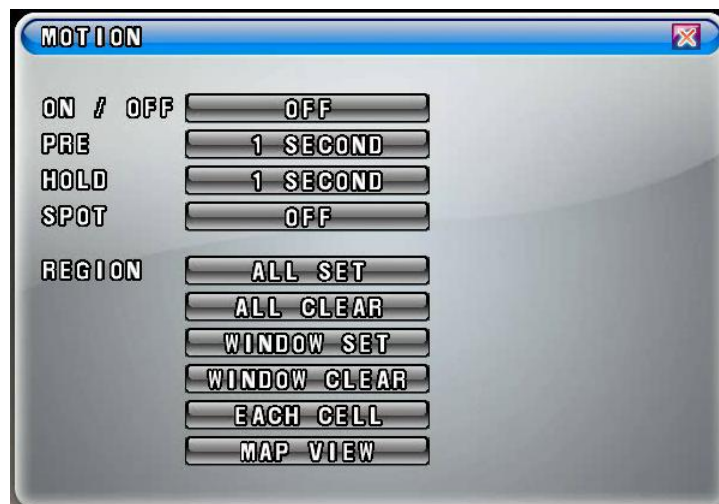

[Fig.7-68 MOTION menu]

- ON/OFF
The system will start to record when MOTION is detected and the ON is selected in the MOTION menu by clicking the mouse. If the OFF is selected, the system won't be recording.



[Fig.7-69 MOTION ON/OFF button]

▫ Pre-Alarm Time Setup

Allows you to record a section of video just prior to Motion or Sensor activation. Click the mouse on the PRE in the MOTION menu and choose one of the values among 0, 1, 2, 3, 4 and 5 seconds with the mouse's wheel, and then click it to save.



[Fig.7-70 Pre-Record Time setup button]



[Fig.7-71 Pre-Alarm Time Setup pop-up window]

▫ Motion Hold Time Setup

The system continues recording for the MOTION HOLD TIME and finishes the recording. Click the mouse on the HOLD in the MOTION menu and choose one of the values among 1 through 30 seconds with the mouse's wheel, and then click it to save.



Fig. 7-72 Hold-Record Time Setup button]

▫ Spot Setup

If the “ON” is selected by clicking the mouse on the SPOT button in the MOTION menu, a full screen will display when a motion is detected. If the “OFF” is selected, the full screen won’t be displayed even though motion of objects is detected.



[Fig.7-73 Spot Setup button]

▫ Region

The Motion Detection Area displays in blue on the screen, and it turns to yellow color when the motion is detected. The white color on the screen represents none of detection area. There are three kinds of REGION settings as follows.

By All Set

Click the ALL SET button in the MOTION menu on each of the cameras and then the Motion Detection Area displays in blue on the screen as shown in Fig.7-75. Right-click on the blue screen to return to the MOTION menu. The factory default value is the ALL SET.



[Fig.7-74 ALL SET button]

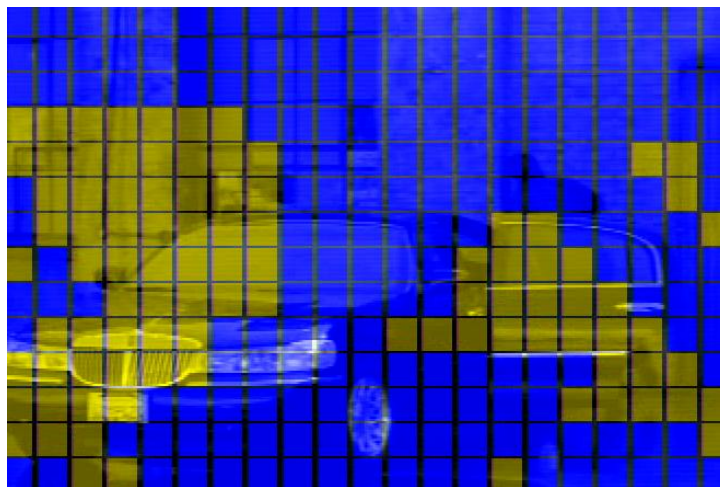

[Fig.7-75 All Set screen]

- All Clear

Click the ALL CLEAR button in the MOTION menu in order to clear the Motion Detection Area, and then the window turns to white color as shown in Fig.7-77. Right-click on the current window to return to the MOTION menu.



[Fig.7-76 ALL CLEAR button]



[Fig.7-77 All Cleared screen]

By Window Set

Click the WINDOW SET button in the MOTION menu on each of the cameras and click one of cells (330 cells in total) for the starting point of the area which you would like to designate, and then click the other one of cells for the ending point of area until the motion detection area is the size you want it to be. The multiple motion areas can be set on each of cameras.

The motion detection by Window Set will be made on the designated area only.

Right-click on the current window to return to the MOTION menu.



[Fig.7-78 WINDOW SET button]

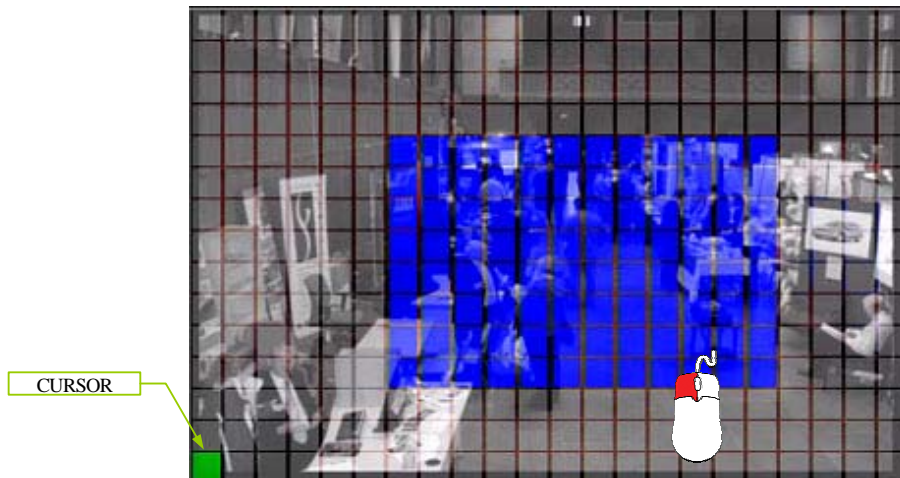

[Fig.7-79 Window Set screen]

- Window Clear

Click the WINDOW CLEAR button in the MOTION menu in order to clear the Motion Detection Area, and then the window you already created the motion detection area will be displayed. Click the starting point and the ending point as much as you wish to clear or it can be cleared by ALL CLEAR as described above (See ALL CLEAR).

Right-click on the current window to return to the MOTION menu.



[Fig.7-80 WINDOW CLEAR button]

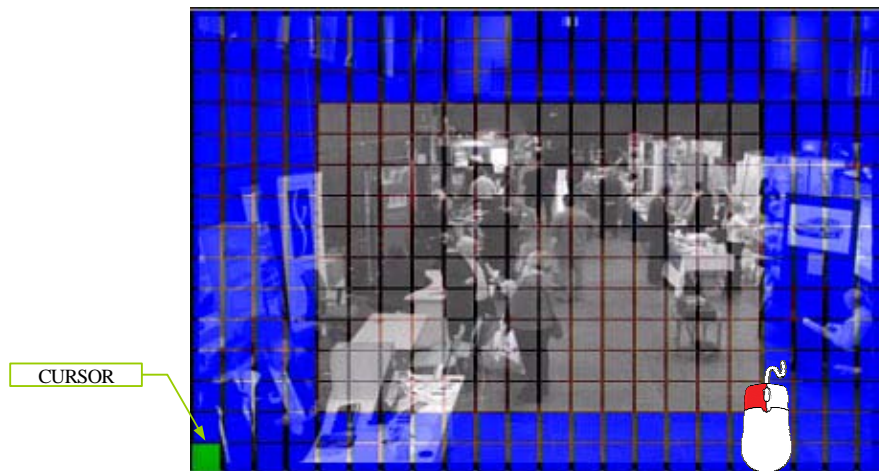

[Fig.7-81 Window Clear setup screen]

By Each Cell

Click the EACH CELL button in the MOTION menu on each of the cameras and click the mouse on each of the cells as much as you would like to designate the Motion Detection Area.

To clear, click the designated cells.

Right-click on the current window to return to the MOTION menu.



[Fig.7-82 EACH CELL button]

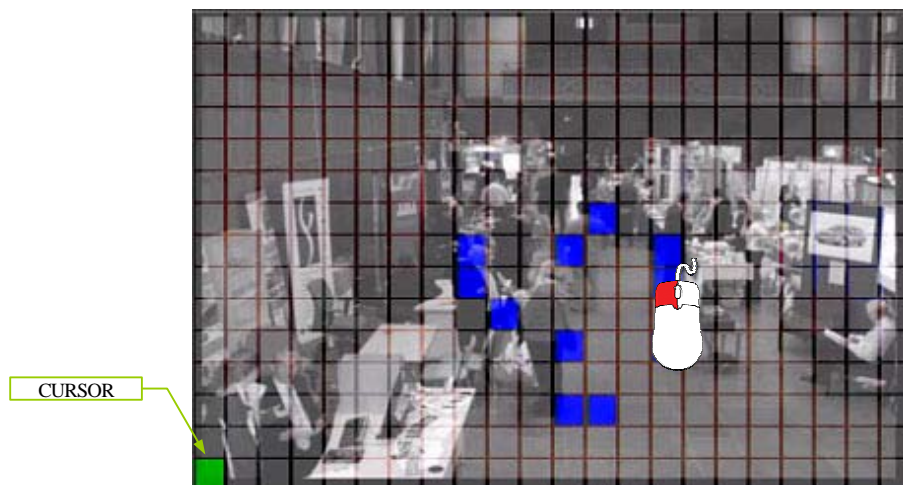

[Fig.7-83 Each Cell Setup screen]

▫ Map View

Click the MAP VIEW button in the MOTION menu to view the current settings for Motion detection area.

Right-click on the current window to return to the MOTION menu.



[Fig.7-84 MAP VIEW button]

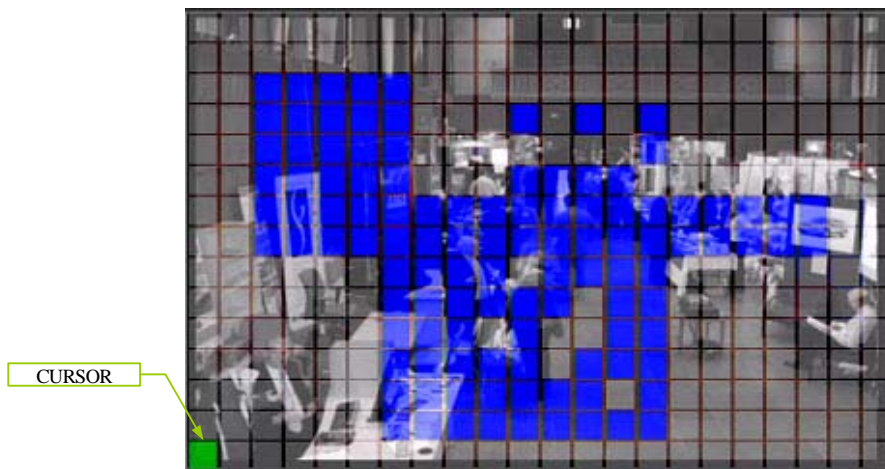



[Fig.7-85 Map View screen]



Note : Please pay attention to the following directions in order to use the Motion Detection function properly:

- Adjust the sensitivity level and motion area to fit your requirements.
 - Do not use this function in an area where many objects are continuously moving. In case of this, change the recording mode to the Continuous (Manual) Recording mode.
 - Use a high quality camera that does not generate video static or “noise”. The motion detection algorithm recognizes this “noise” as a motion and records the noise even if there was no actual motion.
 - Do not point the camera toward a strong and changing lighting source; it can activate false motion detection.
-

7-6.10. Recording by Sensor (PIR Sensor)

- Click the mouse on the  button for each of the channels in the RECORD menu and then the SENSOR menu will be displayed on the screen as shown in Fig.7-86.
- Click the  (EXIT) button to return to the RECORD menu.



[Fig.7-86 SENSOR window]

- ON/OFF
The system will start to record when Alarm is detected and the ON is selected in the SENSOR menu by clicking the mouse. If the OFF is selected, the system won't be recording.
If you select "OK", it will be recorded when only sensor is detected.



[Fig.7-87 SENSOR ON/OFF button]

▫ Pre-Alarm Time Setup

Allows you to record a section of video just prior to Sensor activation. Click the mouse on the PRE in the SENSOR menu and choose one of the values among 0, 1, 2, 3, 4 and 5 seconds with the mouse's wheel, and then click it to save.



[Fig.7-88 Pre-Alarm Time Setup button]



[Fig.7-89 Pre-Alarm Time Setup pop-up window]

▫ Alarm Hold Time Setup

The system continues recording for the Alarm HOLD TIME and finishes the recording. Click the mouse on the HOLD in the SENSOR menu and choose one of the values among 1 through 30 seconds with the mouse's wheel, and then click it to save.



[Fig.7-90 Alarm Hold Time Setup button]

▫ Spot Setup

If the "ON" is selected by clicking the mouse on the SPOT button in the SENSOR menu, a full screen will display when a motion is detected. If the "OFF" is selected, the full screen won't be displayed even though alarm is detected.



[Fig.7-91 Spot Setup button]

7-7. NETWORK

- Click the “NETWORK” button in the SETUP menu and then the NETWORK menu will be displayed on the screen as shown in Fig.7-92.
- Click the  (EXIT) button to return to the SETUP menu.

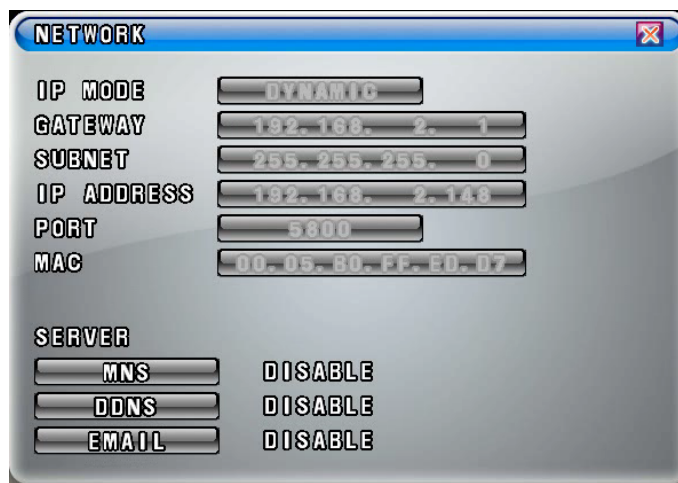

[Fig.7-92 NETWORK menu]

7-7.1. IP Mode

When the system uses the same IP address every time it connects to the network, it is known as a static IP address. If the system’s IP address changes frequently, it is called a dynamic IP address. Check with your Internet Service Provider to determine which IP address was given. This manual will guide users through the setup process for both types.

DYNAMIC IP: automatically receives IP address from the router or gateway. It doesn’t need to enter the GATEWAY ADDRESS, SUBNET MASK and IP ADDRESS.

STATIC IP: requires you to enter the GATEWAY ADDRESS, SUBNET MASK and IP ADDRESS.

- Click the “IP MODE” button in the NETWORK menu and then the IP mode pop-up window will be displayed on the screen (See Fig.7-94).
- Select the STATIC or DYNAMIC by clicking the mouse depends on your networking.



[Fig.7-93 IP Mode button]



[Fig.7-94 IP Mode pop-up window]

7-7.2. GATEWAY, SUBNET, IP ADDRESS

- Click the GATEWAY / SUBNET / IP ADDRESS button in the STATIC IP MODE and then the On Screen Keyboard will appear.
- Delete the current values with the  button and enter the address numbers by using On Screen Keyboard, and then click **OK** button to set with new address.
- Click the **CANCEL** button to return to the original values.



[Fig.7-95 Address Setup window]

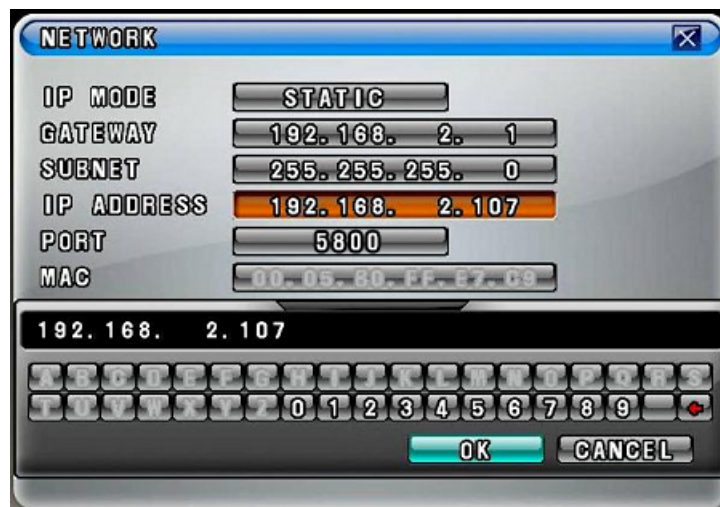

[Fig.7-96 On Screen Keyboard]

7-7.3. Port

- PORT is the TCP address of the program, which is used to connect to the network viewer. It can be set from 1 to 65535 values.
- Click the **PORT** button and then the On Screen Keyboard will show up.
- Delete the current port number with the  button and enter the new port number by using On Screen Keyboard, and then click “OK” button to set with new port number.
- Click the “CANCEL” button to return to the default value.



[Fig.7-97 Port Setup window]



[Fig.7-98 Port Setup Keyboard window]

7-7.3.1 Port Forwarding

- Router has to be set as a virtual server (or port forwarding) in order to utilize the MNS (Mac Name Server) or the DDNS service to use Internet Explorer (See section 8-3) on this product.
- Do not use the public port numbers.

7-7.4. MAC ID

- MAC ID is connecting address for Ethernet, every unit has 12 digit address (HEX 6 byte). MAC ID was already assigned with the factory default value. User can not change it.

7-7.5. MNS (MAC NAME SERVER)

As a sort of DDNS, two servers in our company (CLOVER) are being operated so that our client can access DVR with a Dynamic IP address. If one of servers stops operating, the other one will automatically start working.

- Click the **MNS** button in the NETWORK menu with a mouse (buttons on the front panel or remote controller) and then the **MNS** window will show up as below (See Fig.7-99).
- To return to the **NETWORK** window, click the  (EXIT) button in the **MNS** menu.

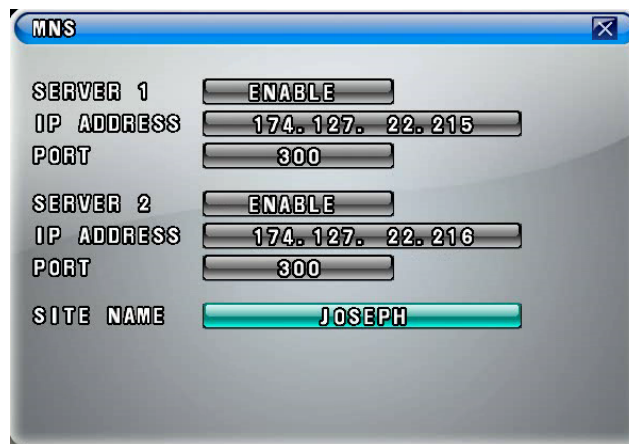

[Fig.7-99 MNS window]

- DISABLE / ENABLE

You can select the **DISABLE** or **ENABLE** button on both SERVER 1 and SERVER 2 by clicking the mouse or pressing the **ENTER** button on the front panel or remote controller.

“**DISABLE**”: MSN (MAC NAME SERVER) is not working.

“**ENABLE**”: MSN (MAC NAME SERVER) is working.



[Fig.7-100 DISABLE/ENABLE button]

▫ IP ADDRESS / PORT

DO NOT CHANGE THE IP ADDRESS AND PORT NUMBER IN THE MNS MENU IF YOU DON'T HAVE ANY SPECIAL SERVER TO ACCESS YOUR DVR WITH A DYNAMIC IP ADDRESS. IF YOU CHANGE THEM, YOU CAN'T NOT ONLY USE OUR MNS (MAC NAME SERVER), BUT ALSO YOUR NETWORKING WILL BE DISCONNECTED.

▫ SITE NAME

The SITE NAME is one of the important factors to access the DVR through MNS (MAC NAME SERVER) with the DVR Master (GUI).

You can't access the DVR system if the SITE NAME you entered already exists on the network. Try to connect the system with other SITE NAME.

- Click the SITE NAME button, the On Screen Keyboard will show up (See Fig.7-102).
- Delete the current SITE NAME with the  button and enter the new SITE NAME by using the On Screen Keyboard and then click **OK** button to save it.
- Click the "**CANCEL**" button to return to the previous value.





[Fig.7-101 SITE NAME Setup button]



[Fig.7-102 SITE NAME Setup: On Screen Keyboard]

7-7.6. DDNS (DYNAMIC DOMAIN NAME SYSTEM)

- Select the DDNS button in the NETWORK menu by clicking the mouse, pressing the buttons on the front panel or remote controller. The DDNS menu will show up as shown in Fig.7-103.
- To return to the NETWORK menu, Click the  (EXIT) button.
- If you were in the middle of entering values on the DDNS menu, you can't exit by clicking the mouse. Choose the SERVER button in the DDNS menu by clicking the mouse and select the DISABLE, and then click the  (EXIT) button.



[Fig.7-103 DDNS menu]

- SERVER
 - Choose the SERVER button in the DDNS menu by clicking the mouse or pressing the buttons on the remote controller and select the DYNDNS.ORG (or NO-IP.ORG) provided by www.dyndns.org (or www.no-ip.org) at no cost.



[Fig.7-104 SERVER button]

▫ HOST NAME

- Click the HOST NAME in the DDNS menu and type the HOST NAME registered to the DDNS server such as DYNDNS.ORG and NO-IP.ORG by using the On Screen Keyboard.
- After changing the values, click on the OK button.



[Fig.7-105 HOST NAME button]

▫ USER ID

- Click the USER ID in the DDNS menu and type the USER ID registered to the DDNS server by using the On Screen Keyboard.
- After changing the values, click on the OK button.



[Fig.7-106 USER ID button]

▫ PASSWORD

- Click the PASSWORD in the DDNS menu and type the PASSWORD registered to the DDNS server by using the On Screen Keyboard.
- After changing the values, click on the OK button.



[Fig.7-107 PASSWORD button]

7-7.7. HOW TO SETUP AND USE THE DDNS

7-7.7.1. Router.

It has to be set as a virtual server (or port forwarding) in order to utilize the DDNS. There are a lot of manufacturers on the market. Please read the provided manual thoroughly before setting or visit our website at www.cloverusa.com in regards to do it.

We, the manufacturer of DVR systems will not support the solution to your individual network issues.

** DDNS (Dynamic Domain Name System) is a method of keeping a domain name linked to a changing IP address. This is a useful feature since many computers do not use a static IP address.

7-7.7.2. Registration to the DDNS server

Visit at www.dyndns.org to register.

Registration to DYNDNS.ORG

1. Visit at www.dyndns.com.
2. Sign up for a new user name and a password: Click the Create Account on the upper right hand corner.
3. After signup new user, check your e-mail and confirm an e-mail from dyndns.com.
4. Go back to www.dyndns.com and log in with the ID and the Password.
5. After log in on dyndns.com front page, click on my services.
6. Click on the Add Host Service (Next to Host Level Service).
7. Click the Add Dynamic DNS Host on the Dynamic DNS.
8. The window to input Host Name will pop up, and select the dyndns.org or the dvrDNS.org on the pop-up window.
9. To complete, click the Add Host button on the bottom.
10. After registration, go to the NETWORK menu on the DVR and enter the HOST NAME, USER ID and the PASSWORD you just registered in the DDNS menu (See section 7-7.6).

7-7.8. EMAIL NOTIFICATION

- Email notification enables to notify events (sensor, motion, video loss, power on/off, power loss, record on/off, record fail, replay or copy start/stop) by sending emails to one or two email accounts.

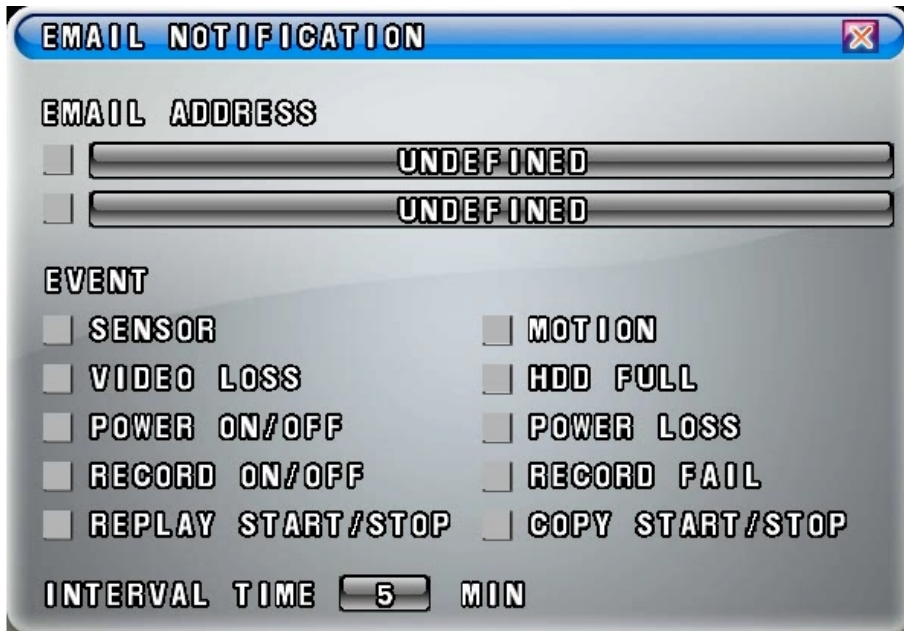

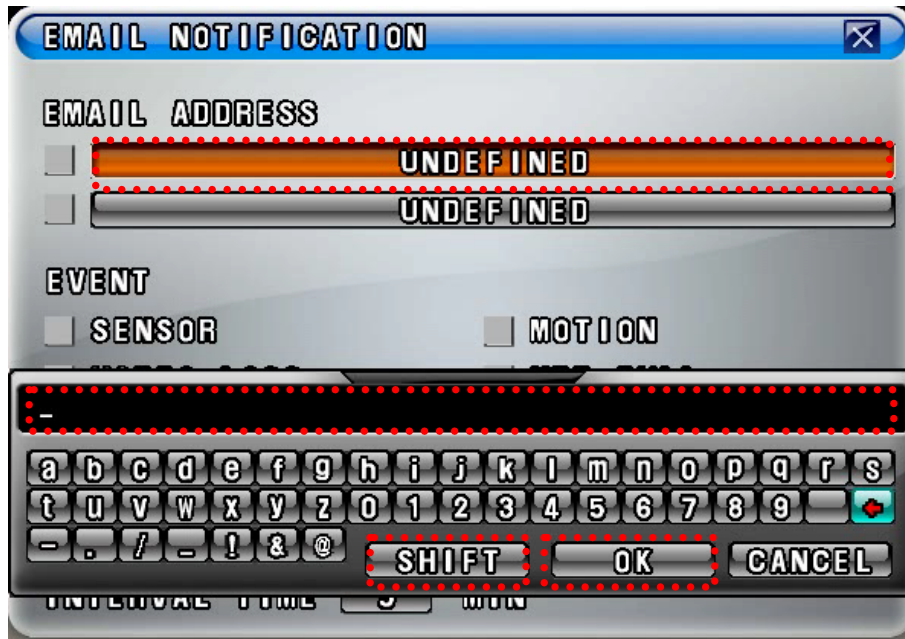

[Fig.7-108 Email Notification window]

▫ EMAIL ADDRESS SETUP



[Fig.7-109 Email Address setup]

- Click one of email address boxes and then the On Screen Keyboard will show up as shown Fig.7-109.
- Delete the current email address with the  button and enter an email address by using the On Screen Keyboard.
- If necessary, click the  button to enter upper cases.
- Click the OK button to save.
- Click the check box below to enable the email notification.



[Fig.7-110 Check Box for email]



Note : If a check box in Fig.7-110 is checked, "ENABLE" message will be displayed in the NETWORK menu, if not, "DISABLE" will be displayed.

▫ EVENT Setup

- Click the check boxes below to choose the events you need.
- To delete, click the check box again.



[Fig.7-111 Event setup]

▫ INTERVAL TIME Setup

- Click the INTERVAL TIME (see Fig.7-112) to set the interval time of sending emails and then choose the time (in minutes) on the pop-up window by clicking the mouse.
- If the 10 minutes is selected, the system will automatically send only one email every 10 minutes even though a lot of events occur.

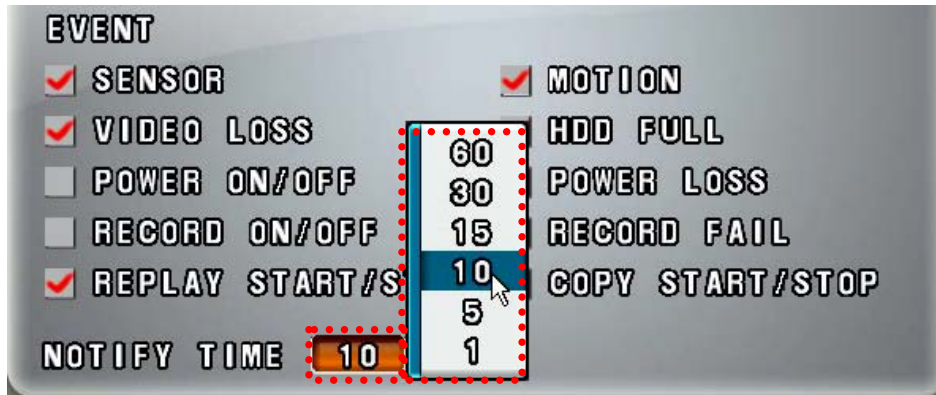

[Fig.7-112 Interval Time of Sending Emails]

Note : If the motion is selected in Fig.7-112, you may receive numerous emails from the DVR systems due to a couple of factors such as continuous moving objects, a strong and changing lighting source, low resolution and noises of cameras. In case of this, select a longer INTERVAL TIME and refer to “Note for Motion Detection Function” on page 112.

7-8. VIDEO ENHANCE

- Click the **VIDEO ENHANCE** button in the **SETUP** menu to enhance the picture quality on each of channels and **VGA OUTPUT** such as Brightness, Contrast and Saturation. The **VIDEO ENHANCE** menu will show up (See Fig.7-113).
- To return to the SETUP menu, click the  (EXIT) button.

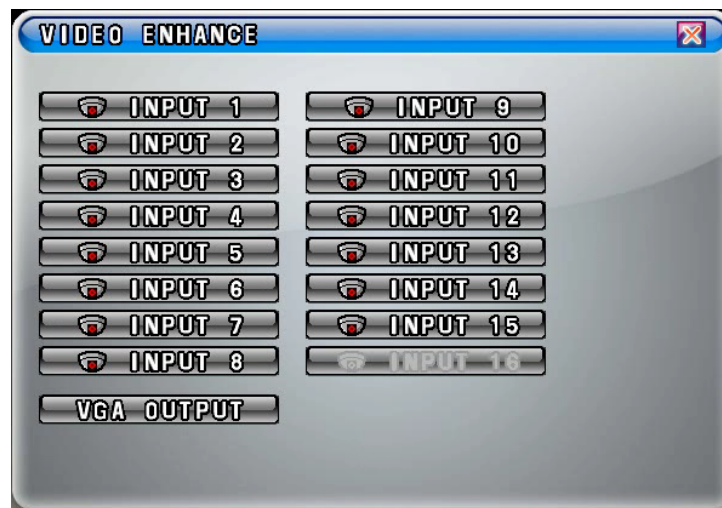

[Fig.7-113 VIDEO ENHANCE]

7-8.1. VIDEO ENHANCEMENT ON EACH CAMERA

- Click on an **INPUT** button in the **VIDEO ENHANCE** menu.
- The **CONTRAST** and **BRIGHTNESS** sliders will be displayed along with camera picture as shown in Fig.7-114.
- Adjust Contrast and Brightness with the sliders by clicking the mouse.
- To return to the VIDEO ENHANCE menu, Click the  (EXIT) button.



[Fig.7-114 CAMERA INPUT]

7-8.2. VIDEO ENHANCEMENT ON VGA OUTPUT

- Click on the **VGA OUTPUT** in the **VIDEO ENHANCE** menu.
- The **CONTRAST**, **BRIGHTNESS** and **SATURATION** sliders will be displayed along with camera picture.
- Adjust Contrast, Brightness and saturation with the sliders by clicking the mouse.
- To return to the **VIDEO ENHANCE** menu, Click the  (EXIT) button.



[Fig.7-115 VGA OUTPUT]

8

Remote Host Program

CONTENTS

8-1. REMOTE PROGRAM OVERVIEW	133
8-2. INSTALLING THE PROGRAM TO PC	134
8-3. INTERNET EXPLORER.....	135
8-4. REMOTE HOST.....	137
8-4.1. Setup.....	139
8-4.2. Connection.....	141
8-4.3. Capture	142
8-4.4. Status	143
8-4.5. Replay.....	144
8-4.6. COPY.....	146
8-4.7. Switch the Normal Screen to Full Screen	148
8-4.8. Speaker / Microphone.....	149
8-4.9. Connection mode.....	150
8-4.9.1. Terminal mode	150
8-4.9.2. Multi mode	151
8-4.10. Copy in the Terminal mode.....	152
8-4.11 E-Map.....	154
8-4.10.1. Addition of map.....	154
8-4.10.2. Placement of cameras on the map	155
8-4.10.3. Usage of camera position.....	156
8-4.10.4. Deletion of Camera position icon	156
8-4.12 Pan / Tilt & Preset.....	157
8-5. PLAYER.....	158

8-1. Remote Program Overview

The Remote Host Program allows you to view live video, search archived video, control PTZ cameras and to set up the exact same menus as the DVR does.

The DVR system can have up to 10 simultaneous Remote Connections. Each user can perform on the DVR system and will not affect the other users. The only exception to this is accessing Setup. Only one user is allowed to access Setup at any time.

In order to log in to the DVR system, users should be requested to enter the password if the password is already turned **ON** in the **SYSTEM** menu (Click **SETUP – SYSTEM**). This ensures that only authorized personnel are allowed to log in.

Remote system minimum requirements

- Microsoft Windows 2000, XP or VISTA Operating System
- Pentium-4 2.0GHz or higher
- 256MB System memory
- 1024 x 768 Display Resolution, 32Bit color
- Internet or LAN Connection
- TCP/IP installed
- Microsoft DirectX 9.0c

It is recommended to have DirectX 9.0c version in client PC. DirectX 9.0 is available for download from Microsoft homepage (www.microsoft.com/windows/directx).

8-2. Installing the Program to PC

Install the program into PC by using program CD (supplied) as follows.

How to install the program

1. Start the operating system (Windows 2000/XP/VISTA).
2. Insert the program CD into CD-ROM drive.
3. Open **My Computer**, and then select CD-ROM drive.
4. Double click **Setup.EXE**. The software installation will begin.
5. After the installation has been completed, the **DVR Master** icon will be created on your desktop screen as shown below.
7. Double click the **DVR Master** icon and the **DVR Master** screen appears.



[Fig.8-1 DVR Master icon]

How to set Screen Resolution and Color Quality

1. Click **Start**, point to **Control Panel** and then click on it.
2. Double-click **Display** icon.
3. In **Display Properties** Window, select **Settings**.
4. Set **Colors as True color (32 bit)** and **Screen area as 1024 x 768 (or 1152 x 864) pixels**.

8-3. Internet Explorer

When you are trying to use this function, it is highly recommended that the password should be turned **ON** in the SYSTEM menu not to enable unauthorized personnel to access your DVR system (See section 7-2.3).

Up to 10 users can remotely access your DVR with the HOST NAME.

How to setup the Internet Explorer

- Registration to the www.dyndns.org (See section 7-7.7.2 on page 123).
- In the IP address box of Microsoft Internet Explorer, type the HOST NAME (See Fig.8-2) you entered in the DDNS menu and the PORT NUMBER of the DVR, and then you will be asked to install the ActiveX control software (See Fig.8-3). **You should type the protocol (http://), the host name (example: cloverdvr1.dyndns.org) or the static IP address (See Fig.8-2-1) and the port number (:5800) in the IP Address box.**

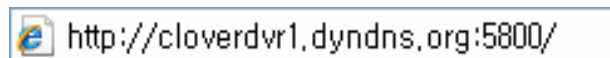

http://cloverdvr1.dyndns.org:5800/

[Fig.8-2 Host Name]



http://65.60.84.40:5800/

[Fig.8-2-1 IP & Port]

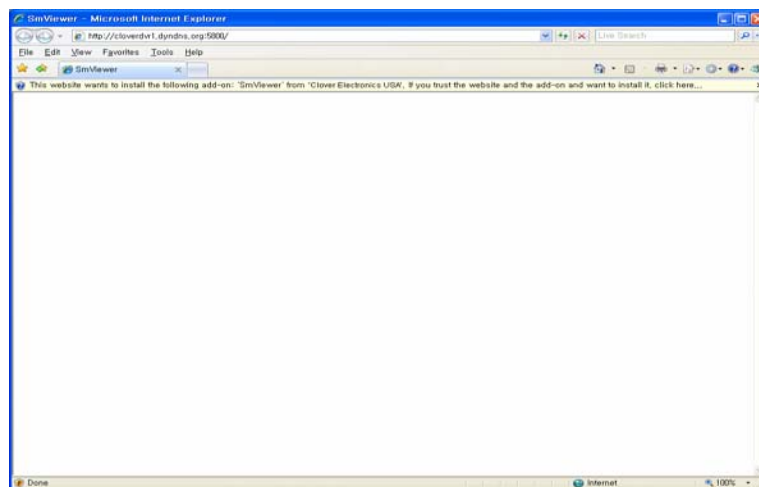

[Fig.8-3 DVR Master- Windows Internet Explorer]

- Click on the following message.
This site wants to install the following add-on: 'DVR Master' from 'Clover Electronics USA'. If you trust the website and the add-on and want to install it, click here....
- Click on the **click install ActiveX Control....** on the pop-up screen and the following window will be displayed.



[Fig.8-4 Install the DVR Master]

- Click on the **Install** button on the above window (See Fig.8-4) and the **DVR Master** will be shown. Refer to the following pages in regards to the **DVR Master**.

8-4. Remote Host

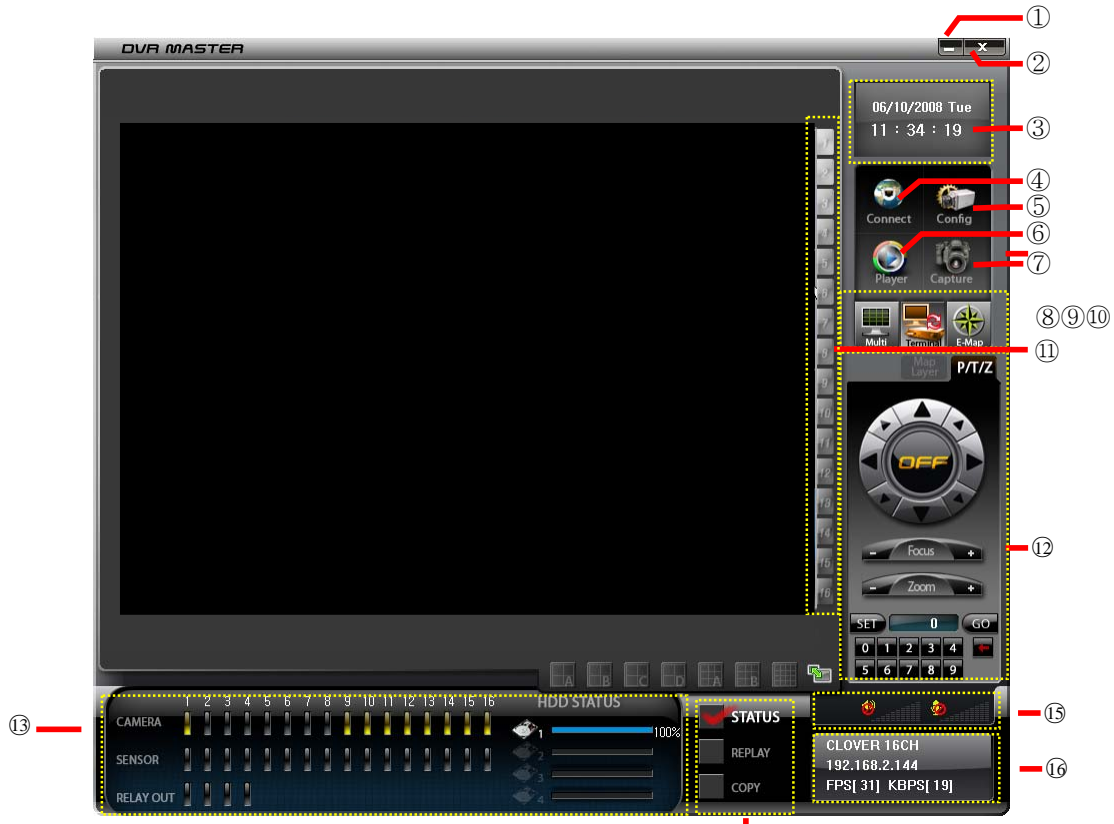

[Fig 8-5. DVR Master]

Table. Description of Remote Host Program Button

- ① Minimization Button
 - ② Close Button
 - ③ Current Time
 - ④ Connection Button
 - ⑤ Setup Button
 - ⑥ Player Execution Button
 - ⑦ Capture Button
 - ⑧ Multi-Mode
 - ⑨ Terminal Mode
 - ⑩ E-map Button
 - ⑪ Splits the screen in 4, 9 & 16ch.
 - ⑫ PAN /TILT Control Button (Control the PTZ camera from the remote site DVR)
 - ⑬ Depending on the mode, it displays Status/REPLAY / COPY information.
 - ⑭ Change button for STATUS / REPLAY/ COPY mode.
 - ⑮ When connected, it displays the audio channel, PC Speaker & Mic control button of remote site DVR.
 - ⑯ It displays the IP address, Frame rate and transfer rate.
-

8-4.1. Setup

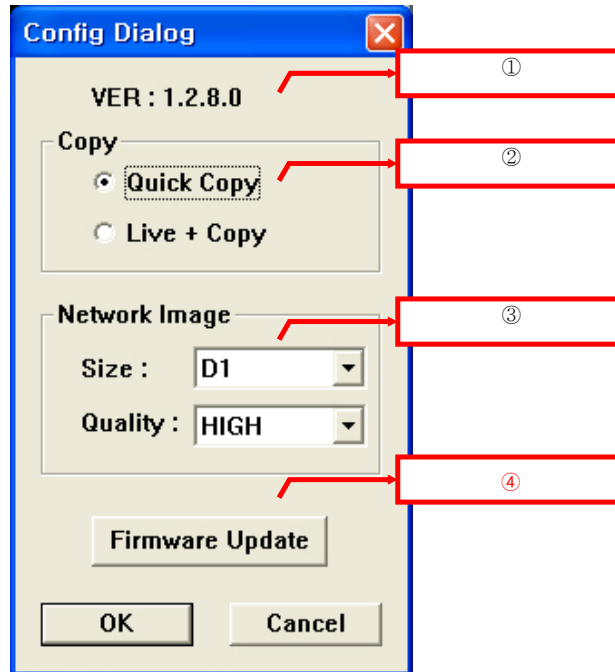

[Fig.8-6 HOST CONFIG window]

① Version number

It represents the current version number of the Firmware.

② Copy

Refer to Section 8-4.10 in regards to copying methods after selecting one between the Quick Copy and the Live + Copy.

▫ Quick Copy

Click on the Quick Copy for faster copying the recorded data from the DVR to the Host Program (DVR Master) without live images. The copying speed of the Quick Copy is faster than the Live + Copy.

▫ Live + Copy

Click on the Live + Copy for copying the recorded data from the DVR to the Host Program (DVR Master) with live images. The copying speed of the Live + Copy is slower than the Live + Copy.

③ Network Image

▫ Size

Choose a Size (Resolution) among D1, Half D1 and CIF you wish to display on the DVR Master by clicking the mouse. This setting does not affect the DVR.

▫ Quality

Choose one among LOW, NORMAL, HIGH and BEST you wish to display on the DVR Master by clicking the mouse. This setting does not affect the DVR.

④ Firmware Update

- Save the latest Firmware to the System Files (Open Windows Explorer – click My Computer - click the Program Files – click DVR Master – click System Files).
- Click the Firmware Update button in the Fig.8-6, and then you will be asked “Do you want to update a firmware?”
- Click the Yes to update.
- Double click the latest firmware as shown in Fig.8-7 and then you will be asked “Shall I update firmware?”
- Click the OK to update. The DVR will display the “Firmware Updating.....” along with the progressive bar on the screen and it will automatically reboot.

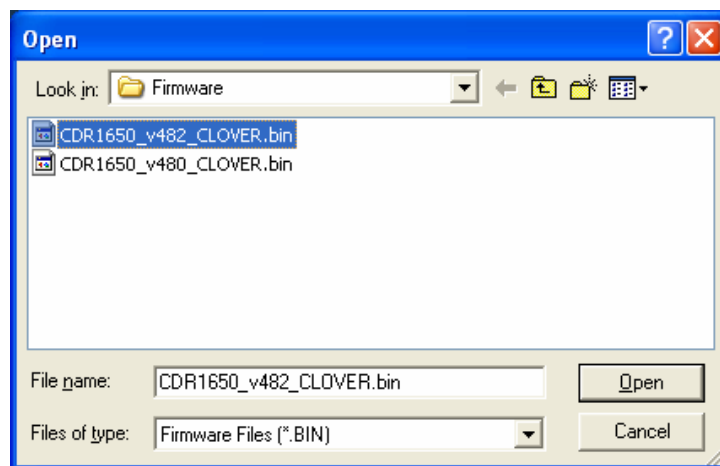

[Fig.8-7 Firmware Files]

8-4.2. Connection

There are two ways to access the DVR through the **DVR Master** as follows.

- With **Set Direct** setting
 - Click the “CONNECT” button on the DVR Master and then the “Connect Dialog menu” as shown in Fig. 8-8 will be displayed.
 - Click the “Set Direct” in the Connect Dialog menu and click the “EDIT” button.
 - Enter the IP address (or WAN IP address of the Router) and Port number, which must be the same as DVR has.
 - Click the “EDIT” button again and then the connection list will be created in the Name List (up to 20 lists).
 - Choose a Site Name in the Name Lists and click the “CONNECT” button in order to access the DVR.

- With **Get Server** setting
 - Click the “CONNECT” button on the DVR Master and then the “Connect Dialog menu” as shown in Fig. 8-8 will be displayed.
 - Click the “Get Server” in the Connect Dialog menu and click the “EDIT” button.
 - Enter the IP address, Port number and Site Name, which must be the same as the MNS has (**SETUP**-click **NETWORK**-click **MNS** in the **NETWORK** menu: Refer to section 7-7.5 **MNS on page 119**).
 - Click the “EDIT” button again and then the connection list will be created in the Name Lists (up to 20 lists).
 - Choose a Site Name in the Name Lists and click the “CONNECT” button in order to access the DVR.

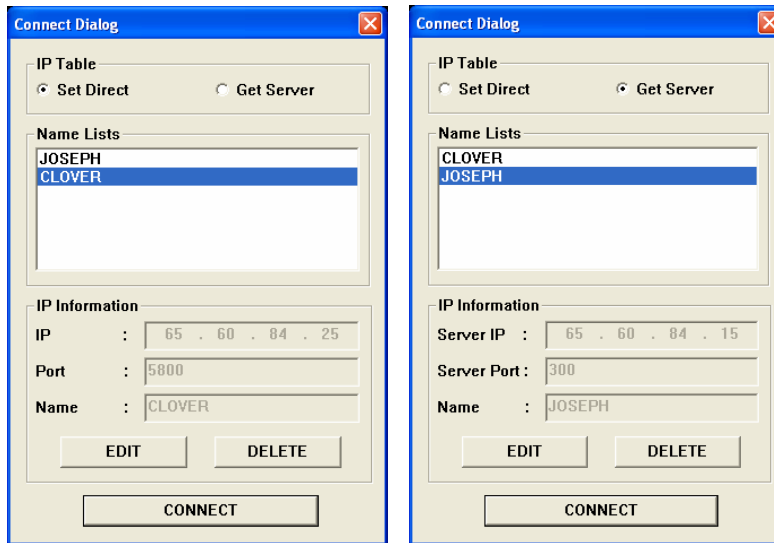

[Fig.8-8 Connect Dialog]

8-4.3. Capture



The current images on the screen will be captured and saved in the Printed Files (Open Windows Explorer – click My Computer – click Program Files – click DvrMaster – click Printed Files).

To play captured images, double-click one of JPEG Images in the Printed Files.

8-4.4. Status



If the Status button on the DvrMaster is selected by clicking the mouse, the DvrMaster displays the DVR's status related to connections of cameras, sensors, relay outputs and remaining HDD (Hard Disk Drive) capacity available for recording.



Status button

[Fig.9-9 STATUS MODE]

8-4.5. Replay



It is possible to replay the recorded data from the DVR system by using the Replay button in Fig.8-10 in the Multi mode only (refer to section 8-4.9.2).

-Click the Replay button as shown in Fig.8-10 to playback the recorded data from the DVR system, and then the Replay Time Setup Window will be displayed.

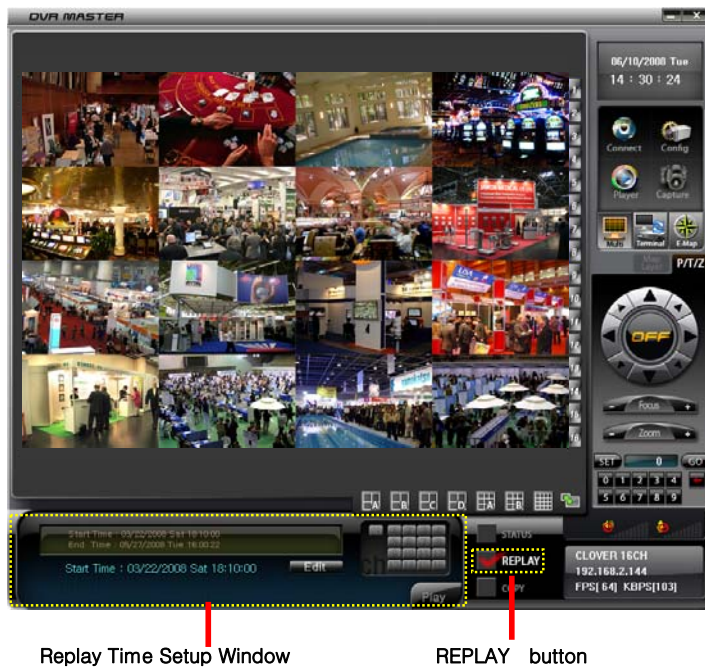

[Fig 8-10 Replay mode]

- After checking the Start Time and End Time on the upper part of the Replay Time Setup Window, click the Edit (**Edit**) button to set the Replay Start Time.
- Set the Replay Start Time in the Start Time Setting menu as shown in Fig.8-11and click the OK button. Replaying start time setup can be possible within a recoding time extent.
- Click the Play (**Play**) button.
- It will start playing the recorded data and the playback control buttons will show up.

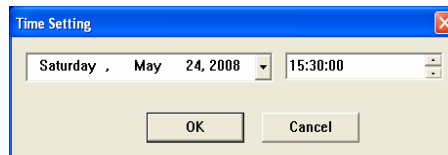

[Fig.8-11 Start Time setting]

▫ Playback Control



Playback Control Buttons

[Fig 8-12. Playback control]

Playback control buttons



: Button for fast rewinding up to 128 times by repeatedly pressing.



: Button for viewing previous frame in still image.

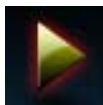

: Play button.



: Button for viewing the next frame in still image.



: Button for fast forwarding up to 128 times by repeatedly pressing.

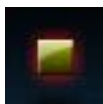

: It stops replaying.

8-4.6. COPY



It is possible to copy the recorded data from the DVR system to a client PC by using the Copy button in Fig.8-13 in the Multi mode only (refer to section 8-4.9.2).

- Click the Copy button as shown in Fig.8-13 to copy the recorded data from the DVR system to a PC, and then the Copy Time Setup Window will be displayed.
- The copy data will be saved in the Backup Files (Open Windows Explorer – click My Computer – click Program Files – click DvrMaster folder – click Backup Files).



Copy Time Setup Window

Copy button

[Fig 8-13 Copy mode]

- Check the Start Time and End Time on the upper part of the Copy Time Setup Window and click the Edit (**Edit**) button to set the Copy Start/End Time.
- Set the Copy Start/End Time in the Start/End Time Setting menu as shown in Fig.8-14 and click the OK button. Copying Start/End time setup can be possible within a recording time extent.
- Select camera(s) you wish to copy by clicking "ALL" or camera channel number(s) in the Copy Time Setup Window.

8. Remote Host Program

“ALL” in yellow represents that all the cameras are selected.

The camera channel number(s) in yellow represents that the corresponding channel(s) are selected.

- Click the Copy () button and then the copying progressive bar as shown Fig.8-15 will show up.
- While copying, click the Stop button in the Copy Time Setup Window if you want to stop copying.
- To playback, refer to section 8-5.PLAYER.

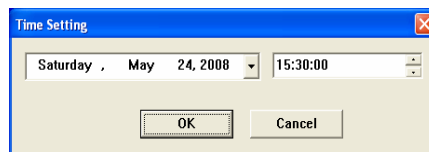

[Fig.8-14 Copy Start/End Time setting menu]

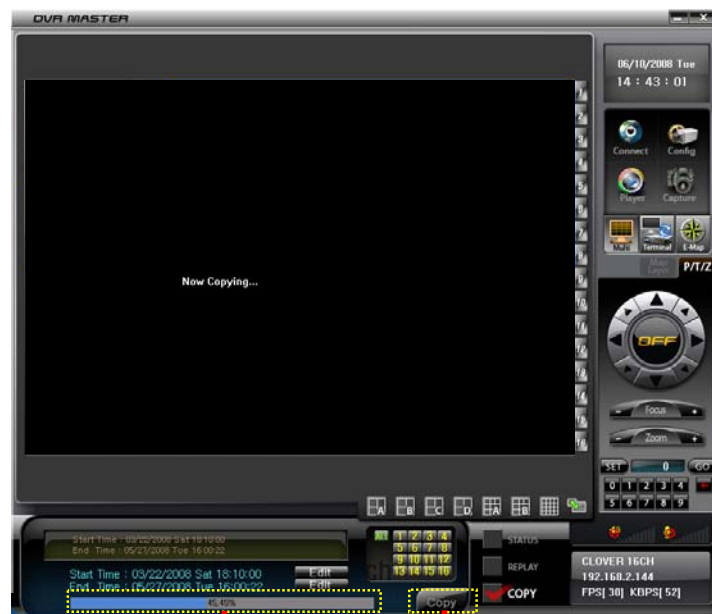

Copying Progressive Bar

Stop button

[Fig 8-15 Status of Copying]

8-4.7. Switch the Normal Screen to Full Screen

- Click the “FULL SCREEN” button on the DvrMaster as shown Fig.8-16 and then the current screen size will be enlarged to fit the monitor’s screen size, but the resolution will be lowered.
- Click the “FULL SCREEN” button again to go back to the NORMAL SCREEN.

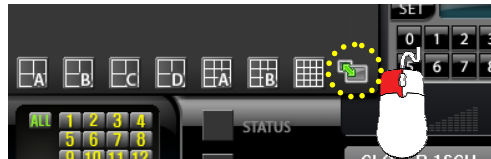

[Fig.8-16 Full Screen Button]

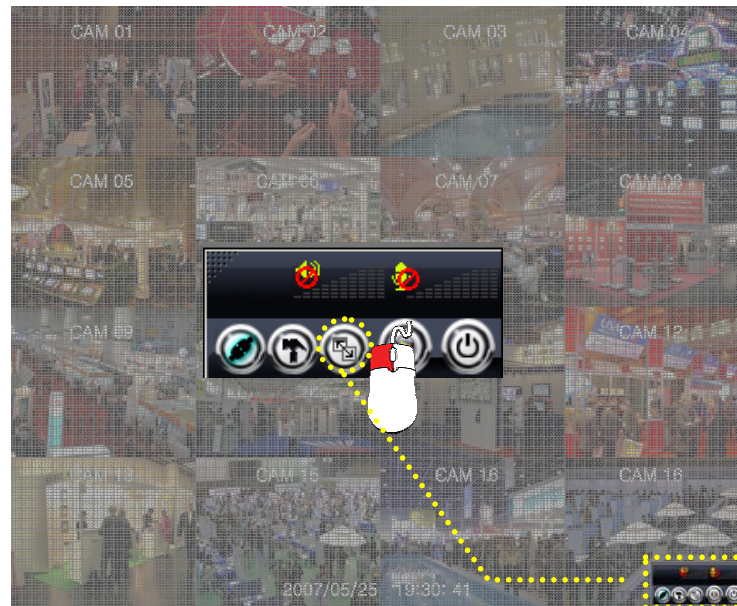

[Fig.8-17 Switch the Normal Screen to Full Screen]

8-4.8. Speaker / Microphone

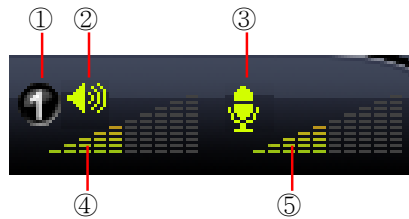

[Fig.8-18 Speaker / Microphone]

Buttons of Remote Host Program

- ① Audio Input channel selection: Select the same audio channel as the DVR has.
 - ② PC Speaker ON/OFF: Turn the Speaker ON or OFF by clicking the mouse.
 - ③ PC Microphone ON/OFF: Turn the Microphone ON or OFF by clicking the mouse.
 - ④ PC Speaker Volume Control: Adjust the Speaker Volume by clicking the amount of audio volume. It is available when the Speaker is turned ON.
 - ⑤ Microphone Volume Control: Adjust the Microphone Volume by clicking the amount of audio volume. It is available when the Microphone is turned ON.
-

8-4.9. Connection mode

There are two kinds of connection mode (See Fig.8-19) on the DvrMaster. Select one of them by clicking the mouse depending on your application.



[Fig.8-19 Connection Mode]

8-4.9.1. Terminal mode

The functions of icons such as Recording, Play, Copy, Setup, System Status, Pan/Tilt, Display, Zoom and OSD on the bottom of the screen are identical to ones DVR system has.

If the terminal mode button on the DvrMaster (See Fig.8-19) is selected, the image of channel 16 won't be displaying on the monitor connected to DVR and DvrMaster.

- Right-click on the screen to appear the icons and right-click it again to disappear.
- For displaying a full screen, click one of channels and for the split screen, click it again.

To display the image of channel 16 on the DVR's monitor,

-Switch the terminal mode to multi mode on the DvrMaster.

-Or exit the DvrMaster by clicking  on the upper right-hand corner of the screen.

8-4.9.2. Multi mode

It is impossible to control (Recording on/off, Setup, System Status, Display and OSD) the DVR system in the Multi mode except Replaying and Copying (See section 8-4.5, 8-4.6 on page 144-146), but the image of channel 16 will always display on the monitor and the DvrMaster.

- Click the Multi mode button to choose the Multi mode as shown in Fig.8-20.



[Fig.8-20 Multi mode screen]

8-4.10. Copy in the Terminal mode

There are four icons such as NETWORK, USB, CD and DVD in the COPY menu of the Multi mode. The recorded data will be saved in the Backup Files (Open Windows Explorer – click My Computer - click the Program Files – click DvrMaster – click Backup Files) through the NETWORK, but the other icons such as USB, CD and DVD will only show what the DVR system functions on these icons. Therefore it is impossible to copy the recorded data to client computer with these icons.

- Click the COPY button on the menu bar and the COPY menu will be displayed on the screen.
- In order to set the Copy starting time and the Copy ending time, select the values (year/month/date and hour/minute/second) by clicking the mouse, change the values with the mouse's wheel and click the mouse again on the changed values to complete.
- Click the mouse on the  icon only when the network is connected and you will be asked as shown in Fig.8-21.
- Click the Yes to copy and the DvrMaster will show the progressive status to copy (See Fig.8-22).
- Click the OK to complete the copy (See Fig.8-23).

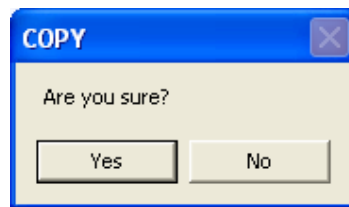

[Fig.8-21 Copy Confirmation]

8. Remote Host Program

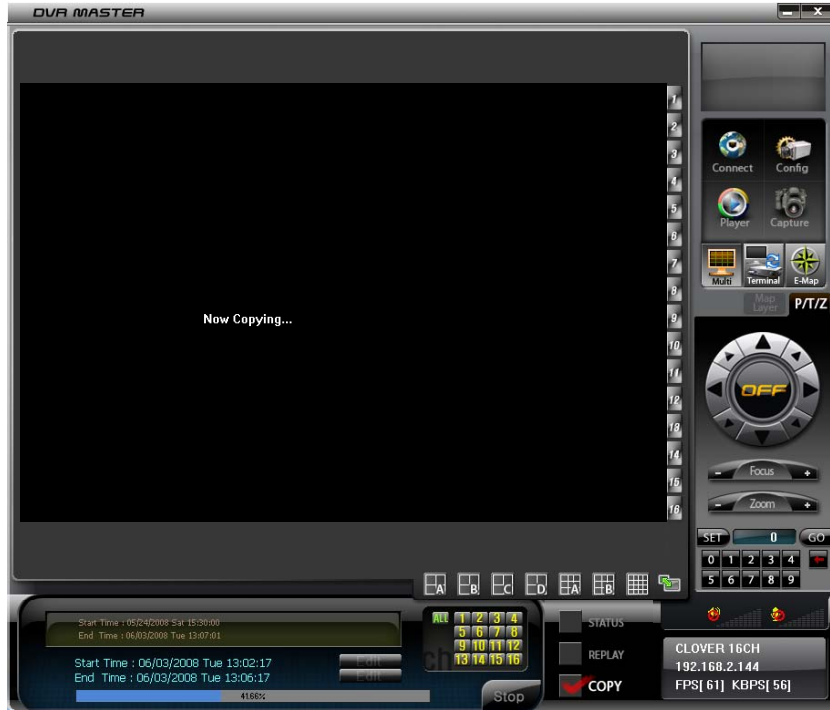

[Fig.8-22 Copying in the Terminal mode]

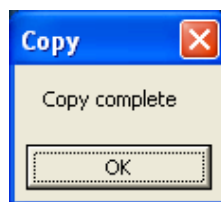

[Fig.8-23 Copy Completion]

8-4.11 E-Map

E-Map enables users to display the cameras on the digital map for better monitoring. The digital map should be a BMP file and you can make it (the higher resolution the better) or use the E-map samples saved in the E-map folder (See Fig.8-26).



[Fig.8-24 E-Map MODE]

8-4.10.1. Addition of map

- Click the E-Map button on the DvrMaster.
- Right-click the MAP as shown in Fig.8-25 and click “Add eMap” on the pop-up window, and then the BMP files factory saved will show up (See Fig.8-26).
- Select a BMP file and click “OPEN button in Fig.8-26, and then an eMap will be saved under the MAP button.

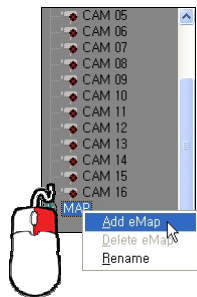

[Fig.8-25 Add eMap]

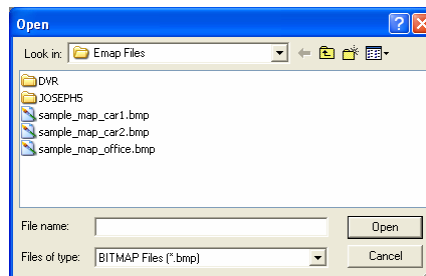

[Fig.8-26 BMP files]

8. Remote Host Program

- To rename, right-click a saved eMap list and click “Rename” on the pop-up window as shown in Fig.8-27.
- To delete, right-click a saved eMap list and click “Delete eMap” on the pop-up window as shown in Fig.8-28.
- To display, double-click one of saved eMap lists. The image size of each channel will be minimized or maximized as much as you want.



Note : The eMap list that is currently displaying can't be deleted or renamed.

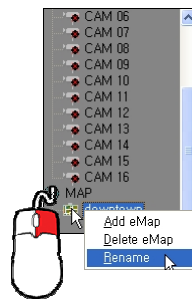

[Fig.8-27 Rename]

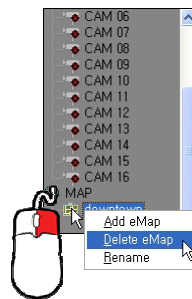

[Fig.8-28 Delete]

8-4.10.2. Placement of cameras on the map

- Click one of the cameras connected to the DVR system and drag the mouse and drop on the map as shown in Fig.8-29.



[Fig.8-29 Placement of Cameras on the Map]

8-4.10.3. Usage of camera position

The small squares with channel numbers on the map indicate the camera position. The blue screen represents that the corresponding camera is not connected to the DVR system.

- Double-click the image to display a full screen.
- To change the camera position, click the image and drag the mouse and drop on the map.
- Double-click the channel number(s) to hide or show the image(s).
- Place the mouse pointer on the square line and minimize or maximize the image by using ⇄ sign.



[Fig.8-30 Usage of Camera Position]

8-4.10.4. Deletion of Camera position icon

Click the image or channel number and drag the mouse and drop the mouse pointer outside of the screen.

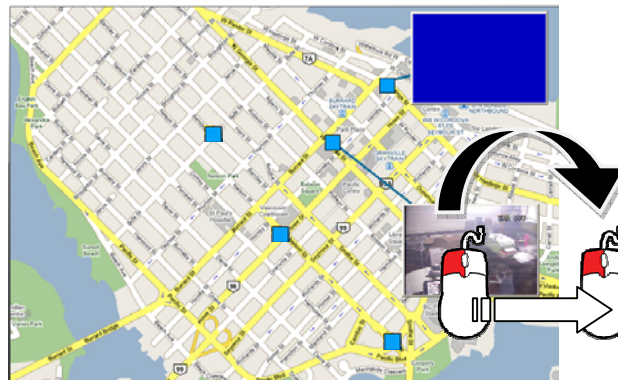

[Fig.8-31 Deletion of Camera Position icon]

8-4.12 Pan / Tilt & Preset

You can control the PTZ camera through DvrMaster. This feature is basically identical to what the DVR system has. Refer to section 6-7.7 PAN/TILT on page 46.

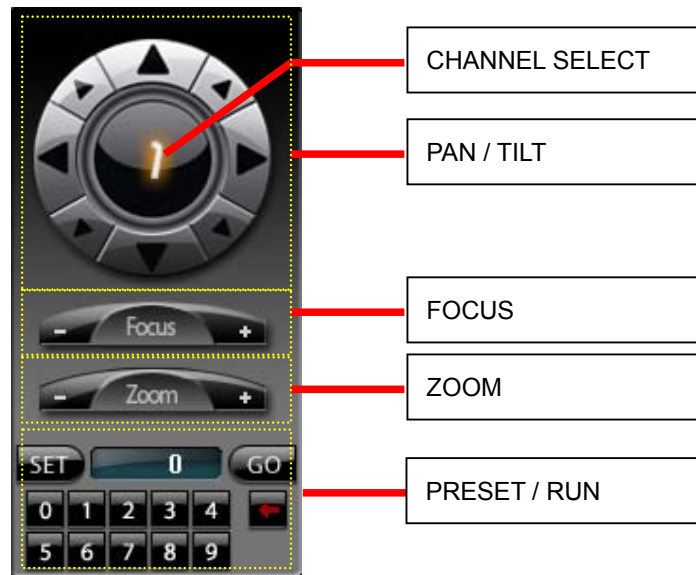

[Fig.8-32 PAN / TILT]

8-5. PLAYER

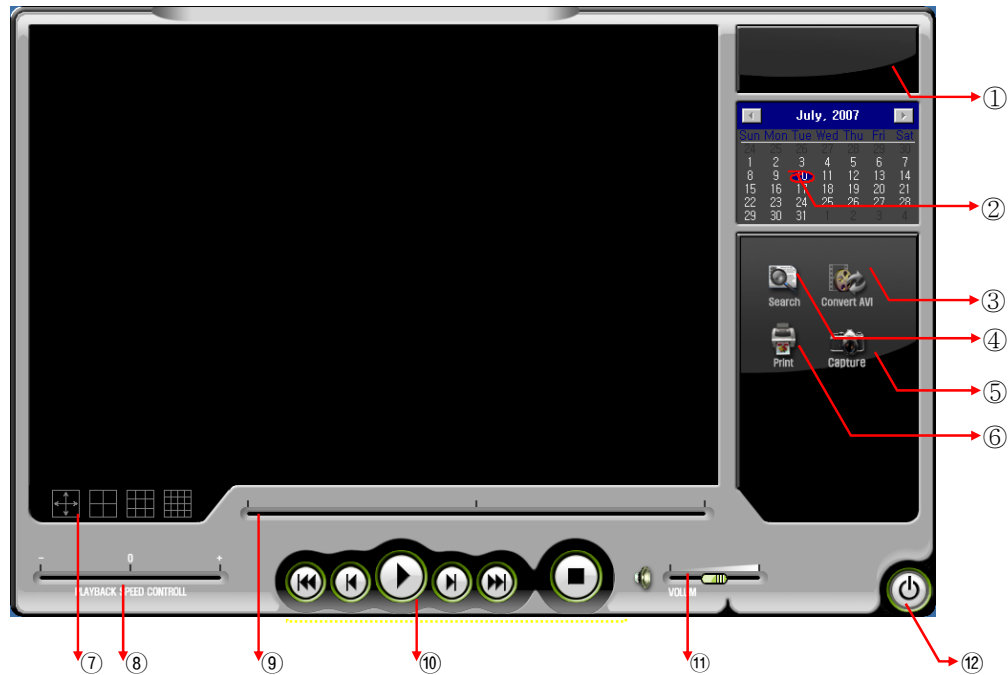

[Fig.8-32 Player]

Chart. Button of Player Program

- ① Status window (Play mode, Date, Time)
- ② Calendar
- ③ Convert to AVI File
- ④ Search button for replaying
- ⑤ Capture button
- ⑥ Print button
- ⑦ Division button
- ⑧ Playback (Replay) speed Control
- ⑨ Search slider for replaying
- ⑩ Replay Control
- ⑪ Volume Control
- ⑫ Exit program button

① Status window (Play mode, Date, Time)

It indicates the play mode, date and time.



[Fig.8-33 Status window]

② Calendar

It shows the date currently being replayed.



[Fig.8-34 Calendar]

③ Convert AVI File

Convert the recorded files to AVI files.



- Click the Convert AVI button on the Player and the Convert AVI window will be displayed (See Fig.8-35).
- Click on the SELECT button on the Convert AVI window and the Browse for Folder will be displayed (See Fig.8-36 and Fig.8-37).
- Select the folder that contains the recorded data and select one of the channels by clicking the mouse and click the OK (See Fig.8-38).
- Click the Start Convert button on the Convert AVI window and click the CLOSE button after verifying the status "Complete" (See Fig.8-39).

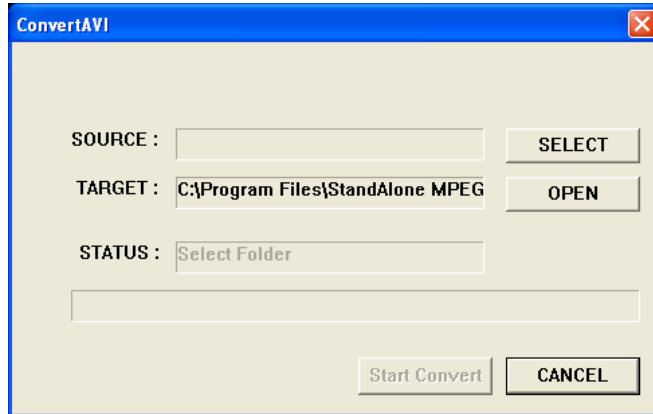

[Fig.8-35 Convert AVI window]

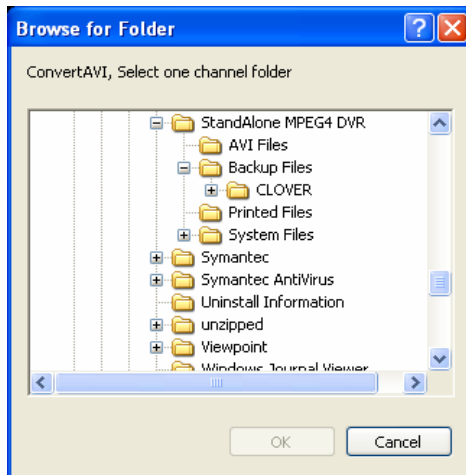

[Fig.8-36 Backup Files by Networking]



[Fig.8-37 DvrRecData by USB]

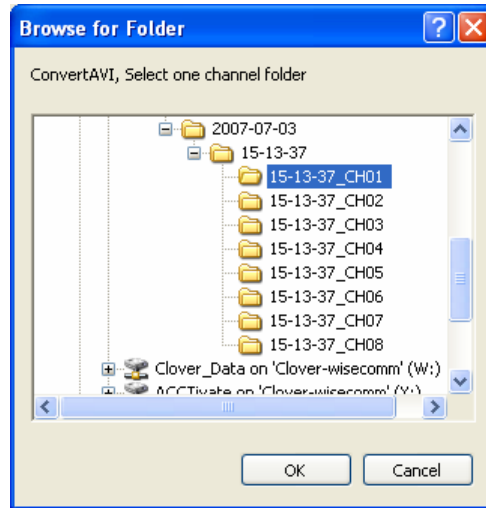

[Fig.8-38 Select one of the Channels]

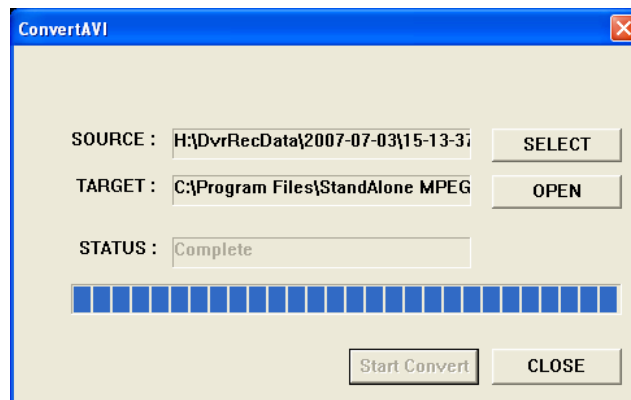

[Fig.8-39 Start Convert Button]

How to play the AVI files

By using Windows media player:

- Click the OPEN button on the Convert AVI window and double click one of the AVI files to play. The AVI files will save in the AVI Files folder (Open Windows Explorer – click My Computer - click the Program Files – click DvrMaster – double click one of the AVI Files).

④ Search button for Replaying



- Click the Search button on the Player and the Browse for Folder will be displayed.
- Select the folder that contains the recorded data and click the OK button on the Browser for Folder. One channel or all the channels can be replayed depending on the selection.

⑤ Capture button

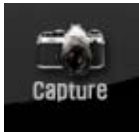

- Click the Capture button when a full screen is replaying on the Player and the current images will be saved in the Printed Files (Open Windows Explorer – click My Computer - click the Program Files – click DvrMaster – click Printed Files) in JPEG file format.

⑥ Print button

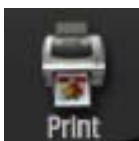

- Click the Print button when a full screen is replaying on the Player and the current images will print out along with comments if you write down some comments in the Print Comment Dialog as shown in Fig.8-40.
- Click the OK button in the Print Comment Dialog regardless of the comments to print.



[Fig.8-40 Print command window]







[Fig.8-41 Print image]

⑦ Division button



Select one of the following divisions while replaying.

-  Full Screen
-  4 Division Screen
-  9 Division Screen
-  16 Division Screen

[Fig.8-42 Division button]

⑧ Playback (Replay) Speed Control

Move the slider with the mouse to control the replaying speed.

The "0" represents the normal speed, "-" and "+" represents slow speed and fast speed respectively.



[Fig. 8-43 Replay Speed Control Slider]

⑨ Search slider for replaying

The slider can be moved left and right by clicking the slider on the bar and dragging it or just click the bar to search the recorded data.



[Fig.8-44 Replay Search Slider]

⑩ Replay Control

Refer to section 6-9.2.3.



[Fig.8-45 Replay Control buttons]

⑪ Volume Control.

Control the volume when replaying on the full screen mode



[Fig.8-46 Replay Volume Control Slider]

⑫ Exit button

Click the Exit button on the Player to exit.



9

Installation of additional HDDs

CONTENTS

9-1. HDD (HARD DISK DRIVE) INSTALLATION	166
9-2. INSTALLATION OF AN ADDITIONAL HDD	167

9-1. HDD (Hard Disk Drive) INSTALLATION

- ▶ Three of internal Hard Disk Drives (HDD) and a CD R/W or DVD R/W can be installed in the system. DVR manufacturer already installed a 500GB of Hard Disk Drive (IDE) and a DVD R/W. To install additional hard disk drives, refer to the following pages.



Note: Jumper settings for all the Hard Disk Drives and the DVD R/W should be made on “Cable Select”. Do not set the jumper settings as Master or Slave on any of IDE Drives, the system won’t be working properly

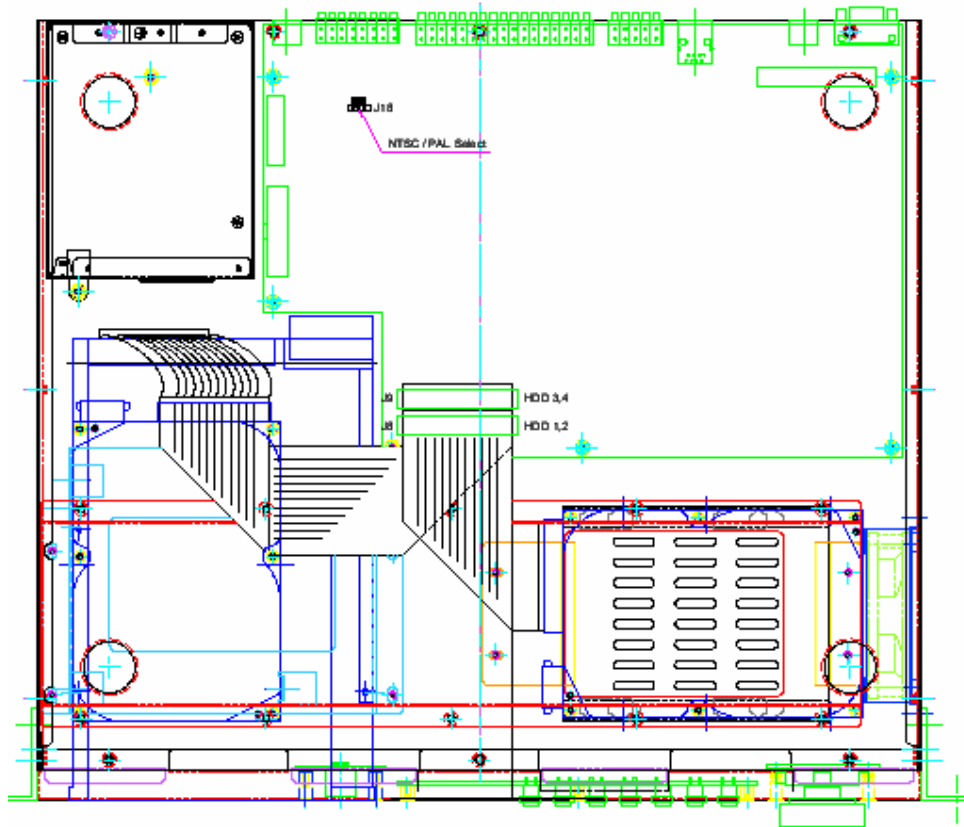

[Fig 9-1 System in]

9-2. Installation of an additional HDD

- ▶ Set the jumper setting to “**Cable Select**” position on the additional HDD.



Note: Be sure that the jumper setting is correct. If not, the system will not recognize the additional HDD.

- ▶ Turn off the power. Unscrew and remove the cover.
- ▶ Install the additional HDD in the space as shown in Fig.9-1.
- ▶ Connect the power connector and the flat cable to the HDD.
- ▶ Reassemble the cover.
- ▶ Turn on the system and confirm that the system recognizes the additional HDD. If the system fails to recognize the HDD, check the correct jumper settings and secure cable connections.



Note: After installing the additional HDD, formatting on the new drive should be performed. Refer to section 7-3.3. for more details.

APPENDIX

CONTENTS

RECORDING TIME TABLE.....	170
FACTORY DEFAULT SETTINGS.....	171

Recording time table

HDD: 500GB, Based on 16 cameras

Recording Resolution : CIF(320 X 240)

DAYS

Each CH (16CH/fps)	30 fps (480fps)	15 fps (240fps)	10 fps (160fps)	7.5 fps (120fps)	5 fps (80fps)	3 fps (48fps)	2 fps (32fps)	1 fps (16fps)
BEST	12.14	24.28	36.42	48.56	72.84	121.40	182.10	364.20
HIGH	18.83	37.66	56.49	75.32	112.98	188.30	282.45	564.90
NORMAL	25.25	50.50	75.75	101.00	151.50	252.50	378.75	757.50
LOW	33.17	66.34	99.51	132.68	199.02	331.70	497.55	995.10

Recording Resolution : HD1(720 X 240)

DAYS

Each CH (16CH/fps)		15 fps (240fps)	10 fps (160fps)	7.5 fps (120fps)	5 fps (80fps)	3 fps (48fps)	2 fps (32fps)	1 fps (16fps)
BEST		12.76	19.14	25.52	38.28	63.80	95.70	191.40
HIGH		20.67	31.01	41.34	62.01	103.35	155.03	310.05
NORMAL		28.50	42.75	57.00	85.50	142.50	213.75	427.50
LOW		37.66	56.49	75.32	112.98	188.30	282.45	564.90

Recording Resolution : D1(720 X 480)

DAYS

Each CH (16CH/fps)				7.5 fps (120fps)	5 fps (80fps)	3 fps (48fps)	2 fps (32fps)	1 fps (16fps)
BEST				22.92	34.38	57.30	85.95	171.90
HIGH				31.28	46.92	78.20	117.30	234.60
NORMAL				41.36	62.04	103.40	155.10	310.20
LOW				55.56	83.34	138.90	208.35	416.70

Factory default settings

(1) LIVE SCREEN

16 SPLIT

OSD ON

(2) TIME / DATE

DISPLAY: ON

TIME FORMAT: 24 HOUR

DATE FORMAT: MM/DD/YYYY

(3) LOAD / BACKUP CONFIG

NONE LISTS

(4) USER ACCOUNT

PASSWORD: SET YOUR PASSWORD (THE PASSWORD IS NULL)

PASSWORD ON/OFF: OFF

(5) IR REMOTE ID

OFF

(6) HDD OVERWRITE

ON

(7) CAMERA

ACTIVE: ALL ON

NAME: CAM XX

BUZZER: ALL ON

RELAY: ALL OFF

PAN/TILT VENDOR: PELCO

DISPLAY: ON

SEQ DISPLAY DWELL: 1 SEC

(8) AUDIO

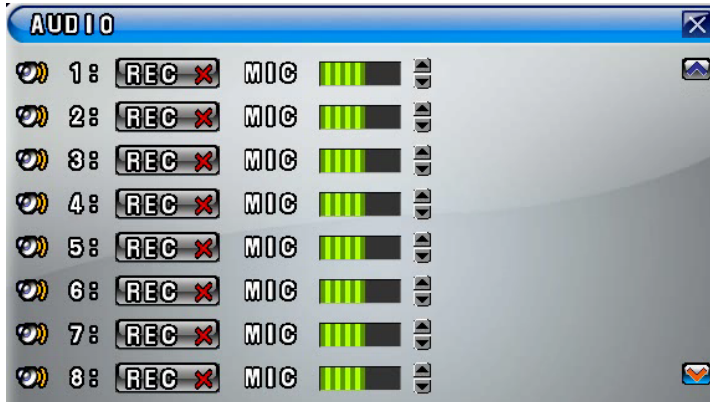

(9) RECORD

RECORD ICON DISPLAY: ON

SIZE: ALL HALF D1 (704 X 240)

FPS: ALL 15 fps

QUALITY: ALL HIGH

MODE: ALL MANUAL RECORD MODES

SENSITIVITY: HIGH

- TIMER RECORD

ACTIVE: ALL OFF

TIMER: ALL 00: 00 – 24: 00

- MOTION

DETECT: OFF

PRE: 1 sec.

HOLD: 10 sec.

SPOT: OFF

REGION: ALL SET

- SENSOR

DETECT: OFF

PRE: 1 sec.

HOLD: 10 sec.

SPOT: OFF

(10) NETWORK

TYPE: DYNAMIC

PORT: 5800

MNS: DISABLE

SERVER 1 MODE: DISABLE

SERVER 1 IP ADDRESS: 65.60.84.15

SERVER 1 PORT: 300

SERVER 2 MODE: DISABLE

SERVER 2 IP ADDRESS: 221.149.149.117

SERVER 2 PORT: 300

SERVER SITE NAME: SXXXXXX (MAC ADDRESS)

DDNS: DISABLE

SERVER: DISABLE

EMAIL: DISABLE

EMAIL ADDRESS: ALL UNDEFINED

EVENT: ALL DESELECT

INTERVAL TIME: 5 MIN

(11) VIDEO

- CAMERA INPUT

BRIGHTNESS: 128 (Max. 255)

CONTRAST : 128 (Max. 255)

- VGA OUTPUT

BRIGHTNESS: 20 (Max. 40)

CONTRAST : 20 (Max. 40)

SATURATION: 25 (Max. 40)

FAQ

CONTENTS

I CAN NOT LOGIN.....176

I can not login

- ▶ **Please check if the link LED of DVR and LAN port of PC are lit.**

- ▶ **Please check if the IP address on DVR and the PC is identical.**
Check SYSTEM STATUS by pressing STATUS button of DVR
MY IP: xxx.xxx.xxx.xxx
Check Target IP Address by clicking CONF button of PC host program.
TARGET IP ADDRESS: xxx.xxx.xxx.xxx

- ▶ **Please check whether there is a response upon PING test with DVR IP.**
Type "PING -t xxx.xxx.xxx.xxx" in DOS COMMAND window and execute.
(xxx.xxx.xxx.xxx is the DVR IP)
Request timed out → **Check IP address**
Reply from: xxx.xxx.xxx.xxx : Check Port number. Check if other user is using this.

- ▶ **Please check the Port number of DVR and PC is identical.**
Check Port number at MENU-SETUP → SYSTEM → NETWORK IP CONFIG.
PORT: 5800 (on DVR)
TARGET PORT NUMBER: 5800 (on Host Program)

- ▶ **Please confirm the Password of DVR and PC is identical.**
Check Password at MENU → SETUP → SYSTEM → PASSWORD

- ▶ **Please check whether DVR is connected another PC.**
Check SYSTEM STATUS by pressing STATUS button.
FROM: xxx.xxx.xxx.xxx : IP which is presently connected.
MY IP: xxx.xxx.xxx.xxx: DVR is waiting for connection.

- ▶ **Please check whether firewall is installed in the network.**
Ask the network administrator to reconfigure the firewall.

Limited 2Year Warranty

This warranty gives the original purchaser specific legal rights and you may also have other rights, which may vary from state to state. If our products do not function because of any defect in material or workmanship, we will repair it for free for 2 year on parts and labor from the date of original purchase. This warranty does not cover modification, abuse, incidental or consequential damages unless the state of owner's residence specially prohibits limitations on incidental or consequential damages.

How to obtain Factory Service

- Original purchaser must fill out the warranty card and mail it to the factory with the model number, serial number and the date of purchase.
- We will repair or replace, and return the system to the owner under this limited warranty.
- Please pack the system carefully and securely using the original packing materials, and send it prepaid and insured to: **13073 E. 166th St, Cerritos, CA 90703**.
- Please include a check for \$40.00 to cover the cost of return postage and handling. If the system is returned within the warranty period, please include a proof of purchase. If the system is out of warranty, you will receive an estimate of the repair cost for your approval before repair work will be started.

Free Manuals Download Website

<http://myh66.com>

<http://usermanuals.us>

<http://www.somanuals.com>

<http://www.4manuals.cc>

<http://www.manual-lib.com>

<http://www.404manual.com>

<http://www.luxmanual.com>

<http://aubethermostatmanual.com>

Golf course search by state

<http://golfingnear.com>

Email search by domain

<http://emailbydomain.com>

Auto manuals search

<http://auto.somanuals.com>

TV manuals search

<http://tv.somanuals.com>