

# **INSTRUCTION MANUAL**

**Stand-Alone 16Channel**

# **DIGITAL VIDEO RECORDER**

**MODEL DV1670, DV1670D**

**Ver. 010312**



Copyright © 2011 Clover Electronics U.S.A. All Rights Reserved.

# System Users Manual

---

**Version 1.1**

Manual created in summer of 2011. This user manual contains instructions for operations for DVR Unit, Client Application, Mobile Device Application and other helpful tips.

# Table of Contents

## Contents

Table of Contents .....	3
Chapter 1. Preface .....	10
1. About This Guide.....	10
2. Precautions - Before You Start! .....	11
3. Precautions – After Powering On! .....	13
4. Precautions – Routine Maintenance! .....	14
5. Contents of Items Included .....	15
Chapter 2. Hardware Description .....	17
1. Technical Specification.....	17
2. Rear Panel .....	19
3. Rear Port Specification and Connection Examples .....	21
Power input.....	21
VGA (Video Graphics Array) Port .....	21
Main Monitor Output .....	23
SPOT Monitor Output .....	23
Camera Input .....	24
RS-232 Serial Connector.....	24
Optional Alarm Sensor Extension Box .....	26
10-Way Terminal Block .....	27
RS-485 Connections .....	28
Alarm Out.....	29
Sensor Input .....	29
USB Connection .....	32
Ethernet Port.....	32
3. Front Panel.....	36
4. Remote Controller.....	38
Chapter 3. Quick Setup .....	39
1. Placement .....	39

2. Connection .....	39
3. Quick Power On .....	41
4. Initial Boot.....	42
5. Setup Screen .....	43
6. Change Password and Enable Auto Lock .....	44
7. Labeling Camera.....	48
8. Enable Recording .....	49
9. Prepare Network.....	51
Chapter 4. Main Menu (Root Menu) .....	53
1. Main Items. ....	53
2. Sub operational items. ....	54
Chapter 5. The “System” Root Menu Item .....	55
Convention of Menu Tree.....	55
1. The “System” Branch .....	56
2. The “Record” Branch.....	58
3. The “Network” Branch.....	59
4. The “Camera” Branch.....	60
5. The “Display” Branch .....	61
6. The “Alarm” Branch .....	62
Chapter 6. The “Search” Root Menu Item .....	63
1. The “Calendar” Search Branch.....	63
2. The “Event” Search Branch .....	64
3. The “Date / Time” Search Branch .....	65
Chapter 7. The “Backup” Root Menu Item .....	66
1. Calendar, Quick and List Branch .....	66
Chapter 8. The “ER”, “PTZ”, and “Sound” Root Menu Items.....	67
Chapter 9. Systems Section In-Depth .....	68
1. INFORMATION GUI .....	68
Language .....	68
Remocon ID (Remote Controller ID) .....	69
Mouse Sensitivity .....	71
Video Standard.....	71

MAC Address.....	72
Webcode.....	72
Versions.....	72
2. DISK MANAGER GUI .....	73
Adding, installing HDD and other drives.....	73
Installing ODD (Optical Disk Drive).....	74
Configuring HDD1 and HDD2 .....	76
CD / DVD RW.....	77
Overwrite .....	77
Auto Delete .....	77
Error List.....	77
S.M.A.R.T(Disk Management) .....	78
3. DEFAULT SETTING GUI .....	79
Configuring Year/Month/Day .....	80
Configuring Date & Time.....	81
Configuring Daylight Saving Time .....	81
Configuring Time Server.....	82
4. UPGRADE GUI.....	83
5. CONFIGURATION GUI.....	84
Configuration Download.....	84
Configuration Upload.....	85
6. PASSWORD GUI.....	86
Configuring User ID .....	86
Modifying User Information .....	87
Configuring User Authority .....	87
Configuring Network Covert .....	88
7. BUTTON SETTING GUI .....	89
Configuration of audible beep .....	89
Configuration of Auto Key Lock .....	89
Configuration of Emergency Lock .....	90
Chapter 10. Record Section In-Depth .....	91
1. Compression, Resolution, Quality, and Speed of Video .....	91

Video Compression .....	91
Video Resolution .....	91
Video Quality.....	92
Speed of Video .....	92
2. Calculating Storage Required .....	94
4 Channel DVR Storage Reference Chart .....	95
9 Channel DVR Storage Reference Chart .....	96
16 Channel DVR Storage Reference Chart .....	97
3. EVENT RECORDING GUI .....	98
Configuring Pre Recording .....	98
Configuring Event Recording.....	98
4. SCHEDULE RECORDING GUI .....	100
Chapter 11. Network Section In-Depth.....	105
1. About Network Section and Clients .....	105
2. IP ADDRESS GUI.....	106
DHCP (Dynamic Host Control Protocol) .....	106
Transmission Option .....	108
Web Server Port.....	108
3. E-MAIL SETUP GUI.....	110
4. DDNS OPTION GUI .....	112
Built in DDNS Server setup.....	112
DDNSIP.Net example.....	113
5. EMAIL NOTIFICATION GUI.....	120
6. NETWORK FRAME GUI .....	121
Chapter 12. Camera Section In-Depth .....	122
1. CAMERA SETTING GUI.....	122
2. PTZ SETTING GUI .....	123
Additional PTZ setting .....	124
3. CONTROLLER GUI .....	126
4. CAMERA TITLE GUI .....	127
5. PTZ TOURING GUI .....	128
6. SERIAL PORT SETTING GUI .....	129

7. How to operate PTZ camera .....	130
Chapter 13. Display Section In-Depth .....	132
1. OSD GUI.....	132
2.SPLIT / SEQUENCE GUI.....	134
3. TV ADJUSTMENT .....	138
Chapter 14. Event Section In-Depth .....	139
1. SENSOR GUI.....	139
2. ALARM GUI.....	140
3. MOTION DETECTION GUI.....	141
4. SPOT OUT GUI .....	143
5. INTERNAL BUZZER GUI.....	144
6. EXTENDED GUI .....	145
Alarm Sensor extension box setting .....	146
Chapter 15. Search Operation .....	147
1. Getting to Search Screen .....	147
2. Calendar Search .....	148
3. Event Search.....	151
4. Date and Time Search .....	153
5. Playback Control Menu Bar .....	154
Playback Controls.....	154
Play and Pause operation .....	155
Fast Play, Rewind Operation.....	155
Mouse Only Operation.....	157
De-Interlacing Option.....	158
Quick Backup During Playback.....	159
Chapter 16. Backup Operation.....	161
1. Calendar Backup .....	161
2. Backup Viewer .....	167
Chapter 17. Mobile and Remote Client Applications .....	169
1. iPhone .....	169
iPhone Application Installation .....	169
Adding a DVR To Your iPhones MPRMS Application .....	169

Search from iPhone.....	174
Controlling Relay-Out from iPhone.....	177
PTZ control from iPhone .....	177
2. Android Phone .....	179
Program Installation for Android .....	179
Application Execution for Android.....	179
Register the product information for Android.....	180
Modify/Delete of Registered Information for Android.....	181
Remote connection for Android .....	182
Live view on Android.....	183
Main menu view on Android .....	183
PTZ control for Android.....	184
PTZ Preset for Android.....	186
Search on Android.....	187
Relay Out for Android .....	188
Information display option on Android .....	189
End the connection for Android.....	190
3. Windows Mobile .....	191
Install the program to Windows Mobile.....	191
Execute the program for Windows Mobile.....	191
Register the Product Information on Windows Mobile.....	192
Connect / Disconnect on Windows Mobile .....	194
Search on Windows Mobile .....	196
PTZ Control for Windows Mobile.....	197
Remote Alarm Control for Windows Mobile .....	199
4. Internet Explorer Version 7 and later .....	200
Initial Connection .....	200
Display Configuration.....	202





## **Chapter 1. Preface**

This manual contains user instruction on how to operate the Digital Video Recording device (DVR Unit), Remote Controller, Client Application, Mobile Application and Central Monitoring Software Application.

This manual also contains cautions and notification regarding safe operating parameters to protect the equipment and equipment operator. Please read this manual and comply with its suggested guidelines for proper operation of this equipment.

For any further concerns and question please inform sellers for further information.

Please properly retain this copy of the manual for future reference.

### **1. About This Guide**

This guide is comprised of Table of Contents where you will find Chapters divided logically discussing about particular topics. Then it is further divided by sections that discuss more detailed discussion pertaining to certain features of Chapter topics.

This manual also includes Index section where popular subjects or key concepts are referenced by page numbers where those topics are discussed.

What this manual is not discussing are topics about upgrades and repairing physical unit. These should be done through seller's authorized repair centers or by detailed direction from seller. Upgrades and repairs consists of adding and removing Hard Disk Drive, adding and removing other media drive, upgrade or downgrade the Firmware, replace any electronic components inside physical units. These actions should be under the guidance of qualified technician because improper actions may cause permanent damages to the unit. Some drives also have compatibility constraints and they are constantly being updated as new products emerge from drive manufacturers.

**2. Precautions - Before You Start!**

- Item 1. DVR Unit's power setting must be on POWER OFF position before power adapter is plugged into the DVR Unit.

Press down on toggle button towards bottom.

This event will prevent electric spark and prevent possible fire, electrocution and product damages.

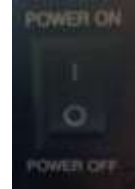

- Item 2. DVR Unit's power setting must be on POWER OFF position before adding cameras, monitor, Hard Disk Drive and other electronic component to DVR Unit.

Cover of the DVR Unit must be closed while DVR Unit is powered on.

All other external devices should be introduced while DVR Unit is turned off.

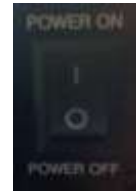

- Item 3. DVR Unit must have about 15 centimeters (about 6 inches) clearance from the wall.

DVR Unit must have 5 centimeters (about 2 inches) clearance for the side of the DVR Unit of any obstructions.



- Item 4. DVR Unit must be installed in none humid place.

Also do not place the DVR Unit near dusty area.

It is also advised that DVR Unit must be away from large power supplies such as power transformers, and also do not install this DVR Unit in closets that does not have temperature control.



Even if DVR Unit may tolerate higher temperature Hard Disk Drives may yield to lower temperature tolerance compared to the DVR Unit.

It is advised that DVR Unit must be kept in standard room temperature whenever possible and any way not to exceed 50C (122F).

**2. Precautions - Before You Start!**

- Item 5. Never uplift the cover to perform an upgrade, attempt a hardware repair while DVR Unit is still powered on.

Users should be aware that taking the cover off from the DVR Unit might void the warranty without consulting with seller.



Improper upgrade may result on permanent equipment failure and user must consult with sellers and their skilled technicians before any upgrade.

- Item 6. Keep the area clean around where DVR Units will be installed.

In case you need to clean the DVR Unit itself, please use dry cloth. DO NOT use any organic solvent. This will damage the DVR Unit and may cause electronics failure if solvent or fumes are exposed to the DVR Unit.



- Item 7. Do not overload the circuit by having multiple devices on one power strip.

Avoid same power circuit input from hair dryer, coffee makers, curling iron, refrigerator or other appliances that may draw concentrated power consumption sporadically.

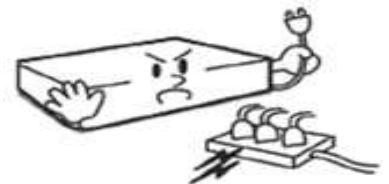

Uninterruptable power devices such as UPS power surge protectors are recommended and at least the DVR DVR Units must be connected properly approved power surge protector.

Input voltage tolerance should be at least 10% of specified voltage level indicated off from included power adapters.

Failure to follow this guideline may cause equipment failure or possibly fire or electrocution.

**3. Precautions – After Powering On!**

- Item 1. If you detect strange odor or detect strange rattling noise immediately turn the DVR Unit's power off.

Please contact your seller or service center for further instruction.



- Item 2. Avoid shock and keep the DVR unit free from vibration.

Constant vibration and sudden shock will possible damage Hard Disk Drive and may cause bad sectors on Hard Disk Drive, dislodged connectors and may even cause damage to the main board.



- Item 3. Make sure any debris does not fall in through ventilation hole.

Also be cautious about other conductive material such as paper clips or other conductive material to have any contact with the main board of the DVR unit.



## 4. Precautions – Routine Maintenance!

- Item 1. Check to see if the LED (Light Emitting Diode) is on.

If DVR unit does not have LED light on please check first if power button is on or off and make sure that it is at POWER ON position.

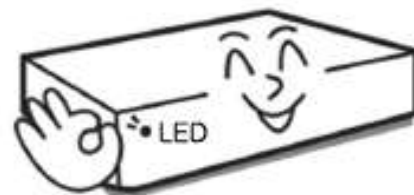

If you still do not see LED light, then please check power adapter and outlet.

- Item 2. Make sure that HDD Overwrite (Hard Disk Drive) is enabled.

If DVR unit does not have HDD Overwrite not enabled HDD will only write video information until HDD's capacity reaches maximum capacity.

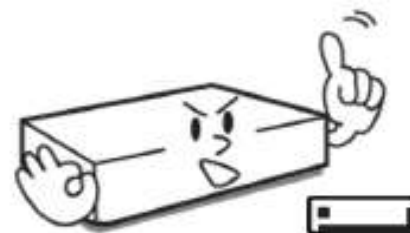

This may result in latest recorded video information not being present in DVR unit.

Chapter 9, Section 2. DISK MANAGER GUI on page 77 covers more details about setting HDD Overwrite option.

- Item 3. Hard Disk Drive is the only moving devices found on DVR unit. As with many moving devices users must pay special attention to the wellness and optimal functionality of such devices. Your HDD is where video information is kept for future review.

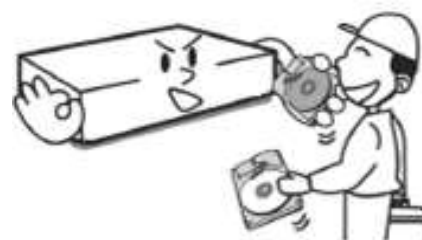

In the DVR unit there are HDD S.M.A.R.T. features that monitor the wellness of HDD disk itself. The S.M.A.R.T displays the current hard drive condition and temperature of the hard disk drive. The S.M.A.R.T is abbreviated from Self-Monitoring, Analysis, and Reporting Technology, where hard disk manufacturers have implemented to warn possible failing condition of hard disk drive. It recommended that HDD with bad sectors, broken images when video images are played back, hear clicking noise, and DVR unit indicating that it is no longer recording video, then it may well be that there are defective HDD in DVR unit.

Please contact your seller or their authorized repair center for further instruction.

Later in this manual Chapter 9 section "S.M.A.R.T(Disk Management)" pages 78 will explain more about HDD S.M.A.R.T. features.

**5. Contents of Items Included**

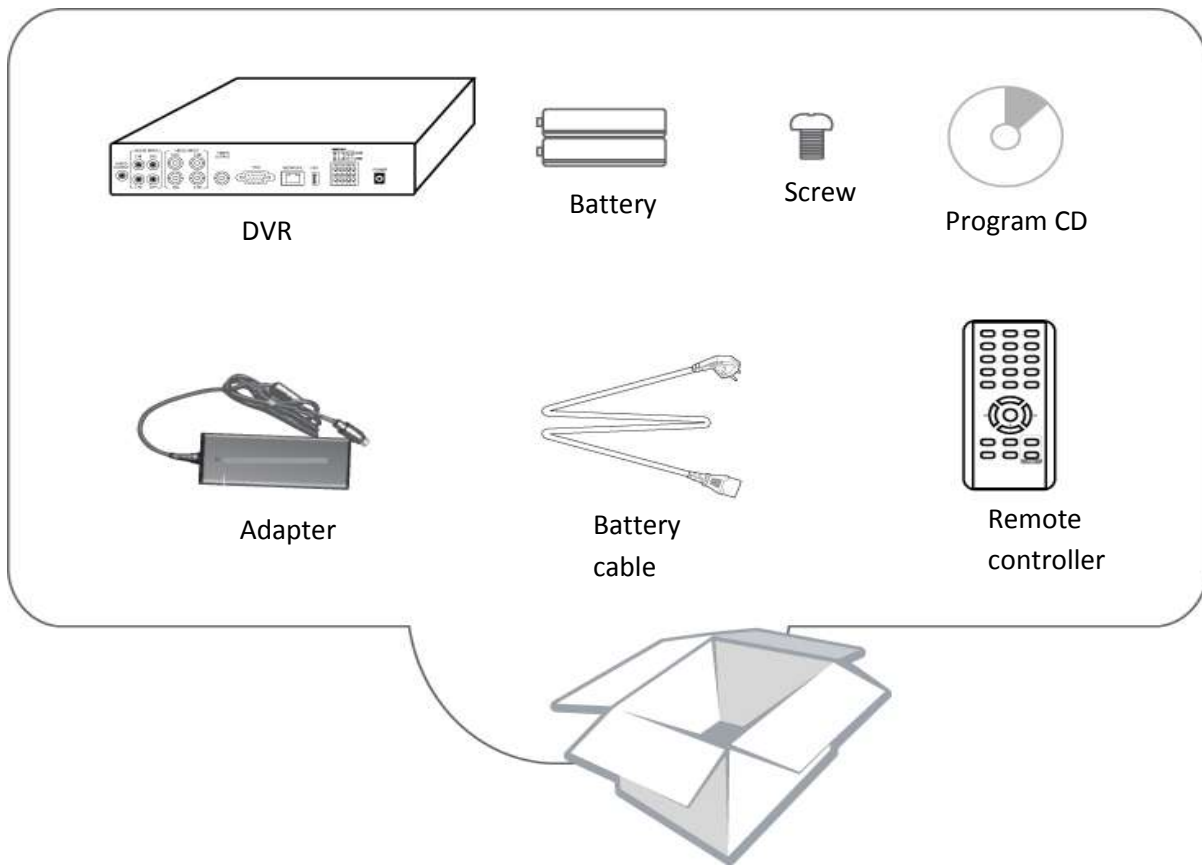

Component	Description
DVR	Stand Alone Digital Video Recorder
Battery	1.5V (AAA) 2 pcs.
Screw	For HDD mounting
Program CD	Manual and Client program
Adapter	DC 12V 5A
Power cable	Power cable
Remote controller	For DVR operation

\*If you are missing any components listed above please contact your seller for further instruction.



## Chapter 2. Hardware Description

### 1. Technical Specification

Operating System: Embedded Linux

Video Recording Compression: H.264

Video Transmission Compression: H.264

Supported Video Standards: NTSC / PAL

Video Output: Composite (main monitor output) via BNC  
VGA monitor via VGA port  
TV connection via S-Video  
SPOT monitor via BNC  
One to one video loop-out via BNC (equal number as camera input)

Audio Input: Single Mono RCA, 1Vpp, 10k ohm

Audio Output: Four Mono RCA, 1Vpp, 10k ohm

Audio Compression: G723.1

Sensor Input: Four sensor input ports via pluggable 10-way terminal block

Alarm Output: Single alarm output port via pluggable 10-way terminal block

Communication:

RS-485 Port – Single TX(+), single RX(-) via pluggable 10-way terminal block

RS-232 Port – 9 pole D-Type male connector

Ethernet Port – RJ-45 Type 10/100/1000 Base-T, DHCP, Static IP and DDNS

Recording Resolution:

NTSC – CIF(352X240), 2CIF(704X240), D1(704X480)

PAL – CIF(352X288), 2CIF(704X288), D1(704X576)

Recording Frame Speed per second:

4ch DVR – CIF resolution 120 frames per second at NTSC (100 fps at PAL)  
2CIF resolution 120 frames per second at NTSC (100 fps at PAL)  
D1 resolution 120 frames per second at NTSC (100 fps at PAL)

9ch DVR – CIF resolution 270 frames per second at NTSC (255 fps at PAL)

2CIF resolution 240 frames per second at NTSC (200 fps at PAL)  
D1 resolution 120 frames per second at NTSC (100 fps at PAL)

16ch DVR – CIF resolution 480 frames per second at NTSC (400 fps at PAL)  
2CIF resolution 240 frames per second at NTSC (200 fps at PAL)  
D1 resolution 120 frames per second at NTSC (100 fps at PAL)

Recording Mode: Emergency, Schedule, Sensor, Motion, Sensor + Motion, Pre and Post Alarm Recording

Recording Search Method Type:

Calendar Search, Date and Time Search, Event List Search, First Search (Oldest recording not over written in HDD), Last Search (Newest recording in HDD)

Search Speed:

Forward – Normal Speed, 2X, 4X, 8X, 10X fast forward play  
Rewind – Normal Speed, 2X, 4X, 8X, 10X fast rewind play

\* 10X fast forward and fast rewind are shown as MAX indication.

Disk Drive Connection:

2 SATA HDD port  
1 SATA optical drive port  
\*only may use 2 ports at any given time. (1 HDD + 1 optical or 2 HDD)

System Control:

Frontal key buttons (\*Included)  
USB mouse operation (\*Included)  
IR battery operated remote controller (\*Included)  
External DVR key controller via RS-232 (\*Optional)

Operating Temperature: 32°F ~ 104°F (0°C ~ 40°C)

Dimension:

Unit – 16.9in (W) X 2.12in (H) X 12.4 (D) or 430mm (W) X 54mm (H) X 315mm (D)  
Outer Box – 18.5in (W) X 8in(H) X 20.5in (L) or 470mm (W) X 203mm(H) X 521mm (L)

Weight:

Unit only – 7.7 lbs (US) or 3.5kg  
Unit with 2 HDD – 10.5 lbs (US) or 4.77kg  
Unit with 1 HDD and 1 ODD – 10.9 lbs (US) or 4.94kg  
Product box without unit – 4.96 lbs (US) or 2.25kg  
Unit with 1 HDD and 1 ODD, product box and accessories – 15.86 lbs (US) or 7.19kg

*\*Some drive manufacturer weight will vary. It is always safe to add 1 or 2 lbs or physically measure before shipping.*

**2. Rear Panel**

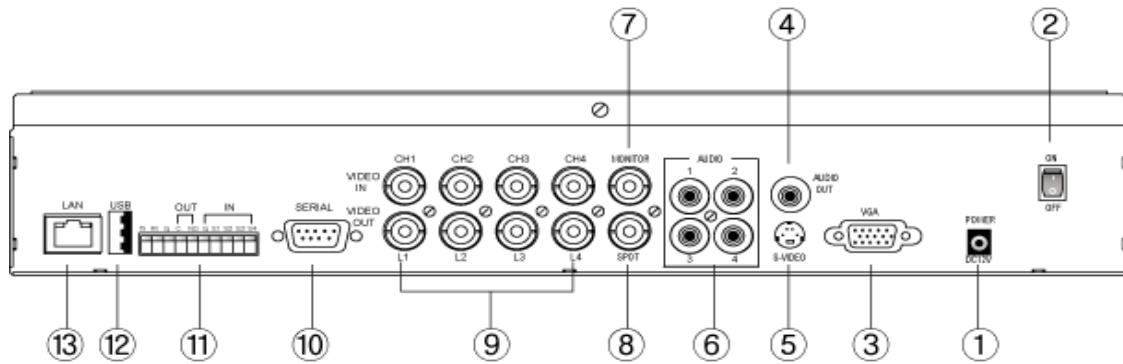

Figure 1 (4ch Model)

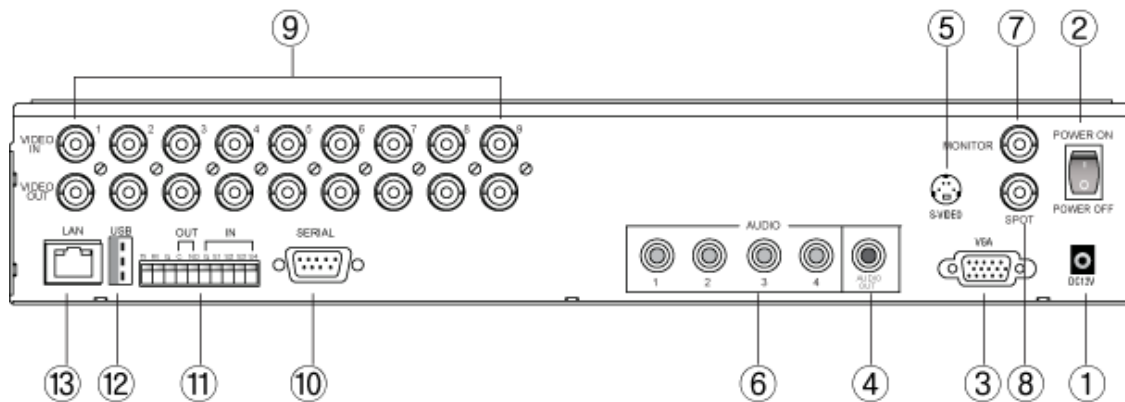

Figure 2 (9ch Model)

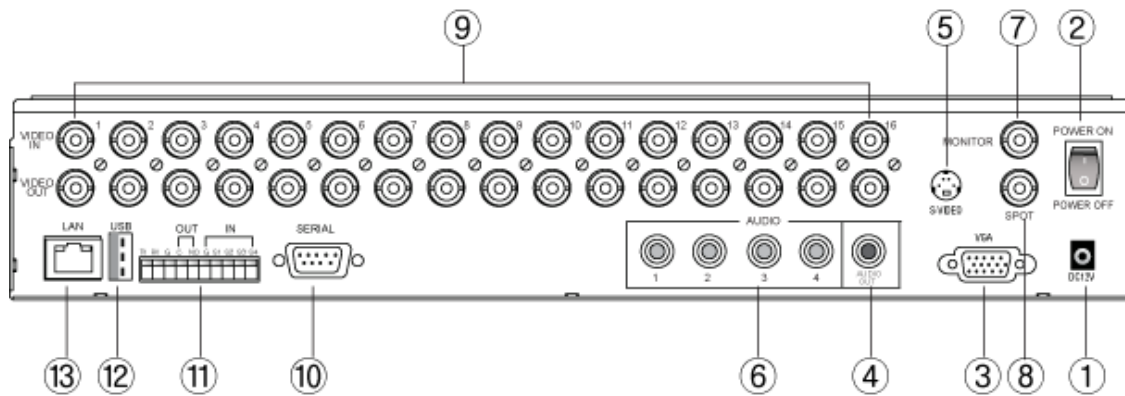
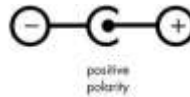

Figure 3 (16ch Model)

- ① Power input – connection port for DC 12 volt
- ② Toggle Power Switch – POWER ON and POWER OFF switch that turns unit on and off
- ③ VGA (Video Graphics Array) Port – Location where VGA monitor cable must be inserted
- ④ Audio Out – Mono RCA, 1Vpp, 10k ohm
- ⑤ S-Video – S-Video out connection
- ⑥ Audio Input – Mono RCA, 1Vpp, 10k ohm, available in 4 channels
- ⑦ Main Monitor Output – BNC main monitor output
- ⑧ SPOT Monitor Output – Secondary monitor output for public display
- ⑨ Camera Input / Video Loop Out – Analog Type BNC camera plug-in location and video loop out
- ⑩ Serial Connection – 9 pole D-Type male connector
- ⑪ PTZ, Sensor, Alarm Out Port – Single TX(+), single RX(-), 1 Alarm out, 4 Sensor In via pluggable 10-way terminal block
- ⑫ USB Port – Connection for USB mouse or for small USB memory device
- ⑬ Network Port – Ethernet port

### 3. Rear Port Specification and Connection Examples

#### **Power input**



Input at 12 volt DC with positive polarity at 5 Amp

[Please refer to the Figure 1 (4ch Model), Figure 2 (9ch Model), Figure 3 (16ch Model) item marked “①” Power input].

#### **VGA (Video Graphics Array) Port**

VGA port uses D-subminiature or D-sub, DE-15F (E rated sized D-Sub with 15 pin Female) port.

Connect a VGA monitor to the DVR with a standard VGA Cable. We recommend using a 17” LCD or CRT monitor or above.

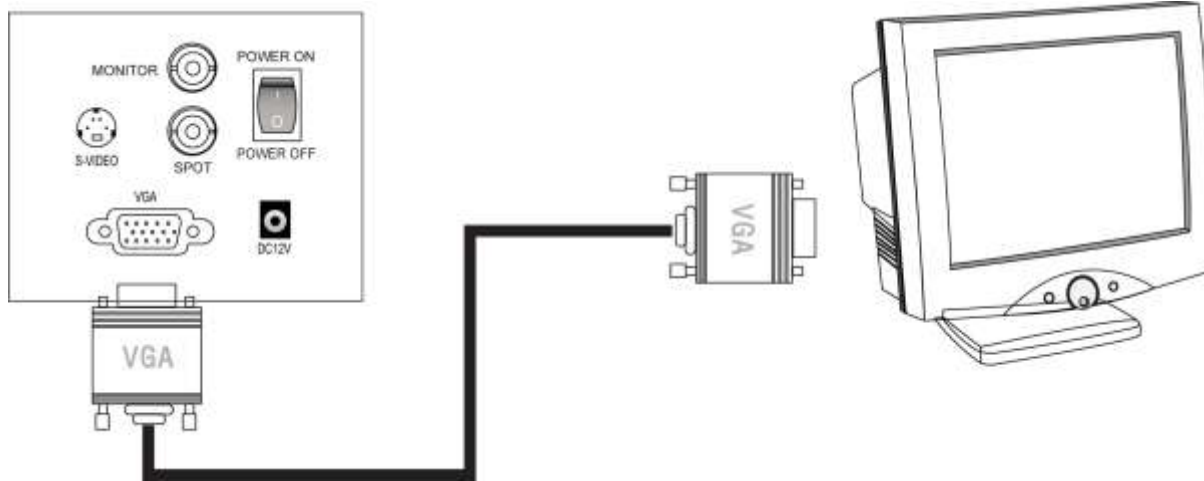

Figure 4 VGA Connection Configuration

Supported resolutions for the VGA ports are:

800x600 @ 60Hz/75Hz

1024x768 @ 60Hz/75Hz

1280x1024 @ 60Hz/75Hz

*\*All resolutions display at True Color 32 Bit*

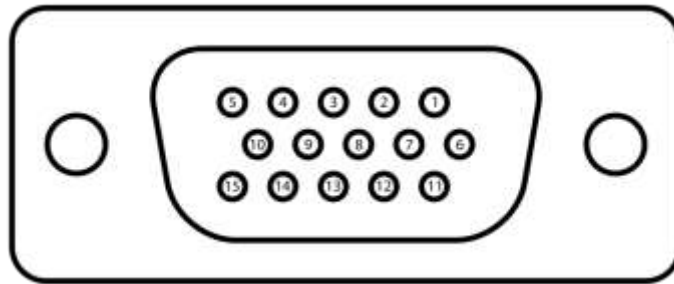

Figure 5. VGA Pin Configuration

[Please refer to the Figure 1 (4ch Model), Figure 2 (9ch Model), Figure 3 (16ch Model) item marked “③” VGA Port].

VGA Pin Configuration Table

Signal Type	Pin Number	Description
RED	1	Red video (75 ohm, 0.7 V p-p)
GREEN	2	Green video (75 ohm, 0.7 V p-p)
BLUE	3	Blue video (75 ohm, 0.7 V p-p)
RES	4	Reserved
GND	5	Ground
RGND	6	Red ground (Red return)
GGND	7	Green ground (Green return)
BGND	8	Blue ground (Blue return)
KEY / PWR	9	Key (not used) / +5V DC
SGND	10	Sync ground
ID0	11	Monitor ID bit 0
SDA	12	Bidirectional data line
HSYNC or CSYNC	13	Horizontal or Composite Sync
VSYNC	14	Vertical Sync and data clock
SCL	15	Data clock

Table 6 VGA Pin Configuration

**Main Monitor Output**

BNC (Bayonet Neil Concelman or British Navel Connector) type 75 ohm.

Connect a monitor that supports BNC Inputs or use a “BNC Twist Lock” to Composite Video adapter if your monitor only supports Composite Video Inputs.

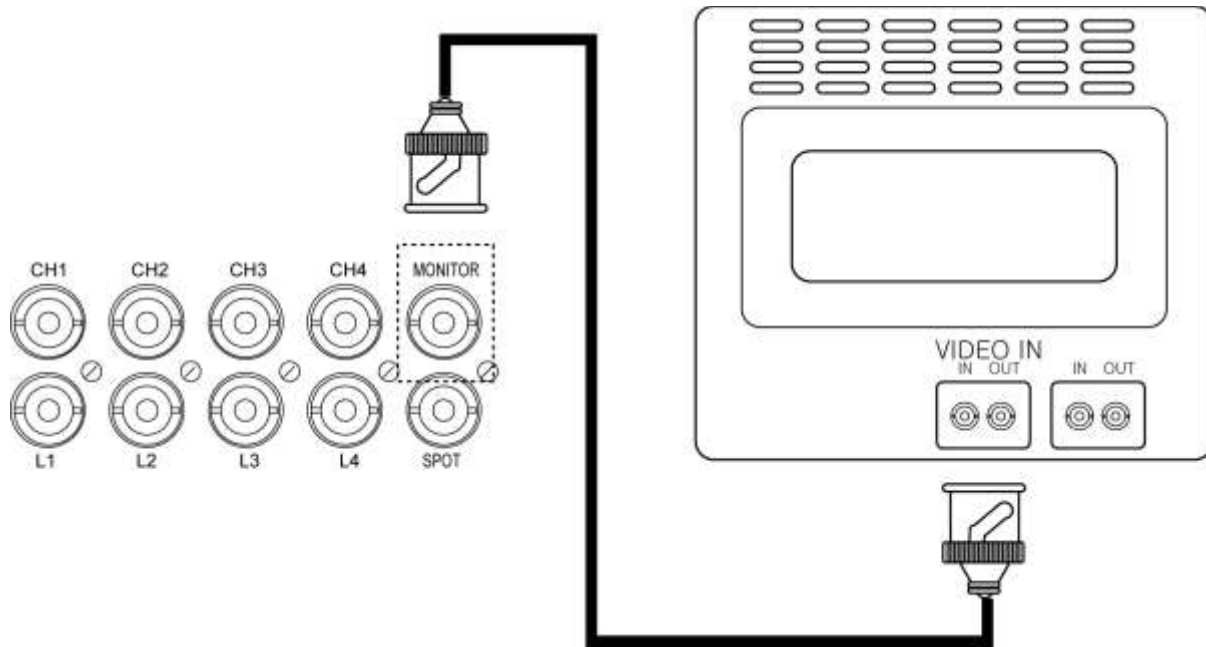

Figure 7 Main Monitor Connection

The display resolution for Monitor is at 720x480.

[Please refer to the Figure 1 (4ch Model), Figure 2 (9ch Model), Figure 3 (16ch Model) item marked “(7)” Main Monitor Output].

**SPOT Monitor Output**

BNC (Bayonet Neil Concelman or British Navel Connector) type 75 ohm.

Connect a monitor that supports BNC Inputs or use a “BNC Twist Lock” to Composite Video.

The display resolution for Monitor is at 720x480.

[Please refer to the Figure 1 (4ch Model), Figure 2 (9ch Model), Figure 3 (16ch Model) item marked “(8)” SPOT Monitor Output].

**Camera Input**

The camera connections are the input ports for the video signal(s) used with the DVR. You may use any video source (75ohm) that outputs via a BNC connector (Twist Lock Type). If your video source outputs via RCA/Composite video, the proper adapter must be used when connecting the cable to the camera connection input port(s) of the DVR. Both NTSC and PAL signals are automatically detected by the DVR and requires no further configuration.

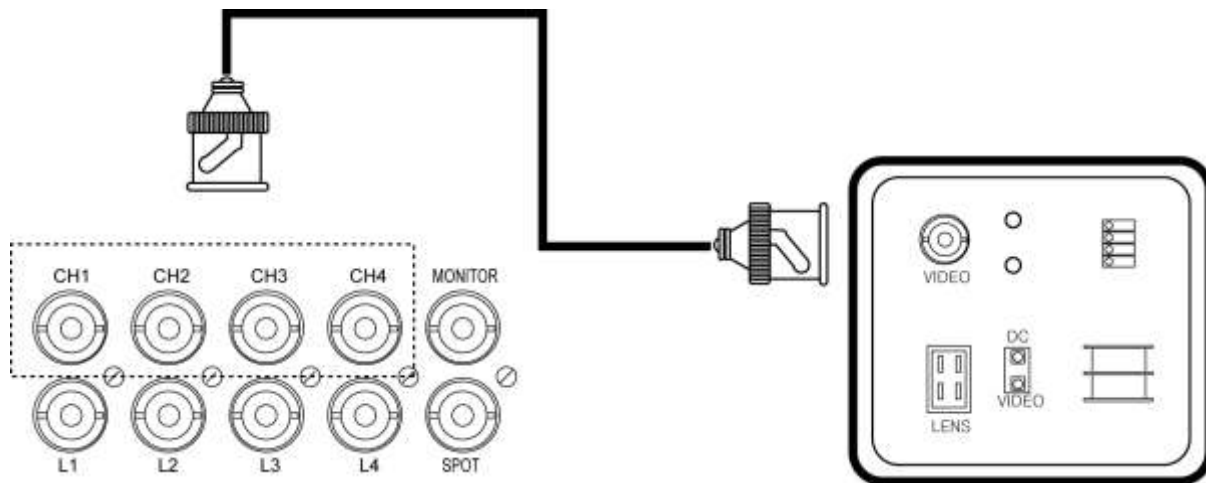

Figure 8 Camera Connection

Connect the cameras to the Video In ports located on the rear panel of the DVR using the proper cables and connectors (BNC Twist Lock). The corresponding video channels can be “looped” out using the “loop out” ports located beneath each video input port. There is no need for terminators to be installed, each port is self terminated. Both NTSC and PAL signals are automatically detected by the DVR and requires no further configuration.

[Please refer to the Figure 1 (4ch Model), Figure 2 (9ch Model), Figure 3 (16ch Model) item marked “⑨” Camera Input / Video Loop Out].

**RS-232 Serial Connector**

RS-232 port uses D-subminiature or D-sub, DE-9M (E rated sized D-Sub with 9 pin Male) port.



## Chapter 2. **Hardware Description**

### **3. Rear Port Specification and Connection Examples**

The RS-232 COM port is used to connect the DVR to a PC (optional updating procedure) or to connect an external device like a DVR controller (optional). The required settings to use the RS-232 port can be configured in the DVR settings.

Connection Type: 9 pole D-Type male connector

Maximum Input Voltage: +/- 25V

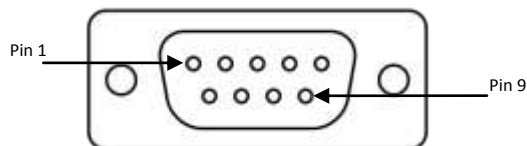

Figure 9 DE-9M Serial Port

[Please refer to the Figure 1 (4ch Model), Figure 2 (9ch Model), Figure 3 (16ch Model) item marked “⑩” Serial Connection].

RS-232 / DE-9M Serial Port Pin Configuration Table

Signal Type	Pin Number	Description
DCD In	1	Carrier Detection Signal (not used)
Rx	2	RS232 Receive
Tx	3	RS232 Transmit
N/C	4	No Connection
GND	5	System Ground
N/C	6	No Connection
RTS	7	RS232 Request To Send Signal
CTS	8	RS232 Clear To Send Signal
N/C	9	No Connection

Table 10. RS-232 pin configuration

**Optional Alarm Sensor Extension Box**

There is optional Alarm Sensor Extension Box that connects to RS-232 port provided in our DVR unit.

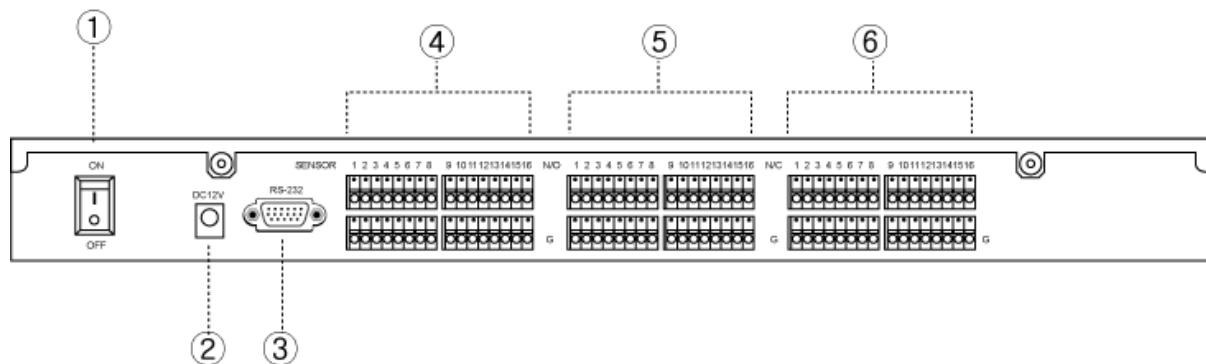

- ① Power switch
- ② Power adaptor connector
- ③ RS-232 port (Port connected to the system)
- ④ Sensor input (1~16)
- ⑤ Normal Open alarm output : 1~16
- ⑥ Normal Close alarm output : 1~16

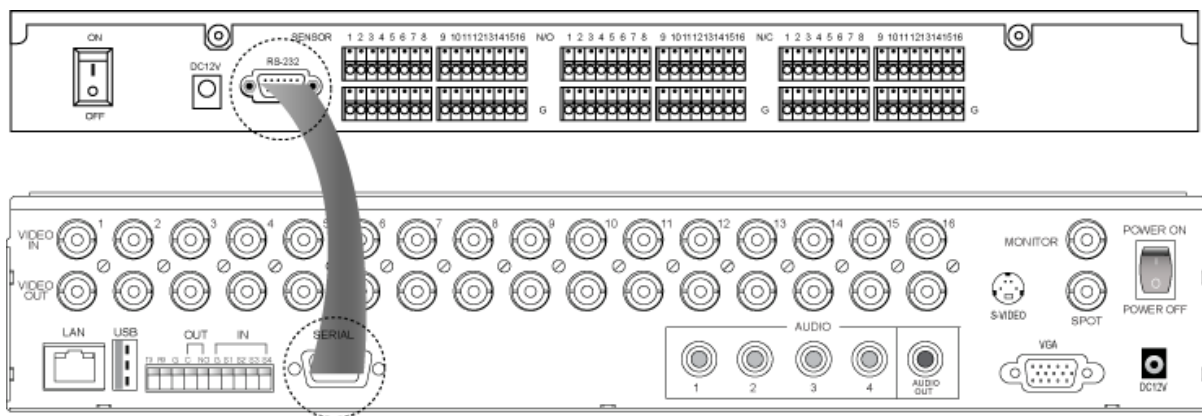

Figure 11 Connection Example of Extension Box

Sensor 1~16 inputs functions same as the S1~S4 inputs (see next section in 10-way terminal Block). Difference is that every port is issued with its own ground connection located right below. Additionally there are 16 NO (Normally Open) dry contact points with dedicated ground and 16 NC (Normally Closed) dry contact point with dedicated ground per points. These NO, NC points are used in Access control integration.

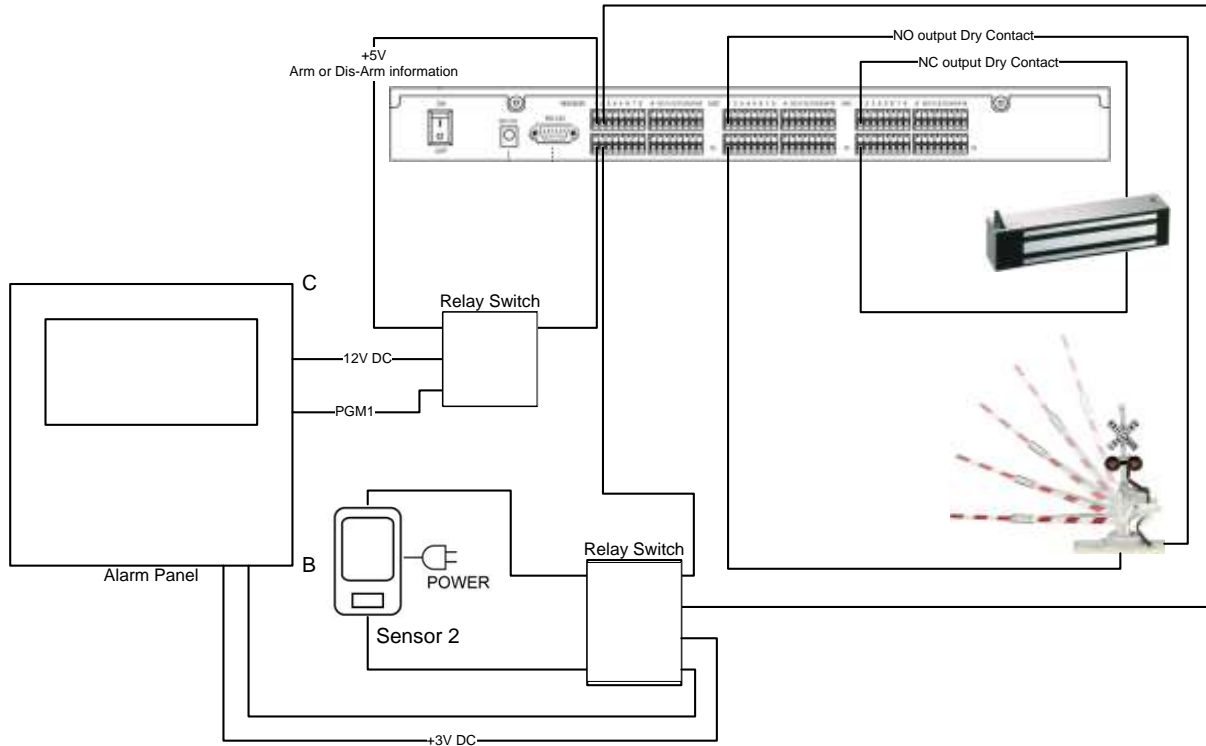

Figure 12 Alarm Sensor Extension Box Wire Example

**10-Way Terminal Block**

There are RS-485, Alarm Output, and Sensor Input (1 to 4 Sensor) all located in 10-Way Terminal Block.

Signal Type	Pin Number	Description
Tx	1	RS-485 Transmit
Rx	2	RS-485 Receive
G	3	Ground (RS-485)
C	4	Common (Ground for Alarm Out)
NO	5	Normally Open (Alarm Out)
G	6	Ground (Sensor)
S1	7	sensor connection port 1
S2	8	sensor connection port 2
S3	9	sensor connection port 3
S4	10	sensor connection port 4

Table 13. 10-Way terminal block pin-out

## Chapter 2. **Hardware Description**

### 3. **Rear Port Specification and Connection Examples**

Specification for 10-Way terminal block

Rated current: 8A

Contact resistance: 20m

Insulation resistance: 5000M/1000V

Withstanding Voltage: AC1500V/1Min

Wire range: 18AWG 1mm<sup>2</sup>

Mechanical

Temp. Range: -40°C~+105°C

MAX Soldering: +250°C for 5 Sec.

Strip length: 5-6mm

Alarm Out Voltage: 5vt

[Please refer to the Figure 1 (4ch Model), Figure 2 (9ch Model), Figure 3 (16ch Model) item marked “⑪” PTZ, Sensor, Alarm Out Port].

#### **RS-485 Connections**

The RS-485 ports are used to connect external PTZ cameras to the DVR. There is single available port with this DVR. External controllers may be used, however you will not have the ability to control the PTZ cameras remotely if you do so.

There are single RS-485 communications ports, these ports are used to connect external PTZ camera controllers.

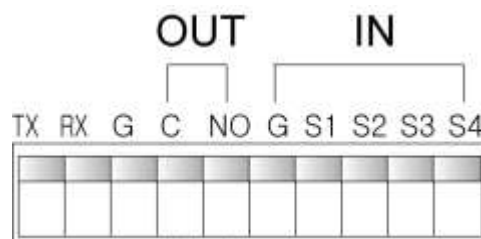

Figure 14 10-Way terminal block

### **Warning**

“S1~S4” port emits +5 volt current out from its ports. Some alarm panels may be damaged if improper voltages are introduced. Please consult your alarm panel documentation for application requiring such connection.

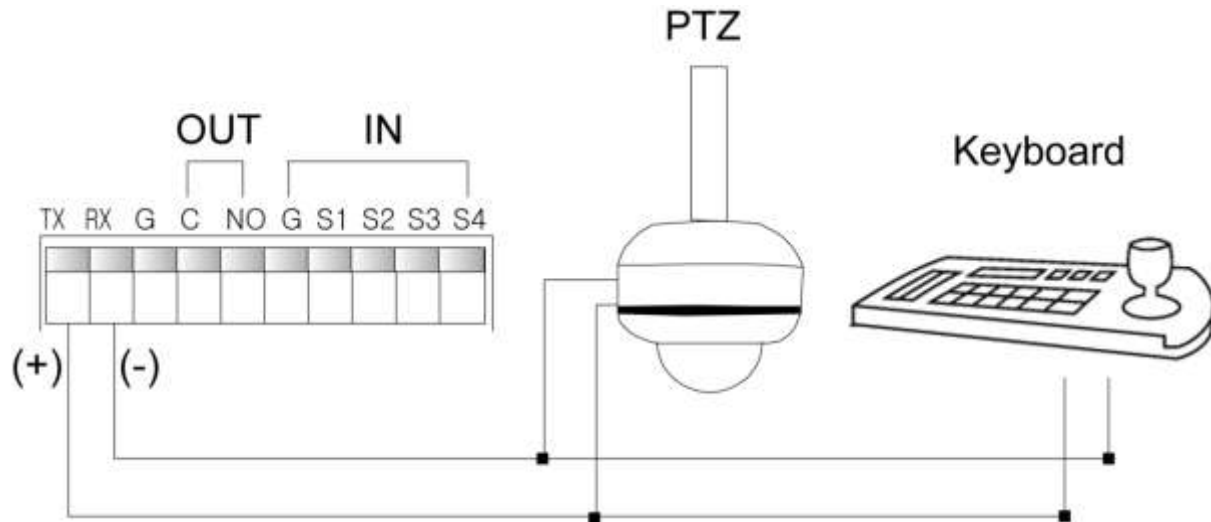

Figure 15 PTZ and Keyboard in RS-485

**Alarm Out**

Connecting the alarm out:

Each alarm output can be controlled/switched by DVR unit and its application software. Each device must be wired to C (Common) and NO (Normally Open). It passes no voltage (dry contact)

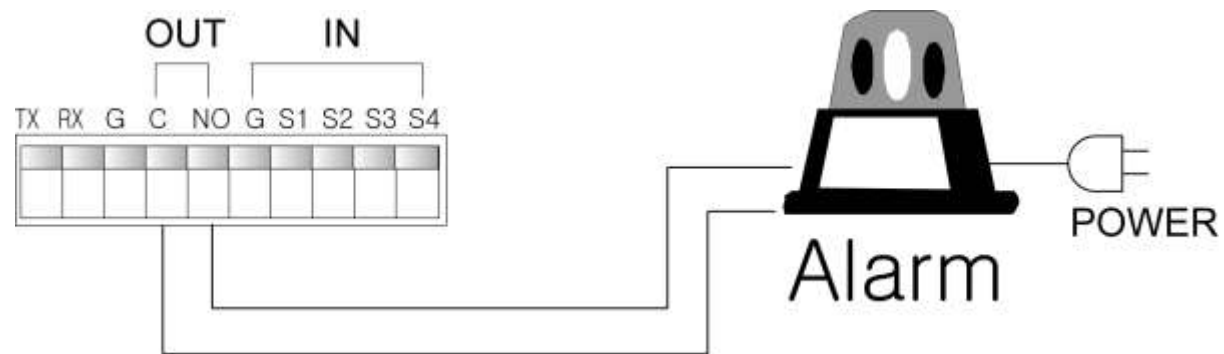

Figure 16 Alarm Out

**Sensor Input**

Connecting the Inputs:

Each alarm input can be controlled/switched by a device such as a motion/IR sensor, door contact sensor, and similar devices. Each device can either be wired as N/O or N/C (Normally Open/Normally Closed).

Specifications:

Alarm Input: +5v

## Chapter 2. Hardware Description

### 3. Rear Port Specification and Connection Examples

Input Voltage Range: -5VDC (minimum) to 40VDC (maximum)

#### Example 1. Dry contact sensor direct to DVR

This example is the simplest form of sensor connection for DVR unit. Sensors dedicated only for the function for the DVR and example below depicts that Motion Sensors are not outputting any type of voltage (dry contact).

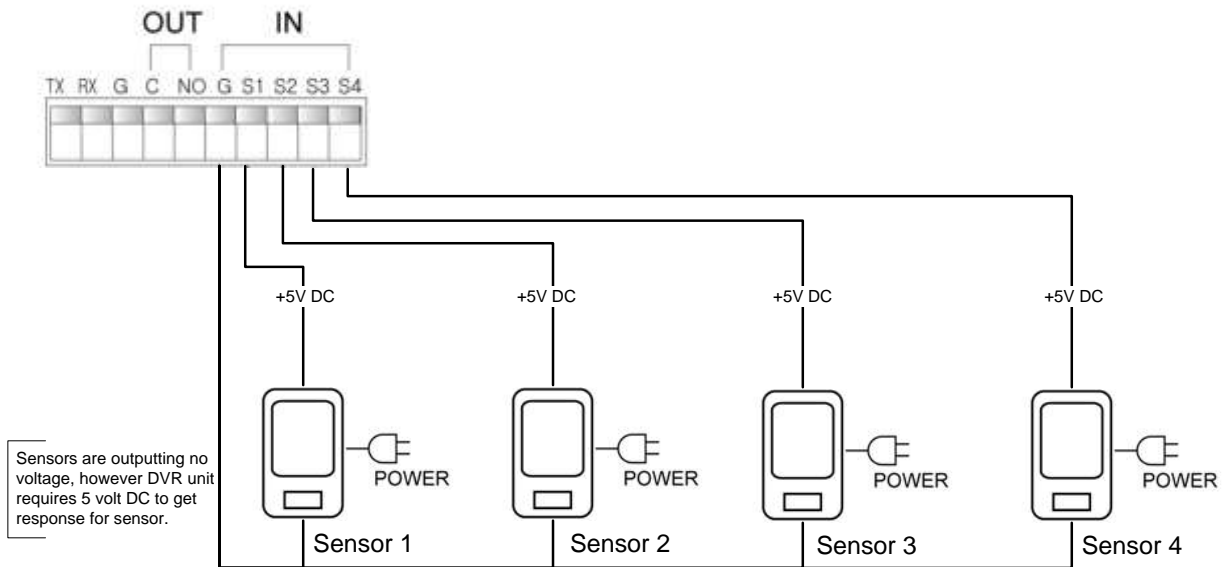

Figure 17 Basic Sensor Connection

#### Example 2. Dry contact and 12 Volt DC combination direct to DVR

For some installation you may have sensors outputting different voltage that may require voltage conversion device.

## Chapter 2. Hardware Description

### 3. Rear Port Specification and Connection Examples

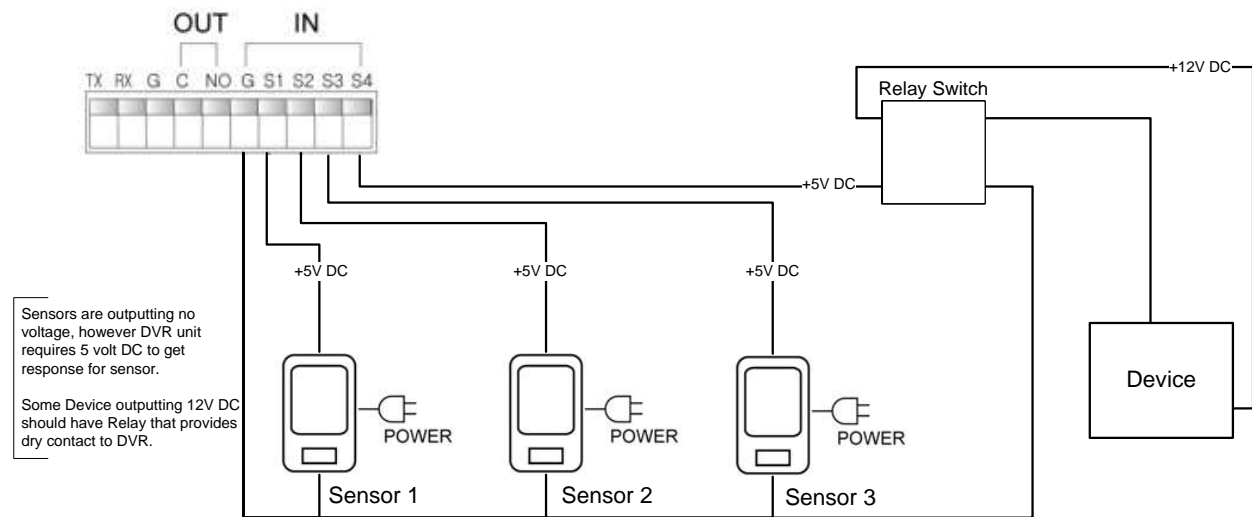

Figure 18 Sensor input with 3 volt DC

#### Example 3. Alarm panel integration with Dry and Wet sensor.

Dry sensors (sensors with no voltage) and Wet sensors (sensors that put out voltage) are readily available to be used with our DVR unit.

Most of the alarm panel that exist today requires some type of Direct Current Voltage from sensors and it also has programmable relay-out connection called PGM available to alarm panel. PGM is used to follow programmed conditions in alarm panel (EX: if smoke detector is sensed then send the signal to fire department and trip 12 volt DC to PGM output where DVR unit will receive the such event through relay switch. It is critical that voltage regulating relay board to be introduced in this type of installation or else DVR unit will be damaged by introducing higher voltage to the unit.)

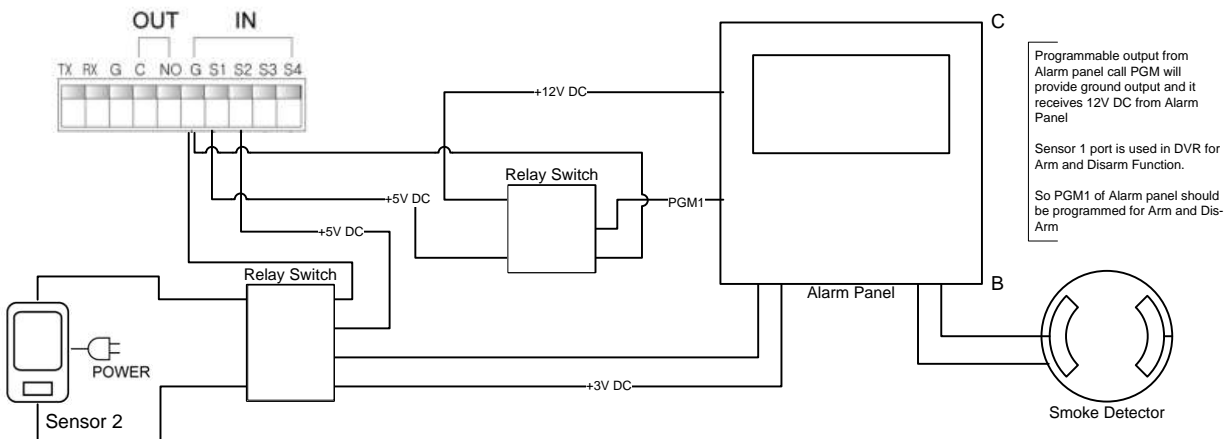

Figure 19 Alarm Panel and Sensor Example

### **USB Connection**

The USB connection ports are used for both back up and mouse control purposes. Either port can be used for back up via USB memory stick or for mouse control. A third option for the two USB ports are for firmware updating procedures. You will only need to use one port for firmware updates.

Two USB ports are located one front side of the DVR and the other in rear side of the DVR. These ports may be used for both USB mouse connection and for USB memory stick back up procedures

[Please refer to the Figure 1 (4ch Model), Figure 2 (9ch Model), Figure 3 (16ch Model) item marked “⑫” USB Port].

### **Ethernet Port**

The RJ-45 port is used to connect the DVR to a network through a DTE (Data Terminal Equipment) device such as a switch or router with an integrated switch. To connect the system to a network please use a standard RJ-45 cable (patch/straight through) and make sure both ends of the cable are securely connected to the proper ports. Consult your local IT administrator for detailed configuration procedures and setup. The maximum cable length for Category 5e, RJ-45 cable is 100 meter or 300 feet.

#### Ethernet Specifications

Connection: 10/100/1000 Base T, IEEE 802.3  
Differential signal voltage:  $\pm 2.8$  V maximum, inputs have transient overvoltage protection

Ethernet port details: IEEE 802.3/802.3u - 10Base-TX/10Base-T physical layer

Auto negotiation: 10/100, full/half duplex

Cable length: 100 meters (100 ohm unshielded twisted pair cable or 150 ohm shielded twisted pair cable, category 5 or higher).

Impedance: built-in compensation for impedance matching

Indicators: ACT, 10/100



## Chapter 2. **Hardware Description**

### **3. Rear Port Specification and Connection Examples**

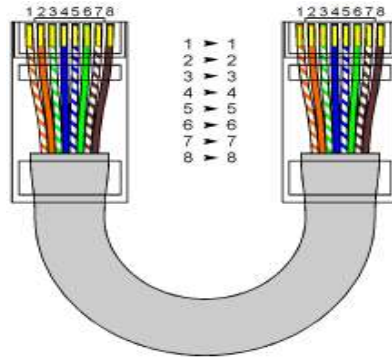

Figure 20 Ethernet Cable Color Code

#### EIA/TIA E568B Configuration

Signal Type	Pin Number	Description
LAN Tx+	1	Ethernet Transmit Positive
LAN Tx-	2	Ethernet Transmit Negative
LAN Rx+	3	Ethernet Receive Positive
Not Used	4	Not Used
Not Used	5	Not Used
LAN Rx-	6	Ethernet Receive Negative
Not Used	7	Not Used
Not Used	8	Not Used

Figure 21 Ethernet Pin Configuration

#### Example 1. Direct connection using cross over cable

This type of connection is used mostly for testing the DVR unit and for simple and short cable connection. Since there is no devices providing DHCP services you must fix your IP address to static IP address (discussed on Chapter Chapter 11. Network Section In-Depth from page 105) to your DVR as well as your PC. If this is not done properly, then there connectivity of the unit to the PC will not happen.

## Chapter 2. Hardware Description

### 3. Rear Port Specification and Connection Examples

First you must use cross over network cable. This is a cable created with crossing pin 1 to 3, 2 to 6 then pin 3 to 1, 6 to 2.

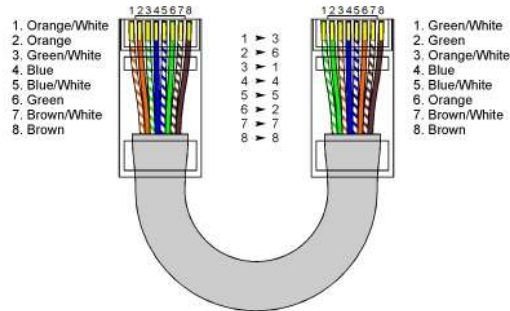

Figure 22 Cross Over Cable

You may now connect directly into PC and DVR unit to communicate directly. Your DVR gateway address and PC's gateway address must be same address. Then you must assign TCP/IP address that belongs to same subnet address as DVR and PC.

Example IP address for DVR

DVR TCP/IP address: 192.168.0.2

DVR's subnet: 255.255.255.0

DVR's gateway: 192.168.0.1

PC's TCP/IP address 192.168.0.3

PC's subnet: 255.255.255.0

PC's gateway: 192.168.0.1

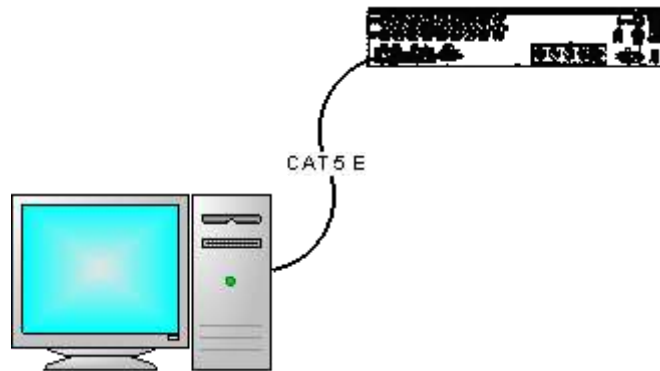

Figure 23. Direct PC Connection

#### Example 2. Connecting DVR unit to Router

This is most common connection for DVR it is advised that your DVR follow the rules of network policy (Please consult with your network administrator).

In this example we are going to assume that router is giving (leasing) TCP/IP address. When router is giving TCP/IP address to the unit this action is possible via Dynamic Host Control Protocol otherwise known as DHCP.

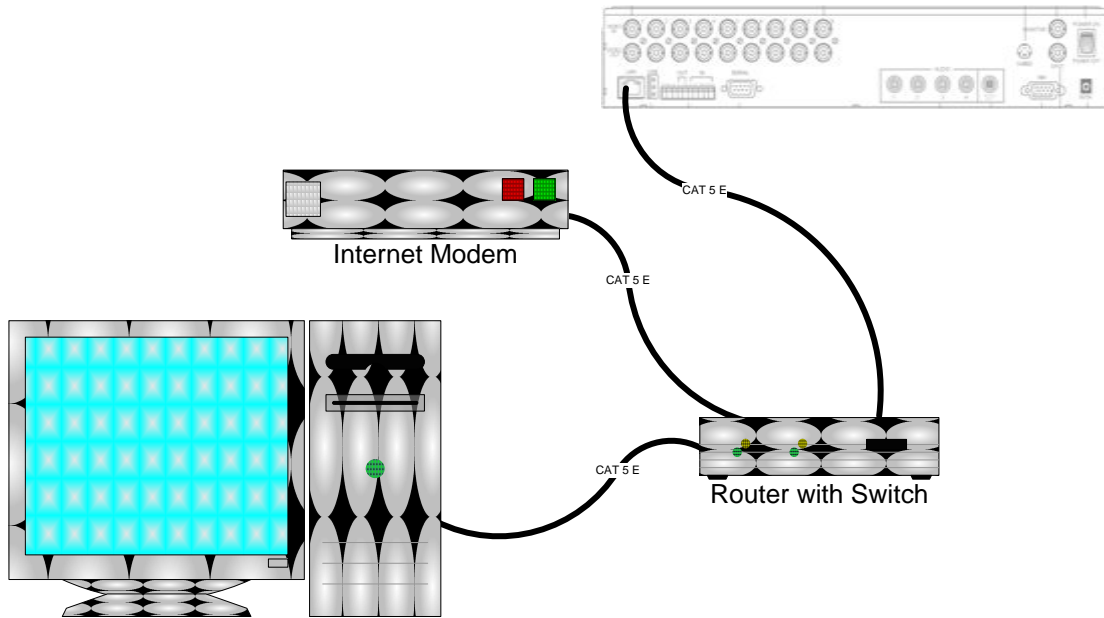

Figure 24 Modem and Router Configuration

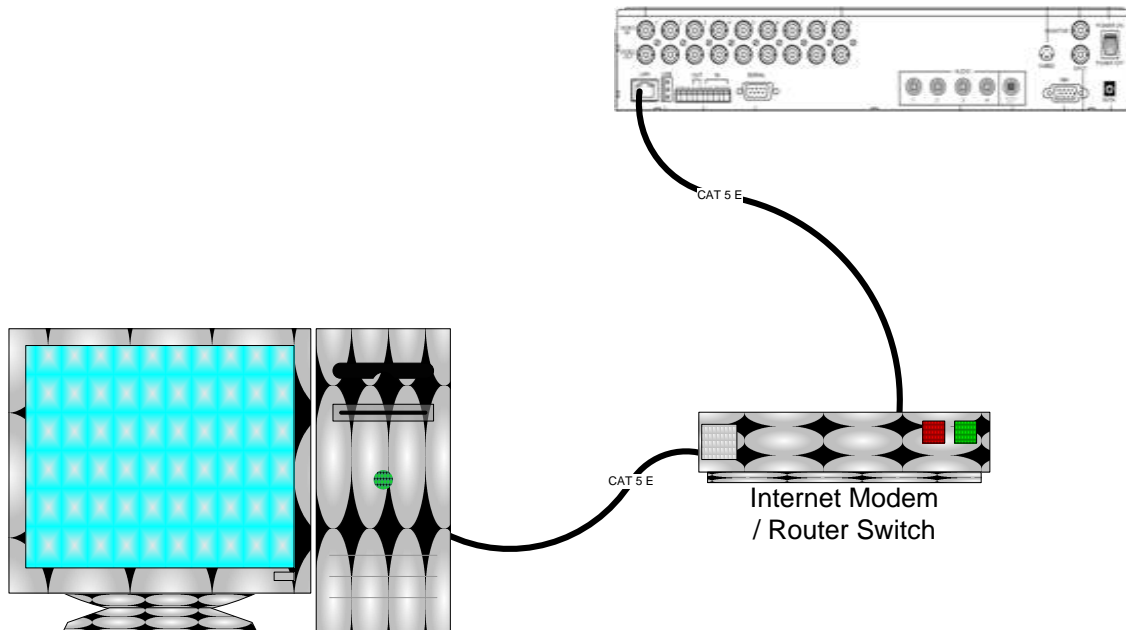

Figure 25 Internet Modem with Router Switch

**3. Front Panel**

Figure 26 Front Panel

No.	Button	Description
①	Directional Button	Use as Control button in Setup Menu (move up, down, left, right)
		Use as Control button in Playback (Pause, Play, Stop, Rewind, Fast Forward)
②	Menu	Call the setup menu. Move to previous step in setup menu.
③	PTZ	Call the PTZ menu
④	Audio	Call the Audio menu
⑤	Backup	Call the Backup menu
⑥	Numeric Buttons	Select a channel or enter a number.
⑦	LED	The status of Power, Record, Network, Schedule and Emergency.
		Search   Call the Search Menu
		QUAD   Change a split mode
⑧	Function Buttons	SEQ   Start sequential display
		Schedule   Switch to schedule record mode.
		Emergency   Switch to Emergency record mode

- ⑨ Front USB Port Connect a USB mouse or USB drive.
- ⑩ ODD Optional ODD is able to install.

**4. Remote Controller**

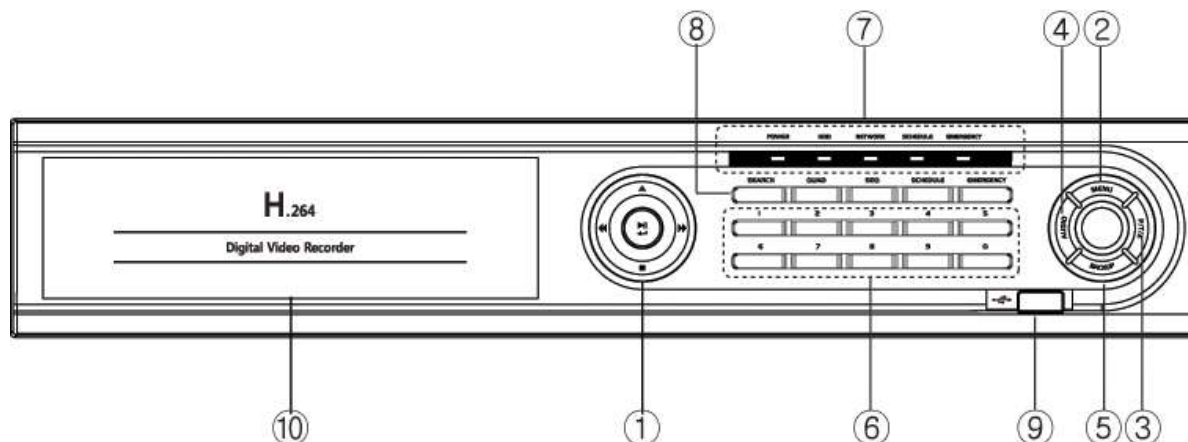
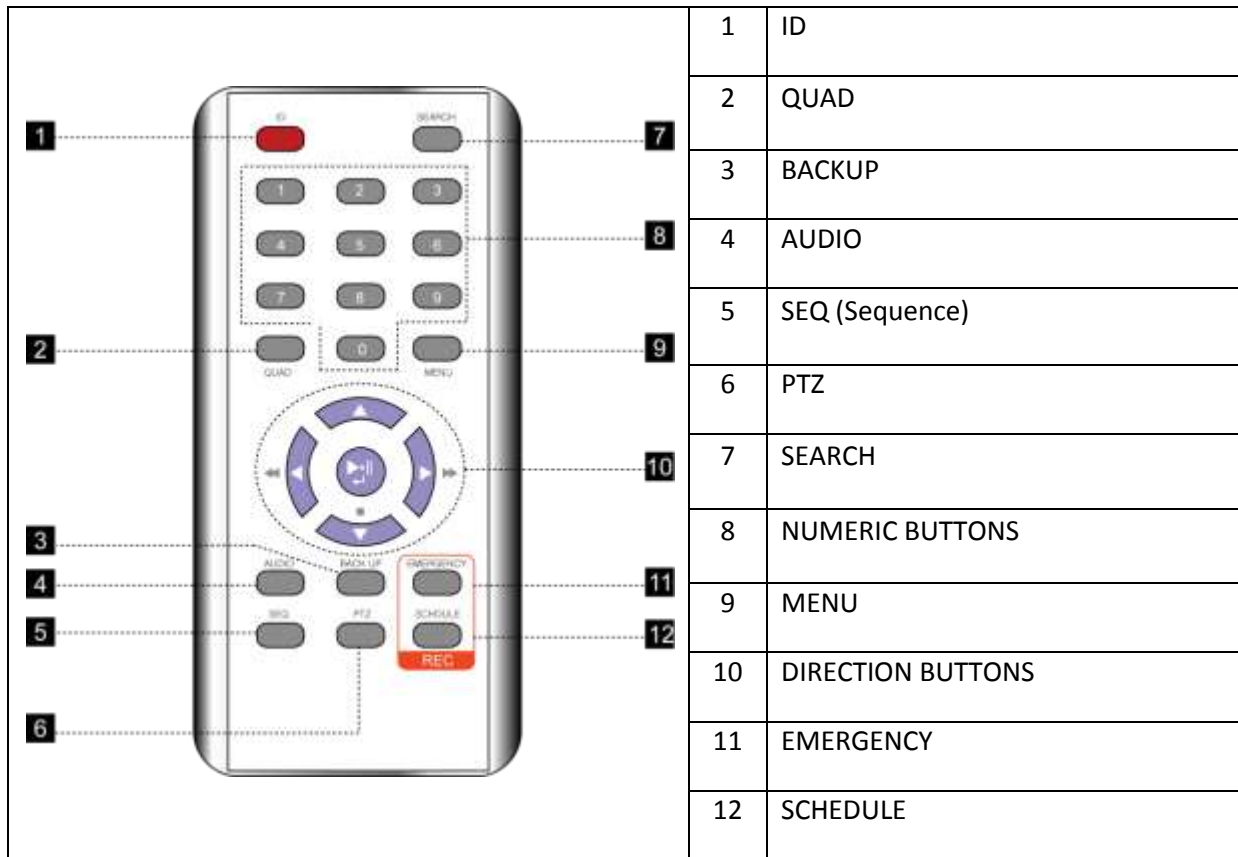

## Chapter 3. Quick Setup

### 1. Placement

#### Step 1. Preparation

Remove unit from out of the box and place it on the table top as seen below.



Figure 27 Table top placement

### 2. Connection

After unpacking the unit you must connect all camera connections, monitor connections, network connection, power connection and other optional connections.

#### Step 1. Connect Cameras to DVR unit



Figure 29 Camera to DVR

Repeat this for number of cameras you are connecting to the DVR unit.

Example: If you are connecting 3 camera in 4ch DVR unit start with CH1 then to CH2 and finish to CH3 and do not connect to CH4

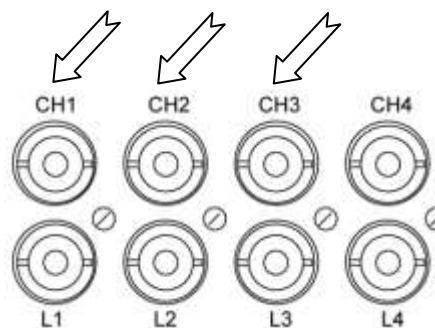

Figure 28 Example of 3 Camera Connections

Step 2. Connect monitor to DVR unit



Depending on what type of monitor you are connection connect either to VGA or BNC monitor of your choice. If you have both types of monitor you may connect both of them.

Figure 30 VGA or Monitor Connection

Step 3. Connect Network Cable to DVR unit

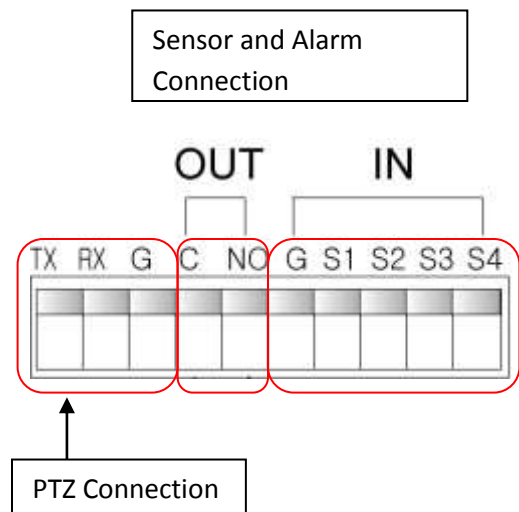

Figure 31 Ethernet Cable to DVR Unit

Step 3. Optional PTZ, Sensor, Alarm



Figure 32 10-Way Terminal Block Connection





### 3. Quick Power On

Power input – connection port for DC 12 volt

Step 1. Included DC Power adapter is located in accessory box.



Step 2. Take the adapter and connect it with power cord.



Step 3. Connect the DC 12V male connector to female DC 12V port.



Step 4. Connect to the wall outlet then press upward to POWER ON switch.



## 4. Initial Boot

After turning on the DVR unit it will go into a boot sequence. At the initial boot section there is no user interaction with DVR unit however please observe to see if DVR unit is properly booting.



Figure 34 Initial Boot screen



Figure 33 Booting in progress

As you may notice progress bar will indicate booting progression, if there is no activity for long period of time then possible corrupt or damaged firmware in DVR unit. Please indicate such failure and contact technical support.

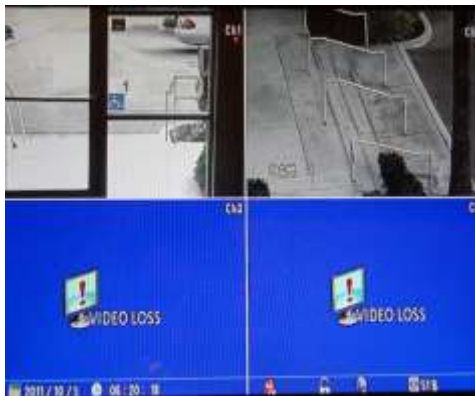

Figure 35 Live Screen View

If you have camera properly connected you will see cameras connection as indicated in figure 34 in CH1 and CH2 but if you do not have camera connect as you see in Ch3 and Ch4 you will see "VIDEO LOSS" indication as you see in above figure. Please check your cable connection if you have

### 5. Setup Screen

To initiate setup menu you may use following method

Mouse

Right mouse click anywhere on the screen of DVR



Remote

Press button labeled "Menu" on remote controller



Frontal Keypad

Pressing button labeled "Menu" on front of DVR unit's directional key pad button.



By using any method shown above there will be setup menu screen shown below



Figure 36 Setup Menu

From the setup screen you have option to choose System, Search, Backup, ER (emergency), PTZ, and Sound options. You also have option to see the log information from Warning section, change orientation from the split option, how to group the view from Group option, and to auto sequence and to automatically lock out DVR by Log out option.

**6. Change Password and Enable Auto Lock**

It is critical that you change the password and create user access to the DVR. By default admin password is 11111111 and user password is also 11111111. As default, you will be logged in as administrator and will have full privileges as administrator. As caution formatting HDD, Factory Reset option and changing administrator password you must input administrator's password as confirmation even if you have login as admin other setting such as network configuration and time parameters are vulnerable if you do not enable auto locking feature and change administrator's password.

Step 1. Select system item form main menu



Figure 37 Select system item from setup menu

Step 2. Select Password tab on the left.



Figure 38 Password Tab

Step 3. Choose the type of login account you want to change password to. In this example we would like to change the administrator account. You may scroll through type of users that DVR will have by clicking the black reverse and forward arrow.

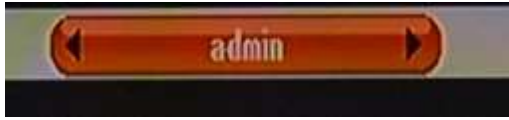

Figure 39 Selecting Accounts.

Or when user section is shown with orange color with black reverse and forward arrow, use the navigational button to toggle through type of users.



Figure 40 Navigational Button

Do not confuse the navigational button with menu, PTZ, Backup buttons on the right.

Step 4. Navigate down to Password field section then press enter or left click on the mouse.

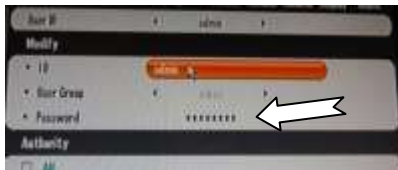

Figure 41 Password Field

You will now see a screen as shown on figure below.



Figure 42 Current Password

Step 5. When you select the area where you could type, numeric keypad will be shown as depicted on Figure 43 Numeric Keypad and Password Confirmation.



Figure 43 Numeric Keypad and Password Confirmation

Here you will be entering current password. Input the password into the numeric keypad and then confirm by selecting OK. Then you will need to end it with OK button.

You need now to input with new password input process. Numeric keypad will appear where desired password could be entered. The password is limited in numeric combination 1 to 8 digit combination.



Figure 44 New Password Confirmation

Step 6. You need to repeat one more time for new password confirmation.



Figure 45 Second Confirmation of New Password

Step 7. Apply the setting and confirm.

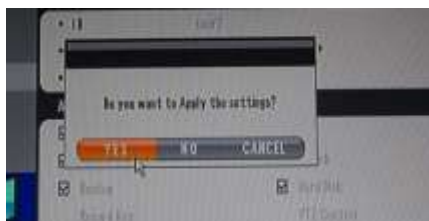
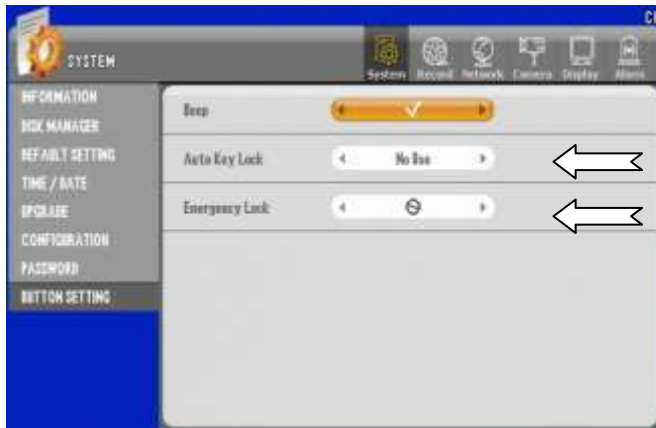

Figure 46 Apply the setting

Step 8. Under Button Settings section, you will have option to choose Auto Key Lock and Emergency Lock option. As default both section is disabled as you see in below figure.



Auto Key Lock will calculate idle time of user intervention and auto time lock the DVR Unit.

Emergency Lock will enable user to input the password every time after setup menu is exited, forcing the user to input password to be in setup menu.

As a good practice we recommend that you enable both of these features specially if this DVR is being place where few or more person may have access to this unit physically.

Choose desire time by toggling between the time selection as shown.

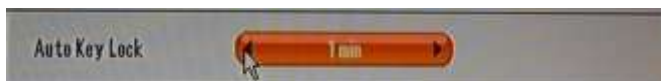

Figure 47 Auto Key Lock Selection

Also choose to enable Emergency Lock as shown below.

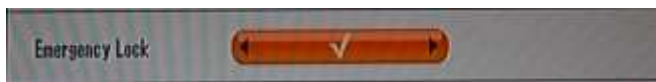

Figure 48 Emergency Lock

Apply the setting then exit.

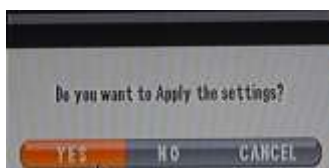

Figure 49 Apply and Exit



## 7. Labeling Camera

Sometime camera location may be identified easier by giving logical name to the camera. Here are steps to give logical name label instead of having default label.

Step 1. Select "Camera" item on upper main category and select CAMERA TITLE



Figure 50 Camera Title Menu

Here you may choose camera(s) that you want to give logical name and repeat to other camera(s) as needed. In this example we have chosen Camera 1 marked Ch1 and will change the label to door1.

Step 2. Click Camera Number to change then use the on screen key pad to change the label as shown below. When done giving name select and choose OK to end typing.



Step 3. Exit the menu and select YES to apply the setting

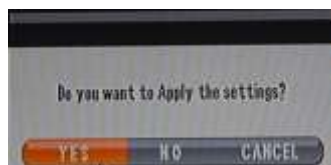



## 8. Enable Recording

Main and primary function of DVR is to record video. Below section is showing how to configure all cameras to record immediately. DVR already may be configured to record on the HDD. It is always

Step 1. Select "Record" item on upper main category then by default "EVENT RECORDING" tab should appear as shown on screen below.

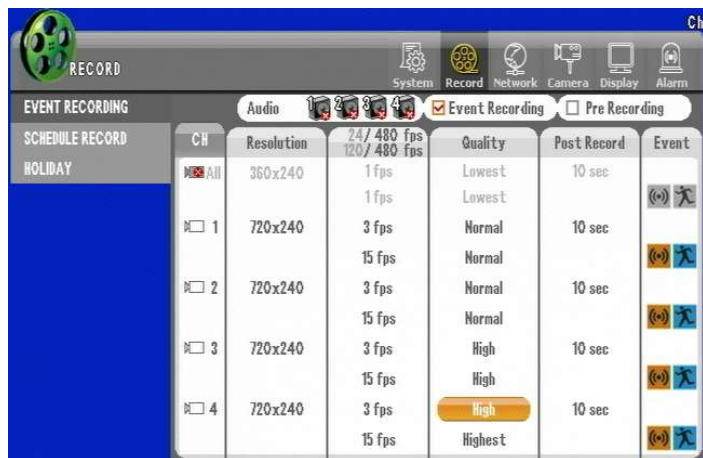

Figure 51 Event Recording Page

There are 3 types of resolution that you may choose 360X240, 720X240, or 720X480.

360X240 is lowest possible resolution setting for this unit, 720X240 being the second best resolution, and 720X480 is most defined resolution setting you could choose. Judging from 360X240, 720X240 will yield 2X more clarity but however you may have twice more consumption on hard disk space. 720X240 will have 4X more clarity but disk space will be decreased by 75% if this resolution is chosen.

Therefore careful planning and prioritizing the importance of each camera is required when first setting up the DVR. One other element is the speed of recording. fps (frames per second) setting. For screen resolution at 360X240 you may record at 30fps that, 720X240 resolution you must stay below 15fps to have equal amount of space allocation in HDD, and for resolution at 720X480 you must choose 7.5fps to have equal amount of space allocation in HDD. Lastly there is also picture quality setting that has 5 step quality elements that impacts HDD allocation as well.

Step 2. Enable Event Recording.



Step 3. Globally configure all cameras to record by clicking on "All" mark to enable all cameras then set resolution to desired setting.



Step 4. Choose fps setting globally and do not exceed base fps. In the picture example is 480fps as base fps.

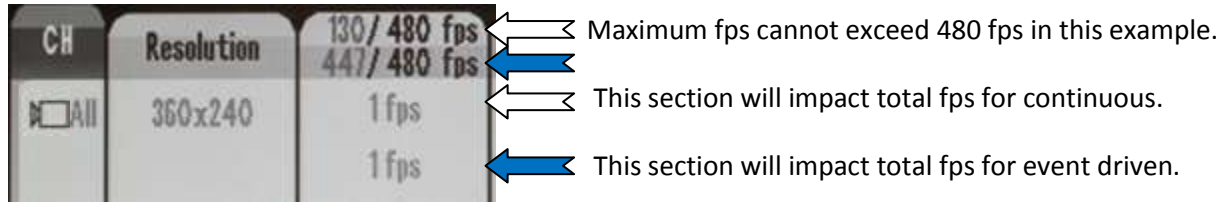

Step 5. Chose picture quality setting.



Step 6. Exit and confirm changes.

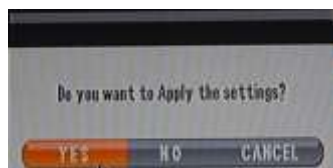

## 9. Prepare Network

Step 1. Select “Network” item on upper main category then by default “IP ADDRESS” tab should appear as shown on screen below.

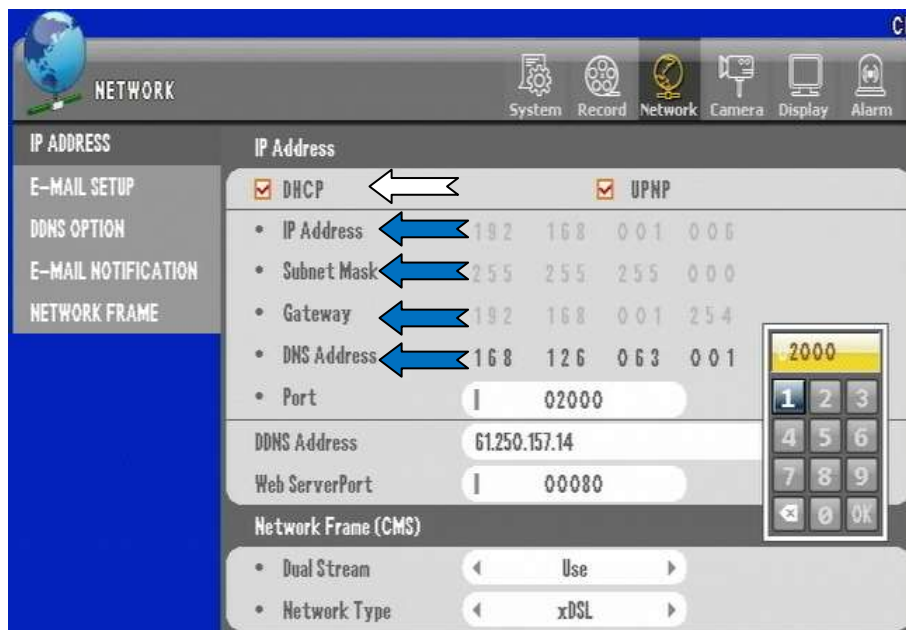



Figure 52 IP ADDRESS Page

Make sure that DHCP is selected if you have a router that leases IP address to network. If you want to give the IP Address value to unit directly then uncheck the DHCP check box and input IP Address directly where  (Arrow) is pointing to. Also make sure to assign proper port number as shown above.

Important Note: when to use DHCP vs. Static IP

DHCP is short for Dynamic Host Communication Protocol where IP address is given to the DVR and these IP address are leased to the unit. Usually IP address are none routable internal IP Address. Internal IP address or known as Private IPv4 address, they may be starting with 192.168.0.0 ~ 192.168.254.254 (16-bit block enabling 65,536 IP address set) also known as class C IP address, 172.16.0.0 ~ 172.31.254.254 (20-bit block enabling 1,048,576 IP address set) also known as class B address, or 10.0.0.0 ~ 10.254.254.254 (24-bit block enabling 16,777,216 IP address set) also known as class A address. So if your router or DHCP server gives the IP address that are class A, B, or C address shown then you can confirm that there is a DHCP services available on your network but if you get IP address ranging from 169.254.1.0 ~ 169.254.254.255 then you have been assigned pseudorandom IP address and it is a indication that there are no DHCP service available for DVR device.

Static IP setting is used when your ISP (Internet Service Provider) gives routable IP they are call Public IPv4 address. They are IP address that points to the DVR unit without relying on DHCP service. In situation such as this case you may configure IP address as recommended by ISP. Often times Static IP is

still used with class A, B, or C address. In those cases, you must point to IP addresses that are not in lease range of the DHCP scope (IP address not issued by DHCP services but must be in same Subnet and Gateway IP). Users tend to use this method when certain IP address out of DHCP scope where particular IPs are configured to use NAT, IP forwarding, or DMZ (NAT, IP forwarding and DMZ are used in most router to enable incoming traffic to specific IP addresses).

Step 2. Configure Port for incoming traffic. You must have NAT, IP forwarding or DMZ configured in your router in order to allow in bound traffic to your network. And Port assign to allow inbound traffic to local IP assign to DVR should be identical to Port configuration with DVR. See figure below but your router configuration page might look different.



Figure 53 Port Forwarding Example

On Figure 53 Port Forwarding Example we are showing how Port forwarding is done in router and DVR.

Step 3. Exit and confirm changes.

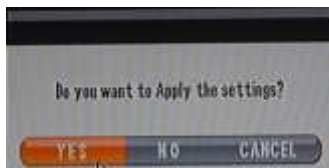

All above steps mentioned in Chapter 3. Quick Setup will ensure that you will have DVR connect to Cameras, enabled recording and basic network configuration.

## Chapter 4. Main Menu (Root Menu)

There are 6 items shown on Main Menu or Root Menu. They are “system”, “search”, “backup”, “ER”, “PTZ” and “sound”. There are also “Warning”, “Split”, “Group”, “Auto Sequence” and “Log out” set of items below Main Menu items.



Figure 54 Main Menu Items

### 1. Main Items.

The “system” item is used to configure DVR unit. The “search” item is used to conduct search and playback the video on DVR unit. The “backup” item is used to conduct backup off to USB memory device or other media. The “ER” is emergency recording function. The “PTZ” is used control PTZ camera and finally the “sound” is used operate sound.

**2. Sub operational items.**

The “Warning” option will indicate any deficiency with DVR unit such as HDD error and Network Error types.

The “Split” items shows screen configuration with following layout.



Single View

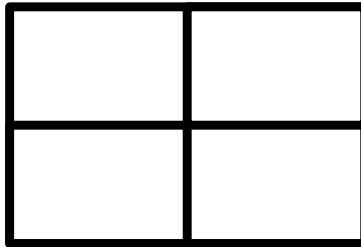

Quad View

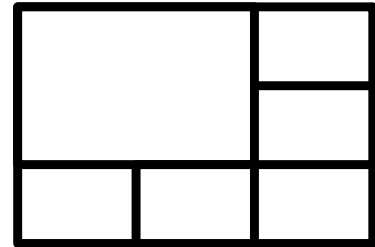

6 View

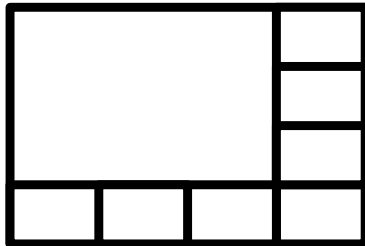

8 View

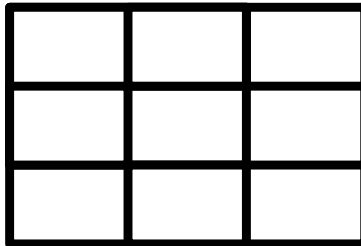

9 View

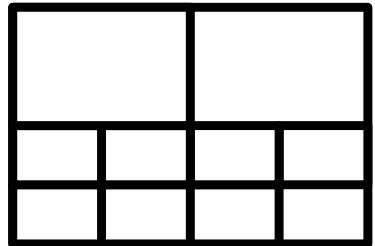

10 View

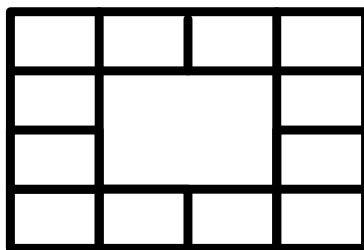

13 View

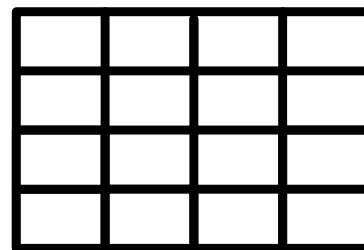

16 View

With “Group” will goggle to the next set of cameras available.

With “Log out” user will need to have right user credential to log back in next time.

## Chapter 5. The "System" Root Menu Item

### Convention of Menu Tree

To quickly understand nature of each field, items selectable in each field, possible selection combination of the field, behavior of each field and types of information shown by each field are graphically illustrated by using hierarchical organization using Tree illustration. There is Root Menu which is Main Menu and there are items which we would now refer them as branches.

Menu Tree will show all type of fields that are present in GUI of the DVR unit. Conventions of the menu tree are organized as follows.



Figure 55 Root Menu

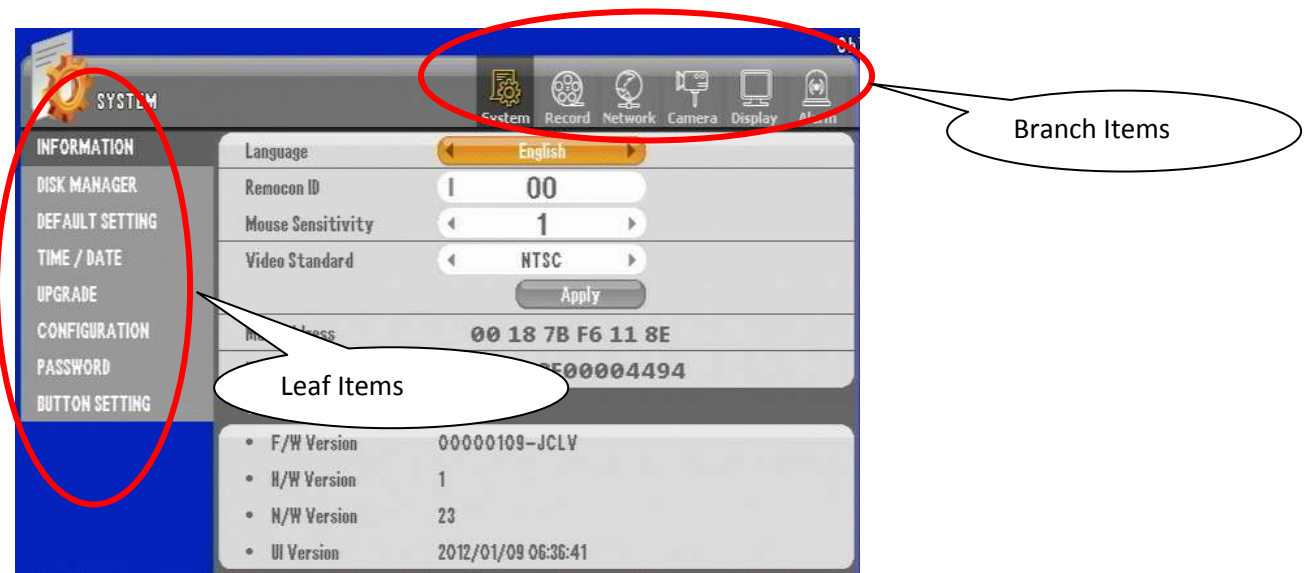
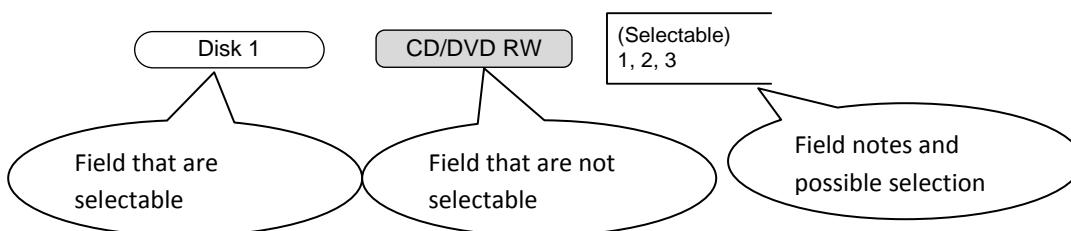
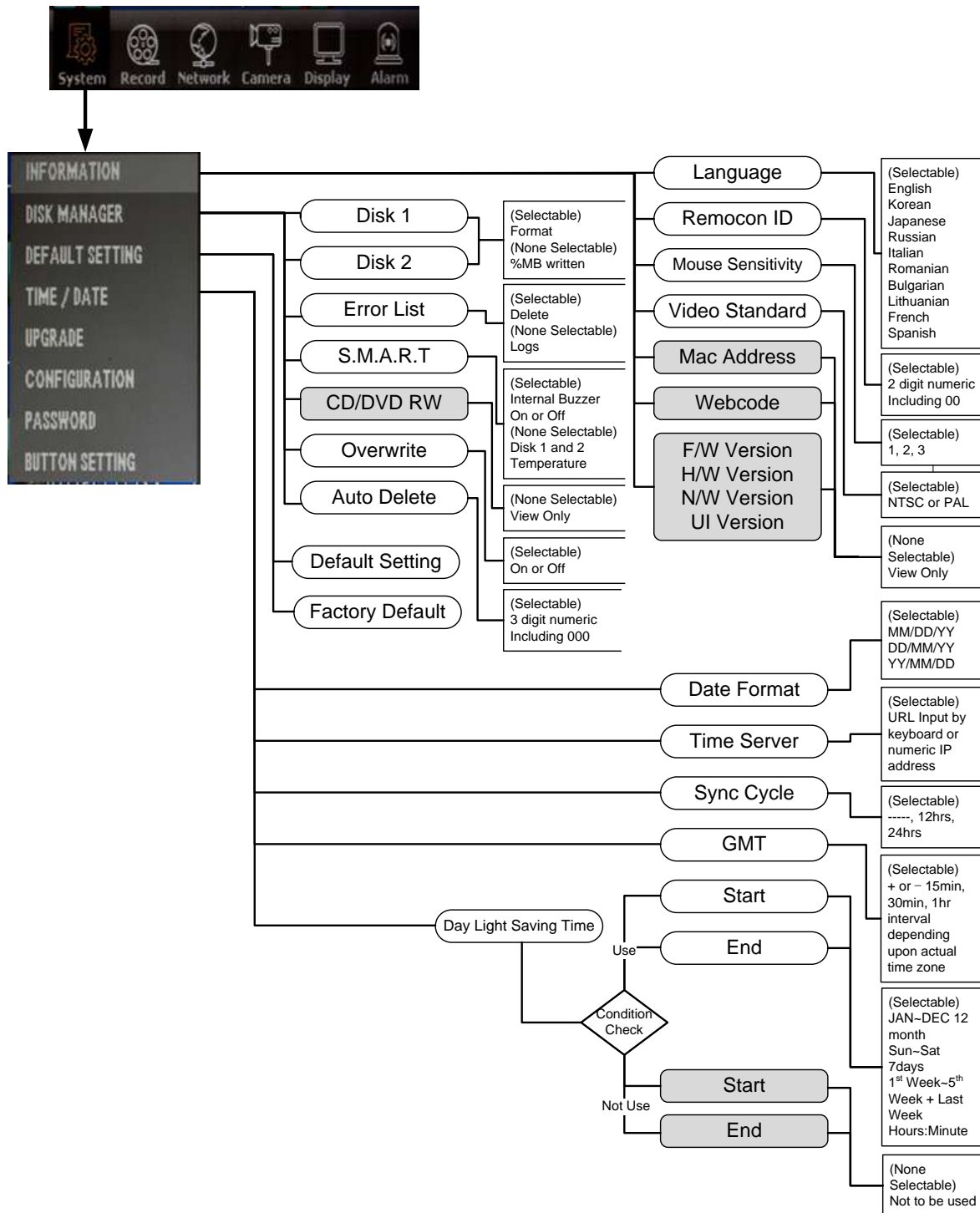

Figure 56 System Branch with INFORMATION Leaf



1. The "System" Branch





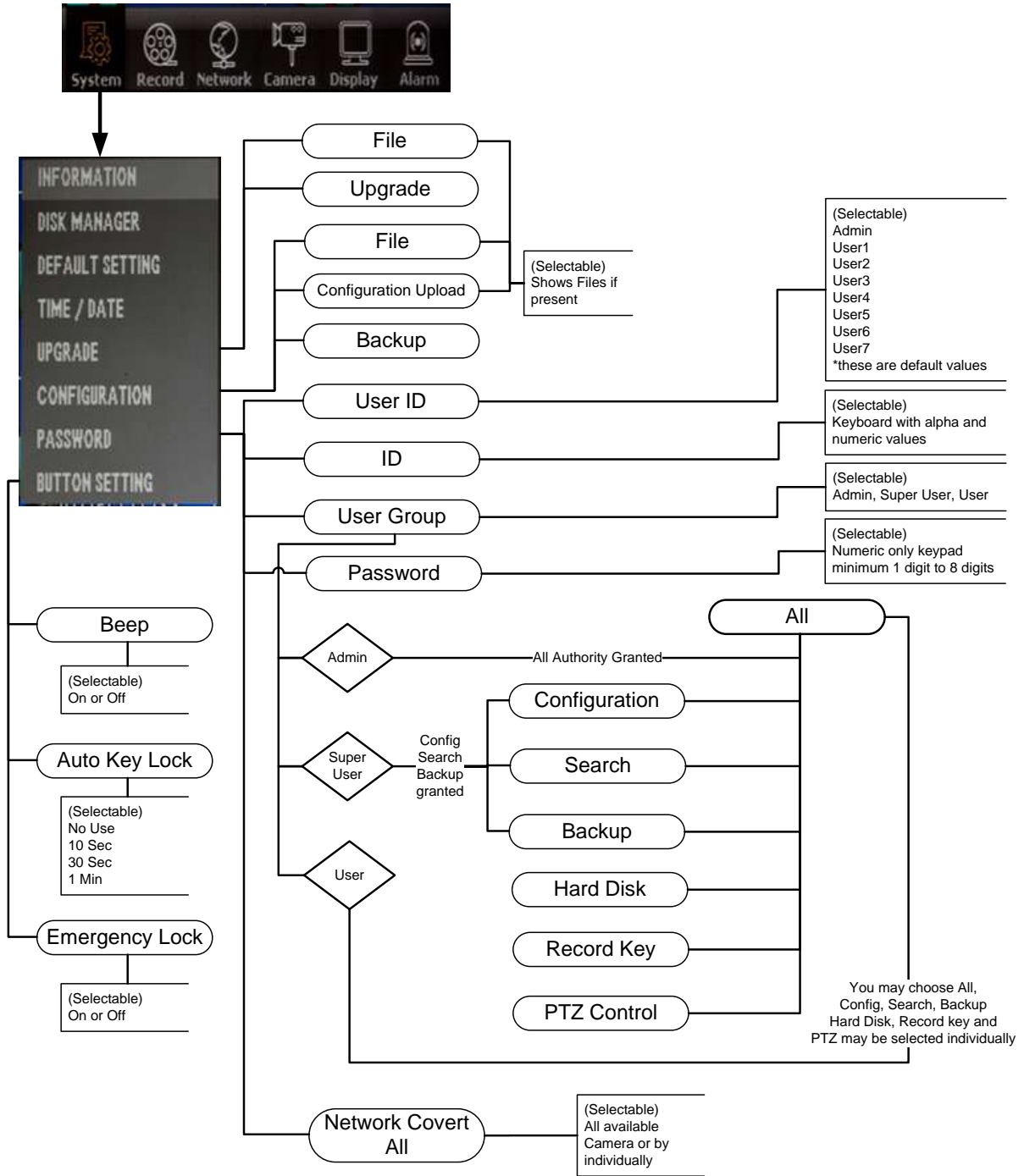

2. The "Record" Branch

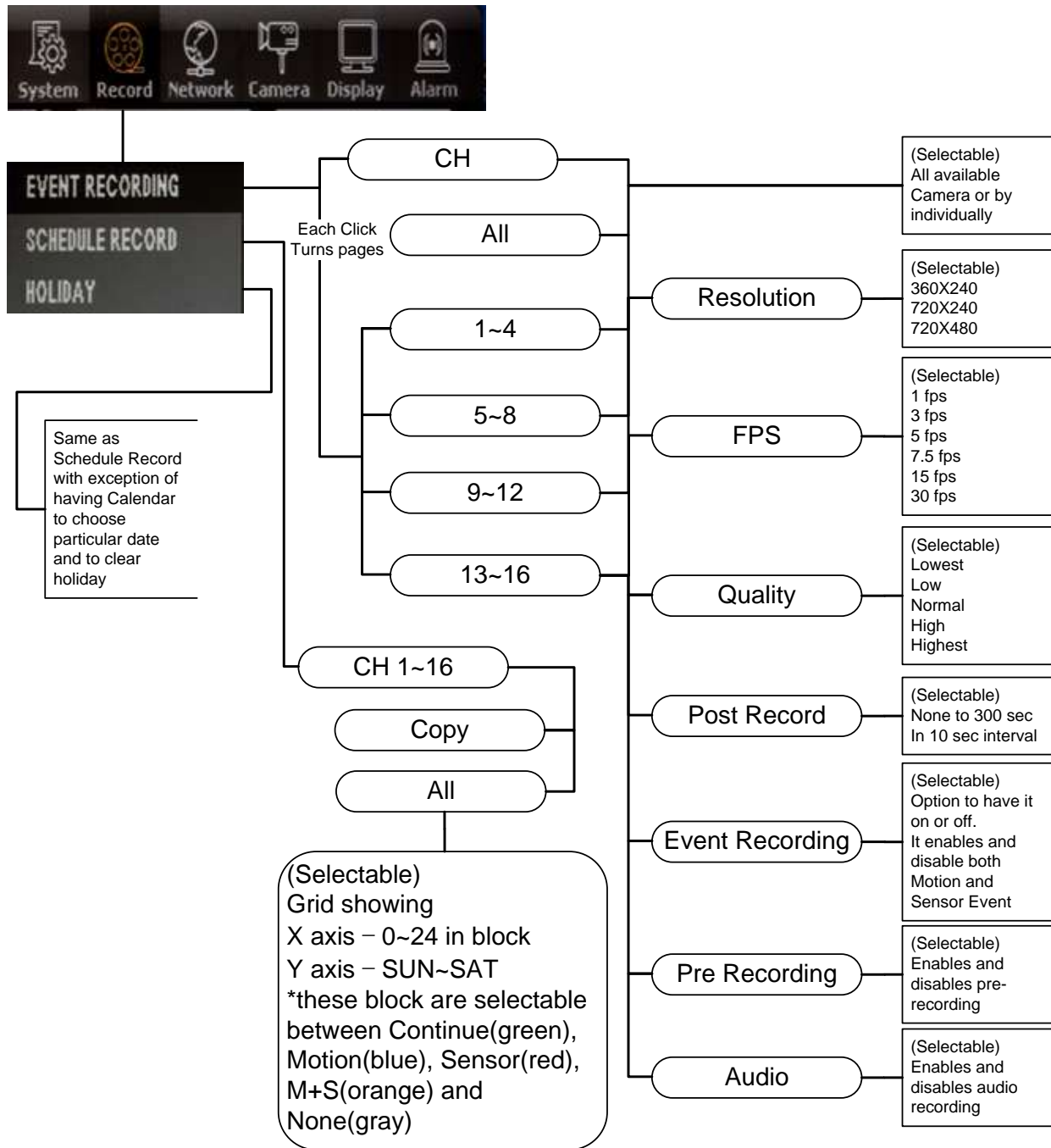

3. The "Network" Branch

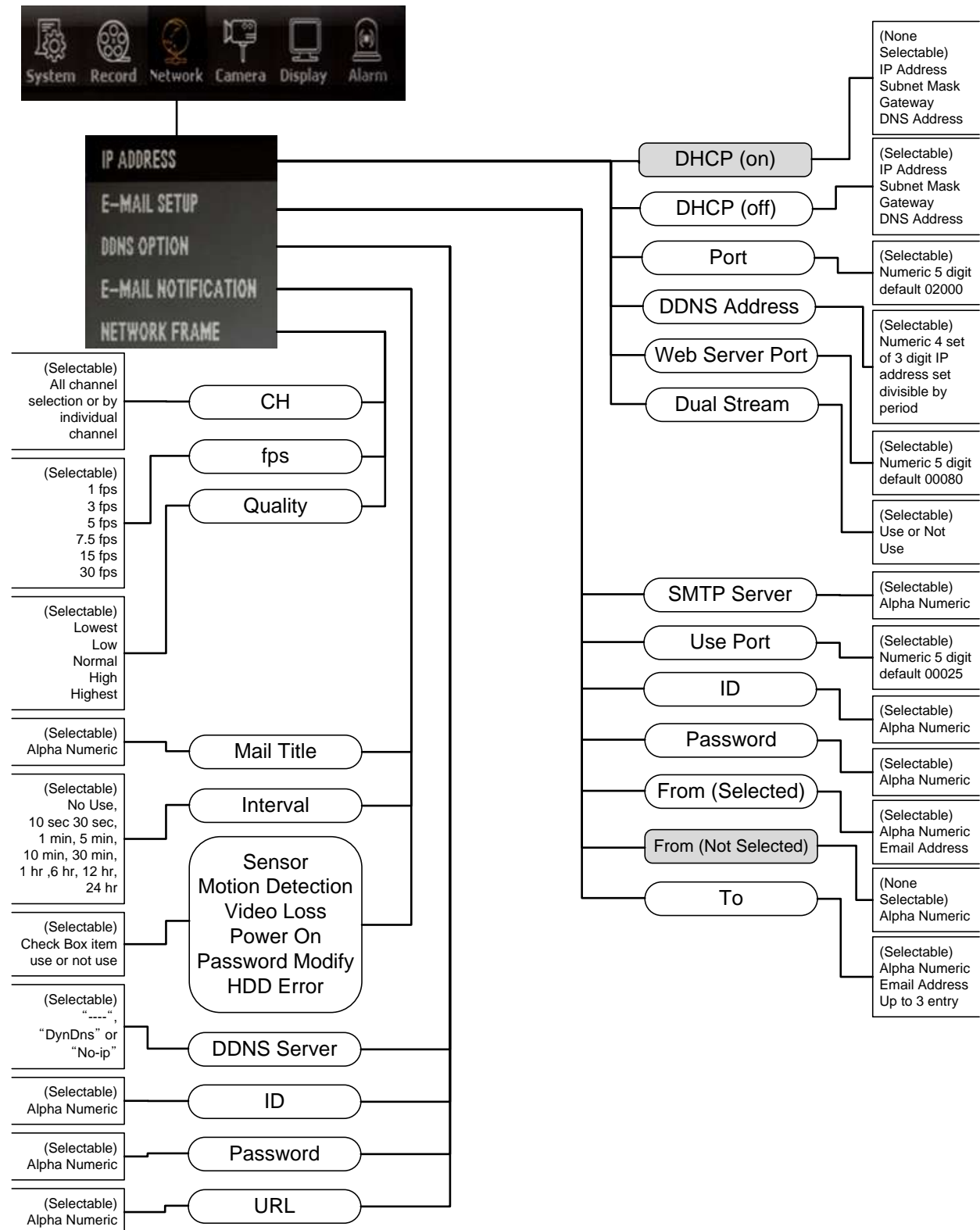

4. The "Camera" Branch

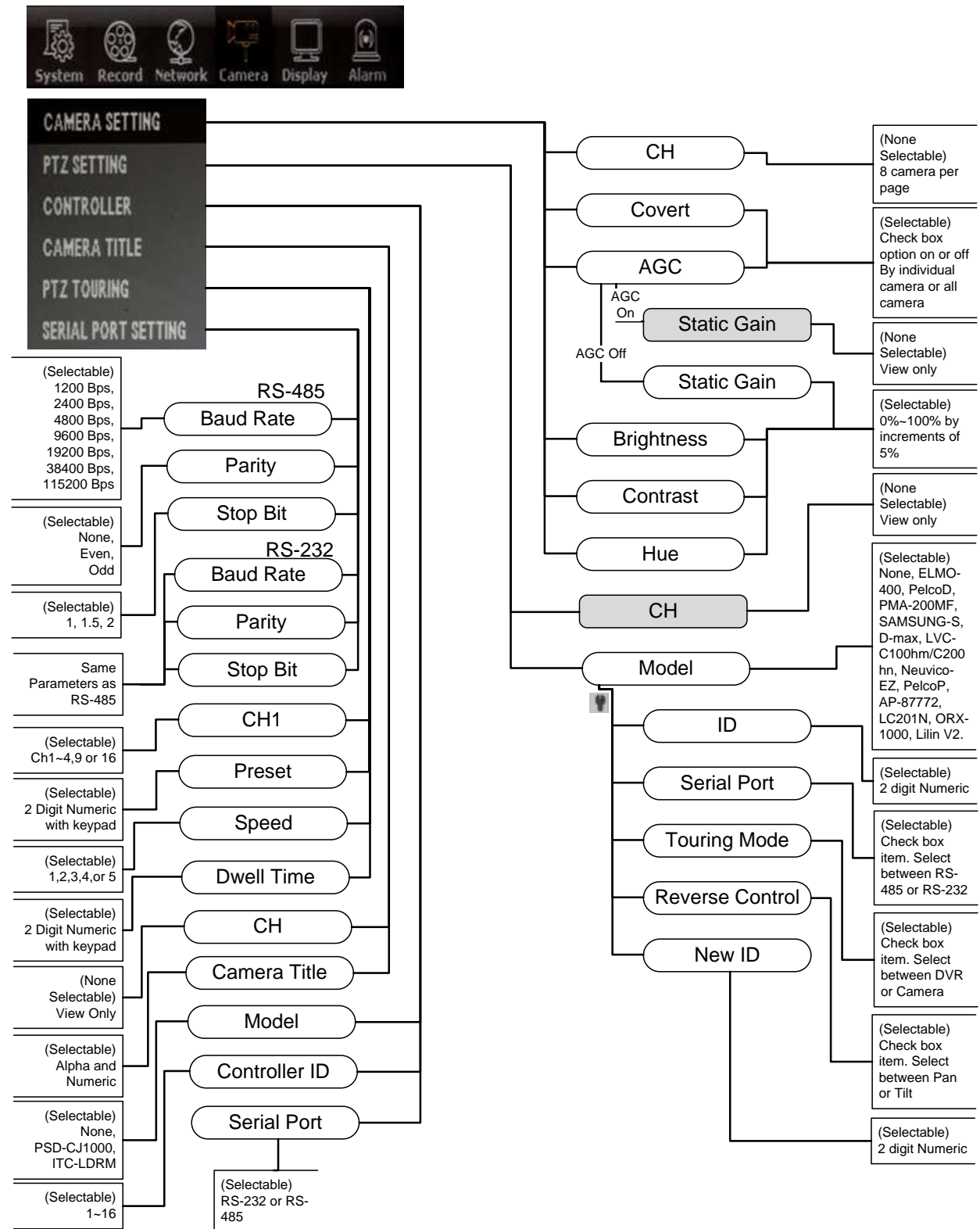

5. The "Display" Branch

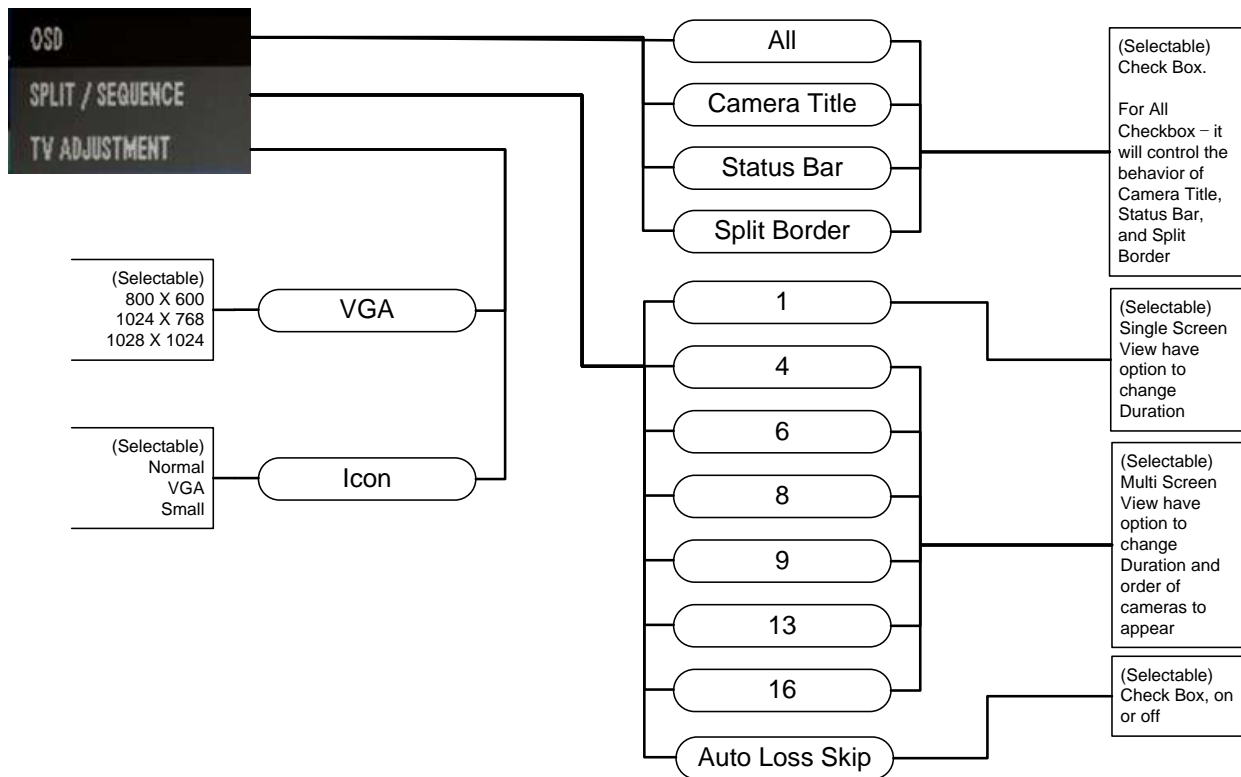

6. The "Alarm" Branch

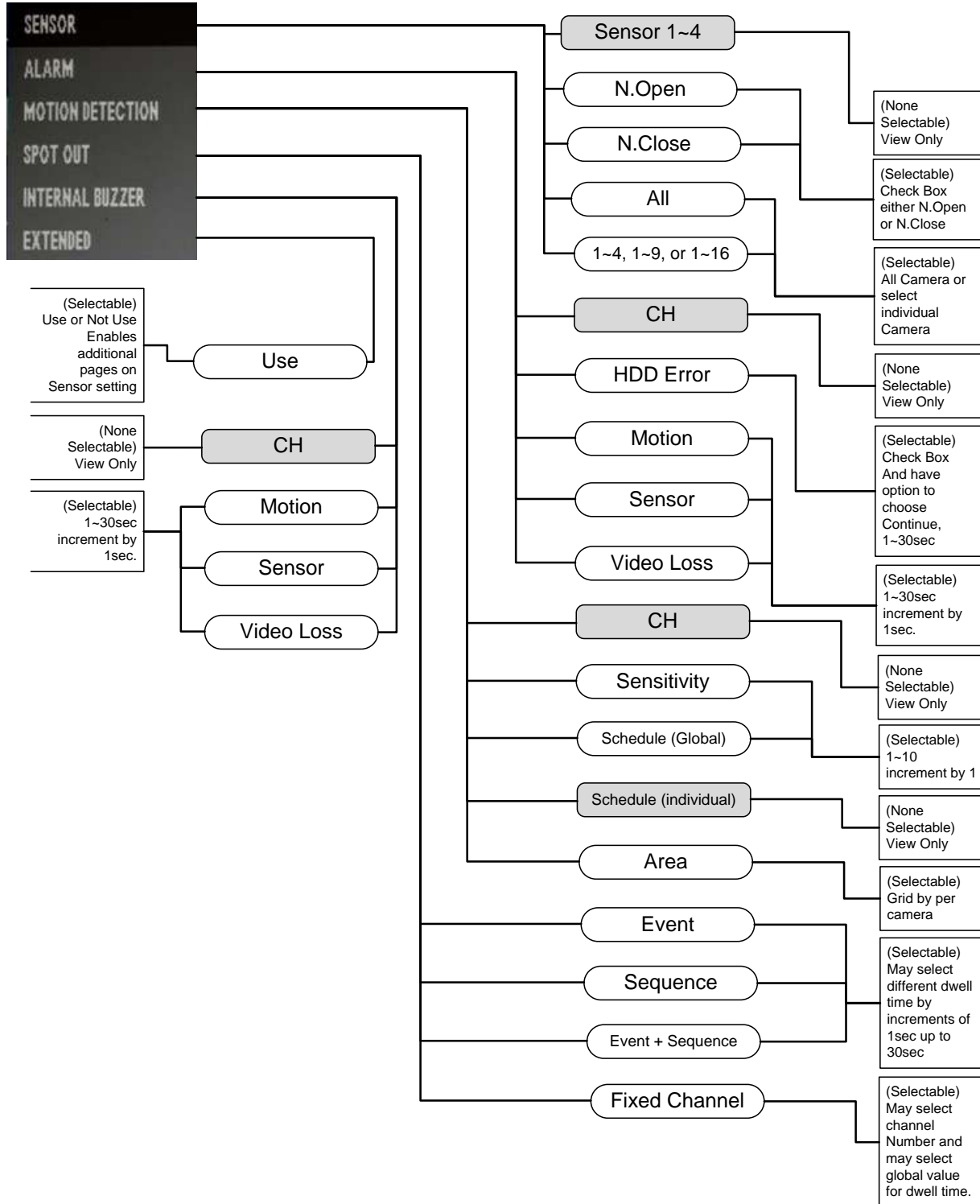

## Chapter 6. The "Search" Root Menu Item

### 1. The "Calendar" Search Branch

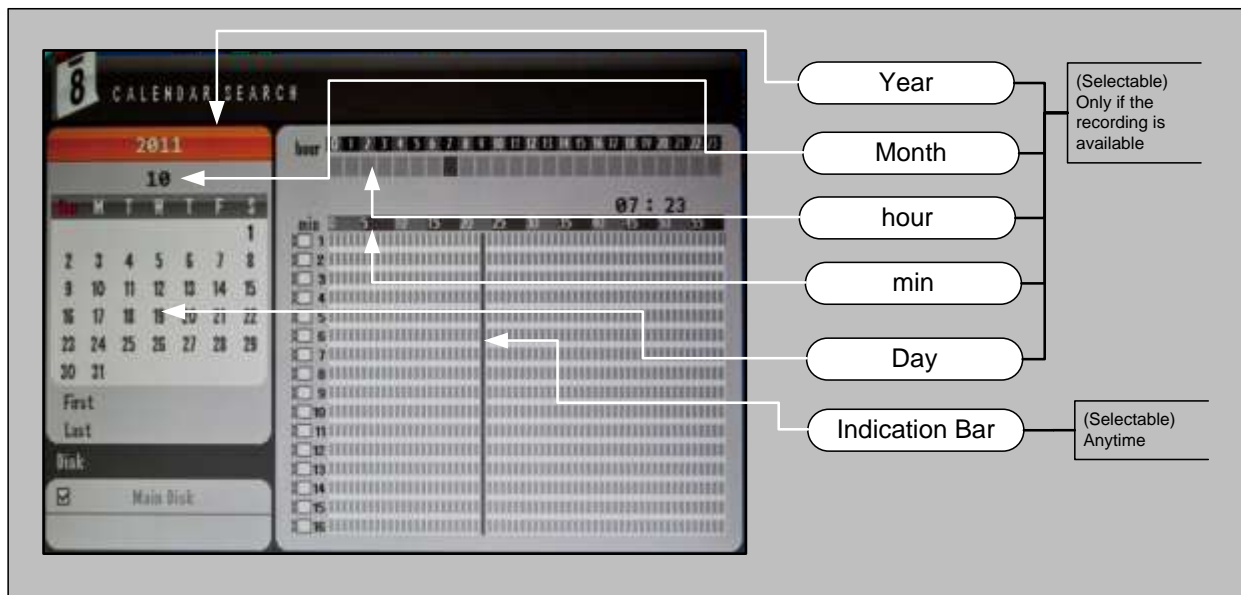

2. The "Event" Search Branch

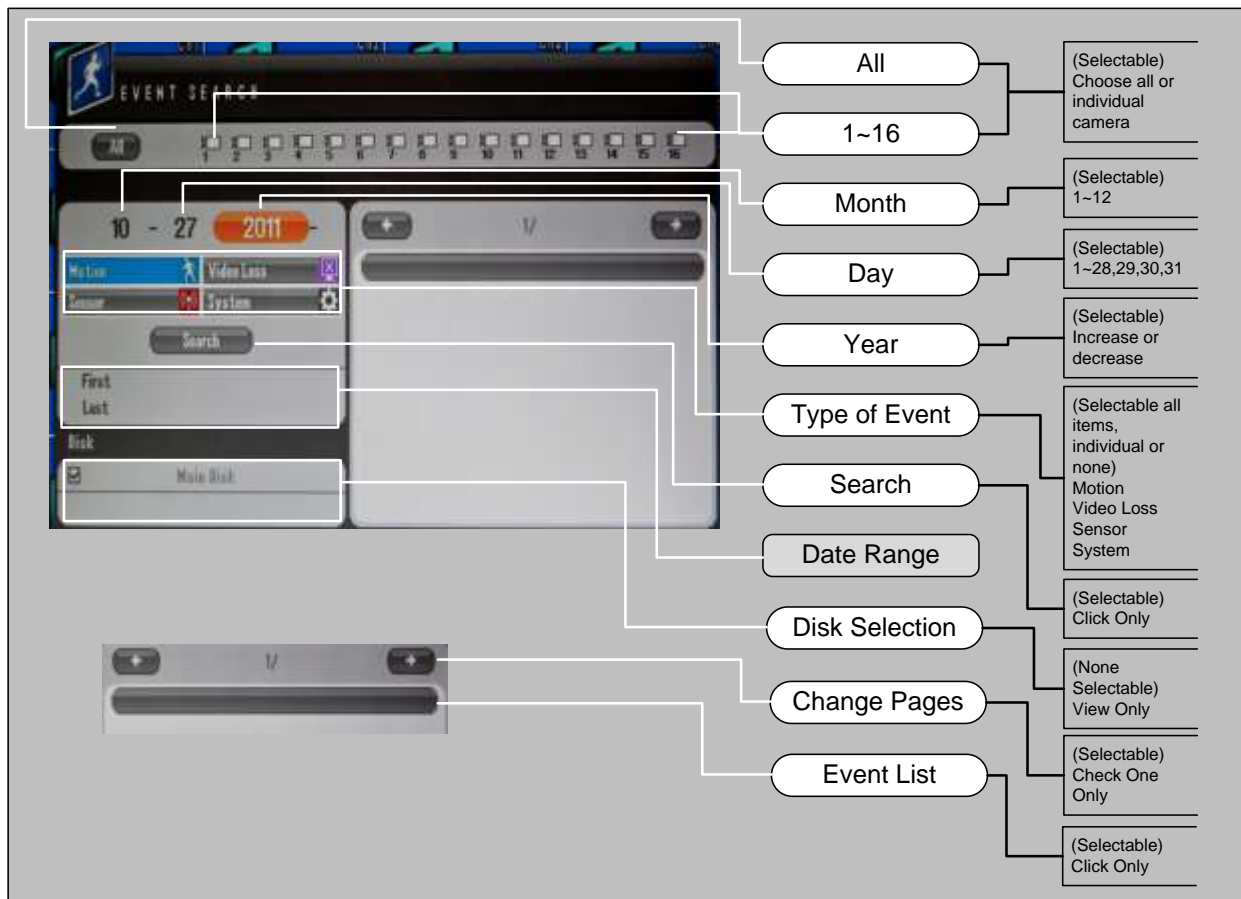



3. The "Date / Time" Search Branch

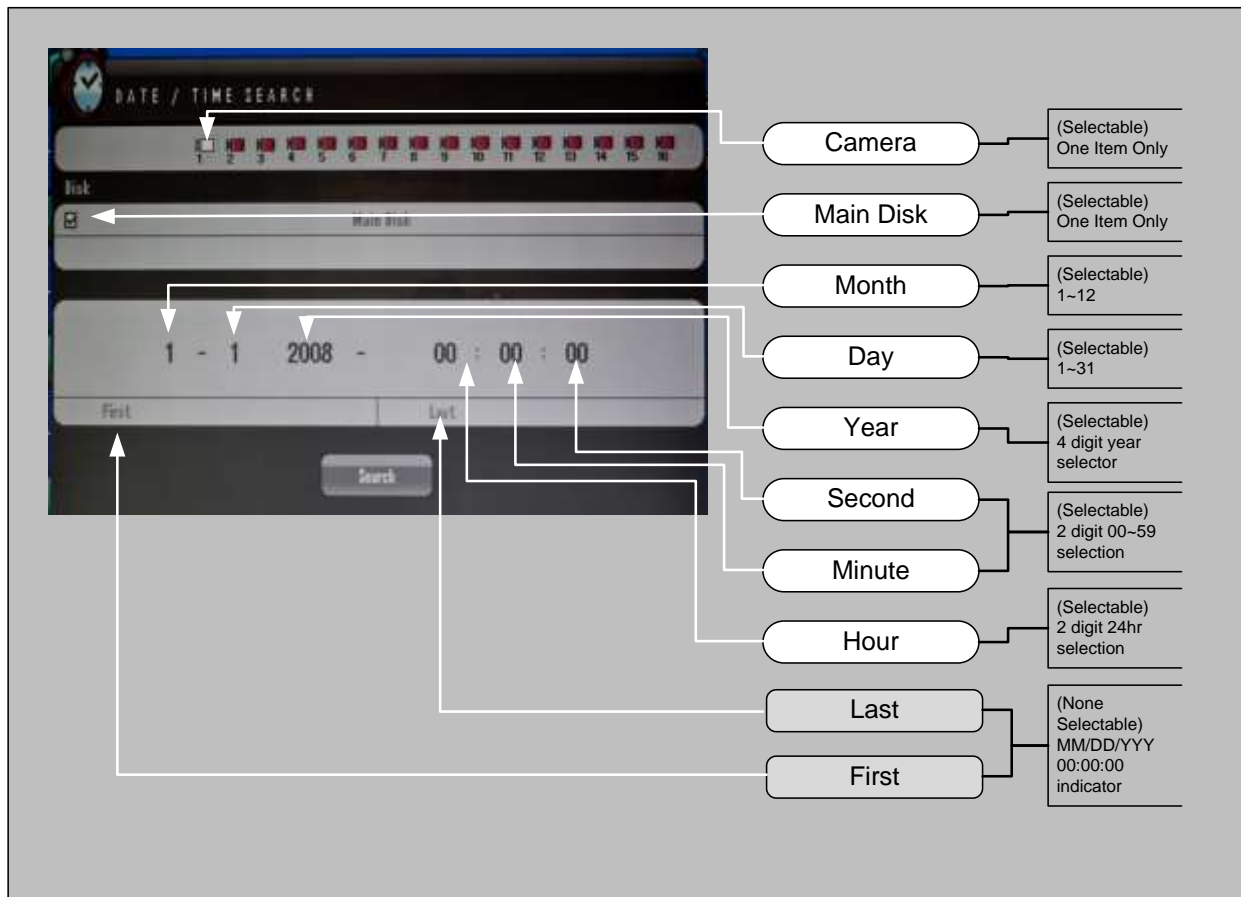

## Chapter 7. The "Backup" Root Menu Item

### 1. Calendar, Quick and List Branch

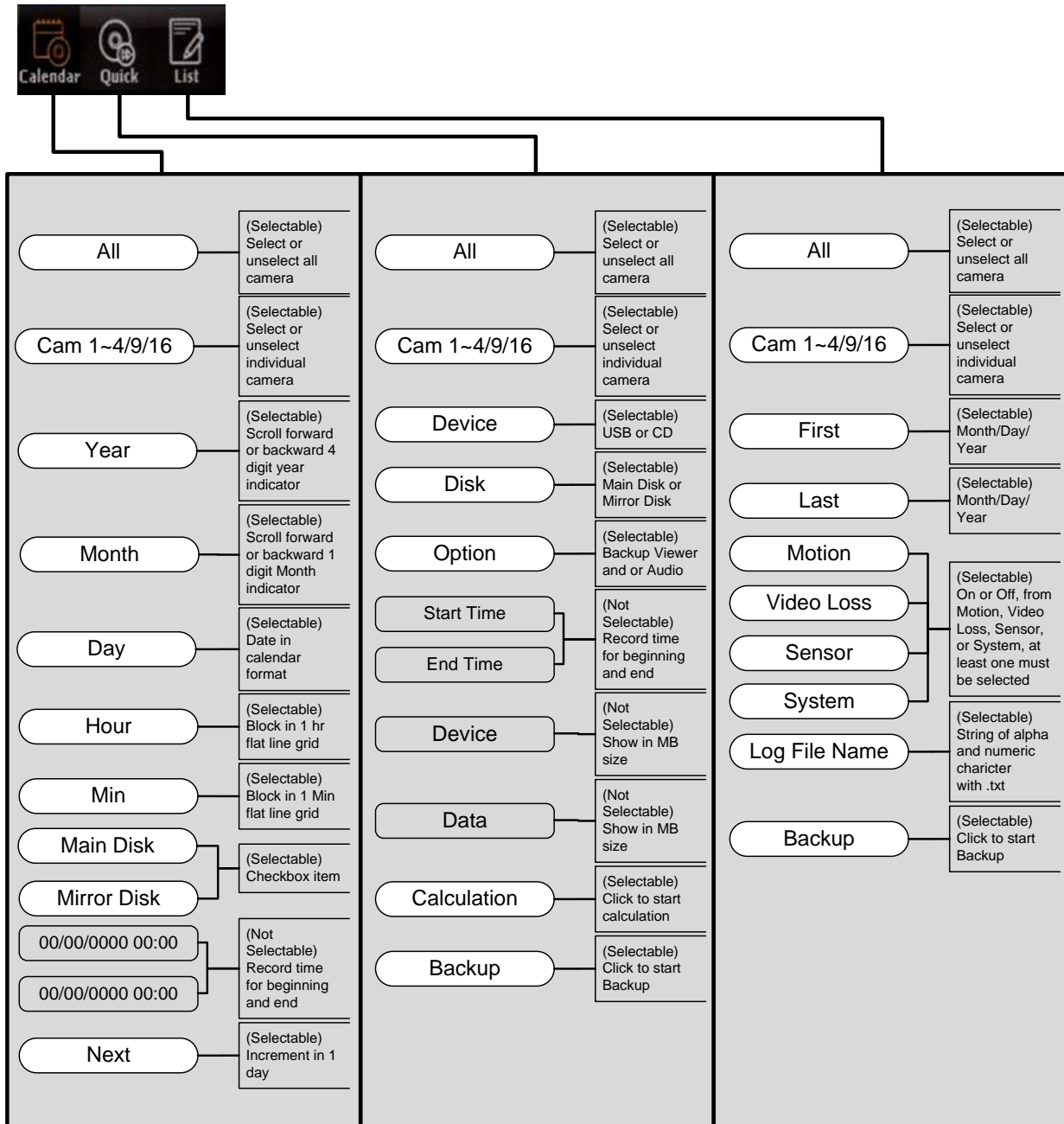

## Chapter 8. The "ER", "PTZ", and "Sound" Root Menu Items

The ER root menu item functions as panic recording features and only have one functional button which is the ER button itself.

PTZ root menu item will invoke PTZ function on single channel view.

Sound root menu item will bring up a single page popup that shows audio off, audio channel 1~4 to enable and disable and check box with Auto feature where sound input and output is operated by hardware associated for such exists that will be automatically utilized. See below Figure 57 Audio Popup.



Figure 57 Audio Popup

**Chapter 9. Systems Section In-Depth****1. INFORMATION GUI**

Graphic User Interface (GUI) for INFORMATION section under SYSTEM is as shown below.

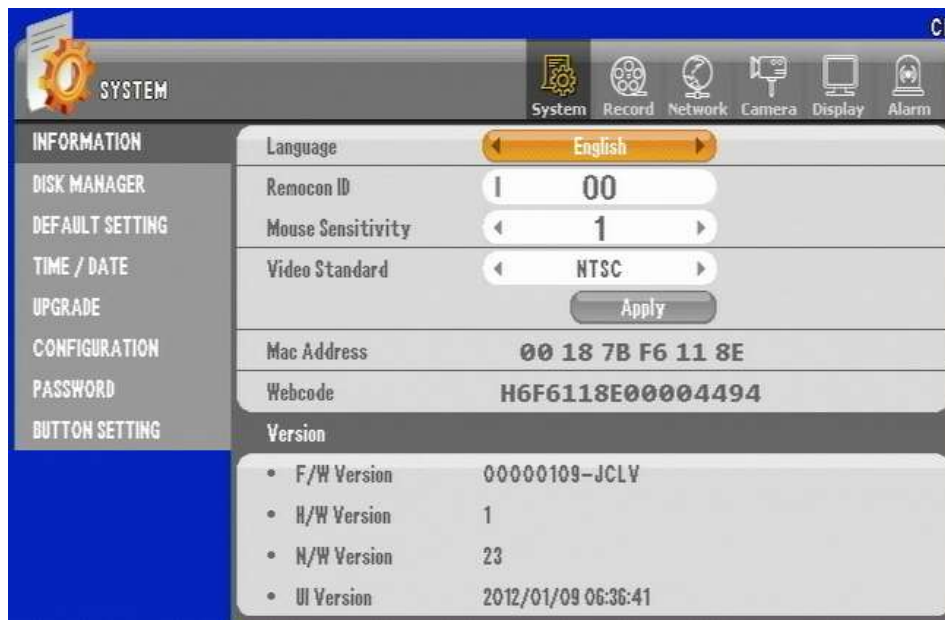

The SYSTEM INFORMATION section page indicates what type of language is being used, remote controller ID information, control for the mouse sensitivity, video standards MAC (media access control) address, webcode (special unique identifier only given to our DVR units) and all versions of software and hardware that makes up the DVR unit. This section is equivalent to “About” section of application program.

**Language**

There are 10 different languages available for the DVR unit. As language field is toggled between English, Korean, Japanese, Russian, Italian, Romanian, Bulgarian, Lithuanian, French, and Spanish you will experience the change in GUI. We need to caution that if language you do not understand is selected please reference this manual for the location where language item is located in system menu. For better understanding of the layout of our GUI, refer to section 1. The “System” Branch in chapter Chapter 5. The “System” Root Menu Item.

**Remocon ID (Remote Controller ID)**

This ID setting enables to control more than two DVRs with one remote controller. Order of configuration is first you need to select DVR to have ID that are not going to conflict with other DVR(s).

Set the ID per each DVR and match the ID for use.

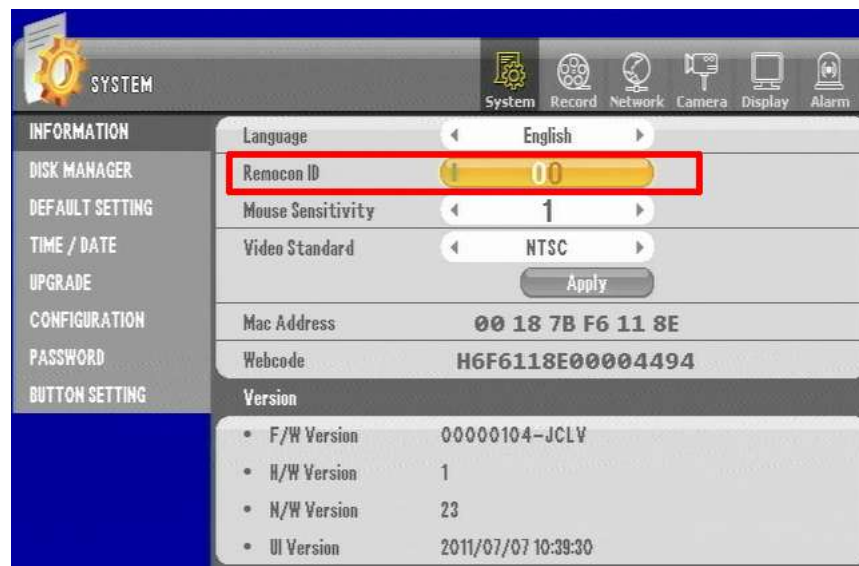

Figure 58 Remote Controller ID

The default value for the ID is "00". Change it to other value other than "00". Let's say that we change the remote controller ID to "02" and then exit out of the GUI menu and save. Then point the remote controller and press the red button labeled ID.

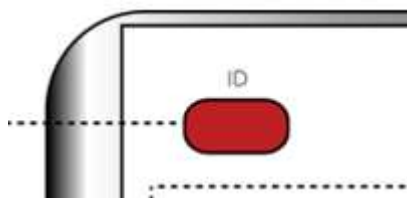

Figure 59 Remote Controller ID Button on remote controller

You will see Figure 60 ID selector screen. Your ID selector screen should appear with DVR ID: 01 in our example (figure shows 00) and you must use the directional button on the remote to configure larger number ID field to 01 as well.

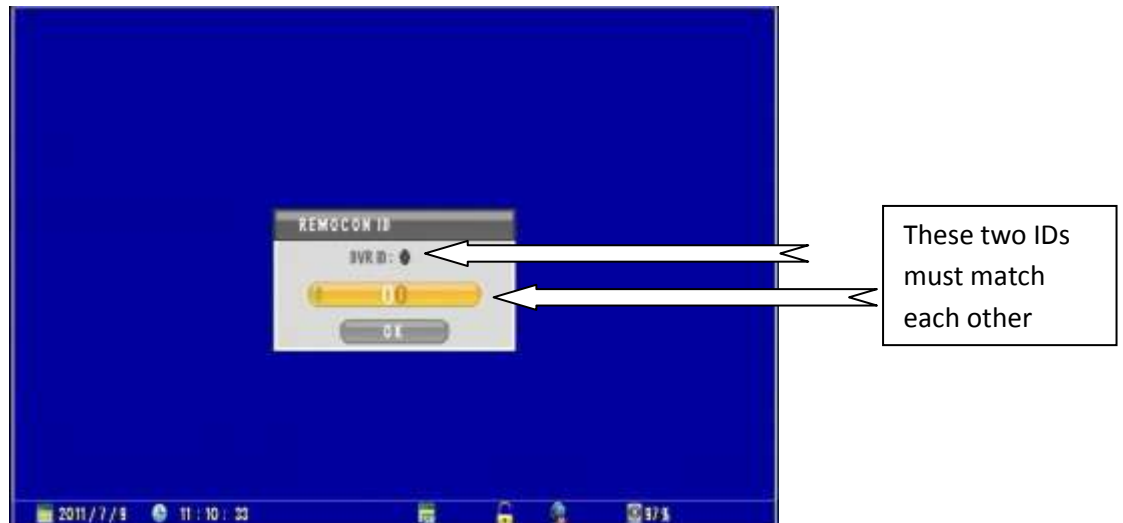
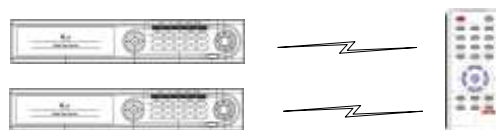

Figure 60 ID selector screen

Now you will have the ability to use that remote controller to operate this particular DVR unit.

Also you may use two remote for two spate DVR let's say you configure one remote to last sync with DVR ID of 01 and use the other remote only for DVR ID of 00 then these two remote now has different ID. Our remote controller has micro controller built in and it remembers the last ID that it was assigned. Therefore, our remote controllers have capability to be assigned ID numbers as well as DVR having spate ID numbers for remote controller.



Tow DVR with one remote controller

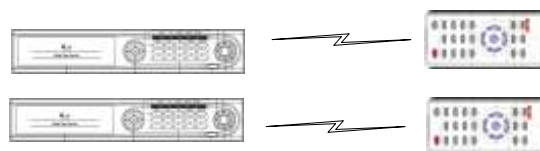

Tow DVR with two remote controller

**Mouse Sensitivity**

This feature enables user how responsive are the movement of the mouse can be when user is operating a mouse via the USB connection provided either in front or back of the DVR unit. It only applies to the mouse sensitivity locally to the DVR not to the remote application. Sensitivity setting has level 1~3. Lowest level being most slow to 3 being the fastest.

**Video Standard**

There are two selectable standards for video NTSC or PAL. Reasons for two type of video standards are that some countries decided to use PAL or NTSC standard for television broadcast. In CCTV environment you must correspond to determine what type of cameras are being used and what type of display monitor is being used. Simple rule to remember is that you should matchup equipment with one uniform standard. If you resided in country that uses NTSC for broadcast and are using NTSC monitor, NTSC Camera then you must choose NTSC for video standards setting for DVR unit. Even if you reside in country that uses PAL standards some countries uses NTSC standard due to compatibility of equipments being used. So it is very critical that you identify what types of camera, and what type of monitor will be used for the DVR unit.

NTSC (National Television System Committee), PAL (Phase Alternating Line) are what these acronyms mean. NTSC standards are predominantly being used in North American countries, some South American country, and a PAL standard dominates the European countries, some South American countries such as Argentina, Uruguay, Brazil and many part of Asia with exception to South Korea, Japan, and Philippines.

## NTSC countries

Canada	Japan	Puerto Rico
Chile	Mexico	South Korea
Costa Rica	Nicaragua	Taiwan
Cuba	Panama	U.S.A.
Dominican Republic	Peru	
Ecuador	Philippine	

Table 1 NTSC countries

### **MAC Address**

As mentioned before MAC (Media Access Control) addresses are unique to individual network card or NIC (Network Interface Card). They are represented in six groups of two hexadecimal digits. These address are sometimes referred as physical address or hardware address as well. Importance of MAC address for our DVR is when users need to provide this information to network administrator. Many reasons your network administrator will need to have MAC address but one most important reason may be for providing adequate rules for organization's firewall configuration or (and) for proper port forwarding application. Often times MAC address are used to create special network rules and are sometime given special privilege in network using MAC address. In this manual we would only discuss applied needs of MAC address pertaining to our DVR unit. For further information regarding MAC address please refer to guides that explain basic principles of Ethernet networking.

### **Webcode**

This also is unique identifier that our DVR has mainly functions as special identifier that is used in DDNS service. Our DVR unit has very easy to use DDNS features and this Webcode is very important part of identifying DVR unit in networking and communication.

### **Versions**

In this section there are notations for F/W Version, H/W Version, N/W Version, and UI Version. They are Firmware, Hardware, Network, User Interface version information. These information are critical information when troubleshooting the DVR unit or to service the DVR unit. Firmware versions indicate type of memory resident software information that is installed in the DVR unit. Hardware version indicates physical equipment versions that have component differences. Network versions indicate type of NIC cards and network controllers and UI is GUI versions.



**2. DISK MANAGER GUI**

Below is the GUI for the DISK MANAGER section.

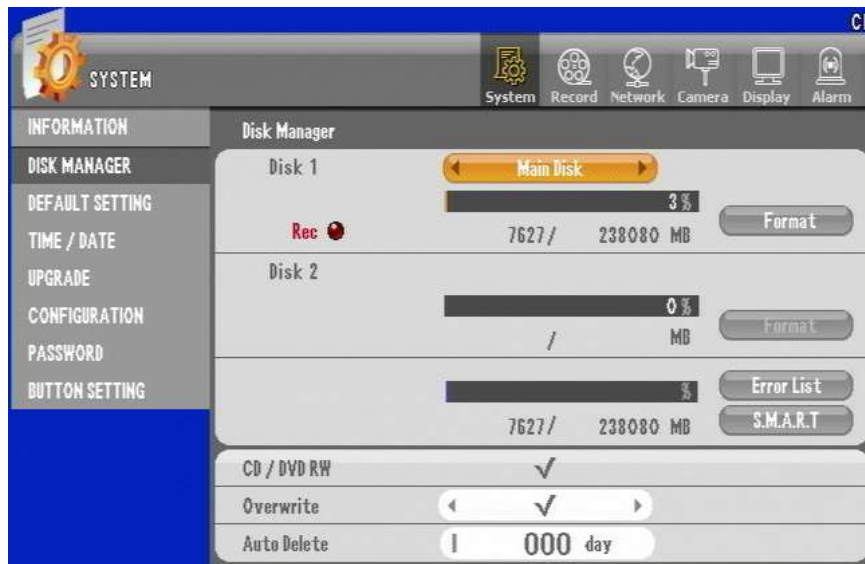

Figure 61 Disk Manager GUI

In this section where options for HDD there are options to see condition of all the HDD installed in the DVR unit as well as performing format, see HDD error and current condition of HDD using S.M.A.R.T.

There are also sections showing other drives that are present. Disk 1 is primary drive that must be installed to have proper operation of DVR unit.

Please check and perform a format operation if DVR unit is not recording, there may be HDD installed but if HDD is not formatted then recording will not occur. Please perform format operation any time when you do a HDD upgrade.

### **Adding, installing HDD and other drives**

Here below illustrate how HDD must be installed in event of HDD upgrade or introducing secondary HDD.

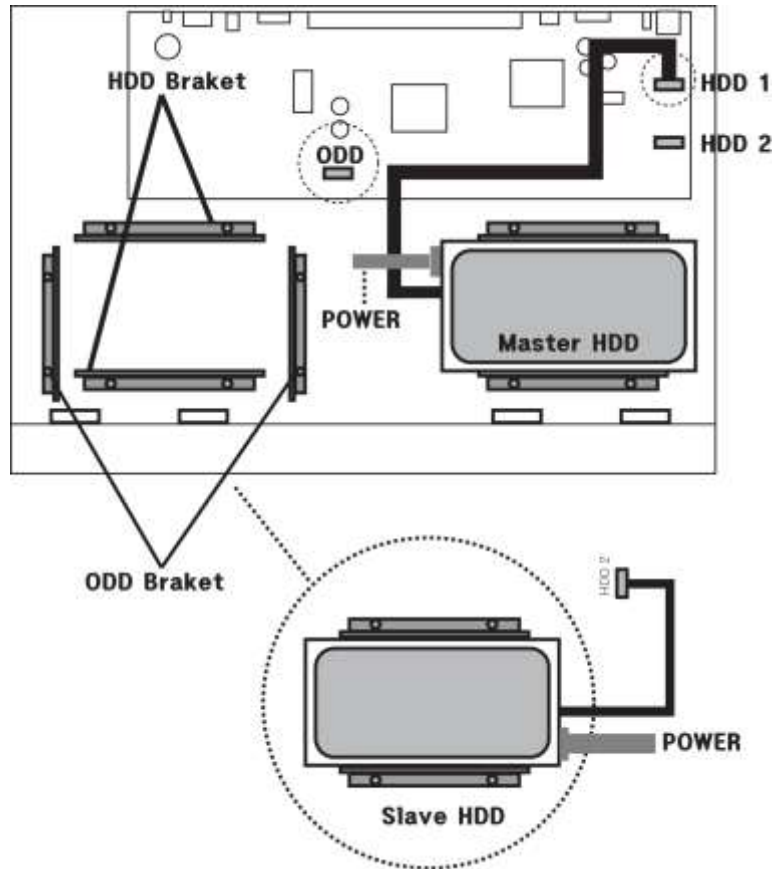

Figure 62 HDD Installation

When you mount a single hard drive, mount it to “Master HDD” as described in the picture above and connect the power. Then, connect the SATA cable to the main board “HDD1.”

When you’d like to mount two HDDs, install “Slave HDD” as described in the picture above, connect the power. And then, connect SATA cable to the main board “HDD2.”

### **Installing ODD (Optical Disk Drive)**

Alternatively you may have HDD 1 and Optical Disk Drive.

Important reminder is to make sure after inserting ODD, check to see recording in HDD 2 is not enabled and make sure that ODD is visible in disk manager section..

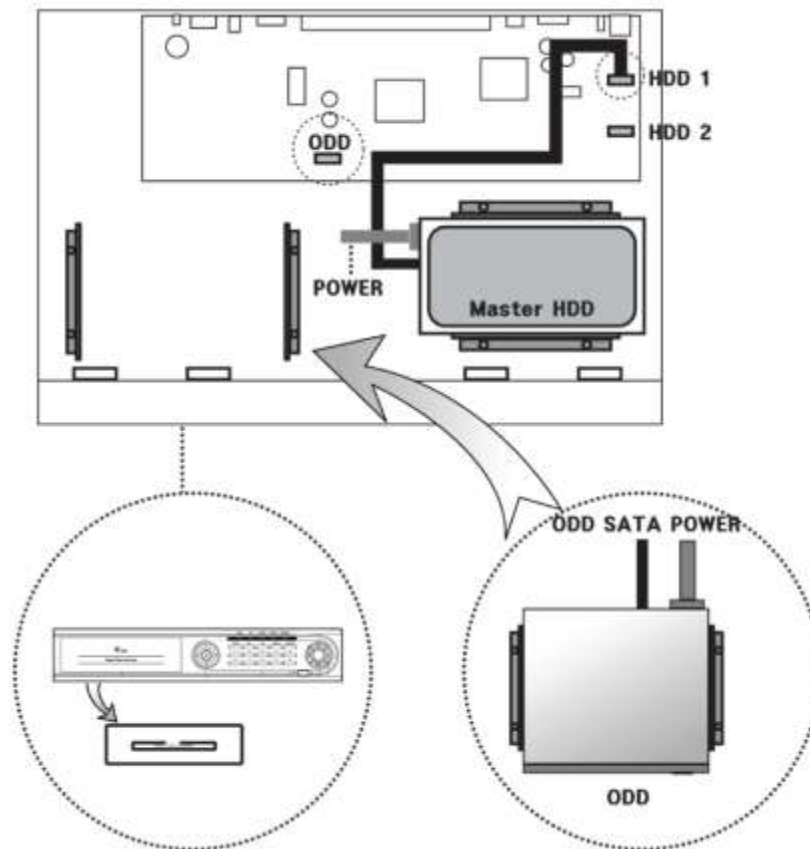

Detach the front panel from the unit and also detach the ODD cover.

Mount the ODD to its bracket and connect the power. Then, connect the SATA cable to the ODD port.

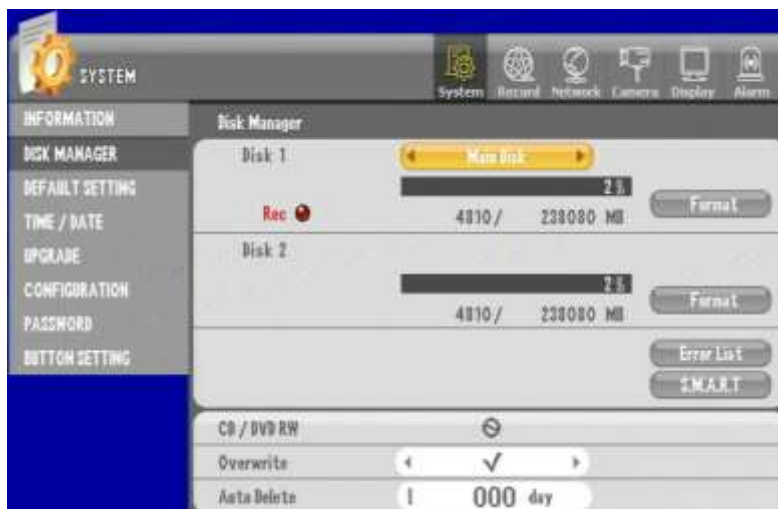

Figure 63 HDD 1 and HDD 2 example

**Configuring HDD1 and HDD2**

Set the first HDD connected to “HDD1” in the system.



Figure 64 Disk 1 Configuration

**1. Set Main Disk or Mirror Disk.**

Main Disk or Mirror Disk option will be available.

Main Disk is used for single disk operation or 2 HDD that will use its maximum volume capacity. At least HDD1 must be set to Main Disk (Single HDD).

With HDD1 and HDD2 installed both HDD1 and HDD2 must be formatted upon 1st time operation.

Mirror Disk option must be chosen if HDD 1 is replicated to HDD 2.

When Mirror Disk option is set and has data corruption or HDD failure HDD2 has replicated information of HDD1.

**2. Format: Format the HDD**

HDD must be formatted when new disk is introduced.

HDD must be formatted when disk is from different DVR unit.

HDD format is recommended when disk is pulled out and reintroduced to DVR unit.

3. Capacity: Used capacity/ Total HDD capacity (Ex : 0 / 238080 MB)

Capacity indicator depicts capacity in percentage and actual files size in mega byte.

**CD / DVD RW**

If the ODD is mounted, V(Check) is displayed. And if not, “∅” is displayed.



**Overwrite**

When the entire HDD volume is consumed, the saved data will be erased as much as new data entered. (V: Overwrite, ∅: No overwrite)



**Auto Delete**

Maintain the data during the designated period while automatically deleting the data saved previously. (Selection Range : Not use, Able to set up to 120 days)



**Error List**

When there is an error for the HDD such as Read, Write, Connection status and HDD recognition, the date is saved. You can select the Delete button to erase the data.





**S.M.A.R.T(Disk Management)**

Display the HDD temperature. If the temperature rises to the designated degree, DVR omits audible alert as well as creates an event that may be notified.

Temperature setting range: Not use, 10'C, 20'C, 30'C, 40'C, 50'C, 60'C, 70'C, 80'C, 90'C



**3. DEFAULT SETTING GUI**

If you ever need to revert to a factory default values of some or all information you have an option to choose between “Default Setting” or “Factory Default” button.

Differences between two buttons are that;

Default Setting : Reset all the settings except the critical settings such as Network, Password. in the menu to their default values.

Factory Setting : Reset all the settings in the menu to their default values.

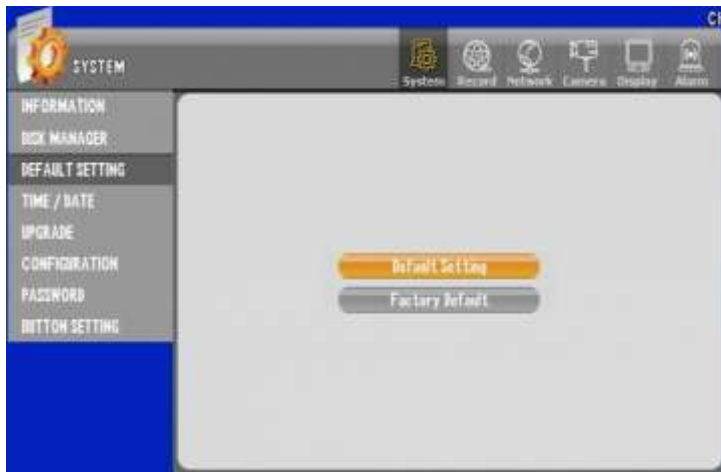

Figure 65 Default Setting

When these default settings are required are when you perform a hardware upgrade or firmware upgrade. Sometimes these upgrades are not required to have default settings applied but some occasions it will be best to perform it and reconfigure the parameters according to guidelines of support representative or technician.

Default setting operation are recommended on following situation;

1. Operating the device for the 1st time. (even though manufacturer may have best guessed possible user environment it is best practice to revert to default and start configuring to users environment)
2. When products is moved to different facility or sent to different time zone.
3. When multiple users access the DVR unit and have administrator rights among the users where you are not sure of the changes implemented on the DVR unit.

**4. TIME / DATE GUI**

In this section of GUI page you can perform operation to change time and date. It is recommended that you perform this operation when you first receive your unit for deployment and is installed in physical location of DVR unit placement. Having the proper time and date information is very critical when DVR's recorded information be presented as evidence to event recorded on the device. You must also be mindful of each regional rules of day light savings time configuration.



Figure 66 Time Date GUI

**Configuring Year/Month/Day**

You can select the display type per country.



- ASIA : Year/ Month/ Day → (Ex) 2006/05/31
- US : Month/ Date/ Year → (Ex) 05/31/2006
- EURO : Date/ Month/ Year → (Ex) 31/05/2006



**Configuring Date & Time**

Set the current date and time.

Set the time and press “Apply”. And then check the popup message and select “Yes.”



Figure 67 Confirmation of date and time change

This message in Figure 67 Confirmation of date and time change appears when there exist some data in HDD that has different time than what you are changing to.

Consequences are;

- If you change the time from 3pm to 4pm, when searching, the 4pm video is played after the 3pm video is played.
- If you change the time from 3pm to 2pm, when searching, the 2pm video is played after the 3pm video is played.

**Configuring Daylight Saving Time**

You can set time to one hour before for certain period of time in the summer

(example)



Figure 68 Daylight Saving Time

Above setting is started from 12:00, Sunday of the last week in July and ended at 00:00,

Monday of the 3th week in August.

### **Configuring Time Server**

It is used to keep the system time constant. It synchronizes the time through the selected time interval and the server.



Time Server	kr.pool.ntp.org
	Test
• Sync Cycle	12Hour
• GMT	+09:00 Seoul

- **Time Server** : Enter the time server URL or IP
- **Sync Cycle** : Set the sync cycle with the time server
- **GMT** : Set the standard time zone
- **Test** : Check the operation status of the time server

**4. UPGRADE GUI**

In this section of GUI page, you will need to introduce the USB media with valid firmware update file and this GUI will show file name similar to Figure 69 UPGRAD GUI.

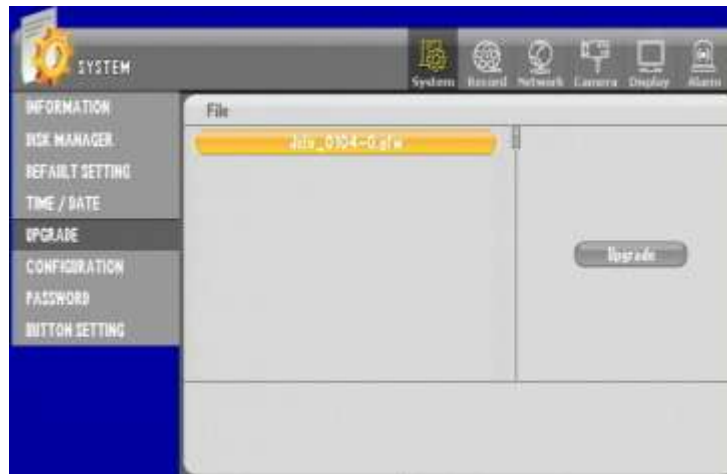

Figure 69 UPGRAD GUI

Save the firmware to the USB Memory Stick and insert it into the USB port of a DVR. Then the file list stored in the memory stick is displayed. Select the relevant firmware file and click the Upgrade tap.

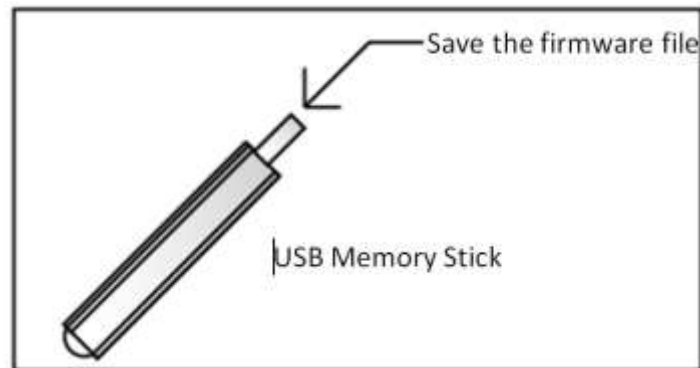

Figure 70 Firmware to USB memory

It may take a minute or a minute & 30 seconds depending on the firmware. Please wait until rebooting is finished. Do not unplug or take out the USB memory stick during the upgrade. Otherwise, it could be the cause of the product failure.

**5. CONFIGURATION GUI**

You can archive the system configuration file to USB memory stick or restore the previous system configuration from the archived file.

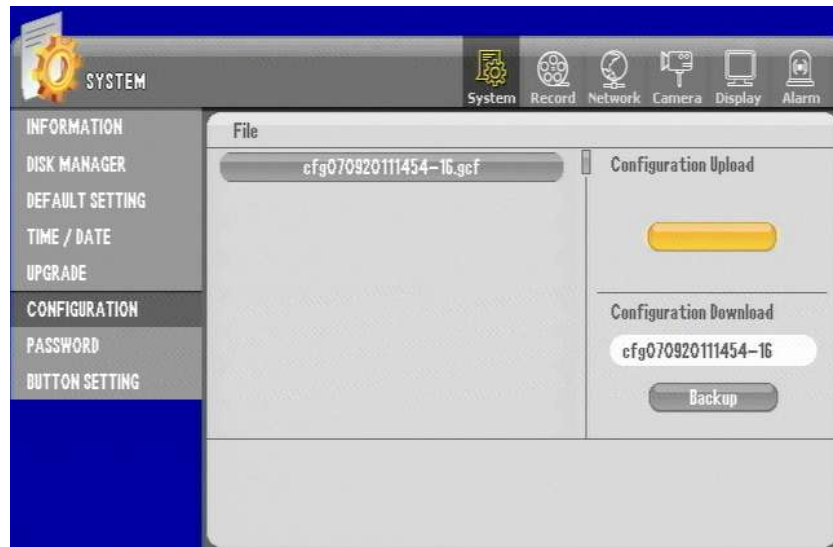

Figure 71 Configuration GUI

**Configuration Download**

Insert the USB memory stick to DVR unit and configuration file may be down save to USB memory stick.

You will see configuration file similar to below Figure 72 Configuration Backup Button.



Figure 72 Configuration Backup Button

Then make sure give enough time to have configuration file to be written to USB memory stick.

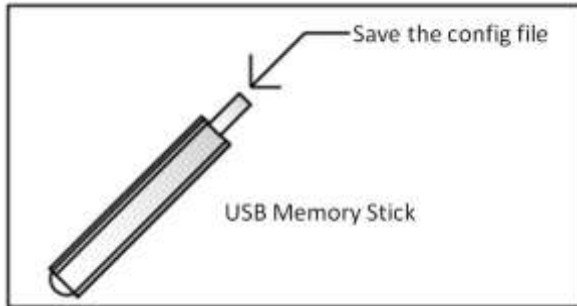

Figure 73 Save configuration file to USB memory

Now as seen on Figure 73 Save configuration file to USB memory configuration file.

### **Configuration Upload**

Take the USB memory stick to DVR unit, you should have already prepared a memory stick with proper configuration on memory stick. Then apply the upload as you see the upload section appears with file name.

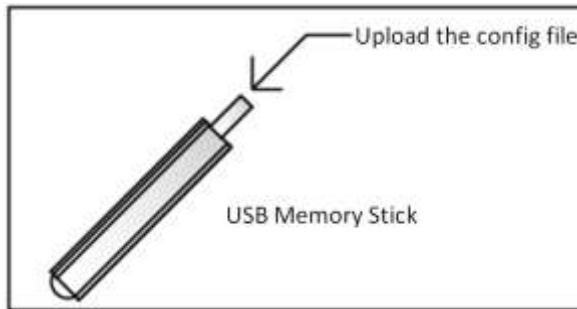

Figure 74 Memory Stick with configuration file

**6. PASSWORD GUI**

This GUI section you can change details for user information, login, authority, and network camera view authority. There are 8 users accounts in our DVR, they are “admin”, “user1”, “user2”, “user3”, “user4”, “user5”, “user6”, and “user7”. They all have default password of “11111111”, and are strongly recommended to be changed. These login accounts are needed when you remotely connect to the DVR and as well as performing password protected function such as HDD format, user authority and other critical operations for DVR.



Figure 75 PASSWORD GUI

**Configuring User ID**

You can register as many as eight system users and they are “admin”, “user1”, “user2”, “user3”, “user4”, “user5”, “user6”, and “user7”.



This is the list of IDs being registered. If you want to edit, select the list and you can move on to “change” menu.

**Modifying User Information**

You can modify information of selected ID (account).

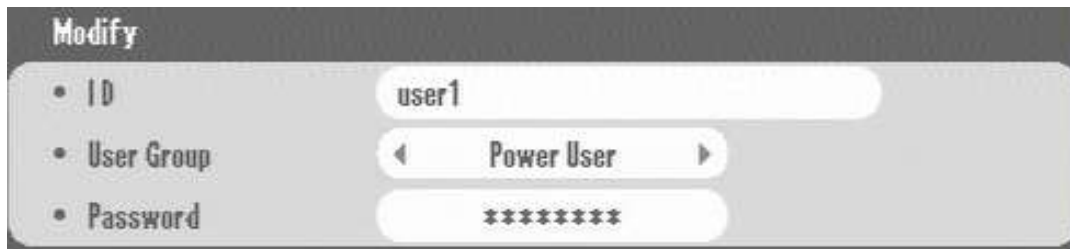

Figure 76 Modify Section for User Information

- ID : Displays ID selected through the list. If you want to change, select and enter through virtual keyboard. You can enter as many as eight character alphanumeric value.
- User Group : The authority is allocated per each group. They may be assigned to users, so it will be easier to configure and easier to group.
  - Admin : Able to use all functions.
  - Power User : Able to use the setup, search and backup function.
  - User : A user can select the authority range.
- Password: Enter up to eight numbers. 11111111 is the default password.

**Configuring User Authority**

Select the authorities for the selected User ID.

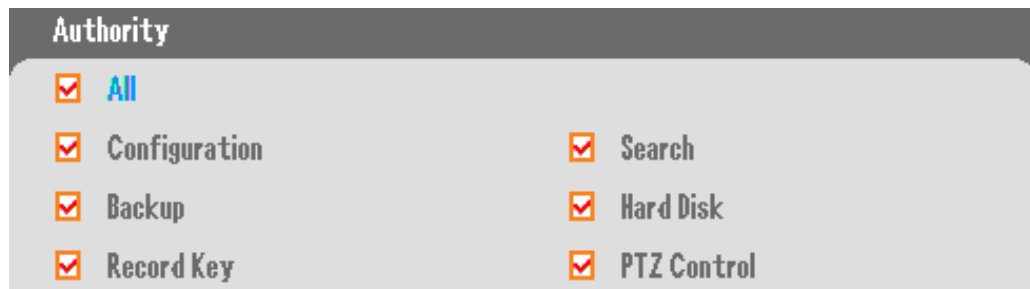

Figure 77 User Authority

- All : Allows full authority.
- Configuration : Allows to set the DVR.
- Search : Allows to search.
- Back up : Allows to backup.
- Hard Disk : Allows to set the HDD such as Overwrite, Auto Delete, etc.
- Record Key : Allows to operate the Schedule Record or Emergency Record.
- PTZ Control : Allows to control the PTZ.

**Configuring Network Covert**

When you choose camera to be hidden, selected camera images are not displayed when it is monitored remotely.



Figure 78 Network Covert User Configuration

You can use the first tick box for “Apply All” or “Cancel All”.



**7. BUTTON SETTING GUI**

Button setting GUI is used to control the audible beep, autokey lock and emergency lock.

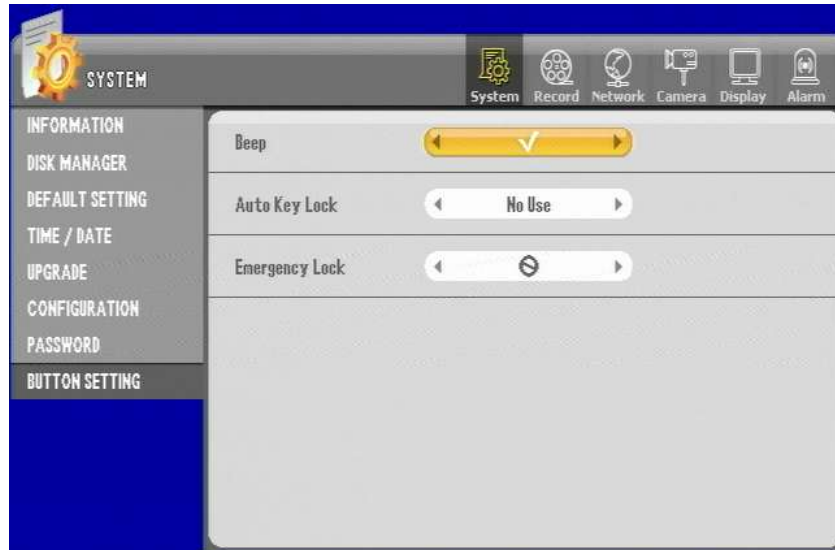



Figure 79 BUTTON SETTING GUI

**Configuration of audible beep**

If it is selected, the DVR beeps on every button press in the front panel.

(  : Beep,  : No Beep)

**Configuration of Auto Key Lock**

If the selected time is passed, the system is locked automatically.



Even if the system is locked, you can select the channel, split screen and sequence viewing. But you have to log on to the system for the operation of other functions.



(If the system is locked, the Icon is changed like the picture above)

**Configuration of Emergency Lock**

This setting locks the emergency recording so that the emergency recording isn't available. In case a user keeps the emergency recording on, it could overuse the HDD or overwrite the existing data. So, you can lock the emergency recording to prevent the problem.

(  : Emergency recording isn't available,  : Emergency recording is available )

## Chapter 10. Record Section In-Depth

In this section we will cover all aspects of record configuration, and how it effects the DVR's performance, storage capacity, recorded image quality and frames per second of recorded video.

### 1. Compression, Resolution, Quality, and Speed of Video

#### Video Compression

This DVR is using the H.264 compression, compression used to compact the size of the video recording that are save to the HDD. The H.264 compression is currently being used to stream HD video in broadcast industry and is being widely accepted as industry standard in compression. Compare to older compression types, H.264 compression uses more complex algorithms to compress video therefore even the TCP/IP streaming videos are adapting this H.264 compression. Compression option is not selectable, yet it is important to understand that this DVR is using the best compression available at the time of product creation.

#### Video Resolution

Our DVR currently support 3 types of video resolution possible for recording and they are resolution measuring at 720 pixels by 480 pixels, 720 pixels by 240 pixels, and 360 pixels by 240 pixels in NTSC format. In PAL format they are 720 pixels by 576 pixels, 720 pixels by 288 pixels, and 360 pixels by 288 pixels. Often they are referenced and marked 720X480 or D1 resolution, 720X240 or 2CIF resolution, 360X240 or CIF resolution for NTSC. Respectively in PAL standard they are referenced as 720X576 or D1 resolution, 720X288 or 2CIF resolution, 360X288 or CIF resolution.

There are two selectable standards for video NTSC or PAL. Reasons for two type of video standards are that some countries decided to use PAL or NTSC standard for television broadcast. In CCTV environment you must correspond to determine what type of cameras are being used and what type of display monitor is being used. Simple rule to remember is that you should matchup equipment with one uniform standard. If you resided in country that uses NTSC for broadcast and are using NTSC monitor, NTSC Camera then you must choose NTSC for video standards setting for DVR unit. Even if you reside in country that uses PAL standards some countries uses NTSC standard due to compatibility of equipments being used. So it is very critical that you identify what types of camera, and what type of monitor will be used for the DVR unit.

**Video Quality**

On our DVR there are 5 levels of video quality. They are marked “Lowest”, “Low”, “Normal”, “High” and “Highest”. Since all H.264 images are compressed from its original images this 5 step of level dictates how much compression will be applied to each individual images being recorded. If you are configuring “Lowest” setting, then you are telling the DVR to use high compression level for each individual image. That means that high compression will yield the smallest data size but will provide the lowest detailed images among 5 levels of video quality. Here are reference files sizes for each image quality in terms of NTSC resolution. These figures may differ depending on complexity of background and patterns being watched by each individual camera because H.264 compression’s performances also are impacted between complex and simple patterns.

NTSC Resolution	“Lowest” setting per image in kilo byte	“Low” setting per image in kilo byte	“Normal” setting per image in kilo byte	“High” setting per image in kilo byte	“Highest” setting per image in kilo byte
720X480 (D1)	4.34 kb	5.50 kb	6.65 kb	8.90 kb	11.15 kb
720X240 (2CIF)	2.00 kb	2.70 kb	3.36 kb	4.10 kb	4.66 kb
360X240 (CIF)	1.12 kb	1.45 kb	1.71 kb	2.30 kb	2.83 kb

Table 2 Data size - Image Quality by Resolution

It is recommended that you try all possible resolution setting and image quality settings before finding most proper image quality before committing recording setting. Be cautious, as higher the image quality setting larger the file size, ultimately shortening number of days of recording.

**Speed of Video**

Speed of images are represented in frames per second calculation. Our DVR may record video in 1, 2, 3, 5, 6, 7.5, 10, 15 and 30 frames per second configuration. If recording is configured to be set on 30fps that represents that for every second there will be 30 images recorded. In our DVR there are some limitations on how much frames may be recorded by channel type of our DVR.

- For 4 channel DVR;  
You may have all 4 cameras recording in 1, 2, 3, 5, 6, 7.5, 10, 15 and 30 frames per second at 360X240, 720X240, and 720X480 resolution.
- For 9 channel DVR;  
You can have 360X240 recording in 1, 2, 3, 5, 6, 7.5, 10, 15 and 30 frames per second.  
You can have 720X240 recording in 1, 2, 3, 5, 6, 7.5, 10, and 15 frames per second all across or have 8 cameras recording at 1, 2, 3, 5, 6, 7.5, 10, 15 and 30 frames per second.  
You can have 720X480 recording in 1, 2, 3, 5, 6, 7.5, and 10 frames per second all across or have 8 cameras recording at 1, 2, 3, 5, 6, 7.5, 10, and 15 frames per second.
- For 16 channel DVR;  
You can have 360X240 recording in 1, 2, 3, 5, 6, 7.5, 10, 15 and 30 frames per second.  
You can have 720X240 recording in 1, 2, 3, 5, 6, 7.5, 10, and 15 frames per second.

You can have 720X480 recording in 1, 2, 3, 5, 6, and 7.5 frames per second.

- For 16 channel DVR combination example;  
You can have 1 camera recording at 720X480 recording 15 frames per second.  
You can have 2 cameras recording 720X240 15 frames per second.  
You can have 2 cameras recording 360X240 15 frames per second.  
You can have rest of the camera 360X240 recording 15 frames per second.

As you could see from the above example you may mix and match configuration to obtain best scenario applicable for your situation.

## 2. Calculating Storage Required

As you have had an opportunity to review compression, resolution, quality, and speed of video, all these factors are needed to intelligently calculate proper storage amount needed for each DVR unit or best configure each video. Here is a simple mathematical formula for your convenience.

HDD Size Per Day by each Camera = number of frames per second X number of seconds in a day (1Day = 60X60X24) X size of image in bytes (see Table 2 Data size - Image Quality by Resolution on page 92).

With above formula here are some reference figures

Resolution	1 camera @ Lowest @ 30fps @ 1 hour	1 camera @ Low @ 30fps @ 1 hour	1 camera @ Normal@ 30fps @ 1 hour	1 camera @ High@ 30fps @ 1 hour	1 camera @ Highest@ 30fps @ 1 hour
360X240	119 MB	153 MB	181 MB	243 MB	299 MB
720X240	211 MB	285 MB	355 MB	433 MB	492 MB
720X480	485 MB	581 MB	702 MB	939 MB	1176 MB

Table 3 30fps by one camera each hour

Resolution	4 camera @ Lowest @ 30fps @ 500 GB HDD	4 camera @ Low @ 30fps @ 500 GB HDD	4 camera @ Normal@ 30fps @ 500 GB HDD	4 camera @ High@ 30fps @ 500 GB HDD	4 camera @ Highest@ 30fps @ 500 GB HDD
360X240	45 days 3 hrs	34 days 21 hrs	29 days 13 hrs	21 days 23 hrs	17 days 20 hrs
720X240	25 days 6 hrs	18 days 17 hrs	15 days 1 hrs	12 days 8 hrs	10 days 20 hrs
720X480	11 days 15 hrs	9 days 4 hrs	7 days 14 hrs	5 days 16 hrs	4 days 12 hrs

Table 4 4ch DVR 500GB by each resolution

Resolution	9 camera @ Lowest @ 500 GB HDD	9 camera @ Low @ 500 GB HDD	9 camera @ Normal@ 500 GB HDD	9 camera @ High@ 500 GB HDD	9 camera @ Highest@ 500 GB HDD
360X240 @ 30fps	20 days 1 hrs	15 days 11 hrs	13 days 3 hrs	9 days 18 hrs	7 days 22 hrs
720X240 @ 15 fps	22 days 6 hrs	16 days 15 hrs	13 days 9 hrs	10 days 23 hrs	9 days 15 hrs
720X480 @ 10 fps	15 days 12 hrs	12 days 6 hrs	10 days 3 hrs	7 days 13 hrs	6 days 1 hrs

Table 5 9ch DVR 500GB by Resolution with max possible frame rate

Resolution	16 camera @ Lowest @ 500 GB HDD	16 camera @ Low @ 500 GB HDD	16 camera @ Normal@ 500 GB HDD	16 camera @ High@ 500 GB HDD	16 camera @ Highest@ 500 GB HDD
360X240 @ 30fps	11 days 6 hrs	8 days 17 hrs	7 days 9 hrs	5 days 11 hrs	4 days 11 hrs
720X240 @ 15 fps	12 days 15 hrs	9 days 8 hrs	7 days 14 hrs	6 days 4 hrs	5 days 10 hrs
720X480 @ 7.5 fps	11 days 15 hrs	9 days 4 hrs	7 days 12 hrs	5 days 16 hrs	4 days 12 hrs

Table 6 16ch DVR 500GB by Resolution with max possible frame rate

These tables represent relative calculation at continuous recording configuration.

**4 Channel DVR Storage Reference Chart**

Here are some examples of easy to reference chart for 4ch DVR. Motion recording results may vary depending on actual circumstances of how DVR is program to record. Such impacting variables are how much motion will each camera will be recording and how sensitive motion detection areas are.

Resolution	Lowest	Low	Normal	High	Highest
500 Giga Byte / Recording Continuous					
360X240 @ 30 fps	45 days 3 hrs	34 days 20 hrs	29 days 13 hrs	21 days 23 hrs	17 days 20 hrs
720X240 @ 30 fps	25 days 6 hrs	18 days 17 hrs	15 days 1 hrs	12 days 8 hrs	10 days 20 hrs
720X480 @ 30 fps	11 days 15 hrs	9 days 4 hrs	7 days 14 hrs	5 days 16 hrs	4 days 12 hrs
500 Giga Byte / On Motion (Considering there is only 35% of recording due to motion)					
360X240 @ 30 fps	128 days 23 hrs	99 days 15 hrs	84 days 11 hrs	62 days 19 hrs	51 days 1 hrs
720X240 @ 30 fps	72 days 5 hrs	53 days 12 hrs	42 days 23 hrs	35 days 5 hrs	31 days 0 hrs
720X480 @ 30 fps	33 days 6 hrs	26 days 6 hrs	21 days 17 hrs	16 days 5 hrs	12 days 22 hrs
1 Tera Byte / Recording Continuous					
360X240 @ 30 fps	92 days 11 hrs	71 days 10 hrs	60 days 13 hrs	45 days 0 hrs	36 days 14 hrs
720X240 @ 30 fps	51 days 18 hrs	38 days 8 hrs	30 days 19 hrs	25 days 6 hrs	22 days 5 hrs
720X480 @ 30 fps	23 days 20 hrs	18 days 19 hrs	15 days 13 hrs	11 days 15 hrs	9 days 6 hrs
1 Tera Byte / On Motion (Considering there is only 35% of recording due to motion)					
360X240 @ 30 fps	264 days 4 hrs	204 days 1 hrs	173 days 0 hrs	128 days 15 hrs	104 days 13 hrs
720X240 @ 30 fps	147 days 22 hrs	109 days 14 hrs	88 days 1 hrs	72 days 4 hrs	63 days 11 hrs
720X480 @ 30 fps	68 days 4 hrs	53 days 19 hrs	44 days 11 hrs	33 days 5 hrs	26 days 12 hrs
6 Tera Byte (2X 3TB HDD) / Recording Continuous					
360X240 @ 30 fps	554 days 19 hrs	428 days 12 hrs	363 days 9 hrs	270 days 3 hrs	219 days 13 hrs
720X240 @ 30 fps	310 days 16 hrs	230 days 3 hrs	184 days 22 hrs	151 days 13 hrs	133 days 8 hrs
720X480 @ 30 fps	143 days 4 hrs	112 days 23 hrs	93 days 10 hrs	69 days 19 hrs	55 days 17 hrs
6 Tera Byte (2X 3TB HDD) / On Motion (Considering there is only 35% of recording due to motion)					
360X240 @ 30fps	1585 days 3 hrs	1224 days 9 hrs	1038 days 5 hrs	771 days 21 hrs	627 days 8 hrs
720X240 @ 30 fps	887 days 16 hrs	657 days 13 hrs	528 days 9 hrs	433 days 0 hrs	380 days 23 hrs
720X480 @ 30 fps	409 days 1 hrs	322 days 19 hrs	266 days 23 hrs	199 days 11 hrs	159 days 5 hrs

Table 7 4ch DVR HDD Reference

**\*Above table is provided only as a guide not as guarantee.**

**9 Channel DVR Storage Reference Chart**

Here are some examples of easy to reference chart for 9ch DVR. Special characteristic of 9 Channel DVR is that recording storages are shared between 9 channels not 8 channels, if it was 8 channels it may have been possible to have 30 fps all across even at 720X240. That is the reason for having this chart calculating its maximum frame rate at CIF 30fps, 2CIF 15fps and D1 at 10fps.

Resolution	Lowest	Low	Normal	High	Highest
500 Giga Byte / Recording Continuous					
360X240 @ 30 fps	20 days 1 hrs	15 days 11 hrs	13 days 3 hrs	9 days 18 hrs	7 days 22 hrs
720X240 @ 15 fps	22 days 11 hrs	16 days 15 hrs	13 days 9 hrs	10 days 23 hrs	9 days 15 hrs
720X480 @ 10 fps	15 days 12 hrs	12 days 6 hrs	10 days 3 hrs	7 days 13 hrs	6 days 1 hrs
500 Giga Byte / On Motion (Considering there is only 35% of recording due to motion)					
360X240 @ 30 fps	57 days 7 hrs	44 days 6 hrs	37 days 13 hrs	27 days 22 hrs	22 days 16 hrs
720X240 @ 15 fps	64 days 5 hrs	47 days 13 hrs	38 days 5 hrs	31 days 7 hrs	27 days 13 hrs
720X480 @ 10 fps	44 days 9 hrs	35 days 0 hrs	28 days 23 hrs	21 days 15 hrs	17 days 6 hrs
1 Tera Byte / Recording Continuous					
360X240 @ 30 fps	41 days 2 hrs	31 days 17 hrs	26 days 22 hrs	20 days 0 hrs	16 days 6 hrs
720X240 @ 15 fps	46 days 0 hrs	34 days 2 hrs	27 days 9 hrs	22 days 10 hrs	19 days 18 hrs
720X480 @ 10 fps	31 days 19 hrs	25 days 2 hrs	20 days 18 hrs	15 days 12 hrs	12 days 9 hrs
1 Tera Byte / On Motion (Considering there is only 35% of recording due to motion)					
360X240 @ 30 fps	117 days 10 hrs	90 days 16 hrs	76 days 21 hrs	57 days 4 hrs	46 days 11 hrs
720X240 @ 15 fps	131 days 12 hrs	97 days 9 hrs	78 days 6 hrs	64 days 3 hrs	56 days 10 hrs
720X480 @ 10 fps	90 days 21 hrs	71 days 17 hrs	59 days 7 hrs	44 days 7 hrs	35 days 9 hrs
6 Tera Byte (2X 3TB HDD) / Recording Continuous					
360X240 @ 30 fps	246 days 13 hrs	190 days 11 hrs	161 days 12 hrs	120 days 1 hrs	97 days 14 hrs
720X240 @ 15 fps	276 days 4 hrs	204 days 13 hrs	164 days 9 hrs	134 days 17 hrs	118 days 12 hrs
720X480 @ 10 fps	190 days 21 hrs	150 days 15 hrs	124 days 14 hrs	93 days 2 hrs	74 days 7 hrs
6 Tera Byte (2X 3TB HDD) / On Motion (Considering there is only 35% of recording due to motion)					
360X240 @ 30 fps	704 days 12 hrs	544 days 4 hrs	461 days 10 hrs	343 days 1 hrs	278 days 19 hrs
720X240 @ 15 fps	789 days 1 hrs	584 days 11 hrs	469 days 16 hrs	384 days 21 hrs	338 days 15 hrs
720X480 @ 10 fps	545 days 10 hrs	430 days 9 hrs	355 days 23 hrs	265 days 23 hrs	212 days 7 hrs

Table 8 9ch DVR HDD reference

**\*Above table is provided only as a guide not as guarantee.**



**16 Channel DVR Storage Reference Chart**

Here are some examples of easy to reference chart for 16ch DVR.

Resolution	Lowest	Low	Normal	High	Highest
500 Giga Byte / Recording Continuous					
360X240 @ 30 fps	11 days 6 hrs	8 days 17 hrs	7 days 9 hrs	5 days 11 hrs	4 days 11 hrs
720X240 @ 15 fps	12 days 15 hrs	9 days 8 hrs	7 days 12 hrs	6 days 4 hrs	5 days 10 hrs
720X480 @ 7.5 fps	11 days 15 hrs	9 days 4 hrs	7 days 14 hrs	5 days 16 hrs	4 days 12 hrs
500 Giga Byte / On Motion (Considering there is only 35% of recording due to motion)					
360X240 @ 30 fps	32 days 5 hrs	24 days 21 hrs	21 days 2 hrs	15 days 16 hrs	12 days 18 hrs
720X240 @ 15 fps	36 days 2 hrs	26 days 18 hrs	21 days 11 hrs	17 days 14 hrs	15 days 12 hrs
720X480 @ 7.5 fps	33 days 6 hrs	26 days 6 hrs	21 days 17 hrs	16 days 5 hrs	12 days 22 hrs
1 Tera Byte / Recording Continuous					
360X240 @ 30 fps	23 days 2 hrs	17 days 20 hrs	15 days 3 hrs	11 days 6 hrs	9 days 3 hrs
720X240 @ 15 fps	25 days 21 hrs	19 days 4 hrs	15 days 9 hrs	12 days 15 hrs	11 days 2 hrs
720X480 @ 7.5 fps	23 days 20 hrs	18 days 19 hrs	15 days 13 hrs	11 days 15 hrs	9 days 6 hrs
1 Tera Byte / On Motion (Considering there is only 35% of recording due to motion)					
360X240 @ 30 fps	66 days 1 hrs	51 days 0 hrs	43 days 6 hrs	32 days 3 hrs	26 days 3 hrs
720X240 @ 15 fps	73 days 23 hrs	54 days 19 hrs	44 days 0 hrs	36 days 2 hrs	31 days 17 hrs
720X480 @ 7.5 fps	68 days 4 hrs	53 days 19 hrs	44 days 11 hrs	33 days 5 hrs	26 days 12 hrs
6 Tera Byte (2X 3TB HDD) / Recording Continuous					
360X240 @ 30 fps	138 days 16 hrs	107 days 3 hrs	90 days 20 hrs	67 days 12 hrs	54 days 21 hrs
720X240 @ 15 fps	155 days 8 hrs	115 days 1 hrs	92 days 11 hrs	75 days 18 hrs	66 days 16 hrs
720X480 @ 7.5 fps	143 days 4 hrs	112 days 23 hrs	93 days 10 hrs	69 days 19 hrs	55 days 17 hrs
6 Tera Byte (2X 3TB HDD) / On Motion (Considering there is only 35% of recording due to motion)					
360X240 @ 30 fps	396 days 6 hrs	306 days 2 hrs	259 days 13 hrs	192 days 23 hrs	156 days 20 hrs
720X240 @ 15 fps	443 days 20 hrs	328 days 18 hrs	264 days 4 hrs	216 days 12 hrs	190 days 11 hrs
720X480 @ 7.5 fps	409 days 1 hrs	322 days 19 hrs	266 days 23 hrs	199 days 11 hrs	159 days 5 hrs

Table 9 16ch DVR HDD reference

**\*Above table is provided only as a guide not as guarantee.**

### 3. EVENT RECORDING GUI

In this section of GUI you can set the Resolution, Frame and Event, etc. necessary to recording.

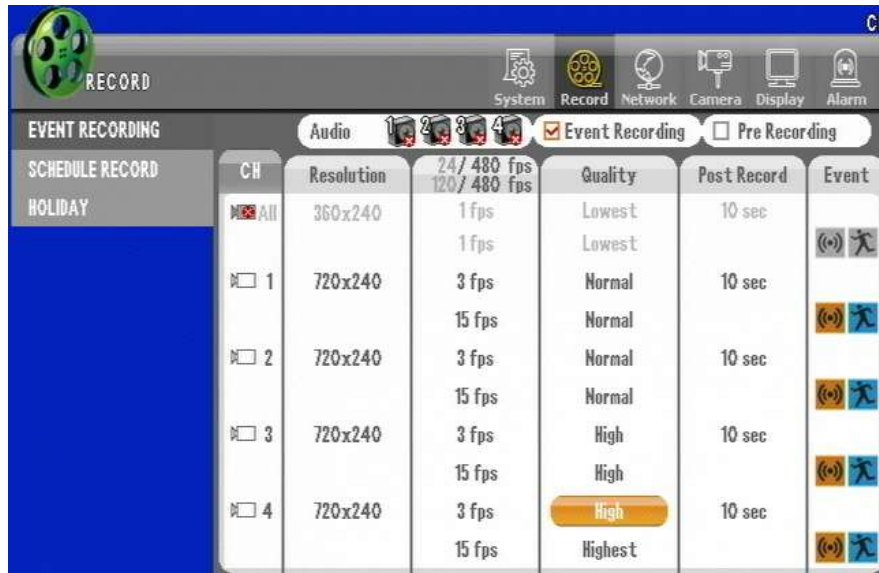

#### Configuring Pre Recording

When an event is triggered, this setting enables pre-recording around 1 to 5 seconds earlier. The pre-recording time is variable depending on the resolution and frame setting. It would be longer if the low resolution and frame are set. And the longest pre-recording time is 5 seconds.



#### Configuring Event Recording



This setting enables the event recording previously set when an event is triggered.

In the center of the EVENT RECORDING GUI you will see the selectable area where you could choose camera, resolution, fps, image quality, post record configuration and event selector.

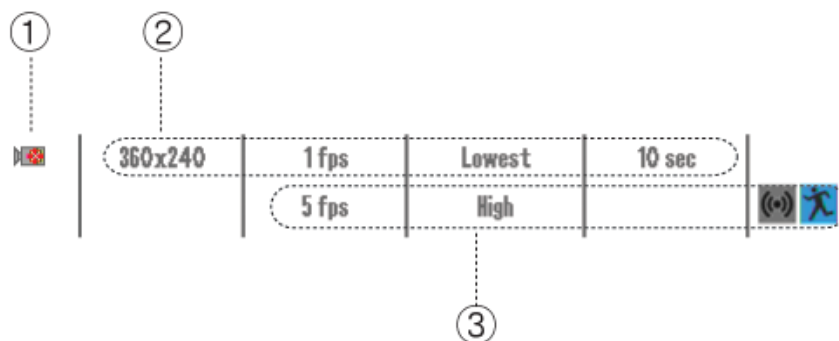

Figure 80 Recording Configuration

### ① Camera selector (Global or individual)

Here in this camera icon you may select to use it or not use it. Below



### ② Resolution, Speed (fps), Image quality, Post record configuration

These selectable variables are possible option configuration for continuous recording setup. Here you can set the resolution, frame, quality, post recording and audio independently.

- Resolution: Select the size of recording image  
Selection ranges are 720X480, 720X240, 360X240 for NTSC and for PAL 720X576, 720X288, 360X288
- fps section: Select how many frames per second that each camera will record.

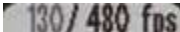
If you see on the top of this section column you will see a number marked similar to following indication 

It is representing that base of 480 fps all combined configuration of fps selection is within the boundaries of 480 fps or not. It is shown numerically and if combination of fps exceeds it will be marked in red number.

480 fps base means that if there are 16 cameras with 360X240 resolution each recording at 30 fps then total fps capable of DVR is 480 fps combined. Then if one camera is set to 720X240 at 15 fps or

720X480 at 7.5 fps those are equivalent to 360X240 resolutions at 30 fps. So if you set 720X480 at 30 fps then it is equivalent to 360X240 at 120 fps so just on camera configuration of 720X480 at 30 fps you will change the fps indicator to “120/480”

- Quality: Select the quality of recording image. There are five quality levels to select. The higher the picture quality is, the bigger the data size is. (Lowest < Low < Normal < high < Highest)
- Post recording: After the event is triggered, set the period of time to continue the recording. (Range: From 10 to 300 seconds)

③ Resolution, Speed (fps), Image quality, Post record configuration especially for those that are applied to event such as motion or alarm events. If an event is triggered in the middle of continuous recording, the recording mode is switched into event recording. And if the event is finished, it returns to the continuous recording mode.

- The setup for resolution, quality and post recording are same with the setting on Continuous recording
- Select the event: When an event is triggered, the event recording previously set is started.



(Unselected Sensor – Grey)



(Selected Sensor – Orange)



(Unselected Motion – Grey)



(Selected Motion – Blue)

## 4. SCHEDULE RECORDING GUI

You can schedule the recording time per time or channel or day of the week or holidays. As it also provide the event recording by the motion and sensor. When the schedule recording is in operation, “SR” is displayed like the picture as below.



Figure 81 Main Display Indication

How to set : Call the Menu → Record → Schedule Record

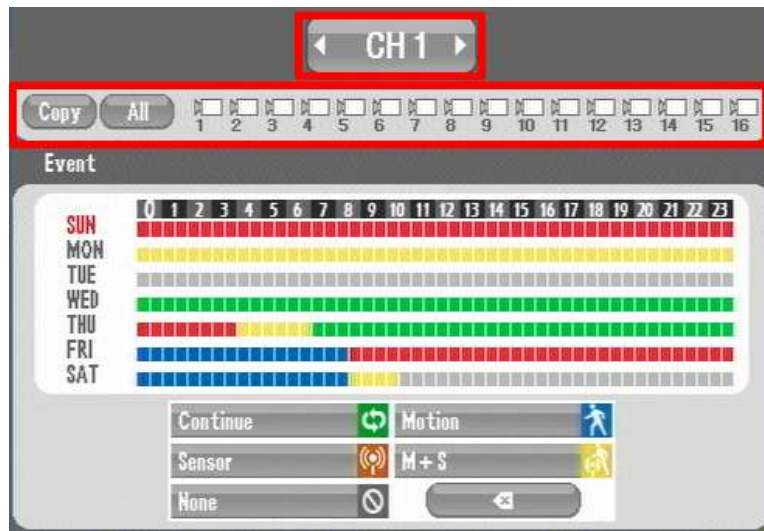

### Select the channel

Select the channel to record

### Set the recording schedule

When scheduling, you can also select the recording mode such as Continue, Motion and Sensor, etc. You can schedule the recording mode by mouse dragging after clicking the recording mode. Or you can select the recording mode by using the sequential change of the recording mode as the color changes per every single click.

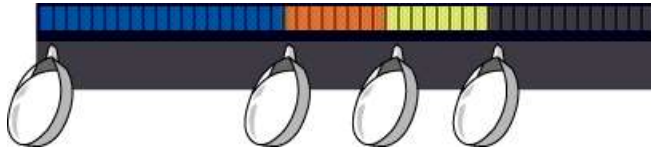

Motion: record when motion occurs



Sensor: record when sensor is in operation



Motion or sensor: record when either of motion or sensor occurs



Continuation: record regardless of event



Erase schedule



Erase all

### Copy

Apply the same settings to the other channel.

You can also apply the same setting values to the multiple channels.



(Not use)



(Use)

### 5. HOLIDAY GUI

You can set the recording for the holidays you designated.

How to set: Call the Menu → Record → Holiday



Figure 82 Holiday Scheduling GUI

**Select the channel**

Select the channel to apply the schedule

**Select holidays**

Select holidays on the calendar to have them marked with red color. Then, holiday recording is applied to the selected date.

**Set the recording schedule**

When scheduling, you can also select the recording mode such as Continue, Motion and Sensor, etc. You can schedule the recording mode by mouse dragging after clicking the recording mode. Or you can select the recording mode by using the sequential change of the recording mode as the color changes per every single click.

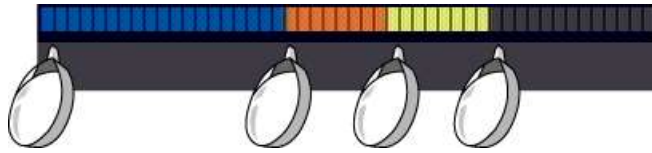

**Copy**

Apply the same settings to the other channel. You can also apply the same setting values to the multiple channels.



(Not use)



(Use)

**Delete**

Enter the first and last date and then press Delete to remove the saved holidays within the range.

Clear Holiday	
First	2010 01 - 01
Last	2010 01 - 01



## Chapter 11. Network Section In-Depth

### 1. About Network Section and Clients

The Network Settings menu enables the user to configure the DVR to be viewed, controlled, and maintained remotely by using the Remote Connection Application(s) (Included on the application disk that came with your DVR):

1. CMS (Central Management System – multiple connections to multiple DVR's at a time)
2. PRMS (Personal Remote Management System – single connection to a DVR at a time)
3. Macintosh PRMS (Personal Remote Management System – single connection to a DVR at a time, **remote setup is not supported with our Macintosh PRMS**)
  - Mobile Remote Applications (Smart Phone Viewers)
    1. Blackberry RMS
    2. Windows Mobile RMS
    3. Symbian (Nokia) RMS
    4. iPhone RMS (downloadable from the App Store)
    5. Android RMS (downloadable from the Google Market)

**NOTE...** Our Blackberry, Windows Mobile, and Symbian RMS' are restricted to Live View & PTZ control only due to the hardware limitations with these phones. Our Android and iPhone RMS' support Live View, Search, Remote Relay Control, and PTZ Control

## 2. IP ADDRESS GUI

To access IP ADDRESS GUI select Network then IP Address Menu

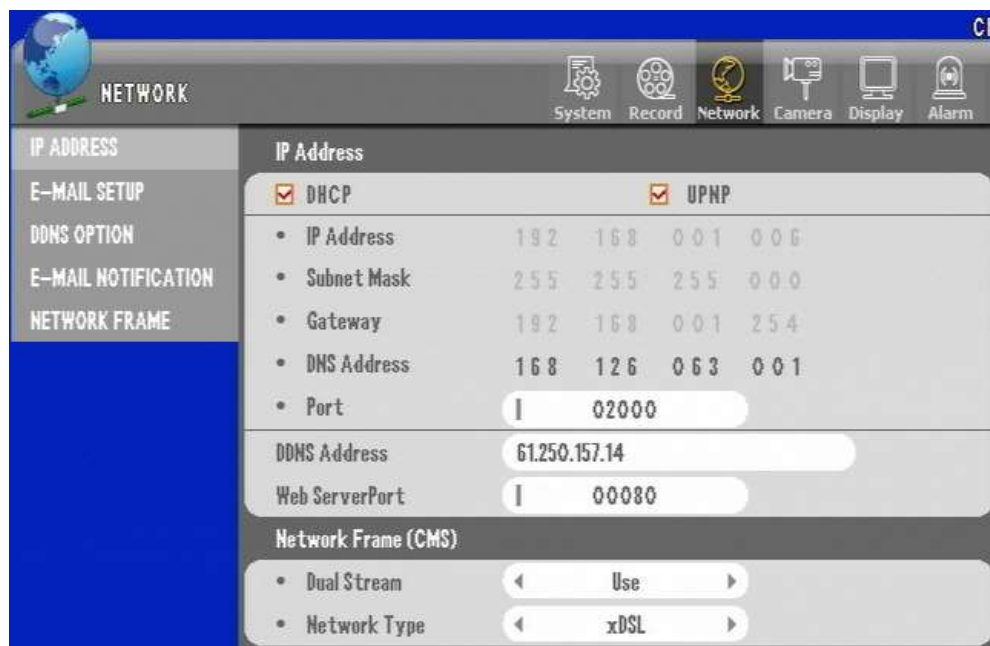

Figure 83 IP ADDRESS GUI

The IP (Internet Protocol) Address is a logical address that is assigned to the DVR for presence on the network. This address is used as an identifier for the remote access application when remotely connecting to the DVR. A different IP address must be assigned to each DVR or device on the same network. Having multiple DVRs' or network devices with the same IP address will result in an IP conflict, which can possibly crash your network. It is very important that every DVR or device on your network has a unique IP address.

### DHCP (Dynamic Host Control Protocol)



Figure 84 DHCP Selector

The DHCP check box option is selected to enable your DVR to obtain an IP Address automatically from your DHCP Server, which is usually your router or a dedicated DHCP server. The IP Address field will be configured/filled automatically by using this option. The benefit of this option is for a hassle free method for IP address assignment. But if your DVR is behind a firewall, and port forwarding is configured, this may cause a connection issue if your DVRs' IP address changes after a DVR or network reboot. **Please consult your Network Administrator for the best configuration method for your network.**

**Note... What is port-forwarding?**

Port forwarding allows remote computers, for example, computers on the Internet, to connect to a specific computer or device, like a DVR, within a private local area network (LAN) through the firewall (security feature that blocks inbound network traffic).

When configuring port forwarding, the network administrator sets aside one port number per network device on the gateway (router) for exclusive use of communicating with the device in the private network. The remote computer must know this port number and the address of the gateway to communicate with the network-internal service.



If the DHCP check box option is NOT selected, the user will have to manually assign an:

IP Address				
<input type="checkbox"/> DHCP				
• IP Address	192	168	001	100
• Subnet Mask	255	255	255	000
• Gateway	192	168	001	001
• DNS Address	168	126	063	001
• Port	02000			

IP Address

Subnet Mask Address

Gateway Address

DNS Address

The Port number by default is 3000. This can be changed to the requirements of your network.

to the DVR. The IP address assigned must match the IP Address scheme of the network the DVR is connected to. For example:

Gateway Address.....192.168.0.1

Subnet Mask Address..... 255.255.255.0

IP Address must be..... 192.168.0.X (x = a number between 2 and 254 because 255 is reserved for the subnet address and 1 is set as the gateway address)

**DDNS Address**

DDNS (Dynamic Domain Name Service) is a feature that can automatically update a dynamic IP Address (ex. 10.10.10.01) using a domain name (ex. <http://DVR.DDNSIP.NET>). This service enables an user with a Dynamic IP Address to have a static domain name for hassle free remote access to their DVR(s).

The address you see here by default is the IP Address to a general DDNS server. Please DO NOT change this address while configuring your DVRs' network settings. **The changes you make under the DVRs' "DDNS OPTION" menu will not be affected by this address.**

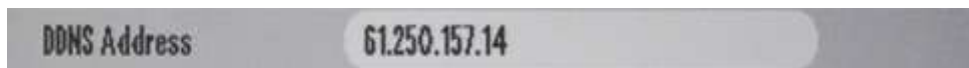

### Transmission Option

The Transmission Option menu is used to either enable or disable the DVRs' Dual Stream function.

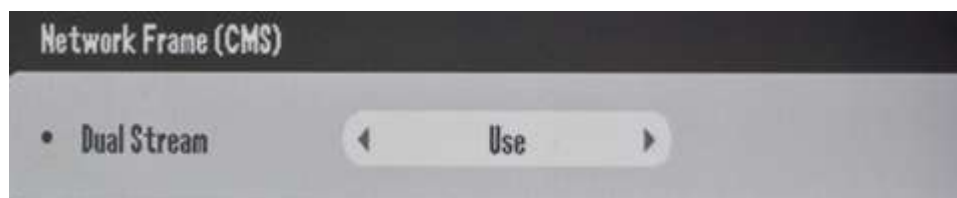

Figure 85 Dual Stream Option

### **What is the Dual Stream Function?**

This DVR is capable of having independent Recording settings (Resolution/Frame Rate/Video Quality) from what is transmitted over the network. The Dual Stream function enables users with slower internet connection speeds to maintain a high recording setting (Resolution/Frame Rate/Video Quality) while lowering the resolution (preset at CIF – 360x240 pixels) for faster frame rate transmissions over your network. Enable this feature by setting it to "Use", disable this feature by setting this option to "Not Use".

### Web Server Port



This DVR has two methods for remote access, the client software (CMS, PRMS, Mobile, Mac PRMS) and web browser (Internet Explorer Version 6 and up ONLY). Remote Client Software access uses the "Port" number mentioned above under the "DHCP" section. Web browser (Internet Explorer) access uses the web server port number. The default value is port number 80 (the standard web server access port number). This port may be changed to comply with your current network configuration. If the web server port number is changed, you must make sure to specify the port number when entering the DVRs' IP address or DDNS for remote access. For example:

If the web server port was changed to 85, then you must enter –

<http://10.10.10.1:85/> (when using the IP address), or

<http://DVR.DDNSIP.NET:85/> (when using DDNS)

## 3. E-MAIL SETUP GUI

SMTP Server	smtp.naver.com
Use Port	00025
<input checked="" type="checkbox"/> Account	
• ID	jsyang
• Password	268573000
Mail Address	
<input checked="" type="checkbox"/> From	jsyang@naver.com
• To	soon@yahoo.com

This DVR supports email notification for events. This section is used to setup the email server and account settings to send these notifications by email:

SMTP Server	smtp.naver.com
-------------	----------------

**SMTP (Simple Mail Transfer Protocol) Server** – This is the outgoing email server address.

Use Port	00025
----------	-------

**Use Port** – This is the port number used by the outgoing email servers.

<input checked="" type="checkbox"/> Account	
• ID	jsyang
• Password	268573000

**Account** – The email account (ID) and password (password) used for the outgoing email server. Select this check box option if your outgoing email server requires authentication.

<input checked="" type="checkbox"/> From	jsyang@naver.com
--	------------------

**From** – Enter the senders email address for email notifications.



The image shows a screenshot of an email setup interface. On the left, there is a grey vertical bar with a bullet point and the label "To". To the right of this bar are three stacked, rounded rectangular input fields. The top field contains the text "soon@yahoo.com". The middle and bottom fields are empty, each containing a vertical cursor line.

**To** - Enter the recipients email address, where the notifications are emailed to. You can set up to three email addresses.

**4. DDNS OPTION GUI**

DVR's DDNS service offers built in DDNS services or if chosen offers other DDNS services available by following DDNS sites:

[www.dyndns.org](http://www.dyndns.org)

[www.no-ip.com](http://www.no-ip.com)

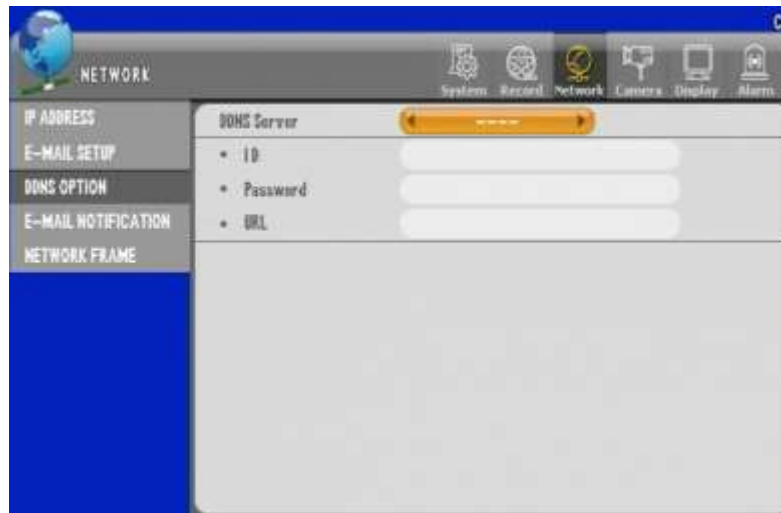

Figure 86 DDNS OPTION GUI

These are two built in services with this DVR. Please select either service and specify the following:

ID – The ID registered with either dyndns.org or no-ip.com

Password – The Password registered to the corresponding ID with either dyndns.org or no-ip.com

URL (Uniform Resource Locator) – The domain name registered with either dyndns.org or no-ip.com

**Built in DDNS Server setup**

There is a third DDNS server that we offer free of any charges. Follow the instructions below:

1. Access The DVRs' "System" menu, then "Information"
2. Make a note of the "Webcode"



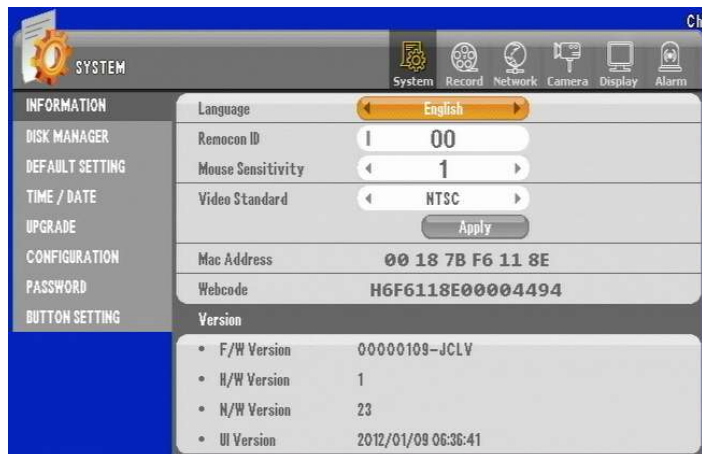

Figure 87 System Information GUI

Enter the Webcode and DVRs' Domain Name. It can take up to 30 minutes for the registration process.

Access your DVR via Internet Explorer by entering:  
 "The DVR DOMAIN Name.DDNSIP.NET  
 Make sure all port forwarding rules have been set on your firewall. YOU MUST SPECIFY THE WEB SERVER PORT IF CHANGED UNDER THE DVRs'

3. Go to <http://www.ddnsip.net> . Enter the "Webcode" and domain name of your DVR. Then press the "Register" button. You will receive a "Registration Success" message if your DVR was registered. Please note that the domain name must be unique to every domain name registered with our DDNS service.



### **DDNSIP.Net example**

Free DDNS is used for remote connection through private DDNS service. (In case of dynamic IP user, it is recommended to use the private DDNS service instead of using manufacturer's DDNS server)

Firstly, go to <http://www.dyndns.com> to create an account. Then, if your DVR is connected to a router, you must do the DMZ setting for your DVR IP in the router setup. DMZ is a function to open all the ports for the selected IP.

For example, here is the way how to create an account with the name of hongkildong.

[1] For creating an account, visit the website: <http://www.dyndns.com>



Figure 88 DynDns.com Site

[2] Create the sub domain name (Example: DVR-Sample) and select the main domain name provided with free. A user may select any name and then click the “ADD” button.

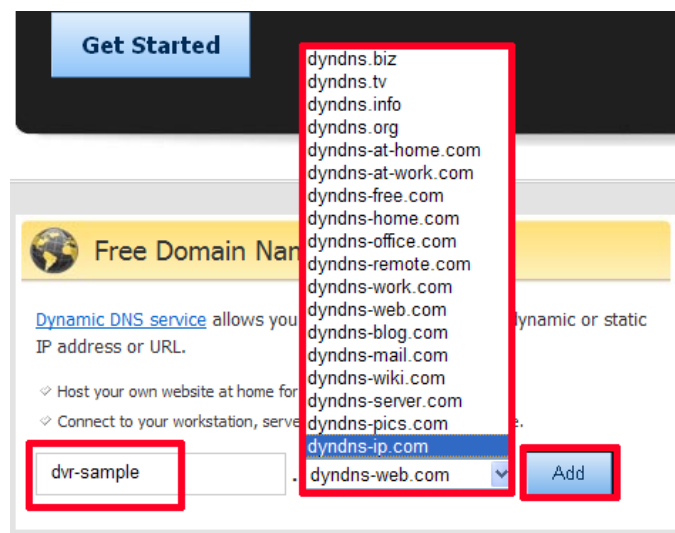

Figure 89 Free DNS using dynds-ip.com

[3] Then, input the detailed user information. After filling in user name, password and e-mail address, etc., then click “Create Account” button. For e-mail verification, receivable e-mail address is required.

Create account or log in to continue checkout:

Username: hongkildong

Password: \*\*\*\*\*

Confirm password: \*\*\*\*\*

Email: y2kjoy@naver.com

Confirm Email: y2kjoy@naver.com

Security Image:   
Enter the numbers from the above image: 73114

Subscribe to:  DynDNS.com newsletter (1 or 2 per month)  Dyn Inc. press releases

I agree with the [acceptable use policy \(AUP\)](#) and [privacy policy](#).  
Your agreement to the AUP is required before we can create your account.

Already Registered?

Username:

Password:

[Forgot your password?](#)

Figure 90 Creating account in DynDns.com

- [4] When you see that the e-mail has been sent to you for verification, then check the e-mail.

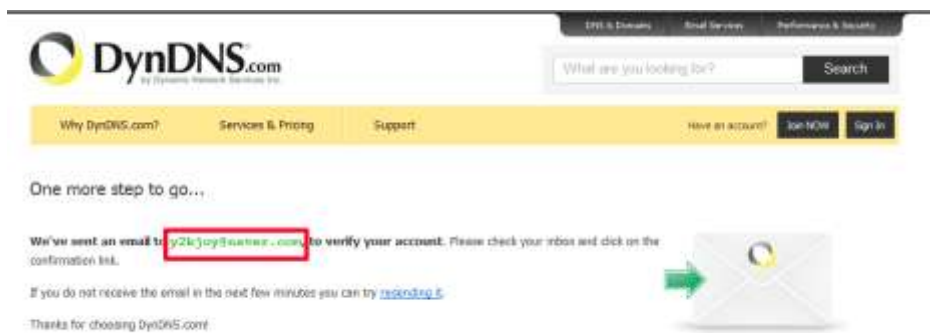

Figure 91 Confirmation Email

- [5] After opening the verification e-mail, if you click the link, the verification is proceeded automatically.

Your DynDNS.com Account 'hongkildong' has been created. You need to visit the confirmation address below within 48 hours to complete the account creation process:

<https://www.dyndns.com/confirm/create/7rlxBDm8xrjmarhmoJkJJA>

Our basic service offerings are free, but they are supported by our paid services. See <http://www.dyndns.com/services/> for a full listing of all of our available services.

If you did not sign up for this account, this will be the only communication you will receive. All non-confirmed accounts are automatically deleted after 48 hours, and no addresses are kept on file. We apologize for any inconvenience this correspondence may have caused, and we assure you that it was only sent at the request of someone visiting our site requesting an account.

Sincerely,  
The DynDNS.com Team  
Dynamic Network Services Inc.

[6] If the e-mail verification is completed, you can enter into the following website.

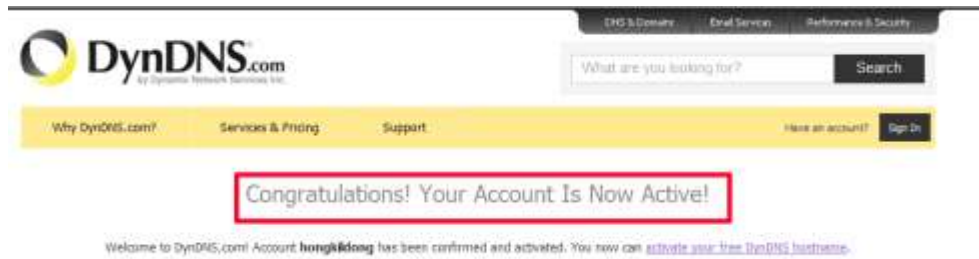

Figure 92 Active Notification

[7] After log-in, click “My Zones/Domains” in “My Service” menu.



Figure 93 My Zone – DynDns.com

[8] Then, click “Dynamic DNS Hosts” in the menu on the left.

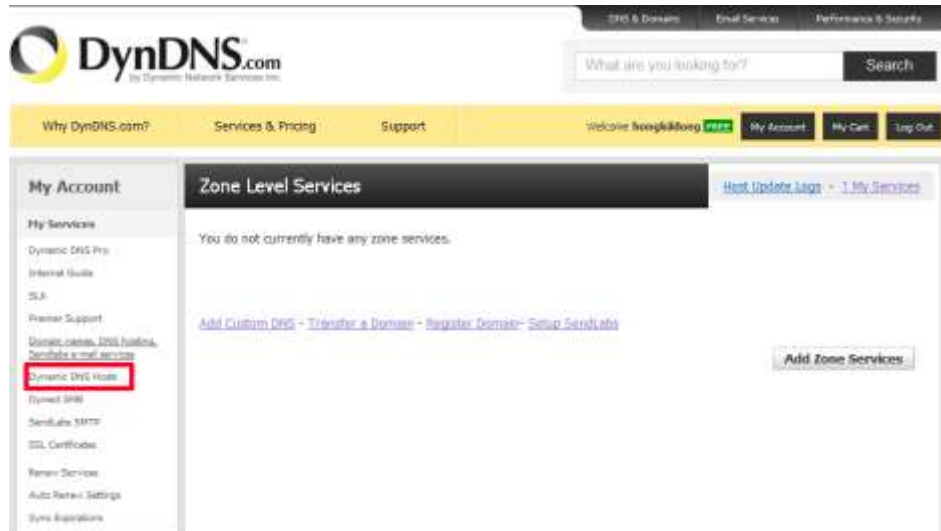

Figure 94 Host - DynDNS.com

[9] Click the firstly registered domain(dvr-sample.dyndns-ip.com)



Figure 95 Check IP - DynDNS.com

[10] Input the public IP of installed router for IP Address. You can find the public IP of the router when you check the router setup. When you complete the input, click “Save Changes”.

Figure 96 IP Address - DynDNS.com

[11] To activate the registered domain, click “Checkout to Activate.”

Hostname	Service	Details	Last updated
dvr-sample.dyndns-ip.com	Host	<a href="#">Checkout to Activate</a>	May, 03, 2011 2:55 AM

Figure 97 Activate - DynDNS.com

[12] Then, click “Proceed to checkout” button below.

**Upgrade Options**

Free accounts allow only two Dynamic DNS Hosts.

- + to add more and enjoy additional benefits for only \$15.00 per year, [purchase Dynamic DNS Pro.](#)
- + to get Dynamic DNS for **your own domain**, use [Custom DNS.](#)

Dynamic DNS Hosts	remove	price
dvr-sample.dyndns-ip.com	<a href="#">remove</a>	\$0.00

Order Total: \$0.00

[Proceed to checkout](#)

[13] And click “Activate Services” below.

Once you have confirmed the contents of your cart your services will be instantly activated.

Service	Period	Price
<b>Dynamic DNS Hosts</b>		
dvr-sample.dyndns-ip.com	-	\$0.00
<b>Sub-Total:</b>		<b>\$0.00</b>

**Activate Services >>**

[14] Then, selected domain IP is activated.

Hostname	Service	Details	Last Updated
<a href="#">dvr-sample.dyndns-ip.com</a>	Host	115.95.186.197	May. 03, 2011 3:41 AM

[Host Update Logs](#)  
[Bulk Update IP Address And Service Type](#)

**Add New Host**

[15] Enter the ID/PW and domain set to the DVR. It's for the routine renewal when the IP is changed.

DDNS Server	DynDns
• ID	hongkildong
• Password	6785543
• URL	dvr-sample.dyndns-ip.com

(Example)

[16] Enter the domain name registered in the URL address to connect.



Note: The service is available after 10 to 30 minutes since the subscription

## 5. EMAIL NOTIFICATION GUI



Figure 98 Email Notification Section

This menu is used to select the type of events that will be sent by the email notification feature:

**Mail Title** – The subject like of the email notification

**Interval** – How often the email notification will be sent, e.g. an email notification one minute, every 5 minutes, etc...

**Sensor** – When a sensor is triggered (Any sensor or trigger device connected to the Sensor in ports on the DVR)

**Motion Detection** – When motion is sensed on a specific camera(s)

**Video Loss** – When a specific camera(s) loses its' video signal

**Power On** – When the DVR reboots or is powered on

**Password Modify** – When a password is changed for a user account on the DVR

**HDD Error** – When there is an internal error on the hard drive of the DVR, e.g. temperature threshold exceeded or failure to recognize the hard drive.



**6. NETWORK FRAME GUI**

CH	120/120 fps	Quality	CH	fps	Quality		
<input checked="" type="checkbox"/>	1 fps	Lowest	<input type="checkbox"/>	9	7.5 fps	Normal	
<input type="checkbox"/>	1	7.5 fps	Normal	<input type="checkbox"/>	10	7.5 fps	Normal
<input type="checkbox"/>	2	7.5 fps	Normal	<input type="checkbox"/>	11	7.5 fps	Normal
<input type="checkbox"/>	3	7.5 fps	Normal	<input type="checkbox"/>	12	7.5 fps	Normal
<input type="checkbox"/>	4	7.5 fps	Normal	<input type="checkbox"/>	13	7.5 fps	Normal
<input type="checkbox"/>	5	7.5 fps	Normal	<input type="checkbox"/>	14	7.5 fps	Normal
<input type="checkbox"/>	6	7.5 fps	Normal	<input type="checkbox"/>	15	7.5 fps	Normal
<input type="checkbox"/>	7	7.5 fps	Normal	<input type="checkbox"/>	16	7.5 fps	Normal
<input type="checkbox"/>	8	7.5 fps	Normal				

Figure 99 Network Frame GUI

The Network Frame menu needs to be configured if you enable the “Dual Stream” feature. This menu is used to configure at what frame rate and video quality the DVR will stream over the network while using Dual Stream. Please refer to Figure 85 Dual Stream Option on page 108.

The frame rate and video quality can be configured per channel. A specified channel can be disabled or enabled by selecting the camera icon located to the right of the channel number.

Camera Enabled

Camera Disabled

You have a maximum of 120 frames to distribute amongst the available channels.

## Chapter 12. Camera Section In-Depth

In This section we will be covering Camera section, where there are controls for adjusting property, naming, PTZ, and viewing aspects of the Camera.

### 1. CAMERA SETTING GUI

Camera Settings GUI has option to control Covert, AGC, Static Gain, Brightness, Contrast and Hue.

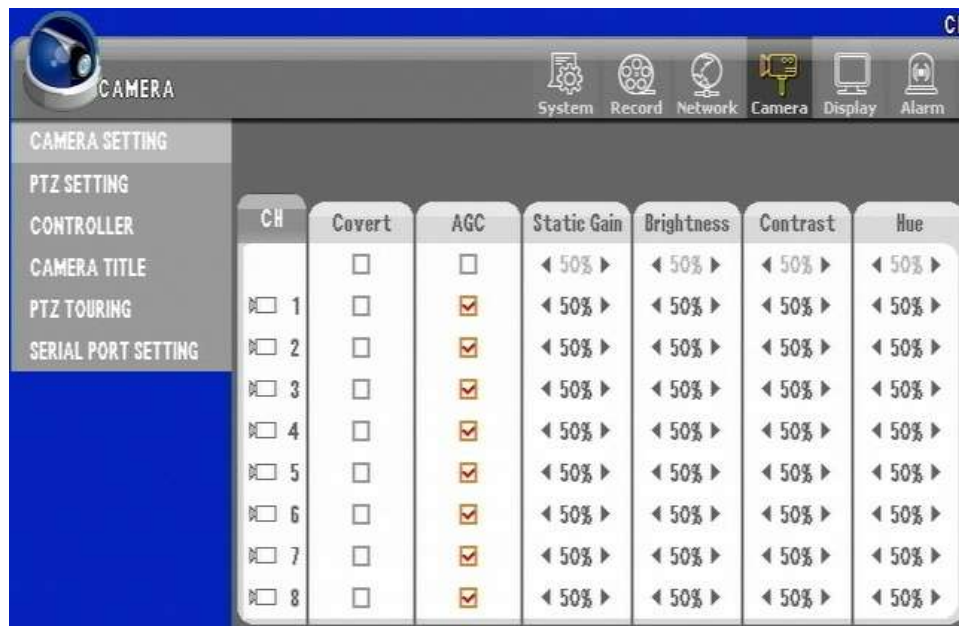

Figure 100 Camera Setting GUI

**Covert:** Controls the camera to be displayed on the Live view or not. As long as camera is chosen on the “CH” section it will conduct the recording even if you choose to have it chosen to covert.

**AGC:** AGC is short for Automatic Gain Control. It will determine the best possible gain option for the camera to show proper signal gain. Gain control is needed for those cameras that are installed far away. They often times loose signal strength and with Gain control you may improve the signal strength. AGC will try to detect the level of the signal and try to compensate internally.

**Static Gain:** Static Gain option only gets enabled if you do not choose to use the AGC feature. Unlike the automatic gain the static gain control enables the option to increase and decrease the gain by user intervention. Use this option if you need to fine tune the camera’s gain to desire output.

**Brightness:** Brightness controls enable the camera to be dim or bright in selectable level increments in 5% every step by 0%~100%.

**Contrast:** Contrast controls enable the camera to be sharper line edges in 0~100% level.

**Hue:** Controls the hue of the camera visual in range of 0~100% level.

**2. PTZ SETTING GUI**

In PTZ setting GUI there are 2 different menu screens as described below.



Figure 101 PTZ Setting GUI 1



If you press the  then the additional PTZ setting can be defined.

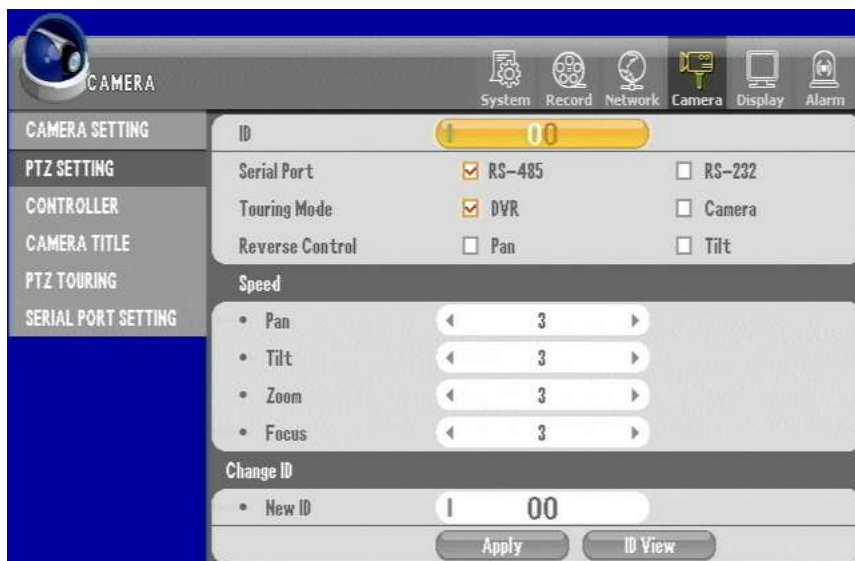

Figure 102 PTZ Settings GUI 2 - Additional Settings

[Note] In case of using more than one PTZ camera, ID should be different. Refer to PTZ camera manual for changing the ID.

### Additional PTZ setting

Select the icons described below.



- Serial Port : Select "RS-485" or RS-232 for the PTZ camera control.

- Reverse Control : Moves reversely when PTZ moves.
  
- Touring Mode
  - DVR : A PTZ camera works by the touring configuration set in DVR.
  - Camera : A PTZ camera works by the touring configuration set in PTZ camera.
  
- Speed: Set the response speed for each feature. (Default: 3)
  
- Change ID : Select "ID View" to be informed of or change PTZ camera's ID. Enter "Changed ID" and then select "Apply." (If the change is not permissible, you should directly change through the PTZ camera.)

### 3. CONTROLLER GUI

You can connect a keyboard to operate the DVR. And the joystick control is very convenient to PTZ control.



Figure 103 Controller GUI

**Model:** Select the model to connect to the DVR. You should check the compatibility between the keyboard and DVR before purchasing.

**Controller ID:** The default value is “0” for the ID. If you want to use different ID, you should change the keyboard ID too.

**Serial port:** Use “RS-485” or “RS-232”

Note: Refer to the instruction manual for the detailed keyboard operation.

**4. CAMERA TITLE GUI**

You may change the title of the camera to give more geographical name or any desire name.

Sometime camera location may be identified easier by giving logical name to the camera. Here are steps to give logical name label instead of having default label.

Step 1. Select “Camera” item on upper main category and select CAMERA TITLE

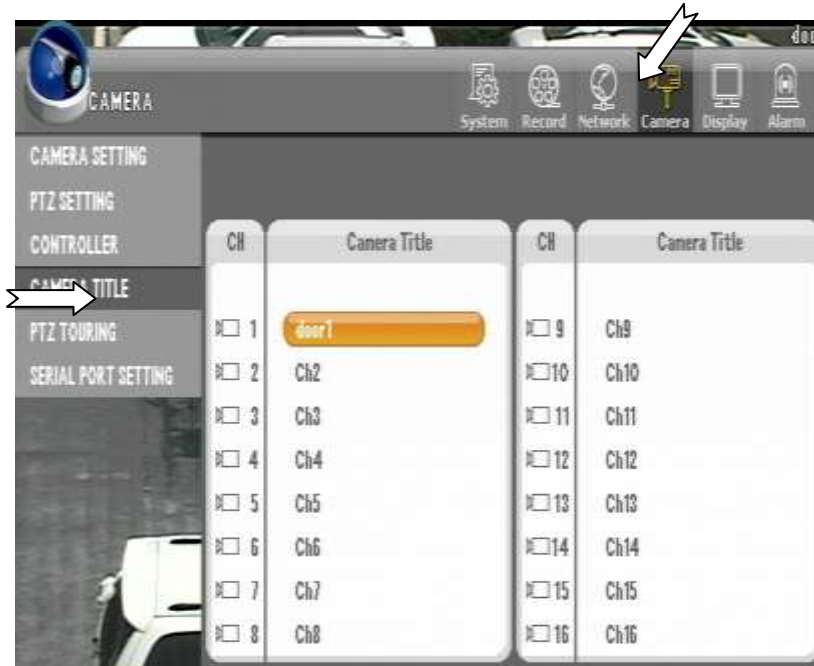

Figure 104 Camera Title Menu

Here you may choose camera(s) that you want to give logical name and repeat to other camera(s) as needed. In this example we have chosen Camera 1 marked Ch1 and will change the label to door1.

Step 2. Click Camera Number to change then use the on screen key pad to change the label as shown below. When done giving name select and choose OK to end typing.



Step 3. Exit the menu and select YES to apply the setting

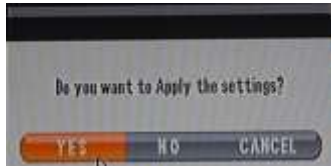

Names of the camera must be changed each individually and they are shown on both the live and recorded playback.

On CMS and other mobile clients will also show the changed camera labels.

### 5. PTZ TOURING GUI

This setting allows the PTZ camera to move repeatedly by previously selected order.

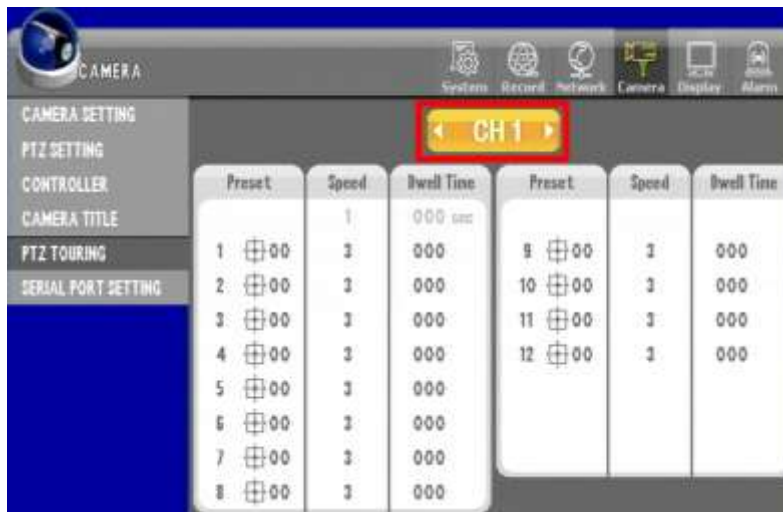

- Select channel : Select a channel to install PTZ camera.
- Preset : Select preset number
- Speed : Select speed
- Dwell Time : Select the stop period of PTZ Camera  
 [Note] Up to 12 presets is available.



**6. SERIAL PORT SETTING GUI**

Serial Port Setting GUI is divided in RS-485 and RS-232 section as shown below.



Figure 105 Serial Port Setting GUI

Set Baud Rate, Parity and Stop Bit for RS-485 and RS-232 communication.

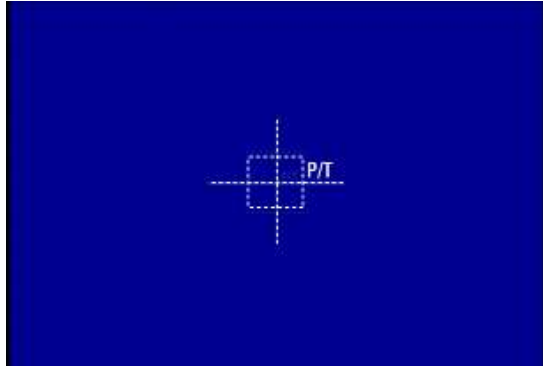

Figure 106 Baud Rate, Parity and Stop Bit

The Setting is variable depending on the PTZ camera model. Refer to the manufacturer’s manual.

**7. How to operate PTZ camera**

Select a channel and press the “PTZ” button to call PTZ control OSD.



[By using the front direction button (Or remote controller)]

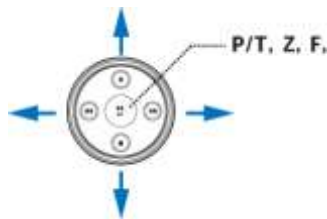

- Use the direction button to move the PTZ camera.
- Whenever pressing the Enter button, the feature changes in the order of Pan/Tilt, Zoom and Focus. Use buttons on the right and left side to move.

[By using the mouse]

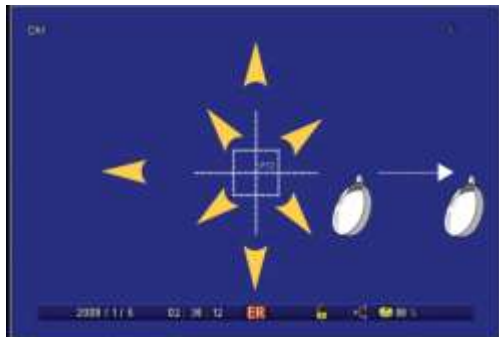

- To call the PTZ control menu, scroll the mouse wheel. Then, the feature changes in the order of Pan/Tilt, Zoom and Focus.

- Pan/Tilt : Click the mouse on the screen to move.
- Focus : Click the right or left on the screen to adjust focus.
- Zoom : Click the right or left on the screen to control zoom.

[PTZ menu]

On the front panel, if you select PTZ button from the PTZ mode, the function menu is displayed as below.



	Able to change direction of pan-tilt camera
	Able to change into "extend and minimize pan-tilt"
	Able to change into camera focus mode
	Touring feature
	Able to retrieve menu built in pan-tilt camera
	Able to operate automatic focus function
	Able to enter pre-set No. and save
	Enter and press preset No. to move and then camera moves accordingly
	Able to enter preset No.
	Change channel
	exit

## Chapter 13. Display Section In-Depth

Display section controls how local view (view from monitor directly connected to DVR) is configured.

### 1. OSD GUI

On OSD (On Screen Display) GUI you have control over showing or not showing “Camera Title”, “Status Bar”, and “Split Border”

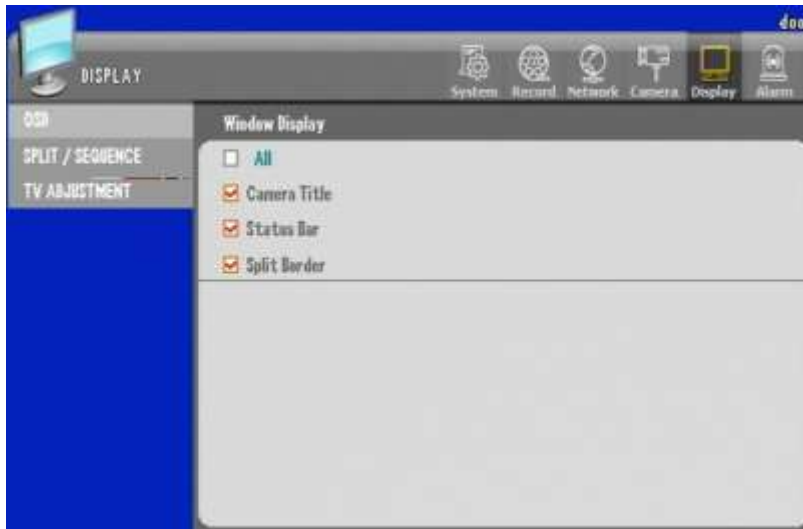

Figure 107 OSD GUI

**Camera Title:** Camera Titles are shown on the upper right corner of each camera section.



Figure 108 Camera Title Location

**Status bar:** Display the status bar on the bottom of the screen. There are information such as Time, Record status, Lock, Network and HDD capacity remained in the status bar.

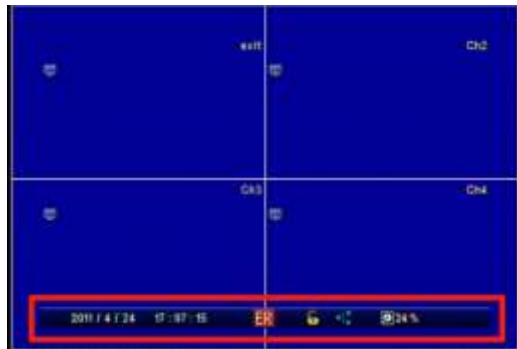

Figure 109 Status Bar Location

**Split screen:** Display the split screen (as default white line is drawn if you unselect it then there will be no boarder between pictures)

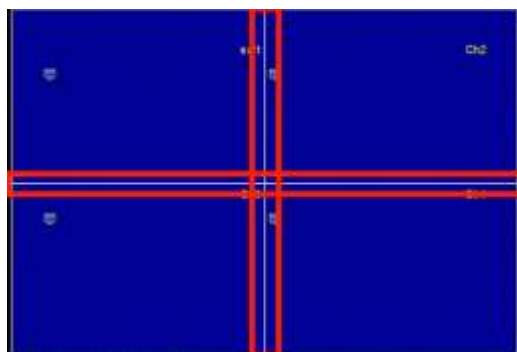

Figure 110 Split Screen Lines

**2.SPLIT / SEQUENCE GUI**

There are options to control how split view and its sequence appearance could be configured.

It is controlled by SPLIT /SEQUENCE GUI shown below.

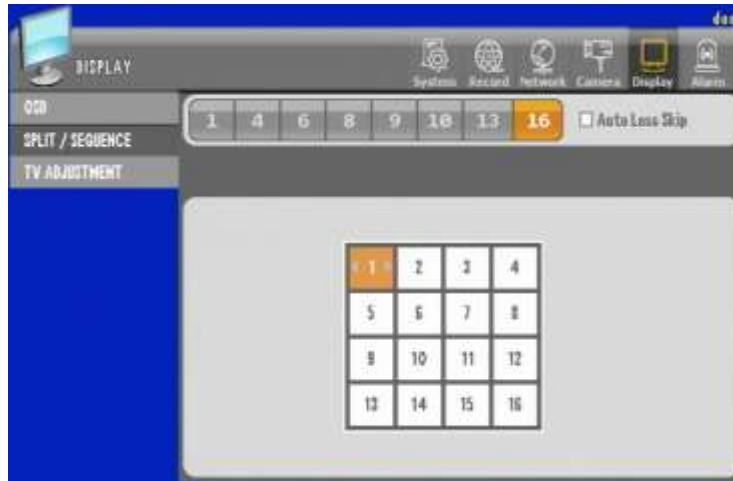

Figure 111 Split / Sequence GUI

In above example shows 16 channel split that has no “Auto Loss Skip” enabled.



Figure 112 Chanel Selector

There is also display order selector as seen below for 16 channel example.



Figure 113 16ch split display order

In the box with camera number 1, if selected the right or left arrow will appear where you can choose which camera will be shown on 16 channel split window. You may do this for all 16 combination to choose the order of the camera.



Figure 114 1ch split configuration

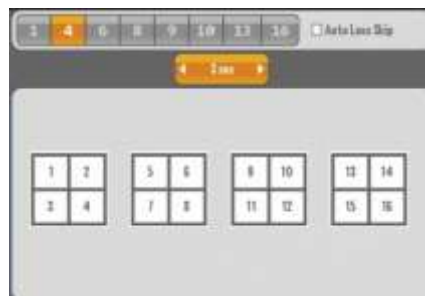

Figure 115 4ch split configuration



Figure 116 6ch split configuration

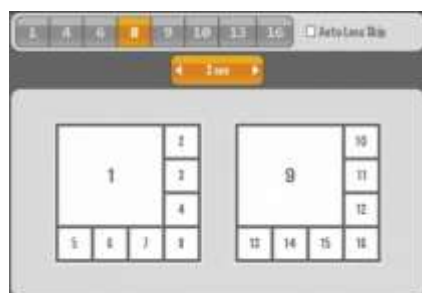

Figure 117 8ch split configuration

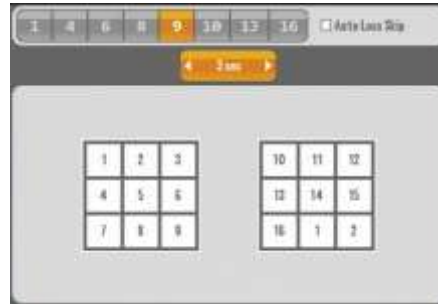

Figure 118 9ch split configuration

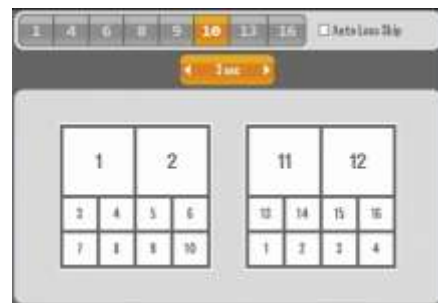

Figure 119 10ch split configuration

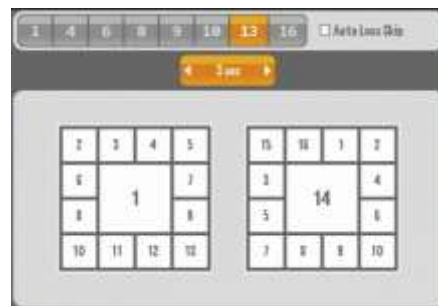

Figure 120 13ch split configuration

**Dwell Time:** All split configuration except 16 channel split configuration you could set dwell time represented in seconds.



Figure 121 Dwell Time selection

**Order Selection:** All Channel box are selectable and may change the order of it except 1 channel split configuration.





Figure 122 Order selection

Auto Loss Skip: If configured (checked) then any missing or video loss camera will not be shown on selection menu and it will auto populate according to empty slot. EX: if camera number 15, 16 is lost, then on 9 channel split 1<sup>st</sup> batch will show 1~9 cameras next will show 10~14 and 1~4 on 2<sup>nd</sup> batch.

### 3. TV ADJUSTMENT

In this section you will use the configuration to adjust resolution and Icon size.

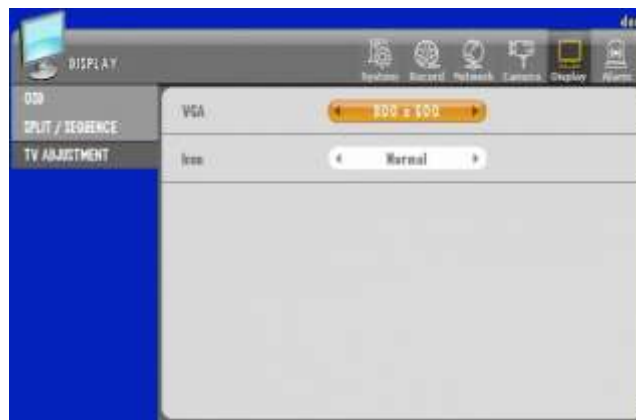

Figure 123 TV Adjustment

**VGA:** VGA (Resolution) selectable 800X600, 1024X768 or 1280X1024

**Icon:** Icon there are Normal, VGA and Small.

## Chapter 14. Event Section In-Depth

### 1. SENSOR GUI

This DVR supports 4 sensor inputs for all 4 channel, 9 channel and 16 channel DVR.



Figure 124 Sensor GUI

**Enable Sensor:** Select the sensor to use.



(Use)



(Not use)

**Input Type:** Choose between Normal Open and Normal Close.

- N/Open (NORMAL OPEN) : The contact is normally opened but it will be closed when the signal is triggered
- N/Close (NORMAL CLOSE) : The contact is normally closed but it will be opened when the signal is triggered

**Related Camera:** Select the camera to be connected with the sensor. Multi-connection is available.



(Not use)



(Use)

**2. ALARM GUI**

You could configure how each “Events” (Motion, Sensor, Video Loss) respond with time individually as shown below.

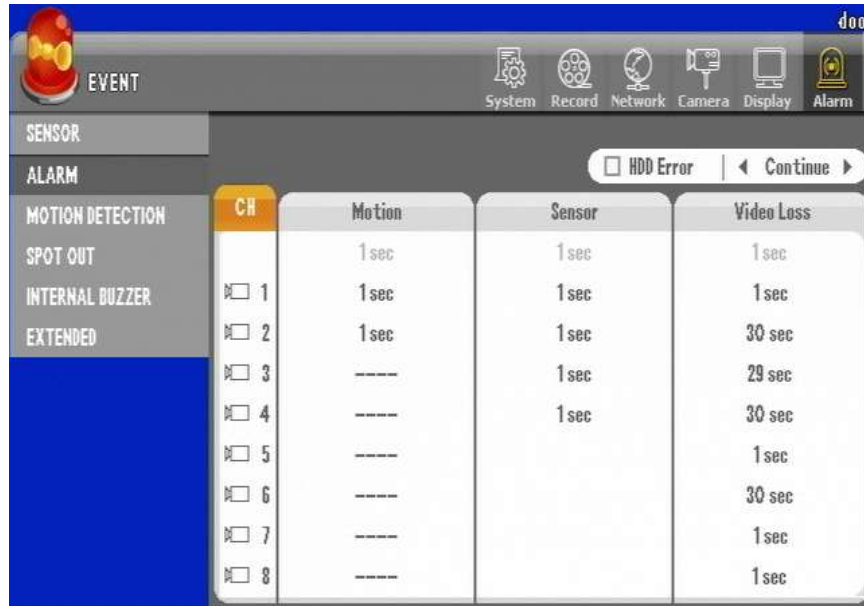

Figure 125 Alarm GUI

Select the alarm duration time on each event (Motion, Sensor, Video Loss)

In case of selecting the alarm duration time in blue-colored, it is applied to all channels

CH	Motion	Sensor	Video Loss
	4 sec	3 sec	5 sec
<input type="checkbox"/> 1	7 sec	4 sec	5 sec

Select the HDD Error and alarm duration time



**3. MOTION DETECTION GUI**

You can set the sensitivity and detection area in order to record when the motion event is triggered.

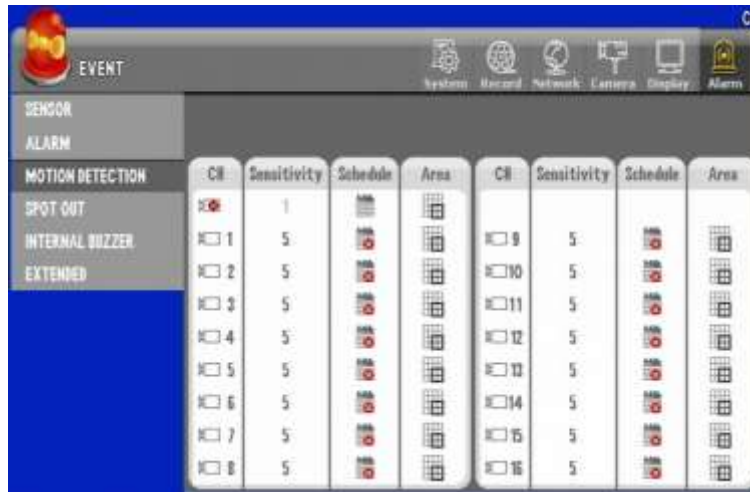
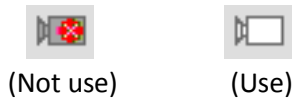

Figure 126 Motion Detection GUI

**Select the channel:** Select the channel using for the motion detection.



**Sensitivity:** Set the sensitivity to be detected.



- The larger the number is, the higher the sensitivity is (1~10).
- If the sensitivity is selected with Schedule, you can set the sensitivity by each hour. You use this option to control sensitivity control for night and day. Some light angels may create larger motion due to the location of the shadow or other effects.



Figure 127 Indication of Hourly configuration of Sensitivity

**Range:** Set the area where a motion would be detected.

There are also indications in pink color when motion is detected. It also serves as feedback on your sensitivity settings. If you see the pink color in the grid you choose for motion then such motion activity is sensitive enough to be detected. Please use trial and error to configure it just right.



Set the area by using the direction key(or mouse dragging) and press “Enter”.

- Select the area where the motion is detected : The selected area is outlined with blue.
- Cancel the area where the motion is detected : No signal
- The area where the motion would be detected is marked with red.

**Note :** You can use the hot key to set all areas.

- No. “1” : Select all
- No. “2” : Cancel all

**4. SPOT OUT GUI**

This setting enables the monitoring by the second monitor and also provides the display mode such as Event popup, Sequence, Event + Sequence and Fixed channel.

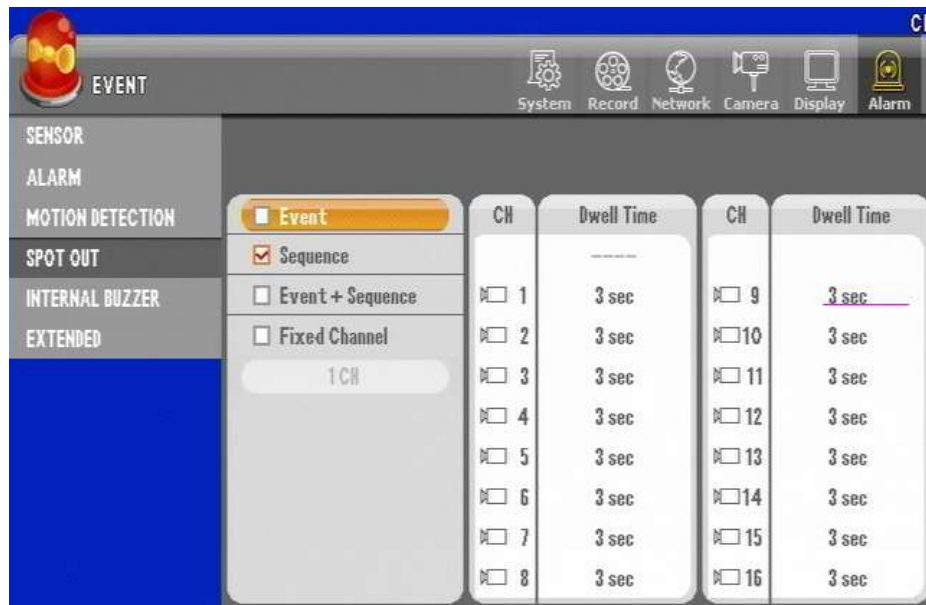

Figure 128 SPOT Out GUI

**Set Sequence Dwell Time:** Available to set from 0 to 30 seconds

**Spot Mode:**

- Event : When an event is triggered, the relevant channel video is popped up.
- Sequence : The selected channels are displayed sequentially for the selected dwell time.
  - Event+Sequence : While being displayed sequentially at no event, when an event is triggered, the channels triggered are displayed preferentially.
- Fixed Channel : Display the selected channel only



**5. INTERNAL BUZZER GUI**

When an event is triggered, the DVR buzzes for the selected time.

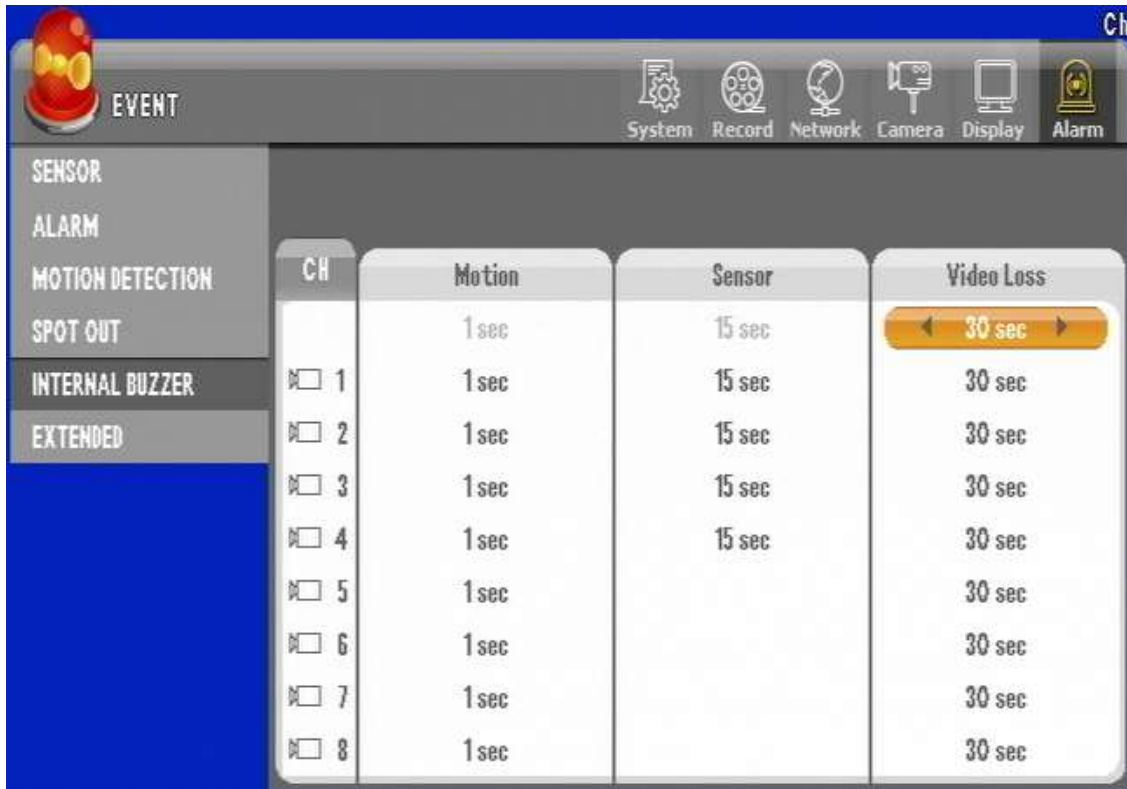

Figure 129 Internal Buzzer GUI

**Range:** 1 to 30 seconds ( “----“: Not use )



**6. EXTENDED GUI**

Once the extended box is connected, up to 16 sensor inputs and alarm outputs can be usable.

► Connection diagram

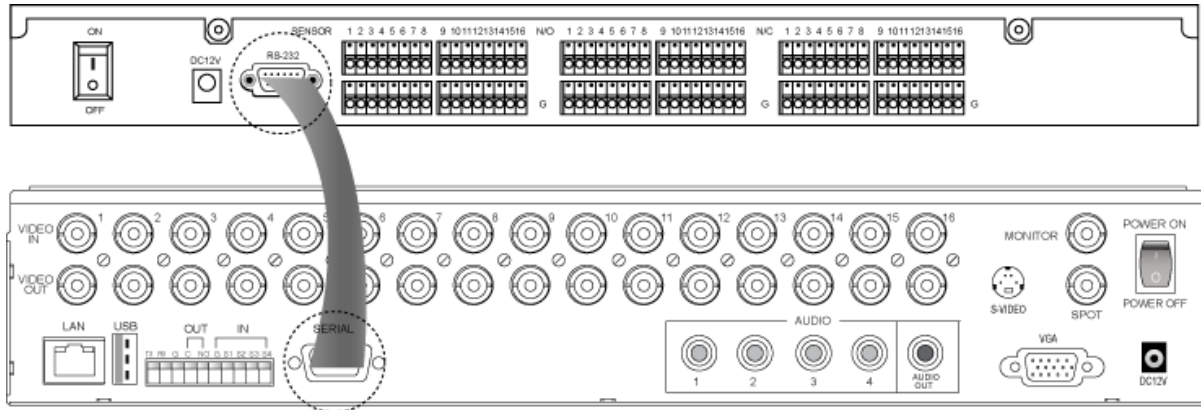

Connect “Serial” port of DVR with “RS-232” port of the extension box.  
 Connect the power cable of extension box and then turn the power on.

► Description

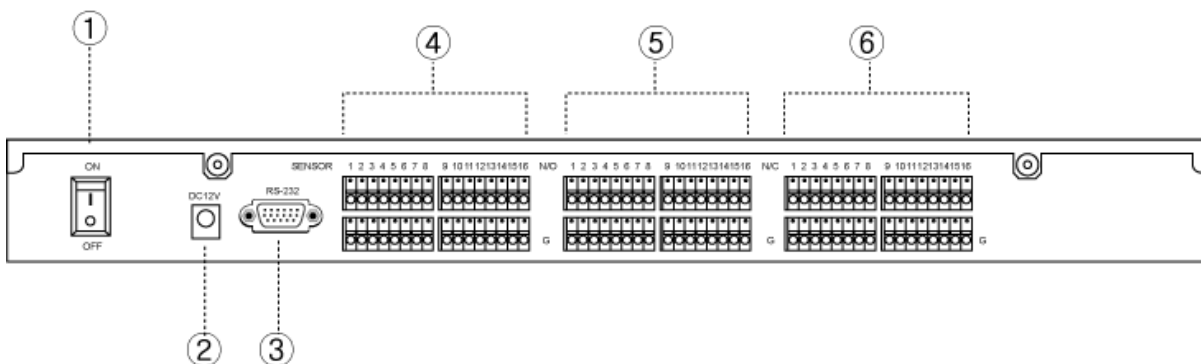

- ① Power switch
- ② Power adaptor connector
- ③ RS-232 port (Port connected to the system)
- ④ Sensor input (1~16)
- ⑤ Normal Open alarm output : 1~16
- ⑥ Normal Close alarm output : 1~16

**Alarm Sensor extension box setting**

After connecting the extension box, you should set to have the system working.

[1] Select the "Use" then move arrow to select check mark.



Figure 130 Extended GUI

You will have check mark appear as Figure 130 Extended GUI shows above.

## Chapter 15. Search Operation

In most cases search operation may be done through the client application, but some cases especially if you are going to perform evidence backup you will perform a search directly from the DVR unit itself. This chapter reviews how you could perform different types of search. There are 3 types of search Calendar, Event, and Date/Time search.

### 1. Getting to Search Screen

Search option may be available by selecting the “Search” button on the face of the DVR.



Figure 131. DVR Front Face with Search Button

Or you may use the “Search” button on the remote controller.



Figure 132 Search using remote controller

Or you may use the right mouse click then click on search button on the screen with left mouse click.

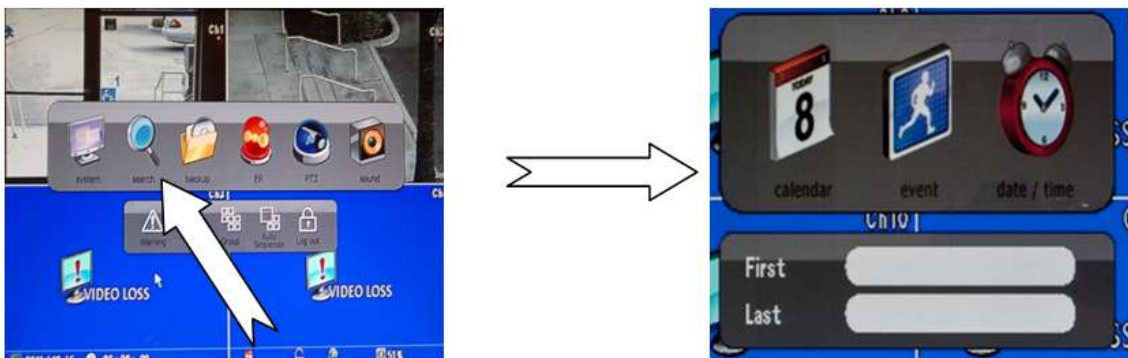

Figure 133 Mouse operation to get to search menu

## 2. Calendar Search

Bring up menu that Figure 134 Search Menu shown below from search screen then press calendar.



Figure 134 Search Menu

Then you must click icon marked “calendar” to see below Figure 135 Calendar Search GUI.

Calendar search can be performed if there are available recording on HDD. They will be highlighted blue and upon selection they indicate that corresponding items are playable.

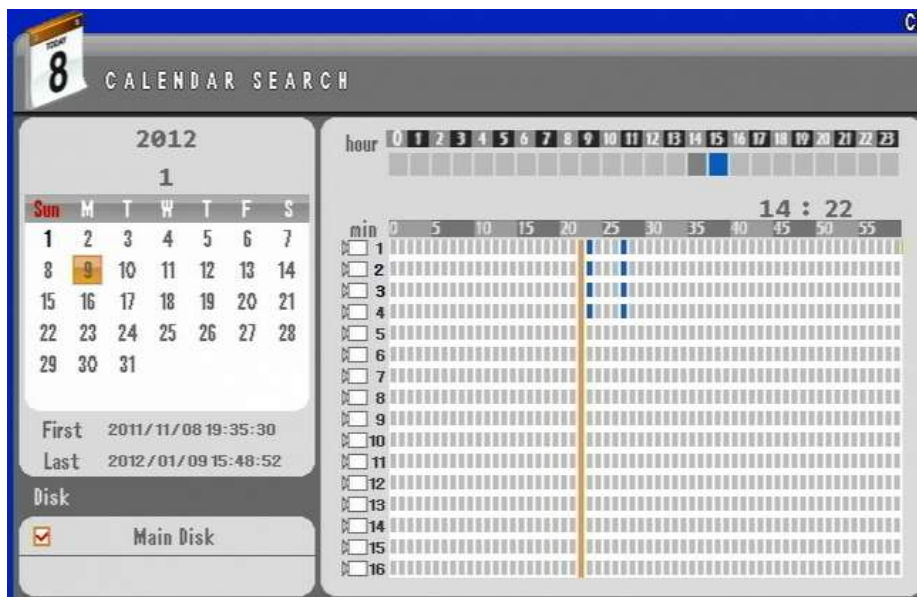

Figure 135 Calendar Search GUI



If there is a no recording present then dates are not selectable as you see on Figure 136 Calendar with no recording.

You must scroll through month and year to find calendar with recording available.

Figure 136 Calendar with no recording



If there is a recording you will see date selectable in orange squares. In Figure 137 Calendar with recording 10<sup>th</sup> day to 30<sup>th</sup> day of this particular calendar has recording and currently 15<sup>th</sup> day is selected to be viewed.

Figure 137 Calendar with recording

If there are no recording you will see the hour and minute indicator as seen below.

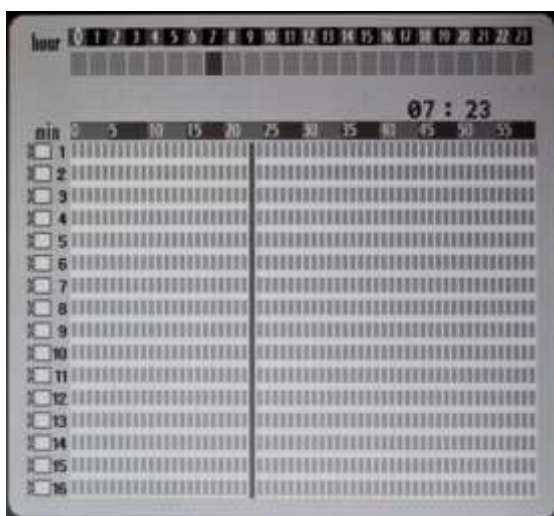

Figure 138 Hour and Min recording indicator

If you have any data on particular hour and you will see mini blocks of 1 minute interval highlighted as seen Figure 139 Hour and Minute indicator with recorded data.

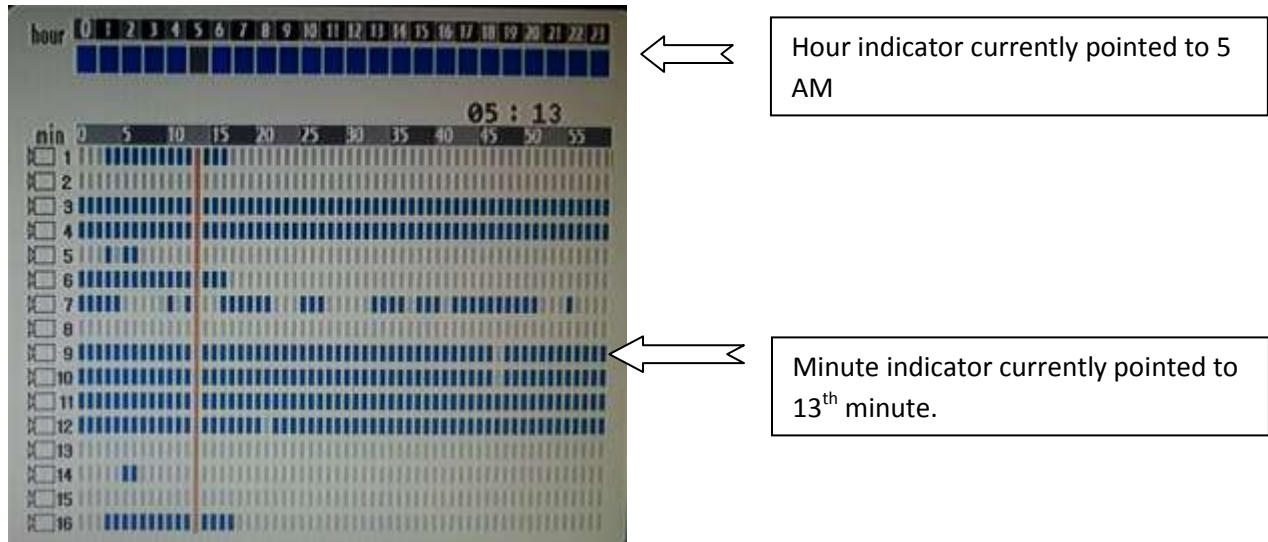

Figure 139 Hour and Minute indicator with recorded data.

The time bar is currently pointed to 13<sup>th</sup> minute and hour is on 5 AM mark so from this point if “enter” button on keypad, remote controller or double click on that indication line, you will be playing back video for selected date and 5:13 AM.

### 3. Event Search

If you have event recording enabled that you may choose such event from event list and perform a playback. You must see a menu that look like Figure 134 Search Menu seen below.



Figure 140 Search Menu

Then you must click icon marked “event” to see below Figure 135 Calendar Search GUI.

Then you will see below GUI screen page.

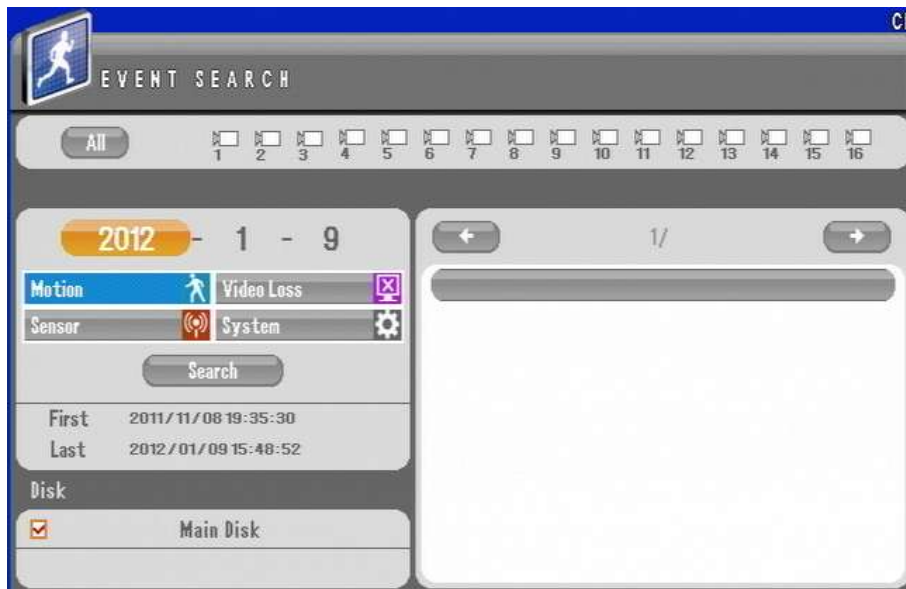

Figure 141 Event Search GUI

On this Figure 141 Event Search GUI Motion is highlighted if you press search button then only then you will have list pane populated with events.





Figure 142 Populated List Pane

As you can see only if you conduct search will it show the list item and as shown on figure above there are 161 pages available for example above. You may have different result.

You need to also highlight the type of event that need to appear on list pane by selecting the event.

Selected events will show from gray coloration to Blue for Motion, Red for Sensor, Pink for Video Loss as shown below.



Figure 143 Event type and Search

Clicking on the item on event list pane will start the playback of the event.



### 4. Date and Time Search

If you know exact time of search that you want to perform you may use the date and time search.

Date and time figure can be changed on screen below by selecting month, day, year, hour, minute then second.



Figure 144 Date and time search

Then press on search to directly playback on time you desire.

## 5. Playback Control Menu Bar

Below you see the actual playback via the 16 channel DVR. Even though there are 16 cameras recording on motion only certain camera appear. Cameras that show video images are those that have recording for that particular time. On a event recording (Motion, Sensor) there will some time slot where there be no recording due to the fact that it did not trigger the event.



Figure 145 Playback screen with event recording

Example in Figure 145 Playback screen with event recording, ch5, ch6, ch9, ch10, ch11, ch12, ch14 and ch16 has playable video recording for that particular time selected to be played back.

### Playback Controls

Playback Controls are available with right button click with mouse, however with remote controller and frontal keypad you may have to click certain button to obtain the same result as operating Playback Controls.



Figure 146 Playback Controls

If you observe the play control on the bottom of the screen as shown on Figure 146 Playback Controls you will see playback control divided in three groups.

1<sup>ST</sup> group is speed control which mouse, keypad, and remote controller are able perform all possible actions.



Figure 147 Speed Control

**Play and Pause operation**



Figure 148 Play Control

Play and pause by mouse operation is simply clicking desired location to obtain the result. However for frontal keypad and remote controller you must press enter key to obtain the result for play and pause.

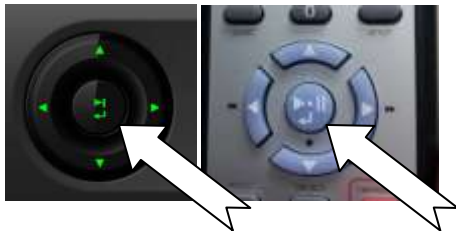

**Fast Play, Rewind Operation**

You may use fast forward option with mouse by pressing doubled arrow mark. Or press right directional key.



Figure 149 Fast Play

Also you may do the same with reverse play and fast play backwards by operating it with mouse on Speed Control, or key pad.

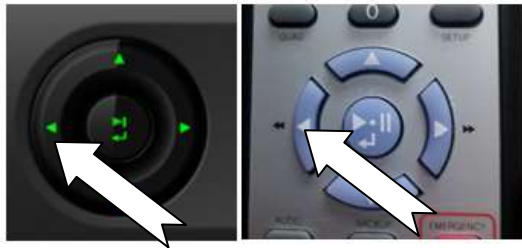

Figure 150 Rewind and Fast Rewind.

They are selectable by 1X, 2X, 4X, 8X, MAX forward and backwards play view.

**Mouse Only Operation**

Some operations like the 2nd group of Playback Controls are fully functional only for the mouse operation. Some operations are available with key controls but not all will operate the same way because with key controls the full Playback Controls are not available.

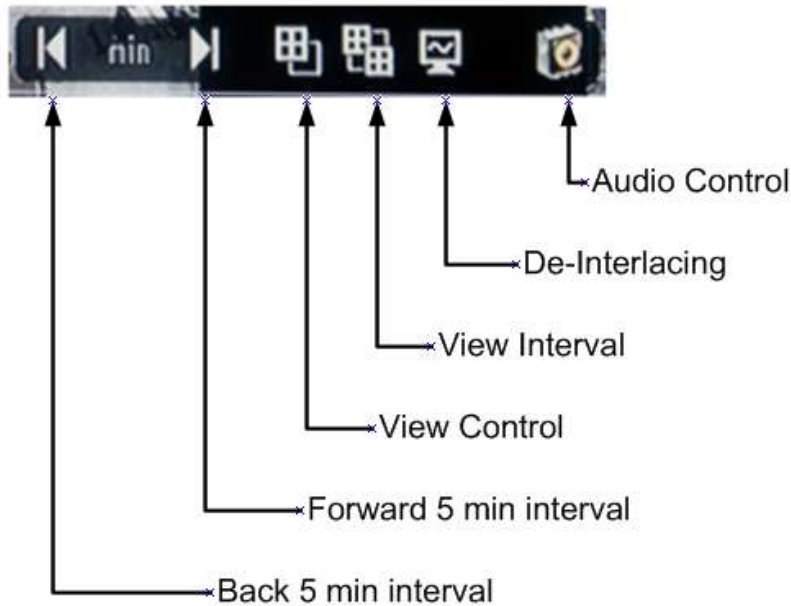

Figure 151 View and Audio control for playback

Forward and backward 5 minute interval is only available via the mouse operation.

With View Control and View Interval option some actions are available via the keypad operation but not as detailed as mouse operation using Play Back Controls.

The View Control option in keypad and remote controller, you may press the Quad buttons, as shown on figure below.



Figure 152 Quad Key Layout

However only the max view in case of 16 channel DVR between 1 and 16 channel view, in case of 9 channel DVR between 1 and 9 channel or in case of 4 channel DVR 1 and 4 channel view will be available. With using mouse on view control you may have many option of view as shown below.

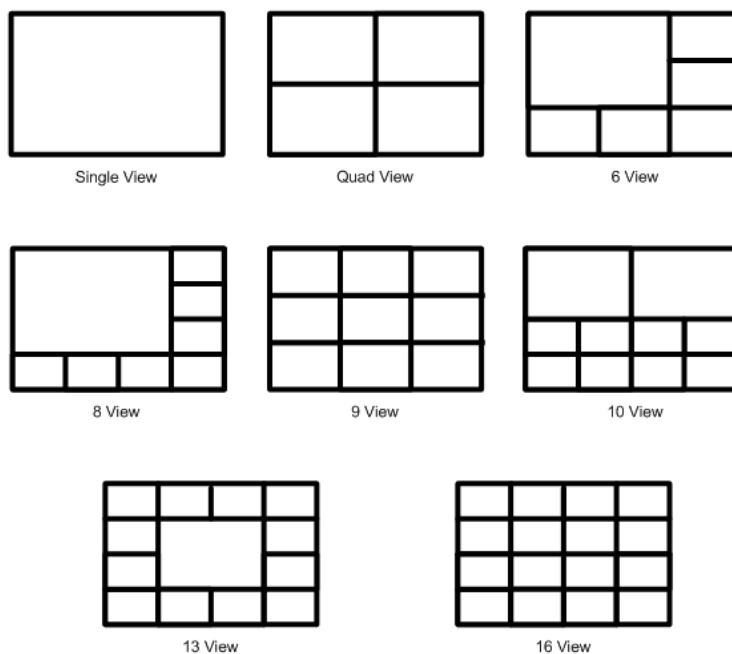

Figure 153 Mouse only view control

### View Interval Option

View Interval option will scroll the next set of camera in view control view as an example of quad view on Figure 153 Mouse only view control if you press view inter option button then next set of the 4 cameras will appear.

### De-Interlacing Option

De-Interlacing Option is available for high speed motion view that will have image tear. Our recorded video images are complied by using right and left field. So for those images that has fast moving object you might observe image tear due to video sync difference between right and left field. De-Interlacing Option shows the picture in a field view rather than frame view. So by using the De-Interlacing option you will eliminate the image tear on playback images.

### Audio in Playback Option

Audio is only other option that will fully function by pressing audio key or by mouse control. It enables the audio and adjusts the audio volume for the playback video.

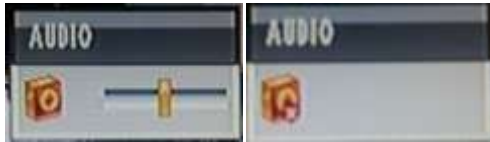

Audio options by default shows audio level 50% volume with second click you will be able to mute the audio. By moving the level adjust bar you are able to control the volume level.

**Quick Backup During Playback**

While playing the video back you do not have to exit the playback view to conduct a quick backup to media of your choice.

You need to click on backup key or click on button shown below to mark an index location of where this backup point will start.



Figure 154 Quick Backup

Then you will see indication on the screen “Mark In” as shown below.

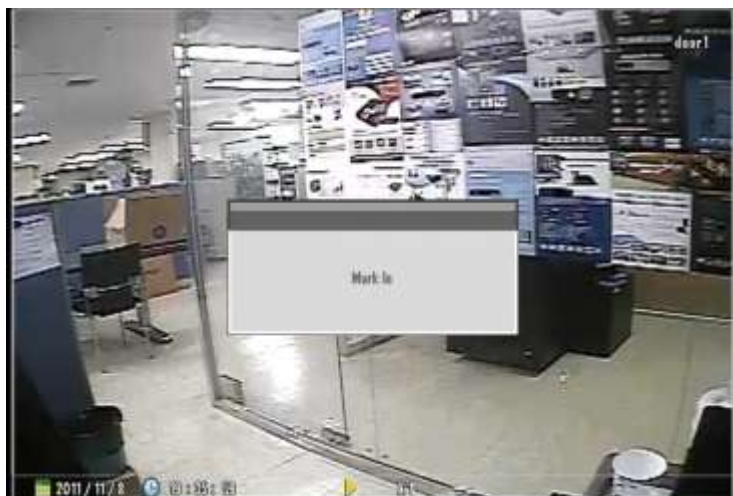

Figure 155 Mark In

After if you press backup button one more time you will now see the Quick Backup GUI to perform a backup operation. What Mark In function does is that from when you 1<sup>st</sup> press the backup button or mouse equivalent operation, DVR actually marks that exact time for Quick Backup GUI to start backup operation.



Figure 156 Quick Backup on Playback

So in Figure 156 Quick Backup on Playback, Mark In was performed at 2011-Dec. 15<sup>th</sup> 5:16 AM and you have an option to back it up on USB because there is no CDRW present.



## Chapter 16. Backup Operation

Backup is the function to archive the recorded video to a storage device such as an extended HDD or USB drive. If an ODD is built-in, it's available to back up the files to the ODD as well.

### Note

When you back up with the external HDD, please use the external HDD supplied the power from outside. The disk for backup should be formatted with FAT32. And it's recommended to use the commercial software providing "FAT32 format" for the disk over 30GB capacity.

### 1. Calendar Backup

Connect the storage device for backup and then select "Backup" button.

Or you may press "backup" from main menu shown below.



Figure 157 Main Menu Items

Then you will see figure below

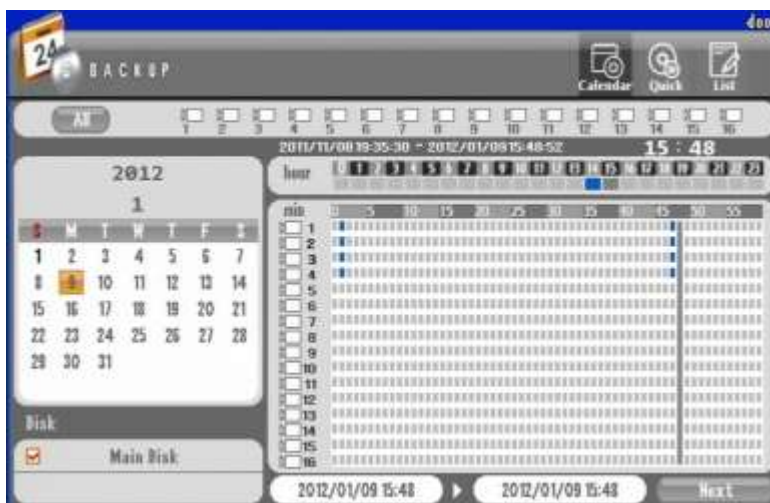

Figure 158 Calendar Backup

### Select the camera

Select the camera to back up.



(Not select)



(Select)

**Select the date**

Select the date to back up.



**Select the disk**

Select the disk to back up.



- Main disk: Back up through the disk used as a main disk
- Mirror disk : Back up through the disk set as a mirror disk

**Select the hour**

Select the hour to back up

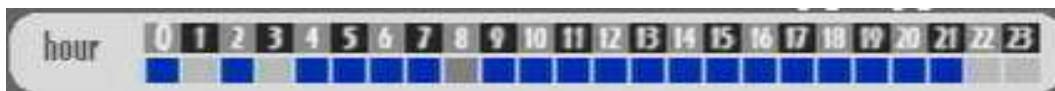

**Select the minute**

Select the minute to back up

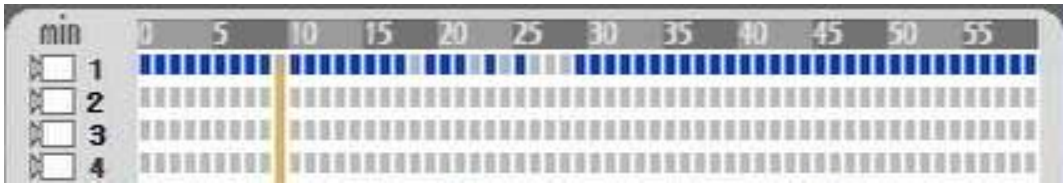

**Set the backup start time**

Select the start time and then click the tap in the left side to set like the picture below.

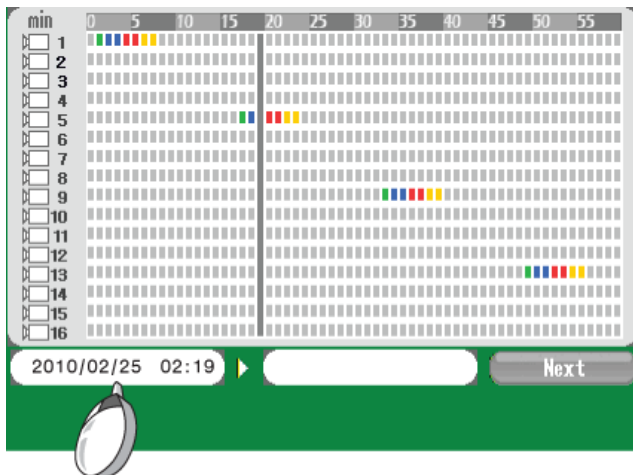

**Select the backup completion time**

Select the completion time and then click the tap in the right side to set like the picture below

And then press Next.

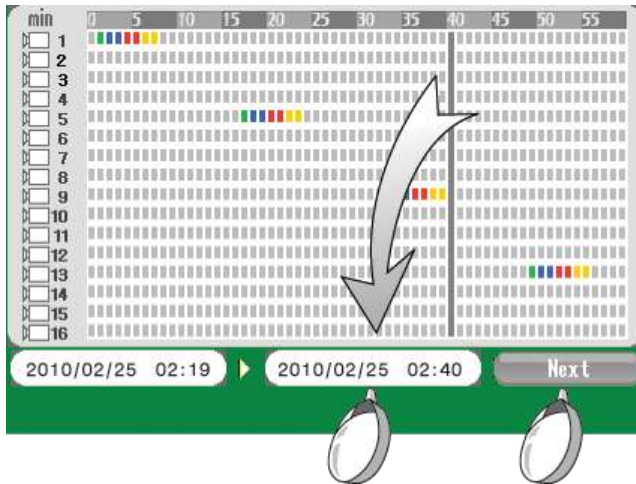

**Note**

Above time setting is applied only when the backup date and hour is same. If the backup date and hour is different, set the start time first by setting date, hour and minute and then set the end time.

► **Select the backup option**

You can select the following options for backup.



- **Device** : Select USB when you back up through USB port. And Select CD/ DVD-RW when you back up with CD/DVD-RW.

- **Backup Range** : Display the selected backup time.

- Option : Select

-Audio : Select when you back up by adding audio signal

-Backup Viewer : Select when you back up by adding a backup viewer program

### **Backup Size**

You can check the selected size to back up and the size of storage device. If the selected data is over the size of storage device, you have to set the backup time again.



- Device: Display the memory size to back up
- Data : Display the data size you selected

### **Backup Password**

When you start a backup, you can set the password.



### **Backup process**

Display the backup progress.



**Display Backup Completed**

Once the "Backup Completed" message is popped up, you may detach the storage device from the USB port.



**2. Backup Viewer**

You can play the backup files with the viewer program below.











Click to run the viewer program.



(Backup viewer program)

Icon	Description
	Open the file
	Fast reverse playback
	Reverse playback
	Step backward
	Pause

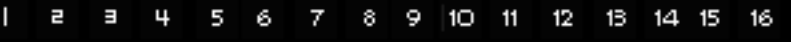
		Playback
		Fast forward
		Show the file list
		Switch to four split mode
		Switch to nine split mode
		Switch to 16 split mode
		Capture the image
		Control the Volume
		Select the channel

► AVI conversion

You can convert the backup file into AVI format file. Click the Start tap to set the start time. Click the End tap to set the end time. Click the AVI tap to start the conversion.





## Chapter 17. Mobile and Remote Client Applications

### 1. iPhone

#### iPhone Application Installation

1. Access the “App Store” from your iPhone or iTunes application.
2. Search for “MPRMS”.
3. Choose to download and install the application (there is no charge to use our MPRMS application).
4. After the installation is complete, launch the MPRMS application from your iPhone.



#### Adding a DVR To Your iPhones MPRMS Application

Launch the MPRMS Application, and press “New”

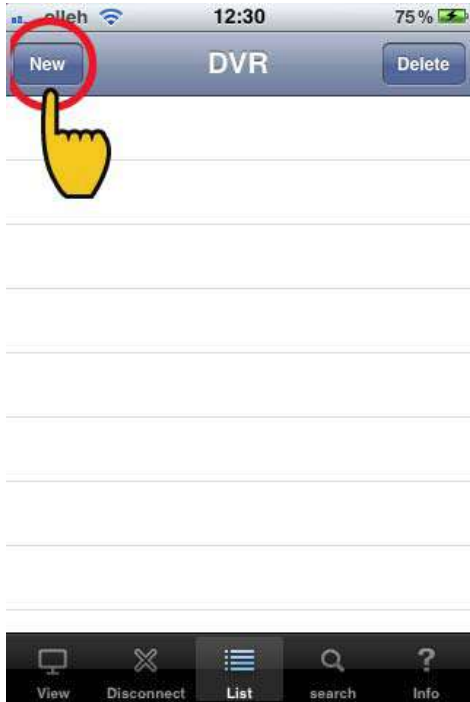

Enter the “Reg Name” (Registration Name). This can be any name to identify the specified DVR. **Make sure there are NO SPACES in the Reg. Name.**



Select the DVR Model:  
H.264 DVRs' = DVR

MPEG4 DVRs' = FDS-110

MJPEG DVRs' = MJPEG



Enter the login information of the DVR. The login information **MUST MATCH** the login information on the DVR.



DVR ID: Enter the User ID for accessing the DVR.

Password: Enter the password for accessing the DVR.

Enter the DVR IP Address & Port Number (You can also enter the domain name address here)



**DDNS Use**

Please disregard this configuration option if you are using DVR within the United States. This feature is used in the following regions:

Asia

Connecting to the DVR

Press the DVR on the site list to connect

**NOTE** You will be prompted that there will be a “N/W Connection Charge”. **THIS IS ONLY A REMINDER TO USERS WITHOUT AN UNLIMITED DATA PLAN, WE WILL NOT CHARGE YOUR ACCOUNT FOR DVR REMOTE ACCESS.**

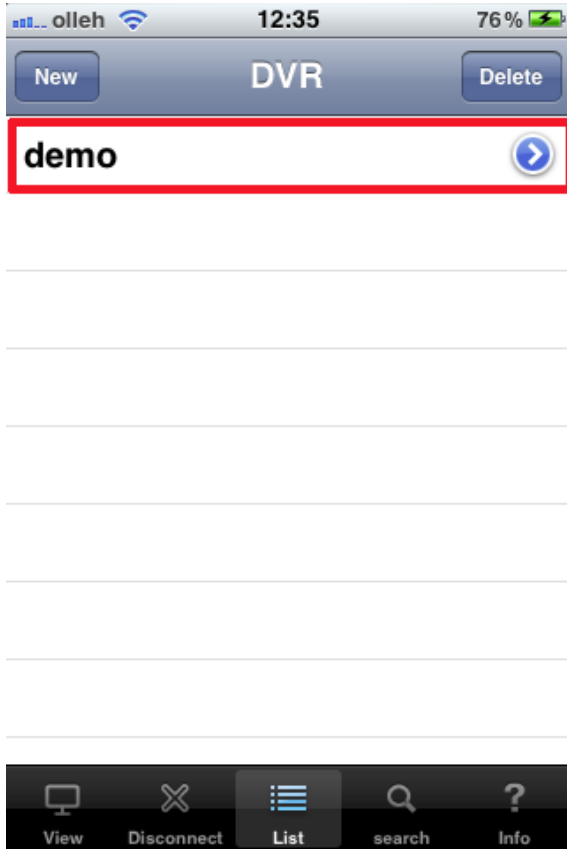

Connect remote access



“CH SELECT” to select camera number.



PTZ : select when controlling pan-tilt



The screen displays only video excluding time, resolution and the name of channel.

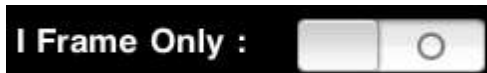

The feature is designed to transmit still photo in certain intervals when video streaming is interrupted due to network load.

See full screen : If you set aside iPhone, it switches into full screen.  
( Touch any area of full screen viewer to retrieve menu )

### **Search from iPhone**

Select “search” the icon below.



[1] Select Date/Time



After selecting a date, select "SEARCH".

[2] Search key operation



Play reverse



Pause



Play



Switch to Live



**Controlling Relay-Out from iPhone**

Relay can be controlled remotely..



Time selection : Set the duration time of alarm output

Off : Alarm off

Infinity : Keep the alarm output continued

**PTZ control from iPhone**

PTZ control is available on iPhone. The way how to control is the same with on CMS and DVR





- (1) Select
- (2) Cancel
- (3) Automatic camera focus
- (4) Call the PTZ menu
- (5) Direction button
- (6) Camera focus control
- (7) Camera zoom control
- (8) Select the channel
- (9) Relay out button (A user can set relay out)
- (10) Select the PTZ menu
- (11) OSD display On/Off button for live screen

## 2. Android Phone

### Program Installation for Android

To install the program on the Phone, execute the 'MARKET' program and download the 'MPRMS' to install. If the installation is completed, you will see the 'MPRMS' icon on the main SCREEN.

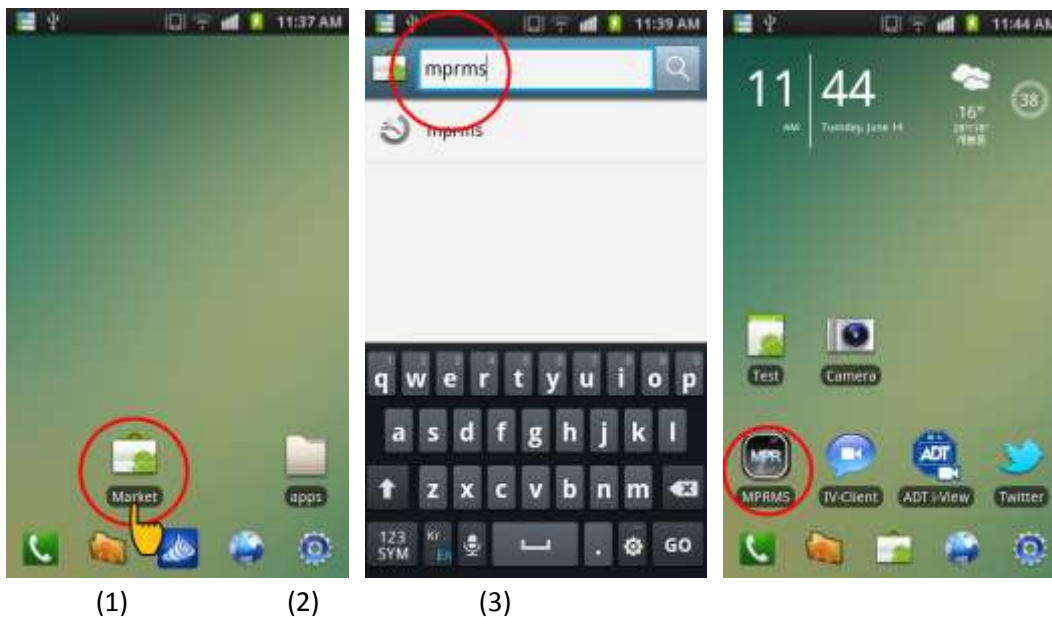

### Application Execution for Android

Select "MPRMS" to execute the program.



(Select the icon)



(Executed Program)

**Register the product information for Android**

Register the product information for remote monitoring.

[1] Register

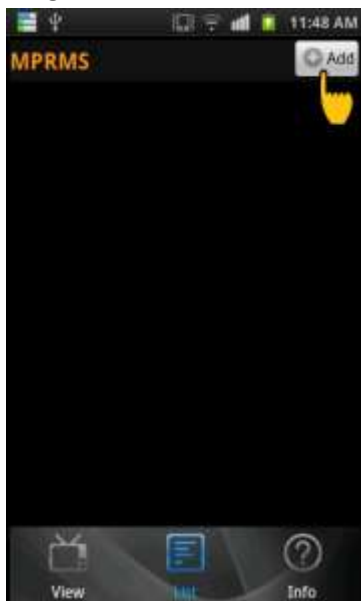

Select "Add" to start the registration.

[2] Enter the registration information



(1) Enter the name, Product ID(User) and Password.

Name : Enter any name you want.

User : Enter the "User ID" registered to the DVR.

Password : Enter the "Password" registered to the DVR.

(Note : "Menu" → "System" → "Password")

IP : This setting is only for static IP users.

(2) After selecting "DDNS use", enter the "Password, IP and Port".

(Note: Dynamic IP user only)

(3) You can check the DDNS ID from the DVR menu: 'Menu' → "System" → System Information.

Copy the 'WEBCODE' and enter it to DDNS ID and save it. (DDNS PORT is automatically changed as per the Webcode of DVR.)

### **Modify/Delete of Registered Information for Android**

If you want to modify or delete the registered information, select the triangle-shaped icon.

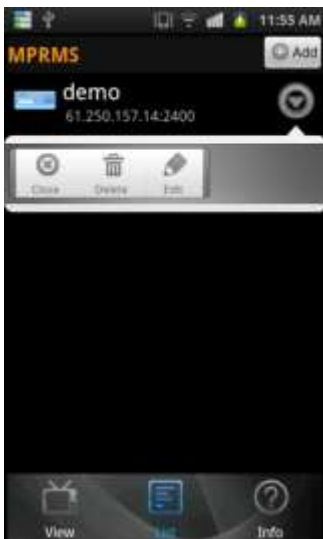

Select to edit the registered info.

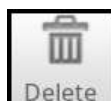

Select to delete the registered info.



Close TOOL menu (As a dual function, it ends the connection)

### **Remote connection for Android**

Select the registered list for connection. Once you click the registered device, it shows the brief information like the 1<sup>st</sup> picture below. If you click the red-colored background, detailed info. appears like the 2<sup>nd</sup> picture. Click OK to execute the monitoring program.

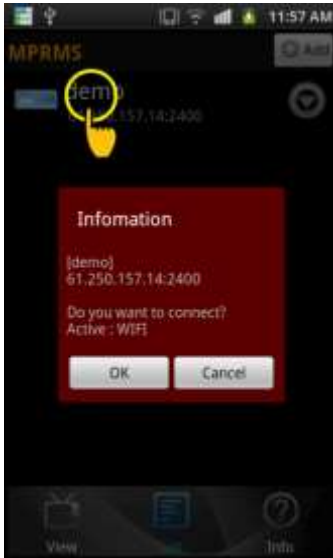

(Select the list)



(Detailed info.)

**Live view on Android**

It shows the currently monitored images with real-time.



- (1) Numeric Button : Press a numeric button to select a channel.
- (2) 1 frame: When selected, it transmits a still image with the certain interval in case the video streaming is interrupted due to the network load
- (3) Show OSD: Select to display the info. such as channel name, date, time and event, etc.

**Main menu view on Android**

On the bottom line of screen, there is a main menu. Select the menu to change the function



Go back to the previous step or close the monitoring program



Move to live mode (Channel change, 1 Frame and OSD display is available)



Go to PTZ mode



Go to PTZ preset mode



Go to search mode



Go to alarm mode



See the registered info.

### **PTZ control for Android**

You can control the PTZ camera remotely.















(Select PTZ mode)

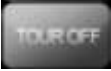

(PTZ mode screen)

- (1) Go to PTZ mode  
Select the PTZ connected channel and click the PTZ button.

- (2) How to control PTZ

	The PTZ camera moves to the selected direction.
	Zoom in/ out
	
	Focus adjustment
	
	operates according to the previously registered 'Preset' number
	
	IRIS Open/ Close.
	
	Call the PTZ menu



Auto Focus



OK button for PTZ OSD menu



Cancel or the upper menu on PTZ OSD menu

**PTZ Preset for Android**

You can set the movement of PTZ camera previously and make the automatic PTZ movement.



(Select preset mode)



(Preset mode screen)

(1) How to go to PTZ mode

Select the PTZ connected channel and click the Preset button.

(2) How to operate Preset



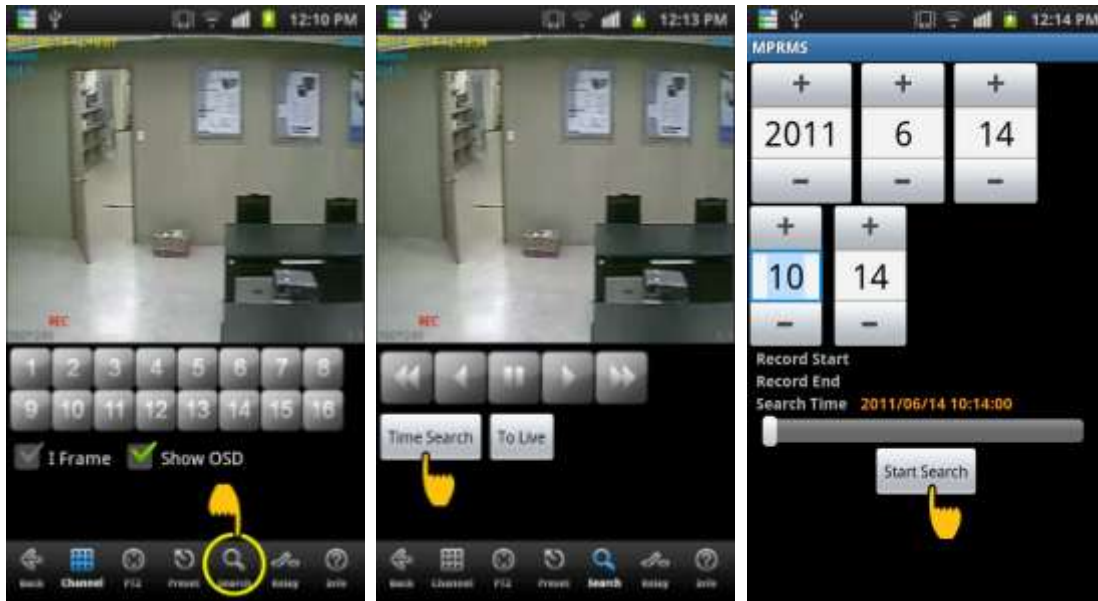

- Move: If you select "Move" and press a number, then the camera moves.
- Save: If you select "Save" and press a number, then the current location is saved.

**Search on Android**



(1. Select the search mode) (2. Select “Time Search”) (3. Select the date and time)

- (1) Select the search mode
- (2) Select “Time Search”: Select “Time Search” to enter the search conditions.  
(Note: Select “To Live” to return to the live mode during the search.)
- (3) Enter the date and time: Select the date and time and click “Start Search” for search.

-  Fast reverse playback
-  Reverse playback
-  Pause
-  Playback
-  Fast playback

**Relay Out for Android**

Relay can be controlled remotely.



- (1) Relay : Select On or Off
- (2) Number : Select the relay number.
- (3) Time : Select the duration time.
- (4) Execute : Make the alarm output work

**Information display option on Android**

It shows the information of current connection.



(Select info)

(Display the connection info )

**[Display Info]**

Below is the example for an explanation.

- IP : 61.250.157.37 : 2000 Via DDNS ← Connected IP information.
- MODEL : 16CH(63,xxx xxx:0) ← 16Ch model
- Webcode : H6F6057200001394 ← Product ID(Webcode).
- F/W : 84, N/W:21 ← F/W and network version.
- VSTD : NTSC ← VIDEO standard.

**End the connection for Android**



(Select the back button)

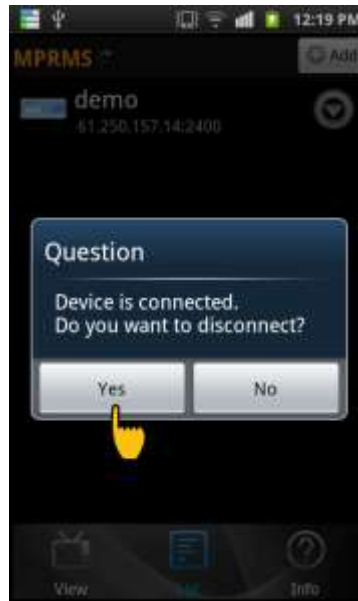

(Select the Yes button)

There are several ways to finish the program.

1. If you click 'BACK', it asks like "Do you want to disconnect?" Then, you may click Yes.
2. Or you may just press close button on the phone.

### 3. Windows Mobile

#### Install the program to Windows Mobile

Copy the program, MPRMS and save it to the mobile phone.

#### Execute the program for Windows Mobile

After save the program into the any folder, you can see the “MPRMS\_Setup.cab” file as below picture.

☞ Please refer to the user’s manual of mobile phone how to copy and save the application program.



Execute the “MPRMS\_Setup.CAB” file then “MPRMS” icon will be created on the screen.



You can see the icon of “MPRMS”.

**Register the Product Information on Windows Mobile**

For mobile viewing, you must register the network information of the DVR. As for the network setting of DVR, please refer to the user’s manual of DVR.

[1] Register

Click the “Add DVR” to register a new DVR.



[2] Fill in the required information.





Enter info. like the picture above.

- NAME : Input any name you want.
- ID : Enter the DVR's login ID.
- PASS : Enter the DVR's login password.
- MODEL : Select the spec. of the model among H.264, MPEG-4 and MJPEG.

[3] Enter DDNS info.



DDNS setting is for a Dynamic IP user and should be entered as follows.

- Use DDNS : Select if you are a dynamic IP user.

- ADDR : Keep the default value of the DDNS server address (Default: www.adtcapsctv.net)
- PORT : The port value will be changed automatically. Keep the value as it is.
- SAVE : Save the info.

[4] Static IP User



- Use STATIC : Select if you are a static IP user.
- ADDR : Enter the static IP address registered in the DVR
- PORT : Enter PORT registered in the DVR. (Default : 3000)

**Connect / Disconnect on Windows Mobile**

[1] Connect



- Connect : Click the “Connect” to see the video.
- Info Setup : To change the DVR information, click the “Info Setup”.
- 1 Only : When selected, it transmits a still image with the certain interval in case the video streaming is interrupted due to the network load.

[2] Disconnect

- Disconnect : If you want to disconnect, click it.

[3] Change the channel



- CH : Click the “▼” to change the channel.

[4] Change the DVR



To connect the other DVR, click the “DVR” and select the registered DVR in the “DEVICE”. After selecting the DVR, click the “Connect” to see the video.

**Search on Windows Mobile**



To play the recorded image, select “Search” then click “Rec Info Req” to set the date and time for searching. After setting the data and time, click “START” to play.  
(NOTE : The playback can be delayed depending on the network environment)

**PTZ Control for Windows Mobile**



Click “Pan Tilt” to control the PTZ camera. Press the direction button to move the camera position.  
[NOTE : In order to stop moving, user must press the “STOP” button.]

- Left : Move to the left
- Right : Move to the right.
- Up : Move to the upper.
- Down : Move to the down.
- STOP : Stop the movement.
- Normal/Invert : Change the direction.

**Zoom /Focus**



Click “Zoom/Focus” to control zoom In/Out and Focus In/Out.

**Preset**



You can save the camera location previously and then send the camera to move to a specified pre-position.

- P1~P16 : Select numbers to save
  - MOVE / SET
- ◎ MOVE : After selecting a number among from P1~P16, press “SEND” to move the camera to the specified pre-position.
- ◎ SET : After selecting a number among from P1~P16, press “SEND” to set the location of camera.

Remote Alarm Control for Windows Mobile



Click "Alarm" to control alarm output.

- Select a number (1~16) : Relay out port. (Default : 1)
- Time : Set the duration time.
- ON/OFF : Press to start or stop.

(Example : If the duration time is set with 5 sec., the alarm output lasts for 5 seconds when you set it ON.)

## 4. Internet Explorer Version 7 and later

The monitoring by the web browser is available as the web server is built in the DVR.

### Initial Connection

If you have actual TCP IP address of the DVR you may input them directly into Internet Explorer or you may use the DDNS IP as indicated below.

Please check the network and port forwarding setup before starting the connection.

[1] Visit <http://www.ddnsip.net> to register your DVR.



The screenshot shows a web form titled "Host Name Service". It contains two input fields: "Web Code(DDNS ID)" and "Your domain name". The "Your domain name" field is pre-filled with "http://" and ".ddnsip.net". Below the input fields are two buttons: "Register" and "Delete".

① Enter the DVR's web code.

You can find the web code as below.

Call the Menu → System → Information → Web code

② You can enter any name you want for your domain name.

③ Click "Register".

Also you can delete your registered DVR after entering the web code and domain name.

 Note



It takes around 10 to 15 minutes to get the service after the registration. So, please try the connection 10 to 15 minutes later.

[2] How to connect

Run the web browser on PC screen and enter <http://soon.ddnsip.net> to connect.



The screenshot shows a web browser window titled "Host Name Service". Inside the window, there is a registration form with the following fields and buttons:

- Web Code(DDNS ID)**: A text input field containing the value "H4F4057000001392".
- Your domain name**: A text input field containing "http://soon", followed by ".ddnsip.net" which is part of the form's label.
- Buttons**: Two buttons labeled "Register" and "Delete" are positioned below the input fields.

In the first connection, install "ActiveX". If the ActiveX is installed, then DVR IP and DVR Port is set as a default value by itself. So if you enter the user ID and password, you can connect to the DVR.

**Display Configuration**

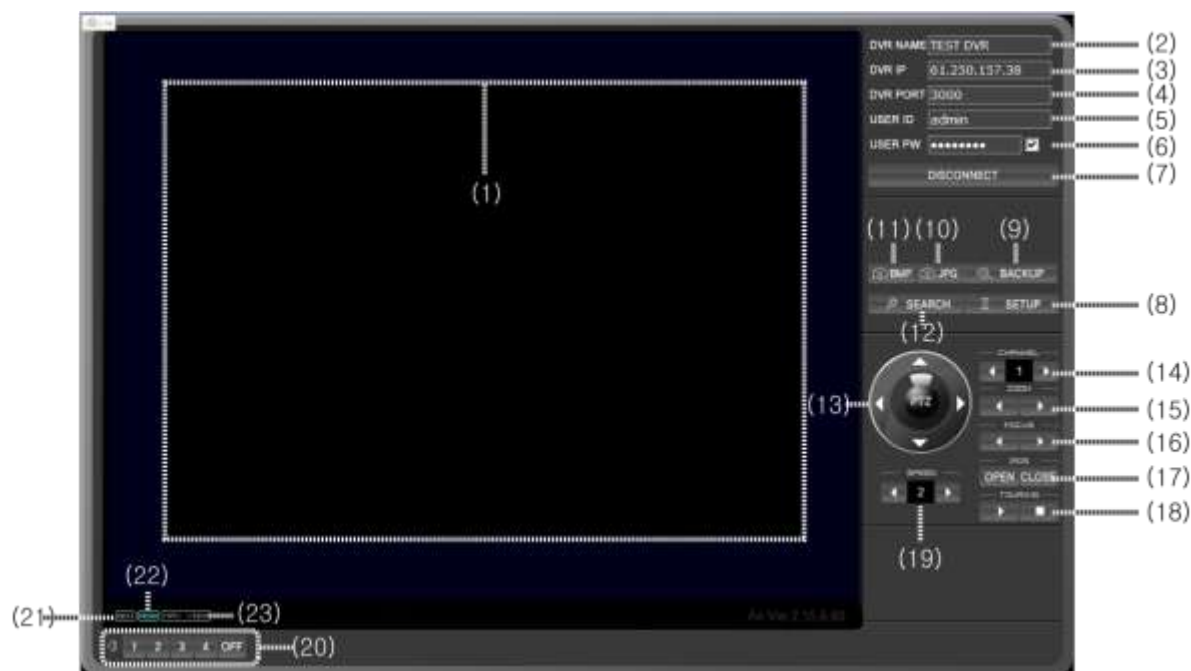

(1) Display area : Whenever you click, the selected channel or split screen is displayed.

(2) DVR Name: Enter any name you want. When you reconnect the DVR in the same pc, the name is saved.)

(3) DVR IP : The IP address registered to the DVR automatically is displayed.

(4) DVR PORT : The port registered to the DVR is automatically displayed.

(5) USER ID : Enter DVR's user ID

(6) USER PW : Enter DVR's password

(Note : The Password is saved when you reconnect the DVR in the same pc.)

(7) CONNECT / DISCONNECT

(8) SETUP : You can set the DVR remotely.

(The remote setup is the same with the local setup.)

(9) BACKUP : It's available to back up the live or playback video.

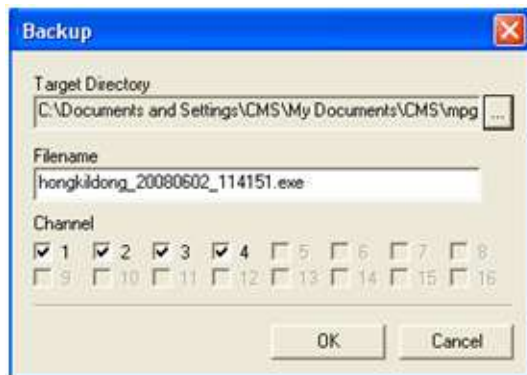

- Directory : Selects the folder to save.
- File name : Enter the file name to save.
- Channel: Select the channel to back up.

(10) JPG : Capture the current picture with jpg file and show the saved folder with popup message.

(11) BMP : Capture the current picture with BMP file and show the saved folder with popup message.

(12) SEARCH : You can search the recorded video remotely. The remote search is the same with the local search.

(13) Direction key : You can use it when controlling the PTZ.

(14) CHANNEL : Select the channel connected to a PTZ camera.

(15) ZOOM : Adjust the zoom

(16) FOCUS : Adjust the focus

(17) IRIS : Control the IRIS

(18) TOURING : Select On or Off for PTZ touring

(19) SPEED : Control the PTZ speed

(20) AUDIO : Select the audio channel to listen

(21) GDI : Display the video with GDI type (It increases the system load and it's recommended for the PC built-in the VGA card of high spec.

(22) RGB : It displays the pictures with the graphic card accelerator. It can decrease the system load but the picture quality is varied depending on the graphic card.

(23) MAX VIEW : Full screen function (Enter "ESC" to go back.)

# Index

- 10-way terminal block, 17, 20, 27
- 16 Channel DVR Storage Reference, 97
- 2CIF, 17, 18, 91, 92, 96
- 352X240. *See* CIF
- 352X288. *See* CIF
- 4 Channel DVR Storage Reference, 95
- 704X240. *See* 2CIF
- 704X288. *See* 2CIF
- 704X480. *See* D1
- 704X576. *See* D1
- 9 Channel DVR Storage Reference, 96
- 9 pole D-Type male connector. *See* RS-232
- Acronym Definition
  - AGC, 122
  - BNC, 23
  - CMS, 105
  - DDNS, 107
  - DHCP, 51
  - DMZ, 52
  - D-sub, 21, 24
  - DTE, 32
  - DVR, 10
  - GUI, 68
  - HDD, 14
  - IP, 106
  - ISP, 51
  - LED, 14
  - MAC Address, 72
  - PGM, 31
  - PRMS, 105
  - S.M.A.R.T., 14
  - SMTP, 110
  - VGA, 20
- administrator, 32, 34, 44, 72, 79, 107
- alarm out, 29
- Alarm Output, 17, 27
- Alarm Sensor Extension Box, 26, 27
- Android, 105, 179, 180, 181, 182, 183, 184, 186, 187, 188, 189, 190
- Audio Input, 20
- Audio Out, 20
- Auto Delete, 77, 88
- Auto Key Lock, 47, 89
- auto locking, 44
- Auto Loss Skip, 134, 137
- AVI, 168
- backup, 53, 87, 88, 147, 159, 160, 161, 163, 164, 165, 167, 168
- Backup, 36, 43, 45, 66, 84, 159, 160, 161, 164, 165, 166, 167
- Baud Rate, 129
- Blackberry, 105
- BNC, 17, 20, 23, 24
- Brightness**, 122, 123
- Calculating Storage, 94
- Calendar, 18, 63, 66, 147, 148, 149, 151, 161
- Camera Input, 20, 24
- Caution
  - circuit overload, 12
  - cleaning unit, 12
  - cover off, 12
  - improper upgrade, 12
  - maximum temperature, 11
  - noise, 13
  - odor, 13
  - Product Weight, 18
  - Sensor Voltage, 28, 31
  - Shock, 13
  - side clearance, 11
  - ventilation, 13
  - vibration, 13
  - voltage tolerance, 12
  - wall clearance, 11
- CIF, 17, 18, 91, 92, 96, 108
- class A IP address, 51
- class C IP address, 51
- CMS, 108, 128, 177
- Configure Port, 52
- Configuring User, 86, 87
- Contents of Items Included, 15
- Contrast**, 122, 123
- Covert, 88, 122
- DDNS, 17, 72, 107, 108, 109, 112, 113, 172, 181, 189, 193, 194, 200
- DDNS OPTION**, 108
- DDNS services, 112
- DE-15F. *See* VGA
- DE-9M. *See* RS-232
- default admin password, 44
- Default Setting, 79

De-Interlacing, 158  
 DHCP, 17, 33, 34, 51, 106, 107, 108  
 Dimension, 18  
 Directional Button, 36  
 DMZ, 52, 113  
 dry contact, 29, 30  
 dry sensors, 31  
**Dual Stream**, 108, 121  
 DVR ID, 70, 172  
 EIA/TIA E568B, 33  
 email notification, 110, 120  
 Email Notification, 120  
 email server, 110  
 EMERGENCY, 38  
 Emergency Lock, 47, 90  
 Error List, 77  
 Ethernet Pin Configuration, 33  
 Ethernet port, 20, 32  
 Ethernet port details, 32  
 event recording, 98, 100, 151, 154  
 Event Recording, 49, 98  
 EVENT RECORDING, 49, 98  
 F/W Version, 72  
 Factory Reset, 44  
 Factory Setting, 79  
 Fast Play, 155  
 Firmware, 10, 72, 83  
 Focus, 130, 131, 185, 186, 197  
 frame, 94, 96, 98, 99, 108, 121, 158, 183  
 frame view, 158  
 Frontal Keypad, 43  
 Gain. *See* Gain control  
 Gain Control, 122  
     AGC, 122  
     Static Gain, 122  
 Gateway Address, 107  
 GUI, 55, 68, 69, 72, 73, 79, 80, 83, 84, 86, 89, 98,  
     100, 102, 103, 106, 110, 112, 113, 120, 121,  
     122, 123, 124, 126, 127, 128, 129, 132, 134,  
     139, 140, 141, 143, 144, 145, 146, 148, 151,  
     160  
 H.264 compression, 91, 92  
 H/W Version, 72  
 HDD, 14, 15, 18, 44, 49, 54, 73, 74, 76, 77, 78,  
     81, 86, 88, 90, 91, 94, 95, 96, 97, 120, 133,  
     140, 148, 161  
 HDD Format, 76  
**Hue**, 122, 123  
 image tear, 158  
 Internal IP address, 51  
 IP address, 33, 34, 51, 106, 107, 108, 109, 194,  
     200, 202  
 iPhone, 105, 169, 174, 177  
 ISP, 51  
 Labeling Camera, 48  
 MAC address, 72  
 Main Disk, 76  
 Mark In, 159, 160  
 MAX, 18, 28, 156, 204  
 maximum cable length for Category 5e, 32  
 menu tree, 55  
 Mirror Disk, 76  
 Modifying User, 87  
 Mouse Only Operation, 157  
 Mouse operation, 147  
 Mouse Sensitivity, 71  
 N/W Version, 72  
 Network Frame, 121  
 Network Port. *See* Ethernet port  
 Normally Open, 26, 27, 29  
 NTSC, 17, 18, 24, 71, 91, 92, 99, 189  
 Numeric keypad, 46  
 ODD, 18, 37, 74, 75, 77, 161  
 Operating Temperature, 18  
 PAL, 17, 18, 24, 71, 91, 99  
 Pan, 130, 131, 197  
 password, 44, 45, 46, 47, 86, 87, 110, 114, 120,  
     165, 172, 193, 201, 202  
 PGM output, 31  
 Playback Controls, 154, 157  
 Power  
     overload, 12  
     POWER OFF, 11, 14  
     POWER ON, 14  
     Uninterruptable Power Supply, 12  
     UPS. *See* Uninterruptable Power Supply  
     voltage tolerance, 12  
 Pre Recording, 98  
 Private IPv4 address. *See* Internal IP address  
 PRMS, 105, 108  
 PTZ, 20, 28, 29, 36, 38, 40, 43, 45, 53, 67, 88,  
     105, 122, 123, 124, 125, 126, 128, 129, 130,  
     131, 174, 177, 178, 184, 185, 186, 197, 203,  
     204

QUAD, 36, 38  
Quick Backup, 160  
Recording Frame Speed, 17  
Recording Resolution, 17  
Rewind, 18, 36, 155, 156  
right and left field, 158  
Right mouse click, 43  
RJ-45 port. *See* Ethernet port details  
Root Menu, 53, 55, 63, 66, 67, 68  
Router, 34, 35  
RS-232, 17, 24, 25  
RS-485, 17, 27  
SATA, 18, 74, 75  
SCHEDULE RECORDING, 100  
Search, 18, 36, 43, 63, 64, 65, 88, 105, 147, 148,  
151, 152, 153, 169, 174, 175, 187, 196  
Search Button, 147  
Sensor, 17, 18, 20, 26, 27, 28, 29, 30, 31, 40,  
100, 101, 102, 103, 120, 139, 140, 145, 146,  
152, 154  
space allocation in HDD, 49  
Split, 53, 54, 132, 133, 134  
SPLIT / SEQUENCE, 134  
SPOT, 17, 20, 23, 143  
Static IP, 17, 51, 194  
Subnet Mask, 107  
S-Video, 17, 20  
TCP/IP. *See* IP Address  
Technical Specification  
Audio, 17  
Operating System, 17  
Video Recording Compression, 17  
Video Transmission Compression, 17  
Temperature  
maximum temperature, 11  
operating temperature, 11  
Tilt, 130, 131, 197  
time bar, 150  
time server, 82  
Touring Mode, 125  
TV ADJUSTMENT, 138  
UI Version, 72  
USB memory, 20, 32, 53, 83, 84, 85  
USB Port, 20, 32, 37  
**Use Port**, 110  
User Group, 87  
VGA, 17, 20, 21, 22, 40, 138, 204  
Video Quality, 92, 108  
View Control, 157  
viewer, 165, 167, 174  
Web Server Port, 108  
Webcode, 72, 112, 113, 181, 189  
Weight, 18  
wet sensors, 31  
Windows Mobile, 105, 191, 192, 194, 196, 197,  
199  
Zoom, 130, 131, 185, 197

## Free Manuals Download Website

<http://myh66.com>

<http://usermanuals.us>

<http://www.somanuals.com>

<http://www.4manuals.cc>

<http://www.manual-lib.com>

<http://www.404manual.com>

<http://www.luxmanual.com>

<http://aubethermostatmanual.com>

Golf course search by state

<http://golfingnear.com>

Email search by domain

<http://emailbydomain.com>

Auto manuals search

<http://auto.somanuals.com>

TV manuals search

<http://tv.somanuals.com>