

INSTRUCTION MANUAL

22" Wide LCD Screen All in One System Built-in 8Ch DVR

MODEL: LCD2284DVR, LCD2288DVR, TFT2284C, TFT2288C
Ver. 030309, 041309, 042909, 102609

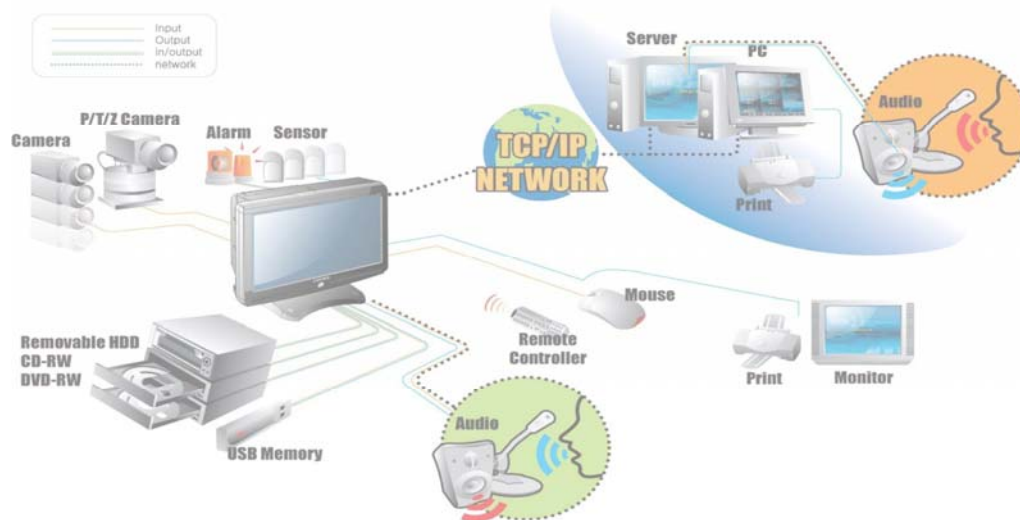

Copyright © 2007 Clover Electronics U.S.A. All Rights Reserved.

CONTENTS

ABOUT THIS MANUAL.....	9
UNPACKING.....	11
22" WIDE LCD PANEL BUILT-IN 8 CH DIGITAL VIDEO RECORDER	12
FEATURES.....	13
WHAT TO DO AT THE TIME OF INSTALLATION.....	15
SPECIFICATIONS.....	17
INSTALLATION	19
5-1. CONTROLS AND CONNECTORS.....	20
5-2. NOTE FOR INSTALLATION	23
5-3. SYSTEM CONNECTION	24
5-4. INSTALLATION	25
5-4.1. Camera Connection	25
5-4.2. Installation of the Monitor.....	25
5-4.2.1. Connection of Composite Monitor	26
5-4.3. Sensor Connection and RELAY IN &OUT.....	26
5-4.4. RS485 / RS232C Connection	27
5-4.5 Connection to an Ethernet Network (Optional).....	27
5-4.6. POWER CABLE CONNECTION	28
HOW TO OPERATE	29
6-1. GENERAL INFORMATION	31
6-2. OPERATING INTERFACE	32
6-3. IR REMOTE CONTROLLER	33
6-4. POWER ON/OFF	34
6-4.1. POWER ON	34
6-4.2. STAND-BY POWER MODE BUTTON.....	34
6-4.3 POWER OFF	34
6-4.4 APPEARANCE OR DISAPPEARANCE OF POWER BUTTON	35
6-5. MENU BAR ON/OFF	36

6-6. DISPLAY SCREEN.....	37
6-6.1. FULL SCREEN.....	37
6-6.2. SPLIT SCREENS.....	38
6-7. LIVE	39
6-7.1. FULL SCREEN.....	39
6-7.2. SPLIT SCREEN	39
6-7.3. SEQUENCING SCREENS	40
6-7.4. LIVE AUDIO	41
6-7.4.1. COMMUNICATION BETWEEN MONITOR AND CLIENT COMPUTER VIA INTERNET	41
6-7.4.2. COMMUNICATION BETWEEN MONITOR AND CAMERAS	41
6-7.5. ZOOM.....	43
6-7.6. OSD ON / OFF.....	44
6-7.7. PAN / TILT	45
6-7.8. SYSTEM STATUS.....	47
6-7.9. POWER LOSS LISTS.....	48
6-8. RECORD	52
6-8.1. Manual (Continuous) recording	52
6-8.2. Manual Event Recording.....	52
6-8.3. Timer Recording.....	53
6-8.4. Timer Event Recording	54
6-8.5. Recording Icons	55
6-9. REPLAY	56
6-9.1. QUICK REPLAY	56
6-9.2. REPLAY	56
6-9.2.1. Playback Devices.....	57
6-9.2.2. Set the Start Time	57
6-9.2.3. Replaying	59
6-9.2.4. Disappearance of Replay control buttons	61
6-10. COPY	63
6-10.1. Copying devices.....	63
6-10.2. Set the Copy Start Time (Copying extent)	64
6-10.3. Set the Copy End Time (Copying extent)	66
6-10.4. Copying the recorded data during replaying	67

SETUP.....	70
7-1. SETUP	73
7-2. SYSTEM	74
7-2.1. TIME / DATE	75
7-2.2. SYSTEM CONFIG	77
7-2.2.1. FACTORY DEFAULT	77
7-2.2.2. LOAD CONFIG / BACKUP CONFIG	78
7-2.3. PASSWORD.....	81
7-2.4. IR REMOTE ID.....	82
7-2.6. SYSTEM INFO	83
7-3. DISK MANAGER.....	84
7-3.1. HDD WRITE FAIL	85
7-3.2. HDD OVERWRITE.....	85
7-3.3. Format	85
7-4. CAMERA.....	87
7-4.1. Camera ON/OFF	88
7-4.2. Camera Name (Camera Title).....	88
7-4.3. Buzzer	89
7-4.4. Relay	89
7-4.5. Pan/Tilt Settings	90
7-4.6 Display.....	94
7-4.7 Sequencing dwell time	94
7-5. AUDIO	95
7-5.1. Audio Recording ON/OFF	96
7-5.2. Microphone Volume	96
7-6. RECORD.....	97
7-6.1. Record ICON Display.....	97
7-6.2. All Manual / Timer recording button	98
7-6.3. All Motion ON / OFF, Sensitivity and Velocity Setting.....	99
7-6.4. All Sensors ON / OFF	100
7-6.5. Size (Recording Resolution).....	100
7-6.6. Recording Speed.....	101
7-6.7. Recording Quality.....	102

System Instruction Manual

7-6.8. Recording Mode.....	103
7-6.8.1. Manual Recording.....	103
7-6.8.2. Manual Event Recording	103
7-6.8.3. Timer Recording (Schedule Recording)	103
7-6.8.4. Timer Event Recording	103
7-6.9. Recording by Motion Detection.....	104
7-6.10. Recording by Sensor (PIR Sensor)	112
7-7. NETWORK.....	115
7-7.1. IP Mode	115
7-7.2. GATEWAY, SUBNET, IP ADDRESS	116
7-7.3. Port.....	117
7-7.3.1 Port Forwarding	117
7-7.4. MAC ID.....	118
7-7.5. MNS (MAC NAME SERVER)	118
7-7.6. DDNS (DYNAMIC DOMAIN NAME SYSTEM).....	120
7-7.7. HOW TO SETUP AND USE THE DDNS.....	121
7-7.7.1. Router.....	121
7-7.7.2. Registration to the DDNS server	122
7-8. VIDEO ENHANCE.....	123
7-8.1. VIDEO ENHANCEMENT ON EACH CAMERA.....	124
7-8.2. VIDEO ENHANCEMENT ON VGA OUTPUT.....	125
REMOTE HOST PROGRAM	127
8-1. REMOTE PROGRAM OVERVIEW.....	128
8-2. INSTALLING THE PROGRAM TO PC.....	129
8-3. INTERNET EXPLORER.....	130
8-4. REMOTE HOST	132
8-4.1. Setup	133
8-4.2. Connection	135
8-4.3. Switch the Normal Screen to Full Screen.....	136
8-4.4. Speaker / Microphone	137
8-4.5. Copy	138
8-5. PLAYER	140

Contents

HDD INSTALLATION	147
9-1. HDD (HARD DISK DRIVE) INSTALLATION	148
APPENDIX	153
RECORDING TIME TABLE	154
FACTORY DEFAULT SETTINGS	155
FAQ	159
I CANNOT LOGIN	160
LIMITED 1YEAR WARRANTY	161
HOW TO OBTAIN FACTORY SERVICE	162

About this manual

This is the Instruction Manual for 22" Wide TFT-LCD monitor built-in 8Ch DVR system, Model LCD2284DVR, LCD2288DVR, TFT2284C and TFT2288C.

The last digit of the model numbers (e.g.: 4 and 8) represent the number of cameras included in the system.

This Manual describes how to install and operate the 22" Wide TFT-LCD monitor built-in 8Ch DVR system and provides specifications and features.

Please read this manual thoroughly and follow the installation process before using the system (Note: Be sure to correctly follow step 3. What to do at the time of installation).

Contact our distributors or dealers when you have any queries.

1 Unpacking

Care should be taken when unpacking to avoid damaging the system.
Please check that the following items are included:



Note: Contact your dealer immediately if any components are missing.

22" Wide LCD Panel Built-in 8 Ch Digital Video Recorder

LCD2284DVR (LCD2288DVR, TFT2284C or TFT2288C) is the most reliable and functional embedded DVR system available today. The system displays 8 channels of live images in Real Time speed, compresses data digitally and records them to the Hard Disk Drive, which can be replayed and searched easily any time.

The **LCD2284DVR (LCD2288DVR, TFT2284C or TFT2288C)** supports easy back up via USB port, external Hard Disk Drive and networking in both static & dynamic IP modes.

User can remotely view live images or search the recorded images.

Under emergency situation, the remote operator can control, turn on and turn off the field installed alarms, such as a siren or light.

It is a very user- friendly DVR system. User can control the **LCD2284DVR (LCD2288DVR, TFT2284C or TFT2288C)** by Mouse or Buttons on the front panel or Remote controller.

2 Features

- ▶ **22" Wide Screen**
 - High resolution TFT-LCD 1,680 x 1,050, Contrast ratio 1,000:1, Response time 5 msec
- ▶ **Multi Functional Record**
 - Powerful, multiple Record Modes available: Manual (Continuous), Timer, and Motion Detection Recording.
- ▶ **User friendly GUI**
 - A few simple buttons for Easy control.
- ▶ **Automatic System Recovery**
 - Automatic and Complete System recovery within 10 seconds.
- ▶ **Easy PTZ control via RS port**
 - No need to use PTZ controller
 - PTZ control from remote PC
- ▶ **Networking**
 - DHCP based automatic network set-up-Easy Network Configuration from Dynamic IP to Dynamic IP
 - Support TCP/IP and Remote Control on all DVR features
 - Up to 10 users can remote access the system through ComboViewer (GUI) or Internet Explorer simultaneously.
 - DDNS support
- ▶ **MPEG-4 Algorithm Compression**
 - The most advanced compression available today.
- ▶ **High Resolution DVR 720 x 480**
 - Real time display 240 Frames/sec
 - Recording speed 240 Frames/sec based on 720x240
 - Programmable display resolution and recording speed on each channel
- ▶ **2 Way Audio**
 - Communicate between the system and cameras or between the system and client computer through the internet
- ▶ **Easy Data Playback in any PC**
 - Back Up data convertible to AVI file format.
- ▶ **Back UP**
 - External HDD, Stick memory, and through network access.
- ▶ **Desktop or Wall-mountable**

3 What to do at the time of Installation

The system should be installed in the following order;

1. Make sure all the required hardware is available.
 - 22" wide TFT-LCD monitor built-in 8 Ch DVR
 - Up to 8 cameras ((Refer to the retail box for the number of camera in the system).
 - CCTV monitor or TV set if necessary
 - Network cable if connecting to a PC
2. Connect the cameras to the monitor (Refer to Fig 5-3).
4. Confirm if live video is displayed on the monitor before going to the next step.
5. Select the Setup Menu and set current date and time (Refer to Section 7-2.1).
6. Run the FACTORY DEFAULT setting in the SYSTEM menu.
7. Perform HDD formatting.
8. Escape from Setup Menu.
9. Set values for required options.
10. Network cable should be connected to the monitor before turning the power on.
Refer to Fig 5-7 for the cable specification.

4 Specifications

	ITEM	DESCRIPTIONS
VIDEO SIGNAL	Television System	NTSC PAL
	Refresh Rate	60 fields/sec 50 fields/sec
	Video Resolution	720x480 720x576
	Video Inputs	8- 6pin Din Cameras or 8- BNC Cameras
	Video Input Signal	Composite 1.0 Vp-p 75 Ohms
	Video Output	1- Composite output
	Video Output Signal	Composite 1.0 Vp-p 75 Ohms
VIDEO FEATURES	Live	240 Frames/sec display 200 Frames/sec display
	Zoom	2 times digital
	Sequence	Sequence display in Full size
	Display Format	1 screen(full), Quad pages split, 9 split pages, 16 split
	Camera Video enhance	Brightness, Contrast control on each cameras
AUDIO FEATURES	LCD Display enhance	Brightness, Contrast, saturation, 4:3 or 16:9 selectable
	G.723	4ch Input / 1ch Output
RECORD	Recording Speed	240 Frames/sec 200 Frames/sec
	Recording resolution	720x480,720x240,360x240 (NTSC) 720x576,720x288,360x288 (PAL)
	Codec	Mpeg4
	Recording	Timer, Motion, Alarm, Manual individually set
	Pre record	0~30 sec
	Material	SATA HDD(Auto overwrite)
SEARCH	Manual, Timer ,Motion, Alarm, Each Camera, All Camera	Fast x128 , Slow, Forward, Reverse, Frame by Frame
BACKUP	External HDD, USB memory, through Network	Each Camera, ALL Cameras, Time range
Recorded data lock	Data protection in overwrite HDD	Time range, Back up
USER INTERFACE	GUI	RGB 24bit full color
	Operating interface	Mouse, Keypad, IR remote controller, Network
NETWORK	Ethernet 10/100M Auto	TCP/IP, DHCP, MNS server
EMAIL NOTIFICATION	SMTP Server	Alarm, Motion, Record ON/OFF, Replay, HDD Fail, Video loss, Power Loss...etc
PC Program	Remote viewer	Same as DVR monitor (Mouse or Key button)
	PC Player	External HDD, USB memory, Internal HDD (Replay, Convert, Copy, Print)
USB	USB 2.0	for external DVD R/W, CD R/W, HDD, USB memory
SERIAL	RS485	8 camera Pan/Tilt, Remote control
ALARM	Alarm Inputs	8 Inputs
	Alarm Outputs	1 Relay Output(1A max)
	Alarm Latch up	1~30 sec
	Buzzer Out	On/Off
HDD	SATA	Refer to the retail box
POWER	Input Voltage	AC 110V/ 220V 50~60Hz (Free voltage)
	Power consumption	Approx. 130W
CONNECTORS	Video Inputs	8- 6pin DIN & 8 BNC
	Video Output	1 RCA for slave monitor
	Audio Output	1 RCA for Speaker
	Alarm In/Out	Alarm In: 9pin terminal block, Alarm Out: 3pin terminal block
	RS485	2pin terminal block
	Ethernet	RJ45
	Mouse	USB mouse
MECHANICAL	Dimension(m/m)	531(W)x440(H)x79(D), 531(W)x446(H)x230(D): with mounting bracket
	Weight	Approx. 19 Lbs

ENVIRONMENT	Operating Temperature	0 ~ 60°C
	Humidity	10 ~ 60%
LCD	Display	22" TFT LCD active matrix
	Pixel Pitch	0.282(H) x 0.282(V) mm
	Active Display Area	473.76(H) x 296.1(V) mm
	Display Colors	16.7M (Hi-FRC)
	Display Mode	Normally White
	Pixel Arrangement	RGB vertical stripe
	Luminance of White	300 cd/m ²
	Contrast Ratio(Center)	1000 : 1
	Viewing Angle L/R/T/B	80 / 80 / 80 / 80 degrees
	Operating Temperature	0°C ~ 60°C
	Storage Temperature	-25°C ~ 60°C

[Fig.4-1 Specifications]

Design and the specifications are subject to change without notice.

5

Installation

CONTENTS

5-1. CONTROLS AND CONNECTORS	20
5-2. NOTE FOR INSTALLATION	23
5-3. SYSTEM CONNECTION	24
5-4. INSTALLATION	25
5-4.1. CAMERA CONNECTION	25
5-4.2. INSTALLATION OF THE MONITOR	25
5-4.2.1. CONNECTION OF COMPOSITE MONITOR	26
5-4.3. SENSOR CONNECTION AND RELAY IN & OUT	26
5-4.4. RS485 / RS232C CONNECTION	27
5-4.5 CONNECTION TO AN ETHERNET NETWORK (OPTIONAL)	27
5-4.6. POWER CABLE CONNECTION	28

5-1. Controls and Connectors

- Front

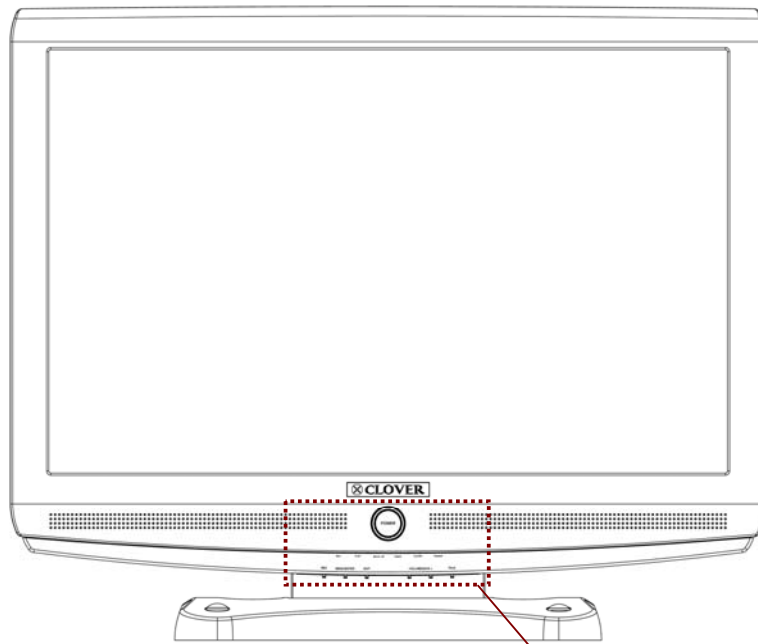

[Fig. 5-1 Front View]

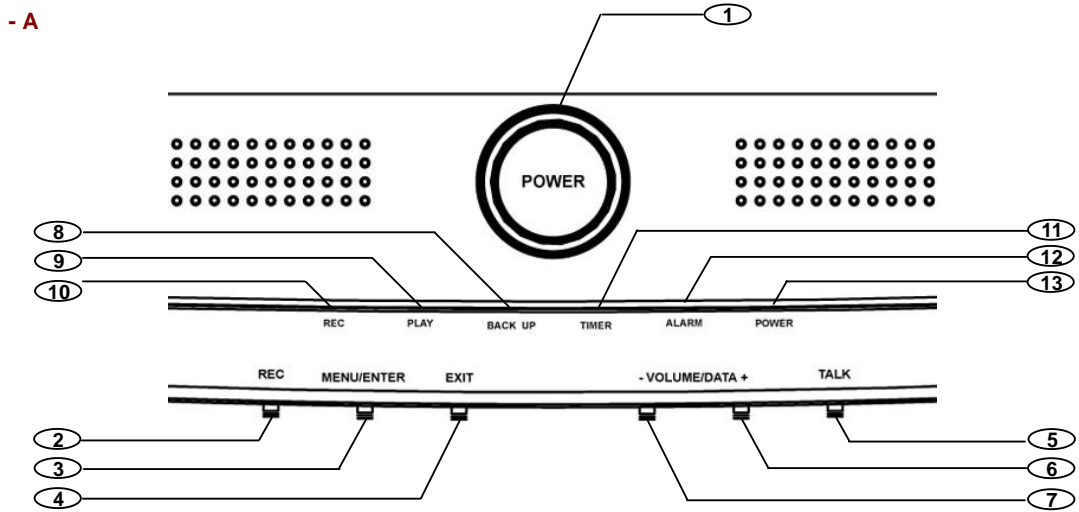

1. Stand-by Power Mode Button

- Turn the LCD Panel (Screen) On or Off
- Even though the LCD Screen is turned off by pressing this button, the system will be continued to work.

2. REC Key

- Press this key to start recording.
- In order to stop recording, click the REC button on the MENU Bar and the following message will be appeared. Click the OK button.



3. MENU / ENTER Key

- This key along with (+), (-), and Exit key are used for Video enhancement on VGA output (See section 7-8.2 for more detailed information).

4. EXIT Key

See section 7-8.2 for information.

5. TALK Key

See section 6-7.4.2 for information.

6. VOLUME / DATA (+) Key

- Used to increase Audio Volume for the system.
- See section 7-8.2 for additional information.

7. VOLUME / DATA (-) Key

- Used to decrease Audio Volume for the system.
- See section 7-8.2 for additional information.

8. BACK UP LED

- The red LED will blink when the system is in the copying mode.

9. PLAY LED

- The green LED will blink when the system is in the playing mode.

10. REC LED

- The red LED will blink when the system is in the recording mode.

11. TIMER LED

- The red LED will blink when the system is in the timer recording mode.

12. ALARM LED

- The green LED will blink when an alarm is activated or video loss.

13. POWER LED

- The red LED is lit when the Power switch on the rear of the system is ON.

- Rear

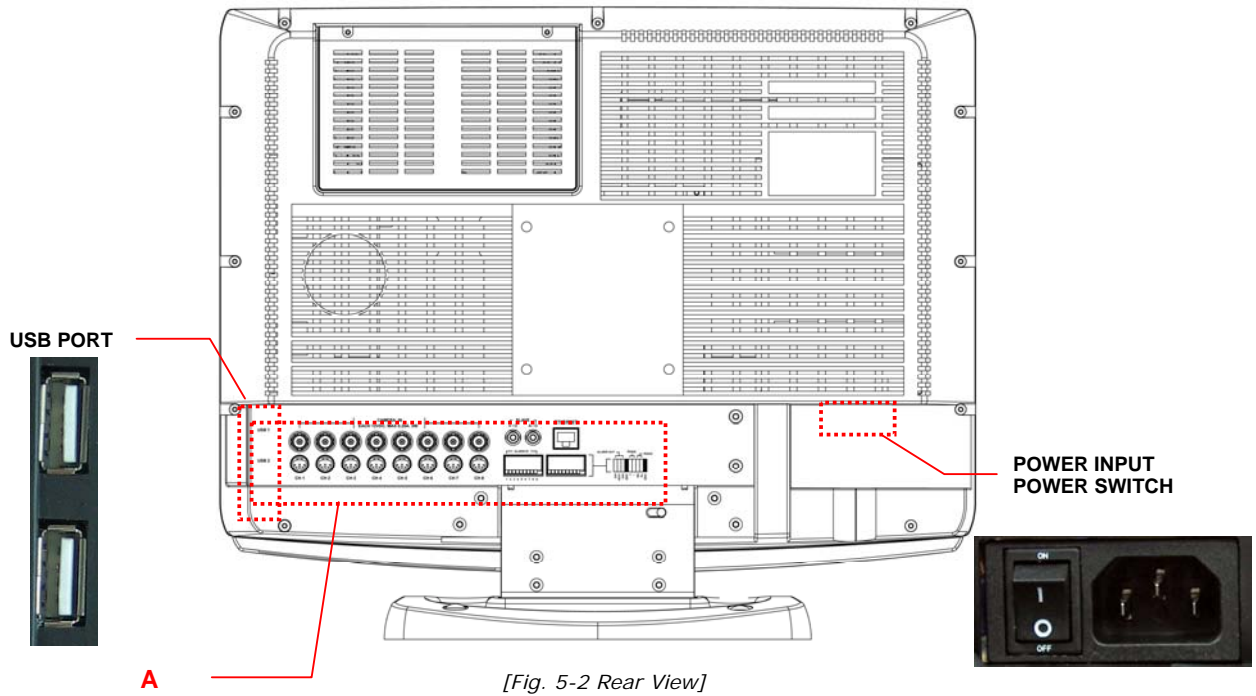

- A

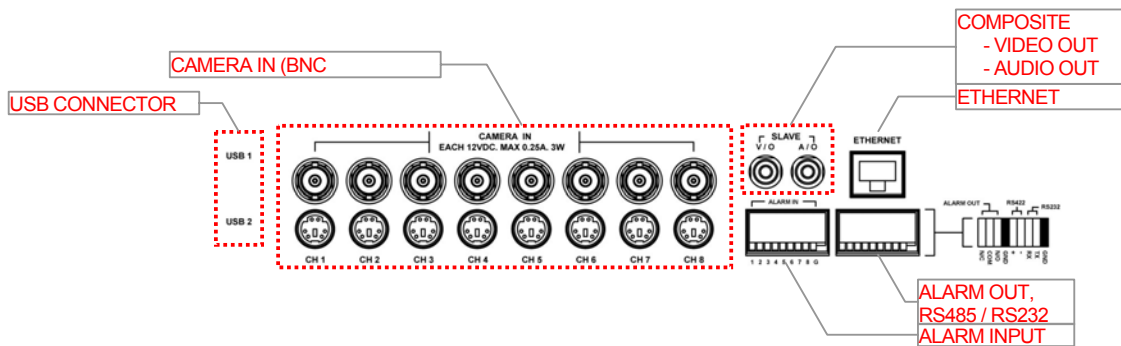

5-2. Note for Installation

- ◆ Install the system according to the instructions described in this manual.
- ◆ The 22" LCD monitor built-in 8Ch DVR and Indoor Cameras are designed for indoor use and should not be used outdoors.
- ◆ Avoid any area with high humidity or dust which can shorten lifetime of the system.
- ◆ Choose a well ventilated area and keep minimum of 10" away from obstructions. Do not place the system near heat generating devices.
- ◆ Avoid any area with movement as this can interfere with the internal Hard Drive.
- ◆ Use a compatible input/output signal type of cameras and monitor.
- ◆ Contact your dealer if you have any problems in regards to the installation of this system.

The Warranty may be voided in case of unauthorized disassembling, abuse or modification.

5-3. System Connection

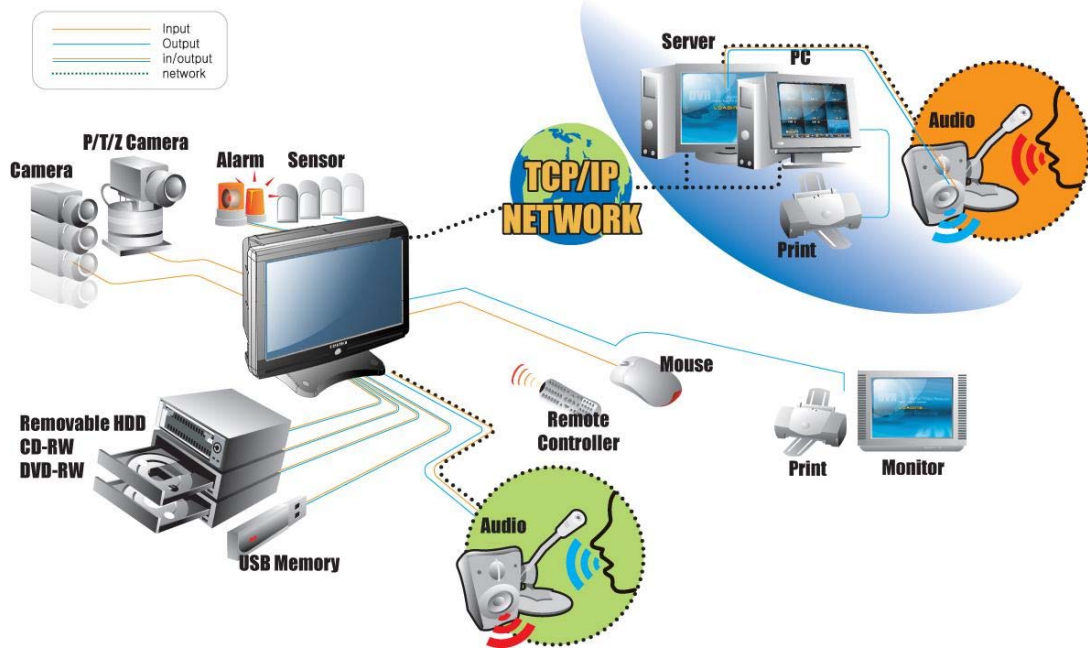

[Fig 5-3 System Connection]

5-4. Installation

5-4.1. Camera Connection

▫ Connection of 6pin MINI DIN Cameras

Connect the supplied cameras to the Camera Input (6pin mini DIN jack) on the back of the system as shown in [Fig. 5-2 Rear View].

▫ Connection of BNC Cameras

Connect the BNC cameras (not included) to the Camera Input (BNC connector) on the back of the system as shown in [Fig. 5-2 Rear View].

5-4.2. Installation of the Monitor



[Fig. 5-3-1 Releasing the Lever]

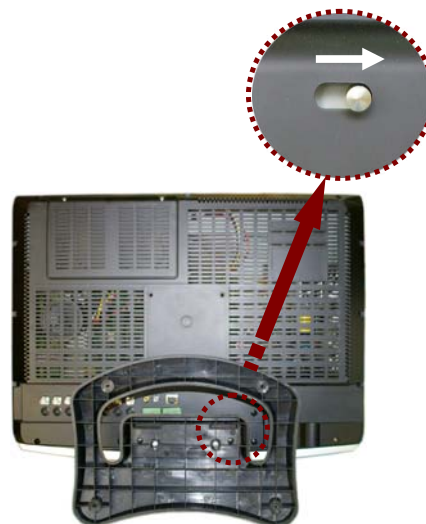

[Fig. 5-3-2 Locking the Lever]

▫ Desktop

- Pull the Lever to the left as shown in [Fig.5-3-1] and move the panel forward or backward until getting the proper angle of panel (screen) for viewing.
- Release the Lever and push it to the right as shown in [Fig.5-3-2] for locking the mounting bracket.

▫ Installation of the system on the wall

- Remove the screw cover on the top of the mounting bracket.

- Place the system on the flat surface with soft fabric and set the proper angle of panel (screen) as shown [Fig.5-3-2].
- Attach the mounting bracket to the desired location on the wall. Locate wall studs and securely fix the mounting bracket with the supplied screws.



Note:

- Pay attention to not make scratches or dents on the surface of panel (screen) during installation of the system.
- In case of this, the warranty will be voided.

5-4.2.1. Connection of Composite Monitor

If necessary, connect the composite Video Output (yellow RCA) and Audio Output (white RCA) to Video IN and Audio IN on a composite monitor or TV (RCA cable: not included).

5-4.3. Sensor Connection and RELAY IN &OUT

▫ **SENSOR Connection (SENSOR IN)**

Connect up to 8 sensors to ALM (SENSOR) IN. The Sensors should be contactor type and support NO (Normal Open).

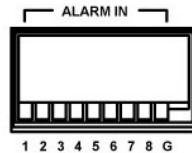

[Fig 5-4 SENSOR IN PIN]

▫ **ALARM OUT Connection**

When necessary, use ALARM OUT. The ALARM OUTPUT is a relay contactor type and supports NO (Normal Open) and NC (Normal Close). The Output capacity is 220V 1A. A higher capacity can cause system failure.

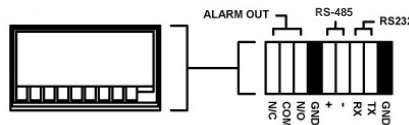

[Fig 5-5]

5-4.4. RS485 / RS232C Connection

- Connect the cable to the “RS485 / RS232C PORT” on the rear of the system.
Specification of the RS232C connector is standard for “DSUB9”
The Maximum Length of cable is 45 ft. When you want to use a longer distance, use “RS323 to RS422” converter

Refer to [Fig 5-6] for connection of Connector PIN

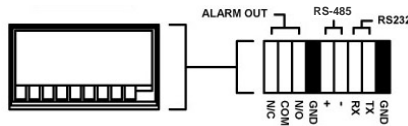

[Fig 5-6]

5-4.5 Connection to an Ethernet Network (Optional)

- **Connecting the cable to Ethernet.**
Our Ethernet connector is a RJ45 type. The maximum cable length is 300 ft. When you want to use a longer cable, we suggest using repeater.

Refer to [Fig. 5-7] for connector pin configuration.

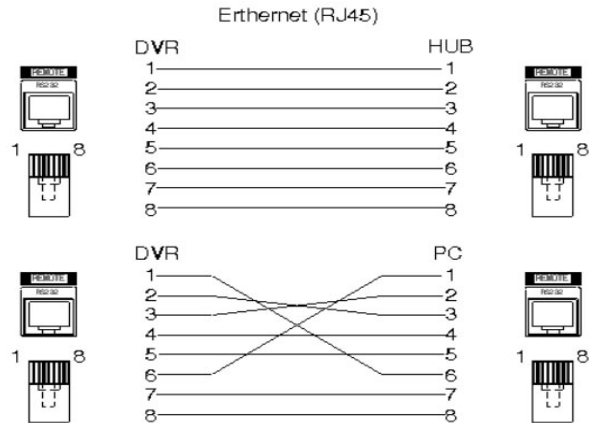

[Fig 5-7]

5-4.6. POWER CABLE CONNECTION

Connect the provided AC power cable to the monitor and an AC outlet. AC input voltage is AC 110V to 220V 50/60Hz.

It should not be shared with other electrical equipment on the same line.

Frequent power cuts can cause crucial failures, so if you have an unstable power source we recommend the use of an Uninterrupted Power Supply or other backup power source.

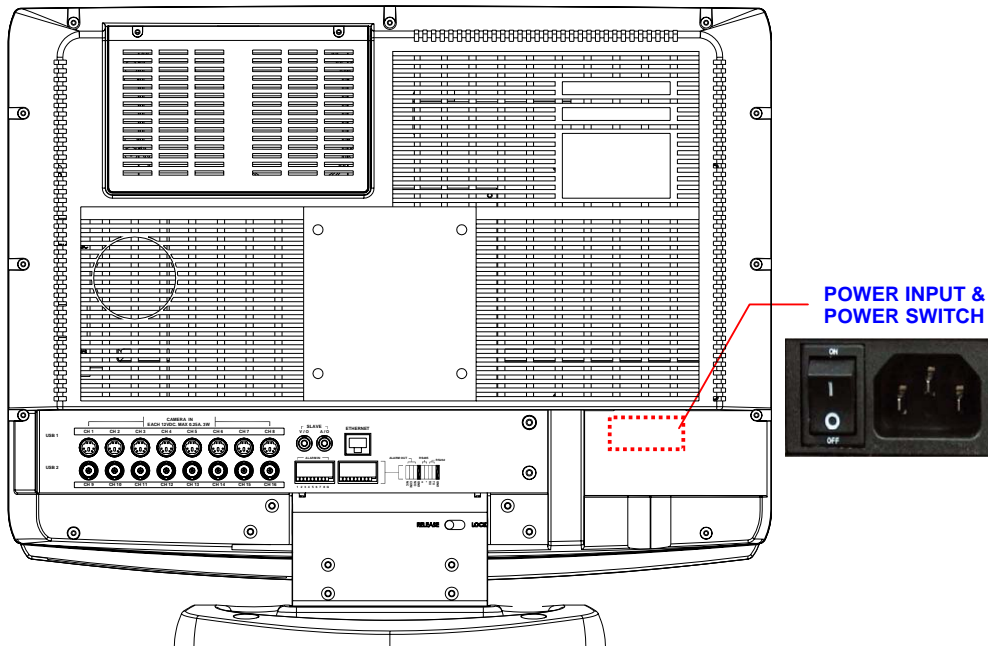

[Fig.5-8 Power cable connection]

6

How to operate

CONTENTS

6-1. GENERAL INFORMATION.....	31
6-2. OPERATING INTERFACE.....	32
6-3. IR REMOTE CONTROLLER	33
6-4. POWER ON/OFF	34
6-4.1. POWER ON	34
6-4.2. STAND-BY POWER MODE BUTTON	34
6-4.3 POWER OFF.....	34
6-4.4 APPEARANCE OR DISAPPEARANCE OF POWER BUTTON.....	35
6-5. MENU BAR ON/OFF	36
6-6. DISPLAY SCREEN.....	37
6-6.1. FULL SCREEN.....	37
6-6.2. SPLIT SCREENS	38

CONTENTS

6-7. LIVE	39
6-7.1. FULL SCREEN	39
6-7.2. SPLIT SCREEN	39
6-7.3. SEQUENCING SCREENS	40
6-7.4. LIVE AUDIO	41
6-7.4.1. COMMUNICATION BETWEEN MONITOR AND CLIENT COMPUTER VIA INTERNET	41
6-7.4.2. COMMUNICATION BETWEEN MONITOR AND CAMERAS	41
6-7.5. ZOOM	43
6-7.6. OSD ON / OFF	44
6-7.7. PAN / TILT	45
6-7.8. SYSTEM STATUS	47
6-7.9. POWER LOSS LISTS	48
6-8. RECORD	52
6-8.1. MANUAL (CONTINUOUS) RECORDING	52
6-8.2. MANUAL EVENT RECORDING	52
6-8.3. TIMER RECORDING	53
6-8.4. TIMER EVENT RECORDING	54
6-8.5. RECORDING ICONS	55
6-9. REPLAY	56
6-9.1. QUICK REPLAY	56
6-9.2. REPLAY	56
6-9.2.1. PLAYBACK DEVICES	57
6-9.2.2. SET THE START TIME	57
6-9.2.3. REPLAYING	59
6-9.2.4. DISAPPEARANCE OF REPLAY CONTROL BUTTONS	61
6-10. COPY	63
6-10.1. COPYING DEVICES	63
6-10.2. SET THE COPY START TIME (COPYING EXTENT)	64
6-10.3. SET THE COPY END TIME (COPYING EXTENT)	66
6-10.4. COPYING THE RECORDED DATA DURING REPLAYING	67

6-1. General Information

- You can operate all functions of the system by using the supplied remote controller or the mouse and partly with the keys on the bottom of the system. Additionally, you can remotely control the system via RS-422C or the Ethernet port located on the back of the system.
- System status is indicated by LED lights on the front panel of the system.
- The system is protected from any accidental pressing of any operator buttons, but care should be taken when using the functions of HDD Formatting as this can lead to data loss.

6-2. Operating Interface

There are 3 ways to operate the system by pressing the buttons on the bottom of the system or buttons on the remote controller and clicking the mouse. A lot of users mostly prefer to use a mouse on these kinds of products such as DVRs, computers and computer-aided devices. Therefore we would like to describe all the instructions in this manual based on using the mouse.

6-3. IR Remote Controller

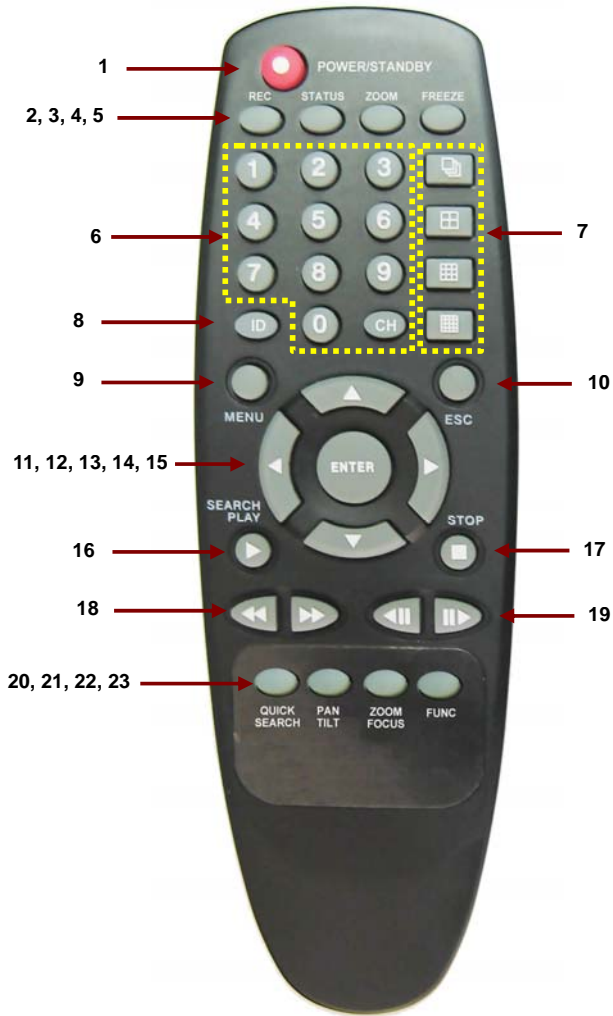

1.	POWER / STANDBY
2.	REC
3.	STATUS
4.	ZOOM
5.	FREEZE
6.	No.1~16 Channel (Full Screen) or IR ID Number
7.	Display format (Split)
8.	IR ID Set
9.	MENU
10.	ESC
11.	UP
12.	DOWN
13.	LEFT
14.	RIGHT
15.	ENTER
16.	SEARCH / PLAY
17.	STOP
18.	FF, REW
19.	Movement forward or backward by 1 Field.
20.	QUICK SEARCH
21.	PAN / TILT
22.	ZOOM / FOCUS
23.	FUNC

[Fig.6-1 IR Remote Controller]

6-4. Power On/Off

6-4.1. POWER ON

On the rear panel:

Turn on the **POWER** switch on the rear panel (See *Fig.5-2*). The LED on the front panel is lit when the **POWER** switch is **ON**.

By Stand-by Power Mode Button

Press this button on the front panel (See *Fig.5-1*) to turn **ON** the system when the **POWER (MAIN)** switch is turned **ON** and the **Stand-by Power Mode Button** is turned **OFF**.

6-4.2. STAND-BY POWER MODE BUTTON

In order to extend the lifetime of the LCD screen and the backlights inside the monitor, press (**less than 1 second**) the **POWER** button located on the front panel (See *Fig.5-1*) to turn **OFF** if you don't need to observe the system for a long time. The system will continue recording when it is in the recording mode even though the **Stand-by Power Mode Button** is turned **OFF**.

6-4.3 POWER OFF

By pressing the Stand-by Power Mode Button:

Press the **POWER** button on the front panel for **3 seconds** and then the **POWER OFF** message as shown in [*Fig.6-2*] will be displayed on the screen.

- Click the **OK** button to turn the power **OFF**.

On the remote controller:

Press the **POWER** button on the remote controller and then the following message will be displayed on the screen.



[*Fig.6-2*Message of POWER off]

- Press the **ENTER** button to turn the power **OFF**.

By clicking the mouse:

- Click the **POWER OFF** button on the MENU bar (See Fig.6-3) and then the message (See Fig.6-2) will be displayed on the screen.
- Click the **OK** button to turn the power **OFF**.



[Fig.6-3 POWER button on MENU bar]

6-4.4 APPEARANCE OR DISAPPEARANCE OF POWER BUTTON

The Power On/Off button and the Audio buttons (See section 6-7.4) as shown in [Fig.6-3-1] will always stay on the MENU bar when the system is not connected through the **COMBO VIEWER** (Client Host Program or Internet Explorer). But the Power On/Off button and the Audio buttons on the MENU bar as shown in [Fig.6-3-1] will be disappeared on the screen of the system and the client's computer when the system is connected through the **COMBO VIEWER** and the mouse pointer is on the **COMBO VIEWER** [See Fig. 6-3-2].

We designed this function so that users can not turn the power On/Off or control the audio functions on the DVR system through internet.



[Fig.6-3-1 Power & Audio buttons]



[Fig.6-3-2 No Power & Audio buttons]

To appear the buttons (See Fig.6-3-1) on the MENU bar: just move the Mouse-pointer on the screen of the system only, not on the COMBO VIEWER.

6-5. Menu Bar On/Off

Right-click on the screen in the LIVE or the RECORD mode. The MENU bar will be appeared and then displayed for 15 seconds. Right-click again, then it will be disappeared.



[Fig.6-4 LIVE Screen]

6-6. Display Screen

6-6.1. FULL SCREEN



[Fig.6-5 FULL screen]

6-6.2. SPLIT SCREENS



FULL SCREEN

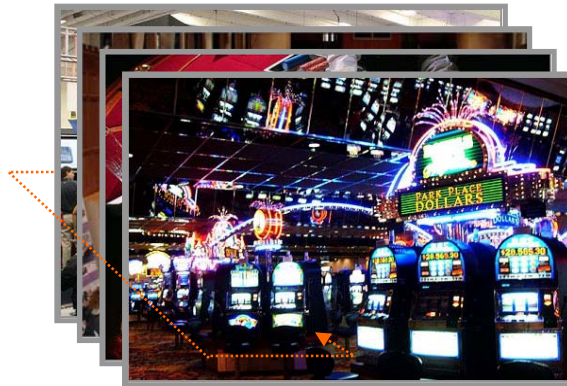

SEQUENCING SCREEN



[4A] 1st QUAD SCREEN



[4B] 2nd QUAD SCREEN



8 SPLIT SCREEN

6-7. LIVE

6-7.1. FULL SCREEN

- A Full SCREEN is available in the LIVE mode or the RECORD mode.
- Click on a certain camera's screen in the LIVE mode or in the RECORD mode and then a FULL SCREEN will be displayed.
- Click the FULL screen to return to the SPLIT SCREEN.

6-7.2. SPLIT SCREEN

- A SPLIT SCREEN is available in the LIVE mode or the RECORD mode.
- Click the DISPLAY icon on the MENU bar and then the pop-up screen will be displayed (See Fig.6-6).
- Click one of the SPLIT screens on the pop-up screen.



[Fig.6-6 DISPLAY pop-up screen]

6-7.3. SEQUENCING SCREENS

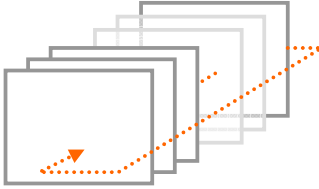

- Displaying the cameras in SEQUENCE is available in the LIVE mode or the RECORD mode.
Each of the channels will be displayed in sequence and the dwell time can be adjusted in the camera set up menu (Refer to section 7-4.7).

-  This ICON is displayed in the upper left hand corner of the screen while the system is in the Sequencing Mode.
- Click a Full screen to return to the SPLIT screen while the system is sequencing.

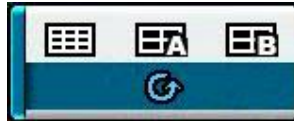

[Fig. 6-7 LIVE Menu DISPLAY pop-up window]



[Fig. 6-8 SEQUENCING screen]

6-7.4. LIVE AUDIO

- The basic system (LCD2284DVR) includes two indoor cameras built-in two way audio and two outdoor cameras built-in one way audio and IR LEDs (Infrared) to view objects in the darkness. Audio functions up to 4 cameras.
- To listen, click the CHANNEL button on the MENU bar as shown below (See Fig.6-9). The CHANNEL can be changed by clicking the mouse repeatedly.
- Turn the AUDIO (speaker) ON by clicking the SPEAKER icon as shown below (See Fig.6-9). If the ICON turns in red by clicking, it represents that the AUDIO is turned OFF and if it turns in yellow, it represents that the AUDIO is turned ON.
- Adjust Audio Volume by Clicking the ▲ or the ▼ button when the AUDIO is turned ON.



[Fig. 6-9 Audio buttons]

6-7.4.1. COMMUNICATION BETWEEN MONITOR AND CLIENT COMPUTER VIA INTERNET

- This system is normally in listening mode between the LCD monitor and your computer through the Internet (GUI or Internet Explorer). In order to communicate between the system and your computer, connect a head phone or a microphone and a speaker to the computer. Adjust the Speaker and the Microphone volume on the ComboViewer (GUI) or Internet Explorer by clicking the amount of volume (See section 8-4.4 Speaker / Microphone).
- Don't forget to turn the AUDIO (speaker) ON by clicking the SPEAKER icon on the MENU bar (See section 6-7.4 for more information) on the system.

6-7.4.2. COMMUNICATION BETWEEN MONITOR AND CAMERAS

- Turn the AUDIO (speaker) ON by clicking the SPEAKER icon on the MENU bar (See 6-7.4 for more information).
- To communicate (two way Audio) with a camera, select one out of two Indoor cameras by clicking the CHANNEL button on the MENU bar and press the **TALK** button on the bottom

of the system.

- To listen only (one way Audio), select one out of indoor/outdoor cameras by clicking the CHANNEL button on the MENU bar.



Note:

- It is impossible to communicate between the system and the cameras as long as the COMBO VIEWER (GUI) is being executed, even though the Speaker and the Microphone are turned Off.
 - Exit the COMBO VIEWER by clicking the Exit button on the GUI in order to communicate between the system and the cameras.
 - In order to listen to the recorded audio in the playback mode, select the corresponding channel to make it a full screen.
-

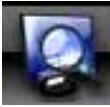

6-7.5. ZOOM

The image on the screen will be zoomed up to 2 times when the ZOOM button is clicked in the LIVE mode (This function is available on the full screen mode only).

- Click the ZOOM button on the MENU bar in the LIVE mode.
- Move the mouse on the ZOOMED screen, and then the 8-directional arrow marks will be appeared as shown below [Fig.6-10].
- Click the  (EXIT) button to return to the LIVE Mode.



[Fig. 6-10 ZOOMED screen]



6-7.6. OSD ON / OFF

OSD ON /OFF is possible in the LIVE mode or RECORD mode.

- Click the **OSD** button on the MENU bar to turn the OSD (On Screen Display) ON or OFF. When the OSD is in OFF position, all the texts on the screen will be disappeared.



[Fig.6-11 OSD ON SCREEN]



[Fig.6-12 OSD OFF SCREEN]



6-7.7. PAN / TILT

- Click the **PAN/TILT** button on the MENU bar in the LIVE mode to access the PAN/TILT cameras.
- Click the  (EXIT) button to return to the LIVE mode.



[Fig.6-13 PAN/TILT button]



[Fig.6-14 PAN/TILT window]

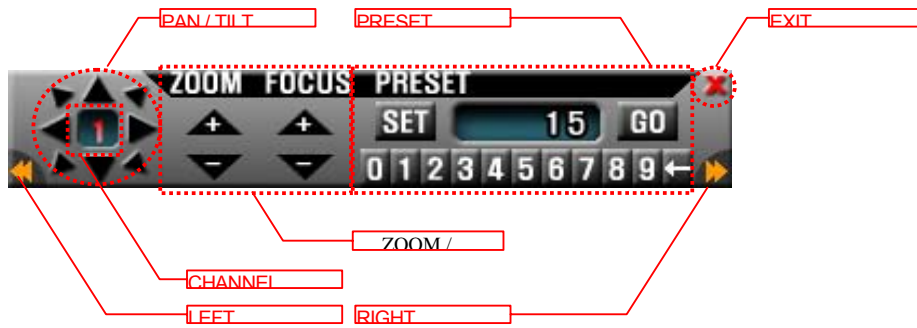

[Fig.6-15 PAN/TILT CONTROL]

▫ **Channel Selection and Screen Conversion**

To change a channel, press the CHANNEL button on the remote controller or click the CHANNEL button on the [Fig.6-15 PAN /TILT CONTROL window]. It will be converted a full screen.

To return to the LIVE mode, press the SPLIT button on the remote controller or click the



(EXIT) button.

▫ **ZOOM / FOCUS**

Control the ZOOM and FOCUS of PAN/TILT camera.

Click the ZOOM/FOCUS button on the PAN/TILT CONTROL window [Fig.6-15 PAN / TILT CONTROL window] or press the UP/DOWN/LEFT/RIGHT button on the remote controller.

▫ **Button of PAN/TILT Control window**



Move the PAN/TILT window as shown in Fig.6-15 by clicking the Left or Right button if necessary.

▫ **PAN / TILT**

Control the PAN and TILT of PAN/TILT camera.

Click the PAN/TILT Button on the PAN/TILT CONTROL window [Fig.6-15 PAN / TILT CONTROL window] or press the UP/DOWN/LEFT/RIGHT button on the remote controller.

▫ **PRESET**



[Fig.6-15-1 Preset Menu]

It is a function to preset the PTZ camera(s) which you wish to monitor frequently.

Preset Setup

- Select a position of camera you wish to preset and click the SET button in Fig.6-15-1.
- Click the number(s) for the current position of camera.
- To delete the numbers by using ← button.

Preset Execution

Click the number(s) which you preset and click GO button to move the camera.

* If you preset the number again, the previous setup is not available and only current setup is available.



6-7.8. SYSTEM STATUS

- Click the SYSTEM STATUS button on the MENU bar to see the system status as shown below [Fig.6-16].
- Click the  (EXIT) button to return to the LIVE mode or RECORD mode.



[Fig.6-16 SYSTEM STATUS button]

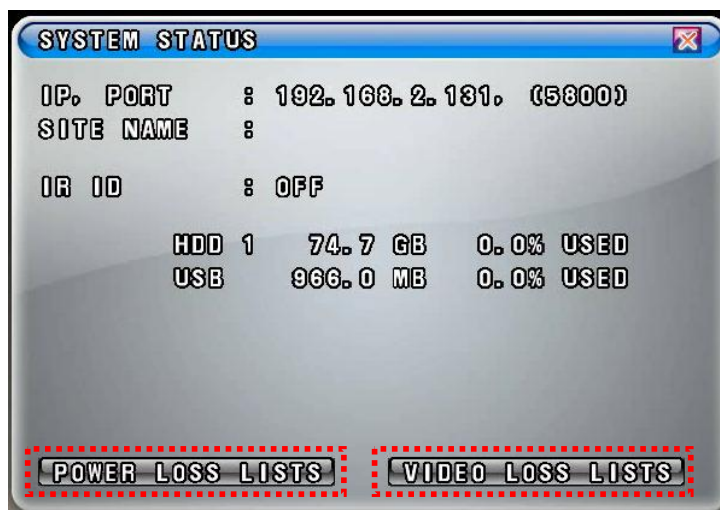

[Fig.6-17 SYSTEM STATUS window]

6-7.9. POWER LOSS LISTS

The list indicates the time/date when the system power was turned OFF.

- Click the POWER LOSS LISTS button on the SYSTEM STATUS window to view the POWER LOSS LISTS.
- Each of the pages contains 10 lists. You can search the pages by clicking the UP/DOWN button.
- Click the  (EXIT) button to return to the LIVE or RECORD mode.



[Fig.6-18 POWER LOSS LISTS window]

▫ CLEAR LISTS button

Click the CLEAR LISTS button to clear the lists, you will be prompted to confirm changes.

When you click the OK button, the POWER LOSS LISTS will be deleted.

To cancel, click the CANCEL button

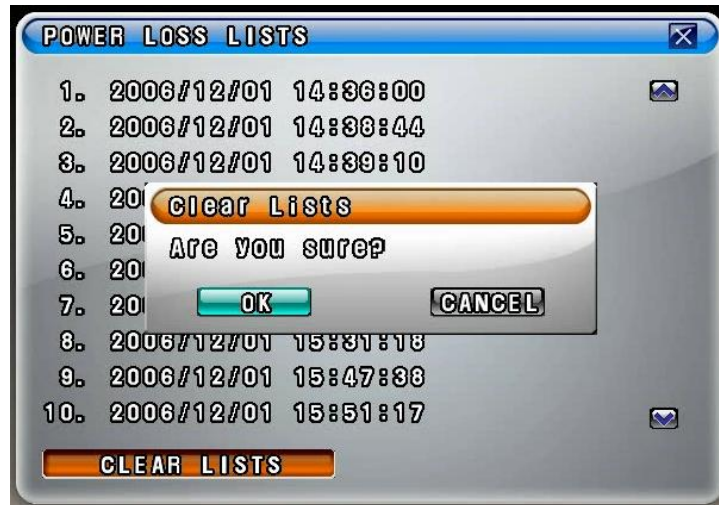



Fig.6-19 POWER LOSS LISTS Message

6-7.10. VIDEO LOSS LIST

The list indicates the video loss channel and the time/date when the video signal was disconnected.

- Click the VIDEO LOSS LISTS button on the SYSTEM STATUS window to view the VIDEO LOSS LISTS.
- Each of the pages contains 4 lists. You can search the pages by clicking the UP/DOWN button.
- Click the  (EXIT) button to return to the LIVE or RECORD mode.



[Fig.6-20 VIDEO LOSS LISTS window]



[Fig.6-21 VIDEO LOSS window]

▫ CLEAR LISTS button

Click the CLEAR LISTS button to clear the lists, you will be prompted to confirm changes.

When you click the OK button, the VIDEO LOSS LISTS will be deleted.

To cancel, click the CANCEL button



[Fig.6-22 VIDEO LOSS LISTS Message window]









6-8. Record



This system provides Watchdog function.

When power goes off during recording and then the power turns on, the system will automatically start recording.







6-8.1. Manual (Continuous) recording



- Click the SETUP icon on the MENU bar in the LIVE mode.
 - Click the RECORD button in the SETUP menu and the RECORD window will be displayed.
 - Select the MANUAL RECORDING () between the MANUAL RECORDING () and the TIMER RECORDING () as shown in [Fig.6-23]. All channels can be set at the same time by clicking the ALL ( ) or each of the channels can be set by clicking the MANUAL RECORDING () on the CAM 1 through CAM 8.
- The MOTION () and SENSOR () as shown in [Fig.6-23] should be turned **OFF** in this recording mode.
- Press the RECORD button on the remote controller or click the RECORD icon on the MENU bar.



[Fig.6-23. Manual Recording setup]

6-8.2. Manual Event Recording

- Click the SETUP icon on the MENU bar in the LIVE mode.
- Click the RECORD button in the SETUP menu and the RECORD window will be displayed.
- Select the MANUAL RECORDING () between the MANUAL RECORDING () and the TIMER RECORDING () as shown in [Fig.6-24]. All channels can be set at the same time by clicking the ALL ( ) or each of the channels can be set by clicking the MANUAL RECORDING () on the CAM 1 through CAM 8.





The MOTION () or SENSOR () as shown in [Fig.6-24] should be turned **ON** in this recording mode.

- Press the RECORD button on the remote controller or click the RECORD icon on the MENU bar.







[Fig.6-24 Manual Event Recording setup]

6-8.3. Timer Recording

- Click the SETUP icon on the MENU bar in the LIVE mode.
- Click the RECORD button in the SETUP menu and the RECORD window will be displayed.
- Select the TIMER RECORDING () between the MANUAL RECORDING () and the TIMER RECORDING () as shown in [Fig.6-25]. All channels can be set at the same time by clicking the ALL () or each of the channels can be set by clicking the TIMER RECORDING () on the CAM 1 through CAM 8.











The MOTION () and SENSOR () as shown in [Fig.6-25] should be turned **OFF** in this recording mode.

- Choose one among WEEKDAY, SATURDAY and SUNDAY in the TIMER menu by clicking the mouse on () that turns to (). You can choose the value () or () by repeatedly clicking the mouse.
- Select the Starting Time and Ending Time by clicking the mouse, change the values with the mouse's wheel and click the mouse again on the changed values to complete as shown in [Fig.6-27]. The recording time can be set in military hour mode (24hour).
- Press the RECORD button on the remote controller or click the RECORD icon on the MENU bar.



[Fig.6-25 Timer Recording setup]

6-8.4. Timer Event Recording

- Click the SETUP icon on the MENU bar in the LIVE mode.
 - Click the RECORD button in the SETUP menu and the RECORD window will be displayed.
 - Select the TIMER RECORDING () between the MANUAL RECORDING () and the TIMER RECORDING () as shown in [Fig.6-26]. All channels can be set at the same time by clicking the ALL () or each of the channels can be set by clicking the TIMER RECORDING () on the CAM 1 through CAM 8.
- The MOTION () or SENSOR () as shown in [Fig.6-26] should be turned **ON** in this recording mode.
- Choose one among WEEKDAY, SATURDAY and SUNDAY in the TIMER menu by clicking the mouse on () that turns to (). You can choose the value  or  by repeatedly clicking the mouse.
 - Select the Starting Time and Ending Time by clicking the mouse, change the values with the mouse's wheel and click the mouse again on the changed values to complete as shown in [Fig.6-27]. The recording time can be set in military hour mode (24hour).
 - Press the RECORD button on the remote controller or click the RECORD icon on the MENU bar.



[Fig.6-26 Timer Event Recording setup]



[Fig.6-27 Example for Timer Recording]

6-8.5. Recording Icons

The Recording Icons depends on recording modes are displayed in the upper left hand corner of the screen.

- To turn the Recording Icon OFF, click the DISPLAY ON in the RECORD menu and then it will be turned OFF. You can select the value **ON** or **OFF** by repeatedly clicking the mouse.

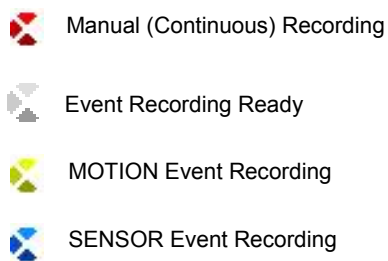

[Fig.6-28 Recording Icons]

6-9. REPLAY

6-9.1. QUICK REPLAY

It is available only by pressing the QUICK SEARCH button on the remote controller.

- Press the PLAY button, then the recent recorded data will be played.

6-9.2. REPLAY



- Click the REPLAY icon on the MENU bar, then the REPLAY window as shown in [Fig.6-29] will be displayed.
- Click the  (EXIT) button to return to the previous mode.

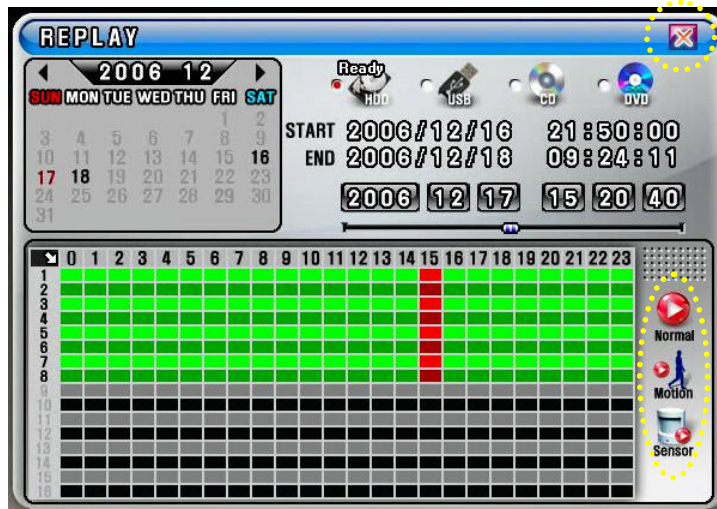

[Fig.6-29 REPLAY window]

6-9.2.1. Playback Devices

In order to playback, plug the USB devices such as external USB HDD, USB memory or USB 2.0 DVD-RW (or CD-R/W) to the USB port or insert a recorded media (CD-R/W or DVD-R/W) into the DVD-R/W drive.

When the devices are ready to playback, the **Ready** on the corresponding devices will be displayed in shown in [Fig.6-30].

- Click the mouse on a device among HDD, USB, CD-R/W and DVD-R/W that is displaying the **Ready** (See Fig.6-30). The corresponding LED will be lit in red when the device is selected.

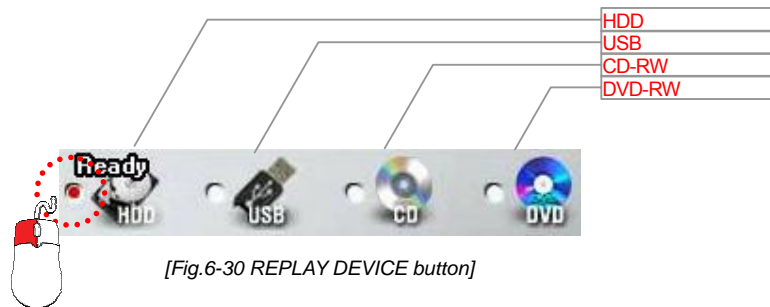

6-9.2.2. Set the Start Time

- Select the Date (year / month / day) on the calendar by clicking the mouse on the highlighted character in black that turns to highlighted character in red (See Fig.6-31). The highlighted character in black indicates the dates and times that contains recorded data, and the highlighted character in red indicates the selected dates and times.
- Select the month (year) by clicking the mouse on the ◀button or ▶ button.

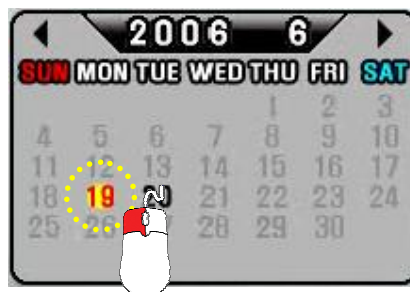

- Select the hour on the Start Time Select Window (See Fig.6-32) by clicking the mouse on the Hour (0 – 23 hour) you wish to start to play.

The green active buttons indicate the HOUR that contains recorded data, and the red active buttons indicate the selected Start HOUR.

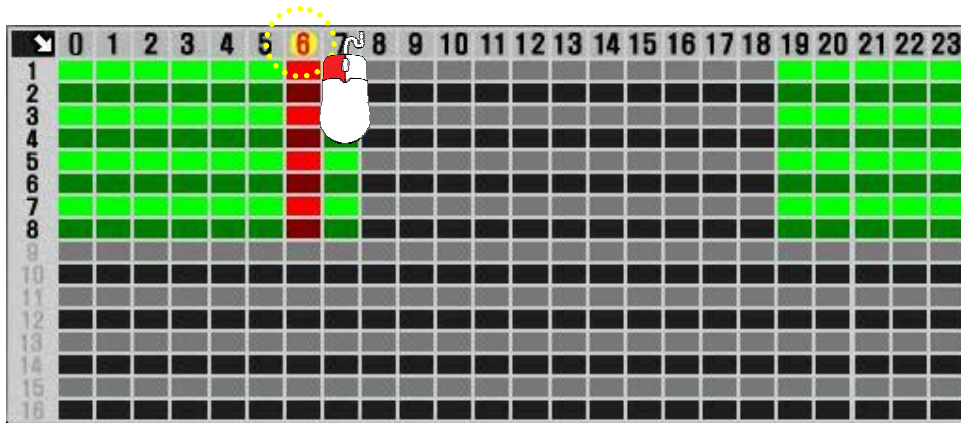

[Fig.6-32 Start Time Select window]

By using the Replay Time set-up buttons:

The time and date can also be set on the Replay Time set-up button window (See Fig.6-33).

- Select the values (year/month/date and hour/minute/second) by clicking the mouse, change the values with the mouse's wheel and click the mouse again on the changed values to complete as shown in [Fig.6-33].



[Fig.6-33 Replay time set-up button]

By using the Replay Time set-up bar:

The starting time to play can also be set by clicking the slider on the bar and dragging it or clicking the bar.



[Fig.6-34 Replay time set-up bar]

6-9.2.3. Replaying

Replaying start time set-up can be possible within a recording time extent.

- Replay buttons (NORMAL / MOTION / SENSOR)



NORMAL PLAY: Click the button to play all the recorded data.



MOTION PLAY: Click the button to play the recorded data by MOTION only.



SENSOR PLAY: Click the button to play the recorded data by SENSOR only.

- How to control while replaying





[Fig.6-35 Replay screen]

① Search Slider



It is possible to playback by clicking the slider on the bar or dragging it.

② PLAY / PAUSE

Click the  button to pause.

Click the  button to replay when in the pause mode.

③ REW/FF

During replaying, press the  or  button.

Keep pressing the  or  button to accelerate the speed up to 128 times.

④ PREV / NEXT

During replaying, press the  button to view previous frame in still image and press

the  button to view the next frame in still image.

⑤ Speaker ON / OFF

Turn speaker ON or OFF.

⑥ Speaker Volume

Adjust the Audio Volume by clicking the ▲ or the ▼ button when the AUDIO is turned ON.

6-9.2.4. Disappearance of Replay control buttons

During replaying, the replay control buttons appear on the bottom of the screen.

- To disappear, drag the mouse pointer downward until the replay control buttons disappear.
- To appear, drag the mouse pointer upward until the replay control buttons appear.

- Click the mouse on one out of channels during replaying to view a full screen.
- Click the mouse on the full screen during replaying to return to the split screen.

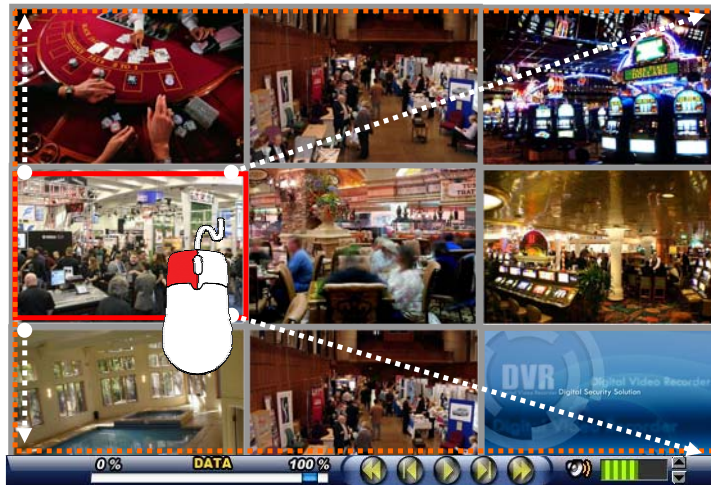

[Fig.6-36 SPLIT screen during replaying]

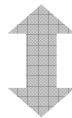

[Fig.6-37 FULL screen during replaying]

6-10. COPY



- Click the COPY icon on the MENU bar, and then the COPY window as shown in [Fig.6-38] will be displayed.
- Click the  (EXIT) button to return to the previous mode.

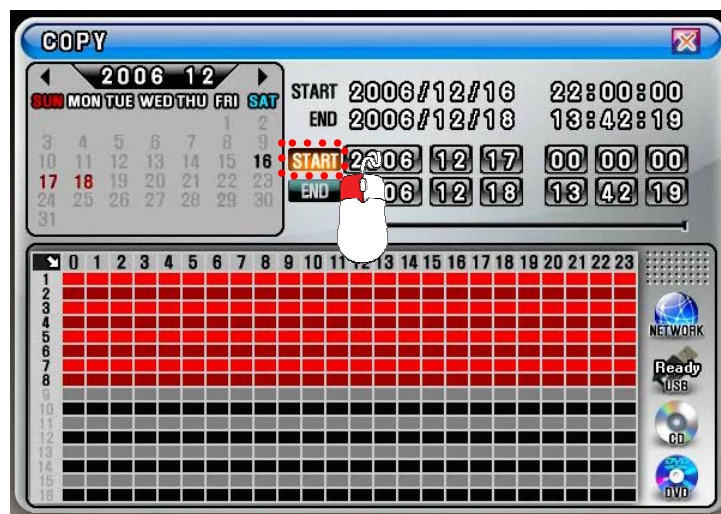

[Fig.6-38 COPY window]

6-10.1. Copying devices

In order to copy the recorded data, plug the USB devices such as external USB HDD, USB memory or USB 2.0 DVD-RW (or CD-R/W) to the USB port and insert a blank media (CD-R/W or DVD-R/W) into the DVD-R/W drive.

When the device and Media are ready to copy, the **Ready** on the corresponding device and Media will be displayed in shown in [Fig.6-38].

We recommend you to format the USB devices prior to copy the recorded data as follows, but the Medias such as CD-R/W and DVD-R/W don't need to format.

- Connect the USB devices to the system.
- Click the SETUP icon on the MENU bar, and the SETUP menu will be displayed.
- Click the DISK MANAGER in the SETUP menu, and the DISK MENAGER will be displayed.
- Click the mouse on the USB button in the DISK MANAGER, and you will be asked.
- Click the OK, and then the progressive bar will be showing along with FORMATTING USB....

In regards to blank Medias (CD-R/W and DVD-R/W)

Most Medias can be used with the system, but some of them may be not compatible with the system. Refer to the included instructions related to Medias or visit the website of DVD/CD DRIVE unit manufacturer for more information.

6-10.2. Set the Copy Start Time (Copying extent)

- Select the Date (year / month / day) on the calendar by clicking the mouse on the highlighted character in red that turns to highlighted character in black (See Fig.6-39).
The highlighted character in black indicates the dates and times that contains recorded data, and the highlighted character in red indicates the selected dates and times.
- Select the month (year) by clicking the mouse on the ◀button or ▶ button.
- Select the hour on the Copy Start Time and Channel Selection Window (See Fig.6-40) by clicking the mouse on the Hour (0 – 23 hour) you wish to start to copy.
The green active buttons indicate the HOUR that contains recorded data, and the red active buttons indicate the selected Start HOUR.

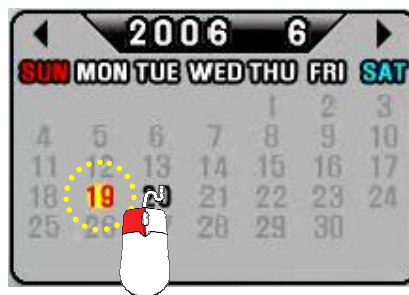

[Fig.6-39 Calendar for Copying]

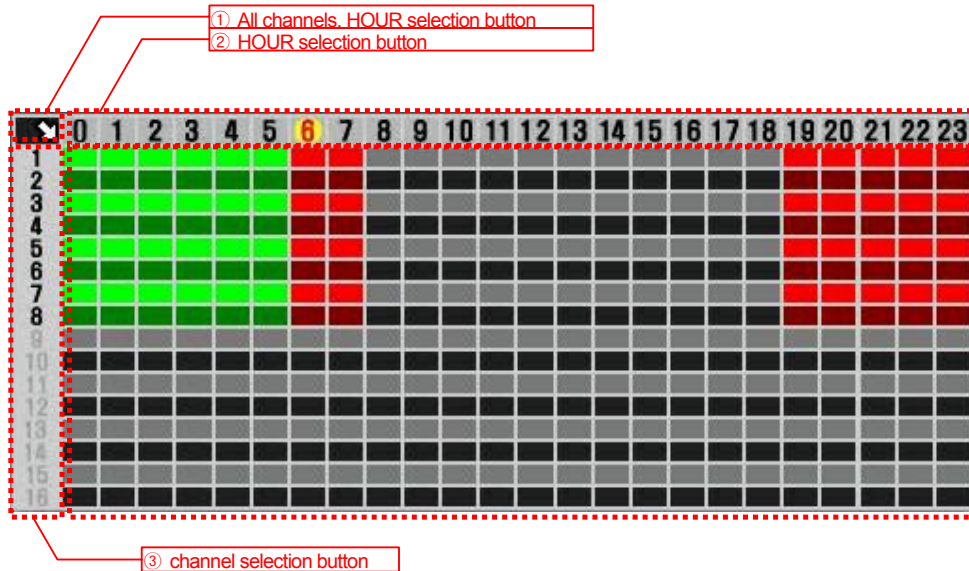

[Fig.6-40 Copy Start time and Channel Selection window]

- ① All channels, HOUR selection button.
Click the arrow button in the upper left corner as shown in [Fig.6-40] to set the full extent of the recording and all the channels simultaneously.
- ② HOUR selection button
Select the start time to copy by clicking the mouse on HOUR (0-23: in the military hour). Thereafter the extent of the copy will be saved on.
- ③ Channel selection button
Some channels can be selected by clicking the mouse on the corresponding channels.

By using the Copy Start/End set-up buttons:

The time and date can also be set on the Copy Start/End set-up buttons window (See Fig.6-41).

- Select the values (year/month/date and hour/minute/second) by clicking the mouse, change the values with the mouse's wheel and click the mouse again on the changed values to complete as shown in [Fig.6-41].



[Fig.6-41 Copy Start/End setup buttons]

By using the Start/End set-up bar:

The starting time to copy can also be set by clicking the slider on the bar and dragging it or just click the bar.



[Fig.6-42 Copy Start/End setup bar]

6-10.3. Set the Copy End Time (Copying extent)

Refer to the above explanation (See section 6.10.2.).

6-10.4. Copying the recorded data during replaying

The system allows users to copy the recorded data during replaying.

- Start replaying (See section 6-9).
- Right-click on the replaying screen, and then the COPY DATA screen will be displayed (See Fig.6-43).
- **To set the starting time and date to copy**, select the values (year/month/date window and hour/minute/second) on the COPY DATA window by clicking the mouse, change the values with the mouse's wheel and click the mouse again on the changed values to complete.
- Select each of channels (1 through 8 in red) or "A" in black for all the channels on the COPY DATA window, and then click on the SELECTED button to save.

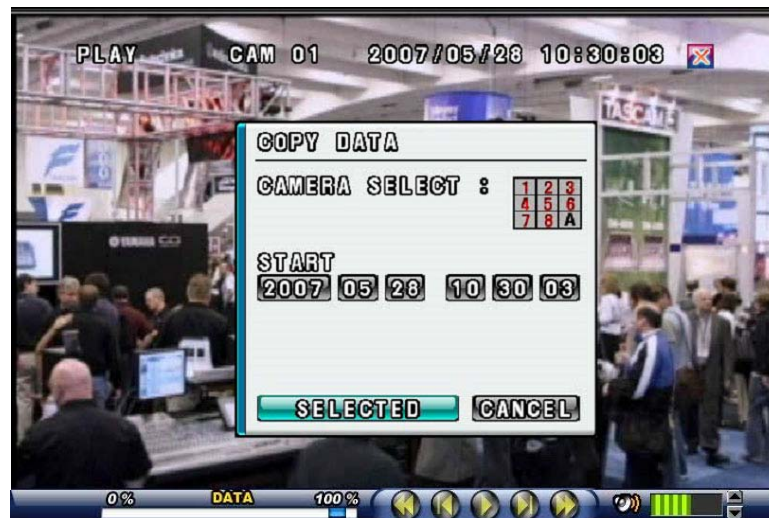

[Fig.6-43 Start Copy Time Setup window]

- **To set the ending time and date to copy**, right-click on the replaying screen again, and the COPY DATA window that contains end time for copying will be displayed (See Fig.6-44). Set the ending time and date to copy as described above.
- To select the COPY MODE, click on the GO TO COPY button (See Fig.6-44), and then the COPY window (See Fig.6-38) will be displayed. The time and date (starting time and ending time) to copy can be changed on the COPY window as well (See section 6-10.2).

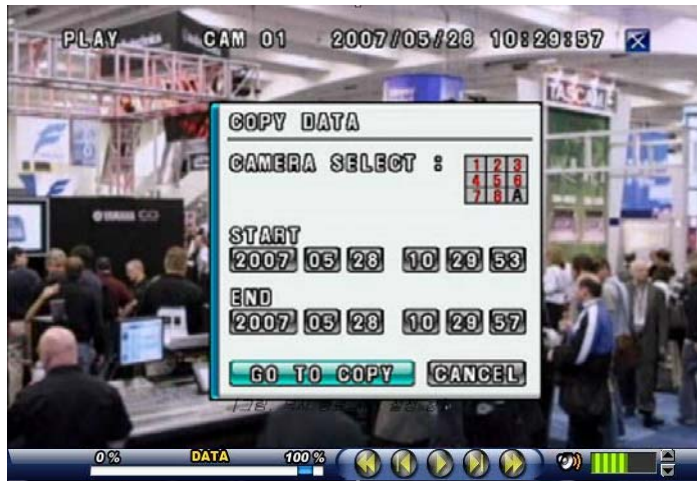

[Fig.6-44 End Copy Time Setup window]

- Choose one among NETWORK, USB, CD and DVD which are ready to copy (See section 6-10.1).

Select COPY Mode

Only when the device and media are ready to copy, the **Ready** on the corresponding device and media will be displayed.



NETWORK COPY

Save the recorded data in **PC** through the **COMBO VIEWER** by Network.

Click the **Network** button on the **COMBO VIEWER** to start copying. It is available only on the **COMBO VIEWER** (not on the system) and the networking should be connected to the system.



USB COPY

Save the recorded data in **USB Device**.

Click the **USB Device** button to start copying.



CD-RW COPY

Save the recorded data on **CD-R/W** Media.

Click the **CD-R/W** button to start copying.



DVD-RW COPY

Save the recorded data on **DVD-R/W** Media.

Click the **DVD-R/W** button to start copying.

- As soon as one of the above buttons is clicked , copying will start along with displaying the icon as shown in [Fig.6-45].

The following icon indicates that copying is in process.



[Fig.6-45 Copying Icon]

7

SETUP

CONTENTS

7-1. SETUP	73
7-2. SYSTEM	74
7-2.1. TIME / DATE	75
7-2.2. SYSTEM CONFIG	77
7-2.2.1. FACTORY DEFAULT	77
7-2.2.2. LOAD CONFIG / BACKUP CONFIG	78
7-2.3. PASSWORD	81
7-2.4. IR REMOTE ID	82
7-2.6. SYSTEM INFO	83
7-3. DISK MANAGER	84
7-3.1. HDD WRITE FAIL	85
7-3.2. HDD OVERWRITE	85
7-3.3. FORMAT	85

CONTENTS

7-4. CAMERA	87
7-4.1. CAMERA ON/OFF	88
7-4.2. CAMERA NAME (CAMERA TITLE)	88
7-4.3. BUZZER	89
7-4.4. RELAY	89
7-4.5. PAN/TILT SETTINGS	90
7-4.6 DISPLAY	94
7-4.7 SEQUENCING DWELL TIME	94
7-5. AUDIO	95
7-5.1. AUDIO RECORDING ON/OFF	96
7-5.2. MICROPHONE VOLUME	96
7-6. RECORD	97
7-6.1. RECORD ICON DISPLAY	97
7-6.2. ALL MANUAL / TIMER RECORDING BUTTON	98
7-6.3. ALL MOTION ON / OFF, SENSITIVITY AND VELOCITY SETTING	99
7-6.4. ALL SENSORS ON / OFF	100
7-6.5. SIZE (RECORDING RESOLUTION)	100
7-6.6. RECORDING SPEED	101
7-6.7. RECORDING QUALITY	102
7-6.8. RECORDING MODE	103
7-6.8.1. MANUAL RECORDING	103
7-6.8.2. MANUAL EVENT RECORDING	103
7-6.8.3. TIMER RECORDING (SCHEDULE RECORDING)	103
7-6.8.4. TIMER EVENT RECORDING	103
7-6.9. RECORDING BY MOTION DETECTION	104
7-6.10. RECORDING BY SENSOR (PIR SENSOR)	112

CONTENTS

7-7. NETWORK	115
7-7.1. IP MODE	115
7-7.2. GATEWAY, SUBNET, IP ADDRESS	116
7-7.3. PORT	117
7-7.3.1 PORT FORWARDING.....	117
7-7.4. MAC ID	118
7-7.5. MNS (MAC NAME SERVER)	118
7-7.6. DDNS (DYNAMIC DOMAIN NAME SYSTEM).....	120
7-7.7. HOW TO SETUP AND USE THE DDNS	121
7-7.7.1. ROUTER.	121
7-7.7.2. REGISTRATION TO THE DDNS SERVER.....	122
7-8. VIDEO ENHANCE	123
7-8.1. VIDEO ENHANCEMENT ON EACH CAMERA.....	124
7-8.2. VIDEO ENHANCEMENT ON VGA OUTPUT	125

7-1. SETUP



It is possible to set up the menus in the LIVE mode and partly in the RECORD mode.

- Click the “SETUP” button on the MENU bar and then the SETUP menu will be displayed.
- Click the  “EXIT” button to return to the previous mode.

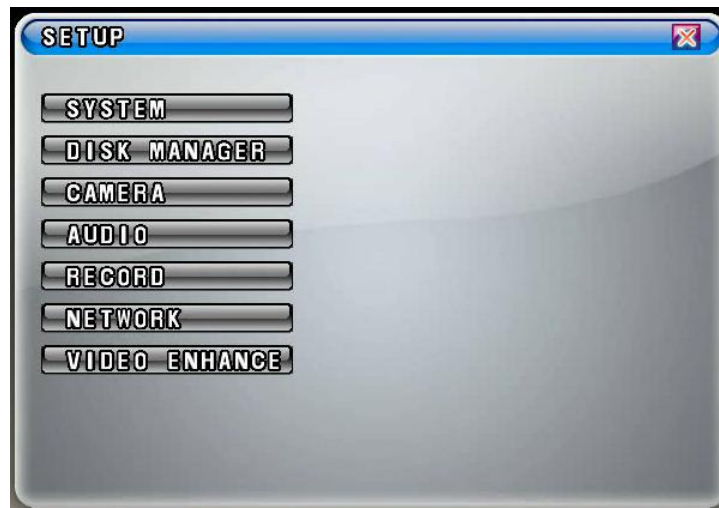

[Fig.7-2 SETUP menu]

7-2. SYSTEM

- Click the “SYSTEM” button in the SETUP menu, and then the SYSTEM menu shown in [Fig.7-3] will be displayed.
- Click the  “EXIT” button to return to the SETUP menu.

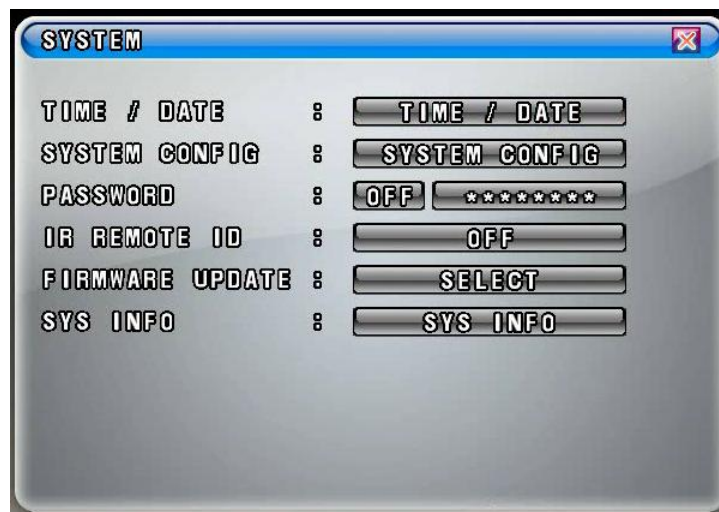

[Fig.7-3 SYSTEM menu]

7-2.1. TIME / DATE

- Click the “TIME/DATE” button in the SYSTEM menu, and then the TIME/DATE menu will be displayed (See Fig.7-4).
- Click the  “EXIT” button to return to the SYSTEM menu.



[Fig.7-4 TIME / DATE menu]

- TIME FORMAT
Click the mouse on the TIME FORMAT button to change and then select 24 HOUR or 12 HOUR by clicking the mouse.



[Fig.7-5 Time Format button]

- TIME Settings
Select the values (AM or PM and hour/minute/second) by clicking the mouse, change the values with the mouse's wheel and click the mouse again on the changed values to complete.

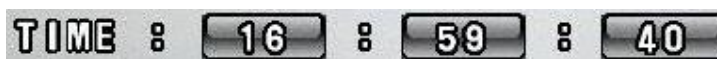

[Fig.7-6 Time Setting]

▫ DATE FORMAT

There are three formats to display the time and date as follow.

- MM / DD / YYYY: For U.S.A.
- YYYY / MM / DD: For Asian countries.
- DD / MM / YYYY: For European countries.

Click the mouse on the DATE FORMAT button to change, and then select a DATE FORMAT among YYYY/MM/DD, DD/MM/YYYY and MM/DD/YYYY.



[Fig. 7-7 Date Format button]

▫ DATE Settings

Select the month, date and year by clicking the mouse, change the values with the mouse's wheel and click the mouse again on the changed values to complete.



[Fig.7-8 Date Settings button]

▫ DISPLAY

It enables you to display the time and date on the Live screen.

Click the DISPLAY button to set display on or off.

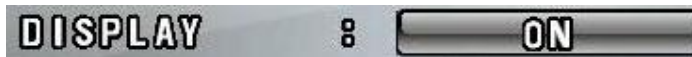

[Fig. 7-9 Display button]



Note: Setting the new time will cause loss of recording data. After setting the time, HDD should be formatted prior to start recording.

7-2.2. SYSTEM CONFIG

- Click the “SYSTEM CONFIG” button in the SYSTEM menu, and then the SYSTEM CONFIG menu will be displayed (See Fig.7-10).
- Click the  “EXIT” button to return to the SYSTEM menu.

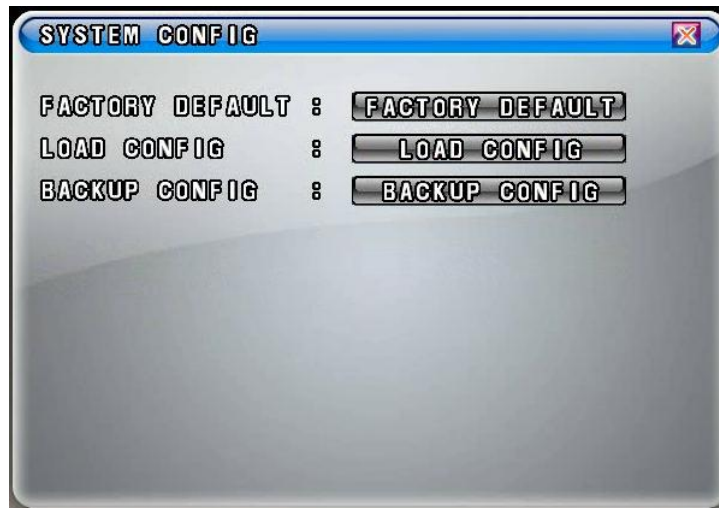

[Fig.7-10 SYSTEM CONFIG]

7-2.2.1. FACTORY DEFAULT

- Click the “FACTORY DEFAULT” button in the SYSTEM CONFIG menu, and you will be asked as shown in [Fig.7-12].



[Fig.7-11 Factory Default button]

- Click the “OK” button in [Fig.7-12] to reset to the Factory Default Values, and then the system will save the factory default values (settings).
Click the CANCEL button to cancel.

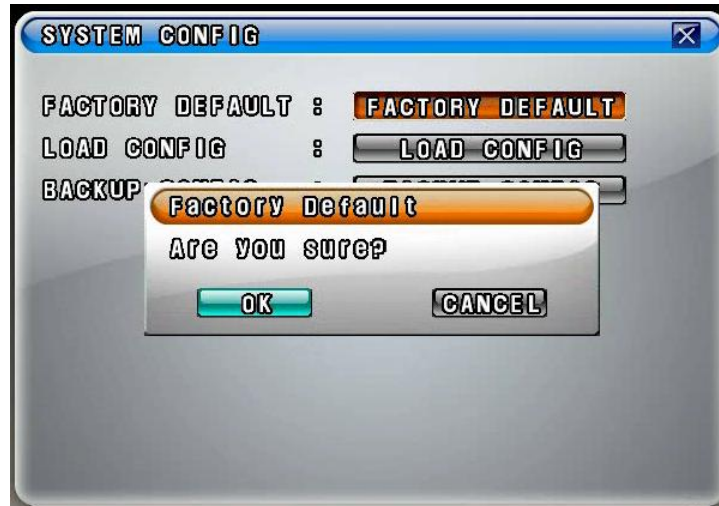

[Fig.7-12 Confirmation window of Factory Default]

7-2.2.2. LOAD CONFIG / BACKUP CONFIG

You can save up to four different settings in the BACKUP CONFIG and load the files in the LOAD CONFIG to change the settings to the system.

▫ LOAD CONFIG

This function is to load the changed settings to the system.

- Click the LOAD CONFIG button and then the LOAD CONFIG window will be displayed (See Fig.7-14).
- Select a backup file among FILE 1, FILE 2, FILE 3 and FILE 4 by clicking the mouse and click the LOAD button to change the settings (See Fig.7-14).
- Click the CANCEL button to cancel.



[Fig.7-13 LOAD CONFIG button]



[Fig.7-14 LOAD CONFIG window]

▫ BACKUP CONFIG

This function is to save the current settings to load the settings to the system. Save the current settings in the BACKUP CONFIG in order to load it to the system in the near future whenever you change the settings.

- Click the BACKUP CONFIG button and then the BACKUP CONFIG window will be displayed (See Fig.7-16).
- Select a blank file among FILE 1, FILE 2, FILE 3 and FILE 4 by clicking the mouse and click the BACKUP button to save the current setting (See Fig.7-16).
- To delete, click the mouse on the saved file and click the DELETE button.
- Click the CANCEL button to cancel.



[Fig.7-15 BACKUP CONFIG button]



[Fig.7-16 BACKUP CONFIG window]

7-2.3. PASSWORD

- ON/OFF

Select ON or OFF by clicking the mouse.

If the ON is selected, the password has to be entered to get into the SETUP mode, RECORD mode, COPY mode, REPLAY mode, and when trying to connect the network through the **COMBO VIEWER**.

- PASSWORD CHANGE

Click the password “*****” button and then the On Screen Keyboard will be displayed as shown in [Fig.7-17]. The factory default password is “11111111”.

Delete the existing password with the  button on the On Screen Keyboard. Enter the new password by using the On Screen Keyboard and click the OK button to save.

The password should be 8 digits.

If you executed the factory default setting, the existing password will be changed to “11111111”.



[Fig.7-17 PASSWORD KEYBOARD window]



Note: Don't forget the password.

7-2.4. IR REMOTE ID

Up to 16 DVR systems can be controlled by only one remote controller we provided, but IDs should be assigned on each of the systems. You don't have to assign any ID on the single unit and you can control the system with the provided remote controller without IR REMOTE ID, which is in the OFF mode (Skip this section).

- Click the IR REMOTE ID button and select one among OFF, 1 through 16 to assign an ID for the system by clicking the mouse.



[Fig.7-18 IR REMOTE ID button]

- When an IR Remote ID is assigned In the SYSTEM menu, press the “ID” button and the same channel button on the remote controller as an assigned ID in the SYSTEM menu to match the IDs between the system and the remote controller. And then press the “ID” button one more time for setting an ID.

When the “ID” button and the channel button are pressed on the remote controller,

- if the channel button is identical to the assigned ID, the Detect IR ID as shown in Fig.7-19 will be displayed along with the IR ID number.
- if not, the IR ID Denied as shown in Fig.7-20 will be displayed along with the denied IR ID number.



Fig.7-19 DETECT IR ID Message



Fig.7-20 IR ID DENIED Message

7-2.5. FIRMWARE UPDATE

There are two ways to update the firmware through **USB memory** and the **COMBO VIEWER** (GUI). We recommend users to update the firmware only in the LIVE mode.

▫ **By USB memory**

- Format the USB with your computer and save the firmware file on it (not including folder).
- Plug it on the USB port on the system.
- Click the mouse on the SELECT button in the SYSTEM menu and the FIRMWARE LISTS will be displayed.
- Click on the list, and then you will be asked, OK or CANCEL.
- Click the OK button to update the firmware and the system will automatically start rebooting.
- Click the CANCEL button to cancel.

▫ **COMBO VIEWER (GUI)**

Refer to section 8-4.1 ④ Firmware Update on [page134](#).

7-2.6. SYSTEM INFO

- Click the “SYSTEM INFO” button in the SYSTEM menu and then the SYSTEM INFO that contains the system version and the last updated date will be displayed.
- Click the  (EXIT) button to return to the SETUP menu.

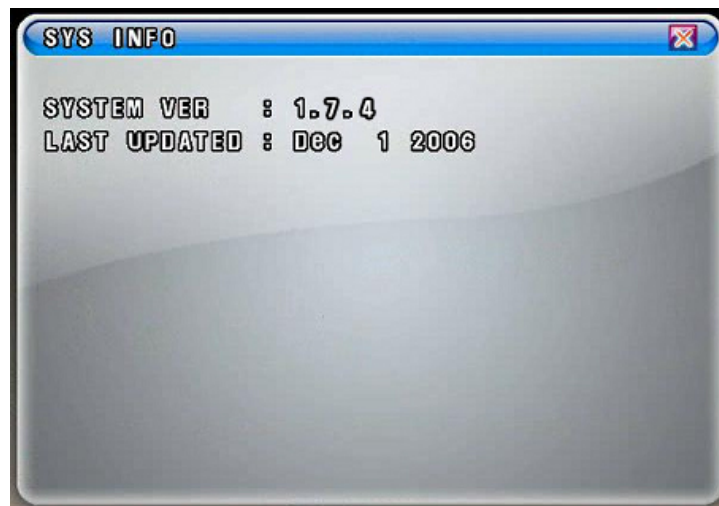

[Fig.7-21 SYSTEM INFORMATION window]

7-3. DISK MANAGER

- Click the “DISK MANAGER” button in the SETUP menu and then the DISK MANAGER window will be displayed (See Fig.7-22).
- A DVD R/W(USB) and 1 Hard Disk Drives can be installed, and all information in regards to the drives will be automatically displayed on the DISK MANAGER window.
- Click the  (EXIT) button to return to the SETUP menu.



[Fig. 7-22 DISK MANAGER window]

7-3.1. HDD WRITE FAIL

If the HDD is in full and the OVERWRITE is turned OFF in the recording mode, the system will activate the relay output (See section 5-4.3) for a siren or other device.

- Click the HDD WRITE FAIL button in the DISK MANAGER window and select “RELAY OUT” or “DISABLE”.



[Fig. 7-23 HDD Write Fail button]

7-3.2. HDD OVERWRITE

- Click the mouse on the OVERWRITE button to select the ON or the OFF. If the ON is selected, the system continues recording by overwriting start from the first index of the recorded file even though the space of HDD is in full. If the OFF is selected, the system will stop recording when the space of HDD is in full.



[Fig. 7-24 Overwrite button]

7-3.3. Format

When you install the new Hard Disk Drives (HDD), it should be formatted before recording. Formatting is possible only when the system is in the LIVE mode.

- Click the “HDD or USB” button to format and then the HDD or USB FORMAT message box will be displayed (See Fig. 7-25).
- Click the “OK” button, and you can see the formatting process of the HDD.
- Click the “CANCEL” button to return to the Disk Manager.

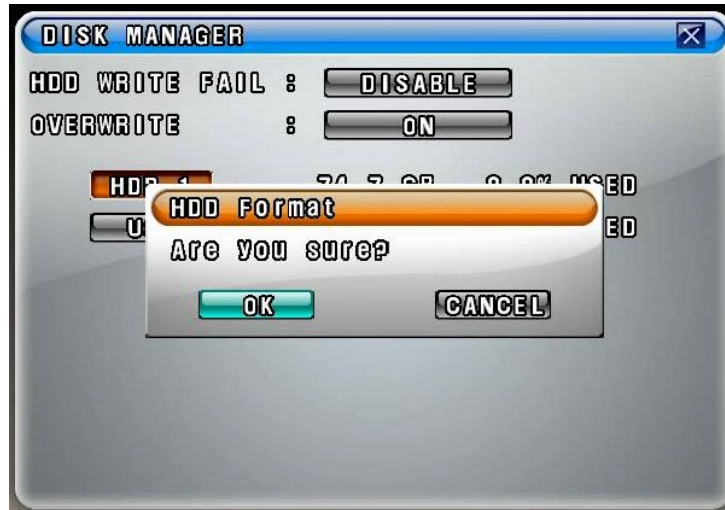

[Fig.7-25 HDD FORMAT window]

7-4. CAMERA

- Click the “CAMERA” button in the SETUP menu and then the CAMERA menu will be displayed (See Fig.7-26). To change the settings in the CAMERA menu, stop recording by clicking the RECORD icon on the MENU BAR.

It is possible only in the LIVE mode.

- Click the  (EXIT) button to return to the SETUP menu.



[Fig.7-26 CAMERA menu]



7-4.1. Camera ON/OFF

- Click on each of the channels to select the “O” or “X” in the CAMERA menu. If the “O” is selected, the corresponding video channels (CAM 01 through CAM 08) will be displayed on the screen. If the “X” is selected, the corresponding video channels (CAM 01 through CAM 08) won’t be displayed.



[Fig.7-27 Camera ON/OFF button]

7-4.2. Camera Name (Camera Title)

- Click the NAME (Camera Title) button in the CAMERA menu and then the On Screen Keyboard will be displayed as shown in [Fig.7-28].
- Delete the existing NAME (Camera Title) with the  button on the On Screen Keyboard.
- Enter the new NAME up to 8 characters by using the On Screen Keyboard and click on the OK button to save. Click on the CANCEL button to cancel.
- Click the  (EXIT) button to return to the SETUP menu.

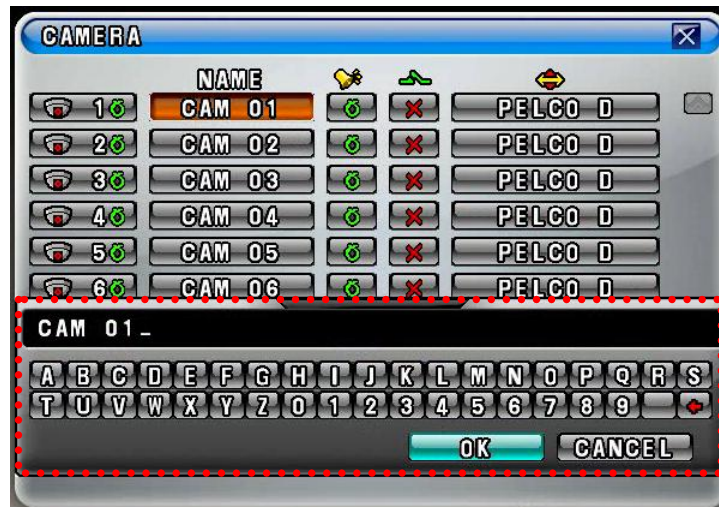

[Fig.7-28 Camera Name Setting Keyboard window]

7-4.3. Buzzer

In order to alert users, the Buzzer will sound at that time video signal lost.

- Click on each of the channels you wish to turn the buzzer “ON” or “OFF”. If the “O” is selected, the buzzer will sound when video signal lost and if the “X” is selected, the buzzer won’t sound.

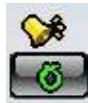

[Fig.7-29 Buzzer button]

7-4.4. Relay

The system will automatically activate a siren or other device through the Relay Output on the rear panel when video signal lost.

- Click on each of the channels you wish to select the Relay Output “O” or “X”. If the “O” is selected, the Relay Output will be turned on to activate a siren or other device when video signal lost.



[Fig.7-30 Relay button]



[Fig.7-31 Relay button]

7-4.5. Pan/Tilt Settings

- Click the PAN/TILT button on the corresponding channels in the CAMERA menu, then the PAN/TILT window will be displayed as shown in [Fig.7-33].
- Click the  (EXIT) button to return to the CAMERA menu.



[Fig.7-32 PAN/TILT button]



[Fig.7-33 PAN/TILT window]

- PTZ ID
 - Click the PTZ ID button in the PAN/TILT window, then On Screen Keyboard will show up.
 - Delete the current ID with the  button and choose a number among “0” to “255” by using the On Screen Keyboard, and then click **OK** button to save it. The ID should be identical to one PTZ camera has.
 - Click the “**CANCEL**” button to return to the previous value.



Fig. 7-33-1 PTZ ID

▫ Pan/Tilt Vendor select

Click the “PAN/TILT & REMOTE” button in the PAN/TILT window, then the vendor lists will show up. Select a vendor on the vendor lists by clicking the mouse.



[Fig.7-34 PAN/TILT & REMOTE]



[Fig.7-35 PAN/TILT Vendor lists]

▫ Model

Click the “MODEL” button in the PAN/TILT window and select the model on the pop-up lists by clicking the mouse.



[Fig.7-36 MODEL button]

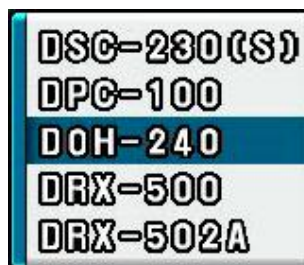

[Fig.7-37 PAN/TILT Model pop-up window]

▫ Baud rate

Click the “BAUD RATE” button in the PAN/TILT window and choose a value among 1200bps, 2400bps, 4800bps, 9600bps, 19200bps, 38400bps, 57600bps and 115200bps on the Baud Rate pop-up window by clicking the mouse.



[Fig.7-38 BAUDRATE button]



[Fig.7-39 Baud Rate pop-up window]

▫ Data Bits

Click the “DATA BITS” button in the PAN/TILT window and choose a value among 5, 6, 7 and 8 on the Data Bits pop-up window by clicking the mouse.



[Fig.7-40 DATA BITS button]



[Fig.7-41 Data Bits pop-up window]

▫ Stop Bits

Click the “STOP BITS” button in the PAN/TILT window and select 1 or 2 on the Stop Bits pop-up window by clicking the mouse.



[Fig.7-42 STOP BITS button]



[Fig.7-43 Stop Bits pop-up window]

▫ Parity Bit

Click the “PARITY BITS” button in the PAN/TILT window and choose a value among NONE, ODD, EVEN, STICK and ZERO on the Parity Bits pop-up window by clicking the mouse.



[Fig.7-44 PARITY BIT button]



[Fig.7-45 Parity Bit pop-up window]

7-4.6 Display

- Click the DISPLAY button in the CAMERA menu and select the ON or OFF. If the “ON” is selected, the camera name (camera title) in the LIVE mode will be displayed on the screen. If the “OFF” is selected, the camera name (camera title) in the LIVE mode won't be displayed.



[Fig.7-46 Display ON/OFF button]

7-4.7 Sequencing dwell time

- Click the “SEQUENCING DWELL” button in the CAMERA menu and choose a value among 1, 2, 3, 4 and 5seconds on the dwell time pop-up window by clicking the mouse.



[Fig.7-47 Sequencing Dwell Time button]



[Fig.7-48 Sequencing Dwell Time pop-up window]

7-5. AUDIO

- Click on the AUDIO button in the SETUP menu and then the AUDIO menu will be displayed on the screen.
- Click the  (EXIT) button to return to the SETUP menu.



[Fig.7-49 AUDIO menu]

7-5.1. Audio Recording ON/OFF

- Click the REC (audio recording) button in the AUDIO menu and select the “O” or “X” by clicking the mouse. If the “O” is selected, the corresponding channel’s audio will be recording along with video signal. If the “X” is selected, the corresponding channel’s audio won’t be recording but video signal will be recording continuously.



[Fig.7-50 Record ON/OFF button]

7-5.2. Microphone Volume

- Adjust audio volume by clicking the ▲ or ▼ button.



[Fig.7-51 Microphone Volume control button]

7-6. RECORD

- Click the "RECORD" button in the SETUP menu and then the RECORD menu will be displayed as shown in [Fig.7-52].
- Click the  (EXIT) button to return to the SETUP menu.



[Fig.7-52 RECORD menu]

7-6.1. Record ICON Display

- The Recording Icons depends on recording modes are displayed in the upper left corner of the screen.
- To turn the Recording Icon OFF, click the DISPLAY ON in the RECORD menu and then it will be turned OFF. You can select the value **ON** or **OFF** by repeatedly clicking the mouse.



[Fig.7-53 Record ICON Display button]

7-6.2. All Manual / Timer recording button

- Click the **All Manual / Timer** recording button in the RECORD menu, then the **All Manual / Timer** recording button will be displayed as shown in [Fig.7-55].
- Select the Manual Recording button or Timer Recording button for all the channels by clicking the mouse in [Fig.7-55].
- See section 6-8.1 through 6-8.5 on page 52 through 55 for more information related to recording.







[Fig.7-54 All Manual / Timer button]



[Fig. 7-55 All Manual / Timer pop-up window]

7-6.3. All Motion ON / OFF, Sensitivity Setting

- Click the  button in the RECORD menu, then the ALL MOTION setup pop-up window will be displayed as shown in [Fig.7-57].
- By clicking the mouse, select the **ALL  ENABLE** on the pop-up window (See Fig.7-57) to enable the system to start recording by motion detection for all the channels.
- By clicking the mouse, select the **ALL  DISABLE** on the pop-up window (See Fig.7-57) to disable the system to start recording by motion detection for all the channels.
- By clicking the mouse, select the ** SENSITIVITY HIGH** on the pop-up window (See Fig.7-57) and choose one of the sensitivity among **LOW, 1, 2, 3** and **HIGH** for all the channels with the mouse's wheel, and then click it to save.
- See section 6-8.1 through 6-8.5 on page 52 through 55 for more information related to recording.



[Fig.7-56 All Motion Setup button]





[Fig.7-57 All Motion Setup pop-up window]



[Fig.7-58 All Motion Sensitivity setup button]

7-6.4. All Sensors ON / OFF

- Click the  button in the RECORD menu, then the ALL SENSOR setup pop-up window will be displayed as shown in [Fig.7-60].
- By clicking the mouse, select the **ALL**  **ENABLE** on the pop-up window (See Fig.7-60) to enable the system to start recording by Sensor (Passive Infrared Sensor) for all the channels.
- By clicking the mouse, select the **ALL**  **DISABLE** on the pop-up window (See Fig.7-60) to disable the system to start recording by Sensor (Passive Infrared Sensor) for all the channels.



[Fig.7-59 All Sensor button]



[Fig.7-60 All Sensor Setup pop-up window]

7-6.5. Size (Recording Resolution)

Select the size of the screen for recording. The larger the size selected, the better display quality is but the larger the data becomes.

- Click the SIZE (Recording Resolution) button on each of the channels in the RECORD menu, then the SIZE (Recording Resolution) pop-up window will be displayed as shown in [Fig.7-62].
- Select one of the Resolution among **D1** (720x480), **HALF D1** (720x240) and **CIF** (360x240) on the pop-up window by clicking the mouse.



[Fig.7-61 Record Size button]



[Fig.7-62 Record Size pop-up window]

7-6.6. Recording Speed

- Click the F/S (Frames Per Seconds: Recording Speed) button on each of the channels in the RECORD menu, then the Recording Speed pop-up window will be displayed as shown in [Fig.7-64].
- Select one of the Recording Speed among AUTO, 30, 15, 10, 7, 5, 3, 2, 1 and OFF on the pop-up window by clicking the mouse.
- If the AUTO is selected on all the channels, the Recording Speed on all the channels should be the same. If the OFF is selected, the corresponding channel won't be recording.



[Fig.7-63 Record Speed button]

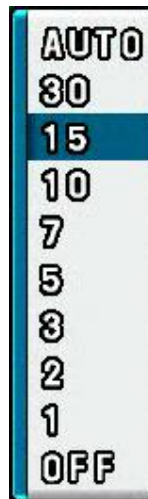

[Fig.7-64 Record Speed pop-up window]

NTSC	30
	15
	10
	7
	5
	3
	2
	1
	OFF

PAL	25
	12
	8
	6
	5
	3
	2
	1
	OFF

[Fig.7-65 Recording Speed for each channel]

7-6.7. Recording Quality

- Click the QUALITY button on each of the channels in the RECORD menu, then the QUALITY pop-up window will be displayed as shown in [Fig.7-67].
- Select one of the Recording Quality among LOW, NORMAL, HIGH and BEST on the pop-up window by clicking the mouse.



[Fig.7-66 Record Quality button]



[Fig.7-67 Record Quality pop-up window]

7-6.8. Recording Mode

The factory default setting for Recording is the Manual Recording (or called Continuous Recording), which keeps recording continuously if the OVERWRITE is set ON in the DISK MANAGE menu. This Manual Recording mode is one of the most popular Recording modes for users, as well as one of the most convenient Recording modes to use.

Users can select one of the following Recording modes depends on their application.

7-6.8.1. Manual Recording

See section 6-8.1 [on page 52](#).

7-6.8.2. Manual Event Recording

See section 6-8.2 [on page 52](#).

7-6.8.3. Timer Recording (Schedule Recording)



See section 6-8.3 [on page 53](#).

7-6.8.4. Timer Event Recording

See section 6-8.4 [on page 54](#).

7-6.9. Recording by Motion Detection

When the menu of motion is properly set up (See section 7-6.3 for all the channels and this section for each of the channels) and detected motion of objects, the system begins recording automatically. The recording icon on the MENU bar should be selected in this recording mode. If not, it won't be recording.

- Click the mouse on the  button for each of the channels in the RECORD menu, then the MOTION menu will be displayed on the screen as shown in [Fig.7-68].
- Click the  (EXIT) button to return to the RECORD menu.

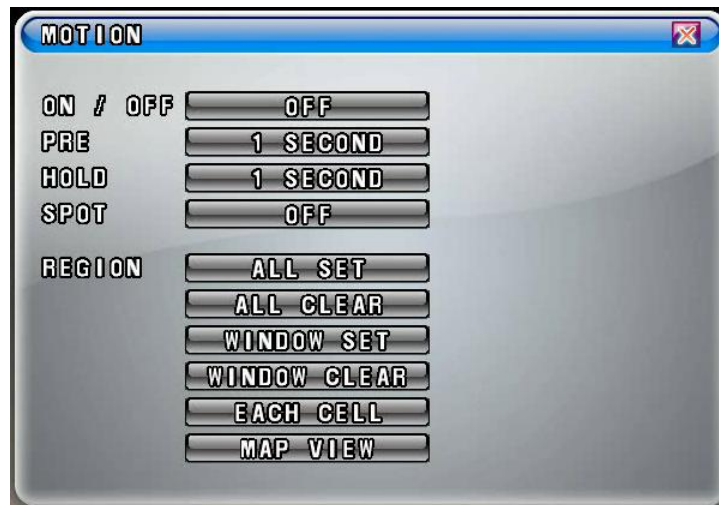

[Fig.7-68 MOTION menu]

- ON/OFF
The system will start recording when MOTION is detected and the ON is selected in the MOTION menu by clicking the mouse. If the OFF is selected, the system won't be recording.



[Fig.7-69 MOTION ON/OFF button]

▫ Pre-Alarm Time Setup

Allows you to record a section of video just prior to Motion or Sensor activation. Click the mouse on the PRE in the MOTION menu and choose one of the values among 0, 1, 2, 3, 4 and 5 seconds with the mouse's wheel, and then click it to save.



[Fig.7-70 Pre-Record Time setup button]



[Fig.7-71 Pre-Alarm Time Setup pop-up window]

▫ Motion Hold Time Setup

The system continues recording for the MOTION HOLD TIME and finishes the recording. Click the mouse on the HOLD in the MOTION menu and choose one of the values among 1 through 30 seconds with the mouse's wheel, and then click it to save.



[Fig. 7-72 Hold-Record Time Setup button]

▫ Spot Setup

If the “ON” is selected by clicking the mouse on the SPOT button in the MOTION menu, a full screen will display when a motion is detected. If the “OFF” is selected, the full screen won’t be displayed even though motion of objects is detected.



[Fig.7-73 Spot Setup button]

▫ Region

The Motion Detection Area displays in blue on the screen, and it turns to yellow color when the motion is detected. The white color on the screen represents none of detection area. There are three kinds of REGION settings as follows.

By All Set

Click the ALL SET button in the MOTION menu on each of the cameras and then the Motion Detection Area displays in blue on the screen as shown in [Fig.7-75]. Right-click on the blue screen to return to the MOTION menu. The factory default value is the ALL SET.



[Fig.7-74 ALL SET button]

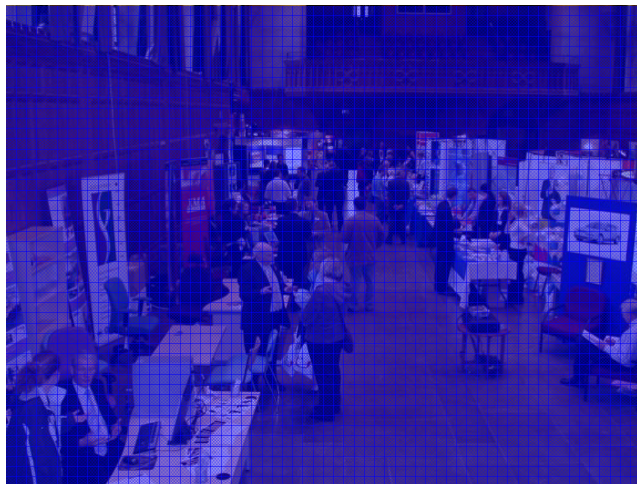

[Fig.7-75 All Set screen]

- All Clear

Click the ALL CLEAR button in the MOTION menu in order to clear the Motion Detection Area, and then the window turns to white color as shown in [Fig.7-77]. Right-click on the current window to return to the MOTION menu.



[Fig.7-76 ALL CLEAR button]

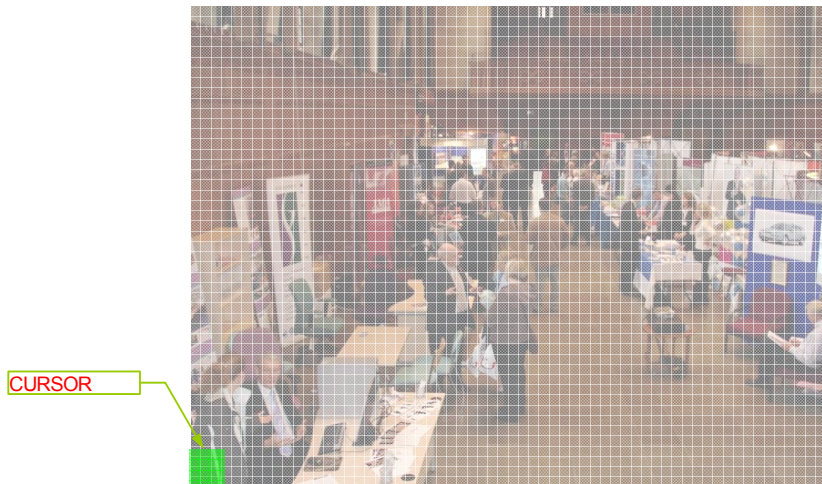

[Fig.7-77 All Cleared screen]

By Window Set

Click the WINDOW SET button in the MOTION menu on each of the cameras and click one of cells (1,320 cells in total) for the starting point of the area which you would like to designate, and then click the other one of cells for the ending point of area until the motion detection area is the size you want it to be. The multiple motion areas can be set on each of cameras.

The motion detection by Window Set will be made on the designated area only.

Right-click on the current window to return to the MOTION menu.



[Fig.7-78 WINDOW SET button]

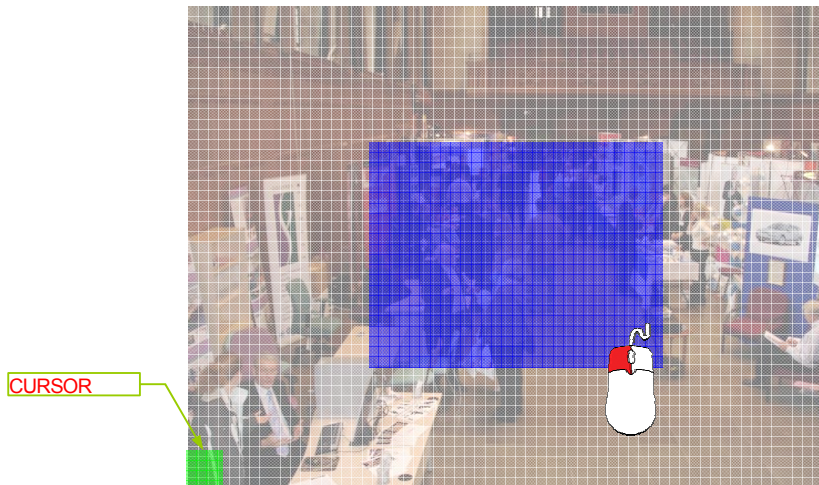

[Fig.7-79 Window Set screen]

- Window Clear

Click the WINDOW CLEAR button in the MOTION menu in order to clear the Motion Detection Area, and then the motion detection area you have created will be displayed. Click the starting point and the ending point as much as you wish to clear or it can be cleared by ALL CLEAR as described above (See ALL CLEAR). Right-click on the current window to return to the MOTION menu.



[Fig.7-80 WINDOW CLEAR button]

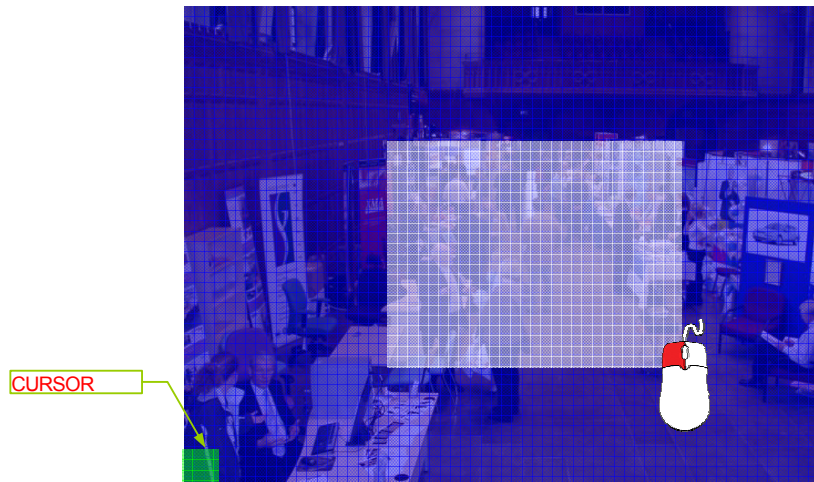

[Fig.7-81 Window Clear setup screen]

By Each Cell

Click the EACH CELL button in the MOTION menu on each of the cameras and click the mouse on each of the cells as much as you would like to designate the Motion Detection Area.

To clear, click the designated cells.

Right-click on the current window to return to the MOTION menu.



[Fig.7-82 EACH CELL button]

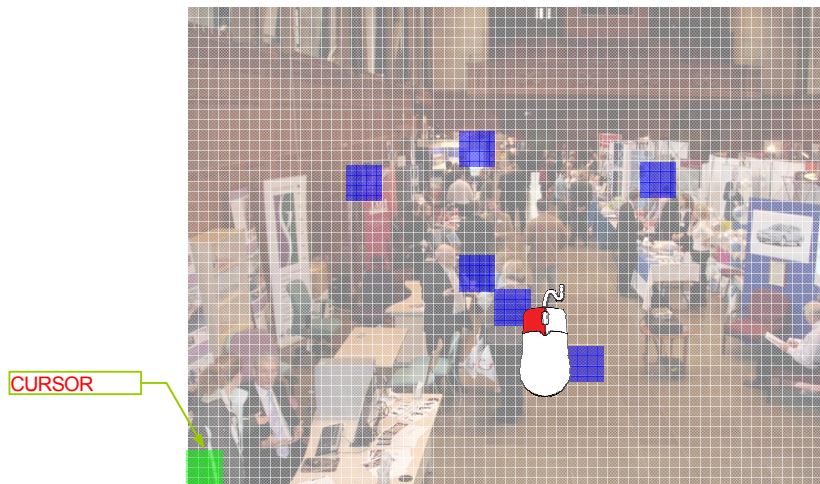

[Fig.7-83 Each Cell Setup screen]

▫ Map View

Click the MAP VIEW button in the MOTION menu to view the current settings for Motion detection area.

Right-click on the current window to return to the MOTION menu.



[Fig.7-84 M

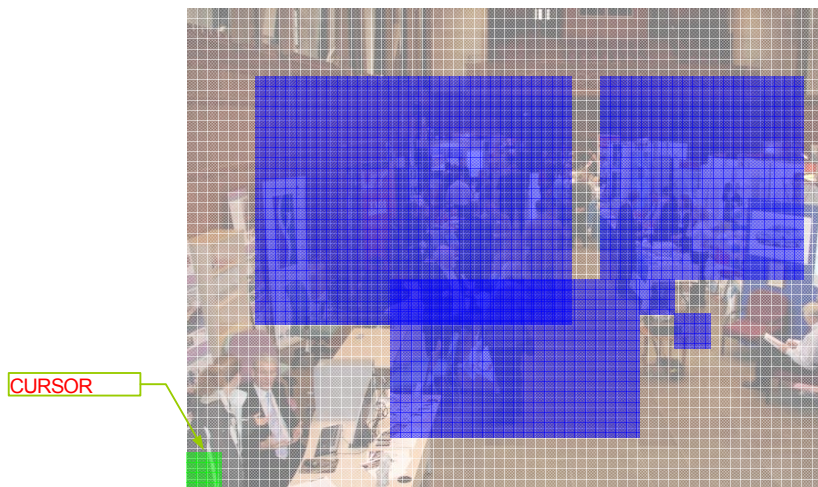



[Fig.7-85 Map View screen]



Note : Please pay attention to the following directions in order to use the Motion Detection function properly:

- Adjust the sensitivity level and motion area to fit your requirements.
- Do not use this function in an area where many objects are continuously moving. In case of this, change the recording mode to the Continuous (Manual) Recording mode.
- Use a high quality camera that does not generate video static or “noise”. The motion detection algorithm recognizes this “noise” as a motion and records the noise even if there was no actual motion.
- Do not point the camera toward a strong and changing lighting source; it can activate false motion detection.

7-6.10. Recording by Sensor (PIR Sensor)

- Click the mouse on the  button for each of the channels in the RECORD menu and then the SENSOR menu will be displayed on the screen as shown in [Fig.7-86].
- Click the  (EXIT) button to return to the RECORD menu.



[Fig.7-86 SENSOR window]

- ON/OFF
The system will start recording when an Alarm is detected and the ON is selected in the SENSOR menu by clicking the mouse. If the OFF is selected, the system won't be recording.
If you select "OK", it will be recorded when only sensor is activated.



[Fig.7-87 SENSOR ON/OFF button]

▫ Pre-Alarm Time Setup

Allows you to record a section of video just prior to Sensor activation. Click the mouse on the PRE in the SENSOR menu and choose one of the values among 0, 1, 2, 3, 4 and 5 seconds with the mouse's wheel, and then click it to save.



[Fig.7-88 Pre-Alarm Time Setup button]



[Fig.7-89 Pre-Alarm Time Setup pop-up window]

▫ Alarm Hold Time Setup

The system continues recording for the Alarm HOLD TIME and finishes the recording. Click the mouse on the HOLD in the SENSOR menu and choose one of the values among 1 through 30 seconds with the mouse's wheel, and then click it to save.



[Fig.7-90 Alarm Hold Time Setup button]

▫ Spot Setup

If the "ON" is selected by clicking the mouse on the SPOT button in the SENSOR menu, a full screen will display when a motion is detected. If the "OFF" is selected, the full screen won't be displayed even though an alarm is detected.



[Fig.7-91 Spot Setup button]

7-7. NETWORK

- Click the “NETWORK” button in the SETUP menu and then the NETWORK menu will be displayed on the screen as shown in [Fig.7-92].
- Click the  (EXIT) button to return to the SETUP menu.



[Fig.7-92 NETWORK menu]

7-7.1. IP Mode

When the system uses the same IP address every time it connects to the network, it is known as a static IP address. If the system's IP address changes frequently, it is called a dynamic IP address. Check with your Internet Service Provider to determine which IP address was given. This manual will guide users through the setup process for both types.

DYNAMIC IP: automatically receives IP address from the router or gateway. It doesn't need to enter the GATEWAY ADDRESS, SUBNET MASK and IP ADDRESS.

STATIC IP: requires you to enter the GATEWAY ADDRESS, SUBNET MASK and IP ADDRESS.

- Click the “IP MODE” button in the NETWORK menu and then the IP mode pop-up window will be displayed on the screen (See Fig.7-94).
- Select the STATIC or DYNAMIC by clicking the mouse depends on your networking.



[Fig.7-93 IP Mode button]



[Fig.7-94 IP Mode pop-up window]

7-7.2. GATEWAY, SUBNET, IP ADDRESS

- Click the GATEWAY / SUBNET / IP ADDRESS button in the STATIC IP MODE and then the On Screen Keyboard will appear.
- Delete the current values with the  button and enter the address numbers by using On Screen Keyboard, and then click **OK** button to set with new address.
- Click the **CANCEL** button to return to the original values.



[Fig.7-95 Address Setup window]



[Fig.7-96 On Screen Keyboard]

7-7.3. Port

- PORT is the TCP address of the program, which is used to connect to the network viewer. It can be set from 1 to 65535 values.
- Click the **PORT** button and then the On Screen Keyboard will show up.
- Delete the current port number with the  button and enter the new port number by using On Screen Keyboard, and then click “OK” button to set with new port number.
- Click the “**CANCEL**” button to return to the default value.



[Fig.7-97 Port Setup window]



[Fig.7-98 Port Setup Keyboard window]

7-7.3.1 Port Forwarding

- Router has to be set as a virtual server (or port forwarding) in order to utilize the MNS (Mac Name Server) or the DDNS service to use Internet Explorer (See section 8-3) on this product.
- Do not use the public port numbers.

7-7.4. MAC ID

- MAC ID is connecting address for Ethernet, every unit has 12 digit addresses (HEX 6 byte).
MAC ID was already assigned with the factory default value. User can not change it.

7-7.5. MNS (MAC NAME SERVER)

As a sort of DDNS, two servers in our company (CLOVER) are being operated so that our client can access DVR with a Dynamic IP address. If one of servers stops operating, the other one will automatically start working.

- Click the **MNS** button in the NETWORK menu with a mouse or buttons on the remote controller and then the **MNS** window will show up as below (See Fig.7-99).
- To return to the **NETWORK** window, click the  (EXIT) button in the **MNS** menu.

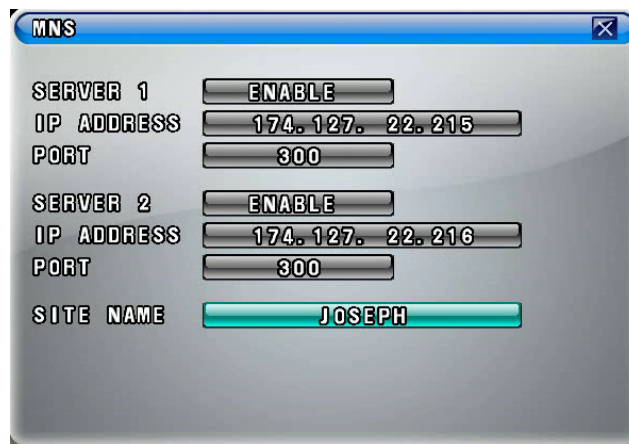

[Fig.7-99 MNS window]

- DISABLE / ENABLE

You can select the **DISABLE** or **ENABLE** button on both SERVER 1 and SERVER 2 by clicking the mouse or pressing the **ENTER** button on the remote controller.

“**DISABLE**”: MSN (MAC NAME SERVER) is not working.

“**ENABLE**”: MSN (MAC NAME SERVER) is working.



[Fig.7-100 DISABLE/ENABLE button]

▫ IP ADDRESS / PORT

DO NOT CHANGE THE IP ADDRESS AND PORT NUMBER IN THE MNS MENU IF YOU DON'T HAVE ANY SPECIAL SERVER TO ACCESS YOUR DVR WITH A DYNAMIC IP ADDRESS. IF YOU CHANGE THEM, YOU CAN'T NOT ONLY USE OUR MNS (MAC NAME SERVER), BUT ALSO YOUR NETWORKING WILL BE DISCONNECTED.

▫ SITE NAME

The SITE NAME is one of the important factors to access the DVR through MNS (MAC NAME SERVER) with the COMBO VIEWER (GUI).

You can't access the DVR system if the SITE NAME you entered already exists on the network. Try to connect the system with other SITE NAME.

- Click the SITE NAME button, the On Screen Keyboard will show up (See Fig.7-102).
- Delete the current SITE NAME with the  button and enter the new SITE NAME by using the On Screen Keyboard, and then click **OK** button to save it.
- Click the "**CANCEL**" button to return to the previous value.





[Fig.7-101 SITE NAME Setup button]



[Fig.7-102 SITE NAME Setup: On Screen Keyboard]

7-7.6. DDNS (DYNAMIC DOMAIN NAME SYSTEM)

- Select the DDNS button in the NETWORK menu by clicking the mouse or pressing the buttons on the remote controller. The DDNS menu will show up as shown in [Fig.7-103].
- To return to the NETWORK menu, Click the  (EXIT) button.
- If you were in the middle of entering values on the DDNS menu, you can't exit by clicking the mouse. Choose the SERVER button in the DDNS menu by clicking the mouse and select the DISABLE, and then click the  (EXIT) button.



[Fig.7-103 DDNS menu]

- SERVER
 - Choose the SERVER button in the DDNS menu by clicking the mouse or pressing the buttons on the remote controller and select the DYNDNS.ORG (or NO-IP.ORG) provided by www.dyndns.org (or www.no-ip.org) at no cost.



[Fig.7-104 SERVER button]

- HOST NAME
 - Click the HOST NAME in the DDNS menu and type the HOST NAME registered to the DDNS server such as DYNDNS.ORG and NO-IP.ORG by using the On Screen Keyboard.
 - After changing the values, click on the OK button.



[Fig.7-105 HOST NAME button]

- USER ID
 - Click the USER ID in the DDNS menu and type the USER ID registered to the DDNS server by using the On Screen Keyboard.
 - After changing the values, click on the OK button.



[Fig.7-106 USER ID button]

- PASSWORD
 - Click the PASSWORD in the DDNS menu and type the PASSWORD registered to the DDNS server by using the On Screen Keyboard.
 - After changing the values, click on the OK button.



[Fig.7-107 PASSWORD button]

7-7.7. HOW TO SETUP AND USE THE DDNS

7-7.7.1. Router.

It has to be set as a virtual server (or port forwarding) in order to utilize the DDNS. There are a lot of manufacturers on the market. Please read the provided manual thoroughly before setting or visit our website at www.cloverusa.com in regards to do it.

We, the manufacturer of DVR systems will not support the solution to your individual network issues.

** DDNS (Dynamic Domain Name System) is a method of keeping a domain name linked to a changing IP address. This is a useful feature since many computers do not use a static IP address.

7-7.7.2. Registration to the DDNS server

Visit at www.dyndns.org to register.

Registration to DYNDNS.ORG

1. Visit at www.dyndns.com.
2. Sign up for a new user name and a password: Click the Create Account on the upper right hand corner.
3. After signup new user, check your e-mail and confirm an e-mail from dyndns.com.
4. Go back to www.dyndns.com and log in with the ID and the Password.
5. After log in on dyndns.com front page, click on my services.
6. Click on the Add Host Service (Next to Host Level Service).
7. Click the Add Dynamic DNS Host on the Dynamic DNS.
8. The window to input Host Name will pop up, and select the dyndns.org or the dvr dns.org on the pop-up window.
9. To complete, click the Add Host button on the bottom.
10. After registration, go to the NETWORK menu on the DVR and enter the HOST NAME, USER ID and the PASSWORD you just registered in the DDNS menu (See section 7-7.6).

7-8. VIDEO ENHANCE

- Click the **VIDEO ENHANCE** button in the **SETUP** menu to enhance the picture quality (Contrast and Brightness) on each of channels. The **VIDEO ENHANCE** menu will show up (See Fig.7-108).
- To return to the SETUP menu, click the  (EXIT) button.

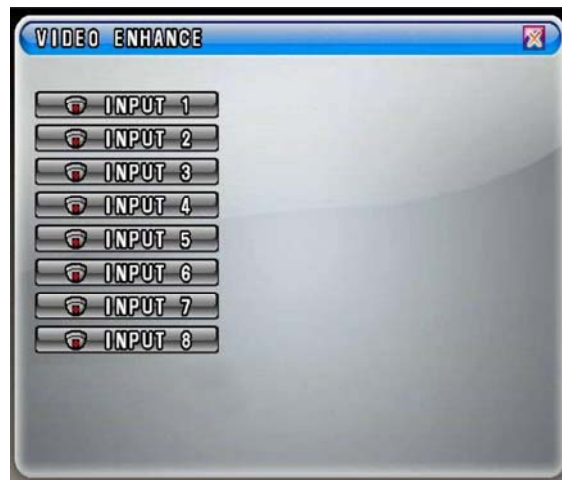

[Fig.7-108 VIDEO ENHANCE]

7-8.1. VIDEO ENHANCEMENT ON EACH CAMERA

- Click on an **INPUT** button in the **VIDEO ENHANCE** menu.
- The **CONTRAST** and **BRIGHTNESS** sliders will be displayed along with camera picture as shown in [Fig.7-109].
- Adjust Contrast and Brightness with the sliders by clicking the mouse.
- To return to the VIDEO ENHANCE menu, Click the  (EXIT) button.



[Fig.7-109 CAMERA INPUT]

7-8.2. VIDEO ENHANCEMENT ON VGA OUTPUT

It is possible to enhance VGA signals only with the MENU/ENTER key on the bottom of the system.

- To display the MENU, press the MENU/ENTER key to change the values. The changes should be made in about 15 seconds. After that, the MENU will be disappeared.
- Choose one of items among **Contrast**, **Brightness**, **Hue**, **Saturation** and **Sharpness** by using (+) or (-) key and press the MENU/ENTER key to change the values. The chosen item along with the Slider will be displayed on the bottom of the screen.
Change the values by using (+) or (-) key and press the MENU/ENTER key to save.
- **Color Tone**
Choose the **Color Tone** by using (+) or (-) key and choose one among **Normal**, **Warm** and **Cool** by pressing the MENU/ENTER key. Press the Exit key or choose other items by using (+) or (-) key to save the values. The default value is **Normal**.
- **Picture Format**
Choose the **Picture Format** by using (+) or (-) key and select between **16: 9** (Aspect ratio) and **4:3** by pressing the MENU/ENTER key. Press the Exit key or choose other items by using (+) or (-) key to save the values. The default value is **16: 9**.
- **Picture Mode**
Choose the **Picture Mode** by using (+) or (-) key and choose one among **User**, **Standard**, **Movie** and **Vivid** by pressing the MENU/ENTER key. Press the Exit key or choose other items by using (+) or (-) key to save the values. The default value is **Standard**.
- To exit, press the Exit key on the bottom of the system.

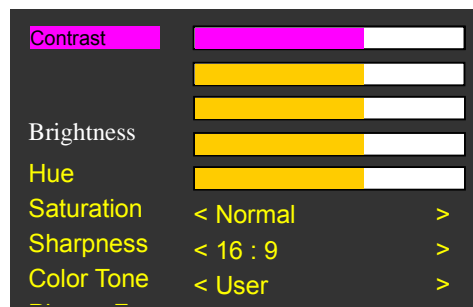

[Fig.7-110 VIDEO ENHANCE]

8

Remote Host Program

CONTENTS

8-1. REMOTE PROGRAM OVERVIEW	128
8-2. INSTALLING THE PROGRAM TO PC	129
8-3. INTERNET EXPLORER	130
8-4. REMOTE HOST	132
8-4.1. SETUP	133
8-4.2. CONNECTION	135
8-4.3. SWITCH THE NORMAL SCREEN TO FULL SCREEN	136
8-4.4. SPEAKER / MICROPHONE	137
8-4.5. COPY	138
8-5. PLAYER	140

8-1. Remote Program Overview

The Remote Host Program allows you to view live video, search archived video, control PTZ cameras and to set up the exact same menus as the DVR system does.

The DVR system can have up to 10 simultaneous Remote Connections. Each user can perform on the DVR system and will not affect the other users. The only exception to this is accessing Setup. Only one user is allowed to access Setup at any time.

In order to log in to the DVR system, users should be requested to enter the password if the password is already turned **ON** in the **SYSTEM** menu (Click **SETUP – SYSTEM**). This ensures that only authorized personnel are allowed to log in.

Remote system minimum requirements

- Microsoft Windows 2000, XP or VISTA Operating System
- Pentium-4 2.0GHz or higher
- 256MB System memory
- 1024 x 768 Display Resolution, 32Bit color
- Internet or LAN Connection
- TCP/IP installed
- Microsoft DirectX 9.0c

It is recommended to have DirectX 9.0c version in client PC. DirectX 9.0 is available for download from Microsoft homepage (www.microsoft.com/windows/directx).

8-2. Installing the Program to PC

Install the program into PC by using program CD (supplied) as follows.

How to install the program

1. Start the operating system (Windows 2000/XP/VISTA).
2. Insert the program CD into CD-ROM drive.
3. Open **My Computer**, and then select CD-ROM drive.
4. Double click **Setup.EXE**. The software installation will begin.
5. After the installation has been completed, the **COMBO VIEWER** icon will be created on your desktop screen as shown below.
6. Double click the **COMBO VIEWER** icon and the **COMBO VIEWER** screen appears.



[Fig.8-1 ComboViewer icon]

How to set Screen Resolution and Color Quality

1. Click **Start**, point to **Control Panel** and then click on it.
2. Double-click **Display** icon.
3. In **Display Properties** Window, select **Settings**.
4. Set **Colors as True color (32 bit)** and **Screen area as 1024 by 768 pixels**.

8-3. Internet Explorer

When you are trying to use this function, it is highly recommended that the password should be turned **ON** in the SYSTEM menu not to enable unauthorized personnel to access your DVR system (See section 7-2.3).

Up to 10 users can remotely access your DVR with the HOST NAME.

How to setup the Internet Explorer

- Registration to the www.dyndns.org (See section 7-7.7.2. on page 122).
- In the IP address box of Microsoft Internet Explorer, type the HOSET NAME (See Fig.8-2) you entered in the DDNS menu and the PORT NUMBER of the DVR, and then you will be asked to install the AciveX control software (See Fig.8-3). **You should type the protocol (http://), the host name (example: cloverdvr1.dyndns.org) or the static IP address (See Fig.8-2-1) and the port number (:5800) in the IP Address box.**

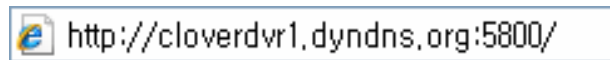

[Fig.8-2 Host Name]

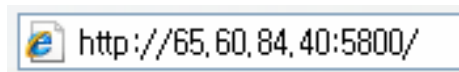

[Fig.8-2-1 IP & Port]

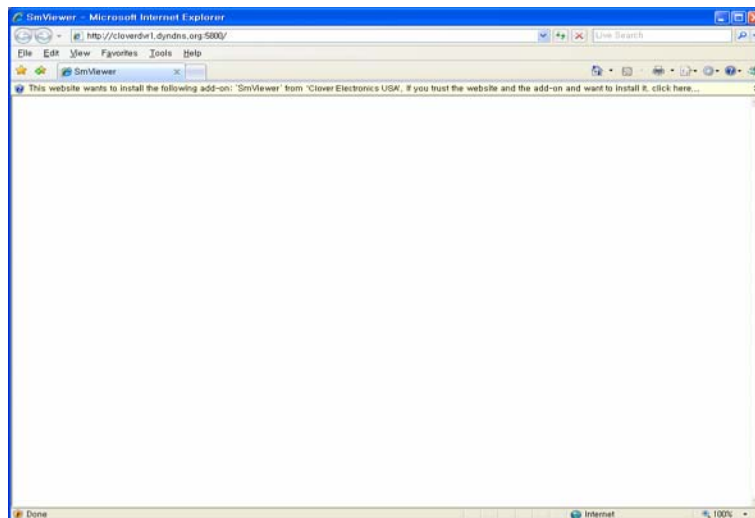

[Fig.8-3 COMBO VIEWER- Windows Internet Explorer]

8. Remote Host Program

- Click on the following message.
This site wants to install the following add-on: 'COMBOVIEWER' from 'Clover Electronics USA'. If you trust the website and the add-on and want to install it, **click here**....
- Click the **click install ActiveX Control**.... on the pop-up screen and the following window will be displayed.



[Fig.8-4 Install the SmViewer]

- Click the **Install** button on the above window (See Fig.8-4) and the **COMBO VIEWER** will be shown. Refer to the following pages in regards to the **COMBO VIEWER**.

8-4. Remote Host

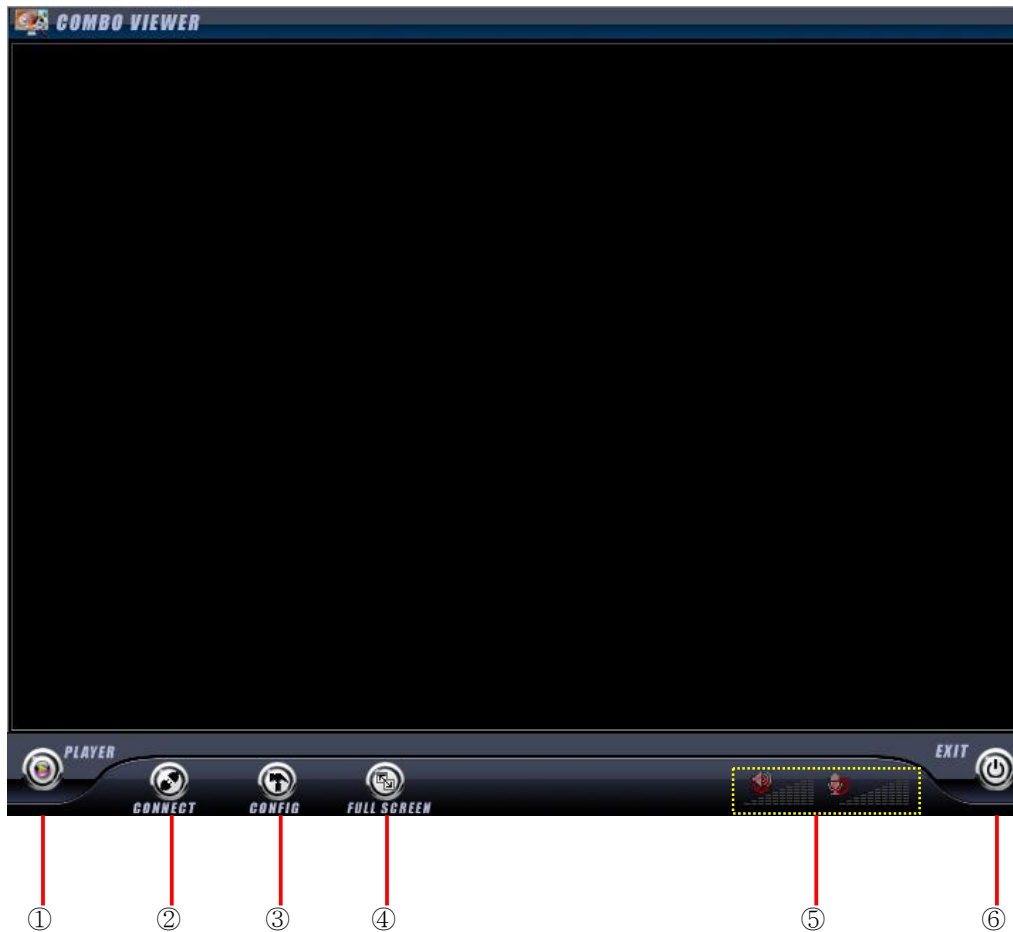

[Fig.8-5 ComboViewer]

Buttons of Remote Host Program

- ① Player button
- ② Connection button
- ③ Setup (Config) button
- ④ Full Screen button
- ⑤ Speaker / Microphone volume control
- ⑥ EXIT button

8-4.1. Setup

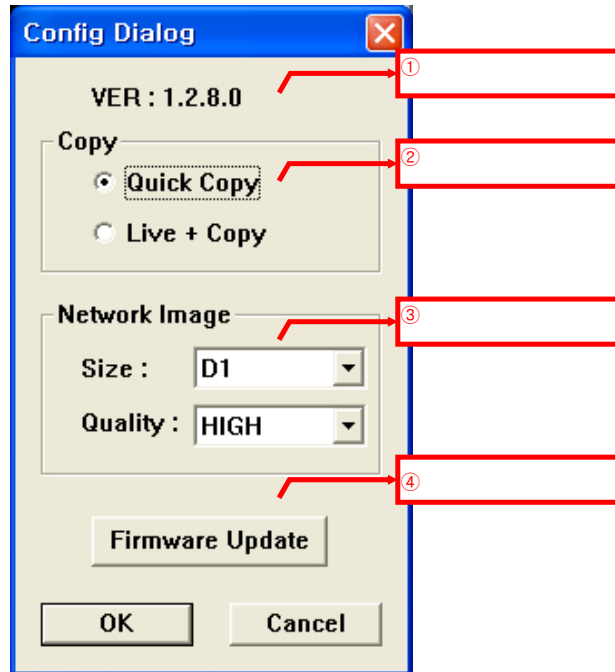

[Fig.8-6 HOST CONFIG window]

① Version number

It represents the current version number of the Firmware.

② Copy

Refer to Section 8-4.5 in regards to copying methods after selecting one between the Quick Copy and the Live + Copy.

▫ Quick Copy

Click on the Quick Copy for faster copying the recorded data from the DVR system to the Host Program (COMBO VIEWER) without live images. The copying speed of the Quick Copy is faster than the Live + Copy.

▫ Live + Copy

Click on the Live + Copy for copying the recorded data from the DVR system to the Host Program (COMBO VIEWER) with live images. The copying speed of the Live + Copy is slower than the Live + Copy.

③ Network Image

▫ Size

Choose a Size (Resolution) among D1, Half D1 and CIF you wish to display on the COMBO VIEWER by clicking the mouse. This setting does not affect the DVR.

▫ Quality

Choose one among LOW, NORMAL, HIGH and BEST you wish to display on the COMBO VIEWER by clicking the mouse. This setting does not affect the DVR.

④ Firmware Update

- Save the latest Firmware to the System Files (Open Windows Explorer – click My Computer - click the Program Files – click ComboViewer – click System Files).
- Click the Firmware Update button on the [Fig.8-6], and then you will be asked “Do you want to update a firmware?”
- Click the Yes to update.
- Double click the latest firmware as shown in [Fig.8-7] and then you will be asked “Shall I update firmware?”
- Click the OK to update. The DVR will display the “Firmware Updating.....” along with the progressive bar on the screen and it will automatically reboot.

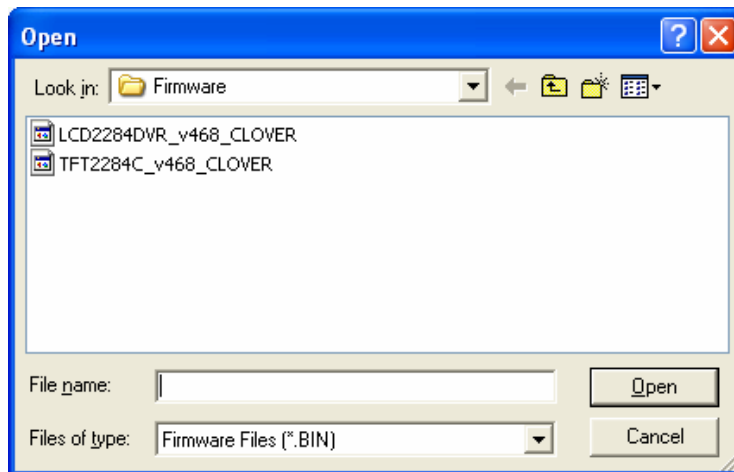

[Fig.8-7 Firmware Files]

8-4.2. Connection

There are two ways to access the DVR system through the **COMBO VIEWER** as follows.

- With **Set Direct** setting
 - Click the “CONNECT” button on the ComboViewer and then the “Connect Dialog menu” as shown in Fig. 8-8 will be displayed.
 - Click the “Set Direct” in the Connect Dialog menu and click the “EDIT” button.
 - Enter the IP address (or WAN IP address of the Router) and Port number, which must be the same as DVR has.
 - Click the “EDIT” button again and then the connection list will be created in the Name List (up to 20 lists).
 - Choose a Site Name in the Name Lists and click the “CONNECT” button in order to access the DVR.
- With **Get Server** setting
 - Click the “CONNECT” button on the ComboViewer and then the “Connect Dialog menu” as shown in Fig. 8-8 will be displayed.
 - Click the “Get Server” in the Connect Dialog menu and click the “EDIT” button.
 - Enter the IP address, Port number and Site Name, which must be the same as the MNS has (**SETUP-click NETWORK-click MNS in the NETWORK menu: Refer to section 7-7.5 MNS on page 118**).
 - Click the “EDIT” button again and then the connection list will be created in the Name Lists (up to 20 lists).
 - Choose a Site Name in the Name Lists and click the “CONNECT” button in order to access the DVR.

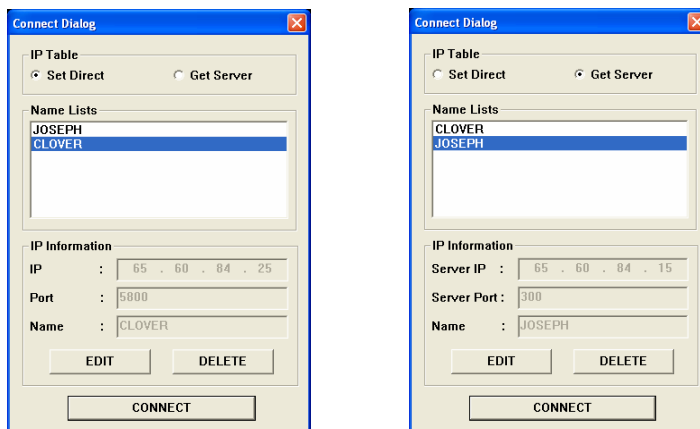

[Fig.8-8 Connect Dialog]

8-4.3. Switch the Normal Screen to Full Screen

- Click the “FULL SCREEN” button on the COMBO VIEWER and then the current screen size will be enlarged to fit the monitor’s screen size, but the resolution will be lowered.
- Click the “FULL SCREEN” button again to go back to the NORMAL SCREEN.

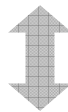

[Fig.8-9 Switch the Normal Screen to Full Screen]

8-4.4. Speaker / Microphone

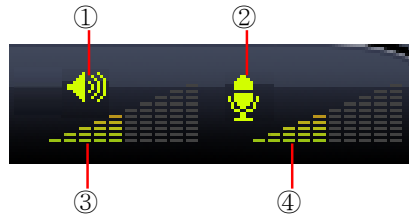

[Fig.8-10 Speaker / Microphone]

Buttons of Remote Host Program

- ① PC Speaker ON/OFF: Turn the Speaker ON or OFF by clicking the mouse.
 - ② PC Microphone ON/OFF: Turn the Microphone ON or OFF by clicking the mouse.
 - ③ PC Speaker Volume Control: Adjust the Speaker Volume by clicking the amount of audio volume. It is available when the Speaker is turned ON.
 - ④ Microphone Volume Control: Adjust the Microphone Volume by clicking the amount of audio volume. It is available when the Microphone is turned ON.
-

8-4.5. Copy

There are four icons such as NETWORK, USB, CD and DVD in the COPY menu of the COMBO VIEWER. The recorded data will be saved in the Backup Files (Open Windows Explorer – click My Computer - click the Program Files – click ComboViewer – click Backup Files) through the NETWORK, but the other icons such as USB, CD and DVD will only show on the COMBO VIEWER. Therefore it is impossible to copy the recorded data to client computer with these icons.

- Click the COPY button on the menu bar and the COPY menu will be displayed on the screen.
- In order to set the Copy starting time and the Copy ending time, select the values (year/month/date and hour/minute/second) by clicking the mouse, change the values with the mouse's wheel and click the mouse again on the changed values to complete.
- Click the mouse on the  icon only when the network is connected and you will be asked as shown in [Fig.8-11].
- Click the Yes to copy and the COMBO VIEWER will show the progressive status to copy (See Fig.8-12).
- Click the OK to complete the copy (See Fig.8-13).

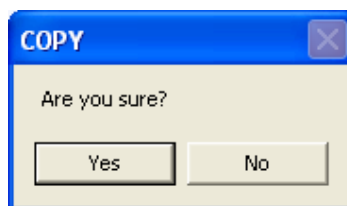

[Fig.8-11 Copy Confirmation]

8. Remote Host Program

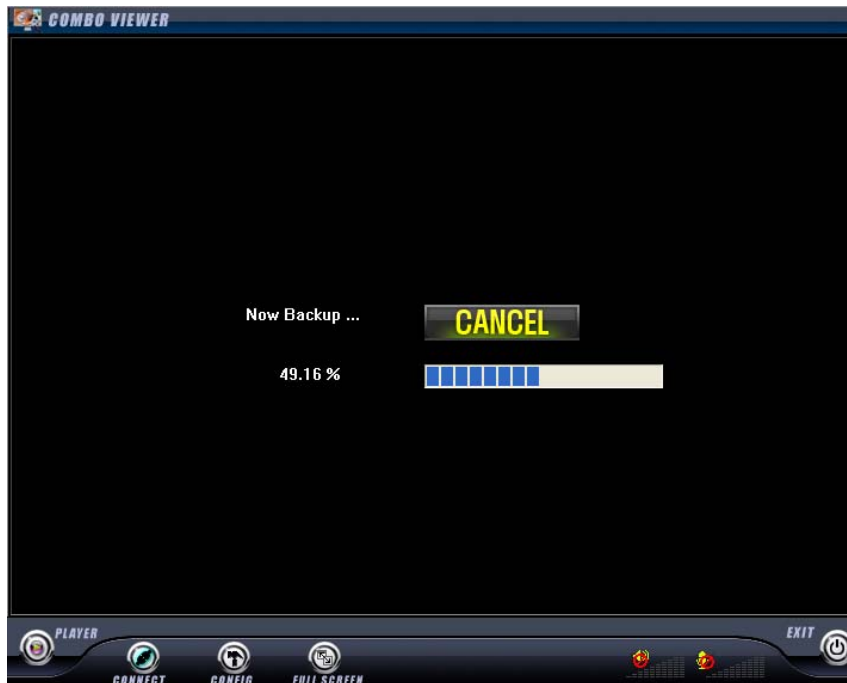

[Fig.8-12 Copying on the COMBO VIEWER]

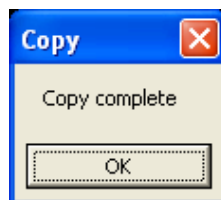

[Fig.8-13 Copy Completion]

8-5. PLAYER

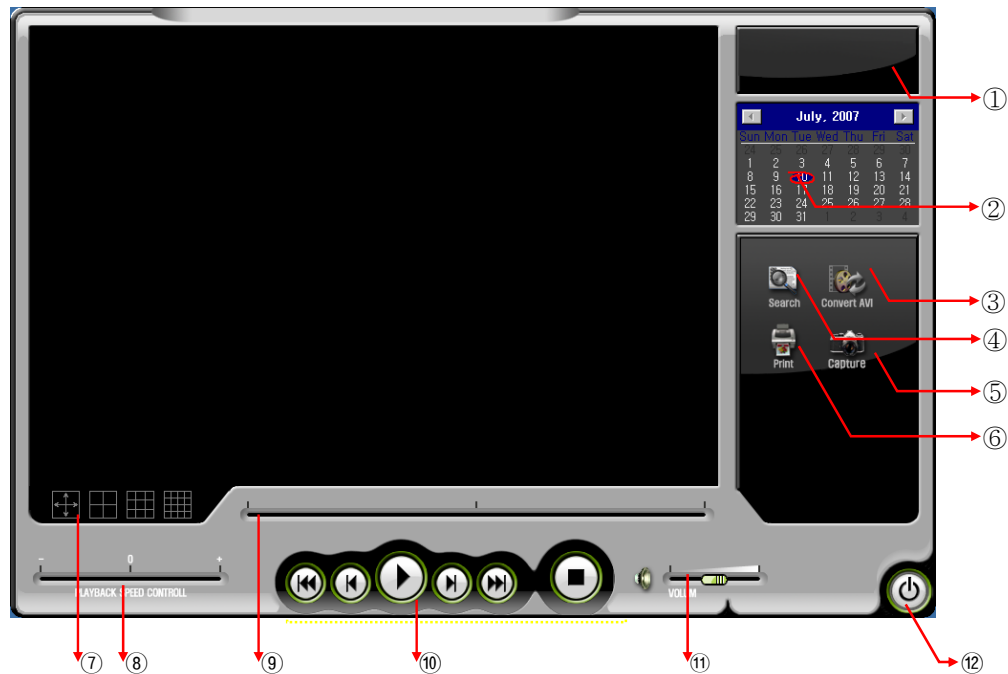

[Fig.8-14 Player]

Chart. Button of Player Program

- ① Status window (Play mode, Date, Time)
- ② Calendar
- ③ Convert to AVI File
- ④ Search button for replaying
- ⑤ Capture button
- ⑥ Print button
- ⑦ Division button
- ⑧ Playback (Replay) speed Control
- ⑨ Search slider for replaying
- ⑩ Replay Control
- ⑪ Volume Control
- ⑫ Exit program button

① Status window (Play mode, Date, Time)

It indicates the play mode, date and time.



[Fig.8-15 Status window]

② Calendar

It shows the date that is currently being replayed.

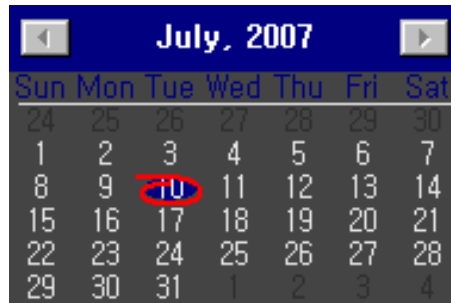

[Fig.8-16 Calendar]

③ Convert AVI File

Convert the recorded files to AVI files.

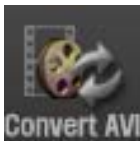

- Click the Convert AVI button on the Player and the Convert AVI window will be displayed (See Fig.8-17).
- Click on the SELECT button for SOURCE on the Convert AVI window and the Convert AVI window or the DVR Player will be displayed (See Fig.8-18 and Fig.8-19).
- Select the folder that contains the recorded data and select one of the channels by clicking the mouse and click the OK (See Fig.8-20).
- If necessary, select a folder for saving or make a new folder to save AVI files as shown in [Fig.8-20-1].

- Click the Start Convert button on the Convert AVI window and click the CLOSE button after verifying the status "Complete" (See Fig.8-21).

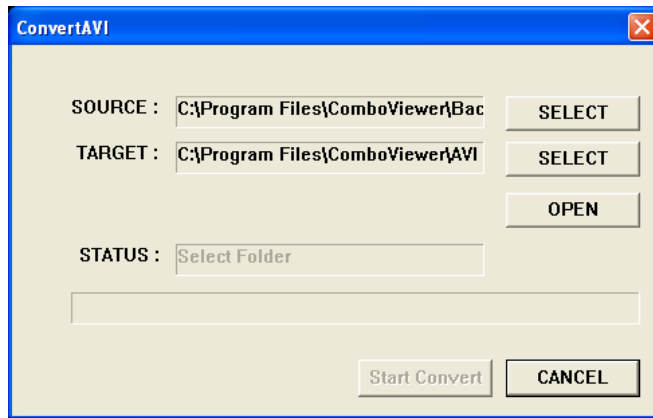

[Fig.8-17 Convert AVI window]

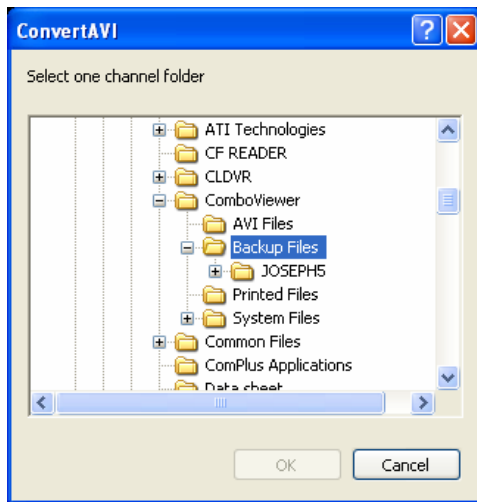

[Fig.8-18 Backup Files by Networking]

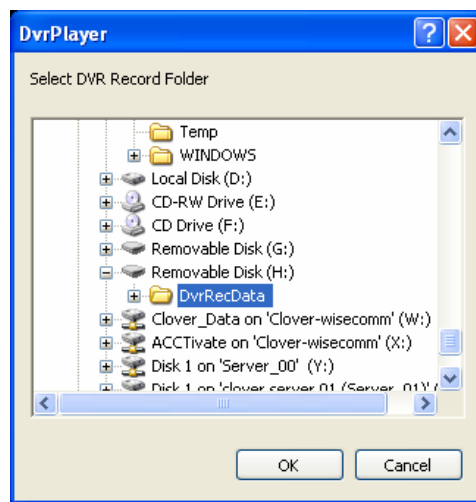

[Fig.8-19 DvrRecData by USB]

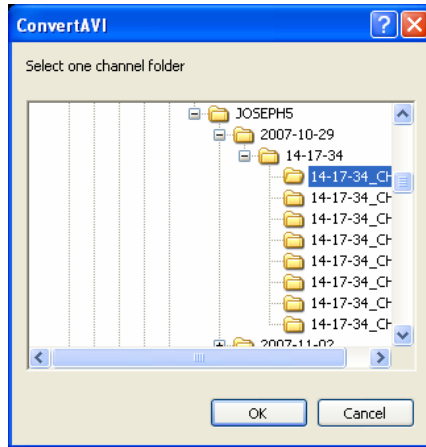

[Fig.8-20 Select one of the Channels]

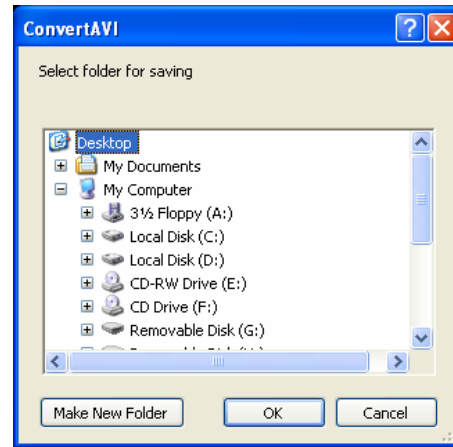

[Fig.8-20-1 Select folder for saving]

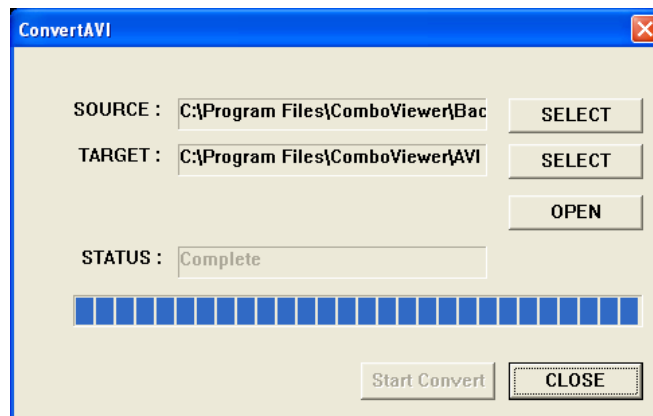

[Fig.8-21 Start Convert Button]

How to play the AVI files

By using Windows media player:

- Click the OPEN button on the Convert AVI window and double click one of the AVI files to play. The AVI files will save in the AVI Files folder (Open Windows Explorer – click My Computer - click the Program Files – click ComboViewer – double click one of the AVI Files).

④ Search button for Replaying



- Click the Search button on the Player and the DVR Player will be displayed.
- Select the folder that contains the recorded data and click the OK button on the DVR Player. One channel or all the channels can be replayed depends on the selection.

⑤ Capture button

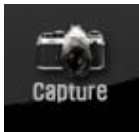

- Click the Capture button when a full screen is replaying on the Player and the current images will be saved in the Printed Files (Open Windows Explorer – click My Computer - click the Program Files – click ComboViewer – click Printed Files) in JPEG file format.

⑥ Print button



- Click the Print button when a full screen is replaying on the Player and the current images will print out along with comments if you write down some comments in the Print Comment Dialog as shown in [Fig.8-22].
- Click the OK button in the Print Comment Dialog regardless of the comments to print.

8. Remote Host Program



[Fig.8-22 Print command window]



[Fig.8-23 Print image]

⑦ Division button



Select one of the following divisions while replaying.

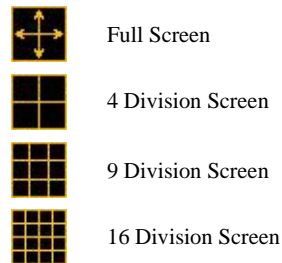

[Fig.8-24 Division button]

⑧ Playback (Replay) Speed Control

Move the slider with the mouse to control the replaying speed.

The "0" represents the normal speed, "-" and "+" represents slow speed or fast speed respectively.



[Fig. 8-25 Replay Speed Control Slider]

⑨ Search slider for replaying

The slider can be moved left and right by clicking the slider on the bar and dragging it or just click the bar to search the recorded data.



[Fig.8-26 Replay Search Slider]

⑩ Replay Control

Refer to section 6-9.2.3.



[Fig.8-27 Replay Control buttons]

⑪ Volume Control.

Control the volume when replaying in the full screen mode



[Fig.8-28 Replay Volume Control Slider]

⑫ Exit button

Click the Exit button on the Player to exit.



9

HDD Installation

CONTENTS

9-1. HDD (HARD DISK DRIVE) INSTALLATION	148
---	-----

9-1. HDD (Hard Disk Drive) INSTALLATION

The system manufacturer already installed a large space of Hard Disk Drive (refer to the retail box for capacity) in the system. Just in case, refer to the following explanation on how to install a HDD.

- ▶ The power switch must be turned off before installing and unplug the power cord to prevent an electric shock that may occur.
- ▶ Separate the HDD cover by removing two screws on the rear of the system as shown illustration below.

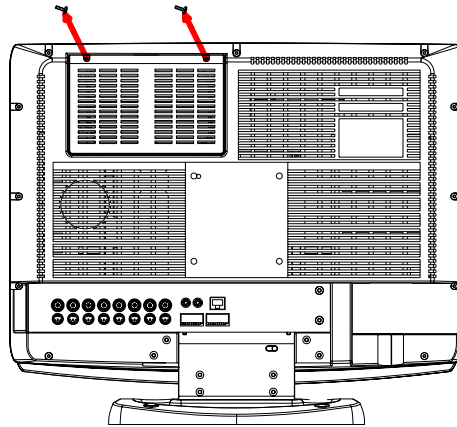

- ▶ Attach the HDD to the HDD bracket and install it with four screws as below. Do not securely fix the four screws so that the HDD moves to the left and the right. Place the HDD with the bracket in its place inside the system.

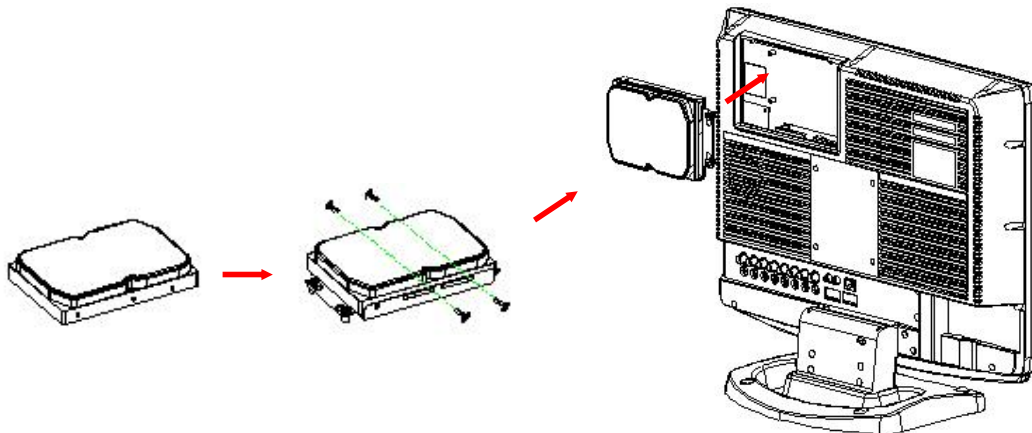

9. Installation of additional HDDs

- ▶ After pushing the HDD to the left and securely fix the bracket to the system with two screws. Connect the power connector and the data cable to the HDD.

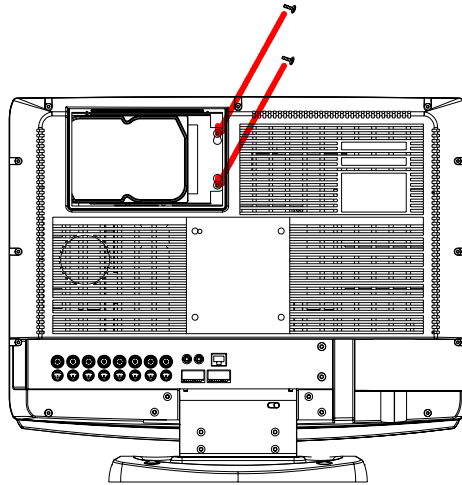

- ▶ After pushing the HDD to the right and securely fix the bracket to the system with two screws.

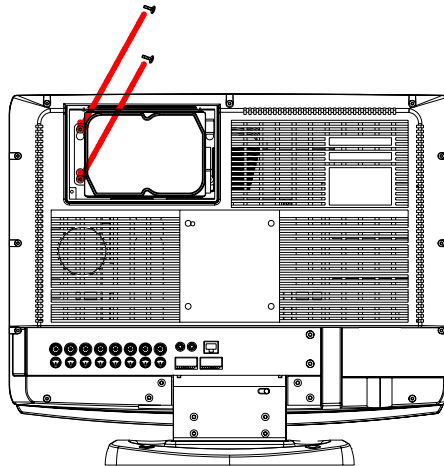

- ▶ Assemble the HDD cover and securely fix it to the system with two screws.

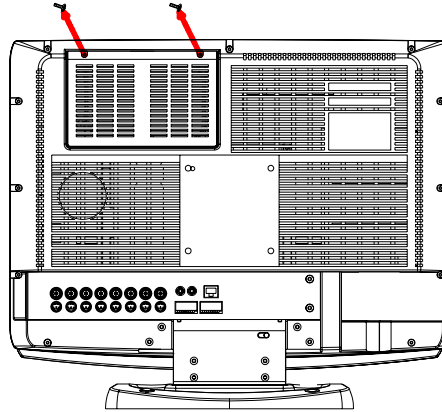

- ▶ Plug the AC power cord to the system and an AC outlet. Turn on the power switch on the back of the system and the following window will be displayed. **Check the power cable and the data cable connection if the system fails to recognize the HDD.**



Check Disk

- ▶ Click the OK button and the system will start formatting the HDD as follows.



Formatting

9. Installation of additional HDDs

- ▶ Update the Firmware with USB memory (or CD-RW/DVD-RW).
 - Copy the Firmware to USB memory (or CD-RW/DVD-RW).
 - Plug the USB memory to USB Port of the system and select **USB/CDRW/DVD** on the following window.



- ▶ If the Firmware is detected, the Firmware lists will be showed up as below.

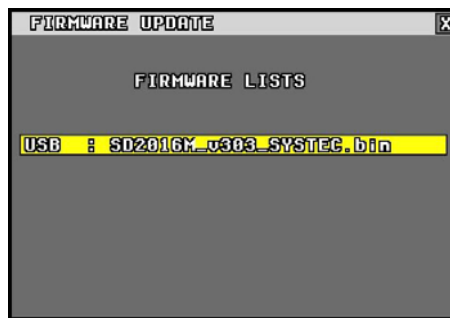

- ▶ When one of the Firmware lists is selected, the Firmware update will be proceeded and the system will automatically start rebooting after updating.



APPENDIX

CONTENTS

FACTORY DEFAULT SETTINGS	156
--------------------------------	-----

Recording time table

HDD: 500GB

Recording Resolution: Half D1 (720 x 240)

Based on 8 cameras

HOURS

Each (Total)	30 fps (240fps)	15 fps (120fps)	10 fps (80fps)	7 fps (56fps)	5 fps (40fps)	3 fps (24fps)	2 fps (16fps)
BEST	58.00	115.00	173.00	249.00	347.00	579.00	870.00
HIGH	194.00	387.00	581.00	830.00	1162.00	1937.00	2907.00
NORMAL	452.00	903.00	1356.00	1937.00	2712.00	4519.00	6778.00
LOW	917.00	1833.00	2750.00	3929.00	5500.00	9169.00	13754.00

DAYS

Each (Total)	30 fps (240fps)	15 fps (120fps)	10 fps (80fps)	7 fps (56fps)	5 fps (40fps)	3 fps (24fps)	2 fps (16fps)
BEST	2.40	4.79	7.20	10.38	14.45	24.12	36.25
HIGH	8.00	16.13	24.20	34.58	48.41	80.70	121.12
NORMAL	18.80	37.63	56.50	80.70	113.00	188.29	282.41
LOW	38.20	76.38	114.58	163.70	229.16	382.00	573.00

Factory default settings

(1) LIVE SCREEN

8 SPLIT
OSD ON

(2) TIME / DATE

DISPLAY : ON
TIME FORMAT : 24 HOUR
DATE FORMAT : YYYY/MM/DD

(3) LOAD / BACKUP CONFIG

NONE LISTS

(4) USER ACCOUNT

PASSWORD : SET YOUR PASSWORD (THE PASSWORD IS NULL)
PASSWORD ON/OFF : OFF

(5) IR REMOTE ID

OFF

(6) HDD OVERWRITE

ON

(7) CAMERA

ACTIVE : ALL ON
NAME : CAM XX
BUZZER : ALL ON
RELAY : ALL OFF
PAN/TILT VENDOR : PELCO
DISPLAY : ON
SEQ DISPLAY DWELL : 1 SEC

(8) AUDIO

AUDIO 1 : RELATED CAMERA CH 1, RECORD OFF, MIC 5
AUDIO 2 : RELATED CAMERA CH 2, RECORD OFF, MIC 5
AUDIO 3 : RELATED CAMERA CH 3, RECORD OFF, MIC 5
AUDIO 4 : RELATED CAMERA CH 4, RECORD OFF, MIC 5

(9) RECORD

RECORD ICON DISPLAY : ON
SIZE : ALL HALF D1 (704 X 240)
FPS : ALL 15 fps
QUALITY : ALL HIGH
MODE : ALL MANUAL RECORD MODE
SENSITIVITY : LOW (19)

- TIMER RECORD

ACTIVE : ALL OFF
TIMER : ALL 00 : 00

- MOTION

DETECT : OFF
PRE : 1 sec.
HOLD : 1 sec.
SPOT : OFF
REGION : ALL SET

- SENSOR

DETECT : OFF
PRE : 1 sec.
HOLD : 1 sec.
SPOT : OFF

(10) NETWORK

TYPE : DYNAMIC

PORT : 113

SERVER 1 MODE : DISABLE

SERVER 1 IP ADDRESS : 65.60.84.25

SERVER 1 PORT : 300

SERVER 2 MODE : DISABLE

SERVER 2 IP ADDRESS : 221.149.149.117

SERVER 2 PORT : 300

SERVER SITE NAME : SXXXXXX (MAC ADDRESS)

(11) VIDEO

- CAMERA INPUT

BRIGHTNESS : 128 (Max. 255)

CONTRAST : 128 (Max. 255)

- VGA OUTPUT

BRIGHTNESS : 20 (Max. 40)

CONTRAST : 20 (Max. 40)

SATURATION : 20 (Max. 40)

FAQ

I cannot login

- ▶ **Please check if the link LED of DVR and LAN port of PC are lit.**

- ▶ **Please check if the IP address on DVR and the PC is identical.**

Check SYSTEM STATUS by pressing STATUS button of DVR
(Available on LIVE mode and RECORD mode.)

MY IP : xxx.xxx.xxx.xxx

Check Target IP Address by clicking CONF button of PC host program.

TARGET IP ADDRESS : xxx.xxx.xxx.xxx

- ▶ **Please check whether there is a response upon PING test with DVR IP.**

Type "PING -t xxx.xxx.xxx.xxx" in DOS COMMAND window and execute.
(xxx.xxx.xxx.xxx is the DVR IP)

Request timed out → Check IP address

Reply from : xxx.xxx.xxx.xxx : Check Port number. Check if other user is using this.

- ▶ **Please check the Port number of DVR and PC is identical.**

Check Port number at MENU-SETUP → SYSTEM → NETWORK IP CONFIG.

PORT : 5800 (on DVR)

TARGET PORT NUMBER : 5800 (on Host Program)

- ▶ **Please confirm the Password of DVR and PC is identical.**

Check Password at MENU → SETUP → SYSTEM → PASSWORD

- ▶ **Please check whether DVR is connected another PC.**

Check SYSTEM STATUS by pressing STATUS button.

FROM : xxx.xxx.xxx.xxx : IP which is presently connected.

MY IP : xxx.xxx.xxx.xxx : DVR is waiting for connection.

- ▶ **Please check whether firewall is installed in the network.**

Ask the network administrator to reconfigure the firewall.

Limited 1Year Warranty

This warranty gives the original purchaser specific legal rights and you may also have other rights, which may vary from state to state. If our products do not function because of any defect in material or workmanship, we will repair it for free for 1 year on parts and labor from the date of original purchase. This warranty does not cover modification, abuse, incidental or consequential damages unless the state of owner's residence specially prohibits limitations on incidental or consequential damages.

How to obtain Factory Service

- Original purchaser must fill out the warranty card and mail it to the factory with the model number, serial number and the date of purchase.
- We will repair or replace, and return the system to the owner under this limited warranty.
- Please pack the system carefully and securely using the original packing materials, and send it prepaid and insured to: **13073 E. 166th St, Cerritos, CA 90703.**
- Please include a check for \$50.00 to cover the cost of return postage and handling. If the system is returned within the warranty period, please include a proof of purchase. If the system is out of warranty, you will receive an estimate of the repair cost for your approval before repair work will be started.

Free Manuals Download Website

<http://myh66.com>

<http://usermanuals.us>

<http://www.somanuals.com>

<http://www.4manuals.cc>

<http://www.manual-lib.com>

<http://www.404manual.com>

<http://www.luxmanual.com>

<http://aubethermostatmanual.com>

Golf course search by state

<http://golfingnear.com>

Email search by domain

<http://emailbydomain.com>

Auto manuals search

<http://auto.somanuals.com>

TV manuals search

<http://tv.somanuals.com>