

OPERATING INSTRUCTIONS FOR YOUR



CORDLESS TELEPHONE WITH CALLER ID

"The antenna is in the phone,
not in your way...and the sound is incredible."



COBRA ELECTRONICS CORPORATION
6500 W. Cortland Street
Chicago, Illinois 60707

MODEL CP-2525



Please note that Caller ID and Call Waiting services from
your local carrier are required for proper operation.



**Cordless Telephone Model CP-2525
Table of Contents**

SUBJECT

Important Safety Instructions3-4

Introduction5

Installation Information6

Quick Set-Up Guide7

Wall-Mounting Instructions8

Using Your Phone9

 Answering/Placing Calls at the Base9

 Answering/Placing Calls Away from the Base.....9

Cordless Phone Operational Features9

 Battery Saver Circuitry9

 Caller ID10

 Caller ID Log.....11

 Making a Call From the Caller ID Log11

 Special Calling Situations11

 Deleting an Entry in the Caller ID Log.....12

 Channel Selection.....12

 Compander Noise Reduction.....12

 Digital Security.....12

 Electronic Directory13-15

 Find16

 Flash16

 Hearing Aid Compatibility.....16

 Intenna® System16

 Last Number Redial.....16

 Message Indicator17

 Out-of-Range Signal17

 Pulse/Tone Switch.....17

 Ringer Switch17

 Secur-Loc®17

Rechargeable Handset Battery Information.....18

 Handset Battery Recharging17

 Replacing the Handset Battery18

 Handset Battery Disposal19

Cleaning the Charging Contacts19

About Cordless Phone Performance.....20

Intenna® Cordless Telephone Troubleshooting Guide21

If You Think You Need Service22

Registered with the FCC.....22

Limited One-Year Warranty23

Cordless Phone AccessoriesInside Back Cover

Important Safety Instructions

When using your telephone equipment, basic safety precautions should always be followed to reduce the risk of fire, electric shock and injury to persons, including the following:



1. Read and understand all instructions.
2. Follow all warnings and instructions marked on the product.
3. Unplug this product from the wall outlet before cleaning. Do not use liquid cleaners or aerosol cleaners. Use a damp cloth for cleaning.
4. Do not locate base unit near water, for example, near a bath tub, wash bowl, kitchen sink, or laundry tub, in a wet basement or near a swimming pool.
5. Do not place this product on an unstable cart, stand or table. The product may fall, causing serious damage to the product.
6. Slots and openings in the cabinet and the bottom or back are provided for ventilation, to protect it from overheating; these openings must not be blocked or covered. The openings should never be blocked by placing the product in the bed, sofa, rug or other similar surface. This product should never be placed near or over a radiator or heat register. This product should not be placed in a built-in installation unless proper ventilation is provided.
7. This product should be operated only from the type of power source indicated on the marking label. If you are not sure of the type of power supply to your home, consult your dealer or local power company.
8. Do not allow anything to rest on the power cord. Do not locate this product where the cord will be abused by persons walking on it.
9. Do not overload outlets and extension cords as this can result in the risk of fire or electric shock.
10. Never push objects of any kind into this product through cabinet slots as they may touch dangerous voltage points or short out parts that could result in a risk of fire or electric shock. Never spill liquid of any kind on the product.
11. To reduce the risk of electric shock, do not disassemble this product, but take it to qualified servicemen when service or repair work is required. Opening or removing covers may expose you to dangerous voltages or other risks. Incorrect reassembly can cause electric shock when the appliance is subsequently used.
12. Avoid using telephone (other than a cordless type) during an electrical storm. There may be a remote risk of electric shock from lightening.
13. Do not use the telephone to report a gas leak in the vicinity of the leak.
14. Unplug this product from the all outlet and refer servicing to qualified service personnel under the following conditions:
 - A. When the power supply cord or plug is damaged or frayed.
 - B. If liquid has been spilled into the product.
 - C. If the product has been exposed to rain or water.
 - D. If the product does not operate normally by following the operating instructions. Adjust only those controls that are covered by the operating instructions because improper adjustment of other controls may result in damage and will often require extensive work by a qualified technician to restore the product to normal operation.
 - E. If the product has been dropped or the cabinet has been damaged.
 - F. If the product exhibits a distinct change in performance.

Important Safety Instructions (continued)

The cordless handset operates on batteries, please read and follow instructions:

- A. Use only the battery pack supplied with the unit or identical replacement.
 - B. Do not dispose of battery pack in a fire. The cells may explode. Check with local codes for possible disposal instruction.
 - C. Since released electrolyte is corrosive and may cause damage to eyes or skin and may be toxic if swallowed:
 - C1. Do not open or mutilate battery pack.
 - C2. Always replace the entire battery pack rather than reusing one or more cells.
 - C3. Do not expose batteries to heat or flame.
 - D. Exercise care in handling the battery pack in order not to "short" the battery contacts with conducting materials such as rings, bracelets, and keys. The battery or conductor may overheat and cause burns.
15. Never install telephone wiring during a lightning storm.
 16. Never install telephone jacks in wet locations unless the jack is specifically designed for wet locations.
 17. Never touch uninsulated telephone wires or terminals unless the telephone line has been disconnected at the network interface.
 18. Use caution when installing or modifying telephone lines.

Save These Instructions

	CAUTION RISK OF ELECTRIC SHOCK DO NOT OPEN	
WARNING: TO PREVENT FIRE OR ELECTRIC SHOCK HAZARD DO NOT EXPOSE THIS PRODUCT TO RAIN OR MOISTURE	CAUTION: TO REDUCE THE RISK OF ELECTRIC SHOCK DO NOT REMOVE COVER (OR BACK). NO USER SERVICEABLE PARTS INSIDE. REFER SERVICING TO QUALIFIED SERVICE PERSONNEL.	THE EXCLAMATION POINT WITHIN THE TRIANGLE IS A WARNING SIGN ALERTING YOU OF DANGEROUS VOLTAGE INSIDE THE PRODUCT.
SEE MARKING ON BOTTOM/BACK OF PRODUCT		

How To Use Your



Cordless Telephone Model CP-2525

U.S. PATENT 4876709
U.S. PATENT 5351284

Introduction

Thank you for your purchase of a Cobra® *Intenna*® Cordless Telephone—the world's first and only full-range-power cordless telephone without any external antennas!

No more extending, bending, or breaking the antennas found on other cordless phones—you Cobra *Intenna* conceals its antenna systems inside the handset and base, where they should be, out of your way.

Now you can install your new Cobra *Intenna* cordless phone virtually anywhere. Without cumbersome external antennas to worry about, put your new phone anywhere a corded phone can go! Then enjoy the freedom of using your new cordless phone all over the house as well as outside in your yard.

Your new Cobra Model CP-2525 features the Opti Scan™ system with 25 selectable channels (the maximum number available) for optimum interference-free use, and a 30 name and number electronic directory. The CP-2525 allows you to keep the phone away from the base for up to 14 days between recharges, is equipped with Clear Call® PLUS Circuitry with compander noise-reduction system to ensure corded-phone sound quality, Private Call® voice scrambling, and Power Protector™ reserve power for operation during power outages. Caller ID allows you to see who's calling before answering.

Please take a moment to review this booklet and become familiar with all of the many user-friendly convenience features built into your new Cobra *Intenna* Cordless Phone.

If you need further assistance installing or using your new *Intenna* Cordless Telephone, please call our consumer "hotline" at 1-773-889-3087.

NOTE: Some cordless telephones operate at frequencies that may cause interference to nearby TV's and VCR's. To minimize or prevent such interference, the base of the cordless telephone should not be placed near or on top of TV's or VCR's. If interference is experienced, moving the cordless telephone base further away from the TV or VCR will often reduce or eliminate the interference.

CAUTION: Any changes or modifications not expressly approved by Cobra could void the user's authority to operate the equipment.

NOTE: Caller ID and Call Waiting services are required for proper operation.

Installation Information

Maximum range is obtained by installing the base unit in the highest living area of your home. The location you choose must be near an electrical outlet and a telephone wall jack.

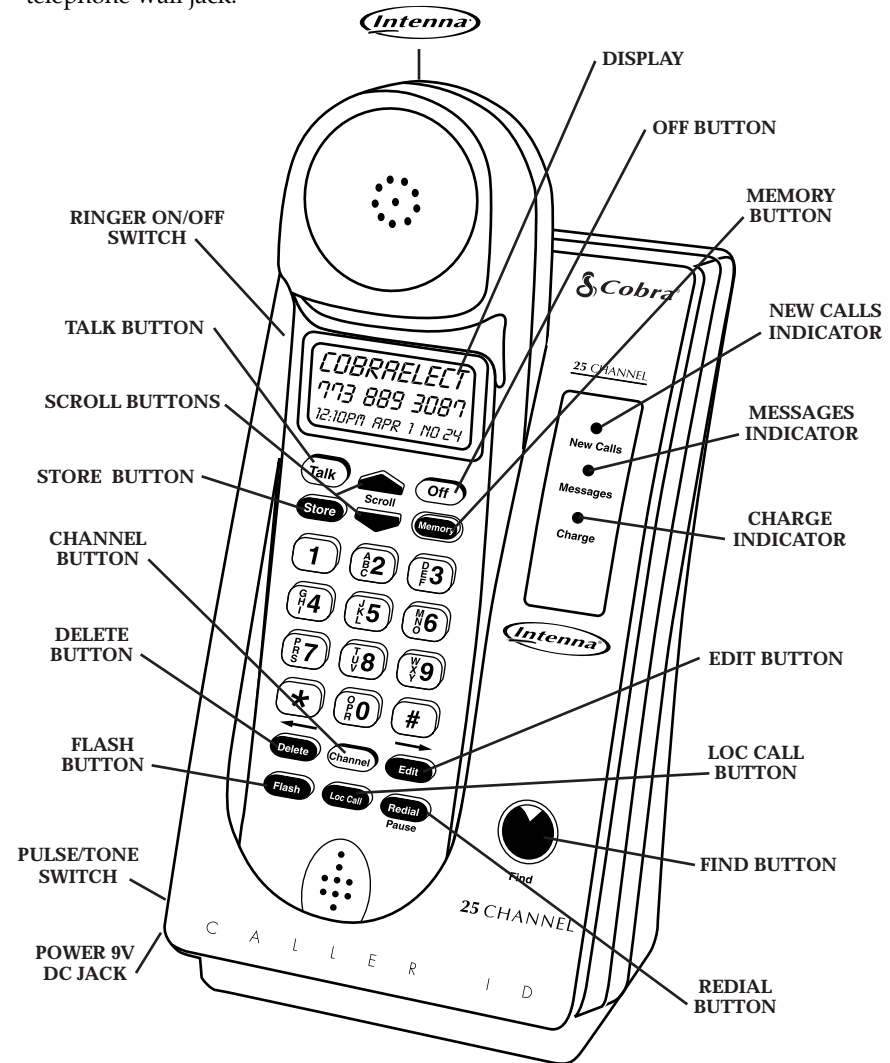

Quick Set-Up Guide

The following basic steps enable quick and easy installation of your new Cobra *Intenna*® Cordless Phone for use on a desk or countertop. You are encouraged to review this complete instruction manual to become familiar with all of the operating instructions and features of your new phone.

NOTE: Before using, connect your new system to AC power (see instructions below) to charge it overnight (at least 12 hours) for optimum conditioning of the rechargeable battery inside the cordless handset.

1. Insert round connector of power adapter into POWER jack (at side of cordless phone's base; see diagram below). Plug power adapter into a standard 120 VAC household electrical outlet. Then place handset in base so CHARGE indicator lights (see p. 18).

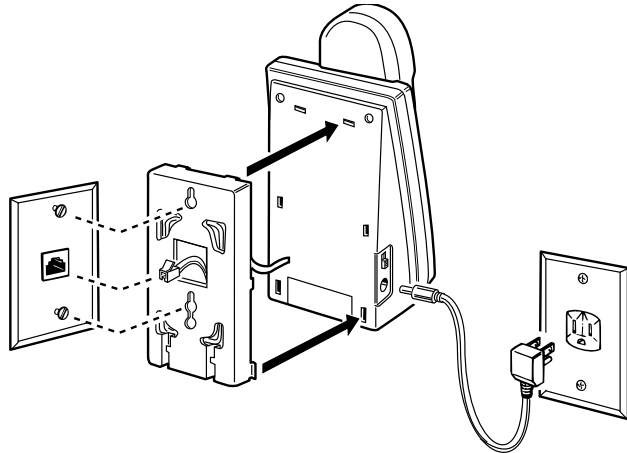

2. After charging, remove the twist-tie from the phone cord and plug the modular telephone connector into the phone jack on your wall (see above).
3. Make sure that the RINGER switch is ON (located on handset; see p. 17 for details).
4. Set the PULSE/TONE switch (at the side of the base) for proper operation (see p. 17 for details).

Note: Make sure you have charged handset in base 12 hours before using.

5. Snap the desk bracket into the base as shown in the illustration

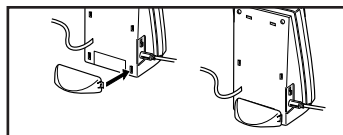
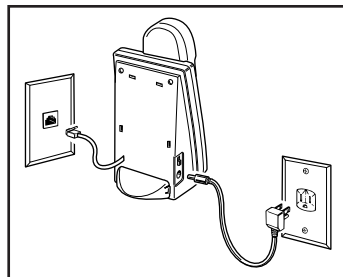

Wall Mounting Instructions

The following steps enable installation on a new or existing telephone wall-mounting plate or directly onto a wall. (Your Cobra *Intenna* is designed to be used with any AT&T, GTE, local phone company or other wall-mounting plates that can be purchased from most local electronics stores.)

- Use the separate wall mounting bracket.
- Place the telephone line cord so the last inch (near the modular connector) is in the center opening (as shown).
- Wrap the cord counter clockwise around the center until the cord is totally contained in the bracket.
- Place the bracket's top two tabs into the top two openings in the base back panel.
- Carefully snap the bottom two tabs into the bottom two openings in the base back panel.
- Plug the modular connector into the telephone wall jack.
- Align the mounting studs on the wall plate to the holes in the cord wrap bracket. Push the base onto the studs and slide it down into a locked position on the wall plate.
- Attach the power adapter to the POWER connection (on the base of the phone) and plug into a household AC power outlet.
- To install directly on any wall, you'll need to provide two screws and wall anchors; follow these steps:
 - Drill two holes $3\frac{1}{4}$ " apart and insert the wall anchors.
 - Drive the screws into the anchors until the head of each screw is protruding about $\frac{1}{8}$ " from the wall.
 - Follow the procedure outlined above, except leave enough telephone cord to reach the phone jack before wrapping the cord.
 - Align the screws to the holes in the cord wrap bracket. Push the base onto the studs and slide it down into a locked position on the wall plate.
 - Plug modular phone connector into telephone wall jack; attach the power adapter to the POWER connection (on the base of the phone) and plug into to a household AC power outlet.

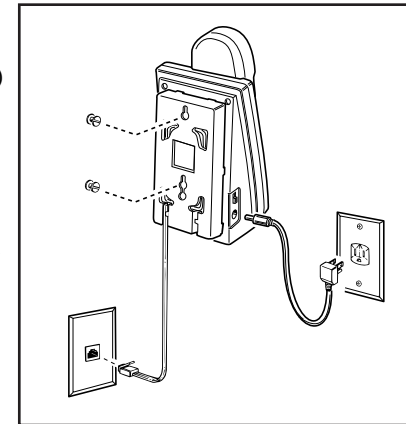

Using Your Phone

After charging the handset batteries overnight (at least 12 hours), your Cobra *Intenna* cordless phone will be ready for use.

ANSWERING/PLACING CALLS AT THE BASE

- The display will illuminate and show Caller ID information with an incoming call. To answer a call, just pick-up handset from base when the phone rings. When call is completed, return handset to base without pressing OFF button; your phone automatically disconnects.
- To place a call, pick-up handset from base and press and release the TALK button. When you hear the dial tone, place your call. The dialed number will appear in the display.

ANSWERING/PLACING CALLS AWAY FROM THE BASE

- The phone is ready to ring if a call is received (RINGER Switch on the handset must be in ON position).
- Press and release the TALK button to answer or place a call.
- Press and release the OFF button when finished with a call.

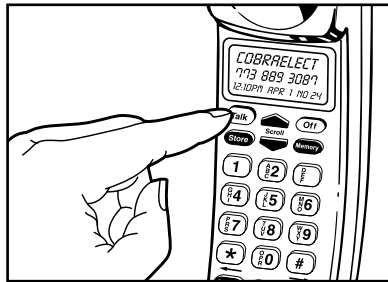

Cordless Phone Operational Features

The following features offer state-of-the-art performance and the ultimate in user-friendly convenience with your new Cobra *Intenna* cordless telephone.

BATTERY SAVER CIRCUITRY

The handset of this phone may be kept away from the base up to 14 days at a time. In this condition, it is ready for you to answer or place calls by pressing and releasing the TALK button.

Note: A warning beep tone will sound and the LOBAT indicator will flash when the handset battery needs recharging (see p. 18). The duration of the battery charge will depend on your actual use of the phone in its remote location.



CALLER ID

NOTE: CALLER ID and Call Waiting services are required for proper operation.

Receiving A Call:

This phone will indicate the caller's name, telephone number, time, and date typically after the first ring. It is also compatible with Call Waiting, where the second caller's information will be displayed. The display will be illuminated upon receipt of the first ring until the call is answered. Sometimes the display may show one of the follow messages:

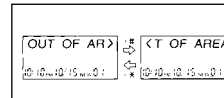

The call originates from an area not served by Caller ID.

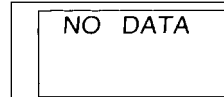

Your telephone company has not sent data.

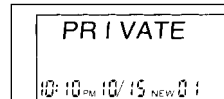

The caller has blocked their Caller ID data from being transmitted.

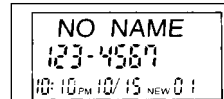

You have not subscribed to a Caller ID service with "name" capability.



There has been an error in data reception.

If the incoming name is longer than 10 characters or the number is longer than 12 digits:

">" will appear as the last character of the first line. Use the "*" button to scroll left and the "#" button to scroll right to view the entire name or number. A maximum of 15 characters for names and 16 digits for phone numbers can be displayed.

PBX Connections:

The Caller ID system may not operate correctly when connected to a PBX system. Please contact your telephone company for further information.

"New Calls" Indicators:

Base: The NEW CALLS LED will be illuminated until you review the call in the Caller ID log.

Handset: The word "NEW" and the number of new calls will be shown in the display.

CALLER ID (CONT'D)

THE CALLER ID LOG

The Caller ID log can store 30 names and numbers. When it becomes full, the oldest will be deleted as new calls are received. You can store an entry from the log into the Electronic Directory (please see Electronic Directory section for instructions).

To review Caller ID log entries, press either the Scroll up or down button. Scrolling up will move you up the list from 1 (newest) to 30 (oldest). Scrolling down will move you down the list from 30 (oldest) to 1 (newest).

Use the “★” and “#” buttons to scroll left and right if the complete name or number does not appear in the display.

To exit the log, press the OFF button.

MAKING A CALL FROM THE CALLER ID LOG

You can make a call automatically from the Caller ID log. Scroll to the desired entry and press the TALK button. “TALK” will appear in the display. The phone will automatically dial the number shown.

IMPORTANT NOTE: Caller ID data includes an area code even if the call originates within your local calling area. Since the area code should not be used for dialing if the number shown is within your area code, press the **Loc Call** button rather than the TALK button. The phone will not dial the area code.

SPECIAL CALLING SITUATIONS

If your telephone company requires a “1” to be dialed before the main number for a local call: Scroll to the desired entry and press the EDIT button. The cursor will flash at the beginning of the phone number line. Press the “1” keypad button. Press the TALK button. The phone will automatically add “1” to the called number.

If you need to change the telephone number: The phone number may have changed since it was first entered into the Caller ID log. To change it, scroll to the desired entry and press the EDIT button. The cursor will flash at the beginning of the phone number line.

To move the cursor to the right, press the “#” keypad button until the digit to be changed is flashing. Press the DELETE button, the digit will disappear and the digit to its right will take its place. Press the keypad button for the new digit. Press the TALK button to begin dialing.

To end the call, press the OFF button.

DELETING AN ENTRY IN THE CALLER ID LOG

Upon receipt of the 31st call, the oldest entry will be deleted.

To manually delete any entry:

1. Scroll up or down to reach the entry to be deleted.
2. Press the DELETE button. The display will show DELETE?
3. Press the DELETE button again.

To manually delete all entries:

1. Press either the scroll up or down button.
2. Press the DELETE button for more than two seconds. The display will show DEL ALL?
3. Press the DELETE button again.

To cancel the delete operation, press the OFF button before pressing the DELETE button for the second time. To return to standby mode, press the OFF button.

CHANNEL SELECTION

25 selectable channels are built into your Cobra *Intenna* for optimum interference-free use.

If interference begins during a conversation:

- Press and release the CHANNEL button on the handset. Your phone will automatically scan and advance to the next clear channel.
- If an alert tone (3 beeps) sounds, channel change was unsuccessful. In that case, move closer to the phone base and press CHANNEL button again.

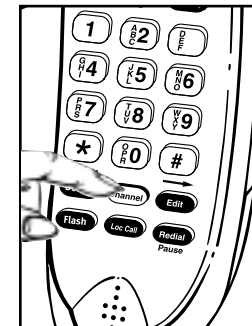

COMPANDER NOISE REDUCTION

Your Cobra *Intenna* has the Cobra Clear Call® PLUS compander noise-reduction system to minimize background noise for optimum audio performance. The sound of your phone will be comparable to the performance of a corded phone.

DIGITAL SECURITY

Your Cobra *Intenna* features 65,000 combinations of digital security coding (in accordance with FCC regulations) to reduce the chance of interference from your neighbors' cordless phones. These inaudible, electronic codes are transmitted automatically by your phone to establish a secure link between your cordless handset and base.

ELECTRONIC DIRECTORY

Your Cobra *Intenna* cordless phone enables you to store thirty names and numbers in an electronic directory. These directory memories are in addition to the thirty Caller ID memories. Any memory from the electronic directory can be automatically dialed.

To store a name and number from the keypad:

1. Press the EDIT button.
2. Enter the phone number using the handset keypad. A maximum of 16 digits can be entered.
3. Press the SCROLL up button to begin entering the name. If you do not want to enter a name, skip to step #5.
4. Keypad buttons are used enter the name.

NOTE: Each button can be used to enter the upper and lower case letters shown on the button. The "1", "0", "CHANNEL", "★", "#" buttons can also enter specific symbols as shown in **Table 1**. A maximum of 15 characters per name can be entered.

EXAMPLE: Enter Ed Jones

- 1.) Press "3" twice. "E" will appear.
- 2.) Press "#" to move the cursor one space to the right
- 3.) Press "3" four times. "d" will appear.
- 4.) Press "#".
- 5.) Press "0" twice for a blank space.
- 6.) Press "#".
- 7.) Press "5" once. "J" will appear.
- 8.) Press "#" and finish entering "o-n-e-s" using the procedures above.

TABLE 1

Number of times key is pressed during character entry									
Key	1	2	3	4	5	6	7	8	9
1	&	'	()	,	-	.	/		1
ABC 2	A	B	C	a	b	c	2		
DEF 3	D	E	F	d	e	f	3		
GHI 4	G	H	I	g	h	i	4		
JKL 5	J	K	L	j	k	l	5		
MNO 6	M	N	O	m	n	o	6		
PQRS 7	P	Q	R	S	p	q	r	s	7
TUV 8	T	U	V	t	u	v	8		
WXYZ 9	W	X	Y	Z	w	x	y	z	9
OPER 0	0	Blank							
channel	*	#							
*	To move the cursor to the left								
#	To move the cursor to the right								

ELECTRONIC DIRECTORY (CONT'D)

5. Press STORE. The display will show LOCATION?
6. Enter a location number (01 to 30).
 - a.) If the location has not been used, the display will show STORE? Press the STORE button. The display will show STORED.
 - b.) If the location is in use, the display will show REPLACE?
 - 1.) If you do want to replace it, press the STORE button. The display will show REPLACED.
 - 2.) If not, select another location number and press STORE. The display will show STORED.
7. The phone will automatically revert to Standby mode in a few seconds.

To store a name and number from the Caller ID log:

1. Locate the desired log entry using the SCROLL buttons.
2. Press the EDIT button.
3. Press STORE. The display will show LOCATION?
4. Enter a location number (01 to 30). If the location has not been used, the display will show STORE? Press the STORE button. The display will show STORED. If replacing an existing directory entry, please go to step #6b above.
5. The phone will automatically revert to Standby mode in a few seconds.

To change a directory memory:

1. Press the Memory button. The display will show LOCATION?
2. Either enter a the location number (01 to 30) or use the SCROLL up and down buttons to find the entry that you want to change. The display will show the memory entry.
3. Press the EDIT button. The first digit of the number will flash. If you do not want to change the telephone number, press the SCROLL up button (the first letter of the name will flash) and go to step #8.
4. Change the telephone number by using the "#" and "★" buttons to move the cursor to the digit(s) requiring change. Once at the digit, press the DELETE button.
5. Press the new digit on the keypad. The display will show the new telephone number.
6. Repeat step #5 for as many digits as necessary.
7. A.) If you are now finished, go to step #8.
B.) If you also want to change the name, press the SCROLL up button. The first letter of the name will flash. Repeat steps #4 through #6 to change the characters in the name.

ELECTRONIC DIRECTORY (CONT'D)

8. Press STORE. The display will show LOCATION?
9. Enter the location number. It can be the current location or a new one. The display will show REPLACE?
10. Press STORE. The display will show REPLACED.
11. The phone will automatically revert to Standby mode in a few seconds.

To delete a directory memory:

1. Press the MEMORY button. The display will show LOCATION?
2. Either enter the location number (01 to 30) or use the SCROLL up and DOWN buttons to find the entry you want to change. The display will show the memory entry.
3. Press the DELETE button. The display will show DELETE?
4. Press the DELETE button again. The display will show DELETED.
5. The phone will automatically revert to Standby mode in a few seconds.

To delete all directory memories:

1. Press the MEMORY button. The display will show LOCATION?
2. Either enter the location number (01 to 30) or use the SCROLL up and DOWN buttons to find the entry you want to change. The display will show the memory entry.
3. Press the DELETE button for more than two seconds. The display will show DEL ALL?
4. Press the DELETE button again. The display will show DELETED.
5. The phone will automatically revert to Standby mode in a few seconds.

To automatically dial a name and number from the electronic directory:

1. Lift the handset from the base.
2. Press the Memory button. The display will show LOCATION?
3. Enter the location number (01 to 30) or press the SCROLL up and down buttons. The display will show the directory entries. Stop when you reach the desired entry.
4. Press the TALK button. The display will show TALK and the number dialed.
5. Press OFF when the conversation is over or place the handset back into the base.

FIND

Find the handset by pressing the Find button on the base. The handset will emit a beeping sound for thirty seconds.

FLASH

This feature briefly interrupts the phone line so that you may access some of the advanced features—like “Call Waiting” and “Three-way Calling”—that may be offered at extra cost by your local telephone company. Press and release the FLASH button on the handset to answer a second phone call or place a conference call if you subscribe to these services. This function is available on the handset and base.

HEARING AID COMPATIBILITY

Your cordless telephone handset is compatible with inductively coupled hearing aids (HAC).

SYSTEM

The revolutionary, patented Intenna hidden-antenna system is a Cobra exclusive. Intenna is the world's first and only full-range-power cordless telephone that conceals the handset and base antennas inside the phone and out of the way. No more antennas to extend, bend or break. Cobra's hidden antennas are perfectly matched to your phone's microprocessor circuitry for optimum performance offering the ultimate in user-friendly convenience.

LAST NUMBER REDIAL

Each time you dial, the phone number you're calling is automatically saved in a special REDIAL memory. To call that number again at a busy signal, press FLASH (without hanging up) to get a new dial tone, then press and release the REDIAL button. If you wish to try the call in a few minutes, use TALK to access the dial tone, then press and release the REDIAL button. The number will automatically be redialed.

MESSAGE INDICATOR

The indicator on the base will illuminate if a caller has left a message in your voice mail. You must subscribe to this service from your telephone company.

OUT-OF-RANGE SIGNAL

If three beeps are heard after the TALK button is pressed, the handset is too far away from the base. The handset and TALK indicator will automatically turn off. Move closer to the base and then try your call again.

PULSE/TONE SWITCH

Your Cobra *Intenna* cordless phone can be used with any phone system because it is switchable from pulse to tone dialing (see switch on side of base) depending on which service you are using. Mixed PULSE and TONE dialing may be used (to access certain long-distance or computerized banking services, for example) by selecting PULSE with the base switch and then using the ★ button on the handset to temporarily switch to tone dialing. Hanging up resets to PULSE.

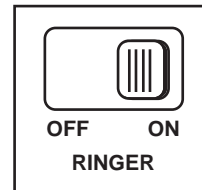
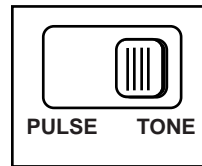

RINGER SWITCH

The OFF/ON switch controls your cordless handset's electronic ringer; no ring will sound in the OFF position.

SECUR-LOC®

This exclusive Cobra electronic circuitry is an added security measure to protect your phone line from being accidentally accessed by a neighbor's cordless phone. Secur-Loc activates automatically when your cordless handset is placed into its base.

Rechargeable Handset Battery Information

NOTE: Before using your new Cobra *Intenna* cordless telephone for the first time, you must charge the battery overnight (at least 12 hours) for optimum long-life conditioning of the nickel-cadmium rechargeable handset battery.

BATTERY RECHARGING

When your cordless handset battery needs recharging, the following alerts will remind you to immediately return the handset to the base for recharging (this normally requires at least 12 hours of continuous charging):

1. The LOBAT indicator in the display will flash.
2. A warning (2 beeps every 15 seconds) will sound while you are using the phone. This indicates you have only a few minutes of battery power remaining to complete your conversation before the phone disconnects.
3. When handset has been away from the base and needs recharging, it will beep at 15 second intervals for two minutes. Return handset to base for recharging.

NOTE: The CHARGE indicator will remain on as long as the handset is in the base, even after the batteries are fully recharged. **The batteries will not be damaged if the handset remains in the base continuously;** the charging system is self-adjusting and will never overcharge the batteries.

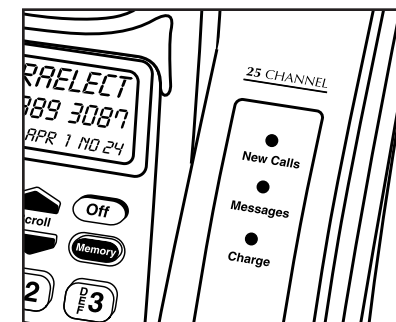
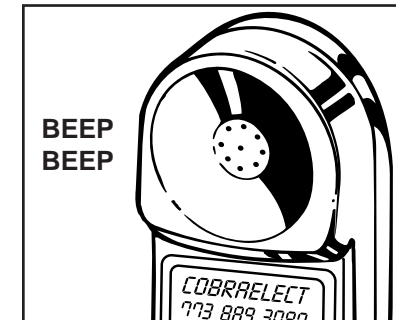
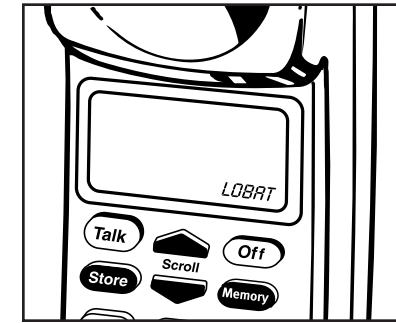

REPLACING THE HANDSET BATTERY

The rechargeable NiCad battery in your cordless phone may need to be replaced if the handset will not function when the TALK button is pressed after recharging for 12 hours.

Replacement batteries are available direct from Cobra (see accessories order form at the end of this booklet or call 1-773-889-3087).

1. To remove the battery door, press and slide downward.
2. Carefully disconnect the battery pack and dispose of it properly. See BATTERY DISPOSAL below.
3. To replace, observe connection orientation and connect the new battery and replace the door. Return the handset to the base and charge the battery overnight (at least 12 hours).

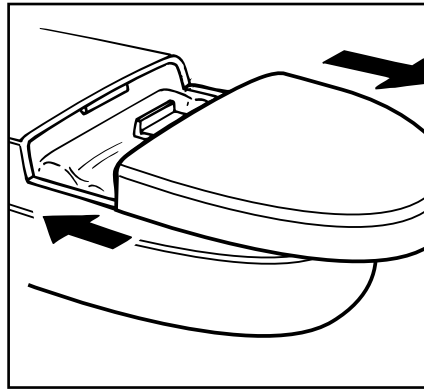

HANDSET BATTERY DISPOSAL

The rechargeable nickel cadmium (NiCad) battery in this product must be recycled or disposed of properly in compliance with all applicable laws. It may not be thrown in the trash. Certain states or municipalities require recycling and have established collection programs. Please contact your local waste removal authority for instructions, or return to Cobra for recycling. Wrap batteries carefully and mail postage prepaid to: **Cobra Electronics Corporation, 6500 W. Cortland Street, Chicago, Illinois 60707, Attn: Battery Recycling.**

Or contact the **Rechargeable Battery Recycling Corporation (RBRC)** at **1-800-8BATTERY** for a local recycling center near you. For more information about battery recycling, the RBRC has a web site at: <http://www.RBRC.com>

DO NOT PUT BATTERIES INTO FIRE OR EXPOSE TO HIGH HEAT. THEY MAY EXPLODE.



CLEANING THE CHARGING CONTACTS

Clean the two metal charging contacts on the base and handset with a soft dry cloth on a regular basis to ensure optimum performance of the battery-charging system. Rubbing alcohol may be used if more thorough cleaning is required.

About Cordless Phone Performance

Your Cobra *Intenna* cordless phone uses radio transmission to communicate between the base and handset. It is thus subject to occasional interference—static or buzzing noises, for example. These conditions may be caused by electrical motors on household appliances, fluorescent lights, electrical storms and other sources.

These steps will enhance the maximum performance of your new phone:

- **Change channels by pressing the CHANNEL button on the handset if you experience interference.**
- **Don't cover the upper section of the cordless handset with your hand** (see diagram below). This may block the internal antenna located at the top of the handset, possibly reducing the phone's range and audio clarity. Always hold the handset at the middle or close to the bottom



INCORRECT



CORRECT

Hold the cordless handset at the middle or bottom area of your phone for best performance and range.

- **Avoid resting the handset on your shoulder** during conversations; this may also block the performance of the internal antenna.
- **Avoid plugging your phone's power cord into an active AC outlet** that also provides power for a major appliance or for charging units a for cordless appliances (vacuums, screwdrivers, etc.) or other electronic devices.

Cordless Telephone Troubleshooting Guide

If your cordless phone does not seem to operate properly, please check the following and refer to the appropriate sections in this booklet for detailed information:

- **The phone is dead; no indicator lights are on:** Are the power adapter and telephone cord connected?
- **Handset beeps during conversations or when away from the base:** The batteries need recharging; return the handset to the base for overnight recharging.
- **Hearing poor audio or added interference during calls:** Don't cover the top section of the handset with your hand or rest the phone on your shoulder. This blocks the special internal Cobra *Intenna* handset antenna.
- **Handset disconnects, loses performance and/or beeps three times when in use away from the base:** You may be out of range or your batteries may need recharging. Move closer to the base and/or recharge batteries.
- **Unable to make a call due to interference:** Select a new channel.
- **Handset won't work after a power outage or after disconnecting phone from AC power and then reconnecting it:** Return the handset to the base for about 15 seconds to automatically match the security coding.
- **Handset seems "dead":** Battery power has run out; return handset to base and charge for at least 12 hours. If handset still seems dead, unplug the handset battery for 15 seconds and plug back in and then place the handset back on the base for at least 5 minutes. Check that charge LED lamp is illuminated.
- **Power Failure Reset:** Power Protector™ Circuitry will preserve the codes set in the handset and base, however, if the battery in the base is low in power, you must return the cordless handset to the base for about 15 seconds. This automatically matches the digital security codes.
- **Caller ID does not work properly:** Make sure you have subscribed to Caller ID service from your telephone company. Check to see if messages shown in the display correspond with those on page 10.
- **Caller ID works properly but does not display information from a second caller:** Make sure you have subscribed to Call Waiting and confirm that your telephone company provides Caller ID during Call Waiting.

For technical assistance, please call our Automated Help Desk which can assist you by answering the most frequently asked questions about Cobra products.

(773) 889-3087

24 hours a day, 7 days a week.

A Consumer Service Representative can be reached through this same number 8:00 am - 8:00 pm, Monday through Friday, CST.

Technical assistance is also available on-line in the Frequently Asked Question (FAQ) section at www.cobraelec.com or by e-mail to productinfo@cobraelec.com

IF YOU THINK YOU NEED SERVICE CALL 1-773-889-3087

"If your product should require factory service please call Cobra first before sending your unit in. This will ensure the fastest turn-around time on your repair."

You may be asked to send your unit to the Cobra factory. It will be necessary to furnish the following in order to have the product serviced and returned.

1. For Warranty Repair include some form of proof-of-purchase, such as a mechanical reproduction or carbon or a sales receipt. If you send the original receipt it cannot be returned.
2. Send the entire product. For example—must include base, handset, cords and power adapter furnished with the product.
3. Enclose a description of what is happening with the unit. Include a typed or clearly printed name and address of where the unit is to be returned.
4. Pack unit securely to prevent damage in transit. If possible, use the original packing material.
5. Ship prepaid and insured by way of a traceable carrier; such as United Parcel Service (UPS) or First Class Mail; to avoid loss in transit to Cobra Factory Service, Cobra Electronics Corporation, 6500 W. Cortland St., Chicago, IL 60707.
6. If the unit is in warranty, upon receipt of your unit it will either be repaired or exchanged depending on the model. Please allow approximately 3 to 4 weeks before contacting us for status. If the unit is out of warranty a letter will automatically be sent informing you of the repair charge or replacement charge. If you have any questions, please call 1-773-889-3087 for assistance.

REGISTERED WITH THE FCC

Please note: This cordless telephone operates under part 15 and part 68 of FCC rules. Operation is subject to two conditions: 1) It may not interfere with radio communications, and 2) It must accept any interference received, including that which may cause undesirable operation. See the Operational Features section of this booklet for ways to reduce interference.

Your telephone company is required by the Federal Communications Commission to allow you to connect FCC registered telephones to their lines.

The FCC requires you to provide information, if requested by the local telephone company, about the connection of an FCC registered telephone to their lines. They may ask you for the FCC registration number and ringer equivalence number (REN), both of which are on the bottom of the base. They may also ask for the Universal Service Order Code (USOC) number which is RJ-11C. It is illegal to use this phone on a party line or to connect it to a coin-operated telephone.

Limited One-Year Warranty

COBRA ELECTRONICS CORPORATION warrants that its COBRA cordless telephone products, and the component parts thereof, will be free of defects in workmanship and materials for period of one (1) year from the date of first consumer purchase. This warranty may be enforced by the first consumer purchaser provided that the product is utilized within the U.S.A.

Cobra will, without charge, repair or replace, at its option, defective cordless telephone products or component parts upon delivery to the Cobra factory Service Department, accompanied by proof of the date of first consumer purchase, such as a duplicated copy of a sales receipt.

You must pay any initial shipping charges required to ship the product for warranty service. The return charges will be at Cobra's expense if the product is repaired or replaced under warranty. For further details concerning procedures for obtaining service, see the "If You Think You Need Service" section of this Owner's Manual.

Exclusions: This limited warranty does not apply 1) to any product damaged by accident, improper line voltage or weather related circumstances; 2) in the event of misuse or abuse of the product or as a result of unauthorized alterations or repairs; 3) to non-defective original equipment Nickel Cadmium rechargeable batteries; 4) if the serial number has been altered, defaced or removed; or 5) if the owner of the product resides outside the U.S.A.

All implied warranties, including warranties of merchantability and fitness for a particular purpose, are limited in duration to the length of this warranty.

Cobra shall not be liable for any incidental, consequential or other damages, including, without limitation, damages resulting from loss of use or cost of installation.

Some states do not allow limitations on how long an implied warranty lasts and/or do not allow the exclusion or limitation of incidental or consequential damages, so the above limitations may not apply to you.

This limited warranty gives you specific legal rights, and you may also have other rights which vary from state to state.

COBRA ELECTRONICS CORPORATION

6500 W. Cortland Street
Chicago, Illinois 60707

Notes:

In addition to its exclusive series of *Intenna* cordless telephones and answering systems, Cobra is also one of America's leading brands of CB radios and accessories, and Safety Alert® radar/laser detectors.

Notes:

Cobra Cordless Phone Accessories

Description	Part No.	Cost Ea.	X Qty.	= Amount
Nickel-Cadmium Battery Pack Assembly with Connector For use with model CP-2525	213-013-9-001	\$15.00		
AC Power Adapter For use with model CP-2525	768-026-N-001	\$15.00		

(Prices subject to change without notice)

** Illinois residents add 7%
 ** Cook Co. residents add .75% (7.75% total)
 ** Chicago residents add 1% (8.75% total)
 ** Indiana residents add 5%
 ** Michigan residents add 4 %
 ** Minnesota residents add 6%
 ** Ohio residents add 6%
 ** Wisconsin residents add 5%

Amount _____
 (Tax if applicable) _____
 Shipping/handling **\$3.75** _____
 Total _____

Make check or money order (no stamps) payable to:
 Cobra Accessories Dept.
 6500 W. Cortland St., Chicago, IL 60707
 Call 1-773-889-3087 or FAX 1-773-622-2269 (for credit card orders)

Allow 4 to 6 weeks for delivery. Offer valid in Continental U.S. only.

Please print clearly:

Name _____
Address (Not P.O. Box) _____
City _____ State _____ Zip _____
Credit Card No. _____ Exp. Date _____
Customer Signature _____
Circle One: Visa MasterCard Discover

Free Manuals Download Website

<http://myh66.com>

<http://usermanuals.us>

<http://www.somanuals.com>

<http://www.4manuals.cc>

<http://www.manual-lib.com>

<http://www.404manual.com>

<http://www.luxmanual.com>

<http://aubethermostatmanual.com>

Golf course search by state

<http://golfingnear.com>

Email search by domain

<http://emailbydomain.com>

Auto manuals search

<http://auto.somanuals.com>

TV manuals search

<http://tv.somanuals.com>