

Cobra®

Cobra Electronics Corporation
6500 West Cortland Street
Chicago, IL 60707

Cobra® CP-9125

FCC Information Included Accessories

If You Think You Need Service

For technical assistance, please call our Automated Help Desk which can assist you by answering the most frequently asked questions about Cobra products.
(773) 889-3087
24 hours a day, 7 days a week.
A Consumer Service Representative can be reached through this same number 8:00 am - 8:00 pm, Monday through Friday, CST.
Technical assistance is also available on-line in the Frequently Asked Questions (FAQ) section at www.cobraelec.com or by e-mail to productinfo@cobraelec.com

If you think you need service call 1.773.889.3087

"If your product should require factory service please call Cobra first before sending your unit in. This will ensure the fastest turn-around time on your repair."

You may be asked to send your unit to the Cobra factory. It will be necessary to furnish the following in order to have the product serviced and returned.

1. For Warranty Repair include some form of proof-of-purchase, such as a mechanical reproduction or carbon or a sales receipt. If you send the original receipt it cannot be returned.
2. Send the entire product.
3. Enclose a description of what is happening with the unit. Include a typed or clearly print name and address of where the unit is to be returned.
4. Pack unit securely to prevent damage in transit. If possible, use the original packing material.
5. Ship prepaid and insured by way of a traceable carrier such as United Parcel Service (UPS) or First Class Mail to avoid loss in transit to: Cobra Factory Service, Cobra Electronics Corporation, 6500 W. Cortland St., Chicago, IL 60707.
6. If the unit is in warranty, upon receipt of your unit it will either be repaired or exchanged depending on the model. Please allow approximately 3 to 4 weeks before contacting us for status. If the unit is out of warranty a letter will automatically be sent informing you of the repair charge or replacement charge. If you have any questions, please call 1.773.889.3087 for assistance.

Cobra Electronics Corp. © 1998
Printed in China
Part No. 480-282-P-001

Operating Instructions for your Cobra CP-9125

Private Call® 900

900 MHz Cordless Telephone



"Ingenious Products for Easier Communication."

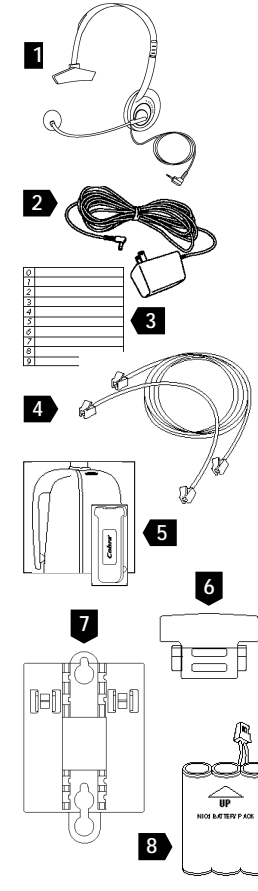

Registered with The FCC

Please note: This cordless phone operates under part 15 and part 68 of FCC rules.

Operation is subject to two conditions:

1. It may not interfere with radio communications, and 2. It must accept any interference received, including that which may cause undesirable operation. See the Operational Features section of this manual for ways to reduce interference.

Changes or modifications not expressly approved by the party responsible for compliance could void the user's authority to operate this equipment.

NOTE: This equipment has been tested and found to comply with the limits for a Class B digital device, pursuant to Part 15 of the FCC Rules. The limits are designed to provide reasonable protection against harmful interference in a residential installation. This equipment generates, uses and can radiate radio frequency energy and, if not installed and used in accordance with the instructions, may cause harmful interference to radio communications. However, there is no guarantee that interference will not occur in a particular installation. If this equipment does cause harmful interference to radio or television reception, which can be determined by turning the equipment off and on, the user is encouraged to try to correct the interference by one of the following measures:

- Reorient or relocate the receiving antenna.
- Increase the separation between the equipment and receiver.
- Connect the equipment into an outlet on a circuit different from that to which the receiver is connected.
- Consult the dealer or an experienced radio/TV technician for help.

Your telephone company is required by the Federal Communications Commission to allow you to connect FCC registered telephones to their lines.

The FCC requires you to provide information, if requested by the local telephone company, about the connection of an FCC registered telephone to their lines. They may ask you for the FCC registration number and ringer equivalence number (REN), both of which are on the bottom of the base. They may also ask for the Universal Service Order Code (USOC) number which is RJ-11C. It is illegal to use this phone on a party line or to connect it to a coin-operated telephone.

The REN is used to determine the quantity of devices you may connect to the telephone line. Excessive RENs on the telephone line may result in the devices not ringing in response to an incoming call. In most areas, the sum of RENs should not exceed 5.0. To be sure, contact the local telephone company.

If your equipment causes harm to the telephone network, the telephone company will notify you in advance (if possible) of a temporary discontinuance of service. Also, you will be advised of your right to file a complaint with the FCC.

The telephone company may make changes in its facilities, equipment or procedures that could affect the operation of your equipment. The telephone company will provide advance notice to help you maintain uninterrupted service.

What's Included with Your CP-9125

1. Headset
2. AC/DC Power Adapter
3. Memory Label
4. Line Cords (6" and 6')
5. Belt Clip
6. Belt Clip Slot Cover
7. Wall Mount Bracket
8. Handset Battery

A1

Controls and Indicators

Our Thanks to You

Base:

- 1. Line Jack
- 2. Power In Jack
- 3. Ringer On/Off Switch
- 4. Tone/Pulse Switch
- 5. Redial/Pause Button
- 6. Flash Button
- 7. Mute Button
- 8. Memory Button
- 9. Charge Indicator
- 10. Intercom Indicator
- 11. In Use Indicator
- 12. Power On/Off Indicator
- 13. Hold Button
- 14. Intercom Page/Find Button
- 15. Speakerphone Button

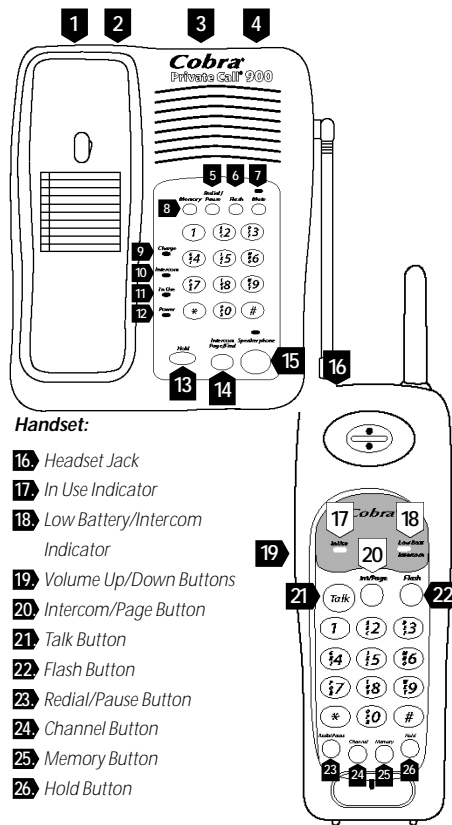

Handset:

- 16. Headset Jack
- 17. In Use Indicator
- 18. Low Battery/Intercom Indicator
- 19. Volume Up/Down Buttons
- 20. Intercom/Page Button
- 21. Talk Button
- 22. Flash Button
- 23. Redial/Pause Button
- 24. Channel Button
- 25. Memory Button
- 26. Hold Button

Thank you for purchasing the Cobra CP-9125 cordless phone. Properly used, this Cobra product will give you many years of reliable service.

Customer Support

Should you encounter any problems with the product or not understand its many features, please refer to this owner's manual. If, after referring to the manual, you still need help, call Cobra Customer Service at 773.889.3087.

Cobra Customer Service

Live operators are available
M-F 8:00 am - 8:00 pm CST at:
773.889.3087. Automated
Technical Assistance available
by phone 24 hours a day, seven
days a week.

E-mail questions to:
productinfo@cobraelec.com

Cobra on the World Wide Web:
Frequently Asked Questions
(FAQ) can be found on-line at:
www.cobraelec.com

A2

A3

How to Use Your Cobra CP-9125 900 MHz Cordless Telephone

Contents

Features 1

FCC Information/Included Accesories A1

Controls & Indicators A2

Our Thanks to You A3

Customer Support

Important Safety Instructions 2

Installation

Quick Set-Up Guide..... 4

Wall Mounting Instructions..... 8

Operating Your CP-9125

Answering Calls From The Handset..... 10

Answering Calls From The Base..... 12

Placing Calls From The Handset..... 14

Placing Calls From The Base..... 15

Channel Selection..... 16

Flash..... 17

Secur-Loc™ 17

4 Level Volume Control..... 18

Hearing Aid Compatibility..... 18

Mute..... 19

Last Number Instant Redial..... 20

Last Number Delay Redial..... 21

Memory Number Storage..... 22

Memory Number Dialing..... 24

To Find The Handset..... 25

Intercom Mode From The Handset..... 26

Intercom Mode From The Base..... 27

Hold Button..... 29

Ringer Switch..... 30

Tone/Pulse..... 30

Handset Battery Recharging..... 31

Private Call® Scrambling..... 32

Battery Saver..... 33

Replacing Handset Battery 34

Disposal of The Battery..... 35

Headset Operation/Belt Clip/Slot Cover..... 36

Cleaning The Charging Contacts..... 37

Troubleshooting 38

Frequently Asked Questions 39

Limited One-Year Warranty 43

Accessories and Order Form 44

If You Think You Need Service Back Cover

Features of This Product

- Private Call™ Voice Scrambling - Base and Handset
- Headset for Hands Free Operation
- 900 MHz Extended Range
- Detachable Belt Clip
- 30 Channel Autoscan
- Clear Call® PLUS Compander
- Ten (10) Number Memory
- Handset Volume Control
- Page/Find
- Mute Button
- Fourteen (14) Day Stand-By
- Wall Mountable
- Last Number Redial
- Hearing Aid Compatible
- Auto Answer
- Auto Stand-By
- Audible Battery Low Indicator
- Replaceable Handset Battery
- Secur-Loc™ 65,000 Security Codes
- Base Speaker Phone
- Base Keypad
- Intercom
- Hold on Base and Handset

Important Safety Instructions

When using your telephone equipment, basic safety precautions should always be followed to reduce the risk of fire, electric shock and injury to persons, including the following:

1. Read and understand all instructions.
2. Follow all warnings and instructions marked on the product.
3. Unplug this product from the wall outlet before cleaning. Do not use liquid cleaners or aerosol cleaners. Use a damp cloth for cleaning.
4. Do not locate base unit near water, for example, near a bath tub, wash bowl, kitchen sink, or laundry tub, in a wet basement or near a swimming pool.
5. Do not place this product on an unstable cart, stand or table. The product may fall, causing serious damage to the product.
6. Slots and openings in the cabinet and the bottom or back are provided for ventilation, to protect it from overheating; these openings must not be blocked or covered. The openings should never be blocked by placing the product in the bed, sofa, rug or other similar surface. This product should never be placed near or over a radiator or heat register. This product should not be placed in a built-in installation unless proper ventilation is provided.
7. This product should be operated only from the type of power source indicated on the marking label. If you are not sure of the type of power supply to your home, consult your dealer or local power company.
8. Do not allow anything to rest on the power cord. Do not locate this product where the cord will be abused by persons walking on it.
9. Do not overload outlets and extension cords as this can result in the risk of fire or electric shock.
10. Never push objects of any kind into this product through cabinet slots as they may touch dangerous voltage points or short out parts that could result in a risk of fire or electric shock. Never spill liquid of any kind on the product.
11. To reduce the risk of electric shock, do not disassemble this product, but take it to qualified servicemen when service or repair work is required. Opening or removing covers may expose you to dangerous voltages or other risks. Incorrect reassembly can cause electric shock when the appliance is subsequently used.
12. Avoid using telephones (other than a cordless type) during an electrical storm. There may be a remote risk of electric shock from lightning.
13. Do not use the telephone to report a gas leak in the vicinity of the leak.
14. Unplug this product from the outlet and refer servicing to qualified service personnel under the following conditions:
 - A. When the power supply cord or plug is damaged or frayed.
 - B. If liquid has been spilled into the product.
 - C. If the product has been exposed to rain or water.
 - D. If the product does not operate normally by following the operating instructions. Adjust only those controls that are covered by the operating instructions because improper adjustment of other controls may result in damage and will often require extensive work by a qualified technician to restore the product to normal operation.

2

Important Safety Instructions

- E. If the product has been dropped or the cabinet has been damaged.
- F. If the product exhibits a distinct change in performance.
15. Never install telephone wiring during a lightning storm.
16. Never install telephone jacks in wet locations unless jack is specifically designed for wet locations.
17. Never touch uninsulated telephone wires or terminals unless the telephone line has been disconnected at the network interface.

CAUTION:

To reduce the risk of fire or injury to persons, read and follow these instructions:

- A. Use only the battery pack supplied with the unit or identical replacement.
- B. Do not dispose of battery pack in a fire. The cells may explode. Check with local codes for possible disposal instruction.
- C. Since released electrolyte is corrosive and may cause damage to eyes or skin and may be toxic if swallowed:
 - C1. Do not open or mutilate battery pack.
 - C2. Always replace the entire battery pack rather than reusing one or more cells.
 - C3. Do not expose batteries to heat or flame.
- D. Exercise care in handling the battery pack in order not to "short" the battery contacts with conducting materials such as rings, bracelets, and keys. The battery or conductor may overheat and cause burns.
- E. Charge the battery provided with or identified for use with this product only in accordance with the instructions and limitations specified in this manual.
- F. Observe proper polarity orientation between the battery and battery charger.

Save These Instructions



3

Installation

Installation

Quick Set-Up Guide

Quick Set-Up Guide

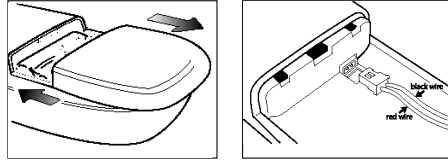

- 1 Install Ni-Cad battery in the handset. To remove the battery door, press and slide downward.

Observe connection orientation, connect the battery and replace the door. The *Low Batt* indicator will blink until the handset is placed in the base and power is applied to the base.

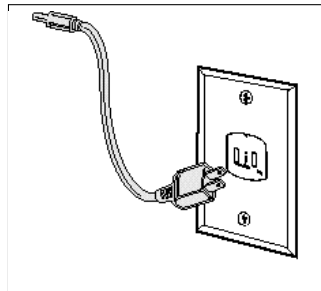

- 2 Connect power adapter in outlet.

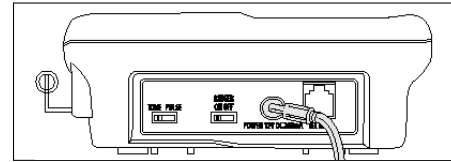

- 3 Connect round connector into power jack on base. *In Use* indicator on base will flash rapidly.



- 4 Place handset on base so *Charge* indicator lights. *In Use* indicator will stop flashing.
- 5 Raise antenna to vertical position.

Note
The battery must be charged at least 12 hours before use.
Replacement batteries are available direct from Cobra. See Accessories section on page 44.

Use only with Class 2 Power Source 12 VDC 500mA

continued

4

5

Installation

Installation

Quick Set - Up Guide

Quick Set-Up Guide *continued*

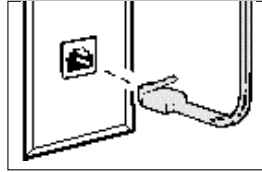

5 Plug 6' phone cord into wall jack.

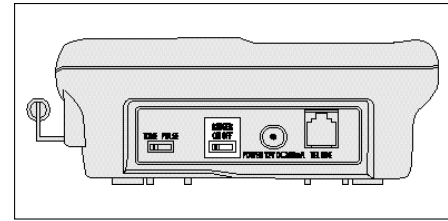

7 Turn on RINGER switch.

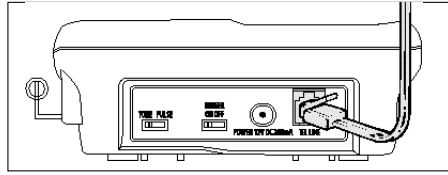

6 Plug phone cord into jack on rear of base.

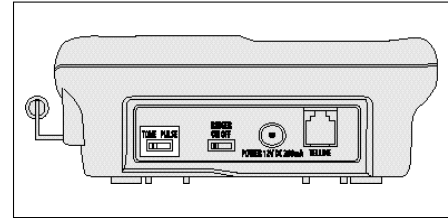

8 Switch TONE/PULSE on base for proper operation.

For tone dialing - switch TONE/PULSE on base to TONE.

For pulse dialing - switch TONE/PULSE on base to PULSE.

Note
Charge batteries for 12 hours before first use.

6

7

Installation

Installation

Wall Mounting Instructions

Wall Mounting Instructions

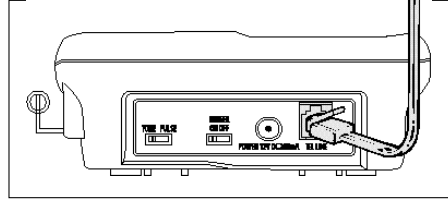

1 Plug 6" phone cord into jack on rear of base.

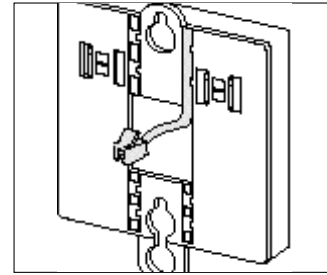

3 Thread cord through slot in wall mount bracket.

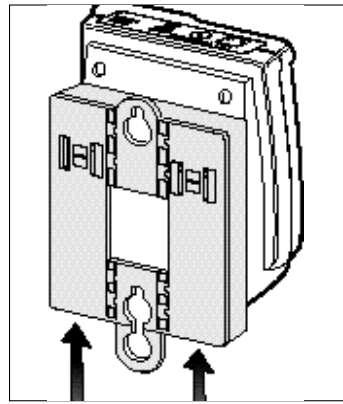

2 Slide wall mount bracket onto base.

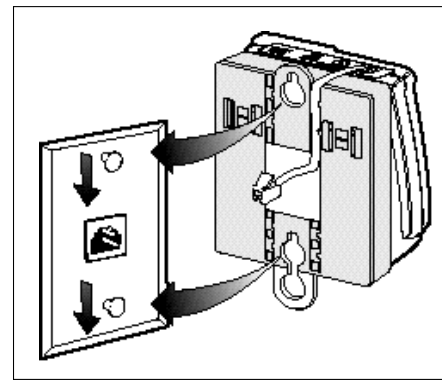

4 Plug phone cord into wall jack.

5 Slide base down on wall plate.

6 Raise antenna to vertical position.

Note

If you do not have a wall mount, contact your local phone company for installation of phone line and wall mount.

8

9

Operation

Operation

Answering Calls From The Handset

Answering Calls From The Handset

To answer a call while handset is away from the base:

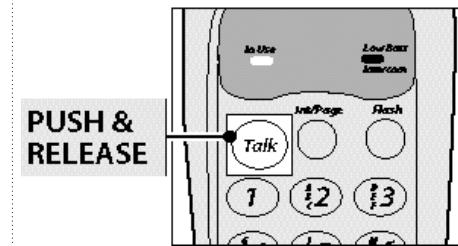

- 1 Push and release button.
- 2 Talk.

When call is completed:



Return handset to base or push and release the button.

Phone automatically disconnects.

To answer a call while handset is in base:

- 1 Pick up handset. Phone will automatically answer incoming call.
- 2 When call is completed:

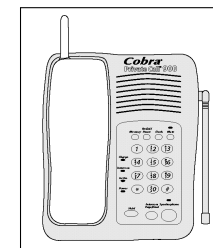

Return handset to base or push and release the button.

Phone automatically disconnects.

Note

When answering a call, the LED will illuminate. It will be displayed on both the handset and the base during the duration of the call.

Operation

Operation

Answering Calls From The Base

Answering Calls From The Base
To answer a call on the base, use the Speakerphone feature:

Note
When answering a call, the  LED will illuminate. It will be displayed on both the handset and the base during the duration of the call.



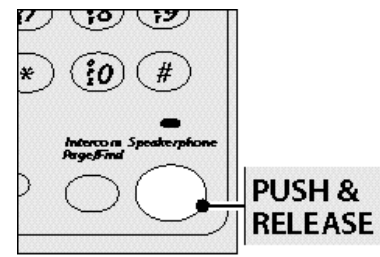

1  LED will flash.

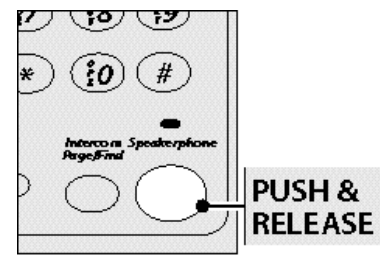

2 Push and release  button.
3 Talk.

When call is completed:



4 Push and release  button.

Phone will automatically disconnect.

Note
You can only end the call from the base by pushing and releasing the  button.

Operation

Placing Calls From The Handset

Note

If you have pulse phone service, use the  button to change from pulse to tone dialing after dialing the number and receiving a response.

Placing Calls From The Handset

- 1 Pick up handset:

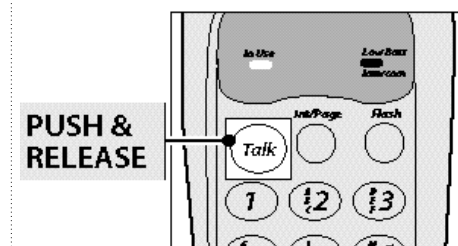

- 2 Push and release  button.
- 3 Wait for dial tone and then place your call.

14

Operation

Placing Calls From The Base

Placing Calls From The Base

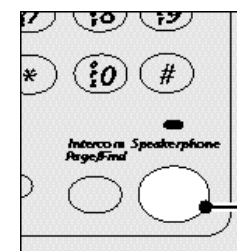

- 1 Push and release  button.
- 2 Wait for dial tone and place your call from the base keypad.

15

Operation

Operation

Channel Selection

Note

Please also refer to questions 3, 5 and 6 in the Frequently Asked Questions section on page 39 for more information about interference.

Channel Selection

Should you experience interference:



Push and release Channel button.

The CP-9125 will scan for and advance to a clearer channel when you *push and release* the Channel button.

- Two double beeps will indicate a successful channel change.
- If three beeps are heard the channel change was not successful. Move closer to base and *press and release* Channel button again.

Flash

handset or base



Push and release FLASH button to interrupt the phone line to access features such as:

- Call Waiting
 - Three Way Calling
- that might be offered by your phone company.

Secur - Loc™

An exclusive security measure to protect your phone from being accessed by another cordless phone. Secur-Loc™ activates automatically every time your handset is placed in the base.

Flash

Secur-Loc™

Operation

4 Level Volume Control

4 Level Volume Control

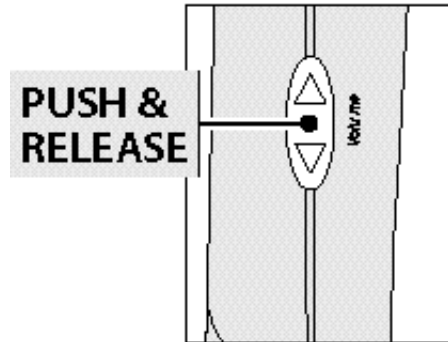

Your CP-9125 has a four level volume control on the side of the handset.

To raise or lower the volume, push the UP arrow for higher volume; push the DOWN arrow for lower volume.

Hearing Aid Compatibility

Hearing Aid Compatibility

The CP-9125 handset is compatible with inductively coupled hearing aids (HAC).

Operation

Mute

Your CP-9125 features a MUTE button on the base. While in a conversation:

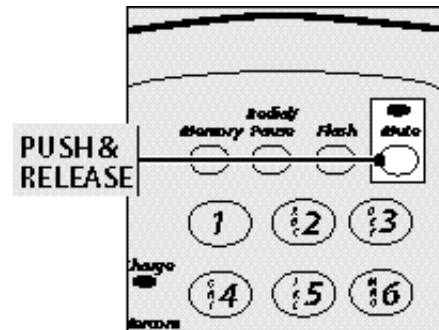

- 1 *Push and release* the MUTE button, which shuts off the base microphone. The *Mute* will illuminate on the base. You will still be able to hear your caller but they will not be able to hear you or a conversation you might be having.
- 2 *Push and release* the MUTE button again to rejoin the conversation. The *Mute* will go off on the base.

Operation

Operation

Last Number Instant Redial

Last Number Instant Redial

Each time you dial a number, that number is stored in the REDIAL memory. Up to 32 digits can be stored. To redial the number after receiving a busy signal:

handset or base



- 1 Push and release FLASH button.
- 2 Listen for dial tone.

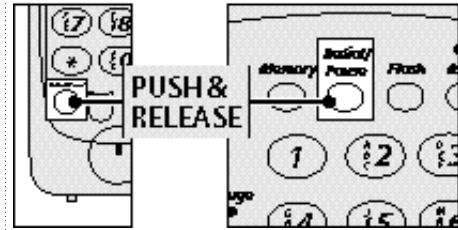

- 3 Push and release REDIAL/PAUSE button.
- 4 The number will be redialed.

20

Last Number Delayed Redial

If steps 1,2 and 3 from the "Last Number Instant Redial" still result in a busy signal, hang up. If you would like to try again in a few minutes, push and release TALK button for dial tone, then:

handset or base



- 3 Push and release REDIAL/PAUSE button.
- 4 The number will be redialed.

Last Number Delayed Redial

21

Operation

Memory Number Storage

Memory Number Storage

The CP-9125 will store up to 10 frequently called numbers.



- 1 Push and release  button once.

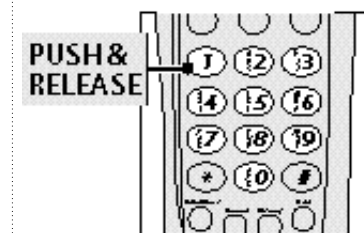

- 2 Enter digits of number to be stored (up to 16).



- 3 Push and release  button again. There will be 2 double beeps.

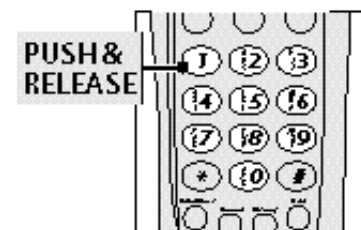

- 4 Assign memory position by entering keypad number from 0 to 9. There will be two quick double beeps to confirm number storage. Repeat for additional numbers to be stored in memory.

Operation

Note

To store numbers from the base follow the same procedure used for the handset.

Note

1. You may also use the  button in memory to temporarily change from pulse to tone dialing.

2. The REDIAL/PAUSE button in memory enters a 3 second delay.

Note

Enter name beside MEMORY number on the memory label provided with the unit.

Operation

Operation

Memory Number Dialing

Memory Number Dialing

- 1 Access the line.



- 2 Push and release  button once.

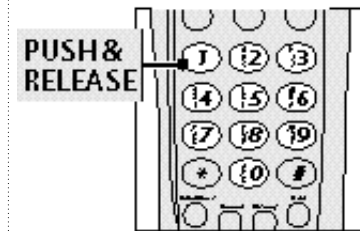

- 3 Push and release keypad number, (0-9), you assigned for that phone number. The phone will dial that number automatically.

Note
Memory dialing from base uses same procedure as handset.

To Find The Handset

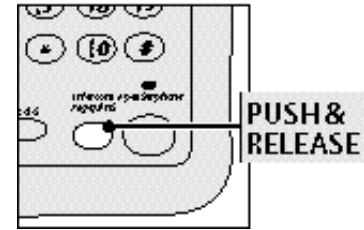

The handset can be located when it's away from the base. To locate the handset:

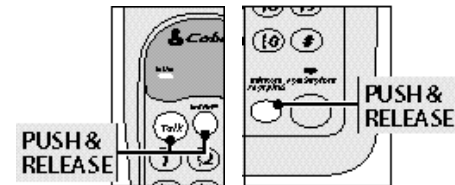

- 1 Push and release  button.

The handset will beep for 30 seconds, allowing time to locate the handset.



- 2 If you wish to stop beep tones push and release  or  buttons, wait 2 seconds, push and release again or, push and release  button on base.

To Find The Handset

Operation

Intercom Mode From The Handset

Note
Intercom may be initiated from either the handset or the base.

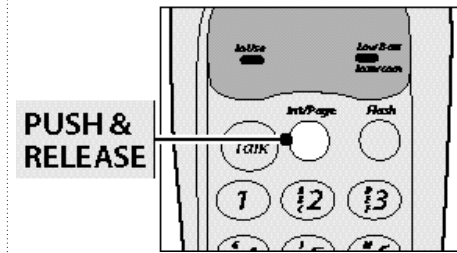

Intercom Mode From The Handset

Your CP-9125 can serve as an intercom between the base and the handset. To utilize this feature:

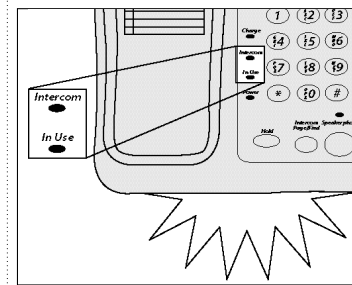

- 1 Push and release  button. The  LED will illuminate.





- 2 The  and  LED will light on the base. Four beeps will emit from the base.
- 3 Begin talking.

Operation

Intercom Mode From The Base

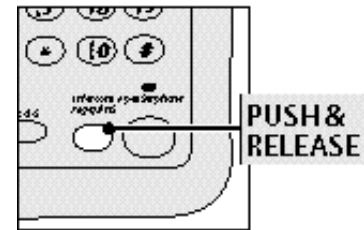

Intercom Mode From The Base

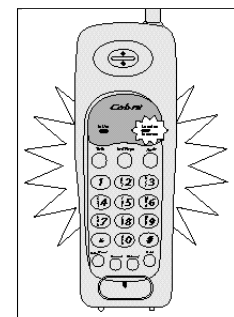

- 1 Push and release  button. The  LED will flash on the base.



- 2 The  LED will flash and the handset will beep.

Note
To initiate INTERCOM while on a call, push and release  button. Then push and release  button.
Proceed following INTERCOM instructions.

Note
Only the handset can end INTERCOM mode. Push and release  button to end.

Operation

Intercom Mode From The Base *continued*

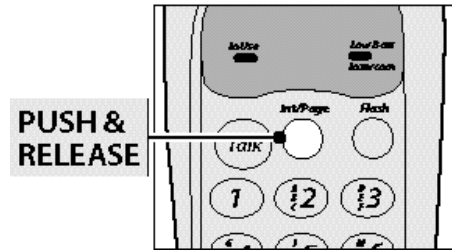

- 3 The person using the handset should *push and release* the ^{Int/Prge} button.
- 4 Begin talking.

Operation

Hold Button On The Base

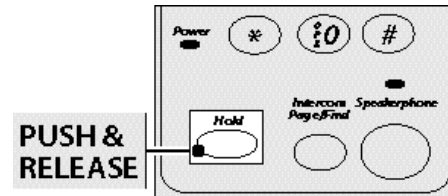

- 1 *Push and release* ^{Hold} button to put a party on hold or to prevent them from hearing you. The ^{Speakerphone} LED on base will blink.
- 2 To release HOLD *push and release* the ^{Speakerphone} button or pick up a branch phone, which will automatically disconnect the CP-9125.

Hold Button On The Handset

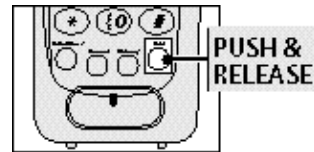

- 1 *Push and release* ^{Hold} button to put a party on hold or to prevent them from hearing you. The ^{In Use} LED on the handset will blink.
- 2 To release HOLD *push and release* ^{Talk} button or pick up a branch phone, which will automatically disconnect the CP-9125.

Hold Button On The Base

Note

When party is on hold, the ^{In Use} LED will be illuminated on the base.

Hold Button On The Handset

Operation

Operation

Ringer Switch

Ringer Switch

OFF/ON switch (on base) controls the handset ringer.

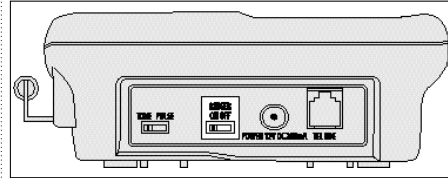

When set on OFF, no ring will sound.

Note

When ringer switch is off you can detect an incoming call by the flashing IN USE LED on the handset or on the base.

Tone/Pulse

Tone/Pulse

The CP-9125 can be used either as tone or pulse, depending upon your phone service.

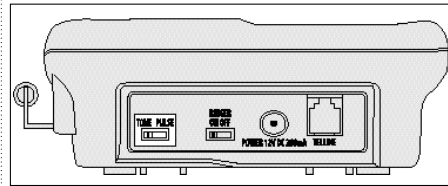

Handset Battery Recharging

When the handset battery needs recharging:

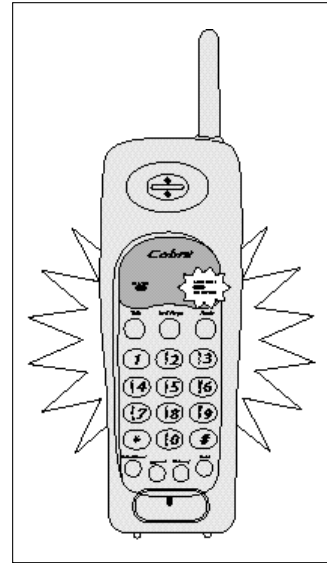

Low Bat on handset will flash and 2 beeps will be heard every 30 seconds for 2 minutes. Return to base for recharging. Handset will shut off at the end of the 2 minute period, terminating a conversation if the handset is in TALK mode.

Handset Battery Recharging

Note

Replacement batteries are available from Cobra. See Accessories section on page 44.

Operation

Operation

**Private Call®
Voice Scrambling**

Private Call® Voice Scrambling
Private Call® prevents other cordless phones or scanners from understanding your conversations.

Battery Saver
Handset may, in OFF position, remain away from base for up to 14 days.

Duration of battery charge depends upon actual use of phone.

Battery Saver

Operation

Replacing Handset Batteries

Note

Replacement batteries are available direct from Cobra. See Accessories section on page 44.

Replacing Handset Batteries

The rechargeable NiCad battery in your cordless phone may need to be replaced if the handset will not function when the TALK button is pressed after recharging for 12 hours.

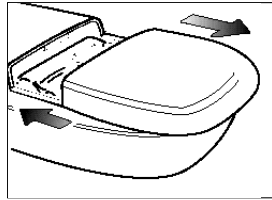

- 1 To remove the battery door, press and slide downward.
- 2 Carefully disconnect the battery pack and dispose of it properly. See Battery Disposal below.
- 3 To replace, observe connection orientation and connect the new battery and replace the door. Return the handset to the base and charge the battery overnight (at least 12 hours).

34

Operation

Handset Battery Disposal

Handset Battery Disposal

The rechargeable nickel cadmium (NiCad) battery in this product must be recycled or disposed of properly in compliance with all applicable laws. It may not be thrown in the trash. Certain states or municipalities require recycling and have established collection programs. Please contact your local waste removal authority for instructions, or return to Cobra for recycling. Wrap batteries carefully and mail postage prepaid to: **Cobra Electronics Corporation, 6500 W. Cortland Street, Chicago, Illinois 60707, Attn: Battery Recycling.**

Or contact the **Rechargeable Battery Recycling Corporation (RBRC)** at 1-800-8BATTERY for a local recycling center near you. For more information about battery recycling, the RBRC has a web site at: <http://www.RBRC.com>

DO NOT PUT BATTERIES INTO FIRE OR EXPOSE TO HIGH HEAT. THEY MAY EXPLODE.

35

Operation

Headset Operation

To Remove The Belt Clip And Install The Slot Cover

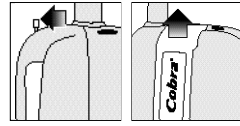

1. Push the belt clip lock tab as shown.
2. Pull the belt clip up and out of the handset.

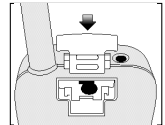

3. Put the slot cover in the slot and press down.

Headset Operation

- 1 The headset jack allows use of a headset with an earpiece and boom microphone.

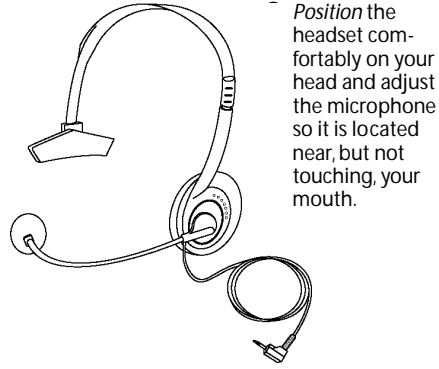

Position the headset comfortably on your head and adjust the microphone so it is located near, but not touching, your mouth.

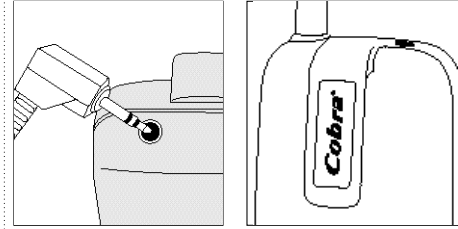

- 2 Plug the headset into the CP-9125 handset.
- 3 Use the belt clip for convenience.

Operation

Cleaning The Charging Contacts

Clean the two metal charging contacts on both base and handset with a soft dry cloth on a regular basis.

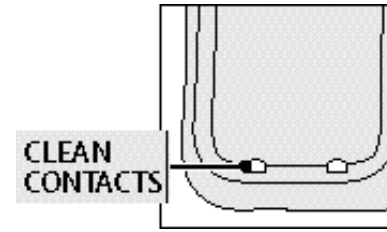

- 1 Clean base contacts.

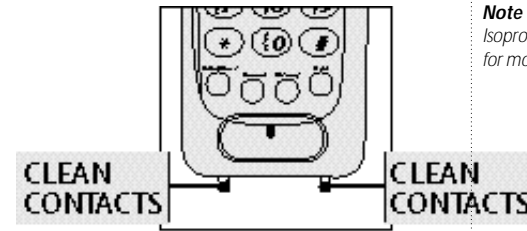

- 2 Clean handset contacts.

Note
Isopropyl alcohol may be used for more thorough cleaning.

Cobra Customer Service

773.889.3087
24 hours a day,
seven days a week

Troubleshooting

Phone is dead

Are power adapter and phone cord connected?

Handset beeps during call or a way from base
Batteries need recharging; return handset to base.

Handset disconnects, loses performance and beeps three times when in use a way from base
Out of range or batteries need recharging. Move closer to base or recharge batteries.

Unable to make call because of interference
Move closer to the base, access the line, select a new channel, and try moving back to your previous location.

Handset won't work after power outage or disconnecting from AC power & reconnecting
Return handset to base for thirty seconds to automatically match security coding.

Handset seems "dead"
Battery power has run out; return handset to base and charge for at least 12 hours. If handset still seems dead, unplug handset battery for 15 seconds and plug back in. Then place handset back on base for at least 5 minutes.

Memory dialing not working
Batteries need recharging; return handset to base. Re-enter memory numbers.

38

Frequently Asked Questions

1. How long should the handset battery be charged?

Typically leaving the handset on the base overnight will charge the battery sufficiently.

2. How long can a battery last after a twelve hour charge?

After a twelve hour charge, the handset has typically 8 hours of continuous talk time, or 14 days in standby mode (when the phone is out of the base but not in use).

3. What is the range of my cordless phone?

There is no way to easily answer this question as many factors affect the range of a cordless phone. In an open field, under ideal conditions, a 900 MHz cordless phone can have an effective range of about 1200 feet.

Unfortunately, most cordless phones are used under conditions that are anything but ideal. The effective range of a cordless phone varies because of environmental and other conditions. Cordless phones and other 900 MHz devices may cause interference which may limit the effective range of your cordless phone. Changing the channel may help.

Aluminum siding can also have a dramatic effect on range. Try using your cordless phone in many locations in and around your home. Each situation presents different conditions under which the phone must work.

Cobra Customer Service

Live operators are available
M-F 8:00 am - 8:00 pm CST at:
773.889.3087. Automated
Technical Assistance available
by phone 24 hours a day, seven
days a week.

E-mail questions to:
productinfo@cobraelec.com

Cobra on the World Wide Web:
Frequently Asked Questions
(FAQ) can be found on-line at:
www.cobraelec.com

39

Frequently Asked Questions

4. Why do I sometimes have difficulty making a connection even though I'm close to the base?

There are several possible causes for this condition. Please try the following solutions to see where your problem lies.

First, make sure the base unit power adapter is connected to a working AC outlet. Make sure that you are within range of the base unit when pressing the TALK button. If this works, then you were trying to access the base from too great a distance. Other cordless phones in your house could be causing interference. Two or more cordless phones may interfere with each other's security codes. If you have two or more cordless phones in your house please disconnect all but the phone which is giving you the Out of Range signal. You can then reset the security codes by using the following procedure.

To reset the security code, remove the handset from the base. Remove the power cord from the base for 30 seconds. Replace the power cord to the base and replace the handset, making sure the charge light comes on. Wait another 30 seconds and the security code should be reset. Try the phone after resetting the security code—it should work fine. Your other cordless phones can still be used but they should be moved further apart or you may experience this problem again.

40

Frequently Asked Questions

5. Why do I have static on my cordless phone?

Your cordless phone works as a miniature radio transmitter and receiver. As such, it will pick up stray signals caused by other nearby appliances which emit radio signals and thus become a source of interference.

Some sources in a home that may cause noise and interference on a cordless phone are:

- other cordless phones
- fluorescent fixtures
- home appliances such as televisions, refrigerators, microwave ovens, home computers and baby monitors

In order to eliminate some of this interference it may be necessary to relocate the base unit of the cordless phone to a different location in your house. This solves two problems. First, you are further from the source of interference and secondly the power adapter for the cordless phone will be plugged into an outlet, which most likely is on a different line than the appliance which is causing the interference.

If the noise persists after relocating the base, move closer to the base unit when talking on the phone. If the noise disappears, then it is most likely local interference being generated by a source outside your home, or a source inside your home strong enough to blanket your entire house such as a baby monitor. If you find that the noise and interference are equally strong throughout your house, your cordless phone may require service.

Cobra Customer Service

Live operators are available
M-F 8:00 am - 8:00 pm CST at:
773.889.3087

Automated Technical Assistance
available 24 hours a day, seven
days a week. E-mail questions to:
productinfo@cobraelec.com

Cobra on the World Wide Web:
Frequently Asked Questions (FAQ)
can be found on-line at:
www.cobraelec.com

41

Frequently Asked Questions

6. Will more than one cordless phone work in the house?

Whether or not you are able to use two or more cordless phones in your house varies, depending on how many cordless phones you have in your house and how close the cordless phones are to each other. Problems you could experience include:

- intermittent ringing
- cross talk
- interference
- inability of the handset to access the base

Changing the channel on one phone may help. Relocating one of the bases may also help.

7. How can I find a replacement battery?

Batteries are typically available locally at Radio Shack, Walmart, K-Mart or anywhere cordless phone accessories are sold. You must match the voltage, milliamp hours (mAH) and the connector of your current battery exactly to the new one to ensure proper operation of your cordless phone. You should take the original battery with you to the store to match these features. Or order the battery from Cobra.

Limited One Year Warranty

Cobra warrants that its cordless telephone products, and the component parts thereof, will be free from defects in workmanship and materials for a period of one (1) year from the date of first consumer purchase. This warranty may be enforced by the first consumer purchaser, provided that the product is utilized within the U.S.A.

Cobra, without charge, will repair, or replace, at its option, defective cordless telephone products or component parts upon delivery to Cobra factory Service Department, accompanied by proof of the date of first consumer purchase, such as a duplicated copy of a sales receipt.

You must pay any initial shipping charges required to ship the product for warranty service. The return charges will be at Cobra's expense if the product is repaired or replaced under warranty.

Exclusions: This limited warranty does not apply 1) to any product damaged by accident, improper line voltage or weather related circumstances; 2) in the event of misuse or abuse of the product or as a result of unauthorized alterations or repairs; 3) to non-defective original equipment Nickel Cadmium rechargeable batteries; 4) if the serial number has been altered, defaced or removed; or 5) if the owner of the product resides outside of the U.S.A.

All implied warranties, including warranties of merchantability and fitness for a particular purpose, are limited in duration to the length of this warranty.

Cobra shall not be liable for any incidental, consequential or other damages, including, without limitation, damages resulting from loss of use or cost of installation.

Some states do not allow limitations on how long an implied warranty lasts and/or do not allow the exclusion or limitation of incidental or consequential damages, so the above limitations may not apply to you.

This limited warranty gives you specific legal rights, and you may also have other rights which vary from state to state.

Cobra Electronics Corporation

6500 West Cortland Street
Chicago, Illinois 60707

Accessory Order Form

Accessories

Nickel-Cadmium Battery Pack Assembly with Connector

For use with model CP-9125
213-021-N-001 \$15.00

AC Power Adapter

For use with model CP-9125
768-032-N-001 \$15.00

Charge Cradle

For use with model CP-9125
CR-900 \$10.00

Headset

For use with model CP-9125
H-900 \$25.00

Part #	Description	Cost Ea.	Qty.	Amount
213-021-N-001	Nickel-Cadmium Battery Pack w/Connector	\$15.00		
768-032-N-001	AC Power Adapter	\$15.00		
CR-900	Charge Cradle	\$10.00		
H-900	Headset	\$25.00		

Prices subject to change without notice.	Amount	
	(Tax if applicable)	
	Shipping/handling	\$4.00
	Total	

Tax Table
 Illinois residents add 7%
 Cook Co. residents add .75% (7.75% total)
 Chicago residents add 1% (8.75% total)

Indiana residents add 5%
 Michigan residents add 4%
 Minnesota residents add 6%
 Ohio residents add 6%
 Wisconsin residents add 5%

For credit card orders fill out order form and fax to: 1.773.622.2269 or call 1.773.889.3087 (Press 1 from the main menu) 8:00 am - 8:00 pm, M-F, CST.

Make check or money order (no stamps) payable to: Cobra Accessories Dept. 6500 West Cortland St. Chicago, IL 60707

Please print clearly

Name _____

Address (No P.O. Box) _____

City _____ State _____

Zip _____

Telephone (____) _____

Credit Card No. _____ Exp. Date _____

Customer Signature _____

Circle One: Visa MasterCard Discover

Allow 4 to 6 weeks for delivery. Offer valid in Continental U.S. only.

Free Manuals Download Website

<http://myh66.com>

<http://usermanuals.us>

<http://www.somanuals.com>

<http://www.4manuals.cc>

<http://www.manual-lib.com>

<http://www.404manual.com>

<http://www.luxmanual.com>

<http://aubethermostatmanual.com>

Golf course search by state

<http://golfingnear.com>

Email search by domain

<http://emailbydomain.com>

Auto manuals search

<http://auto.somanuals.com>

TV manuals search

<http://tv.somanuals.com>