



Propane Catalytic Heater

INSTRUCTIONS FOR USE

U.S. Patent 6,213,761
© 2005 The Coleman Company, Inc.
www.coleman.com

IMPORTANT

Read this manual carefully before assembling, using or servicing this heater. Keep this manual for future reference. If you have questions about assembly, operation, servicing or repair of this heater, please call Coleman at 1-800-835-3278 or TDD: 316-832-8707. In Canada call 1-800-387-6161.



Model 5035
Propane Series



CAN1-11.3-M79 Camp Heater

Contents

General Safety Information
To Set Up
To Light
To Turn Off
To Store
Things You Should Know
Replacement Parts List
Warranty

General Safety Information

FOR YOUR SAFETY

If you smell gas:

1. Do not attempt to light appliance.
2. Extinguish any open flame.
3. Disconnect from fuel supply.



FOR YOUR SAFETY

Do not store or use gasoline or other liquids with flammable vapors in the vicinity of this or any other appliance.

Warning

THIS APPLIANCE CONSUMES AIR

- **When used in any inside area, provide a fresh air opening of at least six square inches (39 square centimeters).**
- **Never operate the heater while sleeping.**
- **Do not use other burning appliances inside.**

This manual contains important information about the assembly, operation and maintenance of this heater. General safety information is presented in these first few pages and is also located throughout the manual. Particular attention should be paid to information accompanied by the safety alert symbol “ DANGER”, “ WARNING”, “ CAUTION”.

Keep this manual for future reference and to educate new users of this product. This manual should be read in conjunction with the labeling on the product.

Safety precautions are essential when any mechanical or propane fueled equipment is involved. These precautions are necessary when using, storing, and servicing. Using this equipment with the respect and caution demanded will reduce the possibilities of personal injury or property damage.

The following symbols shown below are used extensively throughout this manual. Always heed these precautions, as they are essential when using any mechanical or propane fueled equipment.

DANGER

DANGER indicates an imminently hazardous situation which, if not avoided, will result in death or serious injury.

WARNING

WARNING indicates a potentially hazardous situation which, if not avoided, could result in death or serious injury.

CAUTION

CAUTION indicates a potentially hazardous situation which, if not avoided, may result in minor or moderate personal injury, or property damage.

General Safety Information *cont.*



DANGER

Failure to comply with the precautions and instructions provided with this heater can result in death, serious bodily injury and property loss or damage from hazards of fire, explosion, burn and/or asphyxiation.

Only persons who can understand and follow the instructions should use or service this heater.



DANGER



• EXPLOSION - FIRE HAZARD

- Never store propane near high heat, open flames, pilot lights, direct sunlight, other ignition sources or where temperatures exceed 120 degrees F (49°C).
- Propane is heavier than air and can accumulate in low places. If you smell gas, leave the area immediately.
- Never install or remove propane tank while catalytic heater is lighted, near flame, pilot lights, other ignition sources or while catalytic heater is hot to touch.
- During operation, this product can be a source of ignition. Never use the catalytic heater in spaces that contain or may contain volatile or airborne combustibles, or products such as gasoline, solvents, paint thinner, dust particles or unknown chemicals. Minimum clearances from combustible materials: 24 inches.
- Provide adequate clearances around air openings into the combustion chamber.



WARNING

We cannot foresee every use which may be made of our products. **Check with your local fire safety authority if you have questions about use.**

Other standards govern the use of fuel gases and heat producing products for specific uses. Your local authorities can advise you about these.

- Never refill disposable cylinders.
- Use the preset regulator that came with the catalytic heater. Do not attempt to adjust.



WARNING

- This product is fueled by propane gas. Propane gas is invisible, odorless, and flammable. An odorant is normally added to help detect leaks and can be described as a "rotten egg" smell. The odorant can fade over time so leaking gas is not always detectable by smell alone.
- Propane gas is heavier than air and leaking propane will sink to the lowest level possible. It can ignite by ignition sources including matches, lighters, sparks or open flames of any kind many feet away from the original leak. Use only propane gas set up for vapor withdrawal.
- Propane gas should be stored or used in compliance with local ordinances and codes or with ANSI/NFPA 58. Turn off propane when not in use.

CALIFORNIA PROPOSITION 65:

WARNING: This fuel, and byproducts of combustion of this fuel, contain chemicals known to the state of California to cause cancer, birth defects, or other reproductive harm.



WARNING



• BURN HAZARD

- Never leave catalytic heater unattended when hot or in use.
- Keep out of reach of children.



CAUTION

• SERVICE SAFETY

- Keep all connections and fittings clean. Inspect propane cylinder and catalytic heater propane connections for damage before attaching.
- During set up, check all connections and fittings for leaks using soapy water. Never use a flame. Bubbles indicate a leak. Check that the connection is not cross-threaded and that it is tight. Perform another leak check. If there is still a leak, remove the cylinder and contact Coleman for service or repairs.
- Use as a heating appliance only. Never alter in any way or use with any device or part not specifically designed and sold for this product.

To Set Up

NOTE: Use 16.4 oz disposable propane cylinders only. Do not connect to bulk propane systems. The LP-gas cylinder(s) used with catalytic heaters must be constructed and marked in accordance with the specifications for LP-gas cylinders of the U.S. Department of Transportation or *Transport Canada, CAN/CSA B339*.

■ Features identified are Burner, Heater Valve, Base, and Ignition Button (Electronic Ignition only). Propane tank is not included.

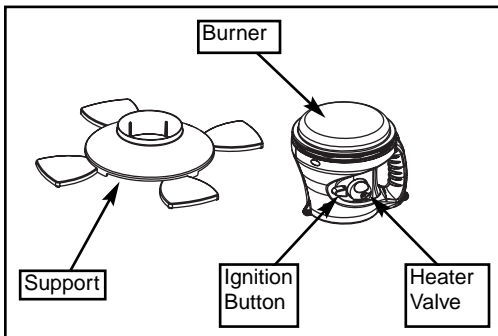

CAUTION

• SERVICE SAFETY

- Keep all connections and fittings clean. Inspect propane cylinder and heater propane connections for damage before attaching.
- During set up, check all connections and fittings for leaks using soapy water. Bubbles indicate a leak. Never use a flame.

■ Turn HEATER VALVE to OFF.

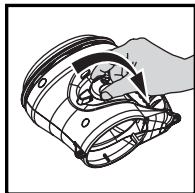

■ Attach CYLINDER to HEATER outdoors.

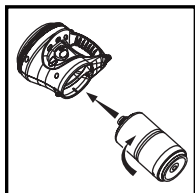

■ Rotate four Support Legs into operating position.

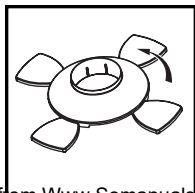

■ Firmly place cylinder into support.

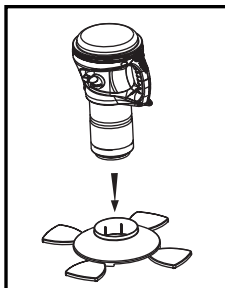

■ Position HEATER as shown on flat surface.

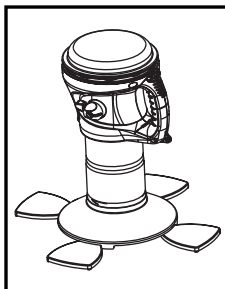

To Light

DANGER



• EXPLOSION - FIRE HAZARD

- Propane is heavier than air and can accumulate in low places. If you smell gas, leave the area immediately.
- Always attach or detach propane source outdoors; never while heater is lighted, near flame, pilot lights, other ignition sources or while heater is hot to touch.
- This heater is red hot during use and can ignite flammables too close to the burner. Keep flammables at least 24 inches from the sides and 24 inches from the top of the heater. Keep gasoline and other flammable liquids and vapors well away from heater.

WARNING



• BURN HAZARD

- Never leave heater unattended when hot or in use.
- Keep out of reach of children.

To Light *cont*

Electronic Ignition

- Hold heater with both hands at a 45° angle, pointing away from yourself and others.
- Turn valve to ON position and repeatedly push red ignition button until heater ignites.
- Heater will ignite with a brief visible flame after 10-12 seconds.
- Place Heater on a flat surface.
- Heater is not adjustable.

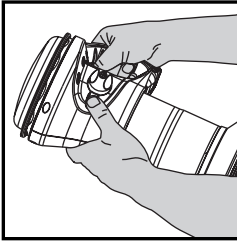
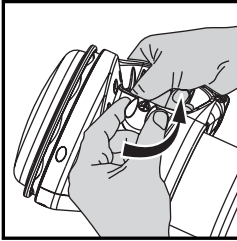

Match Light

- Hold match as shown.
- Turn valve to ON position.
- Heater will ignite with a brief visible flame after 10-12 seconds.
- Heater is not adjustable.



■ NOTE: Observe heat build up for a few minutes to ensure heater is lit. If heater fails to develop substantial heat, turn heater "OFF" and repeat lighting procedure.



To Turn Off

- Turn FUEL VALVE to OFF.
- Allow HEATER to cool for 10-15 minutes.



To Store



DANGER



• EXPLOSION - FIRE HAZARD

- Never store propane near high heat, open flames, pilot lights, direct sunlight, other ignition sources or where temperatures exceed 120 degrees F (49°C).

To Store *cont*

- Make sure Heater is cool.
- Take unit outdoors away from any ignition sources. Remove Cylinder from Heater.
- Replace plastic cap on cylinder.
- Store propane cylinder consistent with the instructions and warnings on the cylinder.

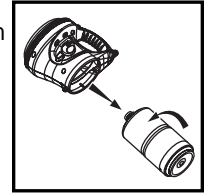

Things You Should Know

1. This is a catalytic heater. Burning occurs within the pad at a lower temperature than a normal flame due to evenly distributed platinum. But, heat guard and burner rim still get hot enough to burn you. Be careful.
2. The catalytic process takes approximately 10 minutes to reach full heat output.
3. Do not use heater for cooking or warming items, this can destroy combustion and catalyst. This heater has a low burn temperature (no flame) but it can still burn clothing, sleeping bags, etc., that might fall on the burner surface.
4. To avoid damage to the catalyst, do not allow head pad to come in contact with or around silicone based hand creams, paints, etc.
5. Do not touch the gray ceramic fiber head pad or poke a hole into it.
6. Do not attempt cleaning the head assembly.

7. For repair service call one of the numbers listed below for location of your nearest Coleman Service Center. If heater must be mailed to Service Center, attach your name, address, and a description of problem to product and send to Service Center either by UPS or Parcel Post **insured** with **shipping** and **insurance** prepaid. *Do not mail propane cylinders.* If necessary to write the Service Center or factory, refer to your heater by model number.

8. If not completely satisfied with performance of this product, please call one of the numbers listed below.

9. As with any new heating appliance, a small amount of smoke may be seen during the initial operation as a result of residual manufacturing oils being heated. This is normal. Coleman suggests the owner operate the heater for 30 minutes when first purchased. This will also familiarize the owner with all the features of the heater.

The Coleman Company, Inc.
3600 N. Hydraulic
Wichita, KS 67219 U.S.A.
1-800-835-3278
TDD: 316-832-8707

Sunbeam Corporation (Canada) Limited
5975 Falbourne Street
Mississauga, Ontario
Canada L5R 3V8
1 800 387-6161

www.coleman.com

Replacement Parts List

No.	Part No.	Description
1	5035-5401	Support
2	5035-1491	Control Knob & screw

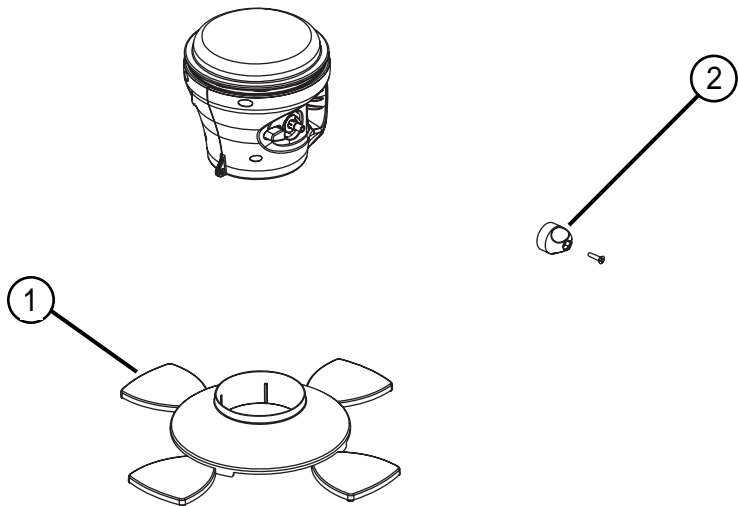

Limited Five Year Warranty

The Coleman Company, Inc. ("Coleman") warrants that for a period of five years from the date of original retail purchase, this product will be free from defects in material and workmanship. Coleman, at its option, will repair or replace this product or any component of the product found to be defective during the warranty period. Replacement will be made with a new or remanufactured product or component. If the product is no longer available, replacement may be made with a similar product of equal or greater value. This is your exclusive warranty.

This warranty is valid for the original retail purchaser from the date of initial retail purchase and is not transferable. Keep the original sales receipt. Proof of purchase is required to obtain warranty performance. Coleman dealers, service centers, or retail stores selling Coleman® products do not have the right to alter, modify or in any way change the terms and conditions of this warranty.

What This Warranty Does Not Cover

This warranty does not cover normal wear of parts, parts that are not genuine Coleman® parts, or damage resulting from any of the following: negligent use or misuse of the product; use on improper voltage or current; commercial use of the product; use contrary to the operating instructions; disassembly, repair or alteration by anyone other than Coleman or an authorized service center. Further, the warranty does not cover Acts of God, such as fire, flood, hurricanes and tornadoes. Warranty void if damage to product results from the use of a part other than a genuine Coleman® part.

COLEMAN SHALL NOT BE LIABLE FOR DEFECTS THAT ARE CAUSED BY THE USE OF UNAUTHORIZED PARTS OR SERVICE. COLEMAN SHALL NOT BE LIABLE FOR ANY INCIDENTAL OR CONSEQUENTIAL DAMAGES CAUSED BY THE BREACH OF ANY EXPRESS OR IMPLIED WARRANTY OR CONDITIONS. EXCEPT TO THE EXTENT PROHIBITED BY APPLICABLE LAW, ANY IMPLIED WARRANTY OF MERCHANTABILITY OR FITNESS FOR A PARTICULAR PURPOSE IS LIMITED IN DURATION TO THE DURATION OF THE ABOVE WARRANTY OR CONDITIONS. SOME STATES, PROVINCES, OR JURISDICTIONS DO NOT ALLOW THE EXCLUSION OR LIMITATION OF INCIDENTAL OR CONSEQUENTIAL DAMAGES OR LIMITATIONS ON HOW LONG AN IMPLIED WARRANTY LASTS, SO THE ABOVE LIMITATIONS OR

EXCLUSION MAY NOT APPLY TO YOU. THIS WARRANTY GIVES YOU SPECIFIC LEGAL RIGHTS, AND YOU MAY ALSO HAVE OTHER RIGHTS THAT VARY FROM STATE TO STATE OR PROVINCE TO PROVINCE.

How to Obtain Warranty Service

Take the product to an authorized Coleman service center. You can find the nearest authorized Coleman service center by visiting www.coleman.com or calling 1-800-835-3278 or TDD 316-832-8707 in the United States or 1 800 387-6161 in Canada. If a service center is not conveniently located, attach to the product a tag that includes your name, address, daytime telephone number and description of the problem. Include a copy of the original sales receipt. Carefully package the product and send either by UPS or Parcel Post **insured** with shipping and **insurance** prepaid to:

For products purchased in the United States:

The Coleman Company, Inc.
3600 North Hydraulic
Wichita, KS 67219

For products purchased in Canada:

Sunbeam Corporation (Canada) Limited
5975 Falbourne Street
Mississauga, Ontario
Canada L5R 3V8

The costs of transporting the product to Coleman or an authorized service center for warranty service is the responsibility of the purchaser.

Do not mail products with fuel in tanks, or with disposable propane cylinders. Remove glass globes from lanterns and wrap separately.

DO NOT RETURN THIS PRODUCT TO THE PLACE OF PURCHASE.

If you have any questions regarding this warranty please call 1-800-835-3278 or TDD 316-832-8707 in the United States or 1 800 387-6161 in Canada.

Free Manuals Download Website

<http://myh66.com>

<http://usermanuals.us>

<http://www.somanuals.com>

<http://www.4manuals.cc>

<http://www.manual-lib.com>

<http://www.404manual.com>

<http://www.luxmanual.com>

<http://aubethermostatmanual.com>

Golf course search by state

<http://golfingnear.com>

Email search by domain

<http://emailbydomain.com>

Auto manuals search

<http://auto.somanuals.com>

TV manuals search

<http://tv.somanuals.com>