



# Compaq Mini CQ10 Notebook PC and Compaq Mini 102 Notebook PC Maintenance and Service Guide

## **SUMMARY**

This guide is a troubleshooting reference used for maintaining and servicing the computer. It provides comprehensive information on identifying computer features, components, and spare parts; troubleshooting computer problems; and performing computer disassembly procedures.

© Copyright 2010 Hewlett-Packard  
Development Company, L.P.

Bluetooth is a trademark owned by its proprietor and used by Hewlett-Packard Company under license. Intel and Atom are trademarks of Intel Corporation in the U.S. and other countries. Microsoft and Windows are U.S. registered trademarks of Microsoft Corporation. SD Logo is a trademark of its proprietor.

The information contained herein is subject to change without notice. The only warranties for HP products and services are set forth in the express warranty statements accompanying such products and services. Nothing herein should be construed as constituting an additional warranty. HP shall not be liable for technical or editorial errors or omissions contained herein.

First Edition: January 2010

Document Part Number: 602516-001  
Revision A

## Safety Warning Notice

---

- ⚠ **WARNING!** To reduce the possibility of heat-related injuries or of overheating the computer, do not place the computer directly on your lap or obstruct the air vents. Use the computer only on a hard, flat surface. Do not allow another hard surface, such as an adjoining optional printer, or a soft surface, such as pillows or rugs or clothing, to block airflow. Also, do not allow the AC adapter to contact the skin or a soft surface, such as pillows or rugs or clothing, during operation. The computer and the AC adapter comply with the user-accessible surface temperature limits defined by the International Standard for Safety of Information Technology Equipment (IEC 60950).
-



---

# Table of contents

<b>1 Product description .....</b>	<b>1</b>
<b>2 External component identification .....</b>	<b>5</b>
Top components .....	5
TouchPad .....	5
Light .....	6
Keys .....	7
Front components .....	8
Right-side components .....	10
Left-side components .....	11
Display components .....	12
Bottom components .....	13
Wireless antennas .....	14
<b>3 Illustrated parts catalog .....</b>	<b>15</b>
Service tag .....	15
Computer major components .....	16
Display assembly subcomponents .....	21
Mass storage devices .....	23
Miscellaneous parts .....	24
Sequential part number listing .....	25
<b>4 Removal and replacement procedures .....</b>	<b>29</b>
Preliminary replacement requirements .....	29
Tools required .....	29
Service considerations .....	29
Plastic parts .....	29
Cables and connectors .....	29
Drive handling .....	30
Grounding guidelines .....	31
Electrostatic discharge damage .....	31
Packaging and transporting guidelines .....	32
Workstation guidelines .....	32

Equipment guidelines .....	33
Component replacement procedures .....	34
Service tag .....	34
Computer feet .....	35
Battery .....	36
SIM .....	37
Memory module .....	38
Keyboard .....	40
RTC battery .....	43
Mass storage devices .....	44
Hard drive .....	45
Solid-state drive .....	45
Top cover .....	46
WLAN module .....	49
WWAN module .....	52
USB/audio board .....	54
DC connector/power board .....	55
Fan .....	56
Heat sink assembly .....	58
System board .....	60
Display assembly .....	63

## **5 Computer Setup ..... 70**

Computer Setup in Windows 7 .....	70
Starting the Setup Utility .....	70
Using the Setup Utility .....	70
Changing the language of the Setup Utility .....	70
Navigating and selecting in the Setup Utility .....	71
Displaying system information .....	71
Restoring default settings in the Setup Utility .....	71
Exiting the Setup Utility .....	72
Setup Utility menus .....	72
Main menu .....	72
Security menu .....	72
System Configuration menu .....	72
Diagnostics menu .....	73
Computer Setup in Windows XP .....	74
Starting Setup Utility .....	74
Using Setup Utility .....	74
Changing the language of Setup Utility .....	74
Navigating and selecting in the Setup Utility .....	74
Displaying system information .....	75
Restoring default settings in the Setup Utility .....	75

Exiting the Setup Utility .....	75
Setup Utility menus .....	75
Main menu .....	76
Security menu .....	76
System Configuration menu .....	76
Diagnostics menu .....	77
<b>6 Specifications .....</b>	<b>78</b>
Computer specifications .....	78
25.7-cm (10.1-in), WSVGA, AntiGlare display specifications .....	80
Hard drive specifications .....	81
Solid-state drive specifications .....	82
System resource specifications .....	83
<b>7 Backup and recovery .....</b>	<b>84</b>
Windows 7 backup and recovery .....	85
Backing up and recovering using Roxio BackOnTrack .....	85
Creating a copy of the hard drive .....	86
Performing a recovery .....	86
Using the Disaster Recovery utility .....	86
Downloading and extracting the Disaster Recovery utility .....	87
Restoring your hard drive image .....	87
Using the Instant Restore utility .....	87
Using the Instant Restore utility when the operating system is functioning .....	88
Using the Instant Restore utility when the operating system is not functioning .....	88
Using Windows Backup and Restore .....	88
Using system restore points .....	88
When to create restore points .....	89
Creating a system restore point .....	89
Restoring to a previous date and time .....	89
Backing up and recovering using HP Recovery Manager .....	89
Backing up your information .....	90
Creating a set of recovery discs .....	91
Performing a recovery .....	91
Recovering using the recovery discs .....	92
Recovering using the partition on the hard drive (select models only) .....	92
Windows XP backup and recovery .....	93
Backing up your information .....	93
Performing a recovery .....	94
Recovering your information .....	94
Recovering the operating system and programs .....	94

<b>8 Connector pin assignments .....</b>	<b>96</b>
Audio-out (headphone)/Audio-in (microphone) jack .....	96
External monitor .....	97
RJ-45 (network) .....	98
Universal Serial Bus .....	99
<b>9 Power cord set requirements .....</b>	<b>100</b>
Requirements for all countries and regions .....	100
Requirements for specific countries and regions .....	101
<b>10 Recycling .....</b>	<b>102</b>
Battery .....	102
Display .....	102
<b>Index .....</b>	<b>108</b>



# 1 Product description

Category	Description	Compaq Mini CQ10	Compaq Mini 102
<b>Product name</b>	Compaq Mini CQ10 Notebook PC	✓	
	Compaq Mini 102 Notebook PC		✓
<b>Processor</b>	Intel Atom N270 1.6-GHz processor, 512-KB Level 2 cache, 533-MHz front-side bus (FSB)	✓	✓
<b>Chipset</b>	Northbridge: 945GSE; 533-MHz bus speed	✓	✓
	Southbridge: ICH7M	✓	✓
<b>Graphics</b>	Intel® Graphics Media Accelerator 950	✓	✓
	Universal Memory Architecture (UMA) graphics subsystem	✓	✓
<b>Panels</b>	<b>25.7-cm</b> (10.1-in) WSVGA (1024 × 600) AntiGlare LED	✓	✓
	<b>NOTE:</b> Display assembly includes 1 webcam, 1 microphone, 2 speakers, and 2 wireless local-area network (WLAN) antennas and cables; 2 wireless wide-area network (WWAN) antennas and cables and a 5-band WWAN antenna and cable on select models		
	Wide aspect 16:9 ratio	✓	✓
<b>Memory</b>	DDR2 PC2-6400, 533-MHz memory module	✓	✓
	One customer-accessible/upgradable memory module slot	✓	✓
	Supports the following configurations:		
	• 1024-MB total system memory (1024 × 1)	✓	✓
	• 2048-MB total system memory (2048 × 1)	✓	
	<b>NOTE:</b> The computer is only available with 1 GB of memory, but supports up to 2 GB of single channel memory.		

Category	Description	Compaq Mini CQ10	Compaq Mini 102
<b>Mass storage devices</b>	<b>Hard drive</b>	✓	✓
	• <b>9.5-mm, 6.35-cm</b> (2.50-in)	✓	✓
	• 160 GB, 5400 RPM	✓	✓
	• Serial ATA	✓	✓
	<b>Solid-state drive (SSD)</b>		✓
	<b>NOTE:</b> For use with XP Home Edition only.		
	• 16 GB, <b>6.35 cm</b> (2.5 in)		✓
	• Multi-level cell (MLC) technology		✓
	• Serial ATA		✓
<b>Optical drive</b>	Supports external USB optical drives only	✓	✓
<b>Diskette drive</b>	Supports external USB diskette drives only	✓	✓
<b>Audio/Visual</b>	High-definition (HD) audio	✓	✓
	Integrated 4-Ω, 1.5-W speakers (2)	✓	✓
	Fixed integrated analog microphone	✓	✓
	Fixed VGA webcam, 640 × 480 resolution, <i>f</i> /2.8, up to 30 frames per second	✓	✓
<b>Modem</b>	Supports external USB modems only	✓	✓
<b>Ethernet</b>	Integrated Atheros® AR8132 PCI-E 10/100BASE-T Ethernet controller	✓	✓
<b>Wireless</b>	<b>Integrated wireless local area network (WLAN) and Bluetooth® options by way of optional WLAN module:</b>	✓	✓
	Two WLAN antennas built into display assembly	✓	✓
	Support for the following WLAN formats:		
	• 802.11b/g	✓	✓
	• 802.11b/g/n	✓	✓
	• 802.11b/g with Bluetooth	✓	✓
	Support for No WLAN option	✓	✓
	<b>Integrated wireless wide area network (WWAN) options by way of optional WWAN module:</b>	✓	✓
	Two WWAN antennas built into display assembly	✓	✓
	Support for 5-band WWAN antenna option	✓	✓
	Subscriber identity module (SIM) security (customer-accessible in battery bay)	✓	✓
Support for No WWAN option	✓	✓	

Category	Description	Compaq Mini CQ10	Compaq Mini 102
<b>External media cards</b>	Digital Media Slot with push-push insert/eject port supporting:	✓	✓
	• Memory Stick (MS)		
	• MS/Pro		
	• MultiMediaCard (MMC)		
	• Secure Digital High Capacity (SDHC) memory card		
	• xD-Picture Card		
<b>Internal media cards</b>	Two Mini Card slots:	✓	✓
	• Full-size Mini Card slot		
	• Half-size Mini Card slot		
<b>Ports</b>	Audio-in/out (microphone/stereo headphone) with jack detection	✓	✓
	VGA (D-sub 15) supporting external 1600 × 1200 monitor at 75 Hz and external WUXGA monitor at 60 Hz (hot plug/unplug with auto-detect of standard- or wide-aspect video)	✓	✓
	RJ-45 (Ethernet, includes link and activity lights)	✓	✓
	USB (3)	✓	✓
	3-pin AC power	✓	✓
<b>Keyboard/ pointing device</b>	92% keyboard	✓	✓
	TouchPad, with 2 TouchPad buttons and 2-way scrolling (taps enabled by default)	✓	✓
<b>Power requirements</b>	30-W UMA AC adapter (non-Smart) with localized cable plug support	✓	✓
	AC adapter connector on cable	✓	✓
	6-cell Li-ion battery (55-Wh) 2.55-Ah, 6-hour target life	✓	✓
	3-cell Li-ion battery (28-Wh) 2.55-Ah , 3-hour target life	✓	✓
<b>Security</b>	Support for HP Kensington Security Lock	✓	✓
<b>Operating system</b>	<b>Preinstalled:</b>		
	• Windows XP Home Edition SP3	✓	✓
	• Windows 7 Starter 32	✓	
	• FreeDos		✓

Category	Description	Compaq Mini CQ10	Compaq Mini 102
Serviceability	<b>End-user replaceable parts:</b>		
	AC adapter	✓	✓
	Battery (system)	✓	✓
	Keyboard	✓	✓
	Hard drive	✓	✓
	Solid state drive		✓
	Memory modules	✓	✓

## 2 External component identification

Components included with the computer may vary by region and model. The illustrations in this chapter identify the standard features on most computer models.

### Top components

#### TouchPad

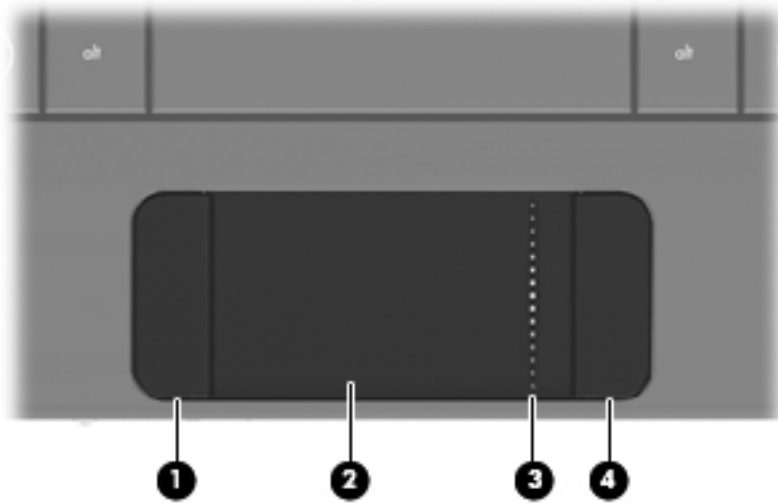

Component	Description
(1) Left TouchPad button*	Functions like the left button on an external mouse.
(2) TouchPad*	Moves the pointer and selects or activates items on the screen.
(3) TouchPad scroll zone	Scrolls up or down.
(4) Right TouchPad button*	Functions like the right button on an external mouse.

\*This table describes factory settings. To view or change pointing device preferences, select **Start > Control Panel > Printers and Other Hardware > Mouse**.



## Light



<b>Component</b>	<b>Description</b>
Caps lock light	On: Caps lock is on.

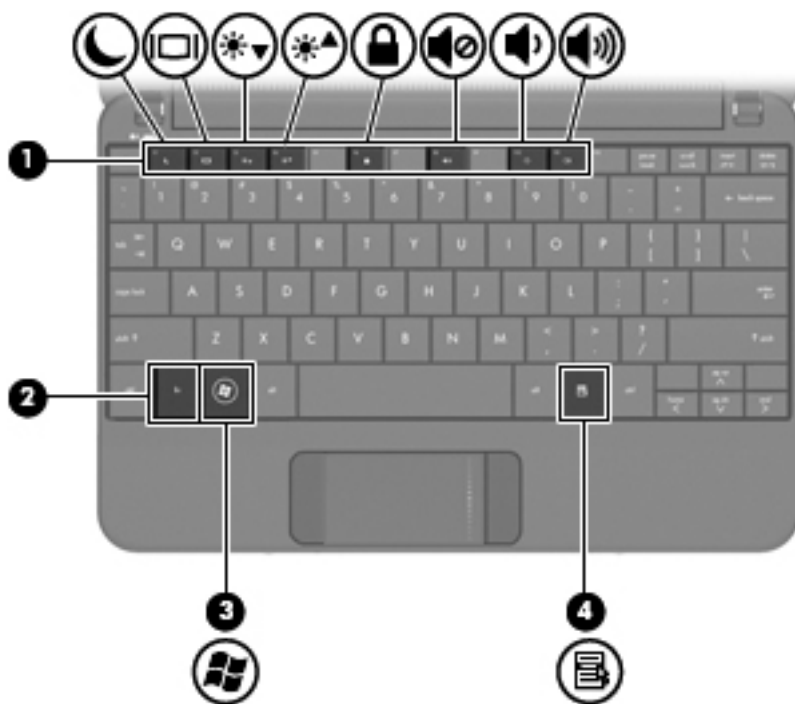

## Keys

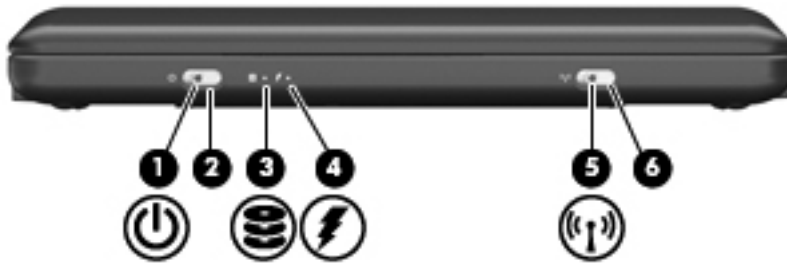

Component	Description
(1) Function keys	Execute frequently used system functions when pressed in combination with the <b>fn</b> key.
(2) <b>fn</b> key	Executes frequently used system functions when pressed in combination with a function key.
(3)  Windows® logo key	Displays the Windows Start menu.
(4)  Windows applications key	Displays a shortcut menu for items beneath the pointer.

# Front components







Component	Description
(1)  Power light	<ul style="list-style-type: none"> <li>• On: The computer is on.</li> <li>• Blinking: The computer is in Standby.</li> <li>• Off: The computer is off or in Hibernation.</li> </ul>
(2) Power switch	<ul style="list-style-type: none"> <li>• When the computer is off, slide the switch to turn on the computer.</li> <li>• When the computer is on, briefly slide the switch to initiate Hibernation.</li> <li>• When the computer is in Standby, briefly slide the switch to exit Standby.</li> <li>• When the computer is in Hibernation, briefly slide the switch to exit Hibernation.</li> </ul> <p>If the computer has stopped responding and Windows shutdown procedures are ineffective, slide and hold the power switch for at least 5 seconds to turn off the computer.</p> <p>To learn more about your power settings, select <b>Start &gt; Control Panel &gt; Performance and Maintenance &gt; Power Options</b>.</p>
(3)  Drive light	Blinking: The hard drive or flash drive is being accessed.
(4)  Battery light	<ul style="list-style-type: none"> <li>• On: A battery is charging.</li> <li>• Blinking: A battery that is the only available power source has reached a low battery level. When the battery reaches a critical battery level, the battery light begins blinking rapidly.</li> <li>• Off: If the computer is plugged into an external power source, the light turns off when all batteries in the computer are fully charged. If the computer is not plugged into an external power source, the light stays off until the battery reaches a low battery level.</li> </ul>

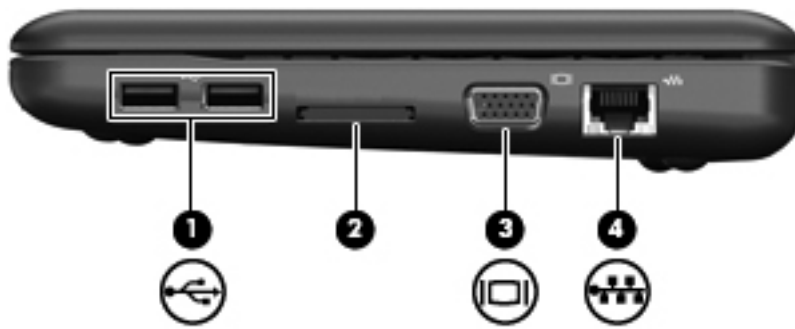

Component	Description
(5)  Wireless light	<ul style="list-style-type: none"><li>• Blue: An integrated wireless device, such as a wireless local area network (WLAN) device, is on.</li><li>• Amber: All wireless devices are off.</li></ul>
(6) Wireless switch	Turns the wireless feature on or off, but does not establish a wireless connection.  <b>NOTE:</b> A wireless network must be set up in order to establish a wireless connection.





## Right-side components

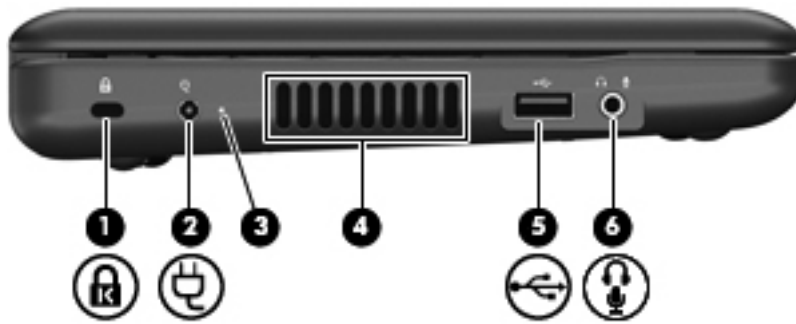

Component	Description
(1)  USB ports (2)	Connect optional USB devices.
(2)  Digital Media Slot	Supports the following optional digital card formats: <ul style="list-style-type: none"><li>• Memory Stick (MS)</li><li>• MS/Pro</li><li>• MultiMediaCard (MMC)</li><li>• Secure Digital High Capacity (SDHC) Memory Card</li><li>• xD-Picture card</li></ul>
(3)  External monitor port	Connects an optional external display, such as a monitor or projector, to the computer.
(4)  RJ-45 (network) jack	Connects a network cable.

## Left-side components



Component	Description
(1)  Security cable slot	Attaches an optional security cable to the computer.  <b>NOTE:</b> The security cable is designed to act as a deterrent, but it may not prevent the computer from being mishandled or stolen.
(2)  Power connector	Connects an AC adapter.
(3) AC adapter light	On: The computer is connected to external power.  Off: The computer is not connected to external power.
(4) Vent	Enables airflow to cool internal components.  <b>NOTE:</b> The computer fan starts up automatically to cool internal components and prevent overheating. It is normal for the internal fan to cycle on and off during routine operation.
(5)  USB port	Connects an optional USB device.
(6)  Audio-out (headphone) jack/Audio-in (microphone) jack	Produces sound when connected to optional powered stereo speakers, headphones, earbuds, a headset, or television audio. Also connects an optional headset microphone.  <b>WARNING!</b> To reduce the risk of personal injury, adjust the volume before putting on headphones, earbuds, or a headset. For additional safety information, refer to the <i>Regulatory, Safety and Environmental Notices</i> .  <b>NOTE:</b> When an audio component is connected to the jack, the computer speakers are disabled.  The audio component cable must have a 4-conductor connector.

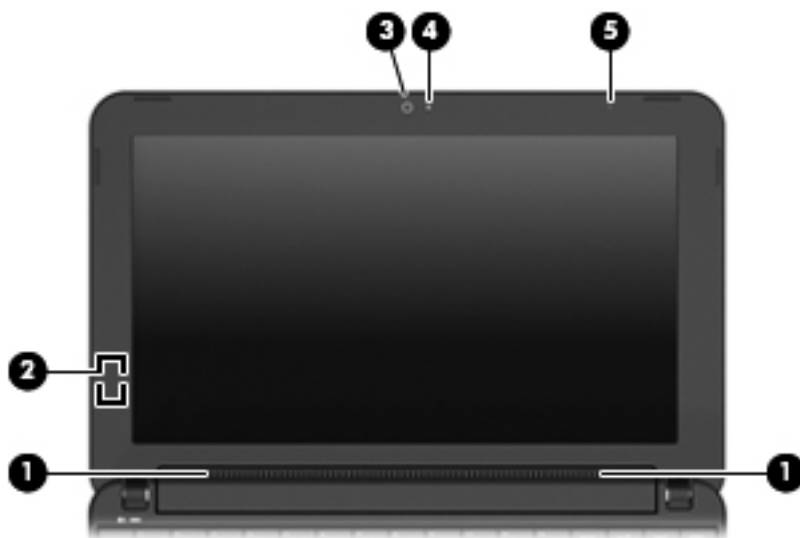

## Display components

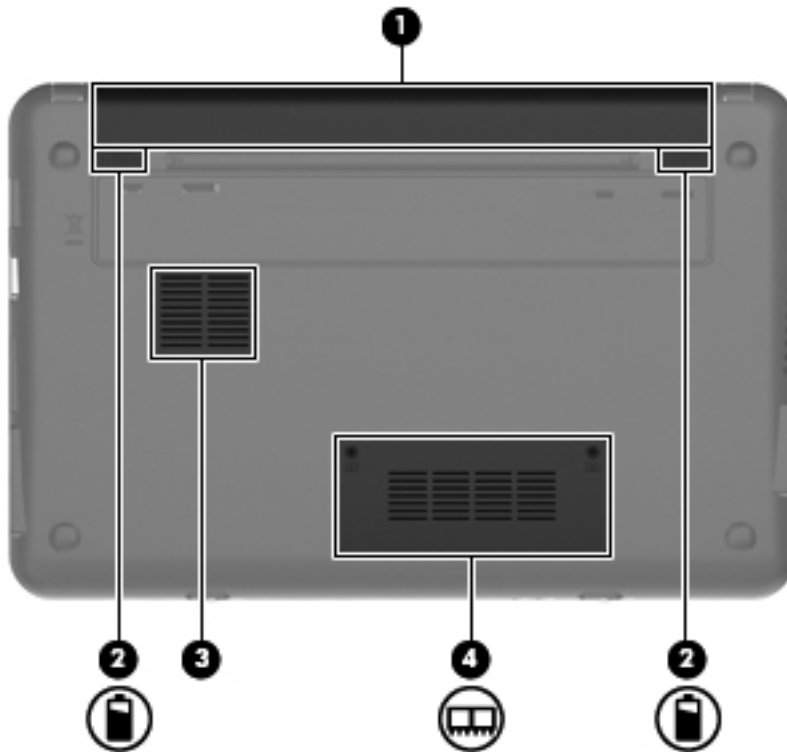

Component	Description
(1) Speakers (2)	Produce sound.
(2) Internal display switch	Turns off the display if the display is closed while the power is on. <b>NOTE:</b> The display switch is not visible from the outside of the computer.
(3) Webcam	Captures still photographs and videos. <b>NOTE:</b> To capture videos, you need to install additional webcam software.
(4) Webcam light	On: The webcam is in use.
(5) Internal microphone	Records sound.

## Bottom components



Component	Description
(1) Battery bay	Holds the battery.
(2)  Battery release latches (2)	Release the battery from the battery bay.
(3) Vent	Enables airflow to cool internal components. <b>NOTE:</b> The computer fan starts up automatically to cool internal components and prevent overheating. It is normal for the internal fan to cycle on and off during routine operation.
(4)  Memory module compartment	Contains the memory module slot.

## Wireless antennas

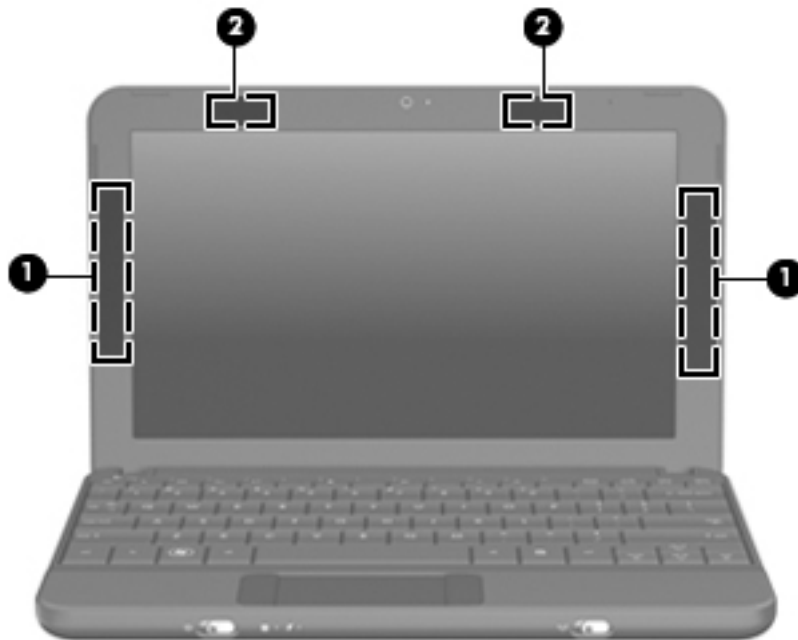

Component	Description
(1) WWAN antennas (2) (select models only)*	Send and receive wireless signals to communicate with wireless wide-area networks (WWANs).
(2) WLAN antennas (2)*	Send and receive wireless signals to communicate with wireless local area networks (WLANs).

\*The antennas are not visible from the outside of the computer. For optimal transmission, keep the areas immediately around the antennas free from obstructions.

To see wireless regulatory notices, refer to the section of the *Regulatory, Safety and Environmental Notices* that applies to your country or region. To access these notices, click **Start > Help and Support > User Guides**.

# 3 Illustrated parts catalog

## Service tag

When ordering parts or requesting information, provide the computer serial number and model description provided on the service tag:

**(1)** Product name: This is the product name affixed to the front of the computer.

**(2)** Serial: This is an alphanumeric identifier that is unique to each product.

**(3)** Product: This number provides specific information about the product's hardware components. The product number, or part number, helps a service technician determine what components and parts are needed.

**(4)** Warranty: This number describes the duration of the warranty period for the computer.

**(5)** Model: This is the alphanumeric identifier used to locate documents, drivers, and support for the computer.

---

 **NOTE:** The Warranty **(4)** and the Model **(5)** fields are excluded on select models.

**NOTE:** The service tag color may be different on select models.

---

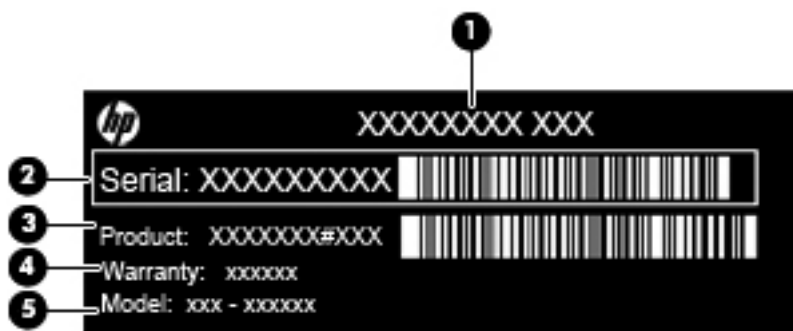

# Computer major components

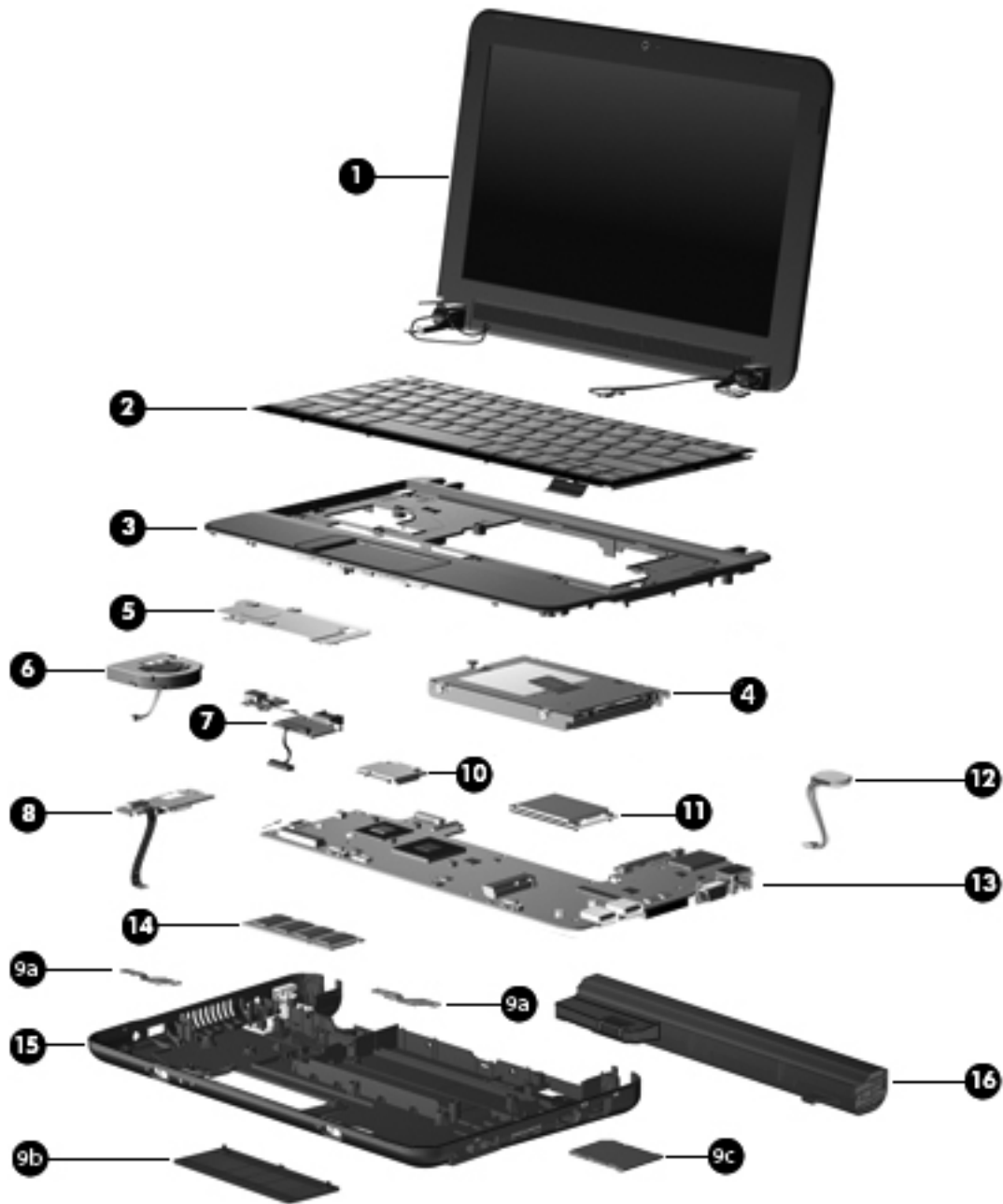

Item	Description	Spare part number
(1)	<p>Display assembly, <b>25.7-cm</b> (10.1-in), WSVGA, AntiGlare</p> <p>(includes 1 webcam, 1 microphone, 2 speakers, and 2 WLAN antennas/cables; WWAN antennas/cables on select models)</p> <p>See <a href="#">Display assembly subcomponents on page 21</a> for a comprehensive list of display assembly components.</p>	594806-001



Item	Description	Spare part number
<b>(2)</b>	Keyboard	
	• For use in Brazil	535689-202
	• For use in the Czech Republic	535689-221
	• For use in Europe	535689-A41
	• For use in Finland, Norway, and Sweden	535689-DH1
	• For use in France	535689-051
	• For use in French Canada	535689-121
	• For use in Germany	535689-041
	• For use in Greece	535689-DJ1
	• For use in Hungary	535689-211
	• For use with international models	535689-B31
	• For use in Israel	535689-BB1
	• For use in Italy	535689-061
	• For use in Latin America	535689-161
	• For use in Portugal	535689-131
	• For use in Russia	535689-251
	• For use in Slovenia	535689-BA1
	• For use in Spain	535689-071
	• For use in Saudi Arabia	535689-171
	• For use in Switzerland	535689-BG1
• For use in Turkey	535689-141	
• For use in the United Kingdom	535689-031	
• For use in the United States	535689-001	
<b>(3)</b>	Top cover with TouchPad	537622-001
<b>(4)</b>	<b>Mass storage devices</b>	
	<b>NOTE:</b> Each hard drive mounts in the computer using a bracket and screws included in the mounting kit.	
	See <a href="#">Mass storage devices on page 44</a> for the mounting kit part number.	
	• Hard drive, 160-GB, 5400-RPM	594809-001
	<b>NOTE:</b> Hard drive mounting kit not detailed.	537641-001
	• Solid state drive, 16 GB	608396-001
<b>(5)</b>	Heat sink assembly (includes replacement thermal material)	537619-001
<b>(6)</b>	Fan	537613-001

<b>Item</b>	<b>Description</b>	<b>Spare part number</b>
<b>(7)</b>	USB/audio board (includes cable)	600124-001
<b>(8)</b>	DC connector/power board	581326-001
	Plastics/actuator kit	537612-001
	Includes the following:	
<b>(9a)</b>	<ul style="list-style-type: none"> <li>Power switch and wireless switch actuators</li> </ul>	
<b>(9b)</b>	<ul style="list-style-type: none"> <li>Memory module compartment cover</li> </ul>	
<b>(9c)</b>	<ul style="list-style-type: none"> <li>Bezel for Digital Media slot</li> </ul>	
<b>(10)</b>	WLAN modules	
	Broadcom 4312G 802.11b/g WiFi and 2070 Bluetooth 2.1+EDR Combo Adapter (BT3.0+HS ready)	575920-001
	Broadcom 43225 802.11b/g/n 2x2 WiFi Adapter	593837-001
	Atheros AR9285 802.11b/g/n 1x1 WiFi Adapter	
	<ul style="list-style-type: none"> <li>For use in Canada, the Cayman Islands, Guam, Puerto Rico, the U.S. Virgin Islands, and the United States</li> </ul>	518436-001
	<ul style="list-style-type: none"> <li>For use in Afghanistan, Albania, Algeria, Andorra, Angola, Antigua and Barbuda, Argentina, Aruba, Australia, Austria, Azerbaijan, the Bahamas, Bahrain, Bangladesh, Barbados, Belarus, Belgium, Belize, Benin, Bermuda, Bhutan, Bolivia, Bosnia and Herzegovina, Botswana, Brazil, the British Virgin Islands, Brunei, Bulgaria, Burkina Faso, Burundi, Cameroon, Cape Verde, the Central African Republic, Chad, Chile, Colombia, Comoros, the Congo, Costa Rica, Croatia, Cyprus, the Czech Republic, Denmark, Djibouti, Dominica, the Dominican Republic, East Timor, Ecuador, Egypt, El Salvador, Equatorial Guinea, Eritrea, Estonia, Ethiopia, Fiji, Finland, France, French Guiana, Gabon, Gambia, Georgia, Germany, Ghana, Gibraltar, Greece, Grenada, Guadeloupe, Guatemala, Guinea, Guinea-Bissau, Guyana, Haiti, Honduras, Hong Kong, Hungary, Iceland, India, Ireland, Israel, Italy, the Ivory Coast, Jamaica, Jordan, Kazakhstan, Kenya, Kiribati, Kyrgyzstan, Laos, Latvia, Lebanon, Lesotho, Liberia, Liechtenstein, Lithuania, Luxembourg, Macedonia, Madagascar, Malawi, Malaysia, the Maldives, Mali, Malta, the Marshall Islands, Martinique, Mauritania, Mauritius, Mexico, Micronesia, Monaco, Mongolia, Montenegro, Morocco, Mozambique, Namibia, Nauru, Nepal, the Nether Antilles, the Netherlands, New Zealand, Nicaragua, Niger, Nigeria, Norway, Oman, Pakistan, Palau, Panama, Papua New Guinea, Paraguay, the People's Republic of China, Peru, the Philippines, Poland, Portugal, the Republic of Moldova, Romania, Russia, Rwanda, Samoa, San Marino, Sao Tome and Principe, Saudi Arabia, Senegal, Serbia, the Seychelles, Sierra Leone, Singapore, Slovakia, Slovenia, the Solomon Islands, Somalia, South Africa, South Korea, Spain, Sri Lanka, St. Kitts and Nevis, St. Lucia, St. Vincent and the Grenadines, Suriname, Swaziland, Sweden, Switzerland, Taiwan, Tajikistan, Tanzania, Togo, Tonga, Trinidad and Tobago, Tunisia, Turkey, Turkmenistan, Tuvalu, Uganda, Ukraine, the United Arab Emirates, the United Kingdom, Uruguay, Uzbekistan, Vanuatu, Venezuela, Vietnam, Yemen, Zaire, Zambia, and Zimbabwe</li> </ul>	518436-002

Item	Description	Spare part number
	Broadcom 4312G 802.11b/g WiFi Adapter	
	<ul style="list-style-type: none"> <li>For use for use in Canada, the Cayman Islands, Guam, Puerto Rico, the United States, and the U.S. Virgin Islands</li> </ul>	504593-003
	<ul style="list-style-type: none"> <li>For use in Afghanistan, Albania, Algeria, Andorra, Angola, Antigua and Barbuda, Argentina, Armenia, Aruba, Australia, Austria, Azerbaijan, the Bahamas, Bahrain, Bangladesh, Barbados, Belarus, Belgium, Belize, Benin, Bermuda, Bhutan, Bolivia, Bosnia and Herzegovina, Botswana, Brazil, the British Virgin Islands, Brunei, Bulgaria, Burkina Faso, Burundi, Cameroon, Cape Verde, the Central African Republic, Chad, Chile, Colombia, Comoros, the Congo, Costa Rica, Croatia, Cyprus, the Czech Republic, Denmark, Djibouti, Dominica, the Dominican Republic, East Timor, Ecuador, Egypt, El Salvador, Equatorial Guinea, Eritrea, Estonia, Ethiopia, Fiji, Finland, France, French Guiana, Gabon, Gambia, Georgia, Germany, Ghana, Gibraltar, Greece, Grenada, Guadeloupe, Guatemala, Guinea, Guinea-Bissau, Guyana, Haiti, Honduras, Hong Kong, Hungary, Iceland, India, Ireland, Israel, Italy, the Ivory Coast, Jamaica, Jordan, Kazakhstan, Kenya, Kiribati, Kyrgyzstan, Laos, Latvia, Lebanon, Lesotho, Liberia, Liechtenstein, Lithuania, Luxembourg, Macedonia, Madagascar, Malawi, Malaysia, the Maldives, Mali, Malta, the Marshall Islands, Martinique, Mauritania, Mauritius, Mexico, Micronesia, Monaco, Mongolia, Montenegro, Morocco, Mozambique, Namibia, Nauru, Nepal, the Nether Antilles, the Netherlands, New Zealand, Nicaragua, Niger, Nigeria, Norway, Oman, Pakistan, Palau, Panama, Papua New Guinea, Paraguay, the People's Republic of China, Peru, the Philippines, Poland, Portugal, the Republic of Moldova, Romania, Russia, Rwanda, Samoa, San Marino, Sao Tome and Principe, Saudi Arabia, Senegal, Serbia, the Seychelles, Sierra Leone, Singapore, Slovakia, Slovenia, the Solomon Islands, Somalia, South Africa, South Korea, Spain, Sri Lanka, St. Kitts and Nevis, St. Lucia, St. Vincent and the Grenadines, Suriname, Swaziland, Sweden, Switzerland, Taiwan, Tajikistan, Tanzania, Togo, Tonga, Trinidad and Tobago, Tunisia, Turkey, Turkmenistan, Tuvalu, Uganda, Ukraine, the United Arab Emirates, the United Kingdom, Uruguay, Uzbekistan, Vanuatu, Venezuela, Vietnam, Yemen, Zaire, Zambia, and Zimbabwe</li> </ul>	504593-004
(11)	WWAN Module, Qualcomm EV-DO/HSPA <b>NOTE:</b> Available as an option.	531993-001
(12)	RTC battery (includes cable and double-sided tape)	537616-001
(13)	System board (includes processor and replacement thermal material)	
	<ul style="list-style-type: none"> <li>Intel Atom N270 1.6-GHz processor, 512-KB Level 2 cache, 533-MHz front-side bus (FSB)</li> </ul>	594804-001
	<ul style="list-style-type: none"> <li>Intel Atom N270 1.6-GHz processor, 512-KB Level 2 cache, 533-MHz front-side bus (FSB) for use with WWAN option</li> </ul>	599187-001
(14)	Memory module	
	<ul style="list-style-type: none"> <li>1024-MB, PC2-6400, DDR2, 533-MHz</li> </ul>	598861-001
	<ul style="list-style-type: none"> <li>1024-MB, PC2-6400, DDR2, 533-MHz, for use with WWAN option</li> </ul>	600131-001
(15)	Base enclosure (includes 4 rubber feet)	594810-001

<b>Item</b>	<b>Description</b>	<b>Spare part number</b>
<b>(16)</b>	Battery	
	• 6-cell Li-ion battery (55-Wh) 2.55-Ah	537627-001
	• 3-cell Li-ion battery (28-Wh) 2.55-Ah	537626-001

# Display assembly subcomponents

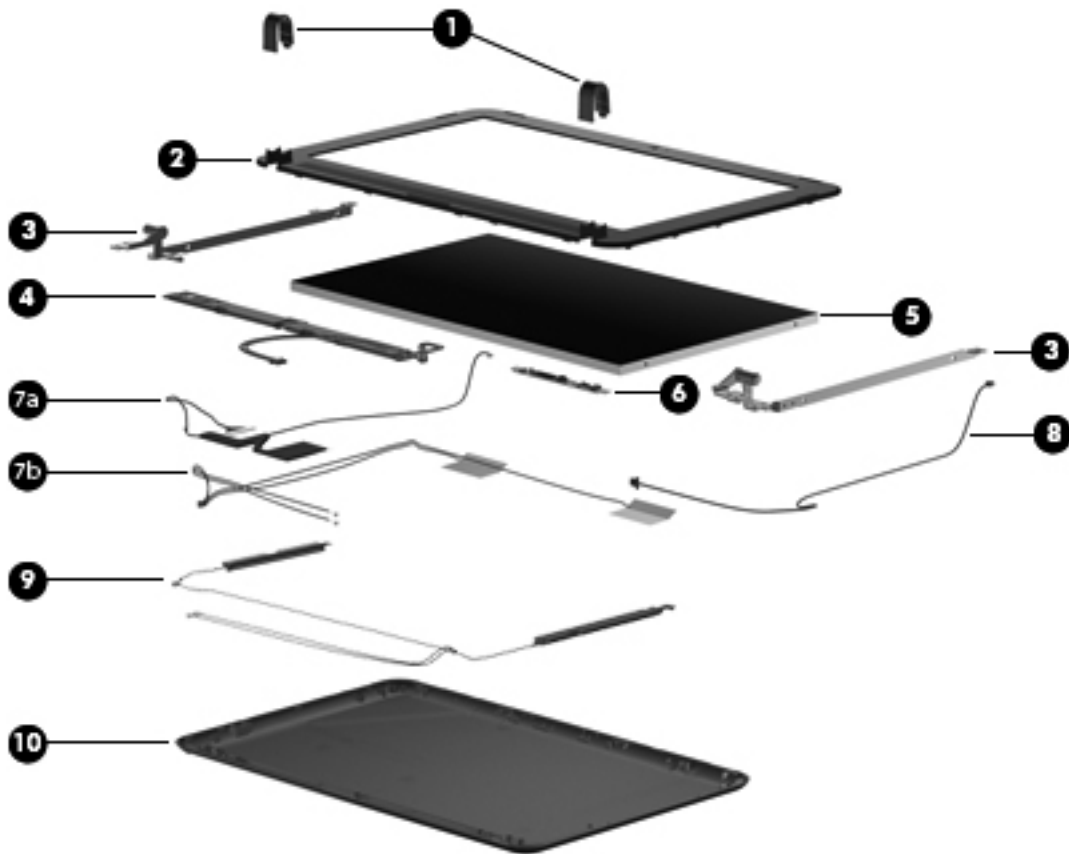

Item	Description	Spare part number
(1)	EMI shield and hinge covers	537617-001
(2)	Display bezel with logo for use with webcam and microphone	537644-001
(3)	Display hinge kit (Includes left and right display panel hinges)	537658-001
(4)	Speaker assembly Includes 2 speakers, cable, and housing	594811-001
(5)	Display panel, <b>25.7-cm</b> (10.1-in) WSVGA (16:9), non-PMMA, AntiGlare	600125-001
(6)	Webcam module	537660-001
	Display cable kit (not illustrated)	579571-001
	Includes:	
(7a)	<ul style="list-style-type: none"> <li>Display/webcam cable</li> </ul>	
(7b)	<ul style="list-style-type: none"> <li>WLAN antenna assembly (530 × 1.37 mm and 440 × 1.37 mm)</li> </ul>	
(8)	Microphone assembly (44 dB, 4.9 × 2.2, omnidirectional)	581323-001
(9)	WWAN antenna assembly for use on select models	538022-001

<b>Item</b>	<b>Description</b>	<b>Spare part number</b>
<b>(10)</b>	Display back cover with logo	594808-001
	Display screw kit (not illustrated)	538510-001
	Includes 14 PM2.0×3.0×4.0×0.4T screws	

## Mass storage devices

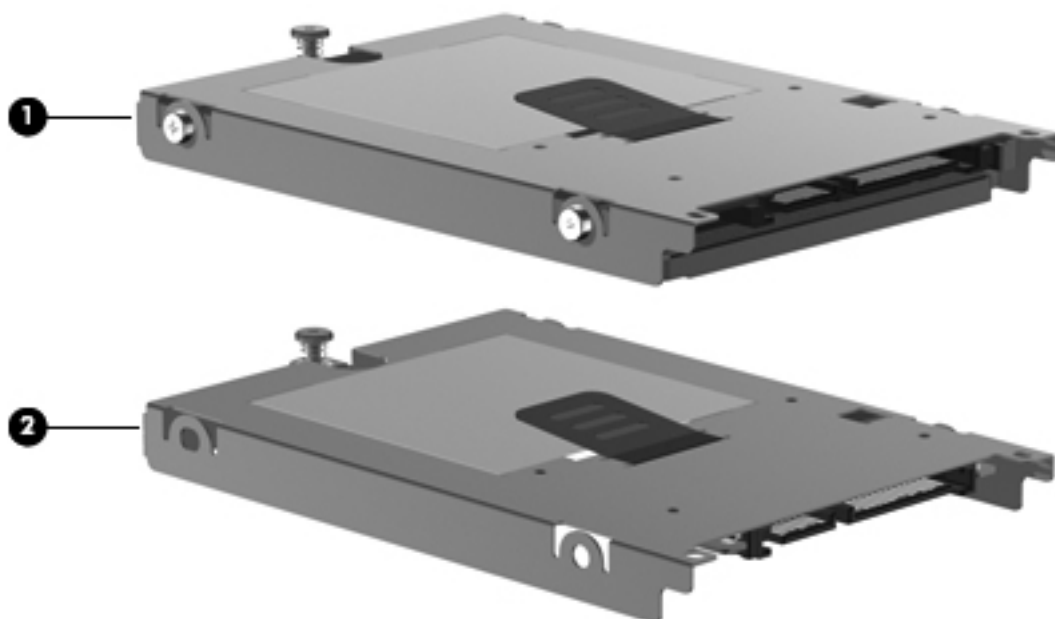

 **NOTE:** Each hard drive spare part kit and solid-state drive spare part kit includes a cable and mounting bracket.

Item	Description	Spare part number
(1)	Hard drive, 160 GB, 5400 RPM	594809-001
	Hard drive mounting kit (includes brackets and screws)	537641-001
(2)	Solid state drive, 16 GB	608396-001

## Miscellaneous parts

Description	Spare part number
30-W, 3-pin AC adapter	496813-001
Power cords, 3-pin, 1.83m	
<ul style="list-style-type: none"><li>• For use in Argentina</li></ul>	490371-D01
<ul style="list-style-type: none"><li>• For use in Australia</li></ul>	490371-011
<ul style="list-style-type: none"><li>• For use in Brazil</li></ul>	490371-202
<ul style="list-style-type: none"><li>• For use in Denmark</li></ul>	490371-081
<ul style="list-style-type: none"><li>• For use in Europe</li></ul>	490371-021
<ul style="list-style-type: none"><li>• For use in Israel</li></ul>	490371-BB1
<ul style="list-style-type: none"><li>• For use in Italy</li></ul>	490371-061
<ul style="list-style-type: none"><li>• For use in India</li></ul>	490371-D61
<ul style="list-style-type: none"><li>• For use in North America</li></ul>	490371-001
<ul style="list-style-type: none"><li>• For use in Singapore and the United Kingdom</li></ul>	490371-031
<ul style="list-style-type: none"><li>• For use in South Africa</li></ul>	490371-AR1
<ul style="list-style-type: none"><li>• For use in Switzerland</li></ul>	490371-111
Rubber kit	537618-001
Includes 4 computer feet — two front and two rear	
Screw kit	537620-001
Includes the following screws:	
<ul style="list-style-type: none"><li>• Phillips 1.6×2.5 mm, nickel</li><li>• Phillips 2.0×3.5 mm</li><li>• Phillips 2.5×4.0 mm, black</li><li>• Phillips 2.5×4.0 mm, nickel</li><li>• Phillips 2.5×6.0 mm</li><li>• Torx T8 2.5×4.0 mm</li></ul>	



## Sequential part number listing

Spare part number	Description
490371-001	Power cord, 3-pin, 1.83m, for use in North America
490371-011	Power cord, 3-pin, 1.83m, for use in Australia
490371-021	Power cord, 3-pin, 1.83m, for use in Europe
490371-031	Power cord, 3-pin, 1.83m, for use in Singapore and the United Kingdom
490371-061	Power cord, 3-pin, 1.83m, for use in Italy
490371-081	Power cord, 3-pin, 1.83m, for use in Denmark
490371-111	Power cord, 3-pin, 1.83m, for use in Switzerland
490371-202	Power cord, 3-pin, 1.83m, for use in Brazil
490371-AR1	Power cord, 3-pin, 1.83m, for use in South Africa
490371-BB1	Power cord, 3-pin, 1.83m, for use in Israel
490371-D01	Power cord, 3-pin, 1.83m, for use in Argentina
490371-D61	Power cord, 3-pin, 1.83m, for use in India
496813-001	AC adapter, 30-W, 3-pin
504593-003	WiFi Adapter, Broadcom 4312G 802.11b/g for use for use in Canada, the Cayman Islands, Guam, Puerto Rico, the United States, and the U.S. Virgin Islands
504593-004	WiFi Adapter, Broadcom 4312G 802.11b/g for use in Afghanistan, Albania, Algeria, Andorra, Angola, Antigua and Barbuda, Argentina, Armenia, Aruba, Australia, Austria, Azerbaijan, the Bahamas, Bahrain, Bangladesh, Barbados, Belarus, Belgium, Belize, Benin, Bermuda, Bhutan, Bolivia, Bosnia and Herzegovina, Botswana, Brazil, the British Virgin Islands, Brunei, Bulgaria, Burkina Faso, Burundi, Cameroon, Cape Verde, the Central African Republic, Chad, Chile, Colombia, Comoros, the Congo, Costa Rica, Croatia, Cyprus, the Czech Republic, Denmark, Djibouti, Dominica, the Dominican Republic, East Timor, Ecuador, Egypt, El Salvador, Equatorial Guinea, Eritrea, Estonia, Ethiopia, Fiji, Finland, France, French Guiana, Gabon, Gambia, Georgia, Germany, Ghana, Gibraltar, Greece, Grenada, Guadeloupe, Guatemala, Guinea, Guinea-Bissau, Guyana, Haiti, Honduras, Hong Kong, Hungary, Iceland, India, Ireland, Israel, Italy, the Ivory Coast, Jamaica, Jordan, Kazakhstan, Kenya, Kiribati, Kyrgyzstan, Laos, Latvia, Lebanon, Lesotho, Liberia, Liechtenstein, Lithuania, Luxembourg, Macedonia, Madagascar, Malawi, Malaysia, the Maldives, Mali, Malta, the Marshall Islands, Martinique, Mauritania, Mauritius, Mexico, Micronesia, Monaco, Mongolia, Montenegro, Morocco, Mozambique, Namibia, Nauru, Nepal, the Nether Antilles, the Netherlands, New Zealand, Nicaragua, Niger, Nigeria, Norway, Oman, Pakistan, Palau, Panama, Papua New Guinea, Paraguay, the People's Republic of China, Peru, the Philippines, Poland, Portugal, the Republic of Moldova, Romania, Russia, Rwanda, Samoa, San Marino, Sao Tome and Principe, Saudi Arabia, Senegal, Serbia, the Seychelles, Sierra Leone, Singapore, Slovakia, Slovenia, the Solomon Islands, Somalia, South Africa, South Korea, Spain, Sri Lanka, St. Kitts and Nevis, St. Lucia, St. Vincent and the Grenadines, Suriname, Swaziland, Sweden, Switzerland, Taiwan, Tajikistan, Tanzania, Togo, Tonga, Trinidad and Tobago, Tunisia, Turkey, Turkmenistan, Tuvalu, Uganda, Ukraine, the United Arab Emirates, the United Kingdom, Uruguay, Uzbekistan, Vanuatu, Venezuela, Vietnam, Yemen, Zaire, Zambia, and Zimbabwe
518436-001	WiFi Adapter, Atheros 9285G 802.11b/g/n 1x1 for use in Canada, the Cayman Islands, Guam, Puerto Rico, the U.S. Virgin Islands, and the United States

518436-002	WiFi Adapter, Atheros 9285G 802.11b/g/n 1x1 for use in Afghanistan, Albania, Algeria, Andorra, Angola, Antigua and Barbuda, Argentina, Armenia, Aruba, Australia, Austria, Azerbaijan, the Bahamas, Bahrain, Bangladesh, Barbados, Belarus, Belgium, Belize, Benin, Bermuda, Bhutan, Bolivia, Bosnia and Herzegovina, Botswana, Brazil, the British Virgin Islands, Brunei, Bulgaria, Burkina Faso, Burundi, Cameroon, Cape Verde, the Central African Republic, Chad, Chile, Colombia, Comoros, the Congo, Costa Rica, Croatia, Cyprus, the Czech Republic, Denmark, Djibouti, Dominica, the Dominican Republic, East Timor, Ecuador, Egypt, El Salvador, Equatorial Guinea, Eritrea, Estonia, Ethiopia, Fiji, Finland, France, French Guiana, Gabon, Gambia, Georgia, Germany, Ghana, Gibraltar, Greece, Grenada, Guadeloupe, Guatemala, Guinea, Guinea-Bissau, Guyana, Haiti, Honduras, Hong Kong, Hungary, Iceland, India, Ireland, Israel, Italy, the Ivory Coast, Jamaica, Jordan, Kazakhstan, Kenya, Kiribati, Kyrgyzstan, Laos, Latvia, Lebanon, Lesotho, Liberia, Liechtenstein, Lithuania, Luxembourg, Macedonia, Madagascar, Malawi, Malaysia, the Maldives, Mali, Malta, the Marshall Islands, Martinique, Mauritania, Mauritius, Mexico, Micronesia, Monaco, Mongolia, Montenegro, Morocco, Mozambique, Namibia, Nauru, Nepal, the Nether Antilles, the Netherlands, New Zealand, Nicaragua, Niger, Nigeria, Norway, Oman, Pakistan, Palau, Panama, Papua New Guinea, Paraguay, the People's Republic of China, Peru, the Philippines, Poland, Portugal, the Republic of Moldova, Romania, Russia, Rwanda, Samoa, San Marino, Sao Tome and Principe, Saudi Arabia, Senegal, Serbia, the Seychelles, Sierra Leone, Singapore, Slovakia, Slovenia, the Solomon Islands, Somalia, South Africa, South Korea, Spain, Sri Lanka, St. Kitts and Nevis, St. Lucia, St. Vincent and the Grenadines, Suriname, Swaziland, Sweden, Switzerland, Taiwan, Tajikistan, Tanzania, Togo, Tonga, Trinidad and Tobago, Tunisia, Turkey, Turkmenistan, Tuvalu, Uganda, Ukraine, the United Arab Emirates, the United Kingdom, Uruguay, Uzbekistan, Vanuatu, Venezuela, Vietnam, Yemen, Zaire, Zambia, and Zimbabwe
531993-001	WWAN module, Qualcomm EV-DO/HSPA
535689-001	Keyboard for use in the United States
535689-031	Keyboard for use in the United Kingdom
535689-041	Keyboard for use in Germany
535689-051	Keyboard for use in France
535689-061	Keyboard for use in Italy
535689-071	Keyboard for use in Spain
535689-121	Keyboard for use in French Canada
535689-131	Keyboard for use in Portugal
535689-141	Keyboard for use in Turkey
535689-161	Keyboard for use in Latin America
535689-171	Keyboard for use in Saudi Arabia
535689-202	Keyboard for use in Brazil
535689-211	Keyboard for use in Hungary
535689-221	Keyboard for use in the Czech Republic
535689-251	Keyboard for use in Russia
535689-A41	Keyboard for use in Europe
535689-B31	Keyboard for use with international models
535689-BA1	Keyboard for use in Slovenia
535689-BB1	Keyboard for use in Israel

535689-BG1	Keyboard for use in Switzerland
535689-DH1	Keyboard for use in Finland, Norway, and Sweden
535689-DJ1	Keyboard for use in Greece
537612-001	Plastics/actuator kit
537613-001	Fan
537616-001	RTC battery (includes cable and double-sided tape)
537617-001	EMI shield and hinge covers
537618-001	Rubber kit with 4 computer feet — two front and two rear
537619-001	Heat sink assembly (includes replacement thermal material)
537620-001	Screw kit
537622-001	Top cover with TouchPad
537626-001	Battery, 3-cell Li-ion battery (28-Wh) 2.55-Ah
537627-001	Battery, 6-cell Li-ion battery (55-Wh) 2.55-Ah
537641-001	Hard drive mounting kit (includes mounting bracket and 4 PM3.0×3.0×4.5 screws)
537644-001	Display bezel with Compaq logo for use with webcam and microphone
537658-001	Display hinge kit (includes left and right display panel hinges)
537660-001	Webcam module
538022-001	WWAN antenna assemblies (optional)
538510-001	Display screw kit
575920-001	Broadcom 4312G 802.11b/g WiFi and 2070 Bluetooth 2.1+EDR Combo Adapter
579571-001	Display cable kit (not illustrated, includes display/webcam cable and WLAN antennas)
581323-001	Microphone assembly (44 dB, 4.9 × 2.2, omnidirectional)
581326-001	DC connector/power board
593837-001	Broadcom 43225 802.11b/g/n 2x2 WiFi Adapter
594804-001	System board, Intel Atom N270 1.6-GHz processor, 512-KB Level 2 cache, 533-MHz front-side bus (FSB)
594806-001	Display, <b>25.7-cm</b> (10.1-in), WSVGA, AntiGlare for use with WWAN
594808-001	Display back cover with logo
594809-001	Hard drive, 160-GB, 5400-RPM
594810-001	Base enclosure
594811-001	Speaker assembly (includes two 4-ohm speakers, cable, and housing)
598861-001	Memory module, 1024-MB, PC2-6400, DDR2, 533-MHz
599187-001	System board, Intel Atom N270 1.6-GHz processor, 512-KB Level 2 cache, 533-MHz front-side bus (FSB) for use with WWAN option

---

600124-001	USB/audio board with cable
600131-001	Memory module, 1024-MB, PC2-6400, DDR2, 533-MHz, for use with WWAN option
600125-001	Display panel, <b>25.7-cm</b> (10.1-in), WSVGA, non-PMMA, AntiGlare
608396-001	Solid state drive, 16 GB

---

---

# 4 Removal and replacement procedures

## Preliminary replacement requirements

### Tools required

You will need the following tools to complete the removal and replacement procedures:

- Flat-bladed screwdriver
- Magnetic screwdriver
- Phillips P0 and P1 screwdrivers

### Service considerations

The following sections include some of the considerations that you must keep in mind during disassembly and assembly procedures.

---

 **NOTE:** As you remove each subassembly from the computer, place the subassembly (and all accompanying screws) away from the work area to prevent damage.

---

### Plastic parts

---

△ **CAUTION:** Using excessive force during disassembly and reassembly can damage plastic parts. Use care when handling the plastic parts. Apply pressure only at the points designated in the maintenance instructions.

---

### Cables and connectors

---

△ **CAUTION:** When servicing the computer, be sure that cables are placed in their proper locations during the reassembly process. Improper cable placement can damage the computer.

---

Cables must be handled with extreme care to avoid damage. Apply only the tension required to unseat or seat the cables during removal and insertion. Handle cables by the connector whenever possible. In all cases, avoid bending, twisting, or tearing cables. Be sure that cables are routed in such a way that they cannot be caught or snagged by parts being removed or replaced. Handle flex cables with extreme care; these cables tear easily.

## Drive handling

---

△ **CAUTION:** Drives are fragile components that must be handled with care. To prevent damage to the computer, damage to a drive, or loss of information, observe these precautions:

Before removing or inserting a hard drive, shut down the computer. If you are unsure whether the computer is off or in Hibernation, turn the computer on, and then shut it down through the operating system.

Before handling a drive, be sure that you are discharged of static electricity. While handling a drive, avoid touching the connector.

Handle drives on surfaces covered with at least one inch of shock-proof foam.

Avoid dropping drives from any height onto any surface.

After removing a hard drive, an optical drive, or a diskette drive, place it in a static-proof bag.

Avoid exposing a hard drive to products that have magnetic fields, such as monitors or speakers.

Avoid exposing a drive to temperature extremes or liquids.

If a drive must be mailed, place the drive in a bubble pack mailer or other suitable form of protective packaging and label the package "FRAGILE."

---

# Grounding guidelines

## Electrostatic discharge damage

Electronic components are sensitive to electrostatic discharge (ESD). Circuitry design and structure determine the degree of sensitivity. Networks built into many integrated circuits provide some protection, but in many cases, ESD contains enough power to alter device parameters or melt silicon junctions.

A discharge of static electricity from a finger or other conductor can destroy static-sensitive devices or microcircuitry. Even if the spark is neither felt nor heard, damage may have occurred.

An electronic device exposed to ESD may not be affected at all and can work perfectly throughout a normal cycle. Or the device may function normally for a while, then degrade in the internal layers, reducing its life expectancy.

△ **CAUTION:** To prevent damage to the computer when you are removing or installing internal components, observe these precautions:

Keep components in their electrostatic-safe containers until you are ready to install them.

Use nonmagnetic tools.

Before touching an electronic component, discharge static electricity by using the guidelines described in this section.

Avoid touching pins, leads, and circuitry. Handle electronic components as little as possible.

If you remove a component, place it in an electrostatic-safe container.

The following table shows how humidity affects the electrostatic voltage levels generated by different activities.

△ **CAUTION:** A product can be degraded by as little as 700 V.

Typical electrostatic voltage levels			
Event	Relative humidity		
	10%	40%	55%
Walking across carpet	35,000 V	15,000 V	7,500 V
Walking across vinyl floor	12,000 V	5,000 V	3,000 V
Motions of bench worker	6,000 V	800 V	400 V
Removing DIPS from plastic tube	2,000 V	700 V	400 V
Removing DIPS from vinyl tray	11,500 V	4,000 V	2,000 V
Removing DIPS from Styrofoam	14,500 V	5,000 V	3,500 V
Removing bubble pack from PCB	26,500 V	20,000 V	7,000 V
Packing PCBs in foam-lined box	21,000 V	11,000 V	5,000 V

## Packaging and transporting guidelines

Follow these grounding guidelines when packaging and transporting equipment:

- To avoid hand contact, transport products in static-safe tubes, bags, or boxes.
- Protect ESD-sensitive parts and assemblies with conductive or approved containers or packaging.
- Keep ESD-sensitive parts in their containers until the parts arrive at static-free workstations.
- Place items on a grounded surface before removing items from their containers.
- Always be properly grounded when touching a component or assembly.
- Store reusable ESD-sensitive parts from assemblies in protective packaging or nonconductive foam.
- Use transporters and conveyors made of antistatic belts and roller bushings. Be sure that mechanized equipment used for moving materials is wired to ground and that proper materials are selected to avoid static charging. When grounding is not possible, use an ionizer to dissipate electric charges.

## Workstation guidelines

Follow these grounding workstation guidelines:

- Cover the workstation with approved static-shielding material.
- Use a wrist strap connected to a properly grounded work surface and use properly grounded tools and equipment.
- Use conductive field service tools, such as cutters, screwdrivers, and vacuums.
- When fixtures must directly contact dissipative surfaces, use fixtures made only of static-safe materials.
- Keep the work area free of nonconductive materials, such as ordinary plastic assembly aids and Styrofoam.
- Handle ESD-sensitive components, parts, and assemblies by the case or PCM laminate. Handle these items only at static-free workstations.
- Avoid contact with pins, leads, or circuitry.
- Turn off power and input signals before inserting or removing connectors or test equipment.



## Equipment guidelines

Grounding equipment must include either a wrist strap or a foot strap at a grounded workstation.

- When seated, wear a wrist strap connected to a grounded system. Wrist straps are flexible straps with a minimum of one megohm  $\pm 10\%$  resistance in the ground cords. To provide proper ground, wear a strap snugly against the skin at all times. On grounded mats with banana-plug connectors, use alligator clips to connect a wrist strap.
- When standing, use foot straps and a grounded floor mat. Foot straps (heel, toe, or boot straps) can be used at standing workstations and are compatible with most types of shoes or boots. On conductive floors or dissipative floor mats, use foot straps on both feet with a minimum of one megohm resistance between the operator and ground. To be effective, the conductive strips must be worn in contact with the skin.

The following grounding equipment is recommended to prevent electrostatic damage:

- Antistatic tape
- Antistatic smocks, aprons, and sleeve protectors
- Conductive bins and other assembly or soldering aids
- Nonconductive foam
- Conductive tabletop workstations with ground cords of one megohm resistance
- Static-dissipative tables or floor mats with hard ties to the ground
- Field service kits
- Static awareness labels
- Material-handling packages
- Nonconductive plastic bags, tubes, or boxes
- Metal tote boxes
- Electrostatic voltage levels and protective materials

The following table lists the shielding protection provided by antistatic bags and floor mats.

<b>Material</b>	<b>Use</b>	<b>Voltage protection level</b>
Antistatic plastic	Bags	1,500 V
Carbon-loaded plastic	Floor mats	7,500 V
Metallized laminate	Floor mats	5,000 V

# Component replacement procedures

This chapter provides removal and replacement procedures.

There are as many as 54 screws, in 8 different sizes, that must be removed, replaced, or loosened when servicing the computer. Make special note of each screw size and location during removal and replacement.

 **NOTE:** The service tag color may be different on select models.

---

## Service tag

When ordering parts or requesting information, provide the computer serial number and model description provided on the service tag:

- (1)** Product name: This is the product name affixed to the front of the computer.
- (2)** Serial: This is an alphanumeric identifier that is unique to each product.
- (3)** Product: This number provides specific information about the product's hardware components. The product number helps a service technician determine what components and parts are needed.
- (4)** Warranty: This number describes the duration of the warranty period for the computer.
- (5)** Model: This is the alphanumeric identifier used to locate documents, drivers, and support for the computer.

 **NOTE:** The Warranty **(4)** and the Model **(5)** fields are excluded on select models.

---



## Computer feet

The computer feet are adhesive-backed rubber pads, tethered to the base enclosure.

Description	Spare part number
Rubber kit	537618-001



## Battery

Description	Spare part number
6-cell Li-ion battery (55-Wh) 2.55-Ah	537627-001
3-cell Li-ion battery (28-Wh) 2.55-Ah	537626-001

Before disassembling the computer, follow these steps:

1. Shut down the computer. If you are unsure whether the computer is off or in Hibernation, turn the computer on, and then shut it down through the operating system.
2. Disconnect all external devices connected to the computer.
3. Disconnect the power from the computer by first unplugging the power cord from the AC outlet and then unplugging the AC adapter from the computer.

Remove the battery:

1. Turn the computer upside down on a flat surface, with the battery bay toward you.
2. Slide the battery release latches **(1)** to release the battery.
3. Remove the battery **(2)**.

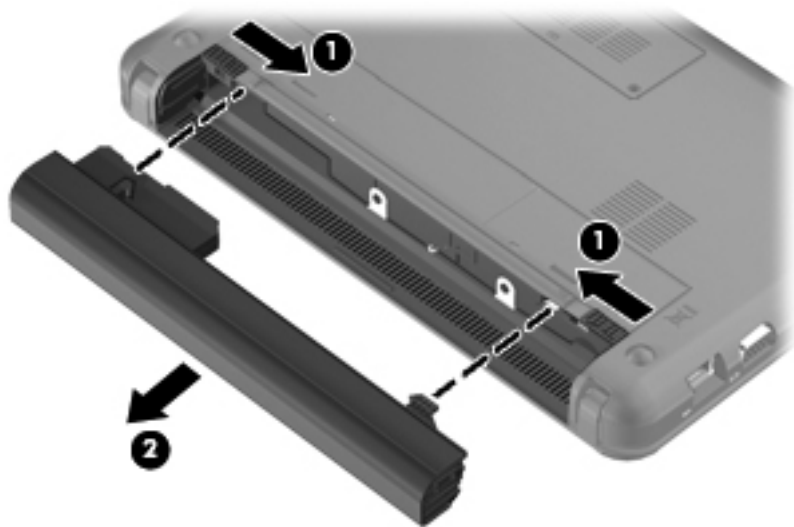

Reverse this procedure to install a battery.

## SIM

 **NOTE:** This section applies only to computer models with WWAN capability.

**NOTE:** If there is a SIM inserted in the SIM slot, it must be removed before disassembling the computer. Be sure that the SIM is reinserted in the SIM slot after reassembling the computer.

Before removing the SIM, follow these steps:

1. Shut down the computer. If you are unsure whether the computer is off or in Hibernation, turn the computer on, and then shut it down through the operating system.
2. Disconnect all external devices connected to the computer.
3. Disconnect the power from the computer by first unplugging the power cord from the AC outlet and then unplugging the AC adapter from the computer.
4. Remove the battery (see [Battery on page 36](#)).

Remove the SIM:

1. Press in on the SIM **(1)**. (The module is partially ejected from the SIM slot.)
2. Remove the SIM **(2)** from the SIM slot.

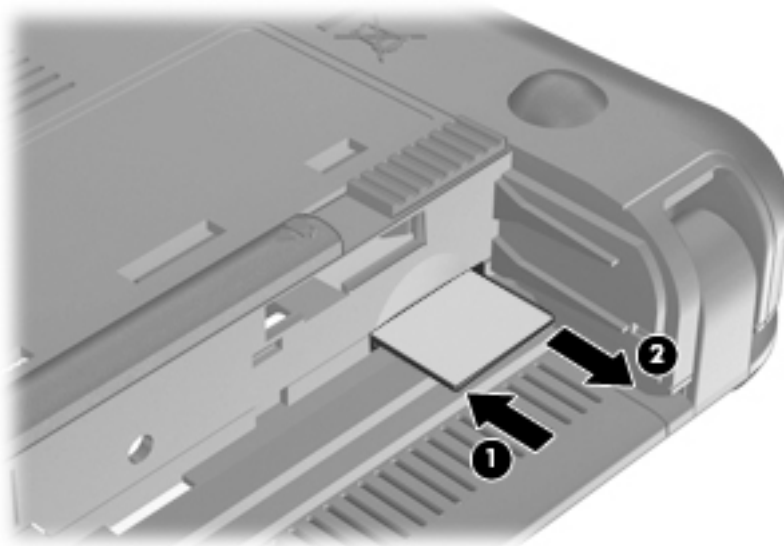

Reverse this procedure to insert the SIM.

## Memory module

Description	Spare part number
1024-MB memory module (PC2-6400, DDR2, 533-MHz)	598861-001

Before removing the memory module, follow these steps:

1. Shut down the computer. If you are unsure whether the computer is off or in Hibernation, turn the computer on, and then shut it down through the operating system.
2. Disconnect all external devices connected to the computer.
3. Disconnect the power from the computer by first unplugging the power cord from the AC outlet and then unplugging the AC adapter from the computer.
4. Remove the battery (see [Battery on page 36](#)).
5. If your computer has WWAN capability, remove the SIM (see [SIM on page 37](#)).

Remove the memory module:

1. Loosen the 2 Phillips PM2.0×3.0 captive screws **(1)** that secure the memory module compartment cover to the computer.
2. Swing the cover up and away from the inside of the computer **(2)**, and then remove the cover **(3)**.

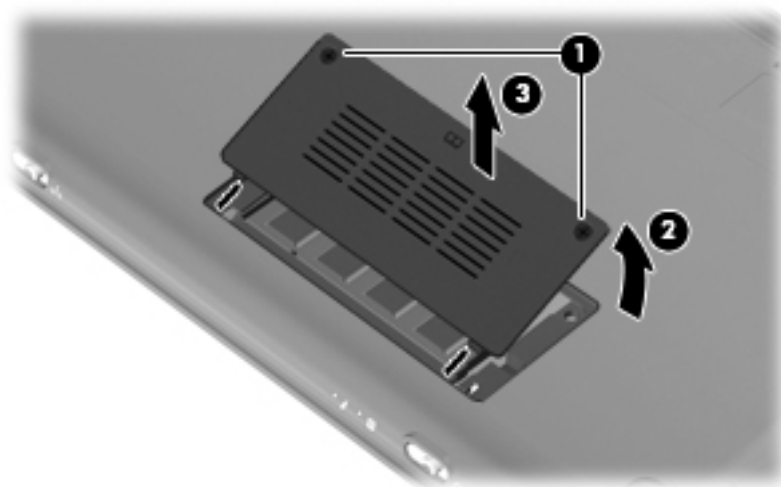

3. Spread the retaining tabs **(1)** on each side of the memory module slot to release the memory module. (The edge of the module opposite the slot rises away from the computer.)

4. Remove the memory module **(2)** by pulling the module away from the slot at an angle.

 **NOTE:** Memory modules are designed with a notch **(3)** to prevent incorrect insertion into the memory module slot.

---

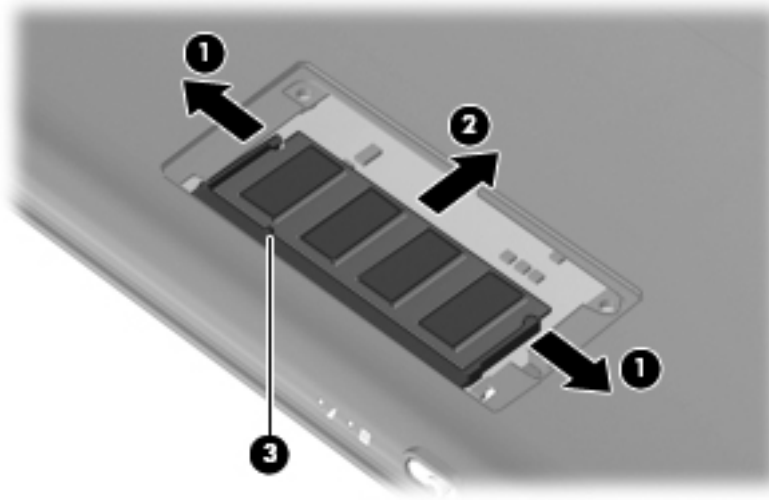

Reverse this procedure to install a memory module.

## Keyboard

Description	Spare part number
Keyboard for use in Brazil	535689-202
Keyboard for use in Europe	535689-A41
Keyboard for use in Finland, Norway, and Sweden	535689-DH1
Keyboard for use in France	535689-051
Keyboard for use in French Canada	535689-121
Keyboard for use in Germany	535689-041
Keyboard for use in Greece	535689-DJ1
Keyboard for use in Hungary	535689-211
Keyboard for use in Israel	535689-BB1
Keyboard for use in Italy	535689-061
Keyboard for use in Latin America	535689-161
Keyboard for use in Portugal	535689-131
Keyboard for use in Russia	535689-251
Keyboard for use in Saudi Arabia	535689-171
Keyboard for use in Slovenia	535689-BA1
Keyboard for use in Spain	535689-071
Keyboard for use in Switzerland	535689-BG1
Keyboard for use in the Czech Republic	535689-221
Keyboard for use in the United Kingdom	535689-031
Keyboard for use in the United States	535689-001
Keyboard for use in Turkey	535689-141
Keyboard for use with international models	535689-B31

Before removing the keyboard, follow these steps:

1. Shut down the computer. If you are unsure whether the computer is off or in Hibernation, turn the computer on, and then shut it down through the operating system.
2. Disconnect all external devices connected to the computer.
3. Disconnect the power from the computer by first unplugging the power cord from the AC outlet and then unplugging the AC adapter from the computer.
4. Remove the battery (see [Battery on page 36](#)).
5. If your computer has WWAN capability, remove the SIM (see [SIM on page 37](#)).



Remove the keyboard:

1. Remove the 3 Phillips PM2.0x3.0 screws that secure the keyboard to the computer.



2. Turn the computer right-side up, and then open the display as far as possible.
3. Turn the computer upside down, and locate the keyboard release access on the bottom of the computer, inside the battery bay.
4. Insert a flexible tool into the opening, and then press inward to release the keyboard.

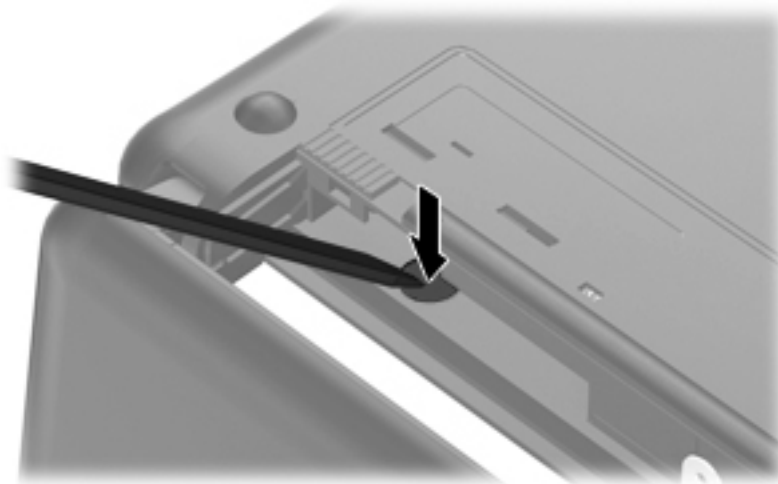

5. Turn the computer right-side up, and then lift up on the top and left edges **(1)** of the keyboard until the keyboard releases completely.

6. Slide the keyboard back until its top edge rests on the display assembly **(2)**.



7. Release the zero insertion force (ZIF) connector **(1)** to which the keyboard cable is attached.
8. Disconnect the cable **(2)**, and then remove the keyboard.



9. Remove the keyboard.

Reverse this procedure to install the keyboard.

## RTC battery

Description	Spare part number
RTC battery	537616-001

Before removing the real-time clock (RTC) battery, follow these steps:

1. Shut down the computer. If you are unsure whether the computer is off or in Hibernation, turn the computer on, and then shut it down through the operating system.
2. Disconnect all external devices connected to the computer.
3. Disconnect the power from the computer by first unplugging the power cord from the AC outlet and then unplugging the AC adapter from the computer.
4. Remove the battery (see [Battery on page 36](#)).
5. If your computer has WWAN capability, remove the SIM (see [SIM on page 37](#)).
6. Remove the Keyboard (see [Keyboard on page 40](#)).

Remove the RTC battery:

1. Disconnect the RTC battery cable **(1)** from the system board.
2. Detach the RTC battery **(2)** from the system board.

 **NOTE:** The RTC battery is attached to the system board with double-sided tape.

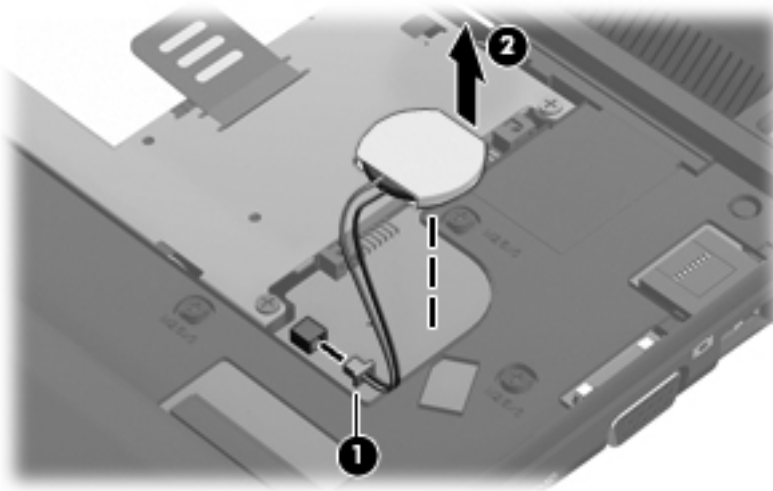

Reverse this procedure to install the RTC battery.

## Mass storage devices

 **NOTE:** Each hard drive spare part kit and solid state drive spare part kit includes a bracket and screws.

Description	Spare part number
Hard drive, 160 GB, 5400 RPM	594809-001
Hard drive mounting kit	537641-001
Solid state drive, 16 GB	608396-001

Before removing the hard drive, follow these steps:

1. Shut down the computer. If you are unsure whether the computer is off or in Hibernation, turn the computer on, and then shut it down through the operating system.
2. Disconnect all external devices connected to the computer.
3. Disconnect the power from the computer by first unplugging the power cord from the AC outlet and then unplugging the AC adapter from the computer.
4. Remove the battery (see [Battery on page 36](#)).
5. If your computer has WWAN capability, remove the SIM (see [SIM on page 37](#)).
6. Remove the keyboard (see [Keyboard on page 40](#)).

To remove the hard drive or the solid state drive:

1. Loosen the Phillips PM2.5×10.0 captive screw **(1)**, and remove the 2 Phillips PM2.0×3.0 screws **(2)** that secure the assembly to the computer.
2. Use the Mylar tab to slide the assembly to the left **(3)** to disconnect it, and remove the assembly **(4)**.

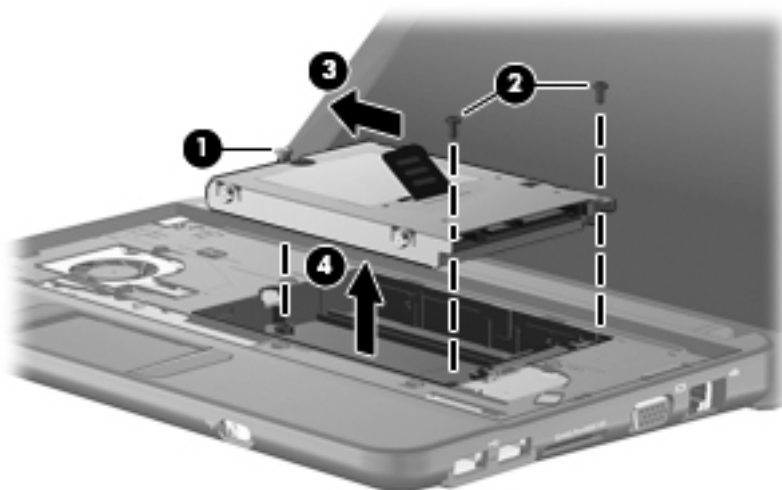

Continue with one of the following sections for hard drive or solid-state drive replacement.

## Hard drive

1. Remove the 4 Phillips PM3.0x3.0 screws **(1)** that secure the hard drive bracket to the hard drive.
2. Using the Mylar tab, lift the bracket **(2)** away from the hard drive.

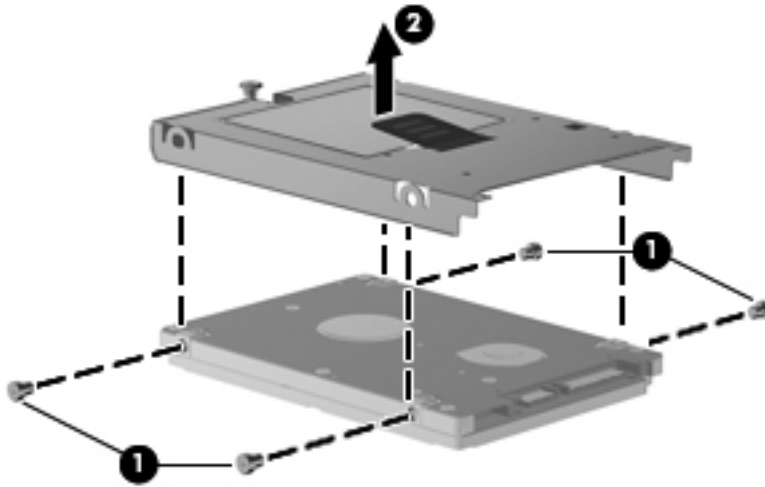

Reverse this procedure to install a hard drive.

## Solid-state drive

To remove the solid-state drive:

1. Remove the 4 Phillips PM2.0x3.0 screws **(1)** that secure the solid-state drive bracket to the solid-state drive.
2. Lift the solid-state drive **(2)** to remove it.

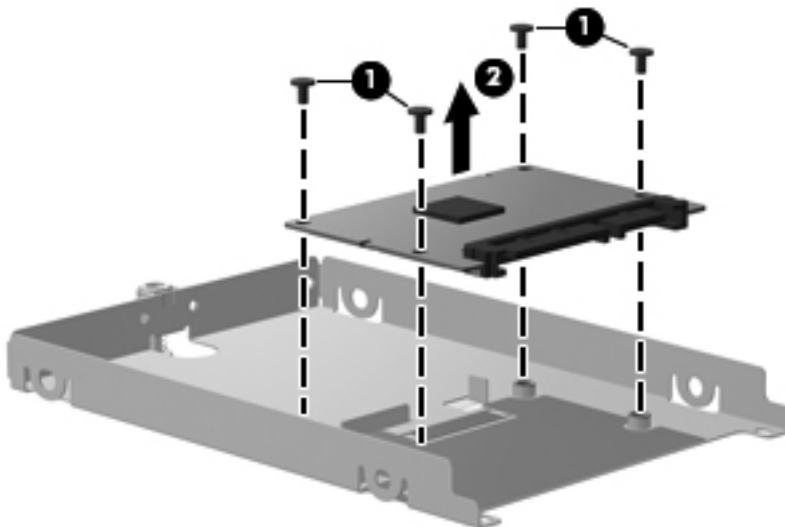

Reverse this procedure to install a solid-state drive.

## Top cover

Description	Spare part number
Top cover with TouchPad	537622-001

Before removing the top cover, follow these steps:

1. Shut down the computer. If you are unsure whether the computer is off or in Hibernation, turn the computer on, and then shut it down through the operating system.
2. Disconnect all external devices connected to the computer.
3. Disconnect the power from the computer by first unplugging the power cord from the AC outlet and then unplugging the AC adapter from the computer.
4. Remove the battery (see [Battery on page 36](#)).
5. If your computer has WWAN capability, remove the SIM (see [SIM on page 37](#)).
6. Remove the memory module (see [Memory module on page 38](#)).
7. Remove the keyboard (see [Keyboard on page 40](#)).
8. Remove the hard drive assembly (see [Mass storage devices on page 44](#)).

Remove the top cover.

1. Turn the computer upside down, with the front toward you.
2. Use a thin, flat tool to release the 4 rubber feet.
3. Remove the 4 Phillips PM2.5×6.0 screws **(1)**, and the Phillips PM2.0×4.0 screw **(2)** that secure the top cover to the base enclosure.

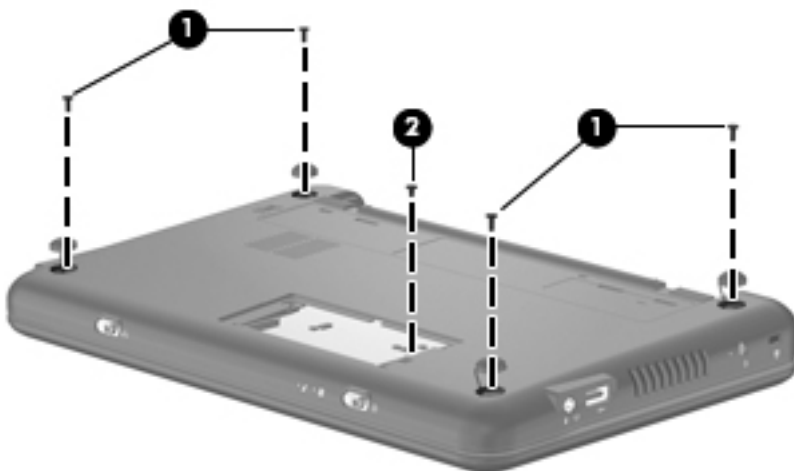

4. Turn the computer right-side up, with the front toward you.
5. Open the computer as far as possible.

6. Remove the 8 Phillips PM2.5×6.0 screws that secure the top cover to the base enclosure.

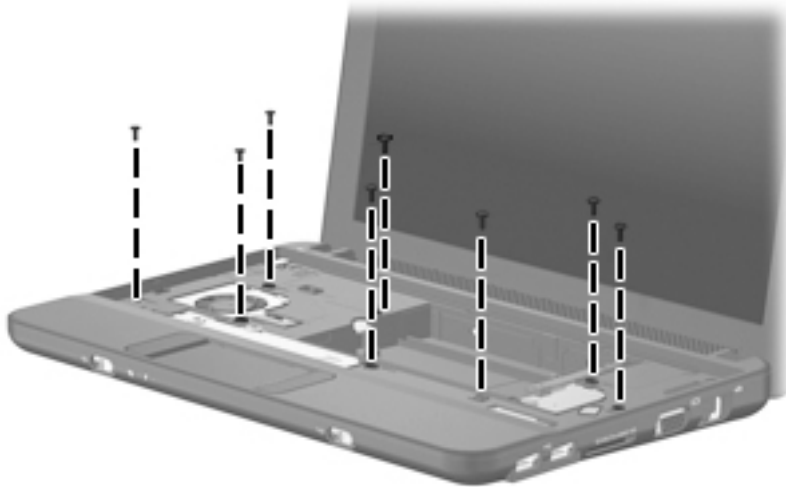

7. Lift the inside edge of the top cover **(1)** and swing it up. Then slide the top cover back slightly to rest against the display assembly **(2)** at an angle.

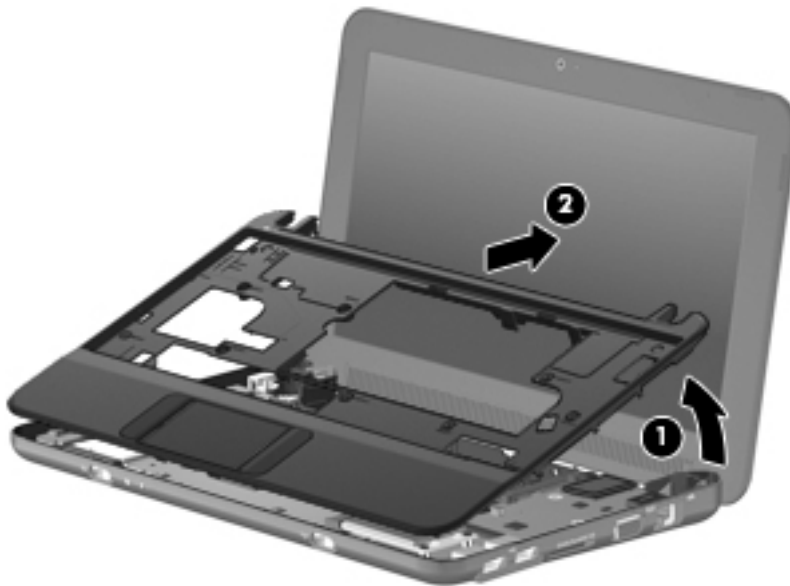

8. Release the ZIF connector **(1)** to which the TouchPad button board cable is connected.

9. Disconnect the TouchPad button board cable **(2)** from the system board, and then remove the top cover.

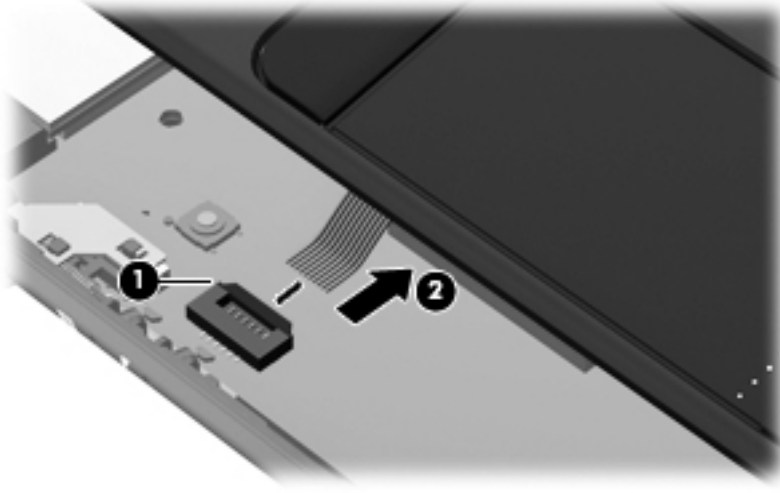

Reverse this procedure to install the top cover.



## WLAN module

Description	Spare part number
Broadcom 4312G 802.11b/g WiFi and 2070 Bluetooth 2.1+EDR Combo Adapter	575920-001
Broadcom 43225 802.11b/g/n 2x2 WiFi Adapter	593837-001
Atheros 9285G 802.11b/g/n 1x1 WiFi Adapter	
<ul style="list-style-type: none"> <li>For use in Canada, the Cayman Islands, Guam, Puerto Rico, the U.S. Virgin Islands, and the United States</li> </ul>	518436-001
<ul style="list-style-type: none"> <li>For use in Afghanistan, Albania, Algeria, Andorra, Angola, Antigua and Barbuda, Argentina, Armenia, Aruba, Australia, Austria, Azerbaijan, the Bahamas, Bahrain, Bangladesh, Barbados, Belarus, Belgium, Belize, Benin, Bermuda, Bhutan, Bolivia, Bosnia and Herzegovina, Botswana, Brazil, the British Virgin Islands, Brunei, Bulgaria, Burkina Faso, Burundi, Cameroon, Cape Verde, the Central African Republic, Chad, Chile, Colombia, Comoros, the Congo, Costa Rica, Croatia, Cyprus, the Czech Republic, Denmark, Djibouti, Dominica, the Dominican Republic, East Timor, Ecuador, Egypt, El Salvador, Equatorial Guinea, Eritrea, Estonia, Ethiopia, Fiji, Finland, France, French Guiana, Gabon, Gambia, Georgia, Germany, Ghana, Gibraltar, Greece, Grenada, Guadeloupe, Guatemala, Guinea, Guinea-Bissau, Guyana, Haiti, Honduras, Hong Kong, Hungary, Iceland, India, Ireland, Israel, Italy, the Ivory Coast, Jamaica, Jordan, Kazakhstan, Kenya, Kiribati, Kyrgyzstan, Laos, Latvia, Lebanon, Lesotho, Liberia, Liechtenstein, Lithuania, Luxembourg, Macedonia, Madagascar, Malawi, Malaysia, the Maldives, Mali, Malta, the Marshall Islands, Martinique, Mauritania, Mauritius, Mexico, Micronesia, Monaco, Mongolia, Montenegro, Morocco, Mozambique, Namibia, Nauru, Nepal, the Nether Antilles, the Netherlands, New Zealand, Nicaragua, Niger, Nigeria, Norway, Oman, Pakistan, Palau, Panama, Papua New Guinea, Paraguay, the People's Republic of China, Peru, the Philippines, Poland, Portugal, the Republic of Moldova, Romania, Russia, Rwanda, Samoa, San Marino, Sao Tome and Principe, Saudi Arabia, Senegal, Serbia, the Seychelles, Sierra Leone, Singapore, Slovakia, Slovenia, the Solomon Islands, Somalia, South Africa, South Korea, Spain, Sri Lanka, St. Kitts and Nevis, St. Lucia, St. Vincent and the Grenadines, Suriname, Swaziland, Sweden, Switzerland, Taiwan, Tajikistan, Tanzania, Togo, Tonga, Trinidad and Tobago, Tunisia, Turkey, Turkmenistan, Tuvalu, Uganda, Ukraine, the United Arab Emirates, the United Kingdom, Uruguay, Uzbekistan, Vanuatu, Venezuela, Vietnam, Yemen, Zaire, Zambia, and Zimbabwe</li> </ul>	518436-002
Broadcom 4312G 802.11b/g WiFi Adapter	

Description	Spare part number
<ul style="list-style-type: none"> <li>For use in Canada, the Cayman Islands, Guam, Puerto Rico, the U.S. Virgin Islands, and the United States</li> </ul>	504593-003
<ul style="list-style-type: none"> <li>For use in Afghanistan, Albania, Algeria, Andorra, Angola, Antigua and Barbuda, Argentina, Armenia, Aruba, Australia, Austria, Azerbaijan, the Bahamas, Bahrain, Bangladesh, Barbados, Belarus, Belgium, Belize, Benin, Bermuda, Bhutan, Bolivia, Bosnia and Herzegovina, Botswana, Brazil, the British Virgin Islands, Brunei, Bulgaria, Burkina Faso, Burundi, Cameroon, Cape Verde, the Central African Republic, Chad, Chile, Colombia, Comoros, the Congo, Costa Rica, Croatia, Cyprus, the Czech Republic, Denmark, Djibouti, Dominica, the Dominican Republic, East Timor, Ecuador, Egypt, El Salvador, Equatorial Guinea, Eritrea, Estonia, Ethiopia, Fiji, Finland, France, French Guiana, Gabon, Gambia, Georgia, Germany, Ghana, Gibraltar, Greece, Grenada, Guadeloupe, Guatemala, Guinea, Guinea-Bissau, Guyana, Haiti, Honduras, Hong Kong, Hungary, Iceland, India, Ireland, Israel, Italy, the Ivory Coast, Jamaica, Jordan, Kazakhstan, Kenya, Kiribati, Kyrgyzstan, Laos, Latvia, Lebanon, Lesotho, Liberia, Liechtenstein, Lithuania, Luxembourg, Macedonia, Madagascar, Malawi, Malaysia, the Maldives, Mali, Malta, the Marshall Islands, Martinique, Mauritania, Mauritius, Mexico, Micronesia, Monaco, Mongolia, Montenegro, Morocco, Mozambique, Namibia, Nauru, Nepal, the Nether Antilles, the Netherlands, New Zealand, Nicaragua, Niger, Nigeria, Norway, Oman, Pakistan, Palau, Panama, Papua New Guinea, Paraguay, the People's Republic of China, Peru, the Philippines, Poland, Portugal, the Republic of Moldova, Romania, Russia, Rwanda, Samoa, San Marino, Sao Tome and Principe, Saudi Arabia, Senegal, Serbia, the Seychelles, Sierra Leone, Singapore, Slovakia, Slovenia, the Solomon Islands, Somalia, South Africa, South Korea, Spain, Sri Lanka, St. Kitts and Nevis, St. Lucia, St. Vincent and the Grenadines, Suriname, Swaziland, Sweden, Switzerland, Taiwan, Tajikistan, Tanzania, Togo, Tonga, Trinidad and Tobago, Tunisia, Turkey, Turkmenistan, Tuvalu, Uganda, Ukraine, the United Arab Emirates, the United Kingdom, Uruguay, Uzbekistan, Vanuatu, Venezuela, Vietnam, Yemen, Zaire, Zambia, and Zimbabwe</li> </ul>	504593-004

△ **CAUTION:** The WWAN module and the WLAN module are not interchangeable.

To prevent an unresponsive system, replace the wireless module only with a wireless module authorized for use in the computer by the governmental agency that regulates wireless devices in your country or region. If you replace the module and then receive a warning message, remove the module to restore computer functionality, and then contact technical support through Help and Support.

Before removing the WLAN module, follow these steps:

1. Shut down the computer. If you are unsure whether the computer is off or in Hibernation, turn the computer on, and then shut it down through the operating system.
2. Disconnect all external devices connected to the computer.
3. Disconnect power from the computer by first unplugging the power cord from the AC outlet and then unplugging the AC adapter from the computer.
4. Remove the battery (see [Battery on page 36](#)).

5. If your computer has WWAN capability, remove the SIM (see [SIM on page 37](#)).
6. Remove the following components:
  - a. Keyboard (see [Keyboard on page 40](#))
  - b. Hard drive (see [Mass storage devices on page 44](#))
  - c. Top cover (see [Top cover on page 46](#))

Remove the WLAN module:

1. Remove the 2 Phillips PM2.0×3.0 screws **(1)** that secure the WLAN module to the system board. (The edge of the module opposite the slot rises away from the computer.)
2. Disconnect the wireless antenna cables **(2)** from the terminals on the WLAN module.
3. Remove the WLAN module **(3)** by pulling the module away from the slot at an angle.

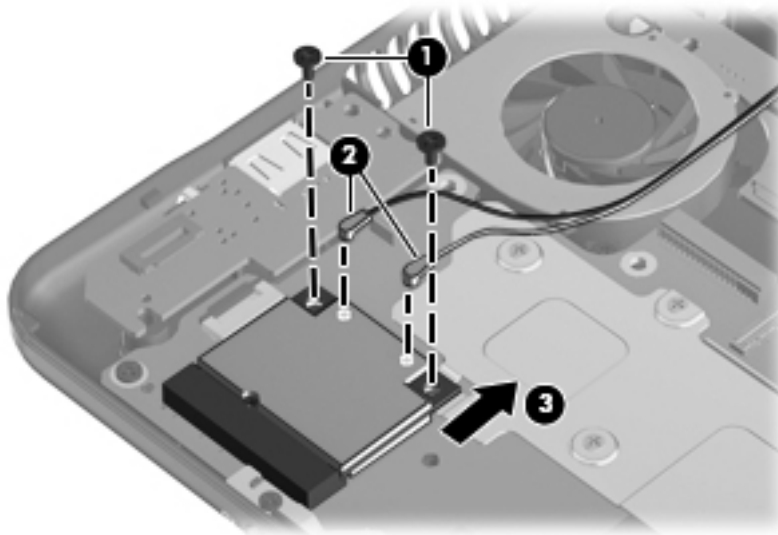

Reverse this procedure to install the WLAN module.

## WWAN module

 **NOTE:** Not available for computers with Mobile Mi installed.

Description	Spare part number
Qualcomm EV-DO/HSPA WWAN module	531993-001

△ **CAUTION:** The WWAN module and the WLAN module are not interchangeable.

To prevent an unresponsive system, replace the wireless module only with a wireless module authorized for use in the computer by the governmental agency that regulates wireless devices in your country or region. If you replace the module and then receive a warning message, remove the module to restore computer functionality, and then contact technical support.

Before removing the WWAN module, follow these steps:

1. Shut down the computer. If you are unsure whether the computer is off or in Hibernation, turn the computer on, and then shut it down through the operating system.
2. Disconnect all external devices connected to the computer.
3. Disconnect the power from the computer by first unplugging the power cord from the AC outlet and then unplugging the AC adapter from the computer.
4. Remove the battery (see [Battery on page 36](#)).
5. Remove the SIM (see [SIM on page 37](#)).
6. Remove the following components:
  - a. Keyboard (see [Keyboard on page 40](#))
  - b. Hard drive or solid-state drive (see [Mass storage devices on page 44](#))
  - c. Top cover (see [Top cover on page 46](#))

Remove the WWAN module:

1. Remove the 2 Phillips PM2.0×3.0 screws **(1)** that secure the WWAN connector module **(3)** to the system board. (The edge of the module opposite the slot rises away from the computer.)
2. Disconnect the wireless antenna cables **(2)** from the terminals on the WWAN module.

 **NOTE:** The red WWAN antenna cable is connected to the WWAN module “Main” terminal. The blue WWAN antenna cable is connected to the WWAN module “Aux” terminal.

3. Remove the WWAN module **(3)** by pulling the module away from the slot at an angle.

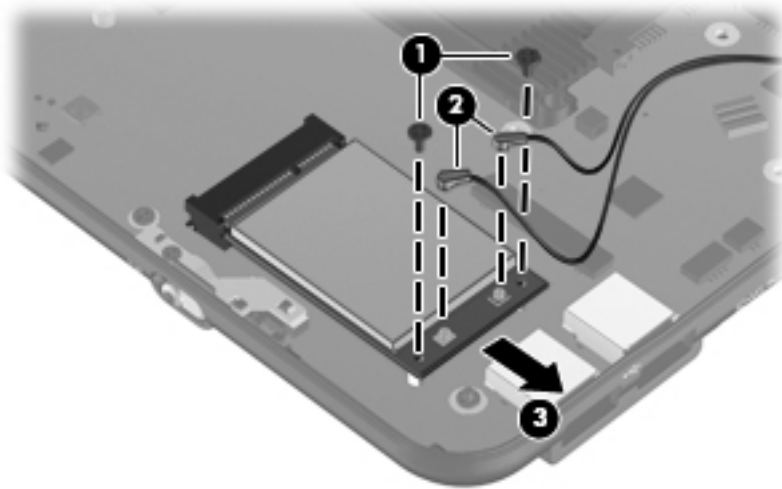

Reverse this procedure to install the WWAN module.

## USB/audio board

Description	Spare part number
USB/audio board (includes cable)	600124-001

Before removing the USB/audio board, follow these steps:

1. Shut down the computer. If you are unsure whether the computer is off or in Hibernation, turn the computer on, and then shut it down through the operating system.
2. Disconnect all external devices connected to the computer.
3. Disconnect the power from the computer by first unplugging the power cord from the AC outlet and then unplugging the AC Adapter from the computer.
4. Remove the battery (see [Battery on page 36](#)).
5. If your computer has WWAN capability, remove the SIM (see [SIM on page 37](#)).
6. Remove the following components:
  - a. Keyboard (see [Keyboard on page 40](#)).
  - b. Hard drive (see [Mass storage devices on page 44](#)).
  - c. Top cover (see [Top cover on page 46](#)).

Remove the USB board:

1. Release the ZIF connector **(1)** to which the USB/audio board cable is connected, and disconnect the cable **(2)**.
2. Release the USB/audio board from the clip attached to the base enclosure **(3)**, and remove the USB/audio board **(4)**.

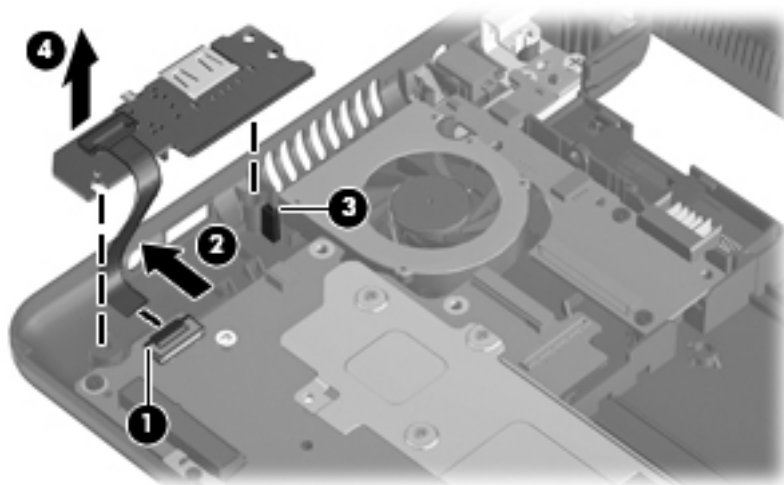

Reverse this procedure to install the USB/audio board.

## DC connector/power board

Description	Spare part number
DC connector/power board	581326-001

Before removing the power/battery pass-through board, follow these steps:

1. Shut down the computer. If you are unsure whether the computer is off or in Hibernation, turn the computer on, and then shut it down through the operating system.
2. Disconnect all external devices connected to the computer.
3. Disconnect the power from the computer by first unplugging the power cord from the AC outlet and then unplugging the AC adapter from the computer.
4. Remove the battery (see [Battery on page 36](#)).
5. If your computer has WWAN capability, remove the SIM (see [SIM on page 37](#)).
6. Remove the following components:
  - a. Keyboard (see [Keyboard on page 40](#))
  - b. Hard drive (see [Mass storage devices on page 44](#))
  - c. Top cover (see [Top cover on page 46](#))

Remove the power/battery pass-through board:

1. Disconnect the power cable **(1)**.
2. Remove the 2 Phillips PM2.5×4.0 screws **(2)** that secure the power/battery pass-through board to the base enclosure.
3. Remove the power/battery pass-through board **(3)**.

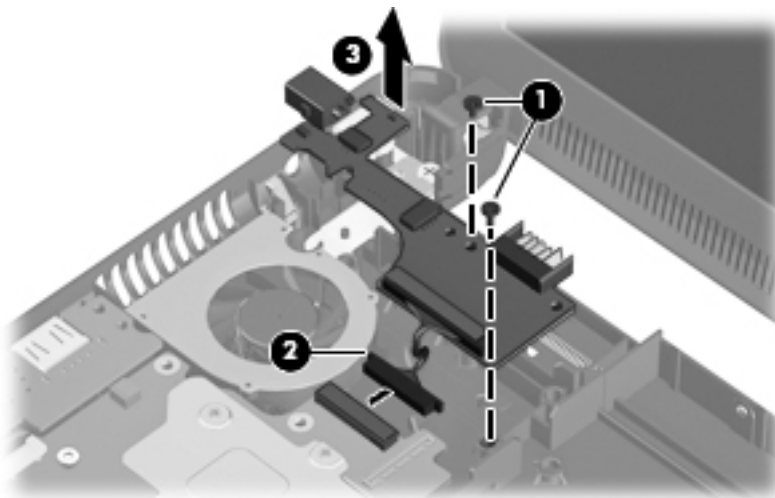

Reverse this procedure to install the power/battery pass-through board.

## Fan

Description	Spare part number
Fan	537613-001

 **NOTE:** To properly ventilate the computer, allow at least a **7.6-cm** (3-in) clearance on the left side of the computer. The computer uses an electric fan for ventilation. The fan is controlled by a temperature sensor and is designed to turn on automatically when high temperature conditions exist. These conditions are affected by high external temperatures, system power consumption, power management/battery conservation configurations, battery fast charging, and software requirements. Exhaust air is displaced through the ventilation grill located on the left side of the computer.

Before removing the fan, follow these steps:

1. Shut down the computer. If you are unsure whether the computer is off or in Hibernation, turn the computer on, and then shut it down through the operating system.
2. Disconnect all external devices connected to the computer.
3. Disconnect the power from the computer by first unplugging the power cord from the AC outlet and then unplugging the AC adapter from the computer.
4. Remove the battery (see [Battery on page 36](#)).
5. If your computer has WWAN capability, remove the SIM (see [SIM on page 37](#)).
6. Remove the following components:
  - a. Keyboard (see [Keyboard on page 40](#))
  - b. Hard drive (see [Mass storage devices on page 44](#))
  - c. Top cover (see [Top cover on page 46](#))

Remove the fan:

1. Disconnect the fan cable **(1)**.
2. Remove the 2 Phillips PM2.5×4.0 screws **(2)** that secure the fan to the base enclosure.



3. Remove the fan (3).

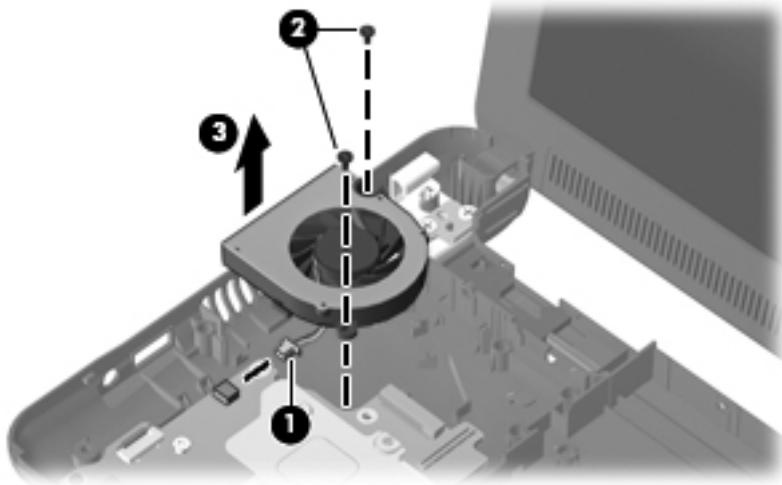

Reverse this procedure to install the fan.

## Heat sink assembly

Description	Spare part number
Heat sink assembly (includes replacement thermal material)	537619-001

Before removing the heat sink assembly, follow these steps:

1. Shut down the computer. If you are unsure whether the computer is off or in Hibernation, turn the computer on, and then shut it down through the operating system.
2. Disconnect all external devices connected to the computer.
3. Disconnect the power from the computer by first unplugging the power cord from the AC outlet and then unplugging the AC adapter from the computer.
4. Remove the battery (see [Battery on page 36](#)).
5. If your computer has WWAN capability, remove the SIM (see [SIM on page 37](#)).
6. Remove the following components:
  - a. Keyboard (see [Keyboard on page 40](#))
  - b. Hard drive (see [Mass storage devices on page 44](#))
  - c. Top cover (see [Top cover on page 46](#))
  - d. WLAN module (see [WLAN module on page 49](#))
  - e. Fan (see [Fan on page 56](#))

Remove the heat sink assembly:

1. Remove the 4 Phillips PM1.6×2.5 screws **(1)** that secure the heat sink assembly to the system board.



**NOTE:** The screws are numbered 1 through 4. Follow this order when removing the screws.

2. Remove the heat sink assembly **(2)**.

 **NOTE:** Due to the adhesive quality of the thermal material located between the heat sink assembly and system board components, it may be necessary to move the heat sink assembly from side to side to detach the assembly.

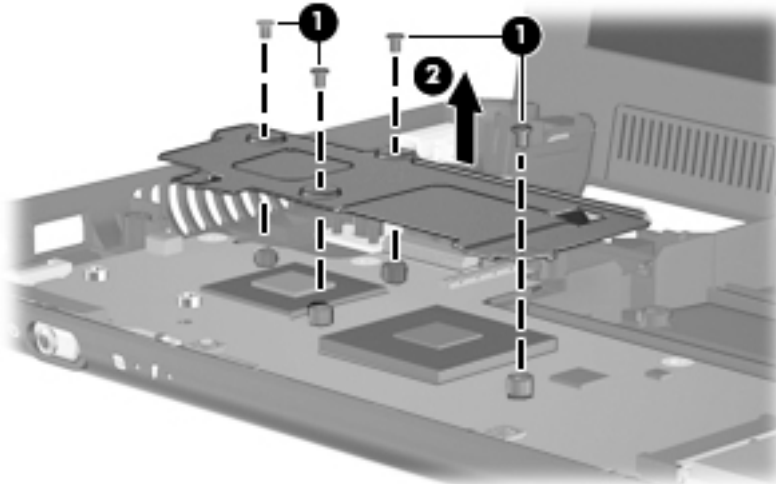

 **NOTE:** The thermal material must be thoroughly cleaned from the surfaces of the heat sink assembly and the system board each time the heat sink assembly is removed. Thermal paste is used on the processor **(1)**, and thermal tape is used on the Northbridge chip **(2)**. Replacement thermal material is included with all heat sink assembly and system board spare part kits.

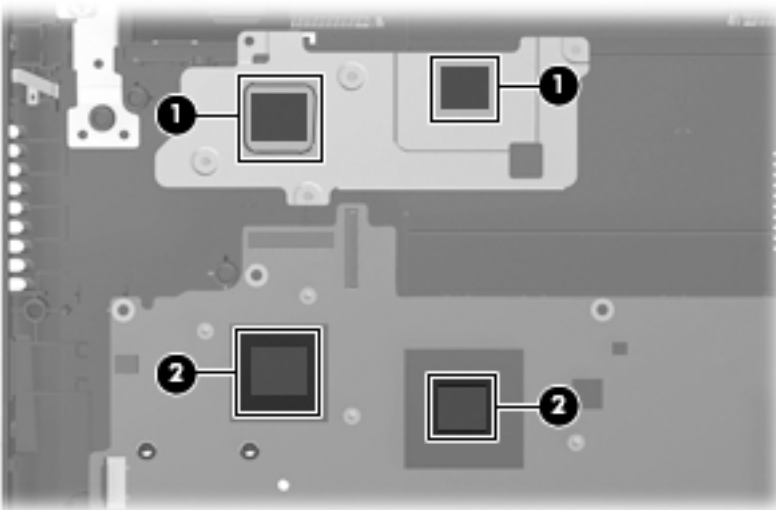

Reverse this procedure to install the heat sink assembly.

## System board

Description	Spare part number
System board (includes processor and replacement thermal material)	
<ul style="list-style-type: none"><li>• Intel Atom N270 1.6-GHz processor, 512-KB Level 2 cache, 533-MHz front-side bus (FSB)</li></ul>	594804-001
<ul style="list-style-type: none"><li>• Intel Atom N270 1.6-GHz processor, 512-KB Level 2 cache, 533-MHz front-side bus (FSB) for use with WWAN option</li></ul>	599187-001

Before removing the system board, follow these steps:

1. Shut down the computer. If you are unsure whether the computer is off or in Hibernation, turn the computer on, and then shut it down through the operating system.
2. Disconnect all external devices connected to the computer.
3. Disconnect the power from the computer by first unplugging the power cord from the AC outlet and then unplugging the AC adapter from the computer.
4. Remove the battery (see [Battery on page 36](#)).
5. If your computer has WWAN capability, remove the SIM (see [SIM on page 37](#)).
6. Remove the following components:
  - a. Keyboard (see [Keyboard on page 40](#))
  - b. Hard drive (see [Mass storage devices on page 44](#))
  - c. Top cover (see [Top cover on page 46](#))

When replacing the system board, be sure that the following components are removed from the defective system board and installed on the replacement system board:

- WLAN module (see [WLAN module on page 49](#))
- WWAN module, if included (see [WWAN module on page 52](#))
- RTC battery (see [RTC battery on page 43](#))
- Heat sink assembly (see [Heat sink assembly on page 58](#))

Remove the system board:

1. Release the tape securing the WWAN antennas **(1)**.

2. Disconnect the following cables from the system board:
  - (2) Display panel cable
  - (3) Microphone cable
  - (4) Speaker cable
  - (5) WLAN cables
  - (6) WWAN cables (select models only)

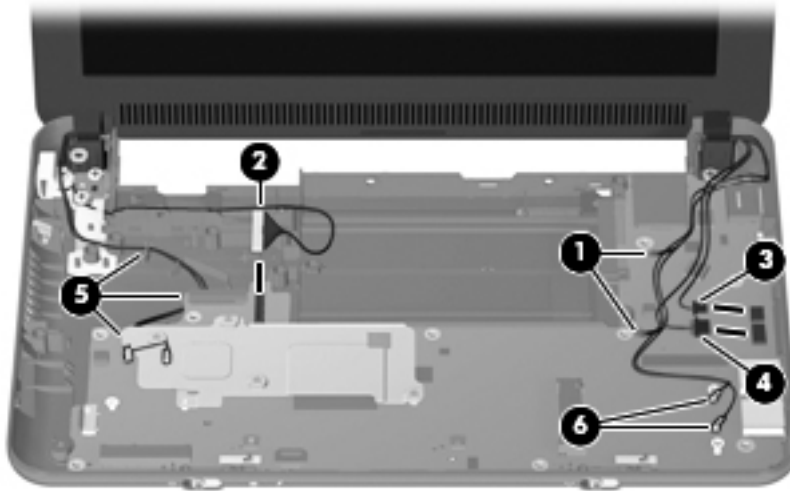

3. Remove the 2 Phillips PM1 .6x2.0 screws (1) that secure the actuators for the power switch and wireless on/off switch to the system board.
4. Remove the actuators (2).

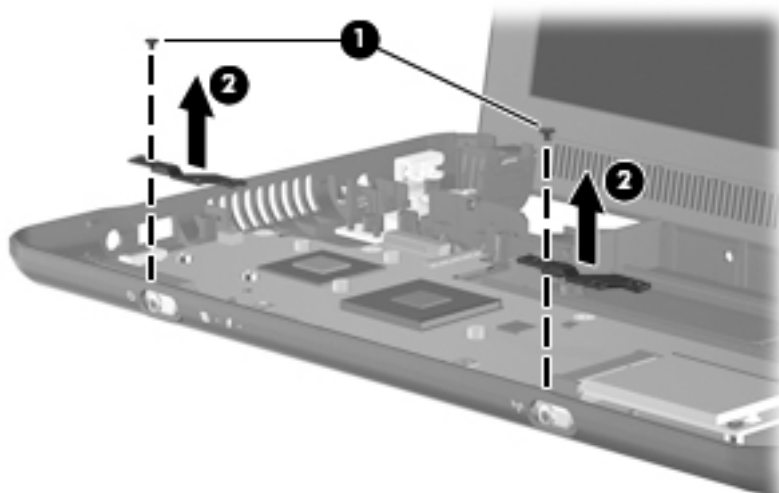

5. Remove the 3 Phillips PM2.5×4.0 screws that secure the system board to the base enclosure.

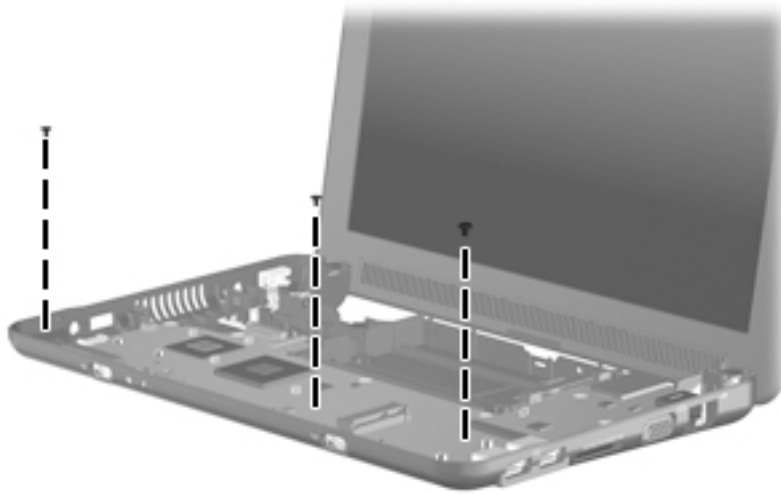

6. Grasp the system board at the midpoint of the left side **(1)**, and lift it up.
7. Pull the system board **(2)** out to the left at an angle to remove it.

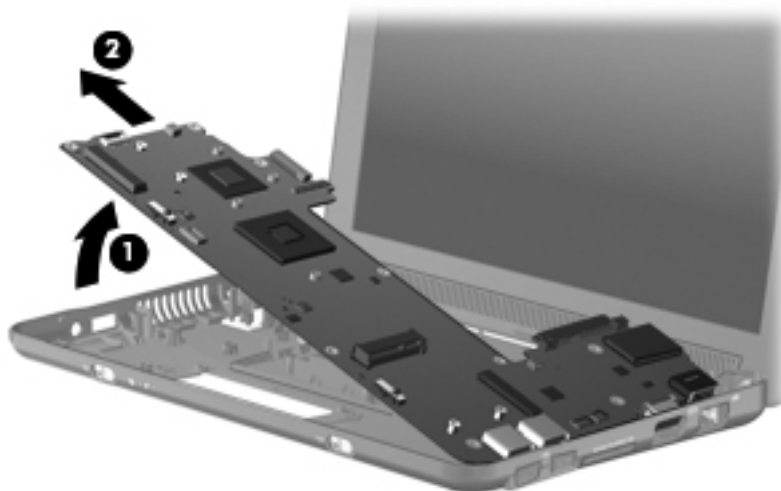

8. Remove the system board.

Reverse the procedure to install the system board.

## Display assembly

 **NOTE:** Each display assembly spare part kit includes 1 webcam, 1 microphone, 2 speakers, and 2 WLAN antenna assemblies; 2 WWAN antenna assemblies on select models.

Description	Spare part number
Display assembly, <b>25.7-cm</b> (10.1-in), WSVGA, AntiGlare for use with WWAN	594806-001
Display panel, <b>25.7-cm</b> (10.1-in), WSVGA, non-PMMA, AntiGlare, LED	600125-001
Hinge covers	537617-001
Display bezel with logo for use with webcam and microphone	537644-001
Display hinge kit	537658-001
Includes left and right display panel hinges	
Speaker assembly	594811-001
Includes 2 speakers, cable, and housing	
Webcam module	537660-001
Display cable kit	579571-001
Includes display/webcam cable and WLAN antennas	
Microphone assembly (44 dB, 4.9 × 2.2, omnidirectional)	581323-001
WWAN antenna assemblies with cables	538022-001
Display back cover with logo	594808-001
Display screw kit (not illustrated)	538510-001

Before removing the display assembly, follow these steps:

1. Shut down the computer. If you are unsure whether the computer is off or in Hibernation, turn the computer on, and then shut it down through the operating system.
2. Disconnect all external devices connected to the computer.
3. Disconnect the power from the computer by first unplugging the power cord from the AC outlet and then unplugging the AC adapter from the computer.
4. Remove the battery (see [Battery on page 36](#)).
5. If your computer has WWAN capability, remove the SIM (see [SIM on page 37](#)).
6. Remove the following components:
  - a. Keyboard (see [Keyboard on page 40](#))
  - b. Hard drive (see [Mass storage devices on page 44](#))
  - c. Top cover (see [Top cover on page 46](#))

Remove the display assembly:

1. Release the tape securing the WWAN antennas **(1)**.
2. Disconnect the following cables from the system board:
  - (2)** Display panel cable
  - (3)** Microphone cable
  - (4)** Speaker cable
  - (5)** WLAN cables
  - (6)** WWAN cables (select models only)

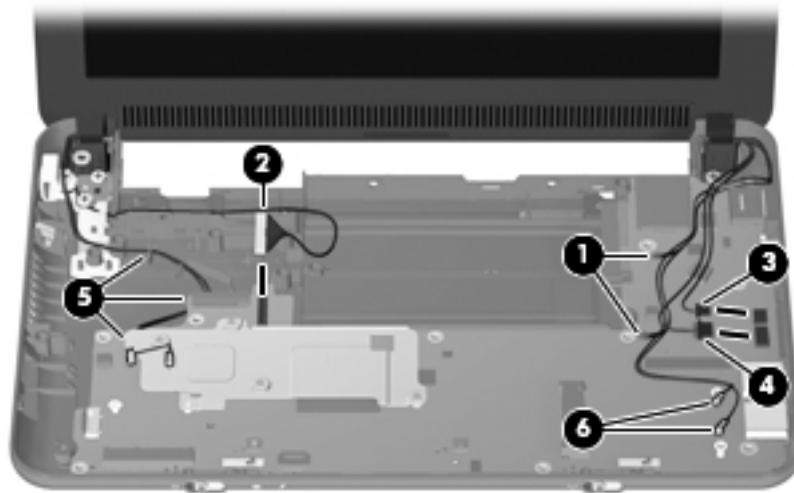

△ **CAUTION:** Support the display assembly when removing the following screws. Failure to support the display assembly can result in damage to the display assembly and other computer components.

3. Remove the 4 Phillips PM2.5×4.0 screws **(1)** that secure the display assembly to the computer.

📝 **NOTE:** One screw on the left hinge **(2)** also secures the display panel cable ground strap.



4. Remove the display assembly **(3)**.

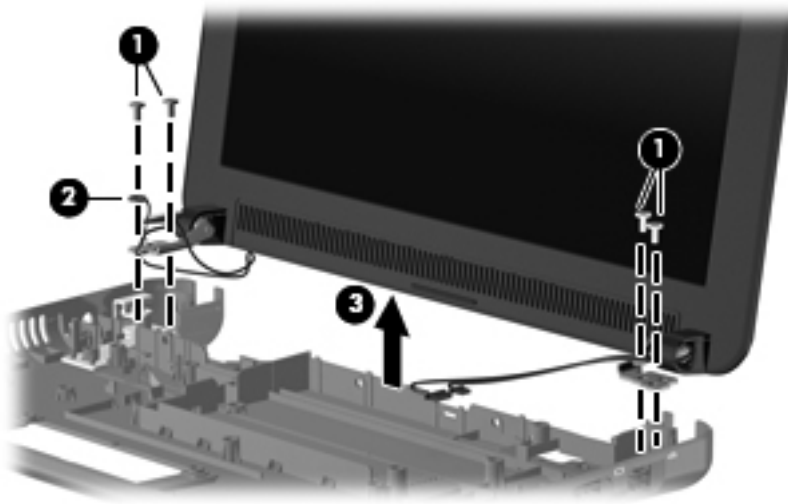

5. If it is necessary to replace the display bezel, perform the following steps:
- a. Remove the display hinge covers **(1)**.
  - b. Flex the inside edges of the top and bottom **(2)**, and then the left and right sides **(3)** of the display bezel until the bezel disengages from the display enclosure.
  - c. Remove the display bezel **(4)**.

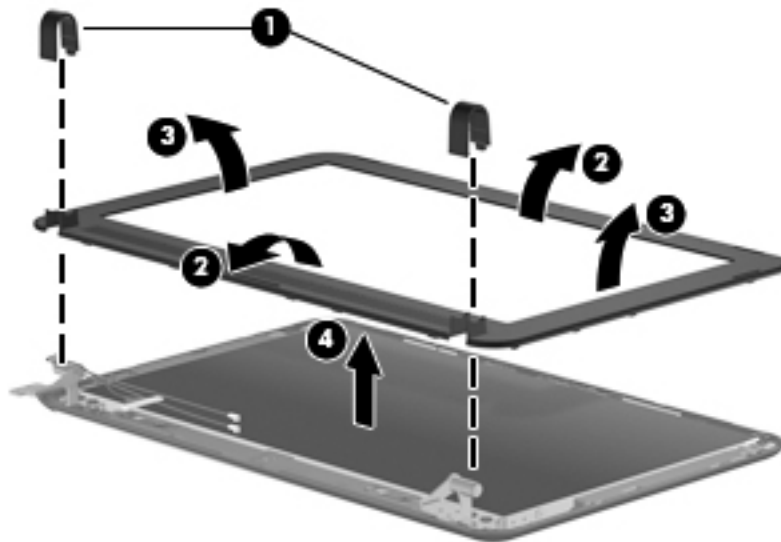

6. If it is necessary to replace the display panel, perform the following steps:
- Remove the 7 Phillips PM2.0×3.0 screws that secure the display panel to the display enclosure.

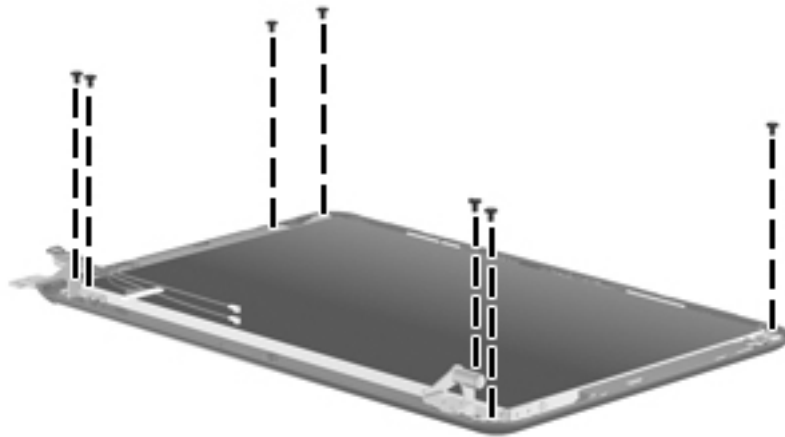

- Lift the display panel up from the display enclosure **(1)**.
- Disconnect the webcam cable **(2)** from the system board **(2)**.
- Remove the display panel **(3)** from the display enclosure.

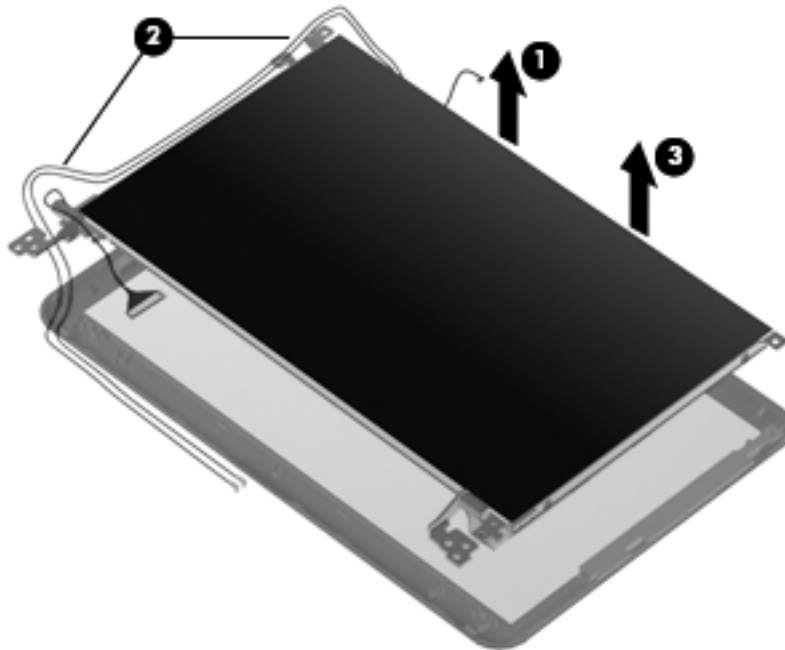

7. If it is necessary to replace the speaker assembly, perform the following steps:
- Remove the two Phillips PM2.0×3.0 screws **(1)** that secure the speaker assembly to the display enclosure.

- b. Remove the speaker assembly (2).

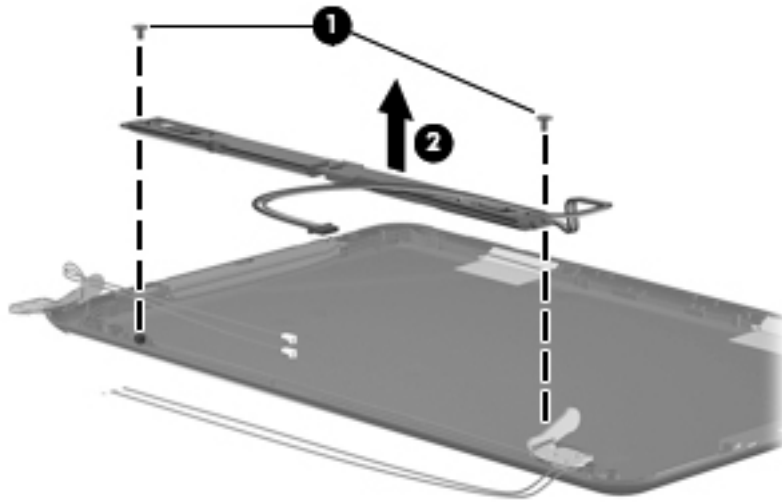

8. If it is necessary to replace the display hinges, perform the following steps:

- a. Remove the 2 Phillips PM2.0x3.0 screws (1) that secure each hinge to the display enclosure.
- b. Remove the hinges (2).

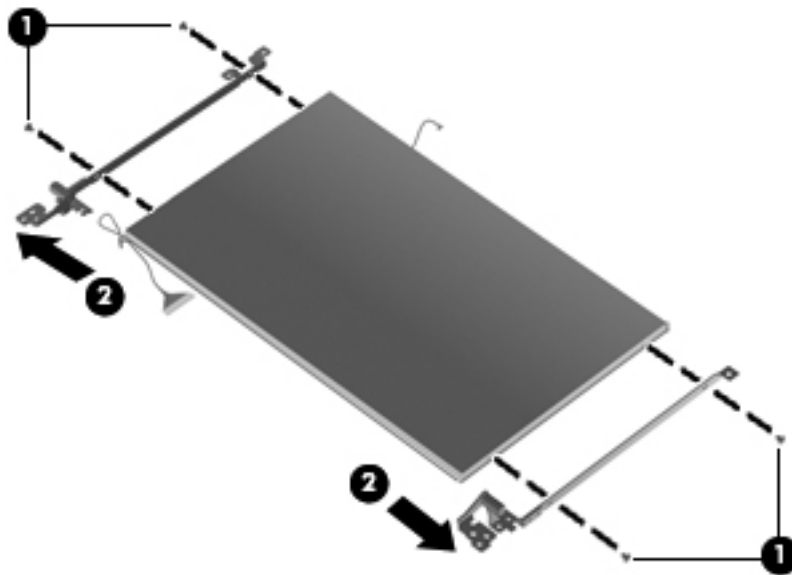

9. If it is necessary to replace the display panel cable, perform the following steps:

- a. Peel back the Mylar protection on the back of the display panel (1).

- b.** Disconnect the display panel cable **(2)**.

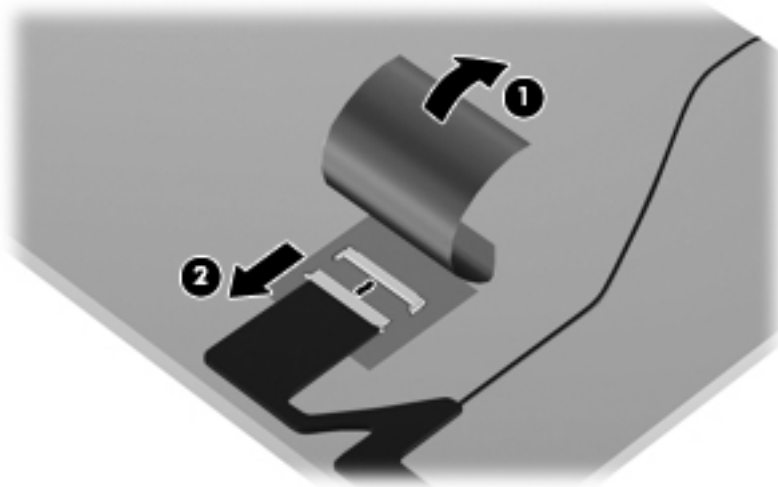

- 10.** If it is necessary to replace the webcam module, perform the following steps:

- a.** Disconnect the webcam cable **(1)** from the webcam.
- b.** Remove the webcam **(2)**.

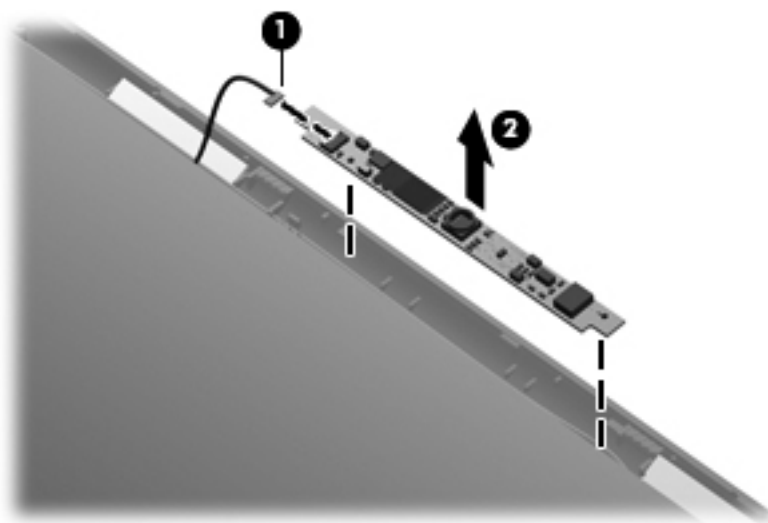

- 11.** If it is necessary to replace the microphone receiver, perform the following steps:

- a.** Release the microphone receiver from the clip **(1)** that secures it to the display enclosure.

- b. Pull the receiver through the tabs **(2)**, and remove the microphone receiver **(3)**.

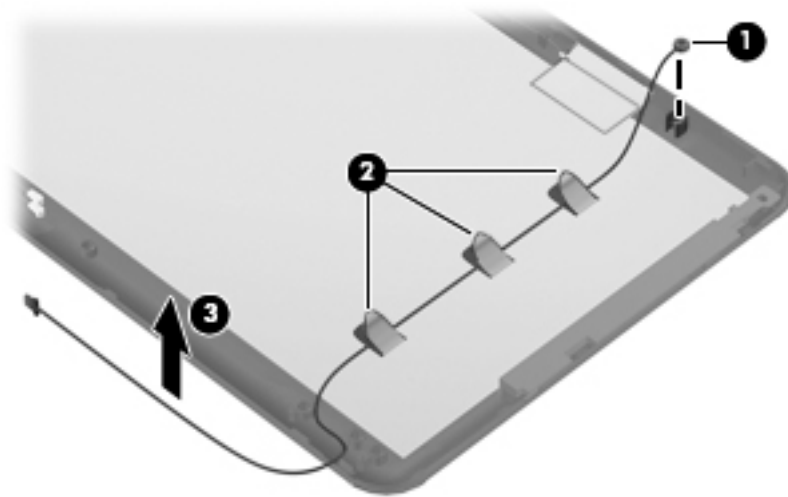

12. If it is necessary to replace the wireless antenna transceivers and cables, detach the cables from the adhesive **(1)** that secures them to the display enclosure, and then remove the cables **(2)**.

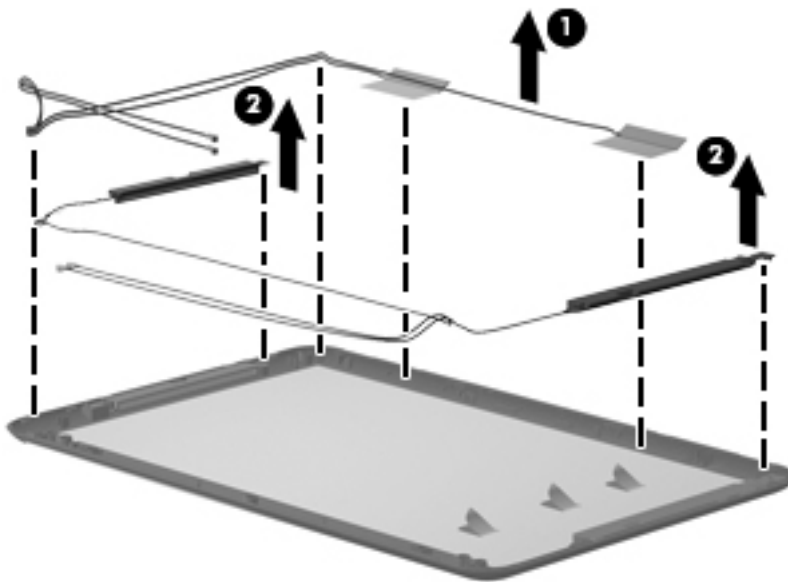

Reverse this procedure to reassemble and install the display assembly.

---

# 5 Computer Setup

## Computer Setup in Windows 7

### Starting the Setup Utility

The Setup Utility is a ROM-based information and customization utility that can be used even when your Windows operating system is not working.

The utility reports information about the device and provides settings for startup, security, and other preferences.

To start the Setup Utility:

- ▲ Open the Setup Utility by turning on or restarting the device, and then pressing **f10** while the “F10 = BIOS Setup Options” message is displayed in the lower-left corner of the screen.

### Using the Setup Utility

#### Changing the language of the Setup Utility

The following procedure explains how to change the language of the Setup Utility. If the Setup Utility is not already running, begin at step 1. If the Setup Utility is already running, begin at step 2.

1. Open the Setup Utility by turning on or restarting the device, and then pressing **f10** while the “F10 = BIOS Setup Options” message is displayed in the lower-left corner of the screen.
2. Use the arrow keys to select **System Configuration > Language**, and then press **enter**.
3. Use the arrow keys to select a language, and then press **enter**.
4. When a confirmation prompt with your language selected is displayed, press **enter**.
5. To save your change and exit the Setup Utility, use the arrow keys to select **Exit > Exit Saving Changes**, and then press **enter**.

Your change goes into effect immediately.

## Navigating and selecting in the Setup Utility

Because the Setup Utility is not Windows based, it does not support the TouchPad. Navigation and selection are by keystroke.

- To choose a menu or a menu item, use the arrow keys.
- To choose an item in a list or to toggle a field, for example an Enable/Disable field, use either the arrow keys or **f5** or **f6**.
- To select an item, press **enter**.
- To close a text box or return to the menu display, press **esc**.
- To display additional navigation and selection information while the Setup Utility is open, press **f1**.

## Displaying system information

The following procedure explains how to display system information in the Setup Utility. If the Setup Utility is not open, begin at step 1. If the Setup Utility is open, begin at step 2.

1. Open the Setup Utility by turning on or restarting the device, and then pressing **f10** while the “F10 = BIOS Setup Options” message is displayed in the lower-left corner of the screen.
2. Select the **Main** menu. System information such as the system time and date, and identification information about the device is displayed.
3. To exit the Setup Utility without changing any settings, use the arrow keys to select **Exit > Exit Discarding Changes**, and then press **enter**.

## Restoring default settings in the Setup Utility

The following procedure explains how to restore the Setup Utility default settings. If the Setup Utility is not already running, begin at step 1. If the Setup Utility is already running, begin at step 2.

1. Open the Setup Utility by turning on or restarting the device, and then pressing **f10** while the “F10 = BIOS Setup Options” message is displayed in the lower-left corner of the screen.
2. Use the arrow keys to select **Exit > Load Setup Defaults**, and then press **enter**.
3. When the Setup Confirmation is displayed, press **enter**.
4. To save your change and exit the Setup Utility, use the arrow keys to select **Exit > Exit Saving Changes**, and then press **enter**.

The Setup Utility default settings go into effect when the device restarts.

---

 **NOTE:** Your password, security, and language settings are not changed when you restore the factory default settings.

---

## Exiting the Setup Utility

You can exit the Setup Utility with or without saving changes.

- To exit the Setup Utility and save your changes from the current session:

If the Setup Utility menus are not visible, press **esc** to return to the menu display. Then use the arrow keys to select **Exit > Exit Saving Changes**, and then press **enter**.

- To exit the Setup Utility without saving your changes from the current session:

If the Setup Utility menus are not visible, press **esc** to return to the menu display. Then use the arrow keys to select **Exit > Exit Discarding Changes**, and then press **enter**.

After either choice, the device restarts in Windows.

## Setup Utility menus

The menu tables in this section provide an overview of Setup Utility options.

 **NOTE:** Some of the Setup Utility menu items listed in this chapter may not be supported by your device.

### Main menu

Select	To do this
System information	<ul style="list-style-type: none"><li>• View and change the system time and date.</li><li>• View identification information about the device.</li><li>• View specification information about the processor, memory size, and system BIOS.</li></ul>

### Security menu

Select	To do this
Administrator password	Enter, change, or delete an administrator password.
Power-On Password	Enter, change, or delete a power-on password.

### System Configuration menu

Select	To do this
Language Support	Change the Setup Utility language.



Select	To do this
Processor C4 State	Enable/disable the processor C4 sleep state.
Boot Options	<p>Set the following boot options:</p> <ul style="list-style-type: none"> <li>• <b>f10</b> and <b>f12</b> Delay (sec.)—Set the delay for the <b>f10</b> and <b>f12</b> functions of the Setup Utility in intervals of 5 seconds each (0, 5, 10, 15, 20).</li> <li>• Internal Network Adapter boot—Enable/disable boot from Internal Network Adapter.</li> <li>• Boot Order—Set the boot order for: <ul style="list-style-type: none"> <li>◦ Internal hard drive (select models only)</li> <li>◦ USB Floppy</li> <li>◦ USB CD/DVD ROM Drive</li> <li>◦ USB flash drive</li> <li>◦ USB Hard drive</li> <li>◦ USB Card Reader</li> <li>◦ Network adapter</li> </ul> </li> </ul> <p><b>NOTE:</b> Only the devices attached to the system will appear in the boot order menu.</p>

## Diagnostics menu

Select	To do this
Hard Disk Self Test (select models only)	Run a comprehensive self-test on the hard drive.
Memory Test	Run a diagnostic test on the system memory.

# Computer Setup in Windows XP

## Starting Setup Utility

Setup Utility is a ROM-based information and customization utility that can be used even when your Windows operating system is not working.

The utility reports information about the computer and provides settings for startup, security, and other preferences.

To start Setup Utility:

- ▲ Open Setup Utility by turning on or restarting the computer, and then pressing **f10** while the “F10 = BIOS Setup Options” message is displayed in the lower-left corner of the screen.

## Using Setup Utility

### Changing the language of Setup Utility

The following procedure explains how to change the language of Setup Utility. If Setup Utility is not already running, begin at step 1. If Setup Utility is already running, begin at step 2.

1. Open Setup Utility by turning on or restarting the computer, and then pressing **f10** while the “F10 = BIOS Setup Options” message is displayed in the lower-left corner of the screen.
2. Use the arrow keys to select **System Configuration > Language**, and then press **enter**.
3. Use the arrow keys to select a language, and then press **enter**.
4. When a confirmation prompt with your language selected is displayed, press **enter**.
5. To save your change and exit Setup Utility, use the arrow keys to select **Exit > Exit Saving Changes**, and then press **enter**.

Your change goes into effect immediately.

### Navigating and selecting in the Setup Utility

Because Setup Utility is not Windows based, it does not support the TouchPad. Navigation and selection are by keystroke.

- To choose a menu or a menu item, use the arrow keys.
- To choose an item in a list or to toggle a field, for example an Enable/Disable field, use either the arrow keys or **f5** or **f6**.
- To select an item, press **enter**.
- To close a text box or return to the menu display, press **esc**.
- To display additional navigation and selection information while the Setup Utility is open, press **f1**.

## Displaying system information

The following procedure explains how to display system information in the Setup Utility. If the Setup Utility is not open, begin at step 1. If the Setup Utility is open, begin at step 2.

1. Open the Setup Utility by turning on or restarting the computer, and then pressing **f10** while the "F10 = BIOS Setup Options" message is displayed in the lower-left corner of the screen.
2. Select the **Main** menu. System information such as the system time and date, and identification information about the computer is displayed.
3. To exit the Setup Utility without changing any settings, use the arrow keys to select **Exit > Exit Discarding Changes**, and then press **enter**.

## Restoring default settings in the Setup Utility

The following procedure explains how to restore the Setup Utility default settings. If the Setup Utility is not already running, begin at step 1. If the Setup Utility is already running, begin at step 2.

1. Open the Setup Utility by turning on or restarting the computer, and then pressing **f10** while the "F10 = BIOS Setup Options" message is displayed in the lower-left corner of the screen.
2. Use the arrow keys to select **Exit > Load Setup Defaults**, and then press **enter**.
3. When the Setup Confirmation is displayed, press **enter**.
4. To save your change and exit the Setup Utility, use the arrow keys to select **Exit > Exit Saving Changes**, and then press **enter**.

The Setup Utility default settings go into effect when the computer restarts.

---

 **NOTE:** Your password, security, and language settings are not changed when you restore the factory default settings.

---

## Exiting the Setup Utility

You can exit the Setup Utility with or without saving changes.

- To exit the Setup Utility and save your changes from the current session:  
If the Setup Utility menus are not visible, press **esc** to return to the menu display. Then use the arrow keys to select **Exit > Exit Saving Changes**, and then press **enter**.
- To exit the Setup Utility without saving your changes from the current session:  
If the Setup Utility menus are not visible, press **esc** to return to the menu display. Then use the arrow keys to select **Exit > Exit Discarding Changes**, and then press **enter**.

After either choice, the computer restarts and loads the operating system.

## Setup Utility menus

The menu tables in this section provide an overview of Setup Utility options.

---

 **NOTE:** Some of the Setup Utility menu items listed in this chapter may not be supported by your computer.

---

## Main menu

Select	To do this
System information	<ul style="list-style-type: none"><li>• View and change the system time and date.</li><li>• View identification information about the computer.</li><li>• View specification information about the processor, memory size, and system BIOS.</li></ul>

## Security menu

Select	To do this
Administrator password	Enter, change, or delete an administrator password.
Power-On Password	Enter, change, or delete a power-on password.

## System Configuration menu

Select	To do this
Language Support	Change the Setup Utility language.
Processor C4 State	Enable/disable the processor C4 sleep state.
Boot Options	<p>Set the following boot options:</p> <ul style="list-style-type: none"><li>• <b>f10</b> and <b>f12</b> Delay (sec.)—Set the delay for the <b>f10</b> and <b>f12</b> functions of the Setup Utility in intervals of 5 seconds each (0, 5, 10, 15, 20).</li><li>• Internal Network Adapter boot—Enable/disable boot from Internal Network Adapter.</li><li>• Boot Order—Set the boot order for:<ul style="list-style-type: none"><li>◦ Internal hard drive (select models only)</li><li>◦ USB Floppy</li><li>◦ USB CD/DVD ROM Drive</li><li>◦ USB flash drive</li><li>◦ USB Hard drive</li><li>◦ USB Card Reader</li><li>◦ Network adapter</li></ul></li></ul> <p><b>NOTE:</b> Only the devices attached to the system will appear in the boot order menu.</p>

## Diagnostics menu

Select	To do this
Hard Disk Self Test (select models only)	Run a comprehensive self-test on the hard drive.
Memory Test	Run a diagnostic test on the system memory.

# 6 Specifications

## Computer specifications

<b>Dimensions</b>	
Depth	<b>16.67 cm</b> (6.56 in)
Width	<b>26.17 cm</b> (10.30 in)
Height	<b>2.52 cm</b> (0.99 in)
<b>Weight</b>	
<b>25.7-cm</b> (10.1-in) LCD, equipped with a 3-cell battery, hard drive, 1-GB memory, WLAN module, and 2 wireless antennas	<b>1.17 kg</b> (2.57 lbs)
<b>Input power</b>	
Operating voltage	19 V dc @ 1.58 A - 30 W
Operating current	1.58 A
<b>Temperature</b>	
Operating	<b>5°C to 35°C</b> (41°F to 95°F)
Nonoperating	<b>-20°C to 65°C</b> (-4°F to 149°F)
<b>Relative humidity</b> (noncondensing)	
Operating	10% to 90%
Nonoperating	0% to 95%
<b>Maximum altitude</b> (unpressurized)	
Operating	<b>-15 m to 3,048 m</b> (-50 ft to 10,000 ft)
Nonoperating	<b>-15 m to 12,192 m</b> (-50 ft to 40,000 ft)
<b>Shock</b>	
Operating	125 g, 2 ms, half-sine
Nonoperating	200 g, 2 ms, half-sine
<b>Random vibration</b>	
Operating	0.75 g zero-to-peak, 10 Hz to 500 Hz, 0.25 oct/min sweep rate

---

Nonoperating

1.50 g zero-to-peak, 10 Hz to 500 Hz, 0.5 oct/min sweep rate

---

**NOTE:** Applicable product safety standards specify thermal limits for plastic surfaces. The computer operates well within this range of temperatures.

---

## 25.7-cm (10.1-in), WSVGA, AntiGlare display specifications

<b>Dimensions</b>	
Height	<b>12.53 cm</b> (4.93 in)
Width	<b>22.27 cm</b> (8.77 in)
Diagonal	<b>25.55 cm</b> (10.06 in)
<b>Number of colors</b>	262,144
<b>Contrast ratio</b>	400:1 (typical)
<b>Brightness</b>	200 nits (typical)
<b>Pixel resolution</b>	
Pitch	0.2175 × 0.2175 mm
Format	1024 × 600
Configuration	RGB vertical stripe
<b>Backlight</b>	Edge lit
<b>Character display</b>	80 × 25
<b>Total power consumption</b>	3.0 W
<b>Viewing angle</b>	±40° horizontal, +20/-40° vertical (typical)



# Hard drive specifications

<b>160-GB*</b>	
<b>Dimensions</b>	
Height	<b>9.5 mm</b> (0.37 in)
Width	<b>70 mm</b> (2.76 in)
Weight	<b>101 g</b> (3.56 oz)
<b>Interface type</b>	SATA
<b>Transfer rate</b>	100 MB/sec
<b>Security</b>	ATA security
<b>Seek times</b> (typical read, including setting)	
Single track	3 ms
Average	13 ms
Maximum	24 ms
<b>Logical blocks</b>	117,210,240
<b>Disc rotational speed</b>	5400 rpm
<b>Operating temperature</b>	<b>5°C to 55°C</b> (41°F to 131°F)
* 1 GB = 1 billion bytes when referring to hard drive storage capacity. Actual accessible capacity is less. Actual drive specifications may differ slightly.	
<b>NOTE:</b> Certain restrictions and exclusions apply. Contact technical support for details.	

# Solid-state drive specifications

<b>Performance</b>	
Transfer modes supported	UDMA 0-4, Multiword-DMA 0-2, PIO 0-4
Read	94902 KB/sec
Write	26743 KB/sec
<b>Characteristics</b>	
Interface	Serial ATA revision 2.6
Flash type	MLC (LBG) NAND
Flash capacity	16 GB
<b>Electrical specifications</b>	
DC supply voltage	5.0 V $\pm$ 5%
Standby current	130 mA (typical)
Active current	Read = 210.1 mA (average) Write = 225.9 mA (average)
<b>Environmental specifications</b>	
Operating temperature	<b>0°C to +70°C</b> (32°F to 158°F)
Storage temperature	<b>-40°C to +85°C</b> (-40°F to 185°F)
Operating altitude	up to <b>24,384 m</b> (80,000 feet)
Humidity	5% to 90% non-condensing
Shock	1,000 g
Acoustic noise	0 dB
Vibration	15 g (peak to peak)
<b>Physical specifications</b>	
Connector	7+15 pin SATA connector
Weight	8.5 $\pm$ 1 g
Dimensions	<b>54 x 39 x 6.4 mm</b> (2.13 x 1.54 x 0.25 in)
<b>Regulations and compliance</b>	
	RoHS, China RoHS, SGS ROHS, FCC, CE UL – PCB Only

# System resource specifications

You can use Device Manager to get a graphical view of the system resources that control how the devices work on the computer. System resources you can access from Device Manager are direct memory access (DMA) channels, input/output (I/O) ports, interrupt request (IRQ) lines, and memory addresses.

If two devices require the same resource and create a device conflict, you can manually change the resource settings in Device Manager to be sure each setting is unique.

---

△ **CAUTION:** Improperly changing resource settings can disable your hardware and cause your computer to malfunction or become inoperable. Only users who have expert knowledge of computer hardware and hardware configurations should change resource settings.

---

To view resource settings in Windows 7 and Windows Vista:

1. Select **Start > Computer**.
2. Click **System properties** near the top of the Computer folder.
3. On the left, click **Device Manager**.
4. On the **View** menu, click one of the following:
  - **Resources by type**
  - **Resources by connection**

To view resource settings in Windows XP:

1. Select **Start > My Computer**, or double-click **My Computer** on the desktop.
2. Under System Tasks, click **View system information**.
3. In the System Properties window, select the **Hardware** tab.
4. Click **Device Manager**.
5. On the **View** menu, click one of the following:
  - **Resources by type**
  - **Resources by connection**

---

# 7 Backup and recovery

Select the section in this chapter that applies to the operating system installed on your computer.

# Windows 7 backup and recovery

Use the instructions in the section if Windows 7 is installed on your computer.

To protect your information, back up your files and folders. In case of system failure, you can use the backup files to restore your computer.

---

△ **CAUTION:** In the event of a hard drive failure, you cannot use your computer to access the Disaster Recovery utility. Therefore, HP recommends that you download the Disaster Recovery utility SoftPaq, and then extract it to a USB flash drive as soon as possible after software setup. For details, refer to “Downloading and extracting the Disaster Recovery utility” later in this chapter.

---

Depending on your computer model, you may have one of the following backup and recovery solutions:

- Roxio BackOnTrack
- HP Recovery Manager

---

 **NOTE:** For detailed information, perform a search for these topics in Help and Support.

---

## Backing up and recovering using Roxio BackOnTrack

Successful recovery after a system failure depends on whether you have completely backed up your files. If Roxio BackOnTrack is preinstalled on your computer, BackOnTrack allows you to create a backup of your computer image. You should create the initial backup immediately after software setup. As you add new software and data files, you should continue to back up your system on a regular basis to maintain a reasonably current backup.

Note the following guidelines when backing up your information:

- Store personal files in the Documents library and back up this folder regularly.
- Back up templates stored in their associated programs.
- Save customized settings in a window, toolbar, or menu bar by taking a screen shot of your settings. The screen shot can be a time-saver if you have to reset your preferences.

To copy the screen and paste it into a word-processing document, follow these steps:

1. Display the screen.
2. Copy the screen:
  - To copy the active window, press **alt+fn+prt sc**.
  - To copy the entire screen, press **fn+prt sc**.
3. Open a word-processing document, select **Edit>Paste**.
4. Save the document.

## Creating a copy of the hard drive

The *back up drive* function of BackOnTrack creates a Disaster Recovery Set that is an exact image of your hard drive data. You can back up the image to an external hard drive (purchased separately).

To create a Disaster Recovery Set using BackOnTrack, follow these steps:

---

 **NOTE:** Be sure that the computer is connected to AC power before you start the backup process.

---

1. Select **Start>All Programs> Roxio**.
2. Select **BackOnTrack>BackOnTrack Home>Disaster Recovery**.
3. Select **Backup drive**.
4. Select a drive to back up.
5. Add a comment to describe the backup.

---

 **NOTE:** Comments are optional, but adding comments can help you remember the purpose of the backup. The date and list of drives being backed up are automatically included in the description.

---

6. Select a destination for the Disaster Recovery Set.

---

 **NOTE:** The destination cannot be a network drive.

---

7. Select the action button at the bottom-right of the computer screen.
8. Follow the on-screen instructions.

## Performing a recovery

In case of system failure or instability, the computer provides the following ways to recover your files:

- BackOnTrack Disaster Recovery utility: You can use Disaster Recovery to recover your hard drive image (including your files, programs, and operating system) after a hard drive failure.
- BackOnTrack Instant Restore utility: You can use Instant Restore to quickly restore your computer to a working state if a software-related problem occurs. The Instant Restore utility automatically creates working states periodically. You can also define a working state by saving the current computer state manually.

---

 **NOTE:** For more information about computer system states, refer to the BackOnTrack software help.

---

## Using the Disaster Recovery utility

---

 **NOTE:** To perform a recovery with Disaster Recovery, you need a USB flash drive (purchased separately). For optimum performance, the capacity of the drive should be no larger than 2 GB.

---

Disaster Recovery recovers data from a Disaster Recovery Set that you previously created with Roxio BackOnTrack. Disaster Recovery is available from the HP Web site in a compressed file called a *SoftPaq*.

---

 **NOTE:** Running the SoftPaq makes the USB drive bootable.

---

- △ **CAUTION:** Before performing a disaster recovery, you must download the Disaster Recovery utility and extract it to a USB flash drive.
- 

### Downloading and extracting the Disaster Recovery utility

To download and extract Disaster Recovery, follow these steps:

1. Connect a bootable USB flash drive or external drive to a USB port on your computer.
2. Open your Web browser, go to <http://www.hp.com/support>, and select your country or region.
3. Enter the SoftPaq number SP42226 in the **Search** box, press **enter**, and then follow the on-screen instructions.
4. Select **Download only** to save the file to your computer.
5. When prompted, select **Save**, and then select the external drive from the list of storage locations.
6. After the file is downloaded, navigate to the USB flash drive or external drive, and then double-click the SoftPaq file to format the USB flash drive and extract the Disaster Recovery files.
7. If prompted to do so, restart your computer after the installation is complete.

### Restoring your hard drive image

To restore your hard drive image using Disaster Recovery, follow these steps:

1. Connect the external hard drive containing the Disaster Recovery Set to your computer.
2. Connect the bootable USB flash drive containing the extracted Disaster Recovery utility to a USB port on your computer.
3. Change the boot device order by turning on or restarting the computer, and then press **f9**.
4. Use the arrow keys to select the USB flash drive, and then press **enter**.
5. At the Roxio BackOnTrack Disaster Recovery screen, select **Disaster Recovery>Next**.
6. Browse to the external hard drive containing the Disaster Recovery Set, and then select **Next**.
7. Select **Next** to proceed with the recovery.

---

 **NOTE:** This process may take several minutes.

---

8. After a message on the screen reports a successful recovery, select **Finish**.

### Using the Instant Restore utility

You can restore your computer from Windows when the operating system is functioning. If the operating system is not functioning, you can also access the utility by restarting your computer.

---

 **NOTE:** For more information about the Instant Restore utility, refer to the BackOnTrack software Help.

---

## Using the Instant Restore utility when the operating system is functioning

To recover information when the operating system is functioning properly, follow these steps:

1. Save and close all open documents and close any open programs.
2. Select **Start>All Programs>Roxio**.
3. Select **BackOnTrack>BackOnTrack Home>Instant Restore**.
4. Select **Restore State**, and then select a restore state.
5. Select the action button in the bottom-right corner of the computer screen.
6. Select **Yes** to confirm your selected restore state.

When the restore process is complete, the computer restarts and a notification message is displayed.

## Using the Instant Restore utility when the operating system is not functioning

To recover information when the operating system is not functioning, follow these steps:

1. Restart the computer.  

---

 **NOTE:** If the operating system has stopped responding and the computer screen is blue, restart the computer by turning the power switch off and then on.

---
2. When the computer logo (HP or Compaq) is displayed on the screen, press the **F6** button repeatedly until the Windows status bar is displayed.
3. When the Roxio BackOnTrack screen is displayed, follow the on-screen instructions.

## Using Windows Backup and Restore

To create a backup using Windows Backup and Restore, follow these steps:

- 
- 
- NOTE:**
- Be sure that the computer is connected to AC power before you start the backup process.
- 

**NOTE:** The backup process may take over an hour, depending on file size and the speed of the computer.

---

1. Select **Start>All Programs>Maintenance>Backup and Restore**.
2. Follow the on-screen instructions to set up and create a backup.

---

 **NOTE:** Windows includes the User Account Control feature to improve the security of your computer. You may be prompted for your permission or password for tasks such as installing software, running utilities, or changing Windows settings. Refer to Help and Support for more information.

---

## Using system restore points

When you back up your system, you are creating a system restore point. A system restore point allows you to save and name a snapshot of your hard drive at a specific point in time. You can then revert back to that point if you want to reverse subsequent changes made to your system.



---

 **NOTE:** Recovering to an earlier restore point does not affect data files saved or e-mails created since the last restore point.

---

You also can create additional restore points to provide increased protection for your system files and settings.

## When to create restore points

- Before you add or extensively modify software or hardware.
- Periodically, whenever the system is performing optimally.

---

 **NOTE:** If you revert to a restore point and then change your mind, you can reverse the restoration.

---

## Creating a system restore point

1. Select **Start>Control Panel>System and Security>System**.
2. In the left pane, select **System protection**.
3. Select the **System Protection** tab.
4. Under **Protection Settings**, select the disk for which you want to create a restore point.
5. Select **Create**.
6. Follow the on-screen instructions.

## Restoring to a previous date and time

To revert to a restore point (created at a previous date and time) when the computer was functioning optimally, follow these steps:

1. Select **Start>Control Panel>System and Security>System**.
2. In the left pane, select **System protection**.
3. Select the **System Protection** tab.
4. Select **System Restore**.
5. Follow the on-screen instructions.

## Backing up and recovering using HP Recovery Manager

If your computer includes HP Recovery Manager, tools provided by the operating system and by HP Recovery Manager software are designed to help you with the following tasks for safeguarding your information and restoring it in case of a system failure:

- Backing up your information
- Creating a set of recovery discs
- Creating system restore points

- Recovering a program or driver
- Performing a full system recovery

## Backing up your information

As you add new software and data files, you should back up your system on a regular basis to maintain a reasonably current backup. Back up your system at the following times:

- At regularly scheduled times

---

 **NOTE:** Set reminders to back up your information periodically.

---

- Before the computer is repaired or restored
- Before you add or modify hardware or software

Note the following when backing up:

- Create system restore points using the Windows System Restore feature, and periodically copy them to a disc.
- Store personal files in the Documents library, and periodically back up this folder.
- Back up templates stored in their associated programs.
- You can back up your information to an optional external hard drive, a network drive, or discs.
- When backing up to discs, use any of the following types of discs (purchased separately): CD-R, CD-RW, DVD+R, DVD-R, or DVD±RW. The discs you use depend on the type of optical drive you are using.

---

 **NOTE:** DVDs store more information than CDs, so using them for backup reduces the number of recovery discs required.

---

- When backing up to discs, number each disc before inserting it into an optical drive.
- Save the customized settings in a window, toolbar, or menu bar by taking a screen shot of the settings. The screen shot can be a time-saver if you have to reset your preferences.

To copy the screen and paste the image into a word-processing document:

1. Display the screen.
2. Copy the screen:  
To copy only the active window, press **alt+prt sc**.  
To copy the entire screen, press **prt sc**.
3. Open a word-processing document, select **Edit> Paste**.
4. Save the document.

## Creating a set of recovery discs

HP recommends that you create recovery discs to be sure that you can restore your system to its original factory state if you experience serious system failure or instability. Create these discs after setting up the computer for the first time.

---

 **NOTE:** This task will require an optional external or shared optical drive.

---

Handle these discs carefully and keep them in a safe place. The software allows the creation of only one set of recovery discs.

Note the following guidelines before creating recovery discs:

- You will need high-quality DVD-R, DVD+R, BD-R (writable Blu-ray), or CD-R discs. All these discs are purchased separately. DVDs have a larger storage capacity than CDs. If you use CDs, up to 20 discs may be required, whereas only a few DVDs are required.

---

 **NOTE:** Double-layer discs and read-write discs—such as CD-RW, DVD±RW, and BD-RE (rewritable Blu-ray) discs—are not compatible with the Recovery Manager software.

---

- The computer must be connected to AC power during this process.
- Only one set of recovery discs can be created per computer.
- Number each disc before inserting it into an optical drive.
- If necessary, you can exit the program before you have finished creating the recovery discs. The next time you open Recovery Manager, you will be prompted to continue the disc creation process.

To create a set of recovery discs:

1. Select **Start>All Programs>Recovery Manager>Recovery Disc Creation**.
2. Follow the on-screen instructions.

## Performing a recovery

---

 **NOTE:** You can recover only files that you have previously backed up. HP recommends that you use Recovery Manager to create a set of recovery discs (entire drive backup) as soon as you set up your computer.

---

Recovery Manager software allows you to repair or restore the system if you experience system failure or instability. Recovery Manager works from recovery discs that you create or from a dedicated recovery partition (select models only) on the hard drive. However, computers that include a solid-state drive (SSD) may not have a recovery partition. If that is the case, recovery discs have been included with your computer. Use these discs to recover your operating system and software.

---

 **NOTE:** Windows has its own built-in repair features, such as System Restore. If you have not already tried these features, try them before using Recovery Manager. For more information on these built-in repair features, select **Start>Help and Support**.

---

**NOTE:** Recovery Manager recovers only the software that was preinstalled at the factory. Software not provided with this computer must be downloaded from the manufacturer's Web site or reinstalled from the disc provided by the manufacturer.

---

## Recovering using the recovery discs

To restore the system from the recovery discs:

1. Back up all personal files.
2. Insert the first recovery disc into an optional optical drive, and restart the computer.
3. Follow the on-screen instructions.

## Recovering using the partition on the hard drive (select models only)

On some models, you can perform a recovery from the partition on the hard drive, which is accessed by pressing either the Start button or **f11**. This restores the computer to its factory condition.

---

 **NOTE:** Computers with an SSD may not have a recovery partition. If the computer does not have a recovery partition, you will not be able to recover using this procedure. Recovery discs have been included for computers that do not have a partition. Use these discs to recover your operating system and software.

---

To restore the system from the partition, follow these steps:

1. Access Recovery Manager in either of the following ways:

Select **Start>All Programs>Recovery Manager>Recovery Manager**.

– or –

- a. Turn on or restart the computer.
- b. Press **f11** while the “Press f11 for recovery message is displayed on the screen.

---

 **NOTE:** It may take several minutes for Recovery Manager to load.

---

2. In the Recovery Manager window, select **System Recovery**.
3. Follow the on-screen instructions.

# Windows XP backup and recovery

Use the instructions in this section if Windows XP is installed on your computer.

To protect your information, use the Windows® Backup utility (select models only) to back up files and folders or create recovery points. In case of system failure, you can use the backup files to restore your computer.

Windows provides the following options:

- Backing up individual files and folders
- Backing up all files and folders
- Scheduling automatic backups
- Creating recovery points
- Recovering information

---

 **NOTE:** For detailed instructions, perform a search for these topics in Help and Support.

**NOTE:** In case of system instability, HP recommends that you print the recovery procedures and save them for later use.

---

## Backing up your information

Recovery after a system failure is as complete as your most current backup. You should create your initial backup immediately after software setup. As you add new software and data files, you should continue to back up your system on a regular basis to maintain a reasonably current backup.

You can back up individual files or folders to an optional external hard drive or to a network drive.

Note the following when backing up:

- Store personal files in the My Documents folder, and back it up periodically.
- Back up templates stored in their associated programs.
- Save customized settings that appear in a window, toolbar, or menu bar by taking a screen shot of your settings. The screen shot can be a time saver if you have to reset your preferences.

To copy the screen and paste it into a word-processing document:

**a.** Display the screen you want to save.

**b.** Copy the screen image:

To copy only the active window, press [alt+fn+prt sc](#).

To copy the entire screen, press [fn+prt sc](#).

**c.** Open a word-processing document, select **Edit > Paste**.

The screen image is added to the document.

**d.** Save the document.

To create a backup using the Windows Backup utility (select models only), follow these steps:

---

 **NOTE:** Be sure that the computer is connected to AC power before you start the backup process.

**NOTE:** The backup process may take over an hour, depending on file size and the speed of the computer.

---

1. Select **Start > All Programs > Accessories > System Tools > Backup**.
2. Follow the on-screen instructions.

## Performing a recovery

In case of system failure or instability, the computer provides the following tools to recover your files:

- Windows recovery tools (select models only): You can use the Windows Backup utility to recover information you have previously backed up.
- *Operating System* and *Driver Recovery* discs (included with your computer): You can use the discs to recover your operating system and programs installed at the factory.

## Recovering your information

To recover information you previously backed up, follow these steps:

1. If possible, back up all personal files.
2. Select **Start > All Programs > Accessories > System Tools > Backup**.  
The Backup or Restore Wizard opens.
3. Select **Restore files and settings >Next**.
4. Follow the on-screen instructions.

---

 **NOTE:** For additional information on initiating a recovery in Windows, perform a search for this topic in Help and Support.

---

## Recovering the operating system and programs

 **CAUTION:** The recovery process reformats and completely erases the hard drive. All files you have created and any software installed on the computer are permanently removed. The recovery process reinstalls the original operating system, software, and drivers. Software, drivers, and updates not installed by HP must be manually reinstalled.

---

To recover your operating system and programs, follow these steps:

1. If possible, back up all personal files.
2. Insert the *Operating System* disc into the optical drive.
3. Shut down the computer.
4. Turn on the computer.
5. Follow the on-screen instructions to install the operating system.

6. After the operating system is installed, remove the *Operating System* disc and insert the *Driver Recovery* disc.
7. Follow the on-screen instructions to install the drivers and programs.

## 8 Connector pin assignments

### Audio-out (headphone)/Audio-in (microphone) jack

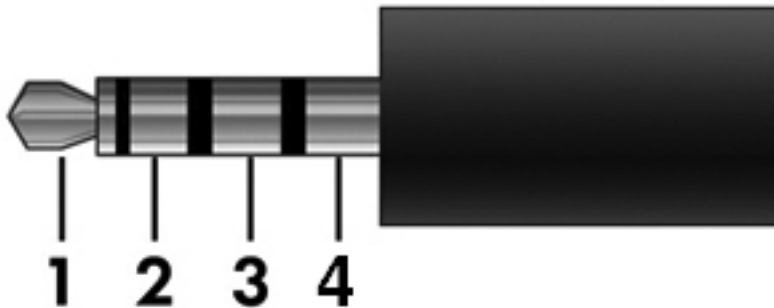

Pin	Signal
1	Left audio signal in
2	Right audio signal in
3	Ground
4	Microphone



## External monitor

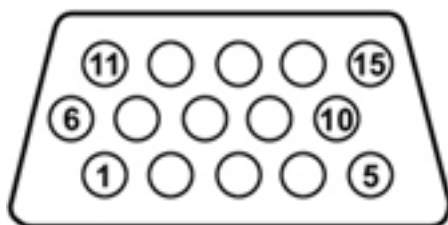

Pin	Signal
1	Red analog
2	Green analog
3	Blue analog
4	Not connected
5	Ground
6	Ground analog
7	Ground analog
8	Ground analog
9	+5 VDC
10	Ground
11	Monitor detect
12	DDC 2B data
13	Horizontal sync
14	Vertical sync
15	DDC 2B clock

## RJ-45 (network)

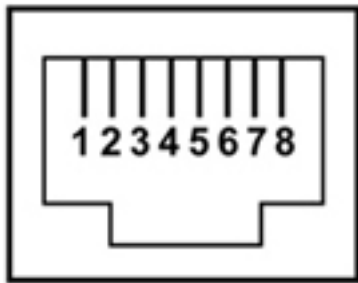

Pin	Signal
1	Transmit +
2	Transmit -
3	Receive +
4	Unused
5	Unused
6	Receive -
7	Unused
8	Unused

# Universal Serial Bus

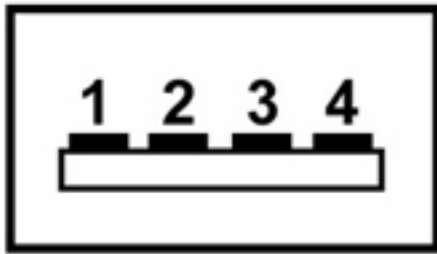

Pin	Signal
1	+5 VDC
2	Data -
3	Data +
4	Ground

---

## 9 Power cord set requirements

The wide range input feature of the computer permits it to operate from any line voltage from 100 to 120 volts AC or from 220 to 240 volts AC.

The 3-conductor power cord set included with the computer meets the requirements for use in the country or region where the equipment is purchased.

Power cord sets for use in other countries and regions must meet the requirements of the country or region where the computer is used.

### Requirements for all countries and regions

The requirements listed below are applicable to all countries and regions:

- The length of the power cord set must be at least **1.5 m** (5.0 ft) and no more than **2.0 m** (6.5 ft).
- All power cord sets must be approved by an acceptable accredited agency responsible for evaluation in the country or region where the power cord set will be used.
- The power cord sets must have a minimum current capacity of 10 amps and a nominal voltage rating of 125 or 250 V AC, as required by the power system of each country or region.
- The appliance coupler must meet the mechanical configuration of an EN 60 320/IEC 320 Standard Sheet C13 connector for mating with the appliance inlet on the back of the computer.

# Requirements for specific countries and regions

Country/region	Accredited agency	Applicable note number
Australia	EANSW	1
Austria	OVE	1
Belgium	CEBC	1
Canada	CSA	2
Denmark	DEMKO	1
Finland	FIMKO	1
France	UTE	1
Germany	VDE	1
Italy	IMQ	1
Japan	METI	3
The Netherlands	KEMA	1
Norway	NEMKO	1
The People's Republic of China	CCC	5
South Korea	EK	4
Sweden	SEMKO	1
Switzerland	SEV	1
Taiwan	BSMI	4
The United Kingdom	BSI	1
The United States	UL	2

1. The flexible cord must be Type HO5VV-F, 3-conductor, 1.0-mm<sup>2</sup> conductor size. Power cord set fittings (appliance coupler and wall plug) must bear the certification mark of the agency responsible for evaluation in the country or region where it will be used.
2. The flexible cord must be Type SPT-3 or equivalent, No. 18 AWG, 3-conductor. The wall plug must be a two-pole grounding type with a NEMA 5-15P (15 A, 125 V) or NEMA 6-15P (15 A, 250 V) configuration.
3. The appliance coupler, flexible cord, and wall plug must bear a "T" mark and registration number in accordance with the Japanese Dentori Law. The flexible cord must be Type VCT or VCTF, 3-conductor, 1.00-mm<sup>2</sup> conductor size. The wall plug must be a two-pole grounding type with a Japanese Industrial Standard C8303 (7 A, 125 V) configuration.
4. The flexible cord must be Type RVV, 3-conductor, 0.75-mm<sup>2</sup> conductor size. Power cord set fittings (appliance coupler and wall plug) must bear the certification mark of the agency responsible for evaluation in the country or region where it will be used.
5. The flexible cord must be Type VCTF, 3-conductor, 0.75-mm<sup>2</sup> conductor size. Power cord set fittings (appliance coupler and wall plug) must bear the certification mark of the agency responsible for evaluation in the country or region where it will be used.

---

# 10 Recycling

## Battery

When a battery has reached the end of its useful life, do not dispose of the battery in general household waste. Follow the local laws and regulations in your area for computer battery disposal.

## Display

- 
- ⚠ **WARNING!** The backlight contains mercury. Exercise caution when removing and handling the backlight to avoid damaging this component and causing exposure to the mercury.
  - ⚠ **CAUTION:** The procedures in this chapter can result in damage to display components. The only components intended for recycling purposes are the liquid crystal display (LCD) panel and the backlight. When you remove these components, handle them carefully.
  - 📄 **NOTE: Materials Disposal.** This HP product contains mercury in the backlight in the display assembly that might require special handling at end-of-life. Disposal of mercury may be regulated because of environmental considerations. For disposal or recycling information, contact your local authorities, or see the Electronic Industries Alliance (EIA) Web site at <http://www.eiae.org>.
- 

This section provides disassembly instructions for the display assembly. The display assembly must be disassembled to gain access to the backlight **(1)** and the liquid crystal display (LCD) panel **(2)**.

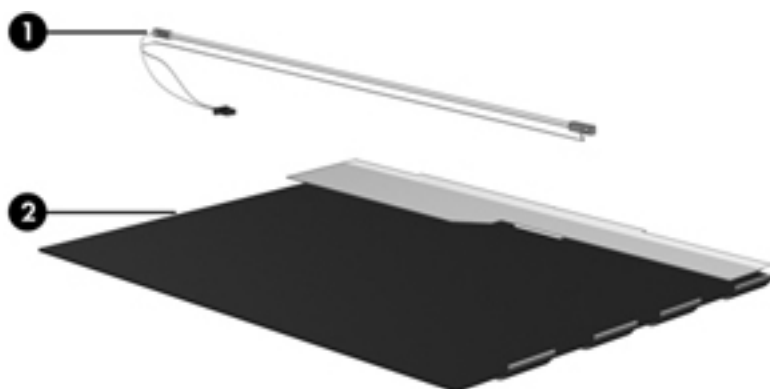

- 
- 📄 **NOTE:** The procedures provided in this chapter are general disassembly instructions. Specific details, such as screw sizes, quantities, and locations, and component shapes and sizes, can vary from one computer model to another.
-

Perform the following steps to disassemble the display assembly:

1. Remove all screw covers **(1)** and screws **(2)** that secure the display bezel to the display assembly.

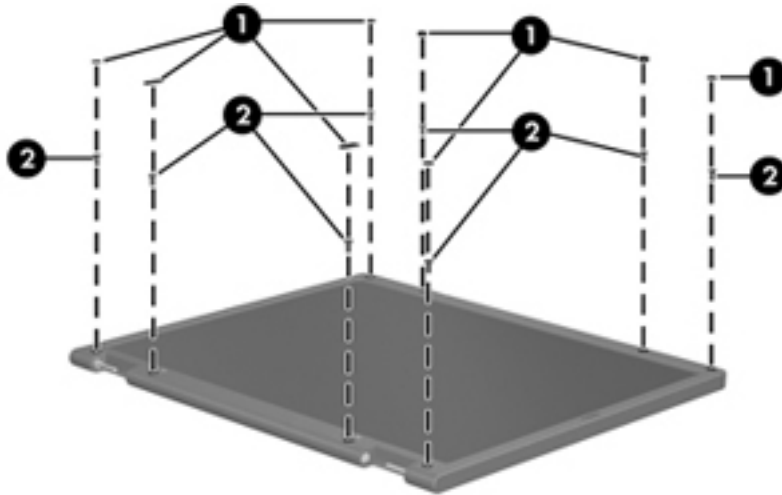

2. Lift up and out on the left and right inside edges **(1)** and the top and bottom inside edges **(2)** of the display bezel until the bezel disengages from the display assembly.
3. Remove the display bezel **(3)**.

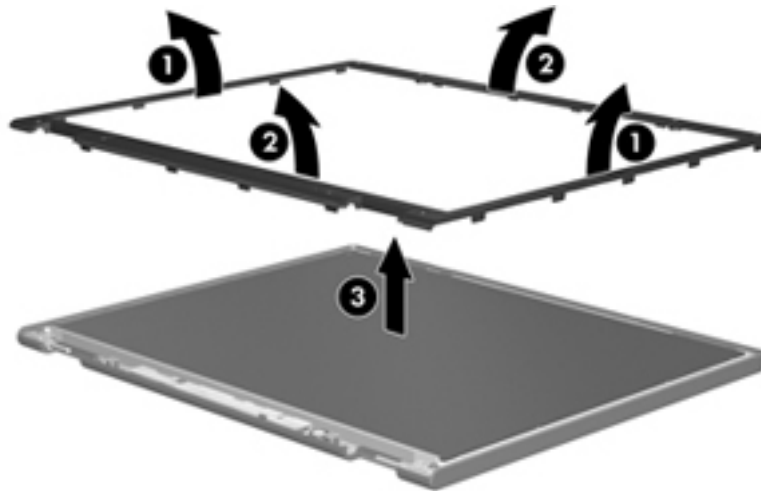

4. Disconnect all display panel cables **(1)** from the display inverter and remove the inverter **(2)**.

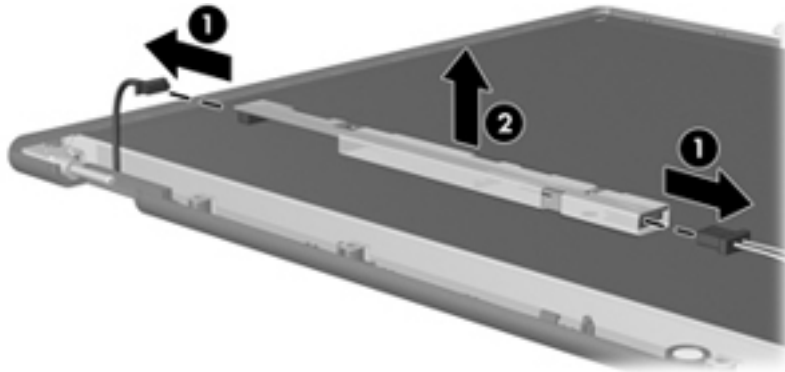

5. Remove all screws **(1)** that secure the display panel assembly to the display enclosure.
6. Remove the display panel assembly **(2)** from the display enclosure.

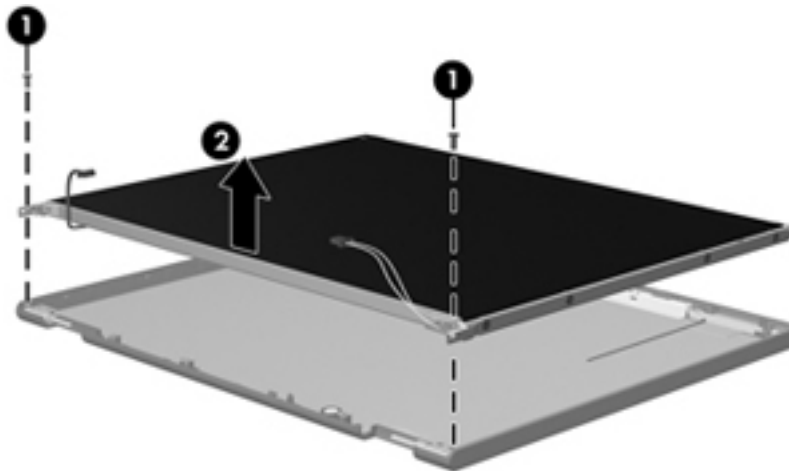

7. Turn the display panel assembly upside down.
8. Remove all screws that secure the display panel frame to the display panel.

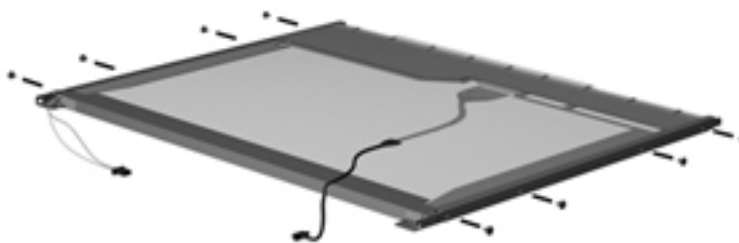

9. Use a sharp-edged tool to cut the tape **(1)** that secures the sides of the display panel to the display panel frame.



**10.** Remove the display panel frame **(2)** from the display panel.

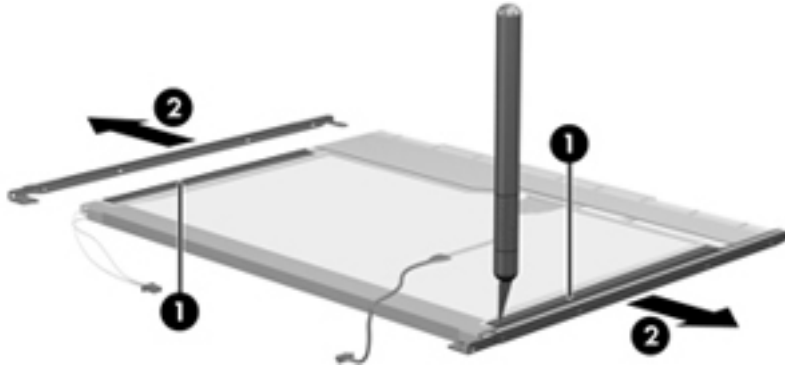

**11.** Remove the screws **(1)** that secure the backlight cover to the display panel.

**12.** Lift the top edge of the backlight cover **(2)** and swing it outward.

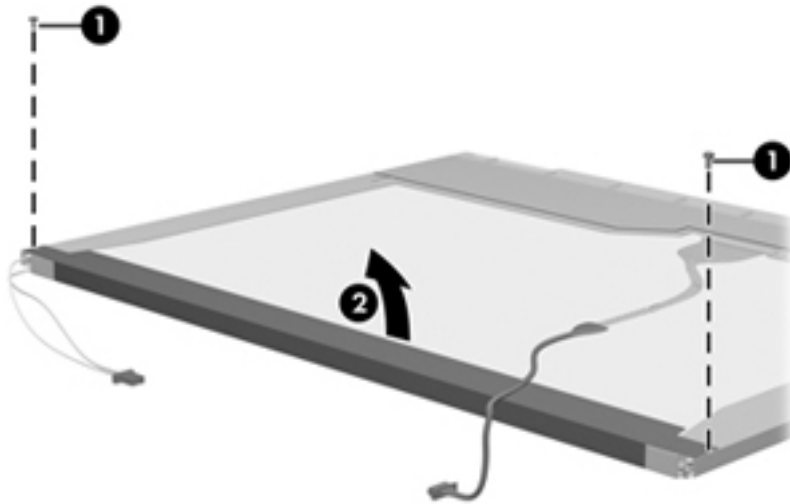

**13.** Remove the backlight cover.

**14.** Turn the display panel right-side up.

15. Remove the backlight cables (1) from the clip (2) in the display panel.

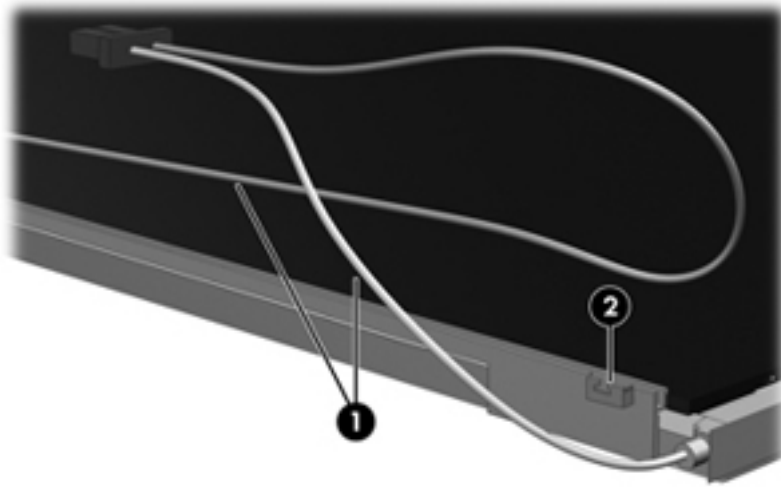

16. Turn the display panel upside down.

⚠ **WARNING!** The backlight contains mercury. Exercise caution when removing and handling the backlight to avoid damaging this component and causing exposure to the mercury.

17. Remove the backlight frame from the display panel.

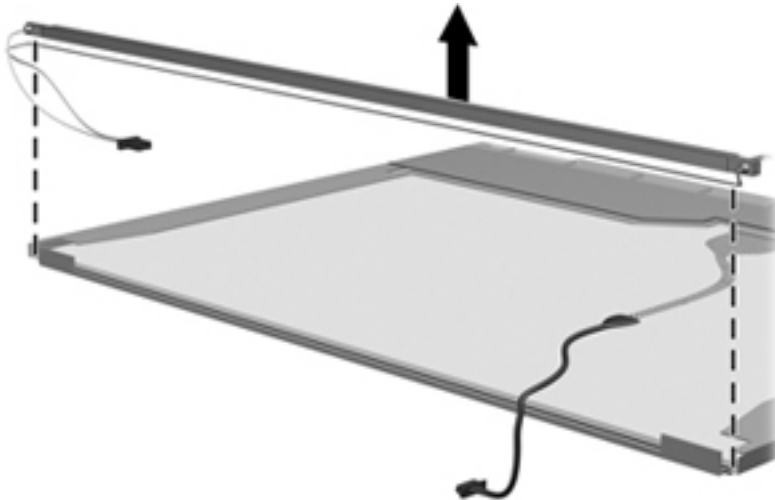

**18.** Remove the backlight from the backlight frame.

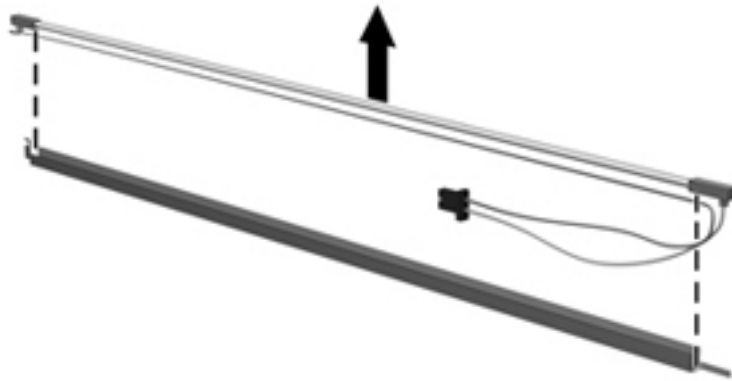

**19.** Disconnect the display panel cable **(1)** from the LCD panel.

**20.** Remove the screws **(2)** that secure the LCD panel to the display rear panel.

**21.** Release the LCD panel **(3)** from the display rear panel.

**22.** Release the tape **(4)** that secures the LCD panel to the display rear panel.

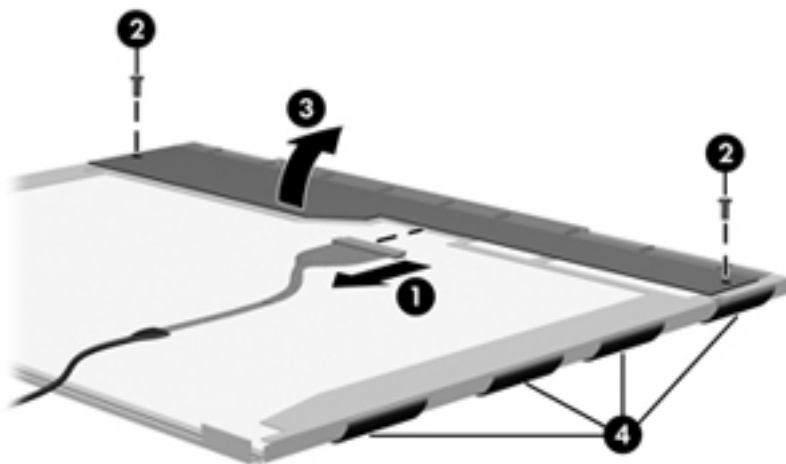

**23.** Remove the LCD panel.

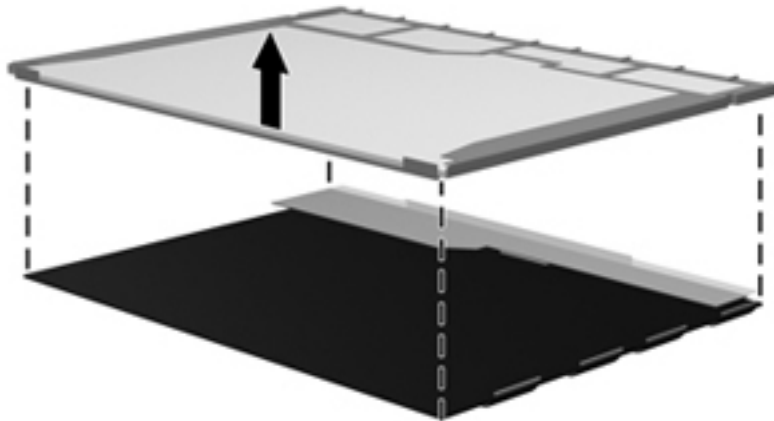

**24.** Recycle the LCD panel and backlight.

# Index

- A**
  - AC adapter, spare part number 24
  - administrator password 72, 76
  - antenna
    - removal 69
    - spare part number 21, 63
  - antennas 14
  - applications key, Windows 7
  - audio, product description 2
  - audio-in (microphone) jack 11
  - audio-out (headphone) jack 11
  - audio-in jack
    - pin assignments 96
  - audio-out jack
    - pin assignments 96
- B**
  - base enclosure, spare part number 19
  - battery
    - removal 36
    - spare part number 20, 36
  - battery bay, identifying 13
  - battery light 8
  - battery release latches 13
  - bay, battery 13
  - boot options 73, 76
  - boot order 73, 76
  - buttons
    - left TouchPad 5
    - right TouchPad 5
- C**
  - cables, service considerations 29
  - caps lock light, identifying 6
  - changing Setup Utility language 74
  - changing the Setup Utility language 70
  - chipset, product description 1
  - compartment, memory module 13
  - components
    - bottom 13
    - display 12
    - front 8
    - left-side 11
    - right-side 10
    - TouchPad 5
  - computer feet
    - locations 35
    - spare part number 35
  - computer specifications 78
  - connectors
    - service considerations 29
- D**
  - Diagnostics menu 73, 77
  - Digital Media Slot, identifying 10
  - discs
    - Driver Recovery 94
    - Operating System 94
  - diskette drive
    - precautions 30
    - product description 2
  - display assembly
    - removal 63
    - spare part number 16, 63
  - display bezel
    - illustrated 21, 63
    - removal 65
    - spare part number 21, 63
  - display cable kit, spare part number 21, 63
  - display component recycling 102
  - display enclosure
    - illustrated 22, 63
    - spare part number 22, 63
  - display hinge kit, spare part number 21, 63
  - display hinge, removal 67
  - display panel
    - illustrated 21
    - removal 66
    - spare part number 21
  - display panel screws 22
  - display screw kit, spare part number 22, 63
  - display specifications 80
  - display switch, identifying 12
  - displaying system information 71, 75
  - drive light, identifying 8
  - Driver Recovery disc 94
  - drives
    - preventing damage 30
  - drives, boot order 73, 76
- E**
  - earbuds 11
  - electrostatic discharge 31
  - Ethernet, product description 2
  - exiting the Setup Utility 72, 75
  - external media cards, product description 3
  - external monitor port
    - pin assignments 97
  - external monitor port, identifying 10
- F**
  - fan
    - removal 56
    - spare part number 17, 56
  - feet
    - locations 35
    - spare part number 35
  - fn key 7

function keys 7

## G

graphics, product description 1  
grounding equipment and methods 33

## H

hard drive  
precautions 30  
product description 2  
spare part number 17  
specifications 81  
hard drive self test 73, 77  
headphone (audio-out) jack 11  
headphone jack  
pin assignments 96  
headphones 11  
heat sink assembly  
removal 58  
spare part number 58  
hinge covers  
illustrated 21, 63  
spare part number 21, 63

## I

internal display switch,  
identifying 12  
internal media cards, product  
description 3  
internal microphone,  
identifying 12

## J

jacks  
audio-in (microphone) 11  
audio-out (headphone) 11  
RJ-45 (network) 10

## K

keyboard  
product description 3  
removal 40  
spare part number 17, 40  
keys  
fn 7  
function 7  
Windows applications 7  
Windows logo 7

## L

language support 72, 76  
latches, battery release 13  
left TouchPad button, identifying 5  
lights  
battery 8  
caps lock 6  
drive 8  
power 8  
webcam 12  
wireless 9

## M

Main menu 72, 76  
mass storage device  
product description 2  
spare part number 17  
mass storage devices  
illustrated 44  
spare part numbers 44  
memory module  
product description 1  
removal 38  
spare part number 19, 38  
memory module compartment cover  
removal 38  
memory module compartment,  
identifying 13  
memory test 73, 77  
microphone (audio-in) jack 11  
microphone assembly, spare part  
number 21, 63  
microphone jack  
pin assignments 96  
model name 1  
modem, product description 2  
monitor port  
pin assignments 97

## N

navigating in the Setup  
Utility 71, 74  
network jack  
pin assignments 98  
network jack, identifying 10

## O

Operating System disc 94  
operating system, product  
description 3

optical drive, product  
description 2

## P

packing guidelines 32  
panels, product description 1  
passwords 72, 76  
pin assignments  
audio-in jack 96  
audio-out jack 96  
external monitor port 97  
headphone jack 96  
microphone jack 96  
monitor port 97  
network jack 98  
RJ-45 jack 98  
Universal Serial Bus (USB)  
port 99  
plastic parts 29  
pointing device  
product description 3  
ports  
product description 3  
USB 10, 11  
power connector, identifying 11  
power cord  
set requirements 100  
spare part number 24  
power light, identifying 8  
power requirements, product  
description 3  
power switch, identifying 8  
power-on password 72, 76  
Processor C4 State 73, 76  
processor, product description 1  
product description  
audio 2  
chipset 1  
diskette drive 2  
Ethernet 2  
external media cards 3  
graphics 1  
internal media cards 3  
keyboard 3  
mass storage device 2  
memory module 1  
modem 2  
operating system 3  
optical drive 2  
panels 1

- pointing device 3
- ports 3
- power requirements 3
- processors 1
- product name 1
- security 3
- serviceability 4
- wireless 2
- product name 1
- R**
- release latches, battery 13
- removal/replacement
  - preliminaries 29
  - procedures 34
- restoring default settings 71, 75
- right TouchPad button,
  - identifying 5
- RJ-45 (network) jack,
  - identifying 10
- RJ-45 jack
  - pin assignments 98
- RTC battery
  - removal 43
  - spare part number 19, 43
- rubber kit, spare part number 24
- S**
- screw count 34
- screw kit
  - spare part number 24
- screws
  - PM1.6x2.0 61
  - PM1.6x2.5 58
  - PM2.0x3.0 41, 44, 51, 52, 66, 67
  - PM2.0x3.0 captive 38
  - PM2.0x3.0x4.0x0.4T 22
  - PM2.0x4.0 46
  - PM2.5x10.0 captive 44
  - PM2.5x4.0 55, 56, 62, 64
  - PM2.5x6.0 46, 47
  - PM3.0x3.0 27, 45
- security cable slot, identifying 11
- Security menu 72, 76
- security, product description 3
- selecting in the Setup
  - Utility 71, 74
- serial number 15, 34
- service considerations 29

- service tag 15, 34
- serviceability, product
  - description 4
- SIM
  - removal 37
- solid state drive
  - product description 2
- solid-state drive 82
- speaker assembly
  - illustrated 21, 63
  - removal 66
  - spare part number 21, 63
- speakers, identifying 12
- specifications
  - computer 78
  - display 80
  - hard drive 81
  - solid-state drive 82
  - system resources 83
- static-shielding materials 33
- switches
  - power 8
  - wireless 9
- system board
  - removal 60
  - spare part number 19, 60
- System Configuration
  - menu 72, 76
- system information 72, 76
- system resources 83
- T**
- tools required 29
- top cover
  - removal 46
  - spare part number 17, 46
- TouchPad
  - buttons 5
  - identifying 5
- TouchPad scroll zone,
  - identifying 5
- transporting guidelines 32
- U**
- USB board
  - removal 54
  - spare part number 54
- USB board, spare part
  - number 18, 54

- USB port
  - pin assignments 99
- USB ports, identifying 10, 11

- V**
- ventilation clearance 56
- vents, identifying 11, 13

- W**
- webcam light, identifying 12
- webcam module
  - illustrated 21, 63
  - removal 68
  - spare part number 21, 63
- webcam, identifying 12
- Windows applications key,
  - identifying 7
- Windows Backup utility 93, 94
- Windows logo key, identifying 7
- Windows recovery 94
- wireless antenna
  - removal 69
  - spare part number 21, 63
- wireless antennas 14
- wireless light, identifying 9
- wireless module, product
  - description 2
- wireless switch, identifying 9
- WLAN antennas, identifying 14
- WLAN module
  - removal 49
  - spare part number 18, 49
- workstation guidelines 32
- WWAN antennas, identifying 14
- WWAN module
  - removal 52
  - spare part number 19, 52



## Free Manuals Download Website

<http://myh66.com>

<http://usermanuals.us>

<http://www.somanuals.com>

<http://www.4manuals.cc>

<http://www.manual-lib.com>

<http://www.404manual.com>

<http://www.luxmanual.com>

<http://aubethermostatmanual.com>

Golf course search by state

<http://golfingnear.com>

Email search by domain

<http://emailbydomain.com>

Auto manuals search

<http://auto.somanuals.com>

TV manuals search

<http://tv.somanuals.com>