

Thank you for purchasing this Factory Service Manual CD/DVD from servicemanuals4u.com.

Please check out our eBay auctions for more great deals on Factory Service Manuals:

[servicemanuals4u](http://servicemanuals4u.com)

Download from www.somanuals.com All Manuals Search And Download.

COMPAQ

[STORE](#) | [PRODUCTS](#) | [SERVICES](#) | [SUPPORT](#) | [CONTACT US](#) | [SEARCH](#)

Maintenance & Service Guide

Presario 1200 Series

Models: 1255, 1257, 1260, 1262, 1266, and 1267

[Home Page](#) | [Notice](#) | [Preface](#) | [Product Description](#) | [Troubleshooting](#)
[Illustrated Parts Catalog](#) | [Removal & Replacement Procedures](#) | [Specifications](#)
[Pin Assignments](#) | [Battery Pack Operations](#)

Welcome to the Maintenance & Service Guide for the Presario 1255 through 1267 series...

[Notice](#)
[Preface](#)
[Product Description](#)
[Troubleshooting](#)
[Illustrated Parts Catalog](#)
[Removal & Replacement Procedures](#)
[Specifications](#)
[Connector Pin Assignments](#)
[Battery Pack Operations](#)



This online guide is designed to serve the needs of those whose job it is to repair Compaq products.

Click to download a ZIP file containing the complete **Maintenance & Service Guide** for this product.

This Guide will be periodically maintained and updated online as needed.

For content comments or questions, contact the [Editor](#).

To report a technical problem, contact your **Regional Support Center** or **IM Help Center**.

1.800.AT.COMPAQ

[privacy and legal statement](#)

COMPAQ

[STORE](#) | [PRODUCTS](#) | [SERVICES](#) | [SUPPORT](#) | [CONTACT US](#) | [SEARCH](#)

Maintenance & Service Guide

Presario 1200 Series

Models: 1255, 1257, 1260, 1262, 1266, and 1267

[Home Page](#) | [Notice](#) | [Preface](#) | [Product Description](#) | [Troubleshooting](#)
[Illustrated Parts Catalog](#) | [Removal & Replacement Procedures](#) | [Specifications](#)
[Pin Assignments](#) | [Battery Pack Operations](#)

Notice

The information in this guide is subject to change without notice.

COMPAQ COMPUTER CORPORATION SHALL NOT BE LIABLE FOR TECHNICAL OR EDITORIAL ERRORS OR OMISSIONS CONTAINED HEREIN, NOR FOR INCIDENTAL OR CONSEQUENTIAL DAMAGES RESULTING FROM THE FURNISHING, PERFORMANCE, OR USE OF THIS MATERIAL.

This guide contains information protected by copyright. No part of this guide may be photocopied or reproduced in any form without prior written consent from Compaq Computer Corporation.

© 1999 Compaq Computer Corporation.
All rights reserved. Printed in the U.S.A.

Compaq, Presario Registered U. S. Patent and Trademark Office.

*Microsoft, MS-DOS, and Windows are registered trademarks of Microsoft Corporation.
Windows 98 is a trademark of Microsoft Corporation.*

The software described in this guide is furnished under a license agreement or nondisclosure agreement. The software may be used or copied only in accordance with the terms of the agreement.

Product names mentioned herein may be trademarks and/or registered trademarks of their respective companies.

Maintenance and Service Guide

Compaq Presario 1200 Series Portable Computers

First Edition (February 1999)
Compaq Computer Corporation

1.800.AT.COMPAQ

[privacy and legal statement](#)

Maintenance & Service Guide

Presario 1200 Series

Models: 1255, 1257, 1260, 1262, 1266, and 1267

[Home Page](#) | [Notice](#) | [Preface](#) | [Product Description](#) | [Troubleshooting](#)
[Illustrated Parts Catalog](#) | [Removal & Replacement Procedures](#) | [Specifications](#)
[Pin Assignments](#) | [Battery Pack Operations](#)

Preface

This *Maintenance and Service Guide* is a troubleshooting guide that can be used for reference when servicing the Compaq Presario 1200 Series Portable Computers.

Compaq Computer Corporation reserves the right to make changes to the Compaq Presario 1200 Series Portable Computers without notice.

Symbols

The following words and symbols mark special messages throughout this guide.

 **WARNING:** Text set off in this manner indicates that failure to follow directions in the warning could result in bodily harm or loss of life.

 **CAUTION:** Text set off in this manner indicates that failure to follow directions could result in damage to equipment or loss of data.

IMPORTANT: Text set off in this manner presents clarifying information or specific instructions.

NOTE: Text set off in this manner presents commentary, sidelights, or interesting points of information.

Technician Notes



WARNING: Only authorized technicians trained by Compaq should repair this equipment. All troubleshooting and repair procedures are detailed to allow only subassembly/module level repair. Because of the complexity of the individual boards and subassemblies, the user should not attempt to make repairs at the component level or to make modifications to any printed circuit board. Improper repairs can create a safety hazard. Any indications of component replacement or printed circuit board modifications may void any warranty.

Serial Number

When requesting information or ordering spare parts, the computer serial number should be provided to Compaq. The serial number is located on the bottom of the computer.

Locating Additional Information

The following documentation is available to support this product:

- Compaq Presario 1200 Series Portable Computer documentation set
- *Introducing Windows 95 Guide*
- Service Training Guides
- Compaq Service Advisories and Bulletins
- *Compaq QuickFind*
- *Compaq Service Quick Reference Guide*

1.800.AT.COMPAQ

[privacy and legal statement](#)

COMPAQ

[STORE](#) | [PRODUCTS](#) | [SERVICES](#) | [SUPPORT](#) | [CONTACT US](#) | [SEARCH](#)

Maintenance & Service Guide

Presario 1200 Series

Models: 1255, 1257, 1260, 1262, 1266, and 1267

[Home Page](#) | [Notice](#) | [Preface](#) | [Product Description](#) | [Troubleshooting](#)
[Illustrated Parts Catalog](#) | [Removal & Replacement Procedures](#) | [Specifications](#)
[Pin Assignments](#) | [Battery Pack Operations](#)

Product Description

[Models and Features](#)

[Controls and Lights](#)

[Left Side Components](#)

[Right Side Components](#)

[Bottom of Unit](#)

[Rear Connectors](#)

[Power Management for Windows 98](#)



Compaq Presario Portable Computers...

are a continuation of new generation multimedia portable computers with innovative integrated designs, outstanding audio and video, advanced core features, and attractive styling.

This full-function, AMD-K6 or

***Pentium-
based
portable
computer
allows full
desktop
functionality.***

1.800.AT.COMPAQ

[privacy and legal statement](#)

Maintenance & Service Guide

Presario 1200 Series

Models: 1255, 1257, 1260, 1262, 1266, and 1267

| [Home Page](#) | [Notice](#) | [Preface](#) | [Product Description](#) | [Troubleshooting](#)
[Illustrated Parts Catalog](#) | [Removal & Replacement Procedures](#) | [Specifications](#)
[Pin Assignments](#) | [Battery Pack Operations](#)

Troubleshooting

[Preliminary Steps](#)

[Clearing the Power-On Password](#)

[Power-On Self Test \(POST\)](#)

[Compaq Diagnostics](#)

[Diagnostic Error Codes](#)

[Troubleshooting Without Diagnostics](#)

[Solving Minor Problems](#)

[Contacting Compaq Support](#)

This section covers troubleshooting information for the Compaq Presario 1200 Series Portable Computers. The basic steps in troubleshooting include:

1. Follow the [Preliminary Steps](#).
2. Run the [Power-On Self-Test \(POST\)](#).
3. Follow the recommended actions described in the diagnostic tables, if you are unable to run POST or if POST displays an error message.

*When following the recommended actions in the Sections on **POST** and [Diagnostic Error Codes](#), perform them in the order listed. Rerun **POST** after each recommended action until the problem is solved and no error message occurs. Once the problem is solved, do not complete the remaining recommended actions.*

NOTE:

If the problem is intermittent, check the computer several times to verify that the problem is solved.

1.800.AT.COMPAQ

[privacy and legal statement](#)

COMPAQ

[STORE](#) | [PRODUCTS](#) | [SERVICES](#) | [SUPPORT](#) | [CONTACT US](#) | [SEARCH](#)

Maintenance & Service Guide

Presario 1200 Series

Models: 1255, 1257, 1260, 1262, 1266, and 1267

| [Home Page](#) | [Notice](#) | [Preface](#) | [Product Description](#) | [Troubleshooting](#)
[Illustrated Parts Catalog](#) | [Removal & Replacement Procedures](#) | [Specifications](#)
[Pin Assignments](#) | [Battery Pack Operations](#)

Illustrated Parts Catalog

This section provides a breakdown and identifies the spare parts ordering number associated with each item for the Compaq Presario 1200 Series Portable Computers.

[System Unit](#)

[Cables](#)

[Boards](#)

[Miscellaneous Hardware &
Plastics Kit](#)

[Display Assembly](#)

[Miscellaneous Parts](#)

[Mass Storage Devices](#)

[Documentation & Software](#)

[Miscellaneous Cable Kit](#)

[Compaq Home](#)

[Search](#)

[Products](#)

[Service](#)

[Worldwide](#)

[Compaq.com](#)

[Comments?](#)

[Legal Notices and Privacy Statement](#)

Revised: 25 February 1999

COMPAQ

[STORE](#) | [PRODUCTS](#) | [SERVICES](#) | [SUPPORT](#) | [CONTACT US](#) | [SEARCH](#)

Maintenance & Service Guide

Presario 1200 Series

Models: 1255, 1257, 1260, 1262, 1266, and 1267

| [Home Page](#) | [Notice](#) | [Preface](#) | [Product Description](#) | [Troubleshooting](#)
[Illustrated Parts Catalog](#) | [Removal & Replacement Procedures](#) | [Specifications](#)
[Pin Assignments](#) | [Battery Pack Operations](#)

Removal and Replacement Procedures

This section explains the removal and replacement procedures for the computer.

Serial Number Location

Disassembly Sequence

[Electrostatic Discharge](#)

[Service Considerations](#)

[Cables and Connectors](#)

[Preparing the Computer for Disassembly](#)

[Battery Pack](#)

[Palmrest Cover with Touch Pad](#)

[Heatspreader](#)

[Keyboard](#)

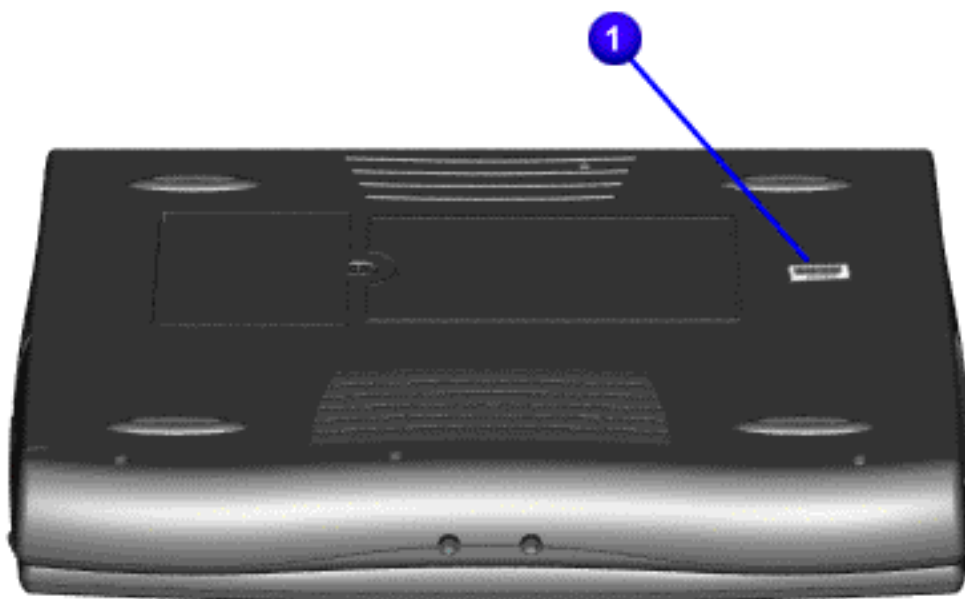

[Processor](#)

[Hard Drives](#)

[CD Drive](#)

[Battery](#)

[Charger Board](#)

[Modem](#)

[Display Panel](#)

[Assembly](#)

[Upper CPU](#)

[Cover](#)

[Speaker](#)

[Assembly](#)

[Diskette Drive](#)

[Fan Assembly](#)

[System Board](#)

[Dip Switch](#)

[Settings](#)

[Memory](#)

[Module](#)

Report the computer [1] serial number to Compaq when requesting information or ordering spare parts.

[1.800.AT.COMPAQ](tel:1800.AT.COMPAQ)

[privacy and legal statement](#)

Maintenance & Service Guide

Presario 1200 Series

Models: 1255, 1257, 1260, 1262, 1266, and 1267

[Home Page](#) | [Notice](#) | [Preface](#) | [Product Description](#) | [Troubleshooting](#)
[Illustrated Parts Catalog](#) | [Removal & Replacement Procedures](#) | [Specifications](#)
[Pin Assignments](#) | [Battery Pack Operations](#)

Specifications

This chapter covers the following specifications of Compaq Presario 1200 Series Portable Computers:

[System interrupts](#)

[Memory Expansion](#)

[System DMA](#)

[Battery Pack](#)

[System I/O Address](#)

[Diskette Drive](#)

[System memory Catalog](#)

[Hard Drive](#)

[Physical & environmental](#)

[CD Drive](#)

[Display](#)

Physical and Environmental

Computer Specifications

	U.S.	Metric
Dimensions		
Height	1.97 in	4.95 cm
Depth	12.20 in	31.00 cm
Width	10.08 in	25.40 cm

Weight Model 1234 Model 1235 Model 1236 Model 1237 Model 1238 Model 1240 Model 1242 Model 1250 Model 1252	7.326 LB 7.326 LB 7.326 LB 7.326 LB 7.326 LB 7.326 LB 7.326 LB 7.326 LB 7.326 LB 7.326 LB	3.33 kg 3.33 kg 3.33 kg 3.33 kg 3.33 kg 3.33 kg 3.33 kg 3.33 kg 3.33 kg 3.33 kg
Stand-Alone (Battery Pack) Power Requirements Nominal Operating Maximum Average Peak Operating	NiMH W @ 9.6 V W @ 9.6 V W @ 9.6 V	Li-ion W @ 14.4 V W @ 14.4 V W @ 14.4 V
AC Power Requirements Operating Voltage Operating Current Operating Frequency Maximum Transient	100-240 V 0.8/0.4 A RMS 47-63 Hz Meets IEC 801-4 and IEC801-5 1kV for 50 ns	
Temperature		
Operating	50° to 95 °F	10° to 35 °C
Non-operating	-4° to 140 °F	-20° to 60 °C
Relative Humidity (non-condensing)		
Operating	10 to 90%	35°C to 90%
Non-operating (tw = 38.7°C max)	5 to 95%	60°C to 95%
Altitude		
Operating	0 to 10,000 ft	0 to 3.15 km
Non-operating	0 to 30,000 ft	0 to 9.14 km
Shock		
Operating	10 G, 11 ms, half sine	
Non operating	240 G, 2 ms, half sine	
Vibration		
Operating	0.5 G	
Non-operating	1.5 G	
NOTE: Applicable product safety standards specify thermal limits for plastic surfaces. Compaq Presario 1200 Series Portable Computers operate well within this range of temperatures.		

Return to the [Top](#).

Compaq Home	Search	Products	Service	Worldwide	Compaq.com
-----------------------------	------------------------	--------------------------	-------------------------	---------------------------	----------------------------

[Comments?](#)

[Legal Notices and Privacy Statement](#)

Revised: 25 February 1999

Maintenance & Service Guide

Presario 1200 Series

Models: 1255, 1257, 1260, 1262, 1266, and 1267

| [Home Page](#) | [Notice](#) | [Preface](#) | [Product Description](#) | [Troubleshooting](#)
[Illustrated Parts Catalog](#) | [Removal & Replacement Procedures](#) | [Specifications](#)
[Pin Assignments](#) | [Battery Pack Operations](#)

Connector Pin Assignments

This appendix provides connector pin assignment tables for Compaq Presario 1200 Series Portable Computers. For more information on connectors, refer to the section on [Rear Connectors](#).

NOTE: The signals in all tables of this appendix are considered active high unless otherwise indicated by an asterisk (*).

Click on a link:

- [Parallel Connector](#)
- [Serial Connector](#)
- [Keyboard/Mouse](#)
- [External VGA Monitor](#)
- [Universal Serial Bus](#)
- [Modem](#)

Parallel Connector



Pin	Signal	Pin	Signal
1	Strobe*	10	Acknowledge*
2	Data Bit 0	11	Busy
3	Data Bit 1	12	Paper Out
4	Data Bit 2	13	Select
5	Data Bit 3	14	Auto Linefeed*
6	Data Bit 4	15	Error*
7	Data Bit 5	16	Initialize Printer*
8	Data Bit 6	17	Select In*
9	Data Bit 7	18-25	Signal Ground

* = Active low

[Return to the top.](#)

Serial Connector

Connector	Pin	Signal
	1	Carrier Detect
	2	Receive Data
	3	Transmit Data
	4	Data Terminal Ready
	5	Signal Ground
	6	Data Set Ready
	7	Ready to Send
	8	Clear to Send
	9	Ring Indicator

Return [to the top](#).

Keyboard/Mouse

Connector	Pin	Signal
	1	Data 1
	2	Data 2
	3	Ground
	4	+5 V
	5	Clock 1
	6	Clock 2

Return [to the top](#).

External VGA Monitor

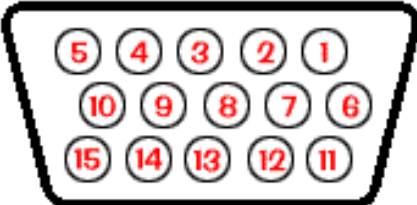
Connector	Pin	Signal
	1	Red Analog
	2	Green Analog
	3	Blue Analog
	4	Not connected
	5	Ground
	6	Ground Analog
	7	Ground Analog
	8	Ground Analog
	9	Not connected
	10	Ground

11	Monitor Detect
12	DDC2B Data
13	Horizontal Sync
14	Vertical Sync
15	DDC2B Clock

Return [to the top](#).

Universal Serial Bus

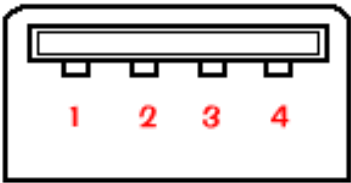
Connector	Pin	Signal
	1	+5V
	2	Data -
	3	Data +
	4	Ground

Return [to the top](#).

Modem

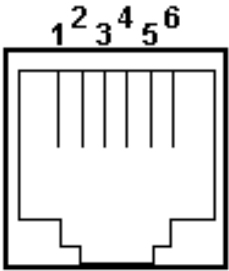
Connector	Pin	Signal
	1	Unused
	2	Unused
	3	Tip
	4	Ring
	5	Unused
	6	Unused

1.800.AT.COMPAQ

[privacy and legal statement](#)

Maintenance & Service Guide

Presario 1200 Series

Models: 1255, 1257, 1260, 1262, 1266, and 1267

[Home Page](#) | [Notice](#) | [Preface](#) | [Product Description](#) | [Troubleshooting](#)
[Illustrated Parts Catalog](#) | [Removal & Replacement Procedures](#) | [Specifications](#)
[Pin Assignments](#) | [Battery Pack Operations](#)

Battery Pack Operating Time

This appendix covers the following information concerning battery pack operating time:

- Increase battery pack operating time
- Conditioning a battery pack
- Disposal of a used battery pack

Increasing Battery Pack Operating Time

Battery pack operating time differs depending on several variables. To avoid unnecessary replacement, consider the following variables when determining how long a charged battery pack should last:

- Power management settings
- Hardware configuration
- Software applications
- Installed options
- Display brightness
- Hard drive usage
- Changes in operating temperature
- Type and number of installed PC Cards

NOTE: The power consumption requirements for PC Cards vary widely. Some cards drain the battery pack very rapidly.

Battery pack operating time can be increased by as much as 50 percent by controlling the energy required by the computer and the energy stored in the battery pack.

Minimizing the Energy Required

To minimize the energy required by the computer, follow these steps:

1. Set the power conservation levels in the Power Management utility to **Maximum**.
2. Customize the timeout value to work more efficiently with the applications. The amount of battery life depends on the values selected.

Maximizing the Energy Stored

To maximize the energy stored in the battery pack, follow these guidelines:

- Condition the battery pack at least every 30 days to improve overall battery performance.
- Keep a battery pack in the computer when using it with AC power to supply the battery pack with a constant trickle charge.
- Store the battery pack in a cool, dry place when not in use.

Return to the [top of this page](#).

Conditioning a Battery Pack

CAUTION: To avoid a loss of data, ensure that all data is saved before discharging a battery pack.



To condition a battery pack, complete the following steps:

1. Plug in the AC adapter and allow the battery to charge until the LED light on the display stops blinking. Your battery gauge may read 100 percent for a period of time before LED light on the display stops blinking. Do not unplug the AC adapter until the arrow disappears.
2. Unplug the AC adapter and allow the battery to drain until the computer reaches hibernation and turns itself off. **Do not plug in the AC adapter during this process or you will need to restart with Step No. 1.** You may use the computer while the battery is draining.
3. Your battery is re- conditioned.
4. Plug in the AC adapter and begin using the computer.

The table below shows the approximate battery pack charge times.

Approximate Battery Charge Time		
Computer	On Line	Off Line
NiMH Battery Pack	4.0 hours premature termination	2:00 hrs
Li ion Battery Pack	4.5 hours premature termination	2:50 hrs

Disposal of a Used Battery Pack

In the interest of safeguarding our environment, Compaq Computer Corporation recommends that nickel metal hydride (NiMH) and lithium ion (Li ion) battery packs be recycled. Battery packs should be handled in accordance with country, state, province, or local regulations.



CAUTION: Never attempt to open or service a battery pack. Opening a battery pack not only damages the pack and makes it unusable, but also expose potentially harmful battery components.

Return to the [top of this page](#).

1.800.AT.COMPAQ

[privacy and legal statement](#)

COMPAQ

[STORE](#) | [PRODUCTS](#) | [SERVICES](#) | [SUPPORT](#) | [CONTACT US](#) | [SEARCH](#)

Maintenance & Service Guide

Presario 1200 Series

Models: 1255, 1257, 1260, 1262, 1266, and 1267

[Home Page](#) | [Notice](#) | [Preface](#) | [Product Description](#) | [Troubleshooting](#)
[Illustrated Parts Catalog](#) | [Removal & Replacement Procedures](#) | [Specifications](#)
[Pin Assignments](#) | [Battery Pack Operations](#)

Models & Features

Models and Features

[Controls and Lights](#)

[Left Side Components](#)

[Right Side Components](#)

[Bottom of Unit](#)

[Rear Connectors](#)

[Power Management](#)

Compaq Presario 1200 Series Portable Computer Models

	Model 1255	Model 1257
Display	12. 1" HPA	12.1" HPA
Processor	AMD-K6 333-MHz MMX	AMD-K6 266-MHz MMX
Hard Drive	3.2-GB (or) 4.0-GB	3.2-GB
CD Drive	24× MAX	24× MAX
Modem	K-56.0 (or) M+ +56.0 Kbps Data/Fax with ITU V.90	M++56.0 Kbps Data/Fax with ITU V.90
Battery	ES NiMH (or) sLi ion	ES NiMH
	Model 1260	Model 1262
Display	12. 1" TFT	12. 1" TFT
Processor	AMD-K6 333-MHz MMX	AMD-K6 333-MHz MMX
Hard Drive	4.0-GB (or) 6.4-GB	4.0-GB
CD Drive	24× MAX	24× MAX
Modem	K-56.0 (or) M+ +56.0 Kbps Data/Fax with ITU V.90	K-56.0 Kbps Data/Fax with ITU V.90
Battery	sLi ion	ES NiMH
	Model 1266	Model 1267

Display	12. 1" TFT	12. 1" TFT
Processor	AMD-K6 333-MHz MMX	AMD-K6 333-MHz MMX
Hard Drive	6.4-GB	4.0-GB
CD Drive	24× MAX	24× MAX
Modem	K-56.0 Kbps Data/Fax with ITU V.90	K-56.0 Kbps Data/Fax with ITU V.90
Battery	sLi ion	ES NiMH

1.800.AT.COMPAQ

[privacy and legal statement](#)

COMPAQ

[STORE](#) | [PRODUCTS](#) | [SERVICES](#) | [SUPPORT](#) | [CONTACT US](#) | [SEARCH](#)

Maintenance & Service Guide

Presario 1200 Series

Models: 1255, 1257, 1260, 1262, 1266, and 1267

[Home Page](#) | [Notice](#) | [Preface](#) | [Product Description](#) | [Troubleshooting](#)
[Illustrated Parts Catalog](#) | [Removal & Replacement Procedures](#) | [Specifications](#)
[Pin Assignments](#) | [Battery Pack Operations](#)

Controls and Lights

[Models and Features](#)

Controls and Lights

[Left Side Components](#)

[Right Side Components](#)

[Bottom of Unit](#)

[Rear Connectors](#)

[Power Management for Windows 98](#)

Front Panel Components

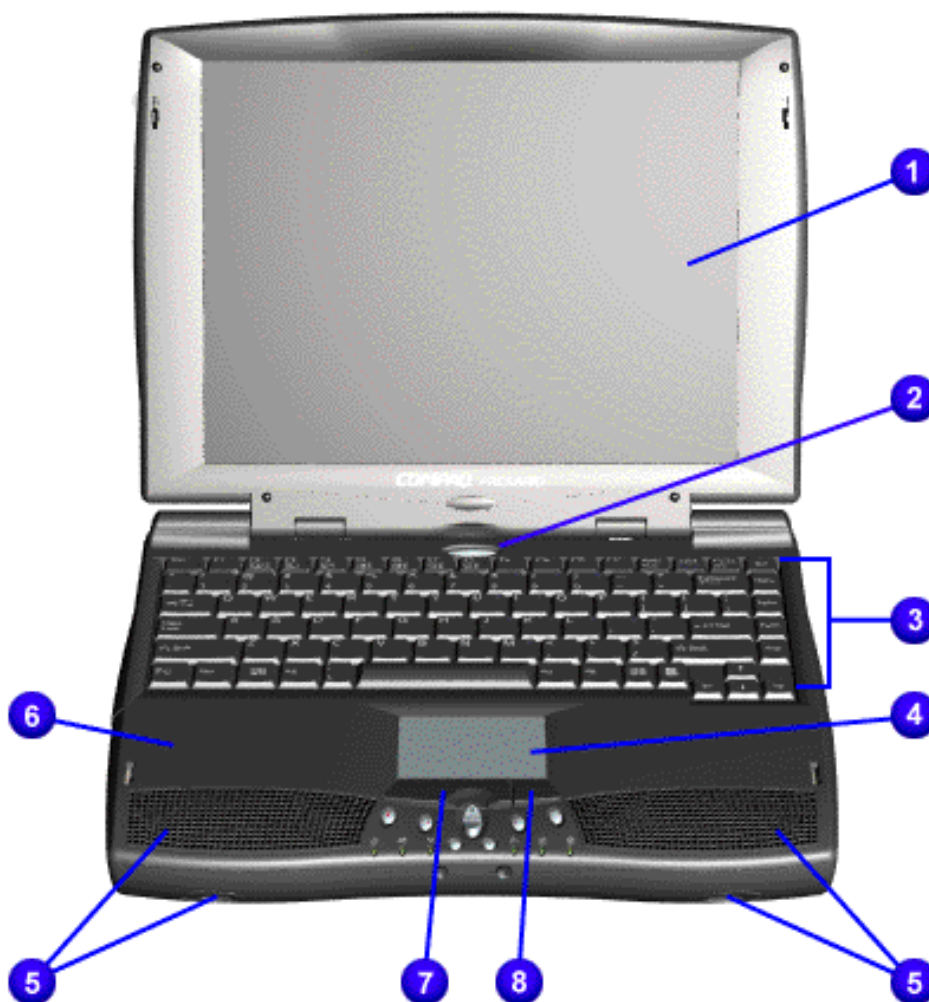

1. Display
2. Power Button
3. Keyboard
4. TouchPad
5. Speakers & Ports
6. Palmrest
7. (L) TouchPad Button
8. (R) TouchPad Button

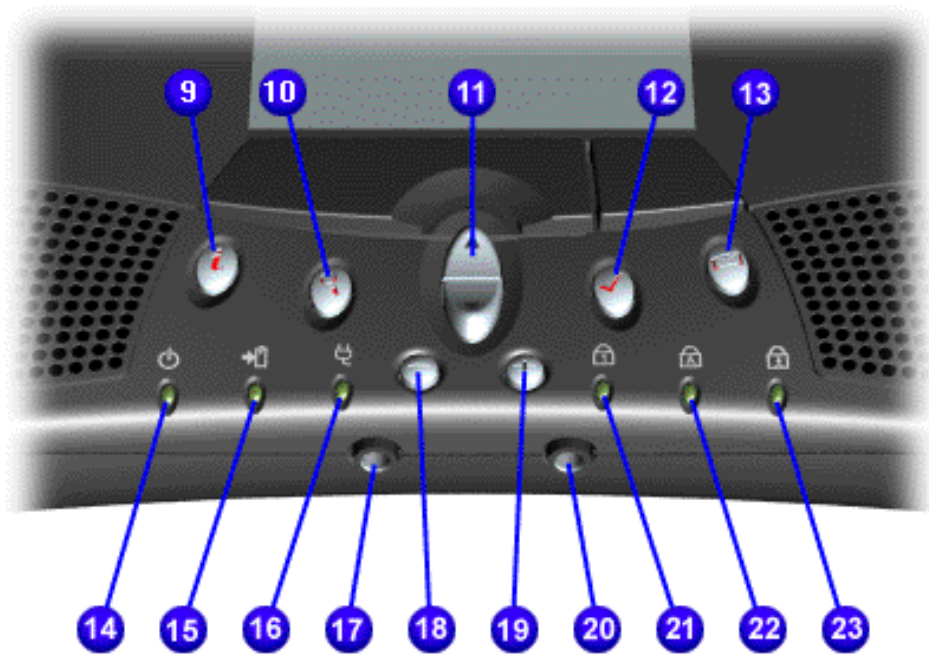

9. Instant Internet Access Button
10. Instant Search Button
11. Scroll up/down Button
12. Instant E-Commerce Button (or favorite website)
13. Instant E-mail
14. Power Light
15. Battery Charge Light
16. AC Adapter Light
17. Headphone Jack
18. Volume Down Button
19. Volume Up Button
20. Microphone Jack
21. Number Lock Light
22. Cap Lock Light
23. Scroll Lock Light

Compaq Home	Search	Products	Service	Worldwide	Compaq.com
-----------------------------	------------------------	--------------------------	-------------------------	---------------------------	----------------------------

[Comments?](#)

[Legal Notices and Privacy Statement](#)

Revised: 25 February 1999

COMPAQ

[STORE](#) | [PRODUCTS](#) | [SERVICES](#) | [SUPPORT](#) | [CONTACT US](#) | [SEARCH](#)

Maintenance & Service Guide

Presario 1200 Series

Models: 1255, 1257, 1260, 1262, 1266, and 1267

[Home Page](#) | [Notice](#) | [Preface](#) | [Product Description](#) | [Troubleshooting](#)
[Illustrated Parts Catalog](#) | [Removal & Replacement Procedures](#) | [Specifications](#)
[Pin Assignments](#) | [Battery Pack Operations](#)

Left Side Components

[Models and Features](#)

[Controls and Lights](#)

[Left Side Components](#)

[Right Side Components](#)

[Bottom of Unit](#)

[Rear Connectors](#)

[Power Management for Windows 98](#)

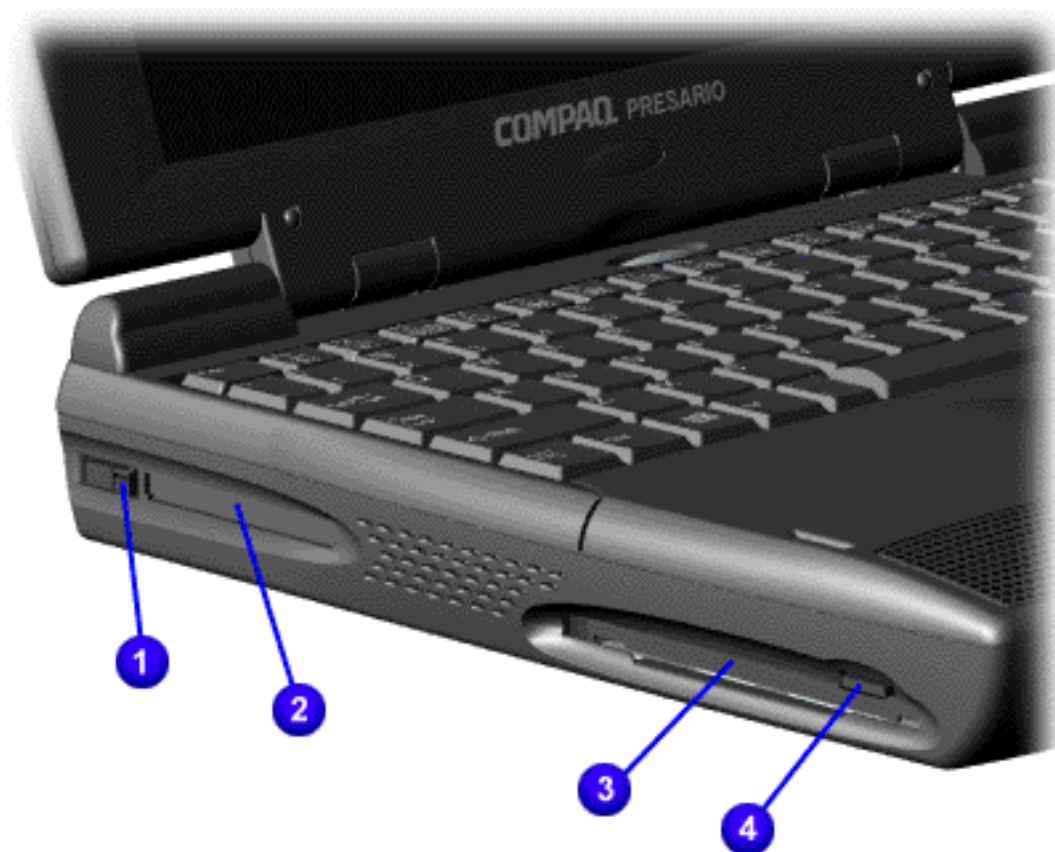

1. PC Card Eject Lever

2. PC Card Slot

3. Diskette Drive Slot

4. Diskette Eject Button

1.800.AT.COMPAQ

[privacy and legal statement](#)

COMPAQ

[STORE](#) | [PRODUCTS](#) | [SERVICES](#) | [SUPPORT](#) | [CONTACT US](#) | [SEARCH](#)

Maintenance & Service Guide

Presario 1200 Series

Models: 1255, 1257, 1260, 1262, 1266, and 1267

| [Home Page](#) | [Notice](#) | [Preface](#) | [Product Description](#) | [Troubleshooting](#)
[Illustrated Parts Catalog](#) | [Removal & Replacement Procedures](#) | [Specifications](#)
[Pin Assignments](#) | [Battery Pack Operations](#)

Right Side Components

[Models and Features](#)

[Controls and Lights](#)

[Left Side Components](#)

[Right Side Components](#)

[Bottom of Unit](#)

[Rear Connectors](#)

[Power Management for Windows 98](#)



1. **Battery Compartment.**

2. **CD Drive.**

3. **CD Drive Eject Button.**

1.800.AT.COMPAQ

[privacy and legal statement](#)

COMPAQ

[STORE](#) | [PRODUCTS](#) | [SERVICES](#) | [SUPPORT](#) | [CONTACT US](#) | [SEARCH](#)

Maintenance & Service Guide

Presario 1200 Series

Models: 1255, 1257, 1260, 1262, 1266, and 1267

[Home Page](#) | [Notice](#) | [Preface](#) | [Product Description](#) | [Troubleshooting](#)
[Illustrated Parts Catalog](#) | [Removal & Replacement Procedures](#) | [Specifications](#)
[Pin Assignments](#) | [Battery Pack Operations](#)

Bottom of Unit

[Models and Features](#)

[Controls and Lights](#)

[Left Side Components](#)

[Right Side Components](#)

[Bottom of Unit](#)

[Rear Connectors](#)

[Power Management for Windows 98](#)

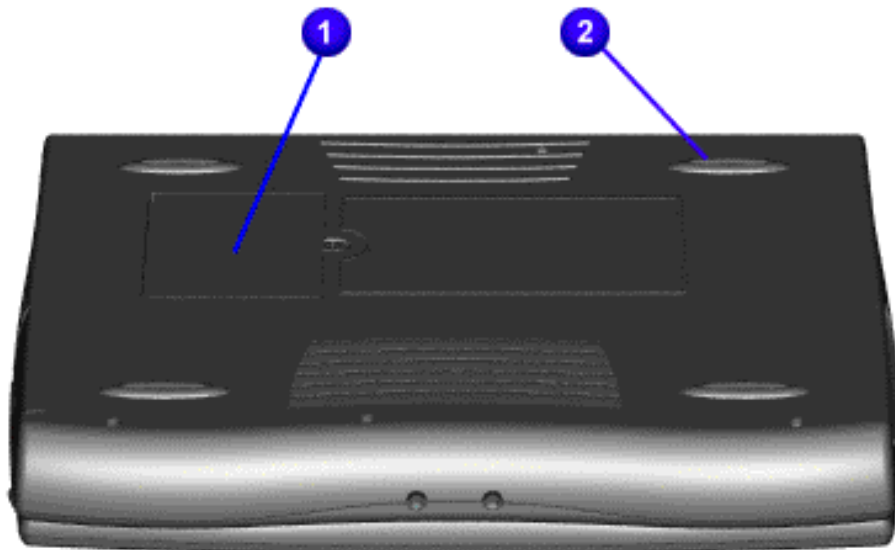

1.
Upgradeable memory compartment.

2.
Rubber feet.

1.800.AT.COMPAQ

[privacy and legal statement](#)

COMPAQ

[STORE](#) | [PRODUCTS](#) | [SERVICES](#) | [SUPPORT](#) | [CONTACT US](#) | [SEARCH](#)

Maintenance & Service Guide

Presario 1200 Series

Models: 1255, 1257, 1260, 1262, 1266, and 1267

[Home Page](#) | [Notice](#) | [Preface](#) | [Product Description](#) | [Troubleshooting](#)
[Illustrated Parts Catalog](#) | [Removal & Replacement Procedures](#) | [Specifications](#)
[Pin Assignments](#) | [Battery Pack Operations](#)

Rear Connectors

[Models and Features](#)

[Controls and Lights](#)

[Left Side Components](#)

[Right Side Components](#)

[Bottom of Unit](#)

[Rear Connectors](#)

[Power Management for Windows 98](#)

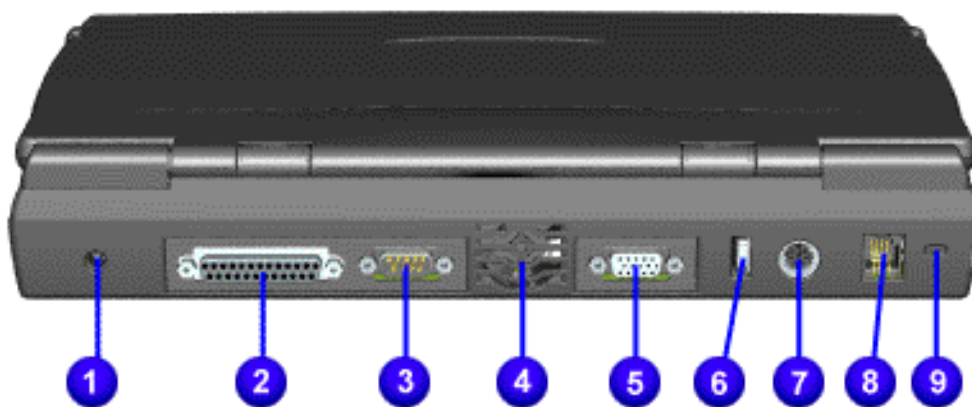

1. AC Adapter.

2. Parallel Printer Port.

3. Serial Port.

4. Fan Exhaust.

5. External Monitor Port.

6. USB.

7. Keyboard/ Mouse Port.

8. Modem Jack.

**9.
Security
Slot.**

1.800.AT.COMPAQ

[privacy and legal statement](#)

COMPAQ

[STORE](#) | [PRODUCTS](#) | [SERVICES](#) | [SUPPORT](#) | [CONTACT US](#) | [SEARCH](#)

Maintenance & Service Guide

Presario 1200 Series

Models: 1255, 1257, 1260, 1262, 1266, and 1267

| [Home Page](#) | [Notice](#) | [Preface](#) | [Product Description](#) | [Troubleshooting](#)
[Illustrated Parts Catalog](#) | [Removal & Replacement Procedures](#) | [Specifications](#)
[Pin Assignments](#) | [Battery Pack Operations](#)

Power Management for Windows 98

The following power management features are available for conserving AC power and extending battery operating time:

[Power Management Settings](#)

[Sleep](#)

[Hibernation](#)

[Battery Operating Time](#)

[Rebooting After Lockup](#)

[Servicing Your Computer](#)

1.800.AT.COMPAQ

[privacy and legal statement](#)

COMPAQ

[STORE](#) | [PRODUCTS](#) | [SERVICES](#) | [SUPPORT](#) | [CONTACT US](#) | [SEARCH](#)

Maintenance & Service Guide

Presario 1200 Series

Models: 1255, 1257, 1260, 1262, 1266, and 1267

[Home Page](#) | [Notice](#) | [Preface](#) | [Product Description](#) | [Troubleshooting](#)
[Illustrated Parts Catalog](#) | [Removal & Replacement Procedures](#) | [Specifications](#)
[Pin Assignments](#) | [Battery Pack Operations](#)

Preliminary Steps

Before running [POST](#), complete the following preliminary steps:

1. If a power-on password has been established, type the password and press the **Enter** key. If the password is not known, [clear the password](#).
2. Run [Computer Checkup](#).
3. Turn off the computer and its external devices.
4. Disconnect any external devices that you do not want to test. Do not disconnect the printer if you want to test it or use it to log error messages.

IMPORTANT:

If the problem only occurs when an external device is connected to the computer, the problem may be related to the external device or its cable. Verify this by running POST with and without the external device connected.

5. Install loopback plugs in the serial and parallel connectors if you would like to test these ports.
6. Ensure the hard drive is installed in the computer.
7. Ensure that the battery pack is inserted in the computer and the computer is connected to an external AC power source.

When the preliminary steps are completed, you are ready to run [POST](#).

Return to [Troubleshooting index page](#).

1.800.AT.COMPAQ

[privacy and legal statement](#)

Maintenance & Service Guide

Presario 1200 Series

Models: 1255, 1257, 1260, 1262, 1266, and 1267

[Home Page](#) | [Notice](#) | [Preface](#) | [Product Description](#) | [Troubleshooting](#)
[Illustrated Parts Catalog](#) | [Removal & Replacement Procedures](#) | [Specifications](#)
[Pin Assignments](#) | [Battery Pack Operations](#)

Clearing the Power-on Password

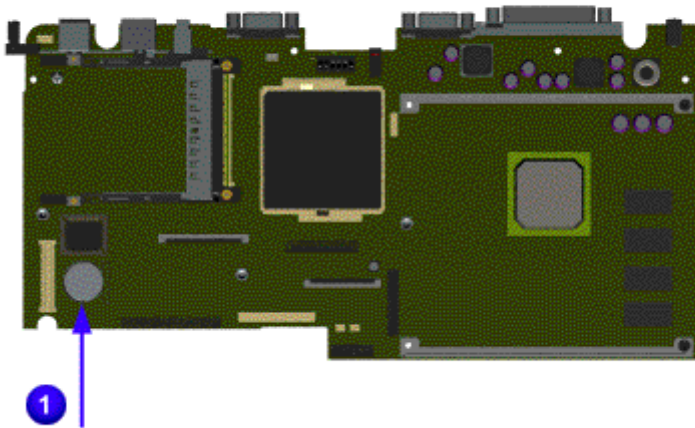

Clearing the power-on password requires removing all Setup attributes that are programmed in the CMOS. The RTC battery is located on the system board. 1

If the password is not known, clear it by performing the following steps:

1. Turn off the computer.
2. Disconnect the power cord.
3. Remove the [battery pack](#).
4. Remove the [Palmrest Cover with Touch Pad](#).
5. Remove the [keyboard](#).
6. Remove the [heatspreader](#).
7. Remove [modem](#).
8. Remove RTC battery for 30 seconds and replace it .
9. Reassemble the computer.
10. Turn on the computer to verify that the power-on password has been cleared. If it has not been cleared, repeat Steps 1 through 10.

Return to [preliminary steps](#) page.

or

Return to [Troubleshooting](#) index page.

[privacy and legal statement](#)

Maintenance & Service Guide

Presario 1200 Series

Models: 1255, 1257, 1260, 1262, 1266, and 1267

| [Home Page](#) | [Notice](#) | [Preface](#) | [Product Description](#) | [Troubleshooting](#)
[Illustrated Parts Catalog](#) | [Removal & Replacement Procedures](#) | [Specifications](#)
[Pin Assignments](#) | [Battery Pack Operations](#)

Power-On Self Test (POST)

Running POST

To run POST, complete the following steps:

- Turn off the computer, then turn on the computer.
- If POST does not detect any errors, the computer will not beep. This indicates successful completion of POST test. POST has run successfully and boots from the hard drive (or from a bootable diskette if one is installed in the diskette drive).
- If POST detects errors, the errors are indicated by screen and/or audible messages. Refer to "Power-On Self-Test (POST) Codes" in the tables for a list of POST codes and their relevant descriptions.

NOTE: If the system is not functioning well enough to run POST, or if the display is not functioning well enough to show POST error messages, refer to the Troubleshooting tables.

Power-On Self-Test Messages

102-System Board Failure

Probable Cause	Recommended Action
DMA, timers, etc.	Replace the system board.

162-System Options Not Set

Probable Cause	Recommended Action
Configuration incorrect	Run Computer Setup.
CMOS reflects that an invalid configuration has been set.	Run Computer Setup.

RAM failure	<ol style="list-style-type: none"> 1. Replace the memory modules. 2. Replace the system board.
Memory test data error	<ol style="list-style-type: none"> 1. Replace the memory modules. 2. Replace the system board.
XX000YZZ RAM failure	Replace the system board.

XX000YZZ 201-Memory Error

Probable Cause	Recommended Action
RAM failure	<ol style="list-style-type: none"> 1. Replace the memory modules. 2. Replace the system board.
Memory test data error	<ol style="list-style-type: none"> 1. Replace the memory modules. 2. Replace the system board
XX000YZZ Ram failure	1. Replace the system board

301-Keyboard Error

Probable Cause	Recommended Action
Keyboard failure	<ol style="list-style-type: none"> 1. Ensure the keys are not depressed during POST. 2. Reconnect the keyboard with the computer off. 3. Replace the keyboard.

304-Keyboard or System Unit Error

Probable Cause	Recommended Action
Keyboard or system board error	<ol style="list-style-type: none"> 1. Replace the keyboard. 2. Replace the TouchPad or mouse. 3. Replace the system board.

601-Diskette Controller Error

Probable Cause	Recommended Action
Mismatch in drive type or failure in the diskette controller	<ol style="list-style-type: none"> 1. Run Computer Checkup (TEST). 2. Check and/or replace cables. 3. Replace the system board.

605-Diskette Drive Error**Probable Cause****Recommended Action**

Mismatch in drive type

Run Computer Setup.

1780-Primary Hard Drive 0 Failure**Probable Cause****Recommended Action**

Disk 0 failed to respond

1. Run Computer Checkup (TEST).

2. Replace the hard drive.

Hard drive format error

1. Run Computer Checkup (TEST).

2. Replace the hard drive.

1782-Hard Drive Controller**Probable Cause****Recommended Action**

Hard drive controller failure

1. Run Computer Setup.

2. Replace the hard drive.

1.800.AT.COMPAQ[privacy and legal statement](#)

Maintenance & Service Guide

Presario 1200 Series

Models: 1255, 1257, 1260, 1262, 1266, and 1267

[Home Page](#) | [Notice](#) | [Preface](#) | [Product Description](#) | [Troubleshooting](#)
[Illustrated Parts Catalog](#) | [Removal & Replacement Procedures](#) | [Specifications](#)
[Pin Assignments](#) | [Battery Pack Operations](#)

Compaq Diagnostics

Compaq Diagnostics is installed on the hard drive of the computer. Run the Diagnostics utilities when you want to view or test system information and if you have installed or connected devices. If you run Compaq Diagnostics from a diskette, ensure that it is version 10.11 or later.

The Diagnostics menu includes the following utilities:

- [Computer Checkup \(TEST\)](#)
- [View System Information \(INSPECT\)](#)
- [Prepare Computer for a Compaq Service Call \(RemotePaq\)](#)

If you have a problem you cannot solve, run the Diagnostics utilities before you call for support. Run Computer Checkup and select to save the device list to a file and to print or to save the log of errors. Run the View System Information (INSPECT) utility and select to print or to save that information. Have the files or the printed information available when you call for support.

Computer Checkup (TEST)

Computer Checkup (TEST) determines whether the various computer components and devices are recognized by the system and are functioning properly. You can display, print, or save the information generated by Computer Checkup.

Follow these steps to run Computer Checkup:

1. Plug the computer into an external power source. (A low battery condition could interrupt the program.)
2. Turn on the external devices that you want to test. Connect the printer if you want to print a log of error messages.
3. Insert the Compaq Diagnostics diskette in drive A.
4. Turn on or restart the computer. The computer starts from drive A, and the **Diagnostics Welcome** screen appears.

5. Press **Enter** to continue. The **Diagnostics** menu appears.
6. Select Computer Checkup from the **Diagnostics** menu. A **Test Option** menu appears.
7. Select **View the Device List** from the **Test Option** menu. A list of the installed Compaq devices appears.
8. If the list of installed devices is correct, select **OK**. The **Test Option** menu appears.

NOTE: If the list is incorrect, ensure that any new devices are installed properly.

9. Select one of the following from the **Test Option** menu:
 - Quick Check Diagnostics. Runs a quick, general test on each device with a minimal number of prompts. If errors occur, they display when the testing is complete. You cannot print or save the error messages.
 - Automatic Diagnostics. Runs unattended, maximum testing of each device with minimal prompts. You can choose how many times to run the tests, to stop on errors, or to print or save a log of errors.
 - Prompted Diagnostics. Allows maximum control over testing the devices. You can choose attended or unattended testing, decide to stop on errors, or choose to print or save a log of errors.
10. Follow the instructions on the screen as the devices are tested. When testing is complete, the **Test Option** menu appears.
11. Exit the **Test Option** menu.
12. Exit the **Diagnostics** menu.

Return to [top of this page](#)

View System Information (INSPECT)

The View System Information (INSPECT) utility provides information about the computer and installed or connected devices. You can display, print, or save the information.

Follow these steps to run View System Information (INSPECT) from the Compaq Diagnostics diskette:

1. Turn on the external devices that you want to test. Connect the printer if you want to print the information.
2. Insert the Compaq Diagnostics diskette in drive A.

3. Turn on or restart the computer. The computer starts from drive A, and the **Diagnostics Welcome** screen appears.
4. Press **Enter** to continue. The Diagnostics menu appears.
5. Select **View System Information (INSPECT)** from the **Diagnostics** menu.
6. Select the item you want to view from the following list:

System	Memory
ROM	Audio
Keyboard	Operating system
System ports	System files
System storage	Windows files
Graphics	

7. Follow the instructions on the screen to cycle through the screens, to return to the list and choose another item, or to print the information.

Return to [top of this page](#)

or to [Preliminary steps](#) page.

or to the [Troubleshooting](#) index page.

1.800.AT.COMPAQ

[privacy and legal statement](#)

COMPAQ

[STORE](#) | [PRODUCTS](#) | [SERVICES](#) | [SUPPORT](#) | [CONTACT US](#) | [SEARCH](#)

Maintenance & Service Guide

Presario 1200 Series

Models: 1255, 1257, 1260, 1262, 1266, and 1267

| [Home Page](#) | [Notice](#) | [Preface](#) | [Product Description](#) | [Troubleshooting](#)
[Illustrated Parts Catalog](#) | [Removal & Replacement Procedures](#) | [Specifications](#)
[Pin Assignments](#) | [Battery Pack Operations](#)

Diagnostic Error Codes

Diagnostic error codes occur if the system recognizes a problem while running the Compaq Diagnostic program. These error codes help identify possibly defective subassemblies.

The following tables list error codes, a description of the error condition, and the action required to resolve the error condition.

IMPORTANT:

Retest the system after completing each step. If the problem has been resolved, do not proceed with the remaining steps.

For the removal and replacement of a particular subassembly, see [Removal and Replacement Procedures](#).

Select error codes by number or type:

[101 through 114](#)
[200 through 215](#)
[300 through 304](#)
[401 through 403](#)
[600 through 699](#)
[1101](#)
[1701 through 1736](#)

[Processor Test](#)
[Memory Test](#)
[Keyboard Test](#)
[Parallel Printer Test](#)
[Diskette Drive Test](#)
[Serial Test](#)

[501 through 516](#)
[2402 through 2456](#)
[2458 through 2480](#)
[3206](#)
[8601 through 8602](#)
[3301 through 6623](#)

[Hard Drive Test](#)
[Video Test](#)
[Audio Test](#)
[Touch Pad Pointing Device Test](#)
[CD Test](#)

Processor Test Error Codes

Error Code	Description	Recommended Action
101-xx	CPU test failed	Replace the processor and retest.
102-xx	Coprocessor or Weitek Error	1. Run the Configuration and Diagnostics Utilities. 2. Replace the processor board and retest.
103-xx	DMA page registers test failed	Replace the system board and retest.
104-xx	Interrupt controller master test failed	
105-xx	Port 61 error	
106-xx	Keyboard controller self-test failed	
107-xx	CMOS RAM test failed	
108-xx	CMOS interrupt test failed	
109-xx	CMOS clock test failed	
110-xx	Programmable timer load data test failed	
113-xx	Protected mode test failed	
114-01	Speaker test failed	

Memory Test Error Codes

200-xx	Memory machine ID test failed	1. Flash the system ROM and retest. 2. Replace the system board and retest.
202-xx	Memory system ROM checksum failed	
203-xx	Write/Read test failed	1. Remove the memory module and retest.

204-xx	Address test failed	2. Install a new memory module and retest.
211-xx	Random pattern test failed	
214-xx	Noise test failed	
215-xx	Random address test failed	

Return [to the top](#)

Keyboard Test Error Codes

300-xx	Failed ID Test	1. Check the keyboard connection. If disconnected, turn off the computer and connect the keyboard.
301-xx	Failed Selftest/Interface Test	
302-xx	Failed Individual Key Test	2. Replace the keyboard and retest.
304-xx	Failed Keyboard Repeat Test	3. Replace the system board and retest.

Parallel Printer Test Error Codes

401-xx	Printer failed or not connected	1. Connect the printer. 2. Check power to the printer. 3. Install the loop-back connector and retest.
402-xx	Failed Port Test	
403-xx	Printer pattern test failed	
		4. Check port and IRQ configuration. 5. Replace the system board and retest.

Return [to the top](#).

Diskette Drive Test

600-xx	Diskette ID drive types test failed	1. Replace the diskette media and retest. 2. Check and/or replace the diskette power and signal cables and retest. 3. Replace the diskette drive and retest. 4. Replace the system board and retest.
601-xx	Diskette format failed	
602-xx	Diskette read test failed	
603-xx	Diskette write, read, compare test failed	
604-xx	Diskette random read test failed	
605-xx	Diskette ID media failed	
606-xx	Diskette speed test failed	
609-xx	Diskette reset controller test failed	
610-xx	Diskette change line test failed	
697-xx	Diskette type error	

698-xx	Diskette drive speed not within limits	
699-xx	Diskette drive/media ID error	<ol style="list-style-type: none"> 1. Replace media. 2. Run the Configuration and Diagnostics Utilities.

Return [to the top](#).

Serial Test Error Codes

1101-xx	Serial port test failed	<ol style="list-style-type: none"> 1. Check port configuration 2. Replace the system board and retest.
---------	-------------------------	--

Hard Drive Test Error Codes

1701-xx	Hard drive format test failed	<ol style="list-style-type: none"> 1. Run the Configuration and Diagnostics Utilities and verify drive type. 2. Verify that all secondary drives have secondary drive capability. 3. Replace the hard drive and retest. 4. Replace the system board and retest.
1702-xx	Hard drive read test failed	
1703-xx	Hard drive write/read/compare test failed	
1704-xx	Hard drive random seek test failed	
1705-xx	Hard drive controller test failed	
1706-xx	Hard drive ready test failed	
1707-xx	Hard drive recalibration test failed	
1708-xx	Hard drive format bad track test failed	
1709-xx	Hard drive reset controller test failed	
1710-xx	Hard drive park head test failed	
1715-xx	Hard drive head select test failed	
1716-xx	Hard drive conditional format test failed	
1717-xx	Hard drive ECC* test failed	
1719-xx	Hard drive power mode test failed	
1724-xx	Network preparation test failed	
1736-xx	Drive monitoring test failed	

* ECC = Error Correction Code

Return [to the top](#).

Video Test Error Codes

501-xx	Video controller test failed	<p>The following apply to error codes 501-xx through 516-xx:</p> <ol style="list-style-type: none"> 1. Disconnect external monitor and test with internal LCD display. 2. Replace the display assembly and retest. 3. Replace the system board and retest.
502-xx	Video memory test failed	
503-xx	Video attribute test failed	
504-xx	Video character set test failed	
505-xx	Video 80 × 25 mode 9 × 14 character cell test failed	
506-xx	Video 80 × 25 mode 8 × 8 character cell test failed	
507-xx	Video 40 × 25 mode test failed	
508-xx	Video 320 × 200 mode color set 0 test failed	
509-xx	Video 320 × 200 mode color set 1 test failed	
510-xx	Video 640 × 200 mode test failed	
511-xx	Video screen memory page test failed	
512-xx	Video gray scale test failed	
514-xx	Video white screen test failed	
516-xx	Video noise pattern test failed	
2402-xx	Video memory test failed	<p>The following steps apply to error codes 2402-xx through 2456-xx:</p> <ol style="list-style-type: none"> 1. Run the Configuration and Diagnostics Utilities. 2. Replace the display assembly and retest. 3. Replace the system board and retest.
2403-xx	Video attribute test failed	
2404-xx	Video character set test failed	
2405-xx	Video 80 × 25 mode 9 × 14 character cell test failed	
2406-xx	Video 80 × 25 mode 8 × 8 character cell test failed	
2408-xx	Video 320 × 200 mode color set 0 test failed	
2409-xx	Video 320 × 200 mode color set 1 test failed	
2410-xx	Video 640 × 200 mode test failed	
2411-xx	Video screen memory page test failed	
2412-xx	Video gray scale test failed	
2414-xx	Video white screen test failed	

2416-xx	Video noise pattern test failed		
2418-xx	ECG/VGC memory test failed		
2419-xx	ECG/VGC ROM checksum test failed	<ol style="list-style-type: none"> 1. Run the Configuration and Diagnostics Utilities. 2. Disconnect external monitor and test with internal LCD display. 3. Replace the display assembly and retest. 4. Replace the system board and retest. 	
2421-xx	ECG/VGC 640 × 200 graphics mode test failed		
2422-xx	ECG/VGC 640 × 350 16 color set test failed		
2423-xx	ECG/VGC 640 × 350 64 color set test failed		
2424-xx	ECG/VGC monochrome text mode test failed		
2425-xx	ECG/VGC monochrome graphics mode test failed		
2431-xx	640 × 480 graphics test failure		
2432-xx	320 × 200 graphics (256 color mode) test failure		
2448-xx	Advanced VGA Controller test failed		
2451-xx	132-column Advanced VGA test failed		
2456-xx	Advanced VGA 256 Color test failed		
2458-xx	Advanced VGA BitBLT test		<p>The following step applies to error codes 2458-xx through 2480-xx:</p> <p>Replace the system board and retest.</p>
2468-xx	Advanced VGA DAC test		
2477-xx	Advanced VGA data path test		
2478-xx	Advanced VGA BitBLT test		
2480-xx	Advanced VGA LineDraw test		

Return [to the top](#).

Audio Test Error Codes

3206-xx	Audio System Internal Error	Replace the system board and retest.
TouchPad/Pointing Device Interface Test Error Codes		
8601-xx	Mouse test failed	1. Replace the TouchPad and retest. 2. Replace the system board and retest.
8602-xx	Interface test failed	
CD Drive Test Error Codes		
3301-xx	CD drive read test failed	1. Replace the CD and retest. 2. Verify that the speakers are connected. 3. Verify that drivers are loaded and properly installed. 4. Replace the CD drive and retest. 5. Replace the system board and retest.
3305-xx	CD drive seek test failed	
6600-xx	ID test failed	
6605-xx	Read test failed	
6608-xx	Controller test failed	
6623-xx	Random read test failed	

Return [to the top](#).

or return to the [Troubleshooting](#) index page.

1.800.AT.COMPAQ

[privacy and legal statement](#)

Maintenance & Service Guide

Presario 1200 Series

Models: 1255, 1257, 1260, 1262, 1266, and 1267

| [Home Page](#) | [Notice](#) | [Preface](#) | [Product Description](#) | [Troubleshooting](#)
[Illustrated Parts Catalog](#) | [Removal & Replacement Procedures](#) | [Specifications](#)
[Pin Assignments](#) | [Battery Pack Operations](#)

Troubleshooting Without Diagnostics

This section provides information about how to identify and correct some common hardware, memory, and software problems. It also explains several types of common messages that may be displayed on the screen. The following pages contain troubleshooting information on:

Audio	Memory
Battery/Battery gauge	PC Card
CD drive	Power
Diskette/Diskette drive	Printer
Display	Touch Pad
Hard drive	Keyboard/Numeric keypad
Hardware Installation	

Since symptoms can appear to be similar, carefully match the symptoms of the computer malfunction against the problem description in the Troubleshooting tables to avoid a misdiagnosis.



WARNING: To avoid a potential shock hazard during troubleshooting procedures, disconnect all power sources before removing the keyboard cover or the display bezel.

Before Replacing Parts

Verify that cables are connected properly to the suspected defective parts.

- Run Computer Setup after connecting external devices.
- Verify that all required device drivers are installed.
- Verify that all required changes have been made to the *CONFIG.SYS* file.
- Verify that all required changes have been made to the *AUTOEXEC.BAT* file.
- Verify that all printer drivers have been installed for each application.

Return to the [Troubleshooting](#) index page.

1.800.AT.COMPAQ

[privacy and legal statement](#)

Maintenance & Service Guide

Presario 1200 Series

Models: 1255, 1257, 1260, 1262, 1266, and 1267

| [Home Page](#) | [Notice](#) | [Preface](#) | [Product Description](#) | [Troubleshooting](#)
[Illustrated Parts Catalog](#) | [Removal & Replacement Procedures](#) | [Specifications](#)
[Pin Assignments](#) | [Battery Pack Operations](#)

Solving Minor Problems

Some minor problems and possible solutions are outlined in the following tables. If the problem appears related to a software application, check the documentation provided with the software.

Solving Audio Problems

Some common audio problems and solutions are listed in the following table.

Solving Audio Problems		
Problem	Probable Cause	Solution(s)
Computer does not beep after the Power-On Self-Test (POST).	This is typical; it indicates successful completion of the Power-On Self-Test (POST).	No action is required.

Solving Battery Pack and Battery Gauge Problems

Some common causes and solutions for battery pack problems are listed in the following table. The "Solving Power Problems" section in this chapter may also be applicable.

Solving Battery Pack and Battery Gauge Problems		
Problem	Probable Cause	Solution(s)
Computer won't turn on when battery pack is inserted and power cord is unplugged.	Battery pack is discharged.	Connect the computer to an external power source and charge the battery pack. Replace the battery pack with a fully charged battery pack.
		Check the battery connectors on the system board to verify they are evenly spaced and that they are not bent or broken.

Computer is beeping and battery LED icon is blinking.	Battery charge is low.	Immediately save any open file(s). Then do any one of the following: <ul style="list-style-type: none"> • Connect the computer to an external power source to charge the battery pack. • Turn off the computer or initiate Hibernation until you can find another power source or charge the battery pack.
Computer battery LED icon (front on the unit) blinks to indicate low battery condition, but computer does not beep.	Volume is turned down too low.	Adjust the volume.
Battery LED icon doesn't light and battery pack won't fast charge.	Battery pack is already charged.	No action is necessary.
	Battery pack was exposed to temperature extremes.	Allow time for the battery pack to return to room temperature.
	Battery pack is at end of its life.	Replace battery pack.
You have to set the date and time every time you turn on the computer.	RTC battery is dead.	Replace the RTC battery.

Problem	Probable Cause	Solution(s)
Battery charge does not last as long as expected.	Battery is being exposed to high temperatures or extremely cold temperatures.	Keep the battery pack within the recommended operating temperature range 50° F to 104° F (10° C to 40° C) or recommended storage range -4° F to 86° F (-20° C to 30° C). Recharge the battery pack.
	Battery has partially self-discharged.	Recharge the battery. Discharge the battery completely and then recharge it.
	Power management is disabled.	Set a power management level in Computer Setup.
	An external device or PC Card is draining the battery.	Turn off or disconnect external devices when not using them.
Battery pack is warm to the touch after charging.	Normal warming has occurred due to charging.	No action is required.
Battery pack operating time is far less than the documented average operating time.	Power management is turned off or disabled.	Enable power management in Computer Setup and in Windows Power Properties.
	An external device or PC Card is draining the battery.	Turn off or disconnect external devices when not using them.

	Battery pack has partially self-discharged.	<p>Condition the battery pack by fully charging, fully discharging, then fully recharging it.</p> <p>To maintain the charge, leave battery packs in the computer when it is connected to external power.</p> <p>If the computer is disconnected from external power for more than two weeks, remove battery packs from the computer to reduce the discharge rate.</p>
	Battery pack is being exposed to high temperatures or extremely cold temperatures.	<p>Keep the battery pack within the recommended temperature ranges. Operating: 50° F to 104° F (10° C to 40° C) Storage: -4° F to 86° F (-20° C to 30° C)</p> <p>Recharge the battery pack.</p>

Solving CD Drive Problems

Some common causes and solutions for CD drive problems are listed in the following table.

Solving CD Drive Problems		
Problem	Probable Cause	Solution(s)
CD drive cannot read a compact disc.	Compact disc is upside down or is improperly inserted in the CD drive.	Open the CD loading tray, lay the compact disc in it (label side up), then close the tray.
	CD is CD Plus or Pregap/Track 0 type.	Cannot read these type CDs in 24x. Remove the CD.

Solving Diskette and Diskette Drive Problems

Some common causes and solutions for diskette and diskette drive problems are listed in the following table.

Solving Diskette and Diskette Drive Problems		
Problem	Probable Cause	Solution(s)
Diskette drive cannot write to a diskette.	Diskette is write-protected.	Disable the diskette's write-protect feature or use a diskette that is not write-protected.
	Computer is writing to the wrong drive.	Check the drive letter in the path statement.
	Not enough space is left on the diskette.	Use another diskette.

	Drive error has occurred.	Run Computer Checkup from the Compaq Diagnostics diskette.
	Diskette is not formatted.	Format the diskette. At the system prompt, enter FORMAT A:
Diskette drive cannot read a diskette.	The wrong type of diskette is being used.	Use the type of diskette required by the drive.
	Diskette has a bad sector.	Copy files to hard drive or another diskette. Reformat bad floppy.
	Drive error has occurred.	Run Computer Checkup from the Compaq Diagnostics diskette.
	Diskette is not formatted.	Format the diskette. At the system prompt, enter FORMAT A:
Cannot boot from diskette.	Bootable diskette is not in drive A.	Put the bootable diskette in drive A.
	Diskette Boot has incorrect setting in Computer Setup.	Run Computer Setup and set diskette as first to boot.

Solving Display Problems

This section lists some common causes and solutions for computer display and external monitor problems.

You can perform a monitor self-test on an external VGA color or monochrome monitor by disconnecting the monitor from the computer. To do so, complete the following steps:

1. Turn off the monitor.
2. Turn off the computer.
3. Disconnect the monitor signal cable from the computer.
4. Turn on the monitor and allow it to warm up for one minute.

The display should be white. A narrow black border may also appear on the left and right sides of the display. Either of these displays indicates that the monitor is working properly.

Solving Display Problems		
Problem	Probable Cause	Solution(s)
Screen is dim.	Control for brightness or contrast (if applicable) is not set properly.	Adjust the Brightness of the display by using Fn + F7 or Fn + F8 . Adjust the Contrast of the display by using Fn + F5 or Fn + F6 .
	Computer screen is in direct light.	Tilt display or move computer.

Screen is blank.	Screen save was initiated by Power Management due to lack of user activity.	Press any key or touch the Touch Pad.
	Display has overheated.	If computer is in direct sunlight, move it and allow it to cool off.
Display is blank and the Suspend icon is flashing.	System is in Suspend mode.	Press any key or touch the Touch Pad.
Internal display is blank and the screen on an external monitor displays information.	Display function was switched to the external monitor.	Use Fn + F3 to switch between LCD or CRT .

Problem	Probable Cause	Solution(s)
Internal display flashes or has garbled characters when computer is connected to external monitor.	Using 1024 × 768 or higher resolution on external monitor and have toggled back to internal display, which supports up to 800 × 600.	Restart the computer.
The light tubes on the edge of the display panel do not light up at all and Power-On Self-Test (POST) completes when the unit is powered up.**	Improper backlight or display cable connections	Replace the display assembly.
	Defective inverter board.	Replace the display assembly.
	Defective display cable.	Replace the display assembly.
	Defective display panel.	Replace the display assembly.
	Defective system board.	Replace the system board.
The light tubes on the edge of the display panel do not light up at all and Power-On Self-Test (POST) does not complete when the unit is powered up.**	Defective system board.	Replace the system board.
Backlight (brightness) cannot be adjusted with Fn + F7 or Fn + F8 ***	Improper display cable connections.	1. Reseat the display cable to the system board. 2. Replace the display assembly.
	Defective inverter board.	Replace the display assembly.
	Defective display cable.	Replace the display assembly.
	Defective system board.	Replace the system board.
Contrast cannot be adjusted with Fn + F5 or Fn + F6 .	Improper display cable connections.	1. Reseat the display cable to the system board. 2. Replace the display assembly.
	Defective inverter board.	Replace the display assembly.
	Defective display cable.	Replace the display assembly.
	Defective system board.	Replace the system board.

****** This problem indicates that the backlight or its power circuitry has failed. Since you cannot observe the POST result on the display panel when the backlight is not functioning, connect the unit to an external monitor before powering the unit up. If an external monitor is not available, verify that POST completes by opening and closing the display, listening for the single or double beep, and watching for the LEDs turn on at the front of the computer.

Problem	Probable Cause	Solution(s)
This display panel has a continuous pattern across it (e.g., a "jailbars" pattern), has a single color on it, or has garbled graphics across the entire panel. This failure is for patterns across the entire panel (not just on one section).	Improper display cable connections	Reseat the display cable to the following until the problem is solved: 1. System board 2. Display assembly
	Defective display cable.	Replace the display assembly.
	Defective inverter board.	Replace the display assembly.
	Defective system board.	Replace the system board.
Ghost bars extending from graphics on the display.	Common characteristic of STN displays.	1. Change the background colors. 2. Adjust the Contrast of the display by using Fn + F5 or Fn + F6 .
A single line, small group of lines, or block appears on the display panel. This failure occurs in only a section of the display panel.	Defective display panel.	Replace the display assembly.

NOTE: To perform a "self-test" on an external VGA color or monochrome monitor, complete the following steps: The screen should be white. A narrow black border may also appear on the left and right sides of the display. Either of these displays indicates that the monitor is working properly.

Solving Hard Drive Problems

Some common causes and solutions for hard drive problems are listed in the following table.



CAUTION: To prevent loss of information, always maintain an up-to-date backup of your hard drive at all times, in case of errors or failures.

Solving Hard Drive Problems

Problem	Probable Cause	Solution(s)
Reading hard drive takes an unusually long time after restarting the computer.	System entered Hibernation due to low battery condition and is now exiting from it.	Give the system time to restore the previously saved data to its exact state before Hibernation.
Hard drive error occurs.	Hard drive has bad sectors or has failed.	Run Computer Checkup.
Hard drive does not work.	Hard drive is not seated properly.	Turn off and unplug the computer, remove the battery pack, and remove and then reinstall the hard drive.

Solving Hardware Installation Problems

Some common causes and solutions for hardware installation problems are listed in the following table.

Solving Hardware Installation Problems

Problem	Probable Cause	Solutions(s)
A new device is not recognized as part of the computer system.	Cable(s) of new external device are loose or power cables are unplugged.	Ensure that all cables are properly and securely connected.
	Power switch of new external device is not turned on.	Turn off the computer, turn on the external device, then turn on the computer to integrate the device with the computer system.
	Device is not seated properly.	Turn off the computer and reinsert the device.

Solving Keyboard/Numeric Keypad Problems

Some common causes and solutions for keyboard/numeric keypad problems are listed in the following table.

Solving Keyboard/Numeric Keypad Problems

Problem	Probable Cause	Solution(s)
Embedded numeric keypad on computer keyboard is disabled.	Num Lock function is not enabled.	Press the Shift+NumLk keys to enable the Num Lock function and embedded numeric keypad. The Num Lock icon on the status panel turns on.
Embedded numeric keypad is disabled and Num Lock function is on.	External numeric keypad is connected to the computer.	Disconnect the external numeric keypad from the computer.

Solving Memory Problems

Some common causes and solutions for memory problems are listed in the following table.

Solving Memory Problems		
Problem	Probable Cause	Solution(s)
Memory count during Power-On Self-Test (POST) is incorrect.	Optional memory expansion card is installed incorrectly, is incompatible with the computer, or is defective.	Ensure that the optional memory expansion card is installed correctly.
"Out of Memory" message is displayed on the screen or insufficient memory error occurs during operation.	System ran out of memory for the application.	Check the application documentation for memory requirements. Install additional memory.
	Too many TSR (terminate-and-stay-resident) applications are running.	Remove from memory any TSR applications that you do not need.

[Solving Minor Problems \(continued\)](#)

or return to the [Troubleshooting index page](#).

1.800.AT.COMPAQ

[privacy and legal statement](#)

COMPAQ

[STORE](#) | [PRODUCTS](#) | [SERVICES](#) | [SUPPORT](#) | [CONTACT US](#) | [SEARCH](#)

Maintenance & Service Guide

Presario 1200 Series

Models: 1255, 1257, 1260, 1262, 1266, and 1267

[Home Page](#) | [Notice](#) | [Preface](#) | [Product Description](#) | [Troubleshooting](#)
[Illustrated Parts Catalog](#) | [Removal & Replacement Procedures](#) | [Specifications](#)
[Pin Assignments](#) | [Battery Pack Operations](#)

Contacting Compaq Support

Obtain the following information before contacting Compaq Reseller Support:

- Product name
- Product serial number
- Purchase date
- Conditions under which the problem occurred
- Any error messages that have occurred
- Hardware configuration
- Type of printer connected
- Hardware/software being used
- Printed result of Computer Checkup (TEST)
- Printed copies of *CONFIG.SYS* and *AUTOEXEC.BAT* files, if possible

Shipping Preparation

To ship the computer, complete the following steps:

1. Back up the critical hard drive files. Ensure that backup tapes/diskette are not exposed to electrical or magnetic fields while stored in transit.
2. Turn off the computer and external devices.
3. Disconnect the external devices from their power sources, then from the computer.

IMPORTANT:

Ensure that there is no diskette in the diskette drive and that there are no PC Cards in the PC slots.

4. Close the display and all exterior doors of the computer.
5. Pack the computer with sufficient packing material to protect it. Use the original packing box or similar packaging.

Return to [Compaq Diagnostics](#) page or [Troubleshooting Index](#) page.

1.800.AT.COMPAQ

[privacy and legal statement](#)

COMPAQ

[STORE](#) | [PRODUCTS](#) | [SERVICES](#) | [SUPPORT](#) | [CONTACT US](#) | [SEARCH](#)

Maintenance & Service Guide

Presario 1200 Series

Models: 1255, 1257, 1260, 1262, 1266, and 1267

[Home Page](#) | [Notice](#) | [Preface](#) | [Product Description](#) | [Troubleshooting](#)
[Illustrated Parts Catalog](#) | [Removal & Replacement Procedures](#) | [Specifications](#)
[Pin Assignments](#) | [Battery Pack Operations](#)

System Unit

Place cursor over each device to attain its part number.

System Unit

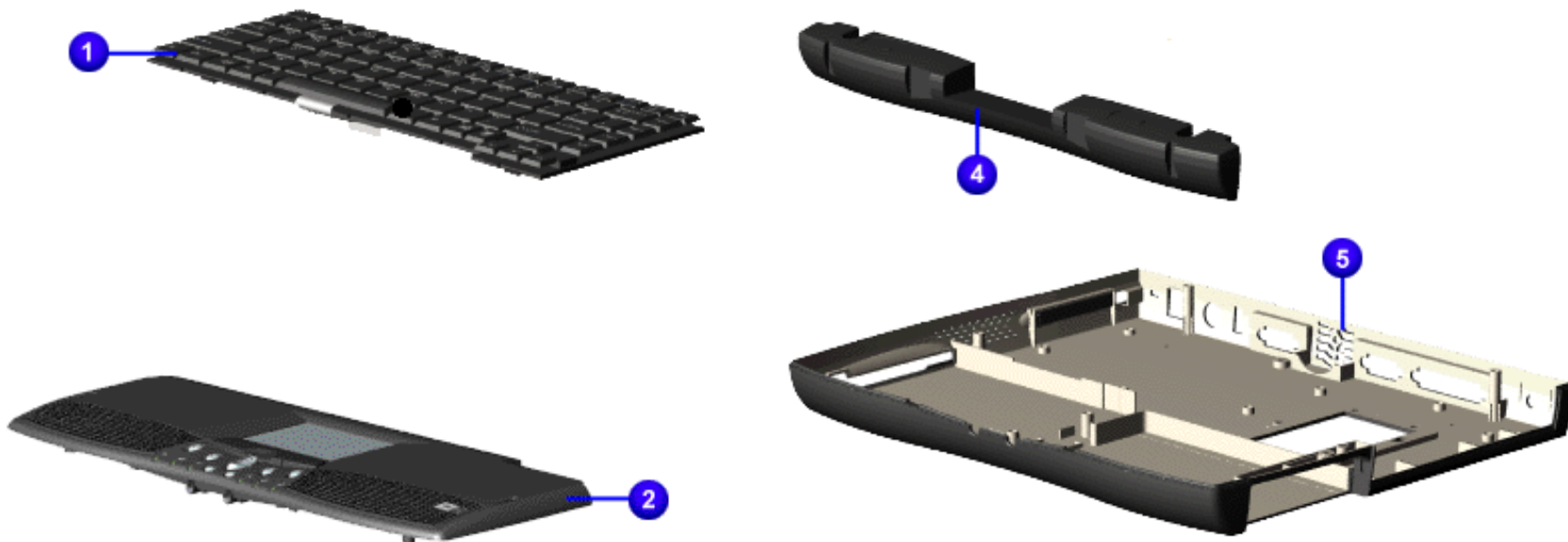
[Boards](#)[Display
Assembly](#)[Mass Storage
Devices](#)[Miscellaneous
Cable Kit](#)[Cables](#)[Miscellaneous
Hardware and
Plastics Kit](#)[Miscellaneous
Parts](#)[Documentation
and Software](#)

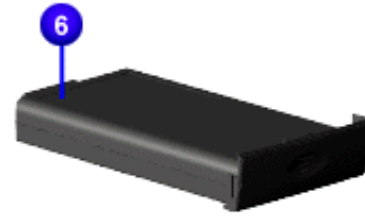
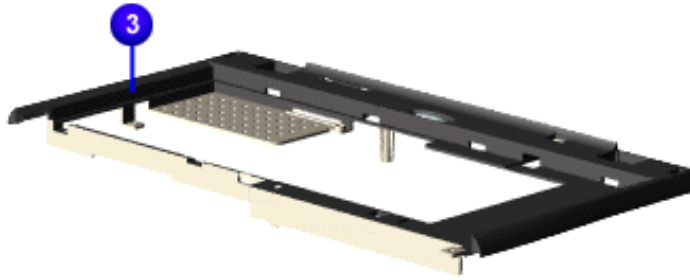

1.800.AT.COMPAQ

[privacy and legal statement](#)

COMPAQ

[STORE](#) | [PRODUCTS](#) | [SERVICES](#) | [SUPPORT](#) | [CONTACT US](#) | [SEARCH](#)

Maintenance & Service Guide

Presario 1200 Series

Models: 1255, 1257, 1260, 1262, 1266, and 1267

[Home Page](#) | [Notice](#) | [Preface](#) | [Product Description](#) | [Troubleshooting](#)
[Illustrated Parts Catalog](#) | [Removal & Replacement Procedures](#) | [Specifications](#)
[Pin Assignments](#) | [Battery Pack Operations](#)

Boards

[System Unit](#)[Boards](#)[Display Assembly](#)[Mass Storage Devices](#)[Miscellaneous Cable Kit](#)[Cables](#)[Miscellaneous Hardware and Plastics Kit](#)[Miscellaneous Parts](#)[Documentation and Software](#)

Place cursor over each device to attain its part number.

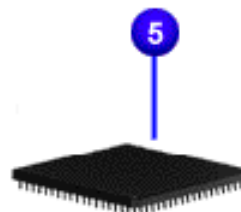
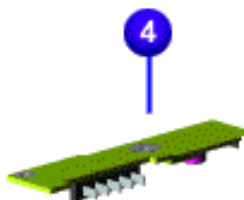
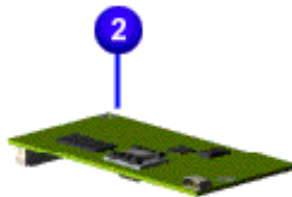
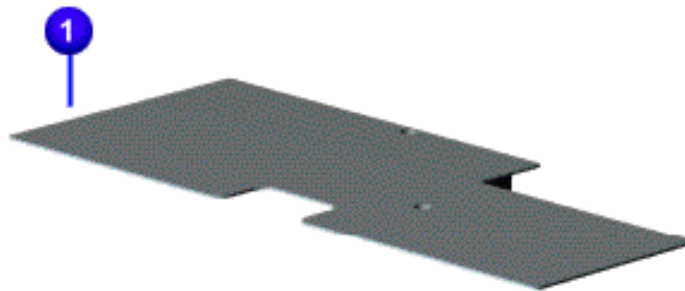

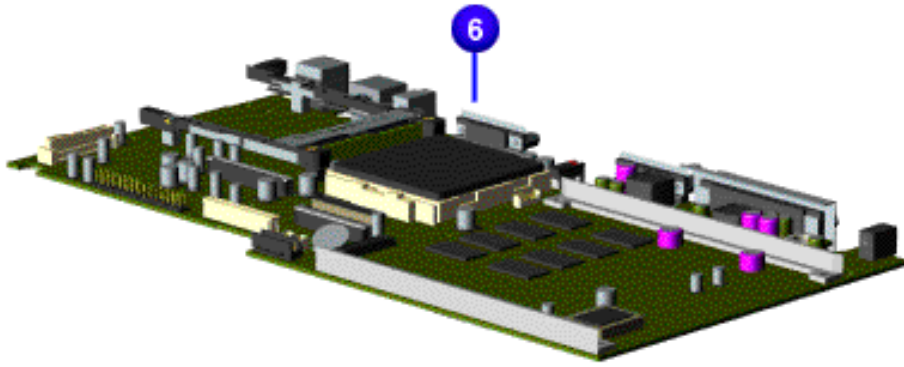

1.800.AT.COMPAQ

[privacy and legal statement](#)

COMPAQ

[STORE](#) | [PRODUCTS](#) | [SERVICES](#) | [SUPPORT](#) | [CONTACT US](#) | [SEARCH](#)

Maintenance & Service Guide

Presario 1200 Series

Models: 1255, 1257, 1260, 1262, 1266, and 1267

[Home Page](#) | [Notice](#) | [Preface](#) | [Product Description](#) | [Troubleshooting](#)
[Illustrated Parts Catalog](#) | [Removal & Replacement Procedures](#) | [Specifications](#)
[Pin Assignments](#) | [Battery Pack Operations](#)

Display Assembly

[System Unit](#)

[Boards](#)

[Display Assembly](#)

[Mass Storage Devices](#)

[Miscellaneous Cable Kit](#)

[Cables](#)

[Miscellaneous Hardware and Plastics Kit](#)

[Miscellaneous Parts](#)

[Documentation and Software](#)



1.800.AT.COMPAQ

[privacy and legal statement](#)

COMPAQ

[STORE](#) | [PRODUCTS](#) | [SERVICES](#) | [SUPPORT](#) | [CONTACT US](#) | [SEARCH](#)

Compaq.com

United States

Maintenance & Service Guide

Presario 1200 Series

Models: 1255, 1257, 1260, 1262, 1266, and 1267

[Home Page](#) | [Notice](#) | [Preface](#) | [Product Description](#) | [Troubleshooting](#)
[Illustrated Parts Catalog](#) | [Removal & Replacement Procedures](#) | [Specifications](#)
[Pin Assignments](#) | [Battery Pack Operations](#)

Mass Storage Devices

[System Unit](#)

[Boards](#)

[Display Assembly](#)

Mass Storage Devices

[Miscellaneous Cable Kit](#)

[Cables](#)

[Miscellaneous Hardware and Plastics Kit](#)

[Miscellaneous Parts](#)

[Documentation and Software](#)

Place cursor over each device to attain its part number.

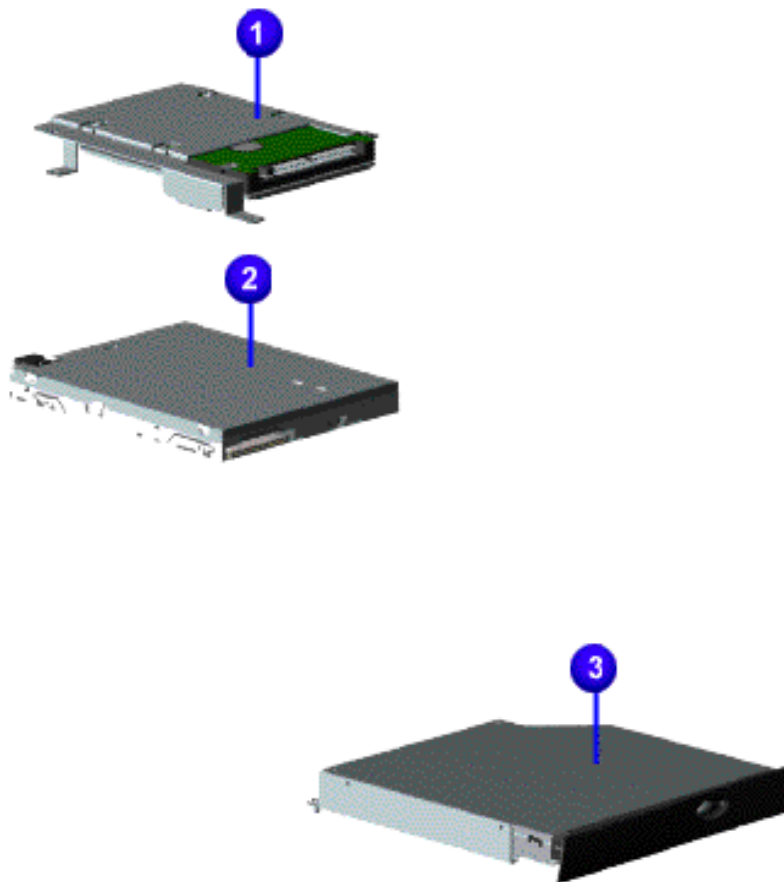

1.800.AT.COMPAQ

[privacy and legal statement](#)

Maintenance & Service Guide Presario 1200 Series Models: 1255, 1257, 1260, 1262, 1266, and 1267

[Home Page](#) | [Notice](#) | [Preface](#) | [Product Description](#) | [Troubleshooting](#)
[Illustrated Parts Catalog](#) | [Removal & Replacement Procedures](#) | [Specifications](#)
[Pin Assignments](#) | [Battery Pack Operations](#)

Miscellaneous Cables Kit

System Unit
Boards
Display Assembly
Mass Storage Devices
Miscellaneous Cable Kit
Cables
Miscellaneous Hardware and Plastics Kit
Miscellaneous Parts
Documentation and Software

Place cursor over each device for a description of that item.

Spare Part Number: 330946-001

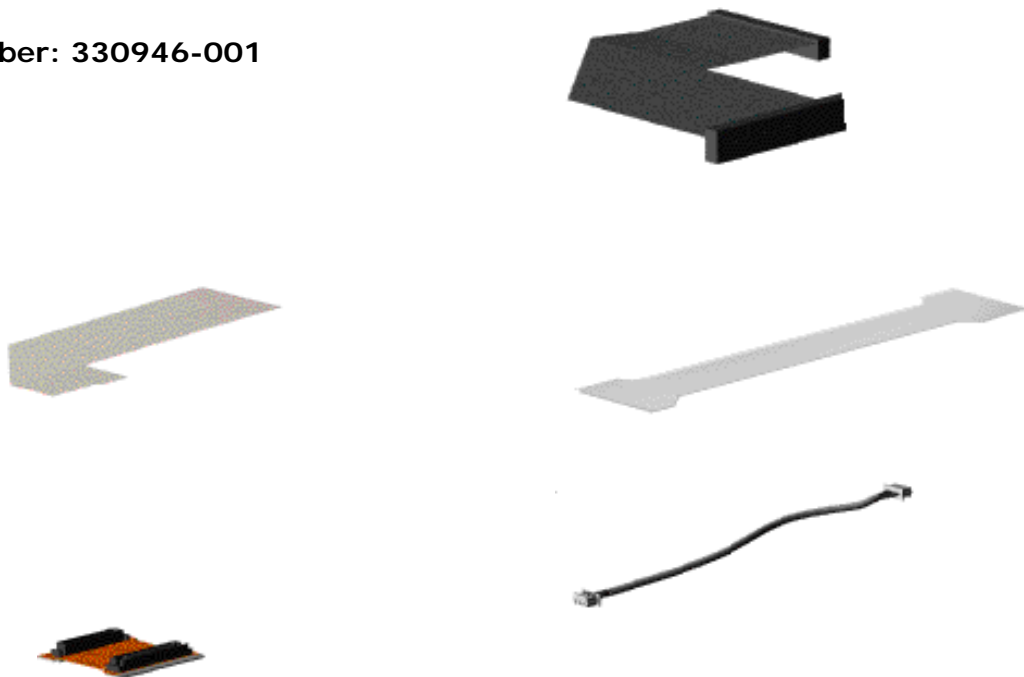

1.800.AT.COMPAQ

[privacy and legal statement](#)

COMPAQ

[STORE](#) | [PRODUCTS](#) | [SERVICES](#) | [SUPPORT](#) | [CONTACT US](#) | [SEARCH](#)

Maintenance & Service Guide

Presario 1200 Series

Models: 1255, 1257, 1260, 1262, 1266, and 1267

[Home Page](#) | [Notice](#) | [Preface](#) | [Product Description](#) | [Troubleshooting](#)
[Illustrated Parts Catalog](#) | [Removal & Replacement Procedures](#) | [Specifications](#)
[Pin Assignments](#) | [Battery Pack Operations](#)

Cables

[System Unit](#)
[Boards](#)
[Display
Assembly](#)
[Mass Storage
Devices](#)
[Miscellaneous
Cable Kit](#)
[Cables](#)
[Miscellaneous
Hardware and
Plastics Kit](#)
[Miscellaneous
Parts](#)
[Documentation
and Software](#)

Description	Spare Part Number
<i>Power Cord</i>	

Description	Spare Part Number
<i>Modem Cables</i>	



[privacy and legal statement](#)

COMPAQ

[STORE](#) | [PRODUCTS](#) | [SERVICES](#) | [SUPPORT](#) | [CONTACT US](#) | [SEARCH](#)

Maintenance & Service Guide

Presario 1200 Series

Models: 1255, 1257, 1260, 1262, 1266, and 1267

[Home Page](#) | [Notice](#) | [Preface](#) | [Product Description](#) | [Troubleshooting](#)
[Illustrated Parts Catalog](#) | [Removal & Replacement Procedures](#) | [Specifications](#)
[Pin Assignments](#) | [Battery Pack Operations](#)

Miscellaneous Hardware and Plastics Kit

[System Unit](#)
[Boards](#)
[Display Assembly](#)
[Mass Storage Devices](#)
[Miscellaneous Cable Kit](#)
[Cables](#)
[Miscellaneous Hardware and Plastics Kit](#)
[Miscellaneous Parts](#)
[Documentation and Software](#)

Miscellaneous Hardware and Plastics Kit

Hardware Spare Part Number: 346853-001 **Plastics Kit Spare Part Number: 330949-001**

<i>Description</i>	<i>Quantity</i>
1. Door, Battery Pack	1 each
2. Cover, Memory Module	1 each
3. Door, PCMCIA	2 each
4. Hinge (Clutch) Cover, Left	1 each
5. Hinge (Clutch) Cover, Right	1 each
6. Rubber Foot	10 each
7. Hard Drive Mounting Bracket	1 each

1.800.AT.COMPAQ

[privacy and legal statement](#)

COMPAQ

[STORE](#) | [PRODUCTS](#) | [SERVICES](#) | [SUPPORT](#) | [CONTACT US](#) | [SEARCH](#)

Maintenance & Service Guide

Presario 1200 Series

Models: 1255, 1257, 1260, 1262, 1266, and 1267

[Home Page](#) | [Notice](#) | [Preface](#) | [Product Description](#) | [Troubleshooting](#)
[Illustrated Parts Catalog](#) | [Removal & Replacement Procedures](#) | [Specifications](#)
[Pin Assignments](#) | [Battery Pack Operations](#)

Miscellaneous Parts

[System Unit](#)[Boards](#)[Display
Assembly](#)[Mass Storage
Devices](#)[Miscellaneous
Cable Kit](#)[Cables](#)[Miscellaneous
Hardware and
Plastics Kit](#)[Miscellaneous
Parts](#)[Documentation
and Software](#)

Use the scroll down menu for the description and spare part number of spare parts **Not Shown**.

1.800.AT.COMPAQ

[privacy and legal statement](#)

COMPAQ

[STORE](#) | [PRODUCTS](#) | [SERVICES](#) | [SUPPORT](#) | [CONTACT US](#) | [SEARCH](#)

Maintenance & Service Guide

Presario 1200 Series

Models: 1255, 1257, 1260, 1262, 1266, and 1267

[Home Page](#) | [Notice](#) | [Preface](#) | [Product Description](#) | [Troubleshooting](#)
[Illustrated Parts Catalog](#) | [Removal & Replacement Procedures](#) | [Specifications](#)
[Pin Assignments](#) | [Battery Pack Operations](#)

Documentation and Software

[System Unit](#)
[Boards](#)
[Display Assembly](#)
[Mass Storage Devices](#)
[Miscellaneous Cable Kit](#)
[Cables](#)
[Miscellaneous Hardware and Plastics Kit](#)
[Miscellaneous Parts](#)
[Documentation and Software](#)

Description	Spare Part Number
Quick Restore CD	
Australia	388205-371
China (PRC)	388205-AA1
Quick Reference Guide (single issue)	162212-001
Quick Reference Guide (quarterly subscription)	184960-001
QuickFind for Windows*, Asia Pacific Edition	137906-xxx

*QuickFind is updated monthly. To complete the QuickFind part number, add the suffix from the table below for the desired month. If you do not specify the 3-digit suffix, the default is the current month in which the order is placed.

QuickFind Part Number Suffix			
Suffix	Month	Suffix	Month
-001	January	-007	July
-002	February	-008	August
-003	March	-009	September
-004	April	-010	October
-005	May	-011	November

-006

June

-012

December

1.800.AT.COMPAQ

[privacy and legal statement](#)

Maintenance & Service Guide

Presario 1200 Series

Models: 1255, 1257, 1260, 1262, 1266, and 1267

| [Home Page](#) | [Notice](#) | [Preface](#) | [Product Description](#) | [Troubleshooting](#)
[Illustrated Parts Catalog](#) | [Removal & Replacement Procedures](#) | [Specifications](#)
[Pin Assignments](#) | [Battery Pack Operations](#)



Electrostatic Discharge



A sudden discharge of static electricity from a finger or other conductor can destroy static-sensitive devices or microcircuitry.

- Often the spark is neither felt nor heard, but damage occurs. An electronic device exposed to an electrostatic discharge (ESD) may not be affected at all and will work perfectly throughout a normal cycle. Although it may function normally for a while, it is possible for the exposed device's internal layers to degrade, reducing its life expectancy considerably.
- Networks built into multiple integrated circuits provide some protection, but in many cases, the discharge can contain enough power to alter device parameters and melt silicon junctions.

Generating Static

This table shows the different electrostatic voltage levels generated by various activities .

NOTE: 700 volts can degrade a product.

Typical Electrostatic Voltages

Event	Relative Humidity		
	10%	40%	55%
Walking across carpet	35,000 V	15,000 V	7,500 V
Walking across vinyl floor	12,000 V	5,000 V	3,000 V
Motions of bench worker	6,000 V	800 V	400 V
Removing DIPS from plastic tubes	2,000 V	700 V	400 V
Removing DIPS from vinyl trays	11,500 V	4,000 V	2,000 V
Removing DIPS from Styrofoam	14,500 V	5,000 V	3,500 V
Removing bubble pack from PCBs	26,000 V	20,000 V	7,000 V
Packing PCBs in foam-lined box	21,000 V	11,000 V	5,000 V

Return to [Removal & Replacement Procedures](#)

1.800.AT.COMPAQ

[privacy and legal statement](#)

COMPAQ

[STORE](#) | [PRODUCTS](#) | [SERVICES](#) | [SUPPORT](#) | [CONTACT US](#) | [SEARCH](#)

Maintenance & Service Guide

Presario 1200 Series

Models: 1255, 1257, 1260, 1262, 1266, and 1267

[Home Page](#) | [Notice](#) | [Preface](#) | [Product Description](#) | [Troubleshooting](#)
[Illustrated Parts Catalog](#) | [Removal & Replacement Procedures](#) | [Specifications](#)
[Pin Assignments](#) | [Battery Pack Operations](#)

Service Considerations

Listed below are some of the considerations that you should keep in mind during the disassembly and re-assembly of the computer.

Tool and Software Requirements

To service the computer, you need the following:

- Compaq screwdriver kit (Spare Part No. 161946-001)
- Torx T-9 screwdriver
- 3/16-inch and 5mm nut drivers (for screwlocks and standoffs)
- Small, standard screwdriver
- Small, Phillips screwdriver
- Diagnostics software

Screws

The screws used in the computer are not interchangeable. If an incorrect screw is used during the reassembly process it can damage the unit.

Compaq strongly recommends that each screw removed during disassembly be kept with the part from which it was removed, then returned to the original location.

IMPORTANT:

As each subassembly is removed from the computer they should be placed away from the work area to prevent damage.

Return to Removal & Replacement Procedures

1.800.AT.COMPAQ

[privacy and legal statement](#)

Maintenance & Service Guide

Presario 1200 Series

Models: 1255, 1257, 1260, 1262, 1266, and 1267

| [Home Page](#) | [Notice](#) | [Preface](#) | [Product Description](#) | [Troubleshooting](#)
[Illustrated Parts Catalog](#) | [Removal & Replacement Procedures](#) | [Specifications](#)
[Pin Assignments](#) | [Battery Pack Operations](#)

Cables and Connectors

Most cables used throughout the units are ribbon cables; they must be handled with extreme care to avoid damage.

Use the following precautions when handling cables to avoid damage to the cable or computer:

- Apply only the required tension to seat or unseat the cables during insertion and removal from the connector.
- Handle cables by the connector whenever possible.
- In all cases, avoid bending, twisting, or tearing the cables, and ensure that the cables are routed in such a way that they cannot be caught or snagged by parts being removed or replaced. Handle flex cables with extreme care; they can tear easily.



CAUTION: When servicing these computers, ensure that cables are placed in their proper location during the reassembly process. Improper cable placement can cause severe damage to the unit.

Select the desired illustration.

- Removing a Cable from a [ZIF Connector](#).
- The ribbon cable position for the [3.2-GB, 4.0-GB, and 6.4-GB hard drive](#).
- The ribbon cable position for the [CD drive](#).
- The ribbon cable position for the [diskette drive](#).
- The cable position for the [speaker assembly](#).

Plastic Parts

Plastic parts can be damaged by the use of excessive force during disassembly and reassembly. When handling the plastic parts, use care. Apply pressure only at the points designated in the maintenance instructions.

Return to [Removal & Replacement Procedures](#)

Compaq Home	Search	Products	Service	Worldwide	Compaq.com
-----------------------------	------------------------	--------------------------	-------------------------	---------------------------	----------------------------

[Comments?](#)

[Legal Notices and Privacy Statement](#)

Revised: 25 February 1999

[1.800.AT.COMPAQ](#)

[privacy and legal statement](#)

Maintenance & Service Guide

Presario 1200 Series

Models: 1255, 1257, 1260, 1262, 1266, and 1267

| [Home Page](#) | [Notice](#) | [Preface](#) | [Product Description](#) | [Troubleshooting](#)
[Illustrated Parts Catalog](#) | [Removal & Replacement Procedures](#) | [Specifications](#)
[Pin Assignments](#) | [Battery Pack Operations](#)

Preparing the Computer for Disassembly

[Electrostatic Discharge](#)

[Service Considerations](#)

[Cables and Connectors](#)

[Preparing the Computer for Disassembly](#)

[Battery Pack](#)

[Palmrest Cover with Touch Pad](#)

[Heatspreader](#)

[Keyboard](#)

[Processor](#)

[Hard Drives](#)

[CD Drive](#)

[Battery Charger Board](#)

[Modem](#)

[Display Panel Assembly](#)

[Upper CPU Cover](#)

[Speaker Assembly](#)

[Diskette Drive](#)

[Fan Assembly](#)

[System Board](#)

Before beginning removal and replacement procedures, complete the following procedures:

1. Disconnect AC power and any external devices.
2. Remove the battery pack.
3. Remove any PC Cards.



WARNING: Metal objects can damage the battery pack as well as the battery contacts in the battery compartment. To prevent damage, do not allow metal objects to touch the battery contacts. Place only the battery pack for the Compaq Presario 1200 Series Portable Computers into the battery compartment. Do not force the battery pack into the bay if insertion does not occur easily.



CAUTION: Do not crush, puncture, or incinerate the battery pack. Do not open a battery pack, as this damages the pack, makes it unusable, and exposes potentially harmful battery components. There are no field-serviceable parts located inside the battery pack.

NOTE:

The Compaq Presario 1200 Series Portable Computers have several screws of various sizes which are **not** interchangeable. Care must be taken during reassembly to ensure that the correct screws are used in their correct location. During removal please keep respective screws with their associated sub-assembly.

[Dip Switch Settings](#)

[Memory Module](#)

Return to [Removal & Replacement Procedures.](#)

1.800.AT.COMPAQ

[privacy and legal statement](#)

COMPAQ

[STORE](#) | [PRODUCTS](#) | [SERVICES](#) | [SUPPORT](#) | [CONTACT US](#) | [SEARCH](#)

Maintenance & Service Guide

Presario 1200 Series

Models: 1255, 1257, 1260, 1262, 1266, and 1267

[Home Page](#) | [Notice](#) | [Preface](#) | [Product Description](#) | [Troubleshooting](#)
[Illustrated Parts Catalog](#) | [Removal & Replacement Procedures](#) | [Specifications](#)
[Pin Assignments](#) | [Battery Pack Operations](#)

Removing the Battery Pack

[Electrostatic Discharge](#)

[Service Considerations](#)

[Cables and Connectors](#)

[Preparing the Computer for Disassembly](#)

[Battery Pack](#)

[Palmrest Cover with Touch Pad](#)

[Heatspreader](#)

[Keyboard](#)

[Processor](#)

[Hard Drives](#)

[CD Drive](#)

[Battery Charger Board](#)

[Modem](#)

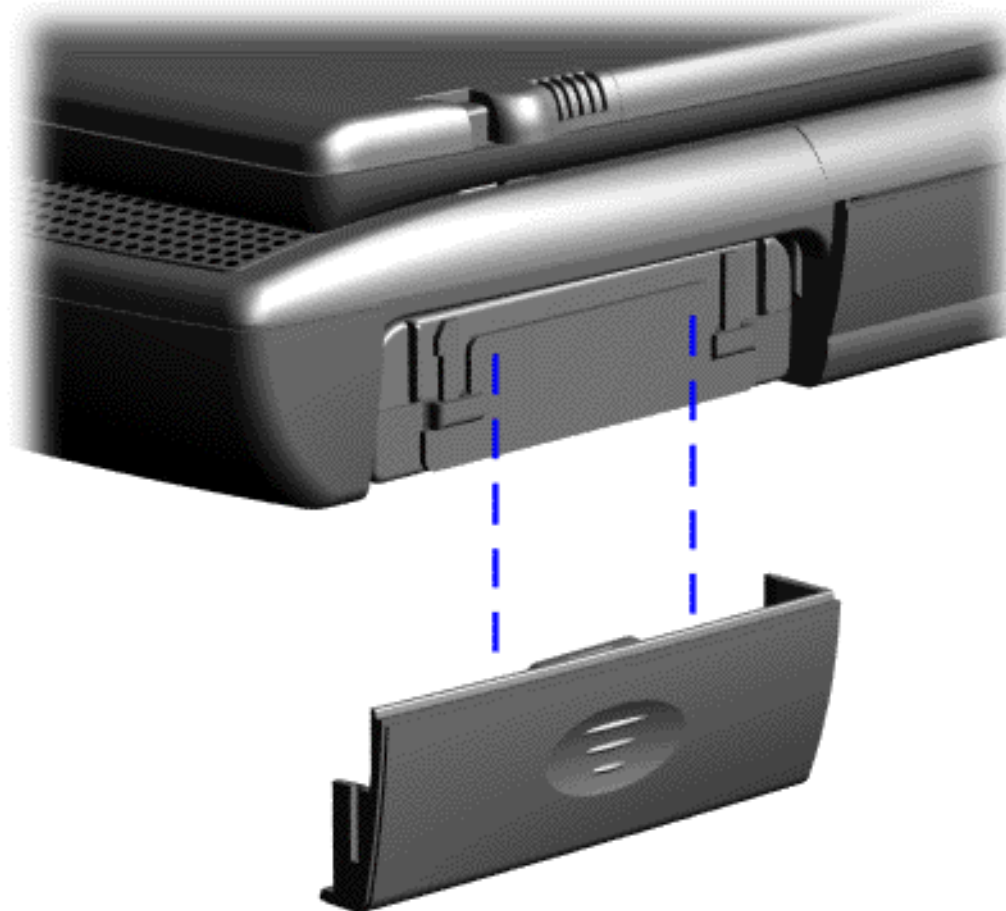

To remove the battery pack, complete the following steps:

1. Slide the battery pack compartment door down and remove it from the battery pack.

[Next Step](#)

[Display Panel
Assembly](#)

[Upper CPU
Cover](#)

[Speaker
Assembly](#)

[Diskette Drive](#)

[Fan Assembly](#)

[System Board](#)

[Dip Switch
Settings](#)

[Memory
Module](#)

[1.800.AT.COMPAQ](tel:1800ATCOMPAQ)

[privacy and legal statement](#)

Maintenance & Service Guide

Presario 1200 Series

Models: 1255, 1257, 1260, 1262, 1266, and 1267

| [Home Page](#) | [Notice](#) | [Preface](#) | [Product Description](#) | [Troubleshooting](#)
[Illustrated Parts Catalog](#) | [Removal & Replacement Procedures](#) | [Specifications](#)
[Pin Assignments](#) | [Battery Pack Operations](#)

Removing the Palmrest Cover with Touch Pad

[Electrostatic Discharge](#)

[Service Considerations](#)

[Cables and Connectors](#)

[Preparing the Computer for Disassembly](#)

[Battery Pack](#)

[Palmrest Cover with Touch Pad](#)

[Heatspreader](#)

[Keyboard](#)

[Processor](#)

[Hard Drives](#)

[CD Drive](#)

[Battery Charger Board](#)

[Modem](#)

[Display Panel Assembly](#)

[Upper CPU Cover](#)

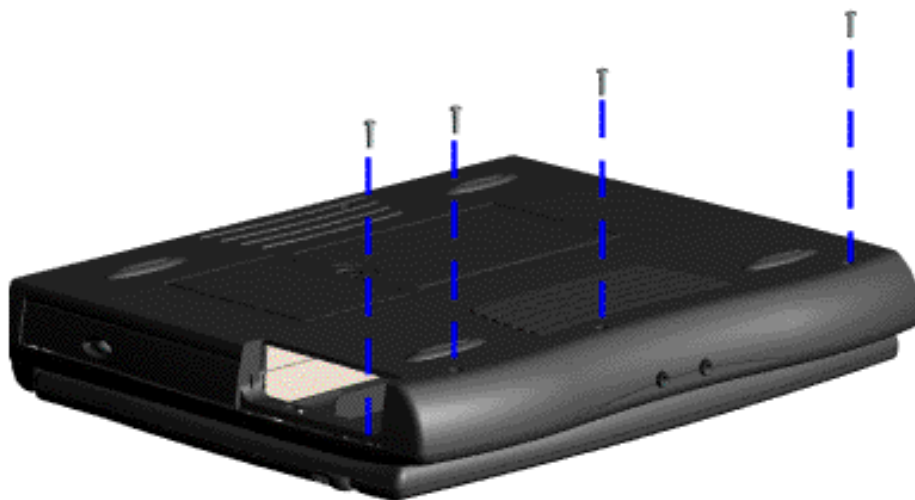

The palmrest cover with touch pad must be removed to gain access to any of the interior components of the computer, and it is the first component that has to be removed to gain access to the interior components.

NOTE: It is not necessary to remove the display panel assembly to access the interior components of the computer.

To remove the palmrest cover with touch pad, complete the following steps:

1. [Prepare the computer for disassembly.](#)

[Speaker
Assembly](#)

[Diskette Drive](#)

[Fan Assembly](#)

[System Board](#)

[Dip Switch
Settings](#)

[Memory
Module](#)

2. Close the computer and turn the computer upside down.

3. Remove four screws from the bottom of the computer.

[Next Step](#)

1.800.AT.COMPAQ

[privacy and legal statement](#)

COMPAQ

[STORE](#) | [PRODUCTS](#) | [SERVICES](#) | [SUPPORT](#) | [CONTACT US](#) | [SEARCH](#)

Maintenance & Service Guide

Presario 1200 Series

Models: 1255, 1257, 1260, 1262, 1266, and 1267

| [Home Page](#) | [Notice](#) | [Preface](#) | [Product Description](#) | [Troubleshooting](#)
[Illustrated Parts Catalog](#) | [Removal & Replacement Procedures](#) | [Specifications](#)
[Pin Assignments](#) | [Battery Pack Operations](#)

Removing the Heatspreader

[Electrostatic Discharge](#)

[Service Considerations](#)

[Cables and Connectors](#)

[Preparing the Computer for Disassembly](#)

[Battery Pack](#)

[Palmrest Cover with Touch Pad](#)

[Heatspreader](#)

[Keyboard](#)

[Processor](#)

[Hard Drives](#)

[CD Drive](#)

[Battery Charger Board](#)

[Modem](#)

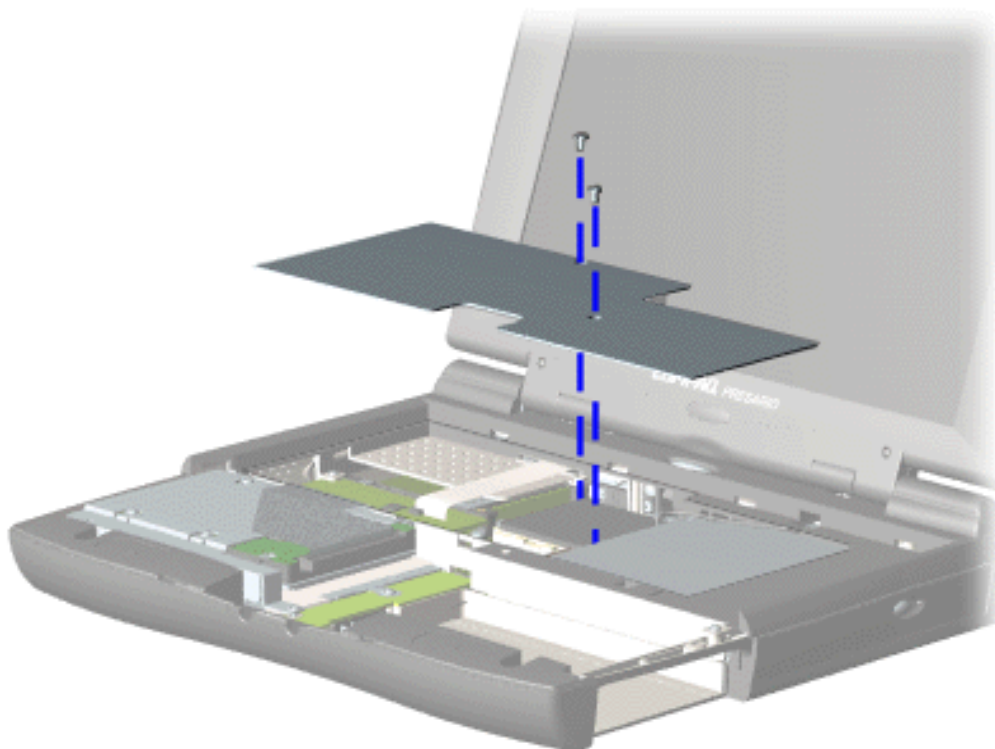

To remove the heatspreader, complete the following steps:

1. [Prepare the computer for disassembly.](#)
2. Remove the [palmrest cover with touch pad.](#)
3. Remove [Keyboard.](#)
4. Remove two screws from the heatspreader and lift out of the chassis.

To replace

[Display Panel
Assembly](#)

[Upper CPU
Cover](#)

[Speaker
Assembly](#)

[Diskette Drive](#)

[Fan Assembly](#)

[System Board](#)

[Dip Switch
Settings](#)

[Memory
Module](#)

*the
heatspreader,
reverse the
previous
procedures.*

1.800.AT.COMPAQ

[privacy and legal statement](#)

COMPAQ

[STORE](#) | [PRODUCTS](#) | [SERVICES](#) | [SUPPORT](#) | [CONTACT US](#) | [SEARCH](#)

Maintenance & Service Guide

Presario 1200 Series

Models: 1255, 1257, 1260, 1262, 1266, and 1267

[Home Page](#) | [Notice](#) | [Preface](#) | [Product Description](#) | [Troubleshooting](#)
[Illustrated Parts Catalog](#) | [Removal & Replacement Procedures](#) | [Specifications](#)
[Pin Assignments](#) | [Battery Pack Operations](#)

Removing the Keyboard

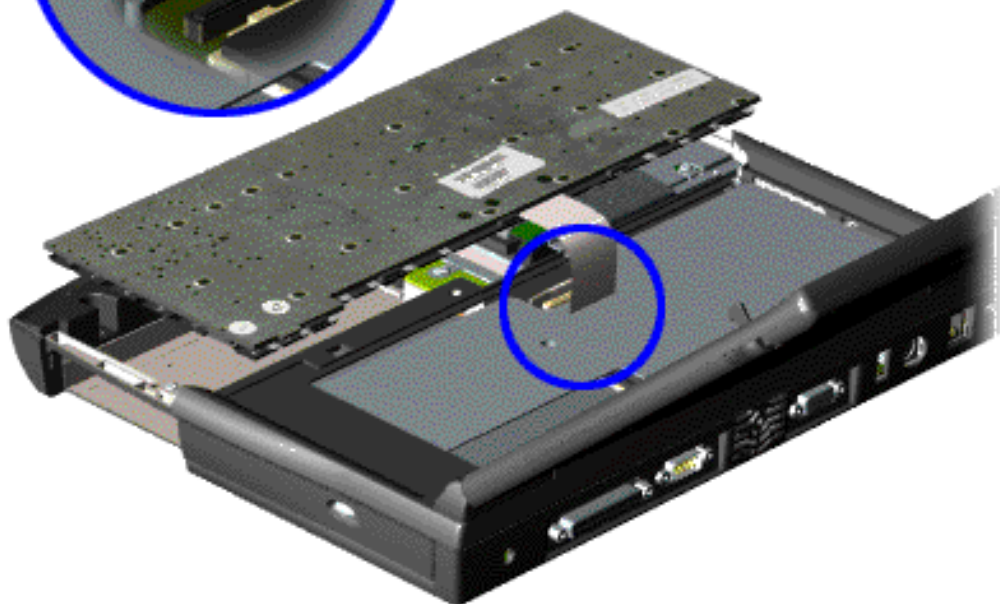
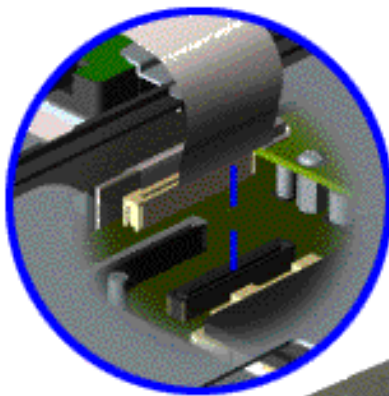
[Electrostatic Discharge](#)[Service Considerations](#)[Cables and Connectors](#)[Preparing the Computer for Disassembly](#)[Battery Pack](#)[Palmrest Cover with Touch Pad](#)[Heatspreader](#)[Keyboard](#)[Processor](#)[Hard Drives](#)[CD Drive](#)

To remove the keyboard, complete the following steps:

1. [Prepare the computer for disassembly.](#)

2. [Remove the palmrest cover with touch pad.](#)

3. Turn the keyboard over allowing it to rest on top of the palmrest cover with touchpad slot opening. .

4. Remove the

[Battery](#)

[Charger Board](#)

[Modem](#)

[Display Panel](#)

[Assembly](#)

[Upper CPU](#)

[Cover](#)

[Speaker](#)

[Assembly](#)

[Diskette Drive](#)

[Fan Assembly](#)

[System Board](#)

[Dip Switch](#)

[Settings](#)

[Memory](#)

[Module](#)

[heatspreader](#)

5. Disconnect the flex cable from the ZIF connector on the system board.

6. Disconnect the flex cable from the ZIF connector on the system board.

To replace the keyboard, reverse the previous procedures.

[Return to Removal & Replacement Procedures](#)

1.800.AT.COMPAQ

[privacy and legal statement](#)

COMPAQ

[STORE](#) | [PRODUCTS](#) | [SERVICES](#) | [SUPPORT](#) | [CONTACT US](#) | [SEARCH](#)

Maintenance & Service Guide

Presario 1200 Series

Models: 1255, 1257, 1260, 1262, 1266, and 1267

[Home Page](#) | [Notice](#) | [Preface](#) | [Product Description](#) | [Troubleshooting](#)
[Illustrated Parts Catalog](#) | [Removal & Replacement Procedures](#) | [Specifications](#)
[Pin Assignments](#) | [Battery Pack Operations](#)

Removing the Processor

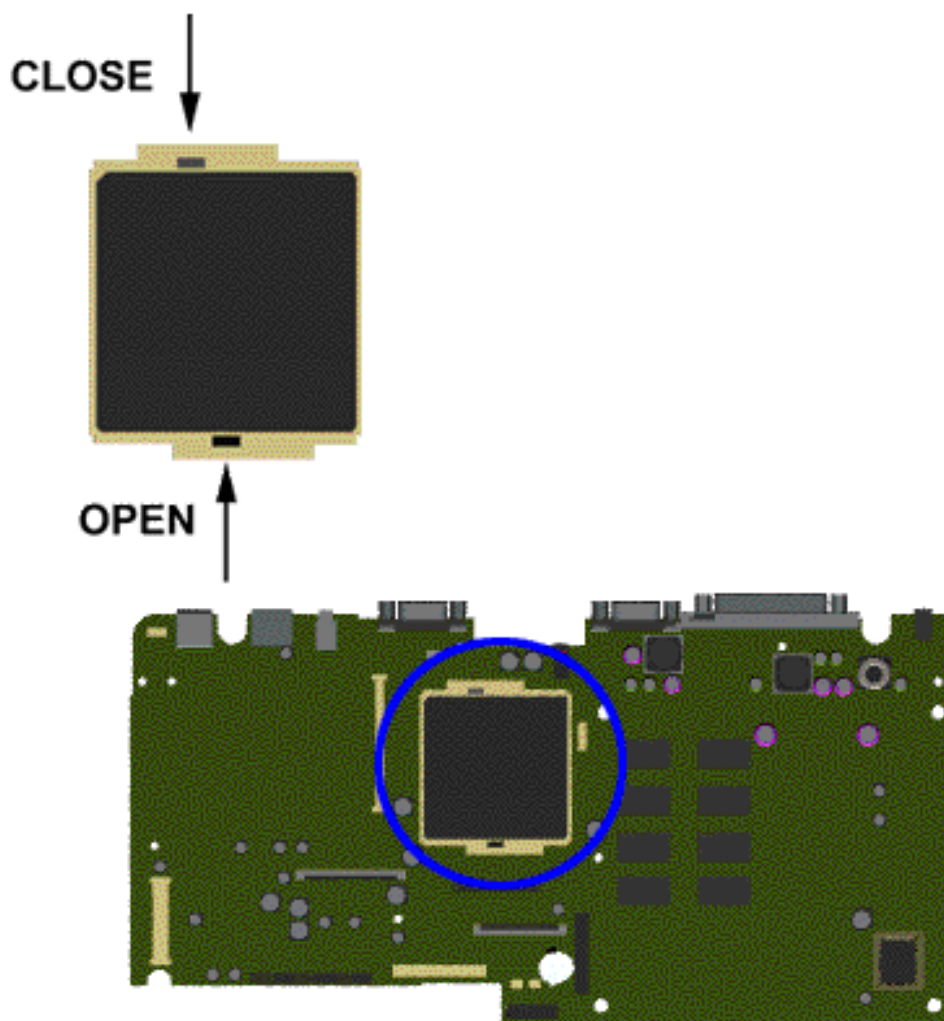
[Electrostatic Discharge](#)
[Service Consideration](#)
[Cables and Connectors](#)
[Preparing the Computer for Disassembly](#)
[Battery Pack](#)
[Palmrest Cover with Touch Pad](#)
[Heatspreader](#)
[Keyboard](#)
[Processor](#)
[Hard Drives](#)
[CD Drive](#)

To remove the processor, complete the following steps:

1. [Prepare the computer for disassembly.](#)
2. Remove [palmrest cover with touchpad.](#)
3. Remove the [heatspreader.](#)
4. Remove the [keyboard.](#)
5. Insert a

[Battery
Charger
Board](#)

[Modem](#)

[Display
Panel
Assembly](#)

[Upper CPU
Cover](#)

[Speaker
Assembly](#)

[Diskette
Drive](#)

[Fan Assembly](#)

[System
Board](#)

[Dip Switch
Settings](#)

[Memory
Module](#)

small blade screw driver into the bottom slot opening on the processor and push toward the display to release the processor from the chassis slot.

6. Lift the processor out of the processor chassis slot.

[Next Step](#)

1.800.AT.COMPAQ

[privacy and legal statement](#)

COMPAQ

[STORE](#) | [PRODUCTS](#) | [SERVICES](#) | [SUPPORT](#) | [CONTACT US](#) | [SEARCH](#)

Maintenance & Service Guide

Presario 1200 Series

Models: 1255, 1257, 1260, 1262, 1266, and 1267

[Home Page](#) | [Notice](#) | [Preface](#) | [Product Description](#) | [Troubleshooting](#)
[Illustrated Parts Catalog](#) | [Removal & Replacement Procedures](#) | [Specifications](#)
[Pin Assignments](#) | [Battery Pack Operations](#)

Removing the Hard Drive

[Electrostatic Discharge](#)

[Service Consideration](#)

[Cables and Connectors](#)

[Preparing the Computer for Disassembly](#)

[Battery Pack](#)

[Palmrest Cover with Touch Pad](#)

[Heatspreader](#)

[Keyboard](#)

[Processor](#)

[Hard Drives](#)

[CD Drive](#)

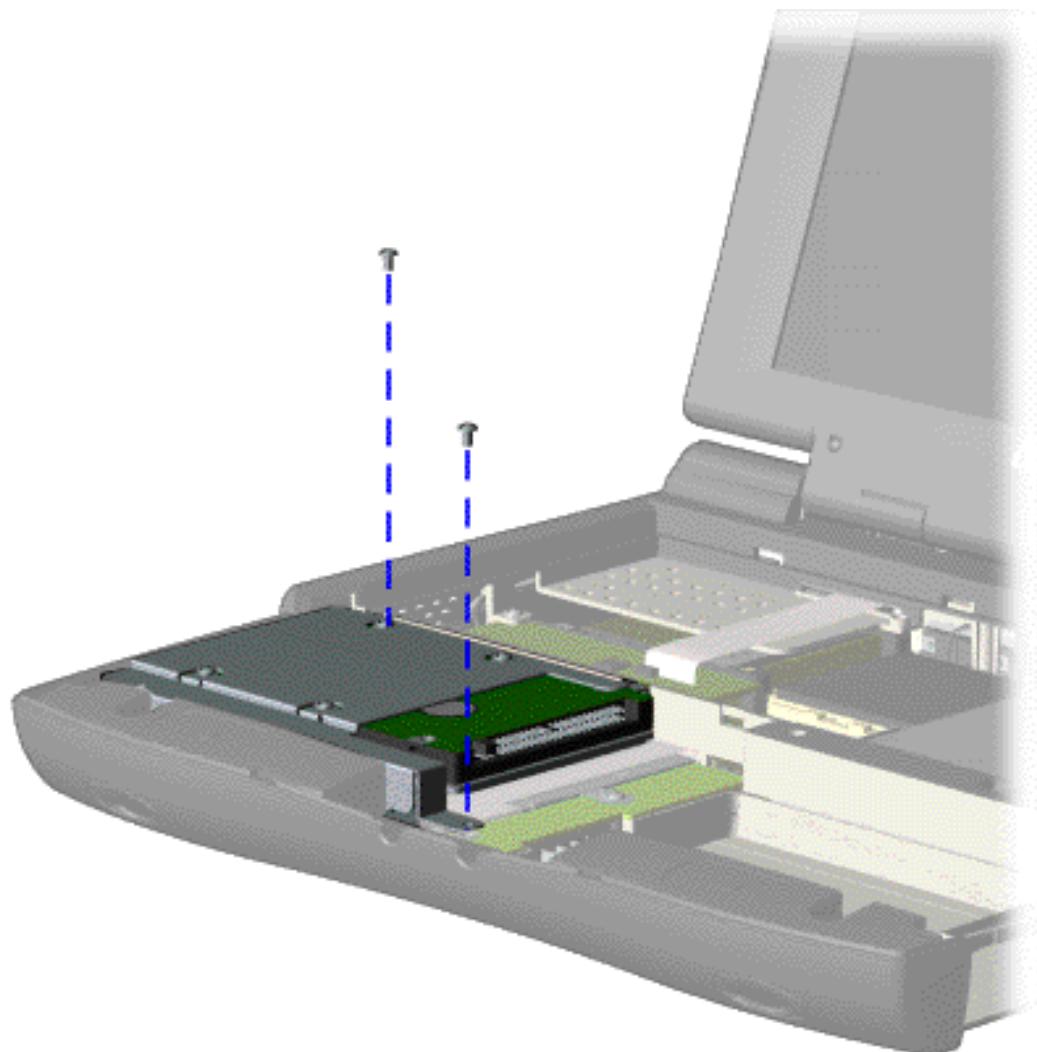

To remove the hard drive, complete the following steps:

1. Prepare the [computer for disassembly](#).
2. Remove the [palmrest cover with touch pad](#).
3. Remove the [keyboard](#).
4. Remove

[Battery
Charger
Board](#)

[Modem](#)

[Display
Panel
Assembly](#)

[Upper CPU
Cover](#)

[Speaker
Assembly](#)

[Diskette
Drive](#)

[Fan Assembly](#)

[System
Board](#)

[Dip Switch
Settings](#)

[Memory
Module](#)

two screws from the hard drive mounting bracket and lift up the hard drive.

[Next Step](#)

1.800.AT.COMPAQ

[privacy and legal statement](#)

COMPAQ

[STORE](#) | [PRODUCTS](#) | [SERVICES](#) | [SUPPORT](#) | [CONTACT US](#) | [SEARCH](#)

Maintenance & Service Guide

Presario 1200 Series

Models: 1255, 1257, 1260, 1262, 1266, and 1267

[Home Page](#) | [Notice](#) | [Preface](#) | [Product Description](#) | [Troubleshooting](#)
[Illustrated Parts Catalog](#) | [Removal & Replacement Procedures](#) | [Specifications](#)
[Pin Assignments](#) | [Battery Pack Operations](#)

Removing the CD Drive

[Electrostatic Discharge](#)

[Service Consideration](#)

[Cables and Connectors](#)

[Preparing the Computer for Disassembly](#)

[Battery Pack](#)

[Palmrest Cover with Touch Pad](#)

[Heatspreader](#)

[Keyboard](#)

[Processor](#)

[Hard Drives](#)

CD Drive

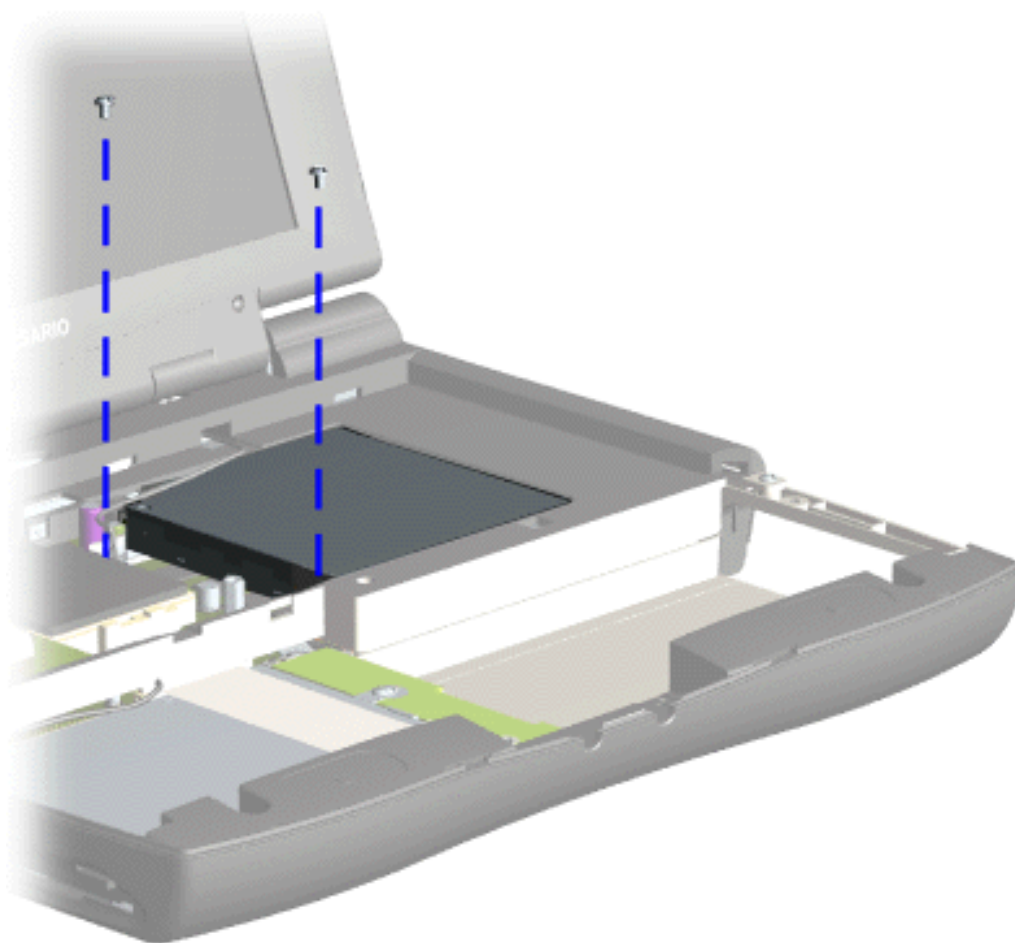

To remove the CD drive, complete the following steps:

1. Prepare the [computer for disassembly](#).
2. Remove the [palmrest cover with touch pad](#).
3. Remove the [heatspreader](#).
4. Remove the [keyboard](#).
5. Remove two screws located at

[Battery
Charger
Board](#)

[Modem](#)

[Display
Panel
Assembly](#)

[Upper CPU
Cover](#)

[Speaker
Assembly](#)

[Diskette
Drive](#)

[Fan Assembly](#)

[System
Board](#)

[Dip Switch
Settings](#)

[Memory
Module](#)

the back CD
drive.

[Next Step](#)

1.800.AT.COMPAQ

[privacy and legal statement](#)

COMPAQ

[STORE](#) | [PRODUCTS](#) | [SERVICES](#) | [SUPPORT](#) | [CONTACT US](#) | [SEARCH](#)

Maintenance & Service Guide

Presario 1200 Series

Models: 1255, 1257, 1260, 1262, 1266, and 1267

[Home Page](#) | [Notice](#) | [Preface](#) | [Product Description](#) | [Troubleshooting](#)
[Illustrated Parts Catalog](#) | [Removal & Replacement Procedures](#) | [Specifications](#)
[Pin Assignments](#) | [Battery Pack Operations](#)

Removing the Battery Charger Board

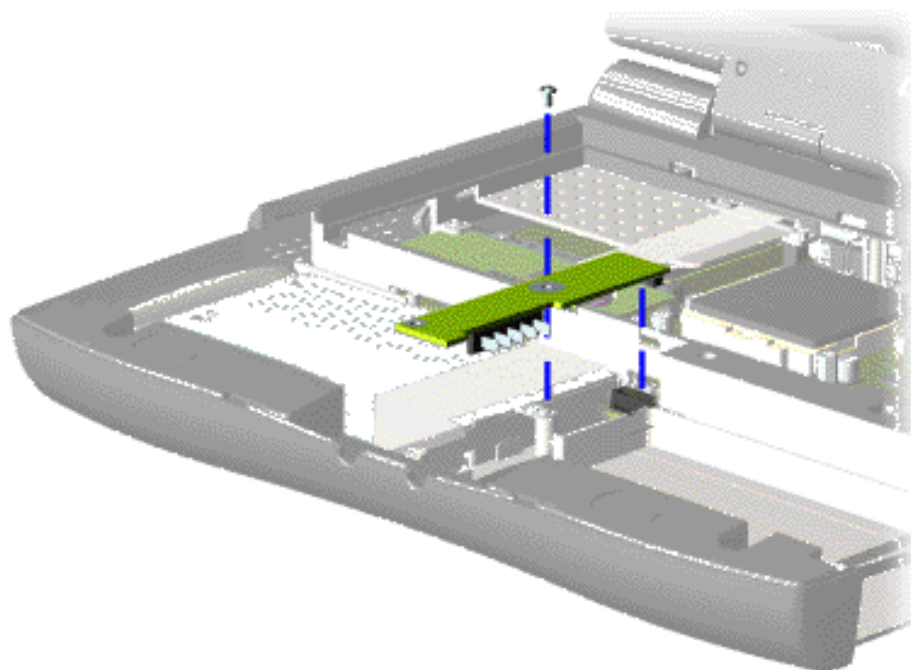

To remove the battery charger board, complete the following steps:

1. Prepare the [computer for disassembly](#).
2. Remove the [palmrest cover with touch pad](#).
3. Remove the [heatspreader](#).
4. Remove the [keyboard](#).
6. Remove the [hard drive](#).
7. Remove one screw from the battery charger board, unplug the board from the connector on the system board,

[Electrostatic Discharge](#)

[Service Considerations](#)

[Cables and Connectors](#)

[Preparing the Computer for Disassembly](#)

[Battery Pack](#)

[Palmrest Cover with Touch Pad](#)

[Heatspreader](#)

[Keyboard](#)

[Processor](#)

[Hard Drives](#)

[CD Drive](#)

[Battery Charger Board](#)

[Modem](#)

[Display Panel
Assembly](#)

[Upper CPU
Cover](#)

[Speaker
Assembly](#)

[Diskette Drive](#)

[Fan Assembly](#)

[System Board](#)

[Dip Switch
Settings](#)

[Memory
Module](#)

and lift out of the chassis.

To replace the battery charger board, reverse the previous procedures.

NOTE:

When replacing the battery charger board, ensure the pins are aligned with the connector on the system board.

1.800.AT.COMPAQ

[privacy and legal statement](#)

COMPAQ

[STORE](#) | [PRODUCTS](#) | [SERVICES](#) | [SUPPORT](#) | [CONTACT US](#) | [SEARCH](#)

Maintenance & Service Guide

Presario 1200 Series

Models: 1255, 1257, 1260, 1262, 1266, and 1267

[Home Page](#) | [Notice](#) | [Preface](#) | [Product Description](#) | [Troubleshooting](#)
[Illustrated Parts Catalog](#) | [Removal & Replacement Procedures](#) | [Specifications](#)
[Pin Assignments](#) | [Battery Pack Operations](#)

Removing the Modem

[Electrostatic Discharge](#)

[Service Considerations](#)

[Cables and Connectors](#)

[Preparing the Computer for Disassembly](#)

[Battery Pack](#)

[Palmrest Cover with Touch Pad](#)

[Heatspreader](#)

[Keyboard](#)

[Processor](#)

[Hard Drives](#)

[CD Drive](#)

[Battery Charger Board](#)

Modem

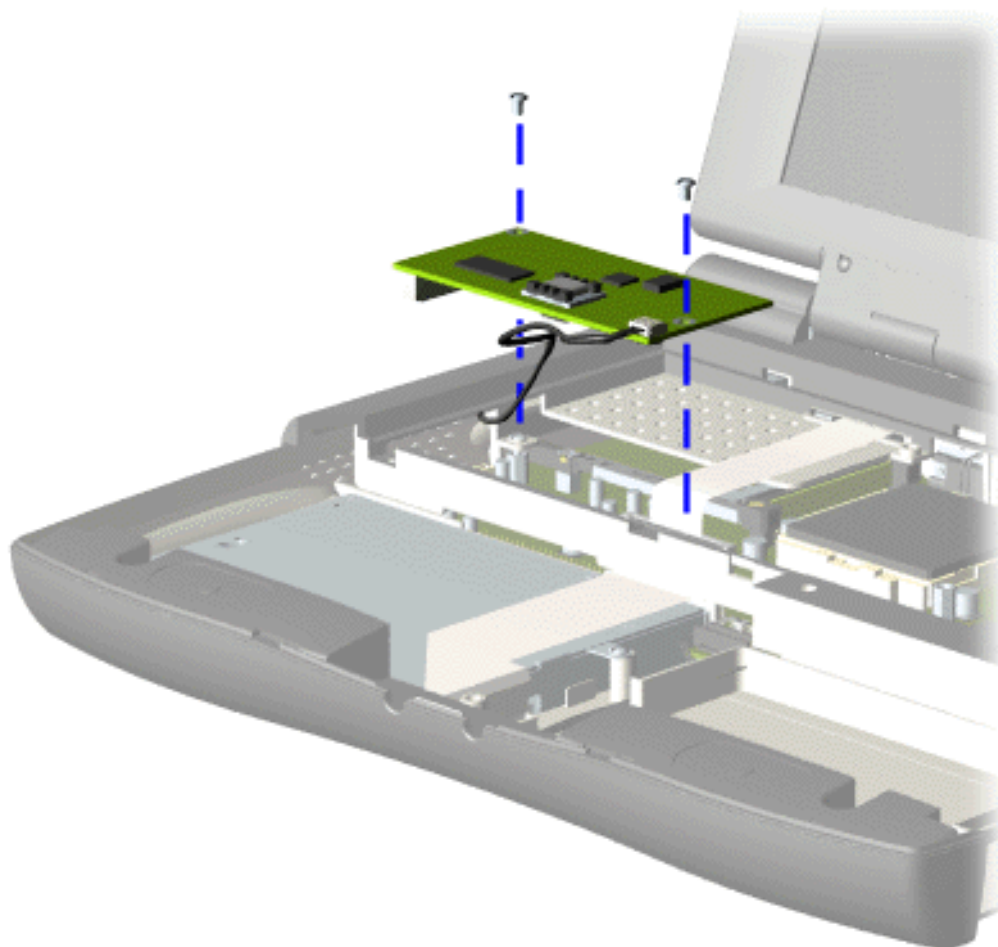

To remove the modem, complete the following steps:

1. Prepare the [computer for disassembly](#).
2. Remove the [palmrest cover with touch pad](#).
3. Remove the [heatspreader](#).
4. Remove the [keyboard](#).
5. Remove two screws securing modem and pull the

[Display Panel Assembly](#)

[Upper CPU Cover](#)

[Speaker Assembly](#)

[Diskette Drive](#)

[Fan Assembly](#)

[System Board](#)

[Dip Switch Settings](#)

[Memory Module](#)

modem off the connector on the system board.

[Next Step](#)

1.800.AT.COMPAQ

[privacy and legal statement](#)

COMPAQ

[STORE](#) | [PRODUCTS](#) | [SERVICES](#) | [SUPPORT](#) | [CONTACT US](#) | [SEARCH](#)

Maintenance & Service Guide

Presario 1200 Series

Models: 1255, 1257, 1260, 1262, 1266, and 1267

| [Home Page](#) | [Notice](#) | [Preface](#) | [Product Description](#) | [Troubleshooting](#)
[Illustrated Parts Catalog](#) | [Removal & Replacement Procedures](#) | [Specifications](#)
[Pin Assignments](#) | [Battery Pack Operations](#)

Removing the Display Panel Assembly

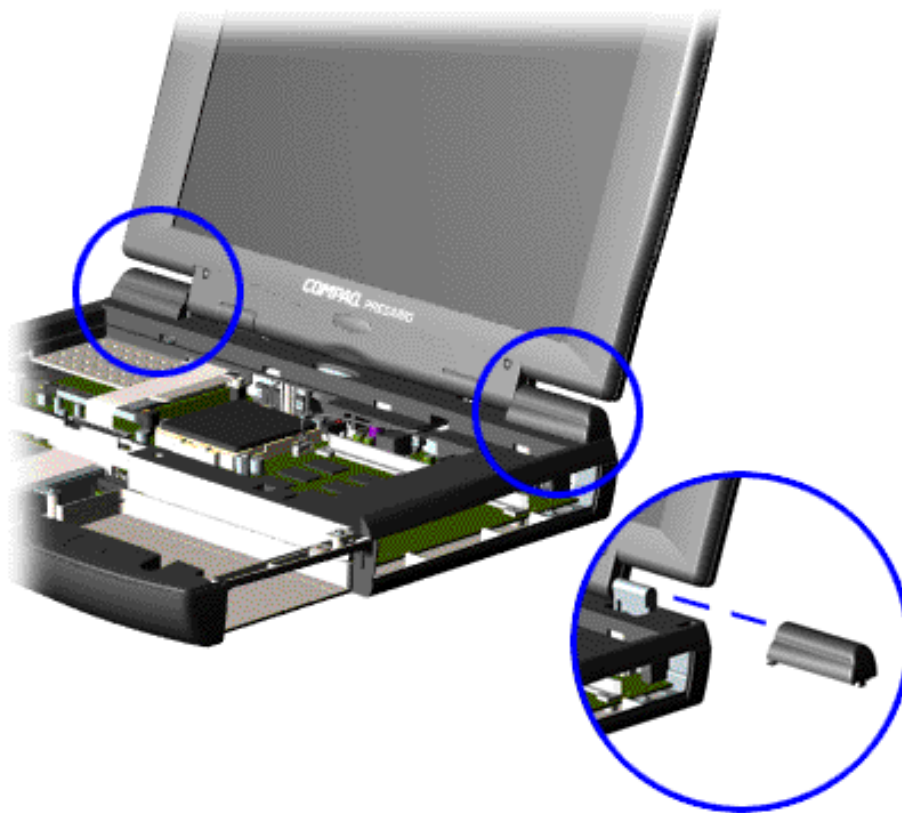
[Electrostatic Discharge](#)
[Service Considerations](#)
[Cables and Connectors](#)
[Preparing the Computer for Disassembly](#)
[Battery Pack](#)
[Palmrest Cover with Touch Pad](#)
[Heatspreader](#)
[Keyboard](#)
[Processor](#)
[Hard Drives](#)
[CD Drive](#)
[Battery Charger Board](#)
[Modem](#)
[Display Panel Assembly](#)
[Upper CPU Cover](#)
[Speaker Assembly](#)

To remove the display panel assembly, complete the following steps:

1. [Prepare the computer for disassembly.](#)
2. Remove the [palmrest cover with touch pad.](#)
3. Remove the [heatspreader.](#)
4. Remove the [keyboard.](#)
5. Remove the [modem.](#)
6. Pull up the hinge covers and lift the covers off the chassis.

IMPORTANT:

Carefully remove the display panel assembly hinge covers.

[Next Step](#)

[Diskette Drive](#)

[Fan Assembly](#)

[System Board](#)

[Dip Switch
Settings](#)

[Memory
Module](#)

[1.800.AT.COMPAQ](tel:1.800.AT.COMPAQ)

[privacy and legal statement](#)

COMPAQ

[STORE](#) | [PRODUCTS](#) | [SERVICES](#) | [SUPPORT](#) | [CONTACT US](#) | [SEARCH](#)

Maintenance & Service Guide

Presario 1200 Series

Models: 1255, 1257, 1260, 1262, 1266, and 1267

[Home Page](#) | [Notice](#) | [Preface](#) | [Product Description](#) | [Troubleshooting](#)
[Illustrated Parts Catalog](#) | [Removal & Replacement Procedures](#) | [Specifications](#)
[Pin Assignments](#) | [Battery Pack Operations](#)

Removing the Upper CPU Cover

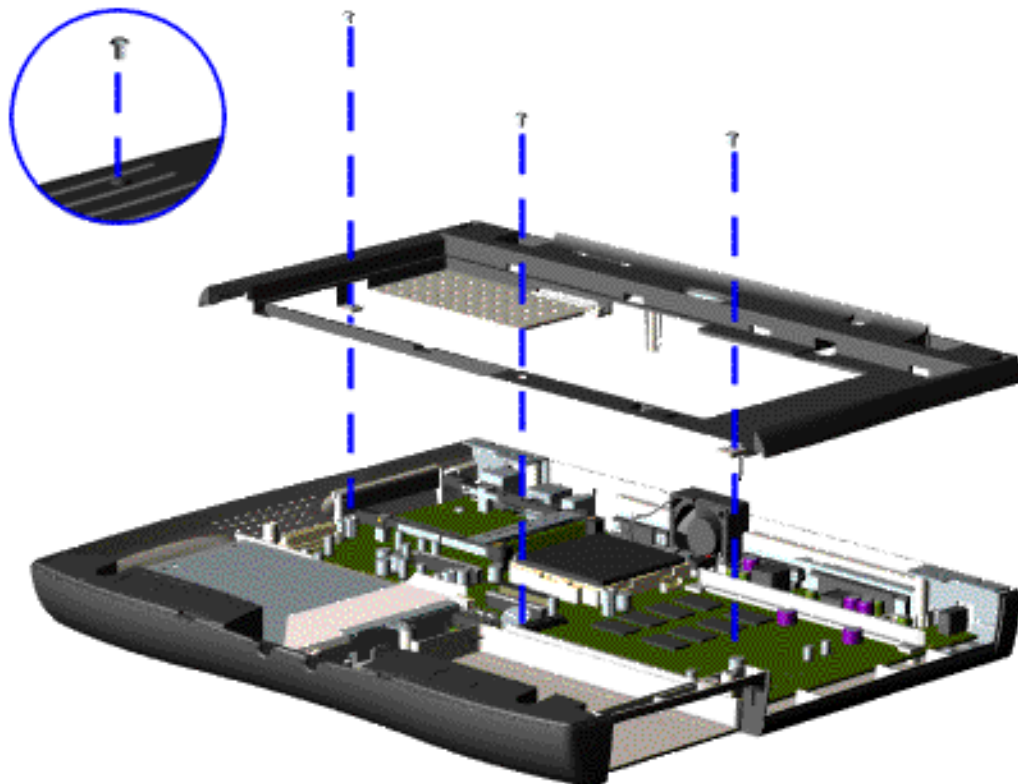

To remove the Upper CPU cover complete the following steps:

1. Prepare the [computer for disassembly](#).
2. Remove the [palmrest cover with touch pad](#).
3. Remove the [heatspreader](#).
4. Remove the [keyboard](#).
5. Remove the [hard drive](#).

[Electrostatic Discharge](#)

[Service Considerations](#)

[Cables and Connectors](#)

[Preparing the Computer for Disassembly](#)

[Battery Pack](#)

[Palmrest
Cover with
Touch Pad](#)

[Heatspreader](#)

[Keyboard](#)

[Processor](#)

[Hard Drives](#)

[CD Drive](#)

[Battery
Charger Board](#)

[Modem](#)

[Display Panel
Assembly](#)

**Upper CPU
Cover**

[Speaker
Assembly](#)

[Diskette Drive](#)

[Fan Assembly](#)

[System Board](#)

[Dip Switch
Settings](#)

[Memory
Module](#)

6. Remove the [display panel assembly](#).

7. Remove the screw located under the bottom of the unit (rear) which secures the Upper CPU cover to the chassis and remove three screws located on the top.

8. Lift the Upper CPU cover off the snaps on the chassis which will disconnect the power switch from the connector on the system board.

To replace the Upper CPU cover, reverse the previous procedures.

1.800.AT.COMPAQ

[privacy and legal statement](#)

COMPAQ

[STORE](#) | [PRODUCTS](#) | [SERVICES](#) | [SUPPORT](#) | [CONTACT US](#) | [SEARCH](#)

Maintenance & Service Guide

Presario 1200 Series

Models: 1255, 1257, 1260, 1262, 1266, and 1267

[Home Page](#) | [Notice](#) | [Preface](#) | [Product Description](#) | [Troubleshooting](#)
[Illustrated Parts Catalog](#) | [Removal & Replacement Procedures](#) | [Specifications](#)
[Pin Assignments](#) | [Battery Pack Operations](#)

Removing the Speaker Assembly

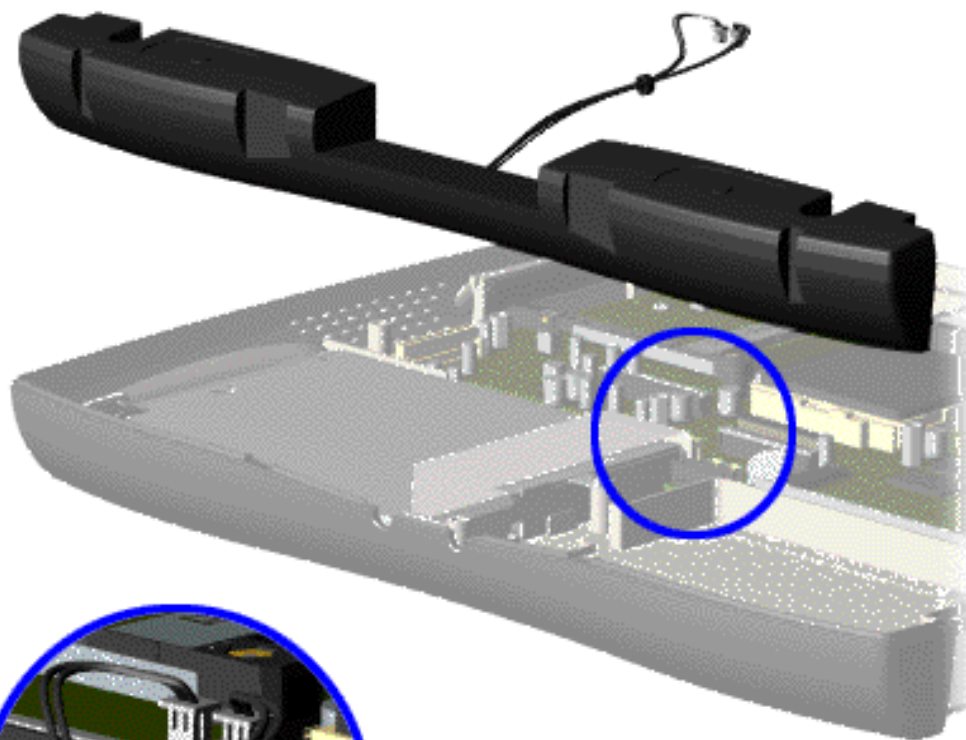

To remove the speaker assembly, complete the following steps:

1. Prepare the [computer for disassembly](#).
2. Remove the [palmrest cover with touch pad](#).
3. Remove the [heatspreader](#).
4. Remove the [keyboard](#).
5. Remove the [hard](#)

[Electrostatic Discharge](#)

[Service Considerations](#)

[Cables and Connectors](#)

[Preparing the Computer for Disassembly](#)

[Battery Pack](#)

[Palmrest Cover with Touch Pad](#)

[Heatspreader](#)

[Keyboard](#)

[Processor](#)

[Hard Drives](#)

[CD Drive](#)

[Battery
Charger Board](#)

[Modem](#)

[Display Panel
Assembly](#)

[Upper CPU
Cover](#)

**Speaker
Assembly**

[Diskette Drive](#)

[Fan Assembly](#)

[System Board](#)

[Dip Switch
Settings](#)

[Memory
Module](#)

[drive](#).

6. Remove the [display panel assembly](#).

7. Remove the [Upper CPU cover](#).

8. Remove the [charger board](#).

9. Disconnect the speaker cables from the system board and remove the speaker assembly from the chassis.

To replace the speaker assembly, reverse the previous procedures.

1.800.AT.COMPAQ

[privacy and legal statement](#)

Maintenance & Service Guide

Presario 1200 Series

Models: 1255, 1257, 1260, 1262, 1266, and 1267

| [Home Page](#) | [Notice](#) | [Preface](#) | [Product Description](#) | [Troubleshooting](#)
[Illustrated Parts Catalog](#) | [Removal & Replacement Procedures](#) | [Specifications](#)
[Pin Assignments](#) | [Battery Pack Operations](#)

Removing the Diskette Drive

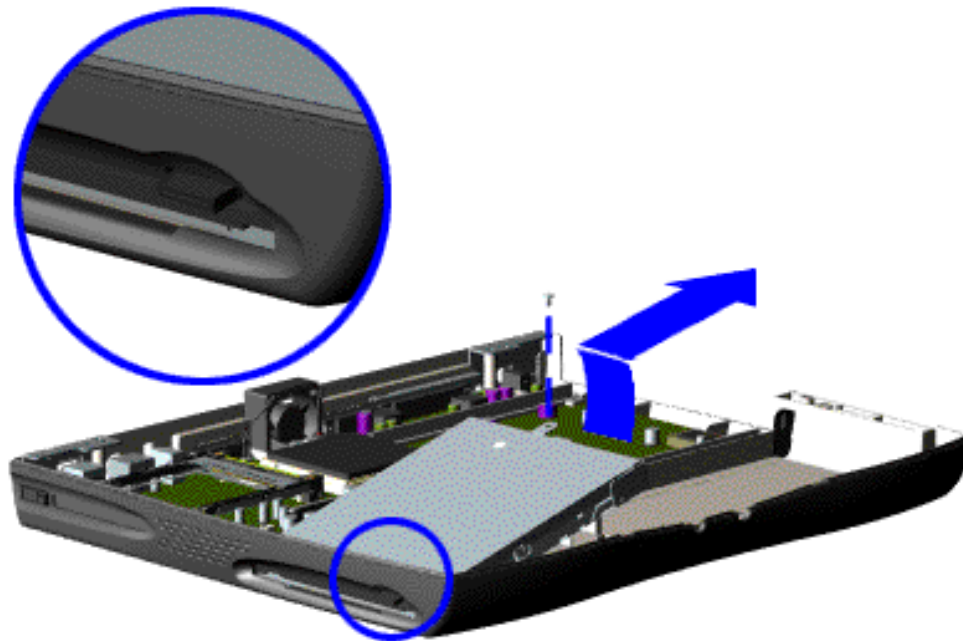

To remove the diskette drive, complete the following steps:

1. [Prepare the computer for disassembly.](#)
2. Remove the [palmrest cover with touch pad.](#)
3. Remove the [heatspreader.](#)
4. Remove the [keyboard.](#)
5. Remove the [hard drive.](#)
5. Remove the [display panel assembly.](#)
6. Remove the [Upper CPU cover.](#)

[Electrostatic Discharge](#)

[Service Consideration](#)

[Cables and Connectors](#)

[Preparing the Computer for Disassembly](#)

[Battery Pack](#)

[Palmrest Cover with Touch Pad](#)

[Heatspreader](#)

[Keyboard](#)

[Processor](#)

[Hard Drives](#)

[CD Drive](#)

[Battery
Charger
Board](#)

[Modem](#)

[Display
Panel
Assembly](#)

[Upper CPU
Cover](#)

[Speaker
Assembly](#)

**Diskette
Drive**

[Fan Assembly](#)

[System
Board](#)

[Dip Switch
Settings](#)

[Memory
Module](#)

7. Remove [battery charger board](#).

8. Remove the screw from the diskette drive and lift up the diskette drive.

[Next Step](#)

NOTE:

Ensure the diskette drive eject lever is properly inserted in the chassis slot, when replacing the diskette drive.

1.800.AT.COMPAQ

[privacy and legal statement](#)

COMPAQ

[STORE](#) | [PRODUCTS](#) | [SERVICES](#) | [SUPPORT](#) | [CONTACT US](#) |
[SEARCH](#)

Maintenance & Service Guide

Presario 1200 Series

Models: 1255, 1257, 1260, 1262, 1266, and 1267

[Home Page](#) | [Notice](#) | [Preface](#) | [Product Description](#) | [Troubleshooting](#)
[Illustrated Parts Catalog](#) | [Removal & Replacement Procedures](#) | [Specifications](#)
[Pin Assignments](#) | [Battery Pack Operations](#)

Removing the Fan Assembly

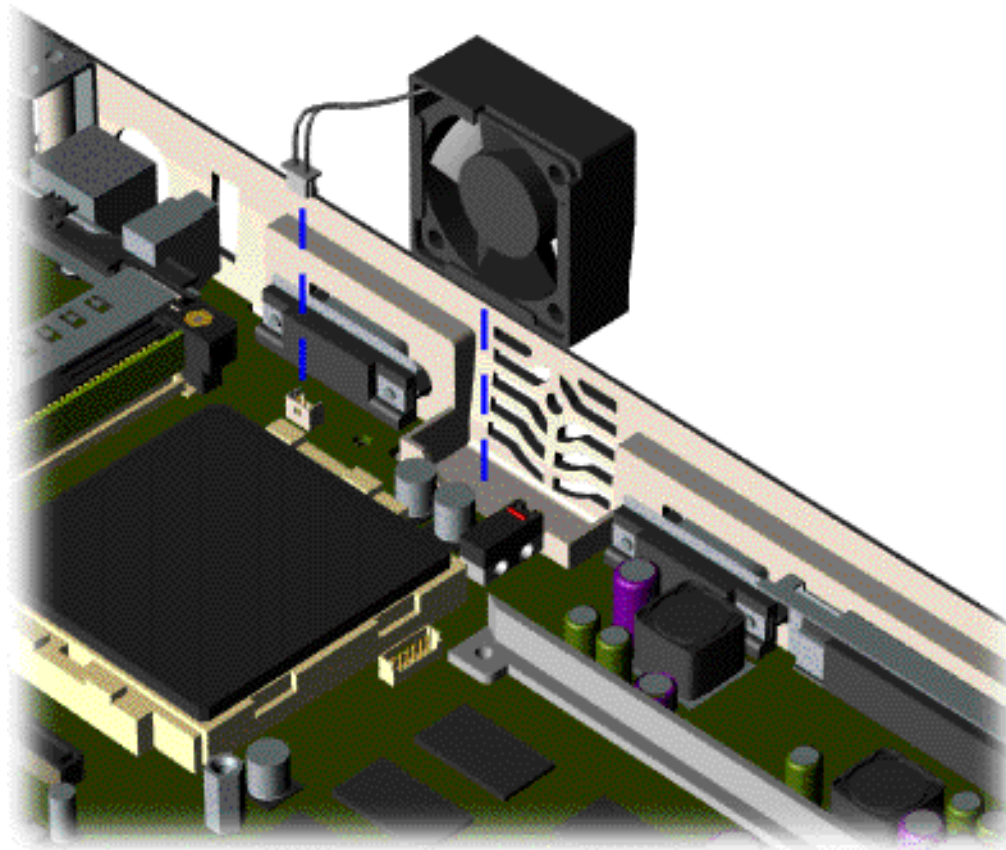
[Electrostatic Discharge](#)[Service Considerations](#)[Cables and Connectors](#)[Preparing the Computer for Disassembly](#)[Battery Pack](#)[Palmrest Cover with Touch Pad](#)[Heatspreader](#)[Keyboard](#)[Processor](#)[Hard Drives](#)[CD Drive](#)

To remove the fan assembly, complete the following steps:

1. Prepare the [computer for disassembly](#).
2. Remove the [palmrest cover with touch pad](#).
3. Remove the [heatspreader](#).
4. Remove the [keyboard](#).
5. Remove the [display panel](#).

[Battery
Charger Board](#)

[Modem](#)

[Display Panel
Assembly](#)

[Upper CPU
Cover](#)

[Speaker
Assembly](#)

[Diskette Drive](#)

[Fan Assembly](#)

[System Board](#)

[Dip Switch
Settings](#)

[Memory
Module](#)

[assembly.](#)

6. Remove the [hard drive.](#)

7. Remove the [Upper CPU cover.](#)

8. Lift the fan assembly from the chassis slot and disconnect the fan cable from the connector on the system board.

[Next Step](#)

1.800.AT.COMPAQ

[privacy and legal statement](#)

Maintenance & Service Guide

Presario 1200 Series

Models: 1255, 1257, 1260, 1262, 1266, and 1267

[Home Page](#) | [Notice](#) | [Preface](#) | [Product Description](#) | [Troubleshooting](#)
[Illustrated Parts Catalog](#) | [Removal & Replacement Procedures](#) | [Specifications](#)
[Pin Assignments](#) | [Battery Pack Operations](#)

Removing the System Board

[Electrostatic
Discharge](#)

[Service
Considerations](#)

[Cables and
Connectors](#)

[Preparing the
Computer for
Disassembly](#)

[Battery Pack](#)

[Palmrest Cover
with Touch Pad](#)

[Heatspreader](#)

[Keyboard](#)

[Processor](#)

[Hard Drives](#)

[CD Drive](#)

[Battery
Charger Board](#)

[Modem](#)

To remove the system board, complete the following steps:

1. Prepare the [computer for disassembly](#).
2. Remove the [palmrest cover with touch pad](#).
3. Remove the [heatspreader](#).
4. Remove the [keyboard](#).
5. Remove the [processor](#).
6. Remove the [modem](#).
7. Remove the [hard drive](#).
8. Remove the [display panel assembly](#).
9. Remove the [Upper CPU Cover](#).

[Display Panel Assembly](#)

[Upper CPU Cover](#)

[Speaker Assembly](#)

[Diskette Drive](#)

[Fan Assembly](#)

[System Board](#)

[Dip Switch Settings](#)

[Memory Module](#)

10. Remove the [battery charger board](#).

11. Remove the [diskette drive](#).

12. Remove the [CD drive](#).

13. Remove the [fan](#).

14. Disconnect the [speaker assembly cables](#).

[Next Step](#)

1.800.AT.COMPAQ

[privacy and legal statement](#)

Maintenance & Service Guide

Presario 1200 Series

Models: 1255, 1257, 1260, 1262, 1266, and 1267

| [Home Page](#) | [Notice](#) | [Preface](#) | [Product Description](#) | [Troubleshooting](#)
[Illustrated Parts Catalog](#) | [Removal & Replacement Procedures](#) | [Specifications](#)
[Pin Assignments](#) | [Battery Pack Operations](#)



CAUTION: When replacing the system board, ensure the dip switch voltage settings on the system board are correct for the computer model and processor voltage marked on the processor chip. If the system board dip switch voltage settings are not correct, damage may occur to the computer and/or system board.

Note: The **black area on the dip switch** indicates the position of the switch.

For Models 1255, 1260, 1262, 1266, 1267:

AMD 333 MHz, 2.2V

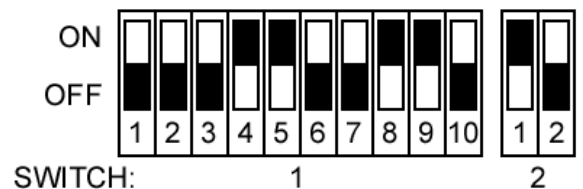

For Model 1257:

AMD 266 MHz, 2.2V

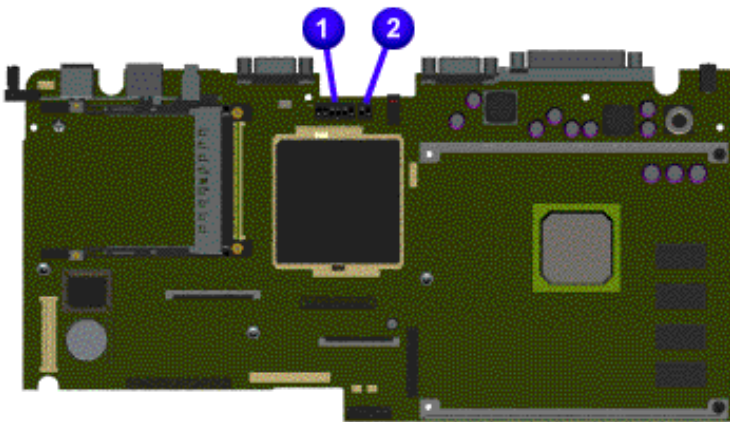
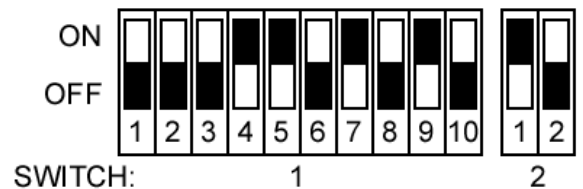

[Return to Removal & Replacement Procedures](#)

1.800.AT.COMPAQ

[privacy and legal statement](#)

COMPAQ

[STORE](#) | [PRODUCTS](#) | [SERVICES](#) | [SUPPORT](#) | [CONTACT US](#) | [SEARCH](#)

Maintenance & Service Guide

Presario 1200 Series

Models: 1255, 1257, 1260, 1262, 1266, and 1267

[Home Page](#) | [Notice](#) | [Preface](#) | [Product Description](#) | [Troubleshooting Illustrated Parts Catalog](#) | [Removal & Replacement Procedures](#) | [Specifications Pin Assignments](#) | [Battery Pack Operations](#)

Removing the Memory Module

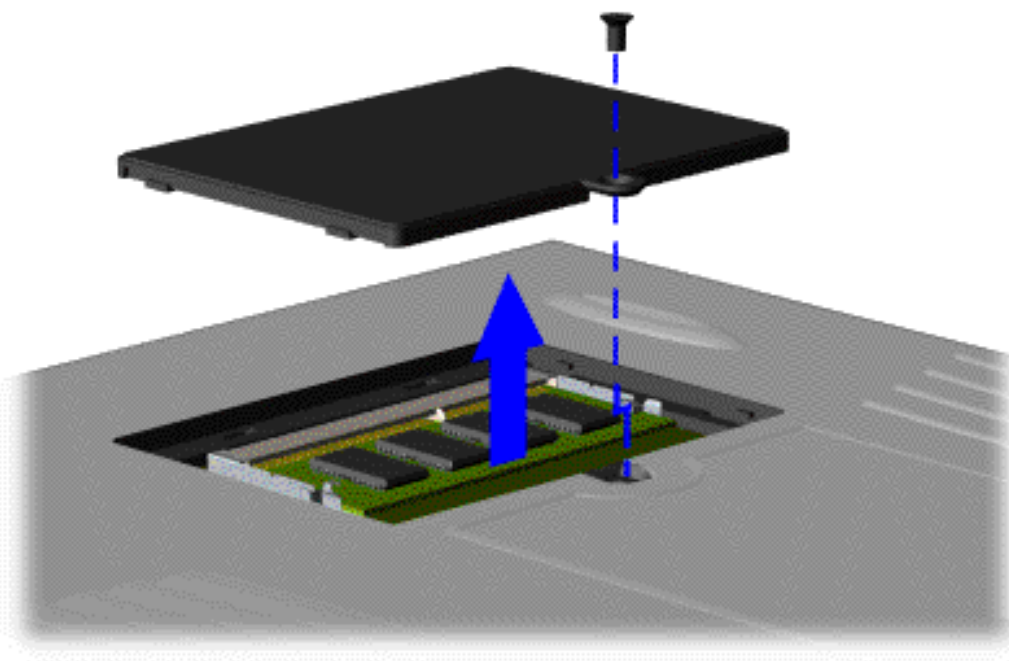
[Electrostatic Discharge](#)[Service Considerations](#)[Cables and Connectors](#)[Preparing the Computer for Disassembly](#)[Battery Pack](#)[Palmrest Cover with Touch Pad](#)[Heatspreader](#)[Keyboard](#)[Processor](#)[Hard Drives](#)[CD Drive](#)[Battery Charger Board](#)[Modem](#)

To remove the memory module, complete the following steps:

1. Prepare the [computer for disassembly](#).
2. Close the computer and turn the computer upside down.
3. Remove the screw from the memory module

[Display Panel
Assembly](#)

[Upper CPU
Cover](#)

[Speaker
Assembly](#)

[Diskette Drive](#)

[Fan Assembly](#)

[System Board](#)

[Dip Switch
Settings](#)

**Memory
Module**

door, and
slide the
memory
module
door to the
right.

[Next Step](#)

1.800.AT.COMPAQ

[privacy and legal statement](#)

COMPAQ

[STORE](#) | [PRODUCTS](#) | [SERVICES](#) | [SUPPORT](#) | [CONTACT US](#) | [SEARCH](#)

Maintenance & Service Guide

Presario 1200 Series

Models: 1255, 1257, 1260, 1262, 1266, and 1267

[Home Page](#) | [Notice](#) | [Preface](#) | [Product Description](#) | [Troubleshooting](#)
[Illustrated Parts Catalog](#) | [Removal & Replacement Procedures](#) | [Specifications](#)
[Pin Assignments](#) | [Battery Pack Operations](#)

Specifications

System Interrupts

System Interrupts	
Hardware IRQ	System Function
IRQ0	Timer Interrupt
IRQ1	Standard 101/102-Key or Microsoft Natural Keyboard
IRQ2	Programmable interrupt controller
IRQ3	Compaq Presario 56K-DF
IRQ4	Communications Port (COM1)
IRQ5	ES1869 Plug and Play AudioDrive
IRQ6	Standard Floppy Disk Controller
IRQ7	Printer Port (LPT1)
IRQ8	System CMOS/real time clock
IRQ9	(free)
IRQ10	OPTi 82C861 PCI to USB Open Host Controller
IRQ10	IRQ Holder for PCI Steering
IRQ11	IRQ Holder for PCI Steering
IRQ11	IRQ Holder for PCI Steering
IRQ11	NeoMagic MagicGraph 128XD
IRQ11	Texas Instruments PCI-1131 CardBus Controller
IRQ11	Texas Instruments PCI-1131 CardBus Controller
IRQ12	Synaptics PS/2 TouchPad
IRQ13	Numeric data processor
IRQ14	Primary IDE controller (dual fifo)

IRQ14	Opti Viper Max Dual PCI IDE Controller
IRQ15	Secondary IDE controller (dual fifo)
IRQ15	Opti Viper Max Dual PCI IDE Controller

Return to the index list of [Specifications](#).

Compaq Home	Search	Products	Service	Worldwide	Compaq.com
-----------------------------	------------------------	--------------------------	-------------------------	---------------------------	----------------------------

[Comments?](#)

[Legal Notices and Privacy Statement](#)

Revised: 25 February 1999

COMPAQ

[STORE](#) | [PRODUCTS](#) | [SERVICES](#) | [SUPPORT](#) | [CONTACT US](#) | [SEARCH](#)

Maintenance & Service Guide

Presario 1200 Series

Models: 1255, 1257, 1260, 1262, 1266, and 1267

[Home Page](#) | [Notice](#) | [Preface](#) | [Product Description](#) | [Troubleshooting](#)
[Illustrated Parts Catalog](#) | [Removal & Replacement Procedures](#) | [Specifications](#)
[Pin Assignments](#) | [Battery Pack Operations](#)

Specifications

System DMA

System DMA	
Hardware DMA	System Function
0	ES1869 Plug and Play AudioDrive
1	ES1869 Plug and Play AudioDrive
2	Standard Floppy Disk Controller
3	(free)
4	Direct memory access controller
5	(free)
6	(free)
7	(free)

Return to the index list of [Specifications](#).

Compaq Home	Search	Products	Service	Worldwide	Compaq.com
-----------------------------	------------------------	--------------------------	-------------------------	---------------------------	----------------------------

[Comments?](#)

[Legal Notices and Privacy Statement](#)

Revised: 25 February 1999

COMPAQ

[STORE](#) | [PRODUCTS](#) | [SERVICES](#) | [SUPPORT](#) | [CONTACT US](#) | [SEARCH](#)

Maintenance & Service Guide

Presario 1200 Series

Models: 1255, 1257, 1260, 1262, 1266, and 1267

[Home Page](#) | [Notice](#) | [Preface](#) | [Product Description](#) | [Troubleshooting](#)
[Illustrated Parts Catalog](#) | [Removal & Replacement Procedures](#) | [Specifications](#)
[Pin Assignments](#) | [Battery Pack Operations](#)

Specifications

System I/O Address

System I/O Address	
I/O Address (Hex)	System Function (Shipping Configuration)
x0000 - x000F	Direct memory access controller
x0020 - x0021	Programmable interrupt controller
x0022 - x0024	Motherboard resources
x0040 - x0043	System timer
x0060 - x0060	Standard 101/102-Key or Microsoft Natural Keyboard
x0061 - x0061	System speaker
x0064 - x0064	Standard 101/102-Key or Microsoft Natural Keyboard
x0070 - x0071	System CMOS/real time clock
x0080 - x0080	Motherboard resources
x0081 - x008F	Direct memory access controller
x0092 - x0092	Motherboard resources
x00A0 - x00A1	Programmable interrupt controller
x00C0 - x00DF	Direct memory access controller
x00EC - x00EF	Motherboard resources
x00F0 - x00FF	Numeric data processor
x0170 - x0177	Opti Viper Max Dual PCI IDE Controller
x0170 - x0177	Secondary IDE controller (dual fifo)

x01F0 - x01F7	Opti Viper Max Dual PCI IDE Controller
---------------	--

x01F0 - x01F7	Primary IDE controller (dual fifo)
x0220 - x022F	ES1869 Plug and Play AudioDrive
x02F8 - x02FF	Compaq Presario 56K-DF
x0330 - x0331	ES1869 Plug and Play AudioDrive
x0370 - x0371	Motherboard resources
x0376 - x0376	Opti Viper Max Dual PCI IDE Controller
x0376 - x0376	Secondary IDE controller (dual fifo)
x0378 - x037F	Printer Port (LPT1)
x0388 - x038B	ES1869 Plug and Play AudioDrive
x03B0 - x03BB	NeoMagic MagicGraph 128XD
x03C0 - x03DF	NeoMagic MagicGraph 128XD
x03F0 - x03F5	Standard Floppy Disk Controller
x03F6 - x03F6	Opti Viper Max Dual PCI IDE Controller
x03F6 - x03F6	Primary IDE controller (dual fifo)
x03F7 - x03F7	Standard Floppy Disk Controller
x03F8 - x03FF	Communications Port (COM1)
x040B - x040B	Motherboard resources
x0480 - x048F	Motherboard resources
x04D6 - x04D6	Motherboard resources

Return to the index list of [Specifications](#).

Compaq Home	Search	Products	Service	Worldwide	Compaq.com
-----------------------------	------------------------	--------------------------	-------------------------	---------------------------	----------------------------

[Comments?](#)

[Legal Notices and Privacy Statement](#)

Revised: 25 February 1999

COMPAQ

[STORE](#) | [PRODUCTS](#) | [SERVICES](#) | [SUPPORT](#) | [CONTACT US](#) | [SEARCH](#)

Maintenance & Service Guide

Presario 1200 Series

Models: 1255, 1257, 1260, 1262, 1266, and 1267

[Home Page](#) | [Notice](#) | [Preface](#) | [Product Description](#) | [Troubleshooting](#)
[Illustrated Parts Catalog](#) | [Removal & Replacement Procedures](#) | [Specifications](#)
[Pin Assignments](#) | [Battery Pack Operations](#)

Specifications

System Memory Catalog

System Memory Catalog	
Memory Address	System Function
x00000000 - x0009FFFF	System board extension for PnP BIOS
x000A0000 - x000AFFFF	NeoMagic MagicGraph 128XD
x000B0000 - x000BFFFF	NeoMagic MagicGraph 128XD
x000C0000 - x000CBFFF	NeoMagic MagicGraph 128XD
x000E0000 - x000FFFFF	System board extension for PnP BIOS
x00100000 - x01FFFFFFF	System board extension for PnP BIOS
x03000000 - x03000FFF	Texas Instruments PCI-1131 CardBus Controller
x03001000 - x03001FFF	Texas Instruments PCI-1131 CardBus Controller
xFD000000 - xFDFFFFFFF	NeoMagic MagicGraph 128XD
xFEA00000 - xFEBFFFFF	NeoMagic MagicGraph 128XD
xFECFF000 - xFECFFFFF	OPTi 82C861 PCI to USB Open Host Controller
xFED00000 - xFEDFFFFF	NeoMagic MagicGraph 128XD
xFFFC0000 - xFFFFFFF	Motherboard resources

Return to the index list of [Specifications](#).

Compaq Home	Search	Products	Service	Worldwide	Compaq.com
-----------------------------	------------------------	--------------------------	-------------------------	---------------------------	----------------------------

[Comments?](#)

[Legal Notices and Privacy Statement](#)

Revised: 25 February 1999

COMPAQ

[STORE](#) | [PRODUCTS](#) | [SERVICES](#) | [SUPPORT](#) | [CONTACT US](#) | [SEARCH](#)

Maintenance & Service Guide

Presario 1200 Series

Models: 1255, 1257, 1260, 1262, 1266, and 1267

[Home Page](#) | [Notice](#) | [Preface](#) | [Product Description](#) | [Troubleshooting](#)
[Illustrated Parts Catalog](#) | [Removal & Replacement Procedures](#) | [Specifications](#)
[Pin Assignments](#) | [Battery Pack Operations](#)

Specifications

Display

12.1" (Diagonal) TFT Display		
	U.S.	Metric
Active Area		
Height	9.6"	246 mm
Width	7.2"	184.5 mm
Overall Dimensions		
Width	7.35"	188.5 mm
Height	10.7"	275 mm
Depth	.27"	6.8 mm
Weight	16.24 oz.	464 g
Contrast Ratio	40:1	40:1
Brightness	70 nits. Avg.	70 nits. Avg.
Total Power Consumption	3.5 - 4.0 W (max)	3.5 - 4.0 W (max)

12.1" (Diagonal) HPA Display		
	U.S.	Metric

Active Area Height	9.56"	245 mm
Width	7.17"	183.8 mm
Overall Dimensions Width Height Depth	7.9" 10.7" .31"	202.5 mm 275.0 mm 8.0 mm
Weight	18.2 oz.	520 g
Contrast Ratio	40:1	40:1
Brightness	70 nits. Avg.	70 nits. Avg.
Total Power Consumption	4.0 - 4.5 W (max)	4.0 - 4.5 W (max)

Return to the index list of [Specifications](#).

Compaq Home	Search	Products	Service	Worldwide	Compaq.com
-----------------------------	------------------------	--------------------------	-------------------------	---------------------------	----------------------------

[Comments?](#)

[Legal Notices and Privacy Statement](#)

Revised: 25 February 1999

COMPAQ

[STORE](#) | [PRODUCTS](#) | [SERVICES](#) | [SUPPORT](#) | [CONTACT US](#) | [SEARCH](#)

Maintenance & Service Guide

Presario 1200 Series

Models: 1255, 1257, 1260, 1262, 1266, and 1267

[Home Page](#) | [Notice](#) | [Preface](#) | [Product Description](#) | [Troubleshooting](#)
[Illustrated Parts Catalog](#) | [Removal & Replacement Procedures](#) | [Specifications](#)
[Pin Assignments](#) | [Battery Pack Operations](#)

Specifications

Memory Expansion

Memory Expansion		
System Memory	Expansion Board Memory	Total Memory
32-MB	16-MB	48-MB
32-MB	32-MB	64-MB
32-MB	64-MB	96-MB

Return to the index list of [Specifications](#).

[Compaq Home](#)
[Search](#)
[Products](#)
[Service](#)
[Worldwide](#)
[Compaq.com](#)
[Comments?](#)
[Legal Notices and Privacy Statement](#)

Revised: 25 February 1999

COMPAQ

[STORE](#) | [PRODUCTS](#) | [SERVICES](#) | [SUPPORT](#) | [CONTACT US](#) | [SEARCH](#)

Maintenance & Service Guide

Presario 1200 Series

Models: 1255, 1257, 1260, 1262, 1266, and 1267

[Home Page](#) | [Notice](#) | [Preface](#) | [Product Description](#) | [Troubleshooting](#)
[Illustrated Parts Catalog](#) | [Removal & Replacement Procedures](#) | [Specifications](#)
[Pin Assignments](#) | [Battery Pack Operations](#)

Specifications

Battery Pack

Battery Pack		
	Nickel Metal Hydride (NiMH)	Lithium Ion (Li ion) *
Dimensions Height Length Width	0.8 in (20.3 mm) 5.7 in (145 mm) 3.1 in (78.7 mm)	0.8 in (20.3 mm) 5.7 in (145 mm) 3.1 in (78.7 mm)
Weight	1.01 lb (458.1 g)	0.90 lb (408.2 g)
Battery Pack Operating Time	2:30 hr	3:00 hr
Energy Nominal Open Circuit Voltage Capacity Power	9.6 V 3200mAH 40 W	14.4 V 2500mAH 40 W
Environmental Requirements Operating Temperature Non-operating Temperature Charging Temperature	32° F (0-50° C) -20° C -60° C 5° C-45° C	32° F (0-50° C) -20° C -60° C 5° C-45° C

1.800.AT.COMPAQ

[privacy and legal statement](#)

COMPAQ

[STORE](#) | [PRODUCTS](#) | [SERVICES](#) | [SUPPORT](#) | [CONTACT US](#) | [SEARCH](#)

Maintenance & Service Guide

Presario 1200 Series

Models: 1255, 1257, 1260, 1262, 1266, and 1267

[Home Page](#) | [Notice](#) | [Preface](#) | [Product Description](#) | [Troubleshooting](#)
[Illustrated Parts Catalog](#) | [Removal & Replacement Procedures](#) | [Specifications](#)
[Pin Assignments](#) | [Battery Pack Operations](#)

Specifications

Diskette Drive

Diskette Drive	
Capacity per Diskette (High/Low)	1,474 KB / 738 KB
Diskette Size	2HD / 2DD
Number of LED Indicators (Read/Write)	NONE
Number of Drives Supported	ONE
Drive Rotation (rpm)	300
Transfer Rate (Kbps)	500 / 250
Bytes per Sector	512
Sectors per Track (High/Low)	18 / 9
Tracks per Disk (High/Low)	160
Access Times:	
Track-to-Track (ms)	3
Average (ms)	94
Setting Time (ms)	15 (Max)
Latency Average (ms)	100
Cylinders (High/Low)	80
Number of Read/Write Heads	2

Return to the index list of [Specifications](#).

Compaq Home	Search	Products	Service	Worldwide	Compaq.com
-----------------------------	------------------------	--------------------------	-------------------------	---------------------------	----------------------------

[Comments?](#)

[Legal Notices and Privacy Statement](#)

Revised: 25 February 1999

COMPAQ

[STORE](#) | [PRODUCTS](#) | [SERVICES](#) | [SUPPORT](#) | [CONTACT US](#) | [SEARCH](#)

Maintenance & Service Guide

Presario 1200 Series

Models: 1255, 1257, 1260, 1262, 1266, and 1267

[Home Page](#) | [Notice](#) | [Preface](#) | [Product Description](#) | [Troubleshooting](#)
[Illustrated Parts Catalog](#) | [Removal & Replacement Procedures](#) | [Specifications](#)
[Pin Assignments](#) | [Battery Pack Operations](#)

Specifications

Hard Drives

Hard Drives		
	3.2-GB	4.0-GB
Capacity Per Drive (Formatted)	3.2 GB	4.0 GB
Drive Type	2.5"	2.5"
Logical Configuration		
Cylinders	7470	6568
Heads	4	6
Sectors per track	---	--
Bytes per sector	512	512
Seek Times (Typical, Including settling in ms)		
Single track	12	12
Average Full stroke	---	---
Transfer Rate		
At interface	33.3 MB/S	33.3 MB/S

Hard Drives		
	5.0-GB	6.4-GB
Capacity Per Drive	5.02 GB	6.49 GB
Drive Type	2.5"	2.5"
Logical Configuration		
Cylinders	7470	8955
Heads	6	6
Sectors per track	---	---
Bytes per sector	512	512
Seek Times (Typical, Including settling in ms)		
Single track	---	---
Average	12	12
Full stroke	---	---
Transfer Rate At interface	33.3 MB/S	33.3 MB/S

Return to the index list of [Specifications](#).

Compaq Home	Search	Products	Service	Worldwide	Compaq.com
-----------------------------	------------------------	--------------------------	-------------------------	---------------------------	----------------------------

[Comments?](#)

[Legal Notices and Privacy Statement](#)

Revised: 25 February 1999

COMPAQ

[STORE](#) | [PRODUCTS](#) | [SERVICES](#) | [SUPPORT](#) | [CONTACT US](#) | [SEARCH](#)

Maintenance & Service Guide

Presario 1200 Series

Models: 1255, 1257, 1260, 1262, 1266, and 1267

| [Home Page](#) | [Notice](#) | [Preface](#) | [Product Description](#) | [Troubleshooting](#)
[Illustrated Parts Catalog](#) | [Removal & Replacement Procedures](#) | [Specifications](#)
[Pin Assignments](#) | [Battery Pack Operations](#)

Specifications

CD Drive

24 x CD Drive	
Dimensions	128 x 12.7 x 129 mm
Weight	0.5 Lbs
Rotational Speed	5120 rpm
Typical Transfer Rate Sustained Data Transfer Rate	3600 KB/s
Access Time Average Random Access Time	110 ms
Spin Up time	2.7 s
Data Buffer Capacity	128 KB

Return to the index list of [Specifications](#).

[Compaq Home](#)[Search](#)[Products](#)[Service](#)[Worldwide](#)[Compaq.com](#)

[Comments?](#)

[Legal Notices and Privacy Statement](#)

Revised: 25 February 1999

Free Manuals Download Website

<http://myh66.com>

<http://usermanuals.us>

<http://www.somanuals.com>

<http://www.4manuals.cc>

<http://www.manual-lib.com>

<http://www.404manual.com>

<http://www.luxmanual.com>

<http://aubethermostatmanual.com>

Golf course search by state

<http://golfingnear.com>

Email search by domain

<http://emailbydomain.com>

Auto manuals search

<http://auto.somanuals.com>

TV manuals search

<http://tv.somanuals.com>