

Maintenance & Service Guide

Presario 1600 Series Portable Computers

[Notice](#)

[Preface](#)

[Product
Description](#)

[Troubleshooting](#)

[Illustrated
Parts Catalog](#)

[Removal &
Repair
Procedures](#)

[Specifications](#)

[Connector Pin
Assignments](#)

[Battery Pack](#)



Welcome to the Presario 1600 Series Portable Computer Maintenance & Service Guide. This online guide is designed to serve the needs of those whose job it is to repair Compaq products. Many of the components of the hardcopy MSG are contained in this online guide. The [Notice](#), contains the copyright and trademark information. The [Preface](#) shows symbol conventions and Technician Notes.

This MSG will be periodically maintained and updated online as needed.

Maintenance & Service Guide

Presario 1600 Series Portable Computers

[Notice](#) | [Preface](#) | [Home](#) | [Product Description](#) | [Troubleshooting](#) | [Illustrated Parts Catalog](#)
[Removal & Replacement Procedures](#) | [Specifications](#) | [Connector Pin Assignments](#) | [Battery Pack](#)

Notice

The information in this guide is subject to change without notice.

COMPAQ COMPUTER CORPORATION SHALL NOT BE LIABLE FOR TECHNICAL OR EDITORIAL ERRORS OR OMISSIONS CONTAINED HEREIN, NOR FOR INCIDENTAL OR CONSEQUENTIAL DAMAGES RESULTING FROM THE FURNISHING, PERFORMANCE, OR USE OF THIS MATERIAL.

This guide contains information protected by copyright. No part of this guide may be photocopied or reproduced in any form without prior written consent from Compaq Computer Corporation.

© 1998 Compaq Computer Corporation.
All rights reserved. Printed in the U.S.A.

Compaq, Presario Registered U. S. Patent and Trademark Office.

Microsoft, MS-DOS, and Windows are registered trademarks of Microsoft Corporation.

Windows 95 is a trademark of Microsoft Corporation.

The software described in this guide is furnished under a license agreement or nondisclosure agreement. The software may be used or copied only in accordance with the terms of the agreement.

Product names mentioned herein may be trademarks and/or registered trademarks of their respective companies.

Maintenance and Service Guide

Compaq Presario 1600 Series Portable Computers

First Edition (October 1997)
Spare Part Number 298499-001
Documentation Part Number 330976-001

Compaq Computer Corporation

[Home](#)

Maintenance & Service Guide

Presario 1600 Series Portable Computers

[Notice](#) | [Preface](#) | [Home](#) | [Product Description](#) | [Troubleshooting](#) | [Illustrated Parts Catalog](#)
[Removal & Replacement Procedures](#) | [Specifications](#) | [Connector Pin Assignments](#) | [Battery Pack](#)

Preface

This *Maintenance and Service Guide* is a troubleshooting guide that can be used for reference when servicing the Compaq Presario 1625/1635 Series Portable Computers.

Compaq Computer Corporation reserves the right to make changes to the Compaq Presario Series Portable Computers without notice.

Symbols

The following words and symbols mark special messages throughout this guide.



WARNING: Text set off in this manner indicates that failure to follow directions in the warning could result in bodily harm or loss of life.



CAUTION: Text set off in this manner indicates that failure to follow directions could result in damage to equipment or loss of data.

IMPORTANT:

Text set off in this manner presents clarifying information or specific instructions.

NOTE:

Text set off in this manner presents commentary, sidelights, or interesting points of information.

Technician Notes



WARNING: Only authorized technicians trained by Compaq should repair this equipment. All troubleshooting and repair procedures are detailed to allow only subassembly/module level repair. Because of the complexity of the individual boards and subassemblies, the user should not attempt to make repairs at the component level or to make modifications to any printed circuit board. Improper repairs can create a safety hazard. Any indications of component replacement or printed circuit board modifications may void any warranty.

Serial Number

When requesting information or ordering spare parts, the computer serial number should be provided to Compaq. The serial number is located on the bottom of the computer.

Locating Additional Information

The following documentation is available to support this product:

- Compaq Presario 1624/1625/1635/1636 Series Portable Computer documentation set
- *Introducing Windows 95 Guide*
- Service Training Guides
- Compaq Service Advisories and Bulletins
- *Compaq QuickFind*
- *Compaq Service Quick Reference Guide*

[Home](#)

Maintenance & Service Guide

Presario 1600 Series Portable Computers

[Notice](#) | [Preface](#) | [Home](#) | [Product Description](#) | [Troubleshooting](#) | [Illustrated Parts Catalog](#)
[Removal & Replacement Procedures](#) | [Specifications](#) | [Connector Pin Assignments](#) | [Battery Pack](#)

Product Description

[Models and Features](#)

[Rear Connectors](#)

[Port Replicator](#)

[Power Management](#)

Compaq Presario 1600 Series Portable Computers are a new generation of multimedia portable computers with an innovative integrated design, outstanding audio and video, advanced core features, and attractive styling. This full-function, Pentium-based series of portable computers allows full desktop functionality.



[Compaq Presario 1600 Series Portable Computers](#)

Maintenance & Service Guide

Presario 1600 Series Portable Computers

[Notice](#) | [Preface](#) | [Home](#) | [Product Description](#) | [Troubleshooting](#) | [Illustrated Parts Catalog](#)
[Removal & Replacement Procedures](#) | [Specifications](#) | [Connector Pin Assignments](#) | [Battery Pack](#)

Troubleshooting



WARNING: To avoid a potential shock hazard during troubleshooting procedures, disconnect all power sources before removing the keyboard cover or the display bezel.

This chapter covers troubleshooting information for the Compaq Presario Series Portable Computers. The basic steps in troubleshooting include:

1. Following the [Preliminary Steps](#).
2. Running the [Power-On Self-Test \(POST\)](#).
3. If you are unable to run POST you may [Troubleshoot Without Diagnostics](#).

Search for [Error Code](#) by number.

Perform the recommended actions in the order listed. Rerun POST after each recommended action until the problem is solved and no error message occurs. Once the problem is solved, do not complete the remaining recommended actions.

NOTE:

If the problem is intermittent, check the computer several times to verify that the problem is solved.

Maintenance & Service Guide

Presario 1600 Series Portable Computers

[Notice](#) | [Preface](#) | [Home](#) | [Product Description](#) | [Troubleshooting](#) | [Illustrated Parts Catalog](#)
[Removal & Replacement Procedures](#) | [Specifications](#) | [Connector Pin Assignments](#) | [Battery Pack](#)

Illustrated Parts Catalog

[System Unit](#)

[Boards](#)

[Display](#)

[Mass Storage Devices](#)

[Cables](#)

[Miscellaneous Hardware and Screws](#)

This chapter provides an illustrated parts breakdown and identifies the spare parts ordering number associated with each item(s) for Compaq Presario 1600 Series Portable Computers.

Maintenance & Service Guide

Presario 1600 Series Portable Computers

[Notice](#) | [Preface](#) | [Home](#) | [Product Description](#) | [Troubleshooting](#) | [Illustrated Parts Catalog](#)
[Removal & Replacement Procedures](#) | [Specifications](#) | [Connector Pin Assignments](#) | [Battery Pack](#)

Removal & Replacement Procedure

This chapter presents the removal and replacement procedures for the computer.

[ESD](#)

[Service Considerations](#)

[Cable Positions](#)

[Preparing the Computer for Disassembly](#)



[Serial Number Location](#)

Serial Number Location

Report the computer serial number to Compaq when requesting information or ordering spare parts. The serial number is displayed on the bottom of the computer.

Maintenance & Service Guide

Presario 1600 Series Portable Computers

[Notice](#) | [Preface](#) | [Home](#) | [Product Description](#) | [Troubleshooting](#) | [Illustrated Parts Catalog](#)
[Removal & Replacement Procedures](#) | [Specifications](#) | [Connector Pin Assignments](#) | [Battery Pack](#)

Specifications

This section covers the following specifications of Compaq Presario 1600 Series Portable Computers:

- [Physical and Environmental/Specifications](#)
- [System Interrupts](#)
- [System DMA](#)
- [System I/O Address](#)
- [System Memory Map](#)
- [Memory Expansion](#)
- [Diskette Drive](#)
- [Hard Drive](#)
- [CD Drive](#)
- [Battery Pack](#)
- [Dip Switch Settings](#)

Physical and Environmental/Specifications		
	U.S.	Metric
Dimensions		
Height	1.96 in	4.95 cm
Depth	12.30 in	31.00 cm
Width	10.08 in	25.40 cm
Weight		
Model 1625	7.326lb	3.33 kg
Model 1635	7.326lb	3.33 kg
Model 1640	7.326lb	3.33 kg
Stand-Alone (Battery Pack) Power Requirements		
	NiMH	Li-ion
Nominal Operating	W @ 9.6 V	W @ 14.4 V
Maximum Average	W @ 9.6 V	W @ 14.4 V
Peak Operating	W @ 9.6 V	W @ 14.4 V
AC Power Requirements		
Operating Voltage	100-240 V	
Operating Current	0.8/0.4 A RMS	
Operating Frequency	47-63 Hz	
Maximum Transient	Meets IEC 801-4 and IEC801-5 1kV for 50 ns	
Temperature		
Operating	50° to 95 °F	10° to 35 °C
Non-operating	-4° to 140 °F	-20° to 60 °C
Relative Humidity (non-condensing)		
Operating	10 to 90%	35°C to 90%
Non-operating (tw = 38.7°C max)	5 to 95%	60°C to 95%
Altitude		
Operating	0 to 10,000 ft	0 to 3.15 km
Non-operating	0 to 30,000 ft	0 to 9.14 km
Shock		
Operating	10 G, 11 ms, half sine	
Non operating	240 G, 2 ms, half sine	
Vibration		
Operating	0.5 G	
Non-operating	1.5 G	

NOTE: Applicable product safety standards specify thermal limits for plastic surfaces. Compaq Presario 1600 Series Portable Computers operate well within this range of temperatures.

[Back to top](#)

System Interrupts	
Hardware IRQ	System Function
IRQ0	Timer Interrupt
IRQ1	Keyboard
IRQ2	Interrupt Controller Cascade
IRQ3	0X2F8 Default Resources for Modem
IRQ4	Communications Port (COM 1)
IRQ5	ES1869 Plug and Play AudioDrive
IRQ6	Diskette Drive
IRQ7	Parallel Port (LPT 1) (default)
IRQ8	System CMOS/Real-Time Clock
IRQ10	IRQ Holder for PCI Steering
IRQ10	PCI-1131 CardBus Controller
IRQ11	IRQ Holder for PCI Steering
IRQ11	MagicGraph128XD
IRQ11	PCI-1131 CardBus Controller
IRQ12	PS/2 TouchPad
IRQ13	Coprocessor
IRQ14	Primary IDE Controller (dual FIFO)
IRQ14	Opti Dual PCI IDE Controller
IRQ15	Opti Dual PCI IDE Controller
IRQ15	Secondary IDE Controller (dual FIFO)

[Back to top](#)

System DMA	
Hardware DMA	System Function
DMA 0	ES1869 Plug and Play AudioDrive
DMA 1	ES1869 Plug and Play AudioDrive
DMA 2	Diskette Drive
DMA 4	Direct Memory Access Controller

[Back to top](#)

System I/O Address	
I/O Address (Hex)	System Function (Shipping Configuration)
0000h-000Fh	DMA Controller # 1
0020h-0021h	Interrupt Controller # 1
0022h-0024h	Motherboard resources
0040h-0043h	System timer
0060h-0060h	Keyboard Controller
0061h-0061h	System speaker
0064h-0064h	Standard 101/102-Key or Microsoft Natural Keyboard
0070h-0071h	System CMOS/real time clock
0080h-0080h	Motherboard resources
0081h-008Fh	DMA Controller
0092h-0092h	Motherboard resources
00A0h-00A1h	Programmable interrupt controller
00C0h-00DFh	DMA Controller
00ECh-00EFh	Motherboard resources
00F0h-00FFh	Numeric data processor
0170h-0177h	Secondary IDE controller (dual FIFO)
0170h-0177h	Opti Dual PCI IDE Controller
01F0h-01F7h	Opti Dual PCI IDE Controller
01F0h-01F7h	Primary IDE controller (dual FIFO)
0201h-0201h	Gameport Joystick
0220h-022Fh	ES1869 Plug and Play AudioDrive
0330h-0331h	ES1869 Plug and Play AudioDrive
0370h-0371h	Motherboard resources
0376h-0376h	Secondary IDE controller (dual FIFO)
0376h-0376h	Opti Dual PCI IDE Controller
0378h-037Fh	Printer Port (LPT1)
0388h-038Bh	ES1869 Plug and Play AudioDrive
03B0h-03BBh	MagicGraph128XD
03C0h-03DFh	MagicGraph128XD
03F0h-03F5h	Diskette Drive Controller
03F6h-03F6h	Primary IDE controller (dual FIFO)
03F6h-03F6h	Opti Dual PCI IDE Controller
03F7h-03F7h	Diskette Drive Controller
03F8h-03FFh	Communications Port (COM1)
040Bh-040Bh	Motherboard resources
0480h-048Fh	Motherboard resources
04D6h-04D6h	Motherboard resources
0800h-0807h	ES1869 Control Interface
0CF8h-0CFFh	PCI bus
1000h-107Fh	PCI-1131 CardBus Controller
FCF0h-FCF7h	Primary IDE controller (dual FIFO)
FCF0h-FCF7h	Opti Dual PCI IDE Controller
FCF8h-FCFFh	Secondary IDE controller (dual FIFO)
FCF8h-FCFFh	Opti Dual PCI IDE Controller

[Back to top](#)

System Memory Map	
Memory Address	System Function
00000000h-0009FFFFh	System board extension for PnP BIOS
000A0000h-000AFFFFh	MagicGraph128XD
000B0000h-000BFFFFh	MagicGraph128XD
000C0000h-000CFFFFh	MagicGraph128XD
000CC000h-000CCFFFh	PCI-1131 CardBus Controller
000CD000h-000CDFFFh	PCI-1131 CardBus Controller
000E0000h-000EFFFFh	System board extension for PnP BIOS
00100000h-017FFFFFh	System board extension for PnP BIOS
05000000h-05040FFFh	PCI-1131 CardBus Controller
FD000000h-FDFFFFFFh	MagicGraph128XD
FEA00000h-FEBFFFFFFh	MagicGraph128XD
FED00000h-FEDFFFFFFh	MagicGraph128XD
FFFC0000h-FFFFFFFh	Motherboard resources

[Back to top](#)

Memory Expansion		
System Memory	Expansion Board Memory	Total Memory
8-MB	16-MB	24-MB
8-MB	32-MB	40-MB
8-MB	64-MB	72-MB
16-MB	16-MB	32-MB
16-MB	32-MB	48-MB
16-MB	64-MB	80-MB
32-MB	16-MB	48-MB
32-MB	32-MB	64-MB
32-MB	64-MB	96-MB
64-MB	16-MB	80-MB
64-MB	32-MB	96-MB
64-MB	64-MB	128-MB*

*Run the PHDISK utility to increase the size of the hibernation file for the larger memory size.

[Back to top](#)

Maintenance & Service Guide

Presario 1600 Series Portable Computers

[Notice](#) | [Preface](#) | [Home](#) | [Product Description](#) | [Troubleshooting](#) | [Illustrated Parts Catalog](#)
[Removal & Replacement Procedures](#) | [Specifications](#) | [Connector Pin Assignments](#) | [Battery Pack](#)

Connector Pin Assignments

This section provides connector pin assignment tables for Compaq Presario 1600 Series Portable Computers and the Compaq Port Replicator for selected models. For more information on connectors, refer to [Rear Connectors](#) for connectors located on the computer and [Port Replicator](#) for connectors located on the port replicator.

NOTE: The signals in all tables of this appendix are considered active high unless otherwise indicated by an asterisk (*).

- [Parallel Connector](#)
- [Serial Connector](#)
- [Keyboard/Mouse](#)
- [External VGA Monitor](#)
- [Phone Line to Wall Jack](#)
- [Port Replicator](#)

Parallel Connector			
			
Pin	Signal	Pin	Signal
1	Strobe*	10	Acknowledge*
2	Data Bit 0	11	Busy
3	Data Bit 1	12	Paper Out
4	Data Bit 2	13	Select
5	Data Bit 3	14	Auto Linefeed*
6	Data Bit 4	15	Error*
7	Data Bit 5	16	Initialize Printer*
8	Data Bit 6	17	Select In*
9	Data Bit 7	18-25	Signal Ground
* = Active low			

[Back to top](#)

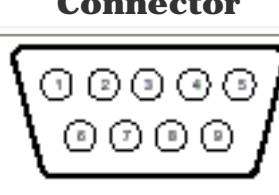
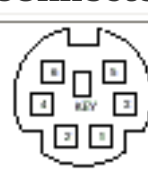
Serial Connector		
Connector	Pin	Signal
	1	Carrier Detect
	2	Receive Data
	3	Transmit Data
	4	Data Terminal Ready
	5	Signal Ground
	6	Data Set Ready
	7	Ready to Send
	8	Clear to Send
	9	Ring Indicator
Keyboard/Mouse		
Connector	Pin	Signal
	1	Data
	2	Not defined
	3	Ground
	4	+5 VDC
	5	Clock
	6	Not defined

[Back to top](#)

External VGA Monitor		
Connector	Pin	Signal
	1	Red Analog
	2	Green Analog
	3	Blue Analog
	4	Not connected
	5	Ground
	6	Ground Analog
	7	Ground Analog
	8	Ground Analog
	9	Not connected
	10	Ground
	11	Monitor Detect
	12	DDC2B Data
	13	Horizontal Sync
	14	Vertical Sync
	15	DDC2B Clock

[Back to top](#)

Phone Line to Wall Jack		
Connector	Pin	Signal
	1	Unused
	2	Unused
	3	Tip
	4	Ring
	5	Unused
	6	Unused

[Back to top](#)

Port Replicator							
Pin	Signal	Pin	Signal	Pin	Signal	Pin	Signal
1	N.C.	21	Printer Data 0	41	N.C.	61	CTS
2	N.C.	22	Printer Data 1	42	N.C.	62	DCD
3	Kb Clk 1	23	Printer Data 2	43	Switch A	63	DSR
4	Joystick Data A	24	Printer Data 3	44	Switch B	64	TXD
5	Kb Data 1	25	Printer Data 4	45	Switch C	65	RTS
6	Joystick Data B	26	Printer Data 5	46	Switch D	66	N.C.
7	Kb Clk 2	27	Printer Data 6	47	N.C.	67	Detect
8	Joystick Data C	28	Printer Data 7	48	MIDI In	68	N.C.
9	Kb Data 2	29	Reserved	49	MIDI Out	69	V. Sync
10	Joystick Data D	30	Reserved	50	+5V	70	Ground
11	Lp Select In	31	Reserved	51	+5V	71	H. Sync
12	Lp Paper End	32	Reserved	52	N.C.	72	Ground
13	Lp Initialize	33	Adapter In	53	N.C.	73	Blue
14	Lp Busy	34	Adapter In	54	N.C.	74	Ground
15	Lp Error	35	Adapter In	55	N.C.	75	Green
16	Lp Ack	36	Adapter In	56	Dock ID -	76	Ground
17	Lp Auto Feed	37	Adapter In	57	RXD	77	Red
18	Lp Strobe	38	Adapter In	58	Lp Select	78	Ground
19	DDC2BC	39	N.C.	59	RI	79	N.C.
20	DDC2BD	40	N.C.	60	DTR	80	N.C.

[Back to top](#)

Maintenance & Service Guide

Presario 1600 Series Portable Computers

[Notice](#) | [Preface](#) | [Home](#) | [Product Description](#) | [Troubleshooting](#) | [Illustrated Parts Catalog](#)
[Removal & Replacement Procedures](#) | [Specifications](#) | [Connector Pin Assignments](#) | [Battery Pack](#)

Battery Pack

This section covers the following information concerning battery pack operating time:

- [Increasing Battery Pack Operating Time](#)
- [Minimizing the Energy Required](#)
- [Maximizing the Energy Stored](#)
- [Conditioning a Battery Pack](#)
- [Battery Charge Time By Model](#)
- [Disposal of a Used Battery Pack](#)

Increasing Battery Pack Operating Time

Battery pack operating time differs depending on several variables. To avoid unnecessary replacement, consider the following variables when determining how long a charged battery pack should last:

- Power management settings
- Hardware configuration
- Software applications
- Installed options
- Display brightness
- Hard drive usage
- Changes in operating temperature
- Type and number of installed PC Cards

NOTE: The power consumption requirements for PC Cards vary widely. Some cards drain the battery pack very rapidly.

Battery pack operating time can be increased by as much as 50 percent by controlling the energy required by the computer and the energy stored in the battery pack.

Minimizing the Energy Required

To minimize the energy required by the computer, follow these steps:

- Set the power conservation levels in the Power Management utility to **Maximum**.
- Customize the timeout value to work more efficiently with the applications. The amount of battery life depends on the values selected.

Maximizing the Energy Stored

To maximize the energy stored in the battery pack, follow these guidelines:

- Condition the battery pack at least every 30 days to improve overall battery performance.
- Keep a battery pack in the computer when using it with AC power to supply the battery pack with a constant trickle charge.
- Store the battery pack in a cool, dry place when not in use.

Conditioning a Battery Pack

 **CAUTION:** To avoid a loss of data, ensure that all data is saved before discharging a battery pack.

To condition a battery pack, complete the following steps:

1. Plug in the AC adapter and allow the battery to charge until the fast charge arrow on the display disappears. Your battery gauge may read 100 percent for a period of time before the arrow disappears. Do not unplug the AC adapter until the arrow disappears.

Select Disabled in the Power menu of the BIOS Setup. The system will hibernate after one hour of being in suspend. By selecting Disabled, the system will not timeout and enter suspend.

2. Unplug the AC adapter and allow the battery to drain until the computer reaches hibernation and turns itself off. **Do not plug in the AC adapter during this process or you will need to restart with Step No. 1.** You may use the computer while the battery is draining.

3. Your battery is re-conditioned.

4. Plug in the AC adapter and begin using the computer.

This table shows battery pack charge times by model.

Battery Charge Time By Model		
Computer	On Line	Off Line
Model 1/NiMH Battery Pack	4.0 hours premature termination	2:00 hr
Model 2/Li ion Battery Pack	4.5 hours premature termination	2:50 hr

Disposal of a Used Battery Pack

In the interest of safeguarding our environment. Compaq Computer Corporation recommends that nickel metal hydride (NiMH) and lithium ion (Li ion) battery packs be recycled. Handle battery packs in accordance with country, state, province, or local regulations.

 **CAUTION:** Never attempt to open or service a battery pack. Opening a battery pack not only damages the pack and makes it unusable, but also exposes potentially harmful battery components.

Maintenance & Service Guide

Presario 1600 Series Portable Computers

[Notice](#) | [Preface](#) | [Home](#) | [Product Description](#) | [Troubleshooting](#) | [Illustrated Parts Catalog](#)
[Removal & Replacement Procedures](#) | [Specifications](#) | [Connector Pin Assignments](#) | [Battery Pack](#)

Models & Features

Models and Features

[Front Of Unit](#)

[Left Side Components](#)

[Right Side Components](#)

[Bottom Of Unit](#)

Models

This table lists the relevant features of Compaq Presario Series Portable Computers.

	Model 1625	Model 1635	Model 1640
Display	12.1"HPA	12.1" TFT	12.1" TFT
Processor AMD K6	266 MMX	233 MMX	266 MMX
Hard Drives	3.2 GB	3.2 GB	4 GB
Speaker Assembly	JBL Pro	JBL Pro	JBL Pro
Modem	K-56K D/F	M++ 56K D/F	K-56 K D/F

Features

All models of the computer have the following features:

- 1.44-MB, 3.5-inch diskette drive
- Built-in 24× CD drive
- Ported stereo speakers
- TouchPad
- Easy Access CD Control Buttons
- 91-key (Three Windows 95 keys, 12 function keys) keyboard
- External AC adapter
- PC Card slots capable of handling one of the following card combinations:
 - Two Type I or Type II PC cards
 - One Type III PC card
- Battery power management features include the following:
 - Advanced Power Management (APM)
 - Suspend mode
 - Screen save
 - Hibernation
- Password security
- Preinstalled software: Windows 95 OSR 2.5 or Windows 98

Maintenance & Service Guide

Presario 1600 Series Portable Computers

[Notice](#) | [Preface](#) | [Home](#) | [Product Description](#) | [Troubleshooting](#) | [Illustrated Parts Catalog](#)
[Removal & Replacement Procedures](#) | [Specifications](#) | [Connector Pin Assignments](#) | [Battery Pack](#)

Front of Unit

Models and Features

Front Of Unit

Left Side Components

Right Side Components

Bottom Of Unit

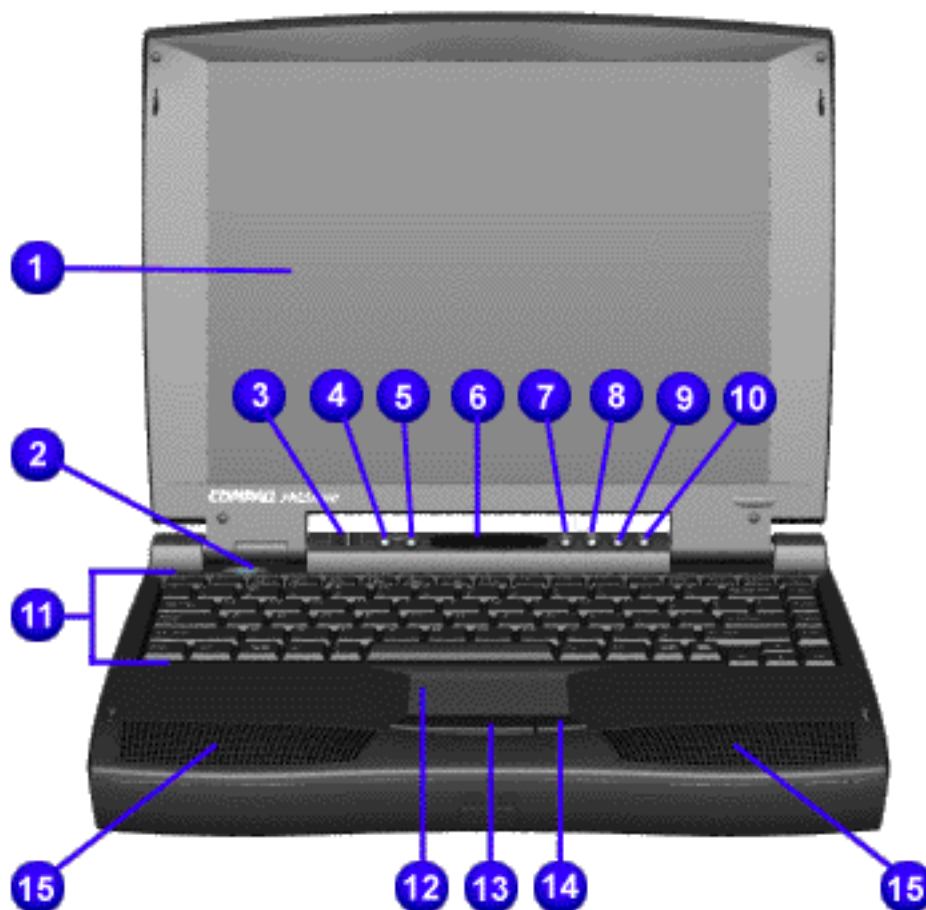

Front of Unit

Front of Unit	
1. Display	9. CD Previous Track
2. Power (On/Off) Button	10. CD Next Track
3. Display Switch	11. Keyboard
4. Volume Control Down Button	12. Touch Pad
5. Volume Control Up Button	13. Left Touch Pad Button
6. Status Panel	14. Right Touch Pad Button
7. CD Play/Pause	15. Integrated Speakers
8. CD Stop	

Maintenance & Service Guide

Presario 1600 Series Portable Computers

[Notice](#) | [Preface](#) | [Home](#) | [Product Description](#) | [Troubleshooting](#) | [Illustrated Parts Catalog](#)
[Removal & Replacement Procedures](#) | [Specifications](#) | [Connector Pin Assignments](#) | [Battery Pack](#)

Left Side Components

[Models and Features](#)

[Front Of Unit](#)

[Left Side Components](#)

[Right Side Components](#)

[Bottom Of Unit](#)

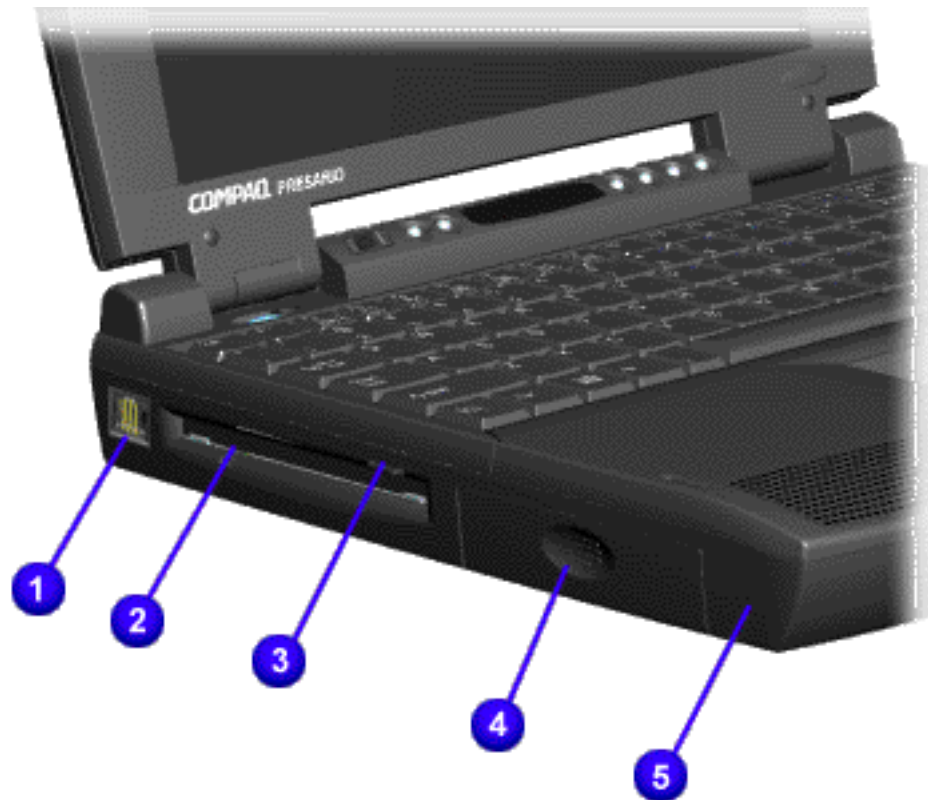

Left Side Components

1. Modem/Phone Jack	4. Battery Compartment
2. Diskette Drive Slot	5. Left Speaker Port
3. Diskette Eject Button	

Left Side Components

Download from [Www.Somanuals.com](http://www.Somanuals.com). All Manuals Search And Download.

Maintenance & Service Guide

Presario 1600 Series Portable Computers

[Notice](#) | [Preface](#) | [Home](#) | [Product Description](#) | [Troubleshooting](#) | [Illustrated Parts Catalog](#)
[Removal & Replacement Procedures](#) | [Specifications](#) | [Connector Pin Assignments](#) | [Battery Pack](#)

Right Side Components

[Models and Features](#)

[Front Of Unit](#)

[Left Side Components](#)

[Right Side Components](#)

[Bottom Of Unit](#)

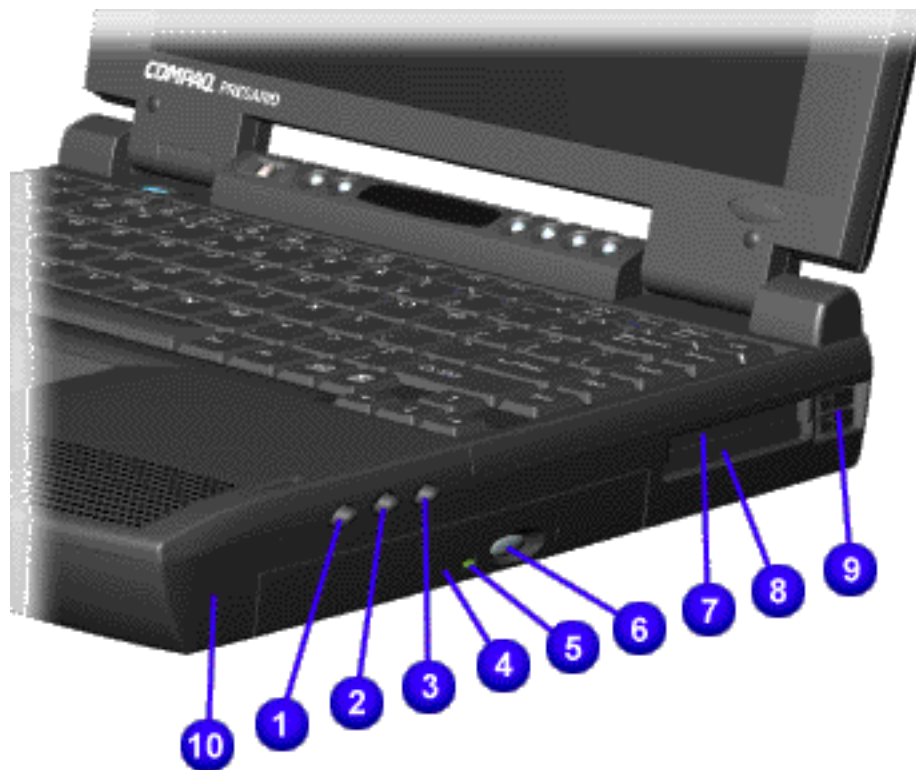

Right Side Components

Right Side Components	
1. Headphone/Line-Out Jack	6. CD Drive Eject Button
2. Line-in Jack	7. PC Card Top Slot
3. External Microphone Jack	8. PC Card Bottom Slot
4. CD Drive	9. PC Card Eject Levers
5. CD Drive Light	10. Right Speaker Port

Maintenance & Service Guide

Presario 1600 Series Portable Computers

[Notice](#) | [Preface](#) | [Home](#) | [Product Description](#) | [Troubleshooting](#) | [Illustrated Parts Catalog](#)
[Removal & Replacement Procedures](#) | [Specifications](#) | [Connector Pin Assignments](#) | [Battery Pack](#)

Bottom Of Unit

[Models and Features](#)

[Front Of Unit](#)

[Left Side Components](#)

[Right Side Components](#)

[Bottom Of Unit](#)

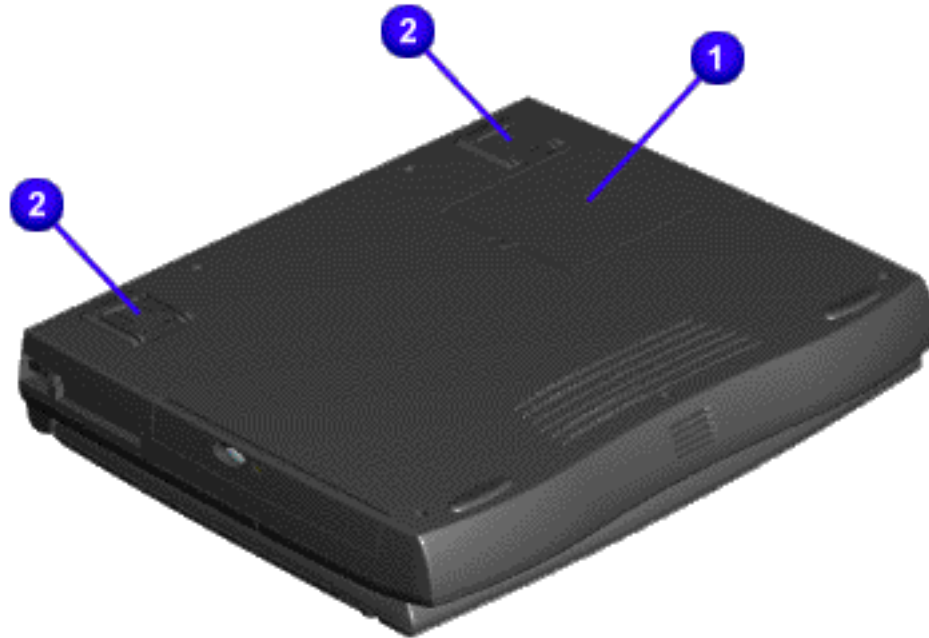

Bottom of Unit

1. Memory Compartment

2. Feet

[Bottom of Unit](#)

Maintenance & Service Guide

Presario 1600 Series Portable Computers

[Notice](#) | [Preface](#) | [Home](#) | [Product Description](#) | [Troubleshooting](#) | [Illustrated Parts Catalog](#)
[Removal & Replacement Procedures](#) | [Specifications](#) | [Connector Pin Assignments](#) | [Battery Pack](#)

Diagnostic

Preliminary Steps

Before running POST, complete the following preliminary steps:

1. If a power-on password has been established, type the password and press the **Enter** key. If the password is not known, [clear the password](#).
2. Run Computer Setup.
3. Adjust the brightness and contrast.
4. Turn off the computer and its external devices.

Disconnect any external devices that you do not want to test. Do not disconnect the printer if you want to test it or use it to log error messages.

NOTE:

If the problem only occurs when an external device is connected to the computer, the problem may be related to the external device or its cable. Verify this by running POST with and without the external device connected.

6. Install loopback plugs in the serial and parallel connectors if you would like to test these ports.
7. Ensure the hard drive is installed in the computer.
8. Ensure that the battery pack is inserted in the computer and the computer is connected to an external AC power source.

When the preliminary steps are completed, you are ready to run [POST](#).

Clearing the Power-On Password

Clearing the power-on password requires removing all Setup attributes that are programmed in the CMOS. If the password is not known, clear it by performing the following steps:

1. Turn off the computer.
2. Disconnect the power cord.
3. [Remove the battery pack](#).
4. [Remove the keyboard](#).
5. Remove the RTC battery (1) for 30 seconds as shown below. The password, together with other Setup attributes, will be cleared.

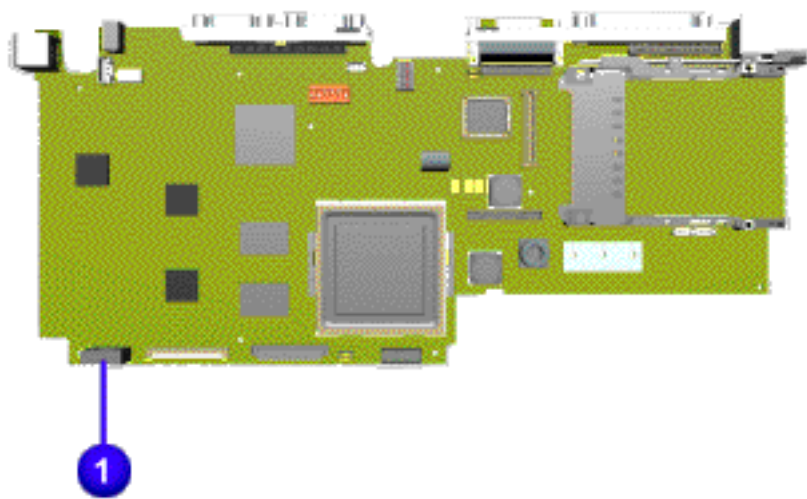

Clearing the Power-On Password

6. Turn the computer on to verify the power-on password has been cleared. If it has not been cleared, repeat these steps.

Maintenance & Service Guide

Presario 1600 Series Portable Computers

[Notice](#) | [Preface](#) | [Home](#) | [Product Description](#) | [Troubleshooting](#) | [Illustrated Parts Catalog](#)
[Removal & Replacement Procedures](#) | [Specifications](#) | [Connector Pin Assignments](#) | [Battery Pack](#)

Power On Self Test (POST)

Running POST

To run POST, complete the following steps:

Turn off the computer. Let stand for a 10 count, then turn the computer back on.

If POST does not detect any errors, the computer will not beep. This indicates successful completion of POST test. POST has run successfully and boots from the hard drive (or from a bootable diskette if one is installed in the diskette drive).

If POST detects errors, the errors are indicated by screen and/or audible messages. Refer to "[Power-On Self-Test \(POST\) Codes](#)" for a list of POST codes and their relevant descriptions.

NOTE: If the system is not functioning well enough to run POST, or if the display is not functioning well enough to show POST error messages, refer to the Troubleshooting tables.

Power-On Self-Test Messages	
102 162 301 304 601 605 1780 1782	
Probable Cause	Recommended Action
102-System Board Failure	
DMA, timers, etc.	Replace the system board.
162-System Options Not Set	
Configuration incorrect	Run Computer Setup.
CMOS reflects that an invalid configuration has been set.	Run Computer Setup.
RAM failure	1. Replace the memory modules. 2. Replace the system board.
Memory test data error	1. Replace the memory modules. 2. Replace the system board.
XX000YZZ RAM failure	Replace the system board.
301-Keyboard Error	
Keyboard failure	1. Ensure the keys are not depressed during POST. 2. Reconnect the keyboard with the computer off. 3. Replace the keyboard.
304-Keyboard or System Unit Error	
Keyboard or system board error	1. Replace the keyboard. 2. Replace the TouchPad or mouse. 3. Replace the system board.
601-Diskette Controller Error	
Mismatch in drive type or failure in the diskette controller	1. Run Computer Checkup (TEST). 2. Check and/or replace cables. 3. Replace the system board.
605-Diskette Drive Error	
Mismatch in drive type	Run Computer Setup.
1780-Primary Hard Drive 0 Failure	
Disk 0 failed to respond	1. Run Computer Checkup (TEST). 2. Replace the hard drive.
Hard drive format error	1. Run Computer Checkup (TEST). 2. Replace the hard drive.
1782-Hard Drive Controller	
Hard drive controller failure	1. Run Computer Setup. 2. Replace the hard drive.

[Back to top](#)

Maintenance & Service Guide

Presario 1600 Series Portable Computers

[Notice](#) | [Preface](#) | [Home](#) | [Product Description](#) | [Troubleshooting](#) | [Illustrated Parts Catalog](#)
[Removal & Replacement Procedures](#) | [Specifications](#) | [Connector Pin Assignments](#) | [Battery Pack](#)

Troubleshooting Without Diagnostics

This section provides information about how to identify and correct some common hardware, memory, and software problems. It also explains several types of common messages that may be displayed on the screen. The following pages contain troubleshooting information on:

[Audio](#)

[Battery/Battery gauge](#)

[CD drive](#)

[Diskette/Diskette drive](#)

[Display](#)

[Hard drive](#)

[Hardware Installation](#)

[Memory](#)

[PC Card](#)

[Power](#)

[Printer](#)

[Touch Pad](#)

[Keyboard/Numeric keypad](#)

Since symptoms can appear to be similar, carefully match the symptoms of the computer malfunction against the problem description in the Troubleshooting tables to avoid a misdiagnosis.



WARNING: To avoid a potential shock hazard during troubleshooting procedures, disconnect all power sources before removing the keyboard cover or the display bezel.

Before Replacing Parts

When troubleshooting a problem, check the following list for possible solutions before replacing parts:

- Verify that cables are connected properly to the suspected defective parts.
- Run Computer Setup after connecting external devices.
- Verify that all required device drivers are installed.
- Verify that all required changes have been made to the *CONFIG.SYS* file.
- Verify that all required changes have been made to the *AUTOEXEC.BAT* file.
- Verify that all printer drivers have been installed for each application.

Maintenance & Service Guide

Presario 1600 Series Portable Computers

[Notice](#) | [Preface](#) | [Home](#) | [Product Description](#) | [Troubleshooting](#) | [Illustrated Parts Catalog](#)
[Removal & Replacement Procedures](#) | [Specifications](#) | [Connector Pin Assignments](#) | [Battery Pack](#)

Keyboard Solutions

Solving Minor Problems

Some minor problems and possible solutions are outlined here. If the problem appears related to a software application, check the documentation provided with the software.

Solving Keyboard/Numeric Keypad Problems

Some common causes and solutions for keyboard/numeric keypad problems are listed in the following table.

Solving Keyboard/Numeric Keypad Problems		
Problem	Probable Cause	Solution(s)
Embedded numeric keypad on computer keyboard is disabled.	Num Lock function is not enabled.	Press the Shift+NumLk keys to enable the Num Lock function and embedded numeric keypad. The Num Lock icon on the status panel turns on.
Embedded numeric keypad is disabled and Num Lock function is on.	External numeric keypad is connected to the computer.	Disconnect the external numeric keypad from the computer.

[Back to Troubleshooting Without Diagnostics](#)

Maintenance & Service Guide

Presario 1600 Series Portable Computers

[Notice](#) | [Preface](#) | [Home](#) | [Product Description](#) | [Troubleshooting](#) | [Illustrated Parts Catalog](#)
[Removal & Replacement Procedures](#) | [Specifications](#) | [Connector Pin Assignments](#) | [Battery Pack](#)

Hard Drive Solutions

Solving Minor Problems

Some minor problems and possible solutions are outlined here. If the problem appears related to a software application, check the documentation provided with the software.

Solving Hard Drive Problems

Some common causes and solutions for hard drive problems are listed in the following table.



CAUTION: To prevent loss of information, always maintain an up-to-date backup of your hard drive at all times, in case of errors or failures.

Solving Hard Drive Problems

Problem	Probable Cause	Solution(s)
Reading hard drive takes an unusually long time after restarting the computer.	System entered Hibernation due to low battery condition and is now exiting from it.	Give the system time to restore the previously saved data to its exact state before Hibernation.
Hard drive error occurs.	Hard drive has bad sectors or has failed.	Run Computer Checkup.
Hard drive does not work.	Hard drive is not seated properly.	Turn off and unplug the computer, remove the battery pack, and remove and then reinstall the hard drive.

[Back to Troubleshooting Without Diagnostics](#)

Maintenance & Service Guide

Presario 1600 Series Portable Computers

[Notice](#) | [Preface](#) | [Home](#) | [Product Description](#) | [Troubleshooting](#) | [Illustrated Parts Catalog](#)
[Removal & Replacement Procedures](#) | [Specifications](#) | [Connector Pin Assignments](#) | [Battery Pack](#)

Diskette Solutions

Solving Minor Problems

Some minor problems and possible solutions are outlined here. If the problem appears related to a software application, check the documentation provided with the software.

Some common causes and solutions for diskette and diskette drive problems are listed below.

Solving Diskette and Diskette Drive Problems		
Problem	Probable Cause	Solution(s)
Diskette drive cannot write to a diskette.	Diskette is write-protected.	Disable the diskette's write-protect feature or use a diskette that is not write-protected.
	Computer is writing to the wrong drive.	Check the drive letter in the path statement.
	Not enough space is left on the diskette.	Use another diskette.
	Drive error has occurred.	Run Computer Checkup from the Compaq Diagnostics diskette.
	Diskette is not formatted.	Format the diskette. At the system prompt, enter FORMAT A:
Diskette drive cannot read a diskette.	The wrong type of diskette is being used.	Use the type of diskette required by the drive.
	Diskette has a bad sector.	Copy files to hard drive or another diskette. Reformat bad floppy.
	Drive error has occurred.	Run Computer Checkup from the Compaq Diagnostics diskette.
	Diskette is not formatted.	Format the diskette. At the system prompt, enter FORMAT A:
	The floppy controller is disabled in F10 Setup	Re-enable the floppy controller in F10 Setup
Cannot boot from diskette.	Bootable diskette is not in drive A.	Put the bootable diskette in drive A.
	Diskette Boot has incorrect setting in Computer Setup.	Run Computer Setup and set diskette as first to boot.

[Back to Troubleshooting Without Diagnostics](#)

Maintenance & Service Guide

Presario 1600 Series Portable Computers

[Notice](#) | [Preface](#) | [Home](#) | [Product Description](#) | [Troubleshooting](#) | [Illustrated Parts Catalog](#)
[Removal & Replacement Procedures](#) | [Specifications](#) | [Connector Pin Assignments](#) | [Battery Pack](#)

Solving Audio Problems

Solving Minor Problems

Some minor problems and possible solutions are outlined here. If the problem appears related to a software application, check the documentation provided with the software.

Some common audio problems and solutions are listed in the following table.

Solving Audio Problems		
Problem	Probable Cause	Solution(s)
Computer does not beep after the Power-On Self-Test (POST).	This is typical; it indicates successful completion of the Power-On Self-Test (POST).	No action is required.

[Back to Troubleshooting Without Diagnostics](#)

Maintenance & Service Guide

Presario 1600 Series Portable Computers

[Notice](#) | [Preface](#) | [Home](#) | [Product Description](#) | [Troubleshooting](#) | [Illustrated Parts Catalog](#)
[Removal & Replacement Procedures](#) | [Specifications](#) | [Connector Pin Assignments](#) | [Battery Pack](#)

Battery Pack

Solving Minor Problems

Some minor problems and possible solutions are outlined in the following tables. If the problem appears related to a software application, check the documentation provided with the software.

Solving Battery Pack and Battery Gauge Problems

Some common causes and solutions for battery pack problems are listed below. The [Solving Power Problems](#) section in this chapter may also be useful.

Solving Battery Pack and Battery Gauge Problems		
Problem	Probable Cause	Solution(s)
Computer won't turn on when battery pack is inserted and power cord is unplugged.	Battery pack is discharged.	<p>Connect the computer to an external power source and charge the battery pack.</p> <p>Replace the battery pack with a fully charged battery pack.</p> <p>Check the battery connectors on the system board to verify they are evenly spaced and that they are not bent or broken.</p>
Computer is beeping and battery icon on the LCD status display is blinking.	Battery charge is low.	<p>Immediately save any open file(s). Then do one of the following:</p> <ul style="list-style-type: none"> ■ Connect the computer to an external power source to charge the battery pack. ■ Turn off the computer or initiate Hibernation until you can find another power source or charge the battery pack.
Computer battery icon on the LCD status display blinks to indicate low battery condition, but computer does not beep.	Volume is turned down too low.	Adjust the volume.
Battery icon doesn't light and battery pack won't fast charge.	Battery pack is already charged	No action is necessary
	Battery pack was exposed to temperature extremes.	Allow time for the battery pack to return to room temperature.
	Battery pack is at end of its life.	Replace battery pack.
You have to set the date and time every time you turn on the computer.	RTC battery is dead.	Replace the RTC battery.
Battery charge does not last as long as expected.	Battery is being exposed to high temperatures or extremely cold temperatures.	Keep the battery pack within the recommended operating temperature range 50° F to 104° F (10° C to 40° C) or recommended storage range -4° F to 86° F (-20° C to 30° C). Recharge the battery pack.
	Battery has partially self-discharged.	Recharge the battery. Discharge the battery completely and then recharge it.
	Power management is disabled.	Set a power management level in Computer Setup.
	An external device or PC Card is draining the battery.	Turn off or disconnect external devices when not using them.
Battery pack is warm to the touch after charging.	Normal warming has occurred due to charging.	No action is required.
Battery pack operating time is far less than the documented average operating time.	Power management is turned off or disabled.	Enable power management in Computer Setup and in Windows Power Properties.
	An external device or PC Card is draining the battery.	Turn off or disconnect external devices when not using them.
	Battery pack has partially self-discharged.	<p>Condition the battery pack by fully charging, fully discharging, then fully recharging it.</p> <p>To maintain the charge, leave battery packs in the computer when it is connected to external power.</p> <p>If the computer is disconnected from external power for more than two weeks, remove battery packs from the computer to reduce the discharge rate.</p>
	Battery pack is being exposed to high temperatures or extremely cold temperatures.	<p>Keep the battery pack within the recommended temperature ranges.</p> <p>Operating: 50° F to 104° F (10° C to 40° C) Storage: -4° F to 86° F (-20° C to 30° C)</p> <p>Recharge the battery pack.</p>

[Back to Troubleshooting Without Diagnostics](#)

Maintenance & Service Guide

Presario 1600 Series Portable Computers

[Notice](#) | [Preface](#) | [Home](#) | [Product Description](#) | [Troubleshooting](#) | [Illustrated Parts Catalog](#)
[Removal & Replacement Procedures](#) | [Specifications](#) | [Connector Pin Assignments](#) | [Battery Pack](#)

Power Solutions

Solving Minor Problems

Some minor problems and possible solutions are outlined here. If the problem appears related to a software application, check the documentation provided with the software.

Solving Power Problems

Also see [Solving Battery and Battery Gauge Problems](#).

Solving Power Problems		
Problem	Probable Cause	Solution(s)
Computer won't turn on and battery pack is not inserted*.	Computer is not connected to a power source.	Insert battery or connect an external power source.
	Power cords to the external power source are unplugged.	Ensure that power cords connecting the computer and the external power source are plugged in properly.
	Power adapter is defective.	Replace AC Adapter and restart.
The computer doesn't timeout while on AC power	The system is designed not to timeout while on AC power.	Windows will spin down the hard drive. Windows can be configured to power off the monitor using the display properties control panel applet. Alternatively, the user can change "BIOS-PM on AC" in the BIOS setup.
Computer turned off while it was left unattended and the power icon is off.	System board is defective.	Replace the system board.
	System initiated Hibernation due to a critical low-battery condition.	Replace the battery pack with a fully charged battery pack or connect the computer to an external power source. Then turn on the computer.
	System initiated Hibernation after a preset timeout.	Turn on the computer.

* In rare cases, it may be necessary to remove the power cord and the battery, wait 30 seconds, and reinsert the power cord to power on the unit. The above steps reset the keyboard controller which is usually always powered, even when the computer appears to be off.

[Back to Troubleshooting Without Diagnostics](#)

Maintenance & Service Guide

Presario 1600 Series Portable Computers

[Notice](#) | [Preface](#) | [Home](#) | [Product Description](#) | [Troubleshooting](#) | [Illustrated Parts Catalog](#)
[Removal & Replacement Procedures](#) | [Specifications](#) | [Connector Pin Assignments](#) | [Battery Pack](#)

CD Drive Solutions

Solving Minor Problems

Some minor problems and possible solutions are outlined in the following tables. If the problem appears related to a software application, check the documentation provided with the software.

Solving CD Drive Problems

Some common causes and solutions for CD drive problems are listed in the following table.

Solving CD Drive Problems		
Problem	Probable Cause	Solution(s)
CD drive cannot read a compact disc.	Compact disc is upside down or is improperly inserted in the CD drive.	Open the CD loading tray, lay the compact disc in it (label side up), then close the tray.
	CD is CD Plus or Pregap/Track 0 type.	Cannot read these type CDs in 24× CD drive. Remove the CD.
No CDs work at all.	The Performance tab in System properties shows that one or more of the hard disks in your computer is using MS-DOS Compatibility mode.	If the driver name listed as causing MS-DOS Compatibility mode is MBRINT13.SYS, your computer may be infected with a boot-sector virus. Please <i>purchase</i> a virus scanning software package (consult your local software retailer for recommendations) to check your system. If the application you purchase successfully eliminates the virus, scan (check) all of your diskettes before re-installing to prevent further contamination.

Maintenance & Service Guide

Presario 1600 Series Portable Computers

[Notice](#) | [Preface](#) | [Home](#) | [Product Description](#) | [Troubleshooting](#) | [Illustrated Parts Catalog](#)
[Removal & Replacement Procedures](#) | [Specifications](#) | [Connector Pin Assignments](#) | [Battery Pack](#)

Hardware Installation Solutions

Solving Minor Problems

Some minor problems and possible solutions are outlined here. If the problem appears related to a software application, check the documentation provided with the software.

Solving Hardware Installation Problems

Some common causes and solutions for hardware installation problems are listed here.

Solving Hardware Installation Problems		
Problem	Probable Cause	Solutions(s)
A new device is not recognized as part of the computer system.	Cable(s) of new external device are loose or power cables are unplugged.	Ensure that all cables are properly and securely connected.
	Power switch of new external device is not turned on.	Turn off the computer, turn on the external device, then turn on the computer to integrate the device with the computer system.
	Device is not seated properly.	Turn off the computer and reinsert the device.

[Back to Troubleshooting Without Diagnostics](#)

Maintenance & Service Guide

Presario 1600 Series Portable Computers

[Notice](#) | [Preface](#) | [Home](#) | [Product Description](#) | [Troubleshooting](#) | [Illustrated Parts Catalog](#)
[Removal & Replacement Procedures](#) | [Specifications](#) | [Connector Pin Assignments](#) | [Battery Pack](#)

Memory Solutions

Solving Minor Problems

Some minor problems and possible solutions are outlined here. If the problem appears related to a software application, check the documentation provided with the software.

Solving Memory Problems

Some common causes and solutions for memory problems are listed in the following table.

Solving Memory Problems		
Problem	Probable Cause	Solution(s)
Memory count during Power-On Self-Test (POST) is incorrect.	Optional memory expansion card is installed incorrectly, is incompatible with the computer, or is defective.	Ensure that the optional memory expansion card is installed correctly.
"Out of Memory" message is displayed on the screen or insufficient memory error occurs during operation.	System ran out of memory for the application.	Check the application documentation for memory requirements. Install additional memory.
	Too many TSR (terminate-and-stay-resident) applications are running.	Remove from memory any TSR applications that you do not need.

[Back to Troubleshooting Without Diagnostics](#)

Maintenance & Service Guide

Presario 1600 Series Portable Computers

[Notice](#) | [Preface](#) | [Home](#) | [Product Description](#) | [Troubleshooting](#) | [Illustrated Parts Catalog](#)
[Removal & Replacement Procedures](#) | [Specifications](#) | [Connector Pin Assignments](#) | [Battery Pack](#)

PC Card Solutions

Solving Minor Problems

Some minor problems and possible solutions are outlined here. If the problem appears related to a software application, check the documentation provided with the software.

Solving PC Card Problems

Some common causes and solutions for PC Card problems are listed in the following table.

Solving PC Card Problems		
Problem	Probable Cause	Solution(s)
When turned on, the computer does not beep when a PC Card is inserted *.	Card is not inserted properly.	Ensure the card is inserted in the correct orientation.
	PC Card beeps are disabled.	Double-click the PC Card icon in the Control Panel, click the Global Settings tab, the enable PC Card sound effects.
	Speaker is turned off or volume is turned down.	Press volume buttons to turn the speaker on, then increase the volume.
	PC Card drivers are not installed.	Double click the Add New Hardware icon in the Control Panel for installation instructions. If PC Card or drivers are not compatible with Windows, install drivers and use the PC Card in MS-DOS mode.
PC Card modem, fax, or network card does not work.	Card or card driver is not supported.	Contact your Compaq authorized service provider for a list of PC Cards tested successfully in Compaq PC Card platforms.
	Card is not fully inserted into the slot or is not inserted properly.	Ensure the card is inserted in the correct orientation.
	Telephone cord is not plugged in all the way.	Check and secure telephone connection.
PC Card modem or fax card does not work.	Necessary drivers are not installed (turned on).	Install drivers.
	You are trying to access the card using the wrong COM port.	See Chapter 6 to verify COM port.
PC Card modem or fax card does not work.	The card conflicts with a serial device.	See Chapter 6 to verify address.
	The card is not supported.	Use supported cards only.
Modem network PC Card does not work.	Network driver is not installed or is not set up properly.	Install driver.
	Telephone cord is not properly connected.	Verify telephone connection
Memory or storage card does not work.	SRAM and flash memory cards require the memory card driver to be loaded (turned on).	Install driver.
	Flash memory cards require the Microsoft FlashFile System to be loaded.	
	Hard drives on flash mass storage cards require the PC Card ATA driver to be loaded.	
	You are trying to access the hard drive card using the wrong drive letter.	Double-click My Computer to verify the drive letter assigned to the card.
	The card is not supported.	Contact your Compaq authorized service provider for a list of PC Cards tested successfully in Compaq PC Card platforms.

* To use two 16-bit PC Cards, an IRQ must be freed by disabling a device such as the parallel port, serial port, or audio controller. By default, only one free IRQ is available. Most 16-bit PC Cards require one free ISA interrupt.

Maintenance & Service Guide

Presario 1600 Series Portable Computers

[Notice](#) | [Preface](#) | [Home](#) | [Product Description](#) | [Troubleshooting](#) | [Illustrated Parts Catalog](#)
[Removal & Replacement Procedures](#) | [Specifications](#) | [Connector Pin Assignments](#) | [Battery Pack](#)

Printer Solutions

Solving Minor Problems

Some minor problems and possible solutions are outlined here. If the problem appears related to a software application, check the documentation provided with the software.

Solving Printer Problems

If you experience problems printing, run a printer self-test. Refer to the documentation provided with your printer for instructions. If the self-test fails, it is a printer-specific problem. Also refer to the printing section of your application documentation.

Solving Printer Problems		
Problem	Probable Cause	Solution(s)
Printer will not turn on.	The signal cable may not be connected properly, or the printer is unplugged.	Ensure that the signal cable is properly connected and that the power cord is connected to the electrical outlet.
Printer will not print.	Printer is not turned on or is off line.	Turn the printer on and set it to on line.
	The device drivers for your application are not installed.	Refer to the printer documentation to install the correct printer driver.
	Printer that is set up for a network is not connected to the network.	Connect the printer to the network.
	Printer cable is too long, unshielded, or defective.	Replace the cable.
	Paper tray is empty.	Fill the paper tray with paper and set the printer to online.
Printer prints garbled information.	Correct printer drivers are not installed.	Refer to the printer documentation to install the correct printer driver.
	Cable is not connected properly.	Ensure that the printer signal cable is properly connected to the computer.
	Cable is defective.	Replace the printer cable and retest.

[Back to Troubleshooting Without Diagnostics](#)

Maintenance & Service Guide

Presario 1600 Series Portable Computers

[Notice](#) | [Preface](#) | [Home](#) | [Product Description](#) | [Troubleshooting](#) | [Illustrated Parts Catalog](#)
[Removal & Replacement Procedures](#) | [Specifications](#) | [Connector Pin Assignments](#) | [Battery Pack](#)

Touch Pad Solutions

Solving Minor Problems

Some minor problems and possible solutions are outlined here. If the problem appears related to a software application, check the documentation provided with the software.

Solving Touch Pad/Pointing Device Problems

Some common causes and solutions for Touch Pad/pointing device problems are listed in the following table.

Solving Touch Pad/Pointing Device Problems		
Problem	Cause	Solution(s)
Touch Pad or mouse does not work.	Incorrect or no device driver is installed.	Install the device driver and add to the AUTOEXEC.BAT file or CONFIG.SYS file.
	The device driver is not installed in Windows.	Install the Touch Pad/mouse driver in Windows.
External mouse does not work.	Mouse is not securely connected or is connected to an incorrect external connector.	Ensure that the mouse is securely connected to the appropriate external connector.
Touch Pad or mouse does not work even though the device is enabled in Windows.	Mouse is not enabled.	Enter SYNTOUCH.COM at the system prompt to activate the mouse device driver. (C:\WINDOWS\DOSSTART.BAT)
		Add a line in the AUTOEXEC.BAT file to automatically activate the mouse device driver each time computer is turned on or restarted.
	Cable not properly seated in Touch Pad board.	Reseat cable.
	Defective Touch Pad board.	Replace Touch Pad board.
	Defective system board.	Replace system board.
	Device driver is not correctly installed in Windows.	Install the appropriate device driver in Windows.
Cursor skips or moves abnormally when using the Touch Pad.	The Touch Pad needs to be cleaned.	Clean the Touch Pad with a cloth dampened with alcohol or an ammonia-based glass cleaner. Wipe up liquid with a dry cloth.

[Back to Troubleshooting Without Diagnostics](#)

Maintenance & Service Guide

Presario 1600 Series Portable Computers

[Notice](#) | [Preface](#) | [Home](#) | [Product Description](#) | [Troubleshooting](#) | [Illustrated Parts Catalog](#)
[Removal & Replacement Procedures](#) | [Specifications](#) | [Connector Pin Assignments](#) | [Battery Pack](#)

Error Codes

Diagnostic error codes occur if the system recognizes a problem while running the [Compaq Diagnostic](#) program. These error codes help identify possibly defective subassemblies.

The following tables list error codes, a description of the error condition, and the action required to resolve the error condition.

IMPORTANT: Retest the system after completing each step. If the problem has been resolved, do not proceed with the remaining steps.

For assistance in For the removal and replacement of a particular subassembly, see [Removal and Replacement Procedures](#).

Select error codes by number or type:

101 through 114	Processor Test
200 through 215	Memory Test
300 through 304	Keyboard Test
401 through 403	Parallel Printer Test
600 through 699	Diskette Drive Test
1101	Serial Test
1701 through 1736	Hard Drive Test
501 through 516	Video Test
2402 through 2456	
2458 through 2480	
3206	Audio Test
8601 through 8602	Touch Pad Pointing Device Test
3301 through 6623	CD Test

Processor Test Error Codes		
Error Code	Description	Recommended Action
101-xx	CPU test failed	Replace the processor and retest.
102-xx	Coprocessor or Weitek Error	1. Run the Configuration and Diagnostics Utilities. 2. Replace the processor board and retest.
103-xx	DMA page registers test failed	Replace the system board and retest.
104-xx	Interrupt controller master test failed	
105-xx	Port 61 error	
106-xx	Keyboard controller self-test failed	
107-xx	CMOS RAM test failed	
108-xx	CMOS interrupt test failed	
109-xx	CMOS clock test failed	
110-xx	Programmable timer load data test failed	
113-xx	Protected mode test failed	
114-01	Speaker test failed	

Memory Test Error Codes		
Error Code	Description	Recommended Action
200-xx	Memory machine ID test failed	1. Flash the system ROM and retest. 2. Replace the system board and retest.
202-xx	Memory system ROM checksum failed	
203-xx	Write/Read test failed	1. Remove the memory module and retest. 2. Install a new memory module and retest.
204-xx	Address test failed	
211-xx	Random pattern test failed	
214-xx	Noise test failed	
215-xx	Random address test failed	

Keyboard Test Error Codes		
Error Code	Description	Recommended Action
300-xx	Failed ID Test	1. Check the keyboard connection. If disconnected, turn off the computer and connect the keyboard.
301-xx	Failed Selftest/Interface Test	
302-xx	Failed Individual Key Test	2. Replace the keyboard and retest.
304-xx	Failed Keyboard Repeat Test	3. Replace the system board and retest.

Parallel Printer Test Error Codes		
Error Code	Description	Recommended Action
401-xx	Printer failed or not connected	1. Connect the printer. 2. Check power to the printer. 3. Install the loop-back connector and retest. 4. Check port and IRQ configuration. 5. Replace the system board and retest.
402-xx	Failed Port Test	
403-xx	Printer pattern test failed	

Diskette Drive Test		
Error Code	Description	Recommended Action
600-xx	Diskette ID drive types test failed	1. Replace the diskette media and retest. 2. Check and/or replace the diskette power and signal cables and retest. 3. Replace the diskette drive and retest. 4. Replace the system board and retest.
601-xx	Diskette format failed	
602-xx	Diskette read test failed	
603-xx	Diskette write, read, compare test failed	
604-xx	Diskette random read test failed	
605-xx	Diskette ID media failed	
606-xx	Diskette speed test failed	
609-xx	Diskette reset controller test failed	
610-xx	Diskette change line test failed	
697-xx	Diskette type error	
698-xx	Diskette drive speed not within limits	
699-xx	Diskette drive/media ID error	1. Replace media. 2. Run the Configuration and Diagnostics Utilities.

Serial Test Error Codes		
Error Code	Description	Recommended Action
1101-xx	Serial port test failed	1. Check port configuration 2. Replace the system board and retest.

Hard Drive Test Error Codes		
Error Code	Description	Recommended Action
1701-xx	Hard drive format test failed	1. Run the Configuration and Diagnostics Utilities and verify drive type. 2. Verify that all secondary drives have secondary drive capability. 3. Replace the hard drive and retest. 4. Replace the system board and retest.
1702-xx	Hard drive read test failed	
1703-xx	Hard drive write/read/compare test failed	
1704-xx	Hard drive random seek test failed	
1705-xx	Hard drive controller test failed	
1706-xx	Hard drive ready test failed	
1707-xx	Hard drive recalibration test failed	
1708-xx	Hard drive format bad track test failed	
1709-xx	Hard drive reset controller test failed	
1710-xx	Hard drive park head test failed	
1715-xx	Hard drive head select test failed	
1716-xx	Hard drive conditional format test failed	
1717-xx	Hard drive ECC* test failed	
1719-xx	Hard drive power mode test failed	
1724-xx	Network preparation test failed	
1736-xx	Drive monitoring test failed	

* ECC = Error Correction Code

Video Test Error Codes		
Error Code	Description	Recommended Action
501-xx	Video controller test failed	The following apply to error codes 501-xx through 516-xx: 1. Disconnect external monitor and test with internal LCD display. 2. Replace the display assembly and retest. 3. Replace the system board and retest.
502-xx	Video memory test failed	
503-xx	Video attribute test failed	
504-xx	Video character set test failed	
505-xx	Video 80 × 25 mode 9 × 14 character cell test failed	
506-xx	Video 80 × 25 mode 8 × 8 character cell test failed	
507-xx	Video 40 × 25 mode test failed	
508-xx	Video 320 × 200 mode color set 0 test failed	
509-xx	Video 320 × 200 mode color set 1 test failed	
510-xx	Video 640 × 200 mode test failed	

511-xx	Video screen memory page test failed	The following steps apply to error codes 2402-xx through 2456-xx: 1. Run the Configuration and Diagnostics Utilities. 2. Replace the display assembly and retest. 3. Replace the system board and retest.
512-xx	Video gray scale test failed	
514-xx	Video white screen test failed	
516-xx	Video noise pattern test failed	
2402-xx	Video memory test failed	
2403-xx	Video attribute test failed	
2404-xx	Video character set test failed	
2405-xx	Video 80 × 25 mode 9 × 14 character cell test failed	
2406-xx	Video 80 × 25 mode 8 × 8 character cell test failed	
2408-xx	Video 320 × 200 mode color set 0 test failed	
2409-xx	Video 320 × 200 mode color set 1 test failed	
2410-xx	Video 640 × 200 mode test failed	The following step applies to error codes 2458-xx through 2480-xx: Replace the system board and retest.
2411-xx	Video screen memory page test failed	
2412-xx	Video gray scale test failed	
2414-xx	Video white screen test failed	
2416-xx	Video noise pattern test failed	
2418-xx	ECG/VGC memory test failed	
2419-xx	ECG/VGC ROM checksum test failed	
2421-xx	ECG/VGC 640 × 200 graphics mode test failed	
2422-xx	ECG/VGC 640 × 350 16 color set test failed	
2423-xx	ECG/VGC 640 × 350 64 color set test failed	
2424-xx	ECG/VGC monochrome text mode test failed	
2425-xx	ECG/VGC monochrome graphics mode test failed	
2431-xx	640 × 480 graphics test failure	
2432-xx	320 × 200 graphics (256 color mode) test failure	
2448-xx	Advanced VGA Controller test failed	
2451-xx	132-column Advanced VGA test failed	
2456-xx	Advanced VGA 256 Color test failed	
2458-xx	Advanced VGA BitBLT test	
2468-xx	Advanced VGA DAC test	
2477-xx	Advanced VGA data path test	
2478-xx	Advanced VGA BitBLT test	
2480-xx	Advanced VGA LineDraw test	

Audio Test Error Codes		
Error Code	Description	Recommended Action
3206-xx	Audio System Internal Error	Replace the system board and retest.

TouchPad/Pointing Device Interface Test Error Codes		
Error Code	Description	Recommended Action
8601-xx	Mouse test failed	1. Replace the TouchPad and retest. 2. Replace the system board and retest.
8602-xx	Interface test failed	

CD Drive Test Error Codes		
Error Code	Description	Recommended Action
3301-xx	CD drive read test failed	1. Replace the CD and retest. 2. Verify that the speakers are connected. 3. Verify that drivers are loaded and properly installed. 4. Replace the CD drive and retest. 5. Replace the system board and retest.
3305-xx	CD drive seek test failed	
6600-xx	ID test failed	
6605-xx	Read test failed	
6608-xx	Controller test failed	
6623-xx	Random read test failed	

[Back to top](#)

Maintenance & Service Guide

Presario 1600 Series Portable Computers

[Notice](#) | [Preface](#) | [Home](#) | [Product Description](#) | [Troubleshooting](#) | [Illustrated Parts Catalog](#)
[Removal & Replacement Procedures](#) | [Specifications](#) | [Connector Pin Assignments](#) | [Battery Pack](#)

System Unit

System Unit

Boards

Display

Mass Storage Devices

Cables

Miscellaneous Hardware and Screws

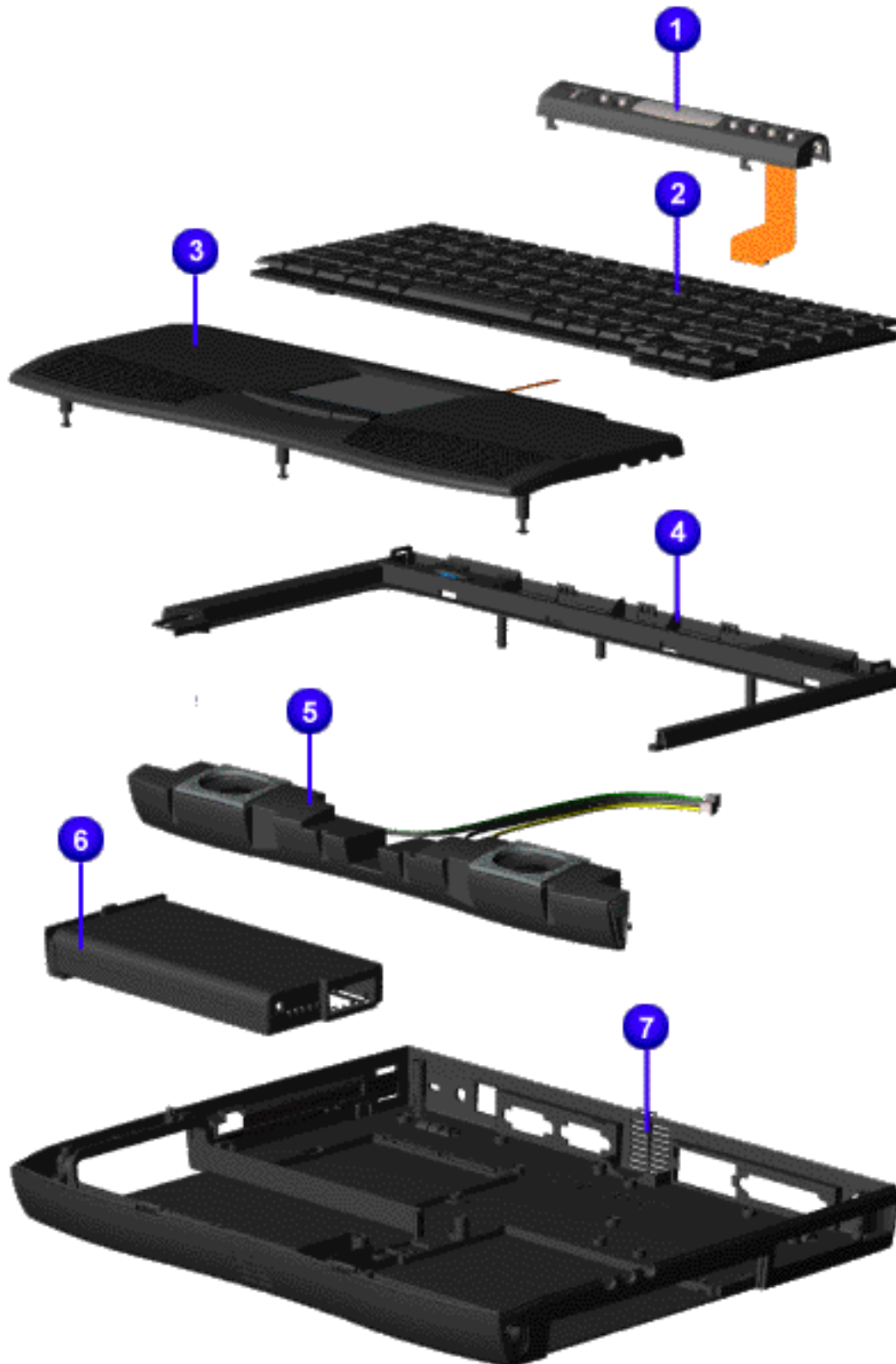

Description	Spare Part Number
1. Status Panel w/Cable	293737-001
2. Keyboards,	
3. Palmrest Cover w/Board and Cable	332226-001
4. Upper CPU Cover Assembly w/Cable and Power Switch (Top Plastics)	293739-001
5. Speaker Assembly, Premium	330979-001
6. Battery Pack, E.S. NiMH	293861-001
6. Battery Pack, Li ion	292560-001
7. CPU Base Assembly (Bottom Plastics), Enclosure	332230-001

Maintenance & Service Guide

Presario 1600 Series Portable Computers

[Notice](#) | [Preface](#) | [Home](#) | [Product Description](#) | [Troubleshooting](#) | [Illustrated Parts Catalog](#)
[Removal & Replacement Procedures](#) | [Specifications](#) | [Connector Pin Assignments](#) | [Battery Pack](#)

Boards

System Unit

Boards

Display

Mass Storage Devices

Cables

Miscellaneous Hardware and Screws

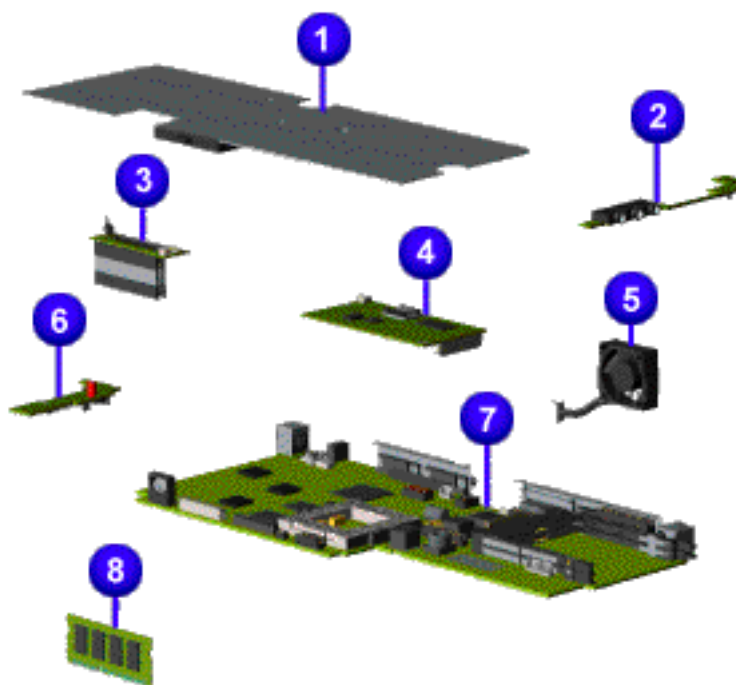

Description	Spare Part Number
1.Heatspreader	298607-001
2.Audio Board w/Jacks	293882-001
3.LCD Interface Board w/Header	293746-001
4.Modem, M+K-56 K Data/Fax	298974-002
K-56K Data/Fax	138657-001
5.Fan	332228-001
6.Voltage Converter	293748-001
7.System Board, w/o Processor	330982-001
8.System Memory, (SODIMM) 64-MB 32-MB 16-MB	332208-001 293727-001 293726-001
LCD Interface (TFT) Connector*	293156-001
LCD Interface (DSTN) Connector*	332232-001
Processor, K/233 MHz MMX*	330980-001
*Not Shown	Back to top

Maintenance & Service Guide

Presario 1600 Series Portable Computers

[Notice](#) | [Preface](#) | [Home](#) | [Product Description](#) | [Troubleshooting](#) | [Illustrated Parts Catalog](#)
[Removal & Replacement Procedures](#) | [Specifications](#) | [Connector Pin Assignments](#) | [Battery Pack](#)

Display

[System Unit](#)

[Boards](#)

[Display](#)

[Mass Storage Devices](#)

[Cables](#)

[Miscellaneous Hardware and Screws](#)



Description	Spare Part Number
Display Assembly Model 1625 12.1 inch HPA	298495-001
Display Assembly w/o microphone, Model 12.1 inch TFT	332224-001

[Display Assembly](#)

Maintenance & Service Guide

Presario 1600 Series Portable Computers

[Notice](#) | [Preface](#) | [Home](#) | [Product Description](#) | [Troubleshooting](#) | [Illustrated Parts Catalog](#)
[Removal & Replacement Procedures](#) | [Specifications](#) | [Connector Pin Assignments](#) | [Battery Pack](#)

Mass Storage Devices

[System Unit](#)

[Boards](#)

[Display](#)

[Mass Storage
Devices](#)

[Cables](#)

[Miscellaneous
Hardware
and Screws](#)

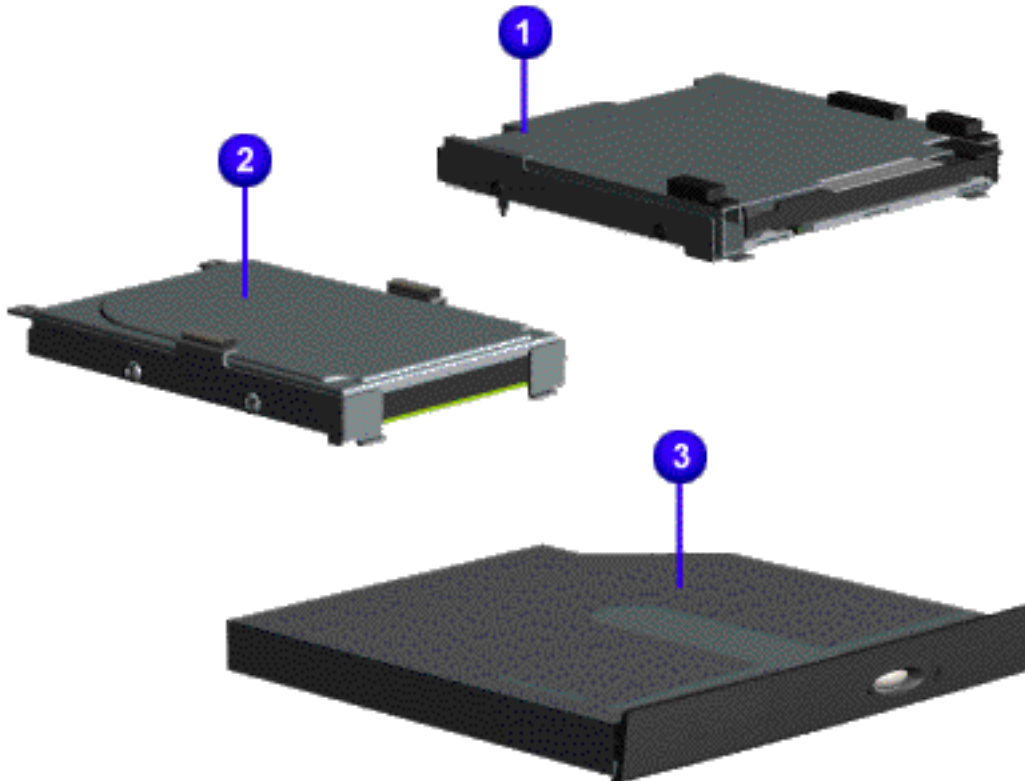

Description	Spare Part Number
1. Diskette Drive, 1.44 MB, 3.5"	330971-001
2. Hard Drive 3.2-GB Model Hard Drive 4.0-GB Model	330968-001 330988-001
3. 24x CD Drive	330967-001

Maintenance & Service Guide

Presario 1600 Series Portable Computers

[Notice](#) | [Preface](#) | [Home](#) | [Product Description](#) | [Troubleshooting](#) | [Illustrated Parts Catalog](#)
[Removal & Replacement Procedures](#) | [Specifications](#) | [Connector Pin Assignments](#) | [Battery Pack](#)

Cables

System Unit

Boards

Display

Mass Storage Devices

Cables

- [Miscellaneous Cables Kit](#)
- [Modem Cables](#)
- [AC Power Cords](#)

Miscellaneous Hardware and Screws

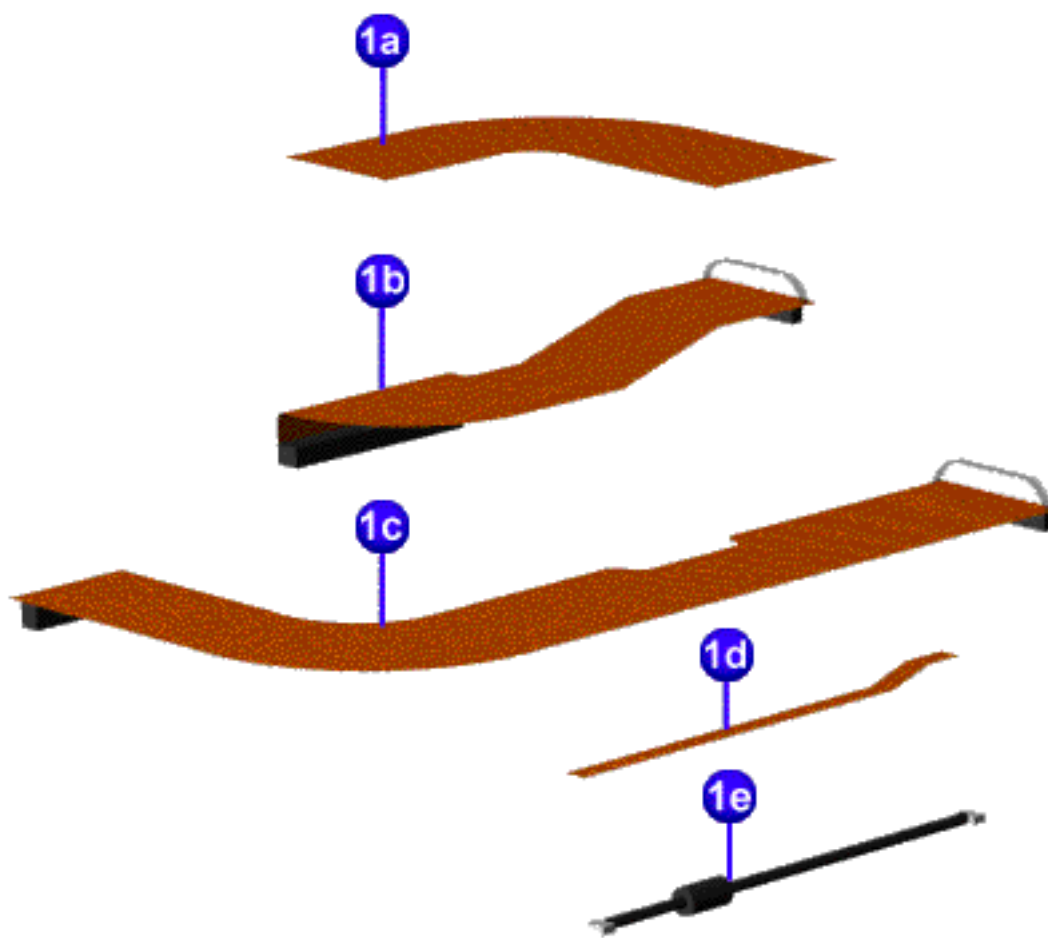

Miscellaneous Cables Kit Spare Part Number: 332234-001

Description	Quantity
1a. Cable, CD Drive	1
1b. Cable, Hard Drive	1
1c. Cable, Diskette Drive	1
1d. Cable, TouchPad SW Board	1
1e. Cable, Fax/Modem	1
CD Play Board*	1
*Not Shown	

Modem Cables

Description	Spare Part Number
Belgium	304398-181
Canada	137256-001
Japan	137256-001
Latin America	137256-001
United States	137256-001
United Kingdom w/adapter	304398-031
France w/adapter	304398-051
Netherlands w/adapter	304398-331

AC Power Cords (Not Shown)

Description	Spare Part Number
US/Canada	293831-001
United Kingdom	293831-031
Japan	293831-291
International	293831-002

[Back to top](#)

Maintenance & Service Guide

Presario 1600 Series Portable Computers

[Notice](#) | [Preface](#) | [Home](#) | [Product Description](#) | [Troubleshooting](#) | [Illustrated Parts Catalog](#)
[Removal & Replacement Procedures](#) | [Specifications](#) | [Connector Pin Assignments](#) | [Battery Pack](#)

Miscellaneous Hardware and Screws

System Unit

Boards

Display

Mass Storage Devices

Cables

Miscellaneous Hardware and Screws

- [Miscellaneous Parts](#)
- [Miscellaneous Hardware Kit](#)
- [Return Kits](#)

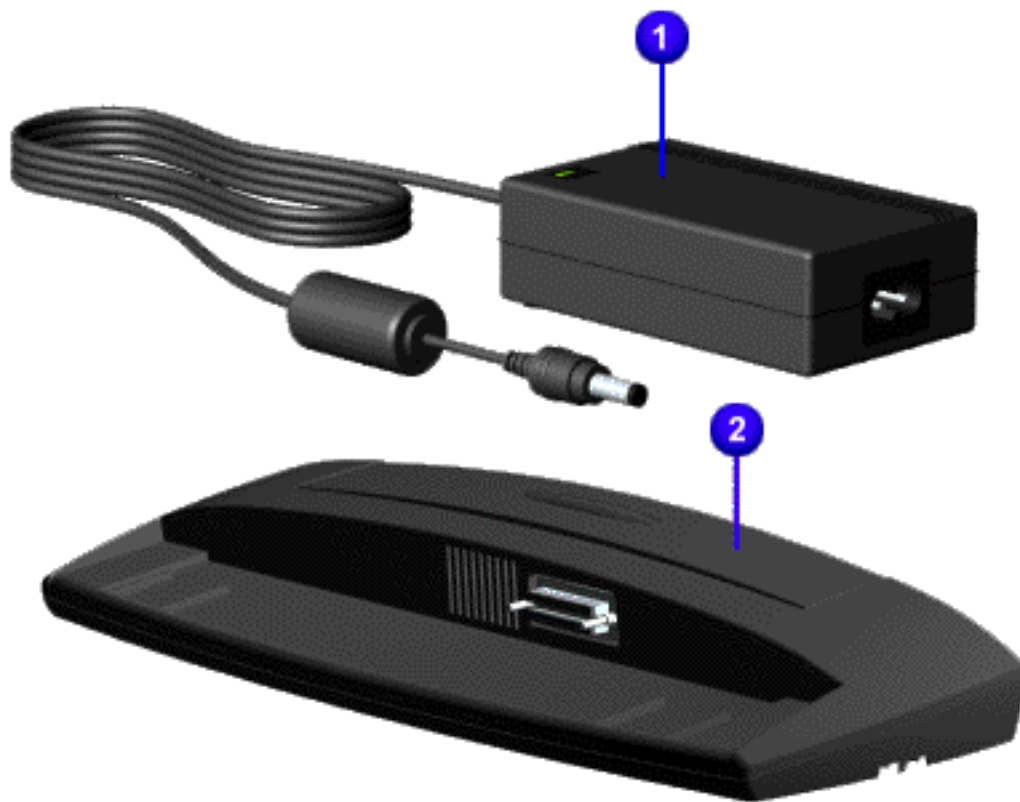

Miscellaneous Parts	
Description	Spare Part Number
1. AC Adapter	298239-001
2. Port Replicator	293857-001
Clock Battery (Not Shown)	117099-001
Miscellaneous Screw Kit (Not Shown)	293760-001
Logo Kit (Not Shown)	203727-001

[Back to top](#)

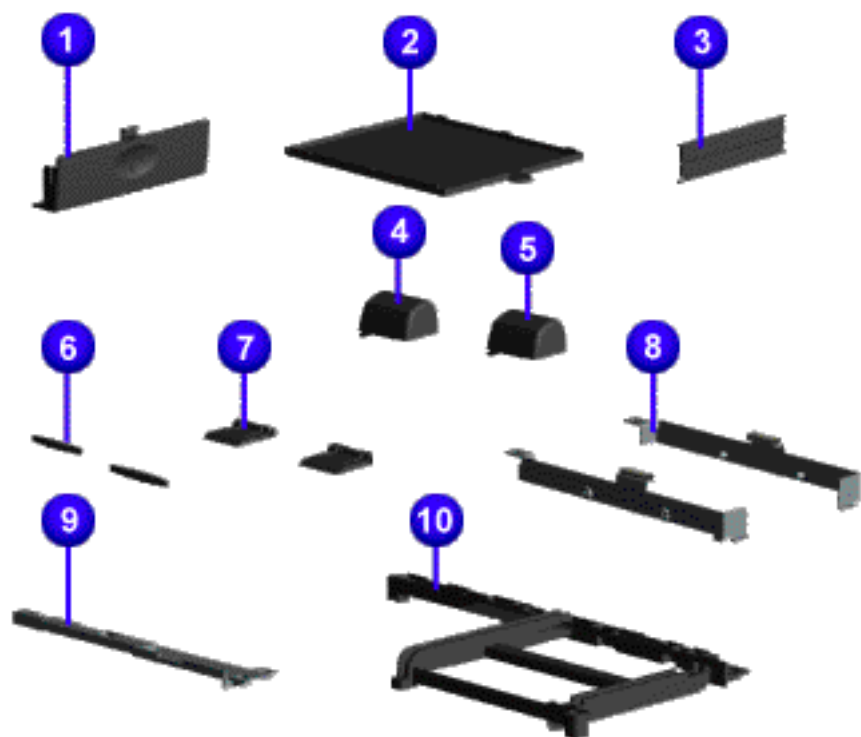

Miscellaneous Hardware Kit Spare Part Number: 293761-001	
Description	Quantity
1. Cover, Battery Pack	1 ea.
2. Cover, Memory Module	1 ea.
3. Door, PCMCIA	2 ea.
4. Hinge (Clutch) Cover, Left	1 ea.
5. Hinge (Clutch) Cover, Right	1 ea.
6. Rubber Foot	10 ea.
7. Stand Foot (plastic)	10 ea.
8. 3.2-GB/4.0-GB Hard Drive Brackets (Left/Right)	1 ea.
9. Stiffener Reinforce Frame	1 ea.
10. Stiffener Reinforce Bracket	1 ea.
Spring Torsion (Not Shown)	10 ea.
Display Assembly Screw Covers (Not Shown)	10 ea.
LCD Guide (Not Shown)	1 ea.
Stand Bracket (Not Shown)	1 ea.

[Back to top](#)

Return Kits	
Description	Quantity
Return Kit	293799-001
Carton and Buns - International	293799-002

[Back to top](#)

Maintenance & Service Guide

Presario 1600 Series Portable Computers

[Notice](#) | [Preface](#) | [Home](#) | [Product Description](#) | [Troubleshooting](#) | [Illustrated Parts Catalog](#) | [Removal & Replacement Procedures](#) | [Specifications](#) | [Connector Pin Assignments](#) | [Battery Pack](#)

Electrostatic Discharge

This chapter provides general service information for the Compaq Presario Series of portable computers. Adherence to the procedures and precautions described in this chapter is essential for proper service. The topics covered include [Electrostatic Discharge](#) and its effects, a table of activities that [Generate Static](#) and the potential voltages, ways of [Preventing Electrostatic Damage to Equipment](#), and [Preventing Damage to the Drive](#), [Grounding Methods](#), [Grounding Work Areas](#), and [Recommended Materials and Equipment](#) to use in the service area. Return to [Removal & Replacement Procedures](#).

Electrostatic Discharge

A sudden discharge of static electricity from a finger or other conductor can destroy static-sensitive devices or microcircuitry. Often the spark is neither felt nor heard, but damage occurs. An electronic device exposed to electrostatic discharge (ESD) may not be affected at all and will work perfectly throughout a normal cycle. Or it may function normally for a while, then degrade in the internal layers, reducing its life expectancy.

Networks built into many integrated circuits provide some protection, but in many cases, the discharge contains enough power to alter device parameters or melt silicon junctions.

Generating Static

The table below shows how different activities generate static electricity and at different electrostatic voltage levels.

Typical Electrostatic Voltages			
Event	Relative Humidity		
	10%	40%	55%
Walking across carpet	35,000 V	15,000 V	7,500 V
Walking across vinyl floor	12,000 V	5,000 V	3,000 V
Motions of bench worker	6,000 V	800 V	400 V
Removing DIPS from plastic tubes	2,000 V	700 V	400 V
Removing DIPS from vinyl trays	11,500 V	4,000 V	2,000 V
Removing DIPS from Styrofoam	14,500 V	5,000 V	3,500 V
Removing bubble pack from PCBs	26,000 V	20,000 V	7,000 V
Packing PCBs in foam-lined box	21,000 V	11,000 V	5,000 V
NOTE: 700 volts can degrade a product.			

Preventing Electrostatic Damage to Equipment

Many electronic components are sensitive to ESD. Circuitry design and structure determine the degree of sensitivity. The following proper packaging and grounding precautions are necessary to prevent damage:

- To avoid hand contact, transport products in the static-safe containers such as tubes, bags, or boxes.
- Protect all electrostatic parts and assemblies with conductive or approved containers or packaging.
- Keep electrostatic sensitive parts in their containers until they arrive at static-free stations.
- Place items on a grounded surface before removing them from their container.
- Always be properly grounded when touching a sensitive component or assembly.
- Place reusable electronic-sensitive parts from assemblies in protective packaging or conductive foam.
- Use transporters and conveyors made of anti-static belts and metal roller bushings. Mechanized equipment used for moving materials must be wired to ground and proper materials selected to avoid static charging. When grounding is not possible, use an ionizer to dissipate electric charges.

Preventing Damage to Drive

To prevent static damage to hard drive and diskette drive, use the following precautions:

- Handle drive gently, using static-guarding techniques.
- Store drive in the original shipping containers.
- Avoid dropping drive from any height onto any surface.
- Handle drive on surfaces that have at least one inch of shock-proof foam.
- Always place drive PCB assembly side down on the foam.

Grounding Methods

The method for grounding must include a wrist strap or a foot step at a grounded work area. When seated, wear a wrist-strap connected to a grounded system. When standing, use footstraps and a grounded floor mat.

Static-Shielding Protection Levels	
Method	Voltages
Anti-static Plastic	1,500
Carbon-Loaded Plastic	7,500
Metallized Laminate	15,000

Grounding Work Areas

To prevent static damage at the work area, use the following precautions:

- Cover the work area with approved static-dissipative material. Provide a wrist strap connected to the work surface and properly grounded tools and equipment.
- Use static-dissipative mats, Heel straps, or air ionizers to give added protection.
- Handle electrostatic sensitive parts, and assemblies by the case or PCB laminate. Handle them only at static-free work areas.
- Avoid contact with pins, leads, or circuitry.
- Turn off power and input signals before inserting and removing connectors or test equipment.
- Use fixtures made of static-safe materials when fixtures must directly contact dissipative surfaces.
- Keep work area free of nonconductive materials such as ordinary plastic assembly aids and Styrofoam.

Use field service tools, such as cutters, screwdrivers, vacuums, that are conductive.

Use a portable field service kit with a static dissipative vinyl pouch that folds out of a work mat. Also use a wrist strap and a ground cord for the work surface. Ground the cord to the chassis of the equipment undergoing test or repair.

Grounding Equipment

Use the following equipment to prevent static electricity damage to the equipment:

Wrist-straps are flexible straps with a minimum of 1 megohm +/- 10% resistance to the ground cords. To provide proper ground, a strap must be worn snug against the skin. On grounded mats without banana-plug connectors, connect a wrist strap with alligator clips.

Heelstraps/Toestraps/Bootstraps can be used at standing work areas and are compatible with most types of boots and shoes. On conductive floors or dissipative floor mats, use them on both feet with a minimum of 1 megohm resistance between operator and ground. To be effective, the conductive strips must be worn in contact with the skin.

Recommended Materials and Equipment

Other materials and equipment that are recommended for use in preventing static electricity include:

- Anti-static tape
- Anti-static smocks, aprons, or sleeve protectors
- Conductive bins, and other assembly or soldering aids
- Conductive foam
- Conductive tabletop work areas with ground cord of 1 megohm of resistance
- Static dissipative table or floor mats with hard tie to ground
- Field service kits
- Static awareness labels
- Wrist-strap and foot straps providing 1 megohm +/- 10% resistance
- Material handling packages
- Conductive plastic bags
- Conductive plastic tubes
- Conductive tote boxes
- Metal tote boxes
- Opaque shielding bags
- Transparent metallized shielding bags
- Transparent shielding tubes

[Back to top](#)

Maintenance & Service Guide

Presario 1600 Series Portable Computers

[Notice](#) | [Preface](#) | [Home](#) | [Product Description](#) | [Troubleshooting](#) | [Illustrated Parts Catalog](#)
[Removal & Replacement Procedures](#) | [Specifications](#) | [Connector Pin Assignments](#) | [Battery Pack](#)

Service Considerations

Listed below are some of the considerations that you should keep in mind during the disassembly and assembly of the computer.

Tool and Software Requirements

To service the computer, you need the following:

- Torx T-9 screwdriver
- 3/16-inch and 7/32-inch nut drivers (for screw locks and standoffs)
- Small, standard screwdriver
- Small, Phillips screwdriver
- Diagnostics software
- Service Kit

Screws

The screws used in the computer are not interchangeable. If an incorrect screw is used during the reassembly process, it can damage the unit. Compaq strongly recommends that all screws removed during disassembly be kept with the part that was removed, then returned to their proper locations.

IMPORTANT:

As each subassembly is removed from the computer, place it away from the work area to prevent damage to the subassembly.

Return to [Removal & Replacement Procedures.](#)

Maintenance & Service Guide

Presario 1600 Series Portable Computers

[Notice](#) | [Preface](#) | [Home](#) | [Product Description](#) | [Troubleshooting](#) | [Illustrated Parts Catalog](#)
[Removal & Replacement Procedures](#) | [Specifications](#) | [Connector Pin Assignments](#) | [Battery Pack](#)

Cable Positions

This section covers types of [cables](#) and installation instructions for [hard drive](#) cable, [diskette drive](#), [ZIF connectors](#), [CD cables](#) and [speaker cable](#) installation.

Cables and Connectors

Most cables used throughout the unit are ribbon cables. Cables must be handled with extreme care to avoid damage. Apply only the tension required to seat or unseat the cables during insertion or removal from the connector. Handle cables by the connector whenever possible. In all cases, avoid bending, twisting, or tearing the cables, and ensure that the cables are routed in such a way that they cannot be caught or snagged by parts being removed or replaced.

 **CAUTION:** When servicing this computer, ensure that cables are placed in their proper location during the reassembly process. Improper cable placement can damage the computer.

Cables

Use the following precautions when handling cables to avoid damage to the cable or computer:

- Always handle cables by their connectors.
- Avoid bending, twisting, or pulling on the cables.
- Apply minimum required force when seating or unseating the cables from their connectors.
- Place the cables in such a manner that they cannot be caught or snagged by parts being removed or replaced.
- Handle flex cables with extreme care; they can tear easily.

 **CAUTION:** When servicing these computers, ensure that cables are placed in their proper location during the reassembly process. Improper cable placement can cause severe damage to the unit.

Plastic Parts

Plastic parts can be damaged by the use of excessive force during disassembly and reassembly. When handling the plastic parts, use care. Apply pressure only at the points designated in the maintenance instructions.

ZIF Connectors

Compaq uses a zero insertion force (ZIF) connector for the keyboard cable to the system board. To remove a cable from a ZIF connector, lift both corners of the ZIF connector and slide simultaneously with constant light force. Then remove the cable as shown below.

 **CAUTION:** A ZIF connector and its attached cable can be easily damaged. Handle only the connector slide when removing or replacing a cable. Never pull or twist on the cable while it is connected.

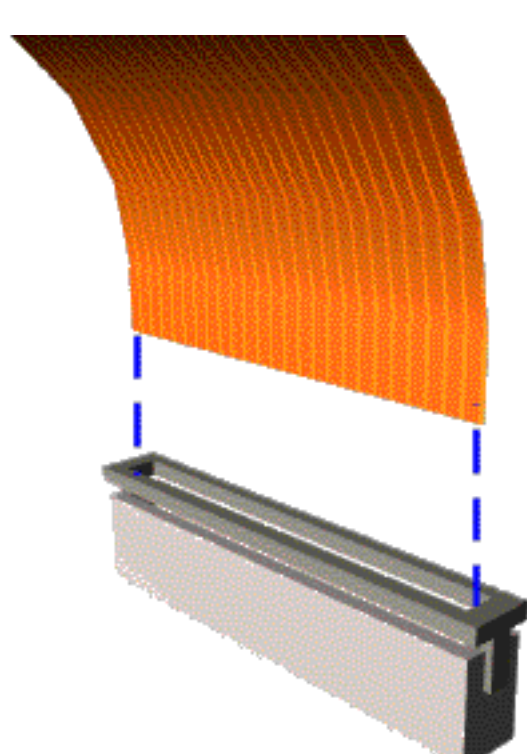

Removing a Cable from a ZIF Connector

Position the ribbon cable for the 3.2-GB or 4.0-GB [hard drive](#) as shown below.

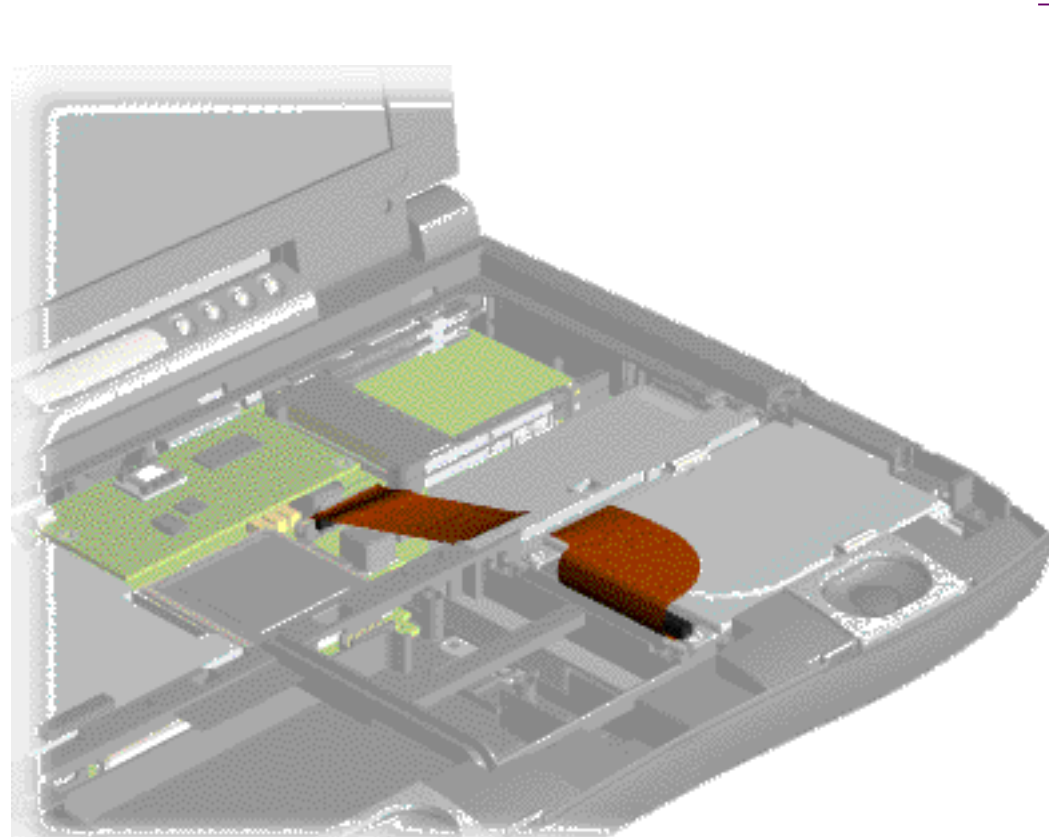

3.2-GB or 4.0-GB Hard Drive Data Cable Installation

Position the ribbon cable for the [CD drive](#) as shown below.

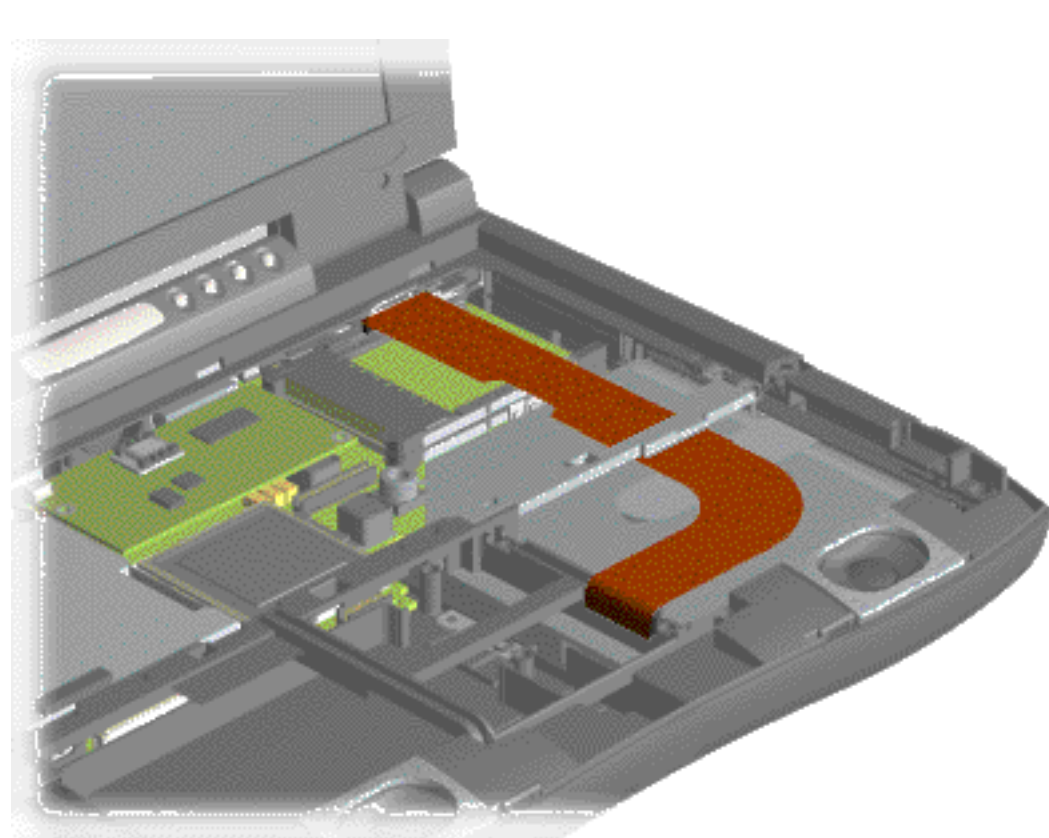

CD Drive Data Cable Installation

Position the ribbon cable for the [diskette drive](#) as shown below.

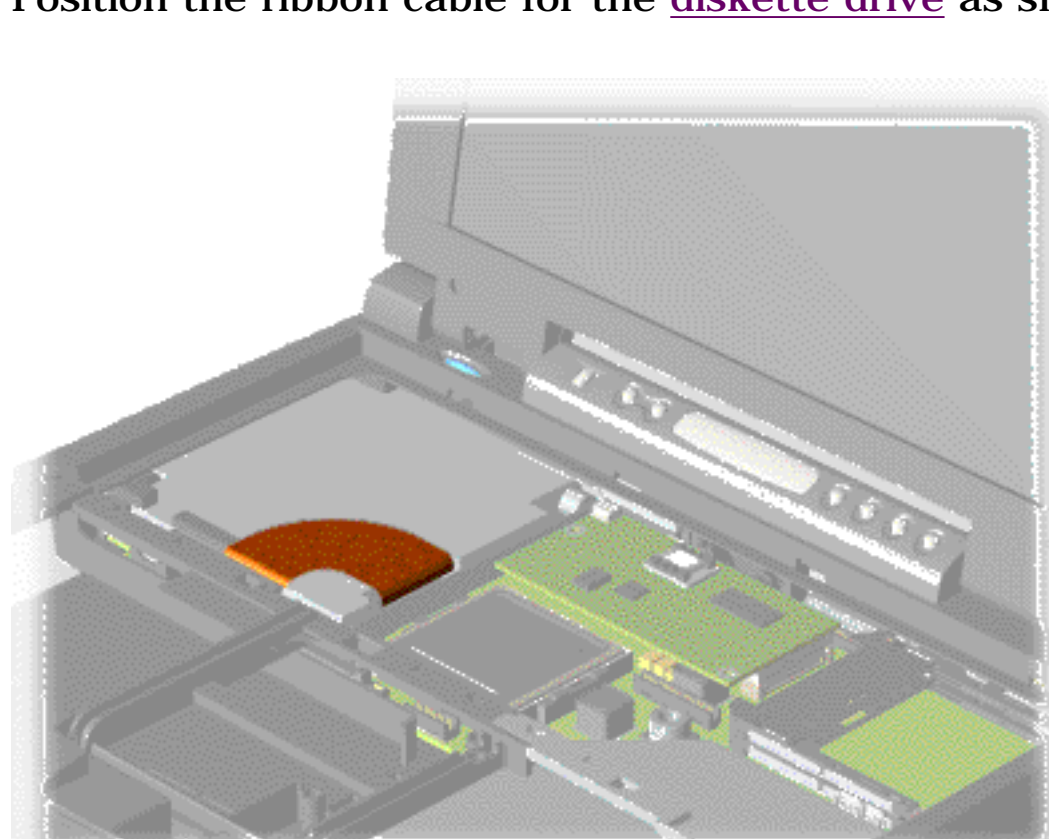

Diskette Drive Data Cable Installation

Position the cable for the [speaker assembly](#) as shown below.

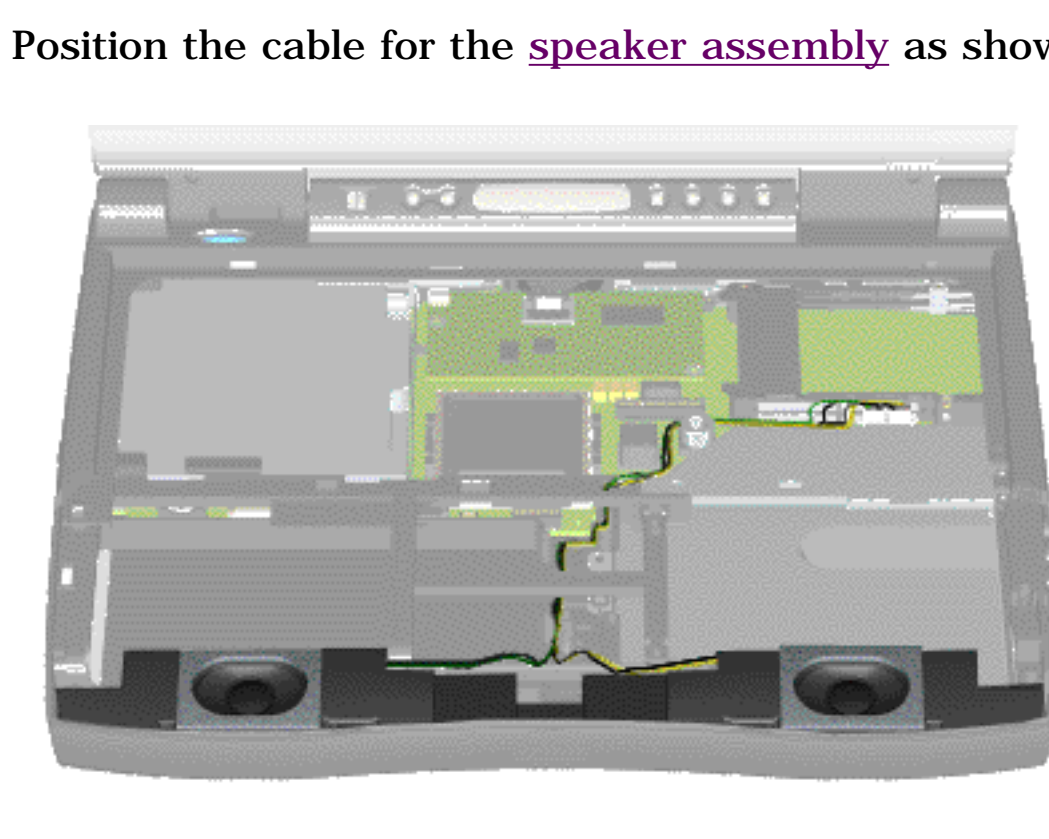

Speaker Assembly Cable Installation

Maintenance & Service Guide

Presario 1600 Series Portable Computers

[Notice](#) | [Preface](#) | [Home](#) | [Product Description](#) | [Troubleshooting](#) | [Illustrated Parts Catalog](#)
[Removal & Replacement Procedures](#) | [Specifications](#) | [Connector Pin Assignments](#) | [Battery Pack](#)

Preparing The Computer For Disassembly

Disassembly Sequence Chart

[Removing the Battery Pack](#)

[Palmrest Cover with Touch Pad](#)

[Keyboard](#)

[Heatspreader](#)

[Status Panel](#)

[Interface Board](#)

[Hard Drive](#)

[Battery Charger Board](#)

[CD Drive](#)

[Display Assembly](#)

[Plastic Subpanel Assembly](#)

[CD Drive Cable](#)

[Speaker Assembly](#)

[Modem](#)

[Diskette Drive](#)

[Fan](#)

[Audio Assembly Board](#)

[System Board](#)



[Memory Module](#)

The Compaq 1600 Series computer is a complex tool that must be disassembled in a pre-defined order. Failure to adhere to the order can cause damage to the unit. Start with this screen and work through the screens until the task is complete. Then work through the screens in reverse order to reassemble the computer.

NOTE: Remove the battery pack before performing any internal maintenance on the computer.

To prepare the computer for disassembly, complete the following steps:

- Disconnect AC power and any external devices
- Remove the battery pack
- Remove any PC Cards

	WARNING: Metal objects can damage the battery pack as well as the battery contacts in the battery compartment. To prevent damage, do not allow metal objects to touch the battery contacts. Place only the battery pack for the Compaq Presario 1600 Series Portable Computers into the battery compartment. Do not force the battery pack into the bay if insertion does not occur easily.
	CAUTION: Do not crush, puncture, or incinerate the battery pack. Do not open a battery pack, as this damages the pack, makes it unusable, and exposes potentially harmful battery components. There are no field-serviceable parts located inside the battery pack.

NOTE: Compaq Presario 1600 Series Portable Computers have several screws of various sizes which are **not** interchangeable. Ensure that the correct screws are used in their correct location. During removal please keep respective screws with their associate sub-assembly.

[Back to top](#)

Maintenance & Service Guide

Presario 1600 Series Portable Computers

[Notice](#) | [Preface](#) | [Home](#) | [Product Description](#) | [Troubleshooting](#) | [Illustrated Parts Catalog](#)
[Removal & Replacement Procedures](#) | [Specifications](#) | [Connector Pin Assignments](#) | [Battery Pack](#)

Removing the Battery Pack

[Removing the Battery Pack](#)

[Palmrest](#)

[Cover with Touch Pad](#)

[Keyboard](#)

[Heatspreader](#)

[Status Panel](#)

[Interface Board](#)

[Hard Drive](#)

[Battery Charger Board](#)

[CD Drive](#)

[Display Assembly](#)

[Plastic Subpanel Assembly](#)

[CD Drive Cable](#)

[Speaker Assembly](#)

[Modem](#)

[Diskette Drive](#)

[Fan](#)

[Audio Assembly Board](#)

[System Board](#)

[Memory Module](#)

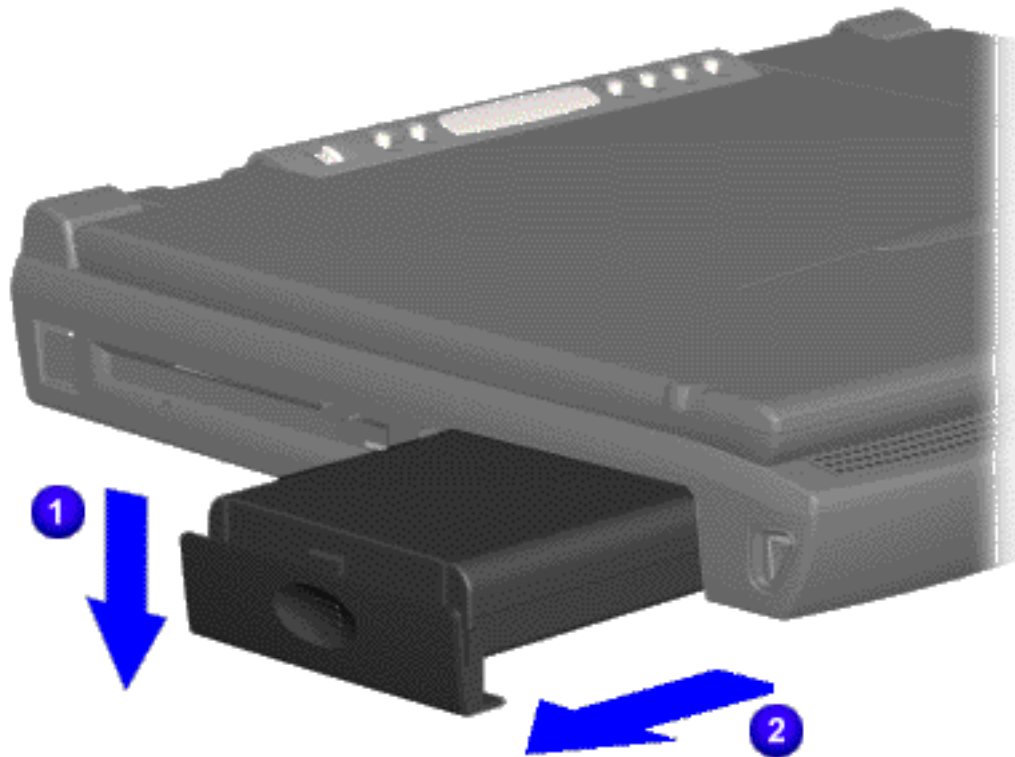

Removing the Battery Pack

To remove the battery pack, complete the following steps:

1. Slide the battery door down **1**.

2. Slide the battery pack compartment door down and pull out the battery pack **2**.

3. To replace the battery pack, reverse the removal procedure.

Back to [Preparing the Computer for Disassembly](#)

Maintenance & Service Guide

Presario 1600 Series Portable Computers

[Notice](#) | [Preface](#) | [Home](#) | [Product Description](#) | [Troubleshooting](#) | [Illustrated Parts Catalog](#)
[Removal & Replacement Procedures](#) | [Specifications](#) | [Connector Pin Assignments](#) | [Battery Pack](#)

Removing The Palmrest Cover with Touch Pad

The palmrest cover with touch pad is the first component to be removed to gain access to any of the interior components of the computer.

NOTE: It is not necessary to remove the display panel assembly to access the interior components of the computer.

[Removing the Battery Pack](#)

[Palmrest Cover with Touch Pad](#)

[Keyboard](#)

[Heatspreader](#)

[Status Panel](#)

[Interface Board](#)

[Hard Drive](#)

[Battery](#)

[Charger Board](#)

[CD Drive](#)

[Display Assembly](#)

[Plastic Subpanel Assembly](#)

[CD Drive Cable](#)

[Speaker Assembly](#)

[Modem](#)

[Diskette Drive](#)

[Fan](#)

[Audio Assembly Board](#)

[System Board](#)

[Memory Module](#)

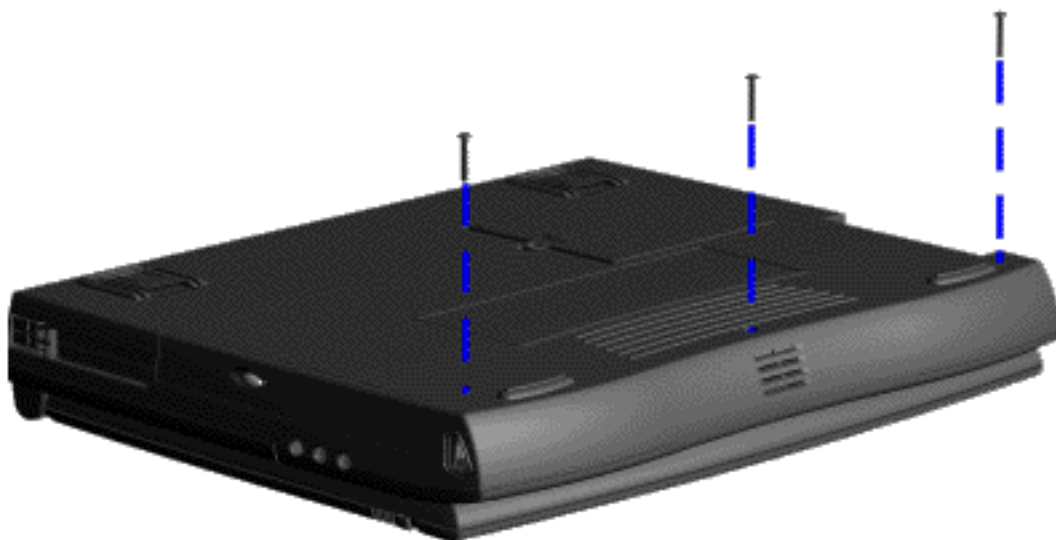

Removing the Screws from the Palmrest Cover with Touch Pad

To remove the palmrest cover with touch pad, complete the following steps:

1. [Prepare the Computer for Disassembly.](#)

2. Close the computer and turn the computer upside down.

3. Remove the three screws from the bottom of the computer as shown.

[Next](#)

Maintenance & Service Guide

Presario 1600 Series Portable Computers

[Notice](#) | [Preface](#) | [Home](#) | [Product Description](#) | [Troubleshooting](#) | [Illustrated Parts Catalog](#)
[Removal & Replacement Procedures](#) | [Specifications](#) | [Connector Pin Assignments](#) | [Battery Pack](#)

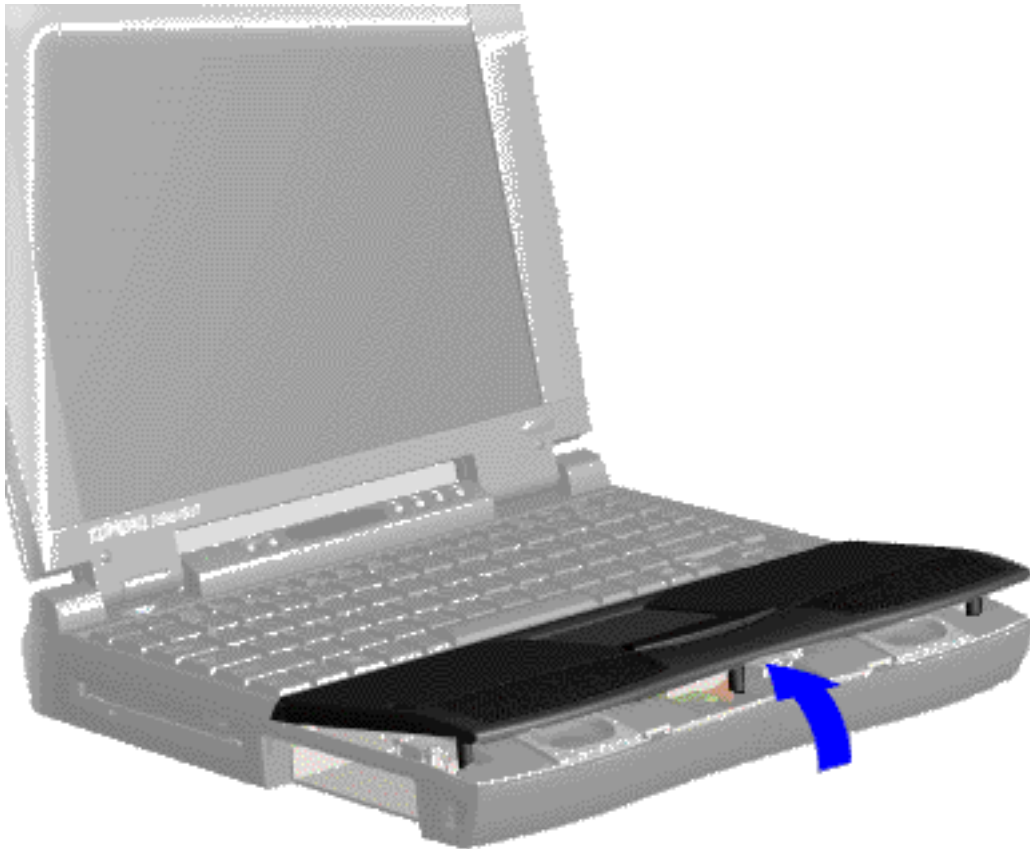

4. Turn the computer over (right side up), pull forward on the display latches to release and open the display assembly.

5. Lift up the front end of the palmrest cover with touch pad and remove it from the groove in the chassis as shown.

[Next](#)

Maintenance & Service Guide

Presario 1600 Series Portable Computers

[Notice](#) | [Preface](#) | [Home](#) | [Product Description](#) | [Troubleshooting](#) | [Illustrated Parts Catalog](#)
[Removal & Replacement Procedures](#) | [Specifications](#) | [Connector Pin Assignments](#) | [Battery Pack](#)

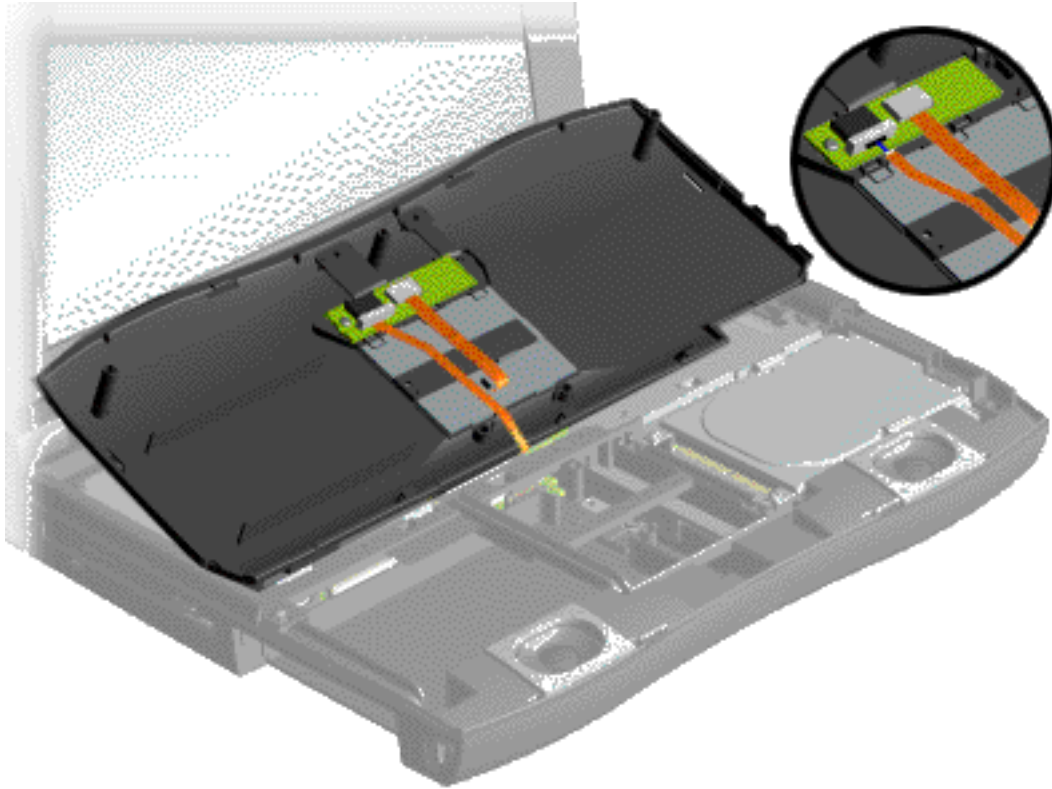

6. Tilt the palmrest cover with touch pad back, allowing it to rest on top of the keyboard, and disconnect the flex cable from the LIF connector on the palmrest cover as shown.

To replace the palmrest cover with touch pad, reverse the removal procedure.

[Back to Preparing the Computer for Disassembly](#)

[Disconnecting the Palmrest Cover with Touch Pad](#)



CAUTION: When replacing the palmrest cover with touch pad, ensure that the cable is fully inserted into the LIF connector on the system board. If metal end should come in contact with the keyboard, damage may occur to the computer.

Maintenance & Service Guide

Presario 1600 Series Portable Computers

[Notice](#) | [Preface](#) | [Home](#) | [Product Description](#) | [Troubleshooting](#) | [Illustrated Parts Catalog](#)
[Removal & Replacement Procedures](#) | [Specifications](#) | [Connector Pin Assignments](#) | [Battery Pack](#)

Removing The Keyboard

NOTE:

To remove a cable from a ZIF connector, lift both corners of the ZIF connector and slide simultaneously with constant light force. Then remove the cable.

[Removing the Battery Pack](#)

[Palmrest Cover with Touch Pad](#)

[Keyboard](#)

[Heatspreader](#)

[Status Panel](#)

[Interface Board](#)

[Hard Drive](#)

[Battery Charger Board](#)

[CD Drive](#)

[Display Assembly](#)

[Plastic Subpanel Assembly](#)

[CD Drive Cable](#)

[Speaker Assembly](#)

[Modem](#)

[Diskette Drive](#)

[Fan](#)

[Audio Assembly Board](#)

[System Board](#)

[Memory Module](#)

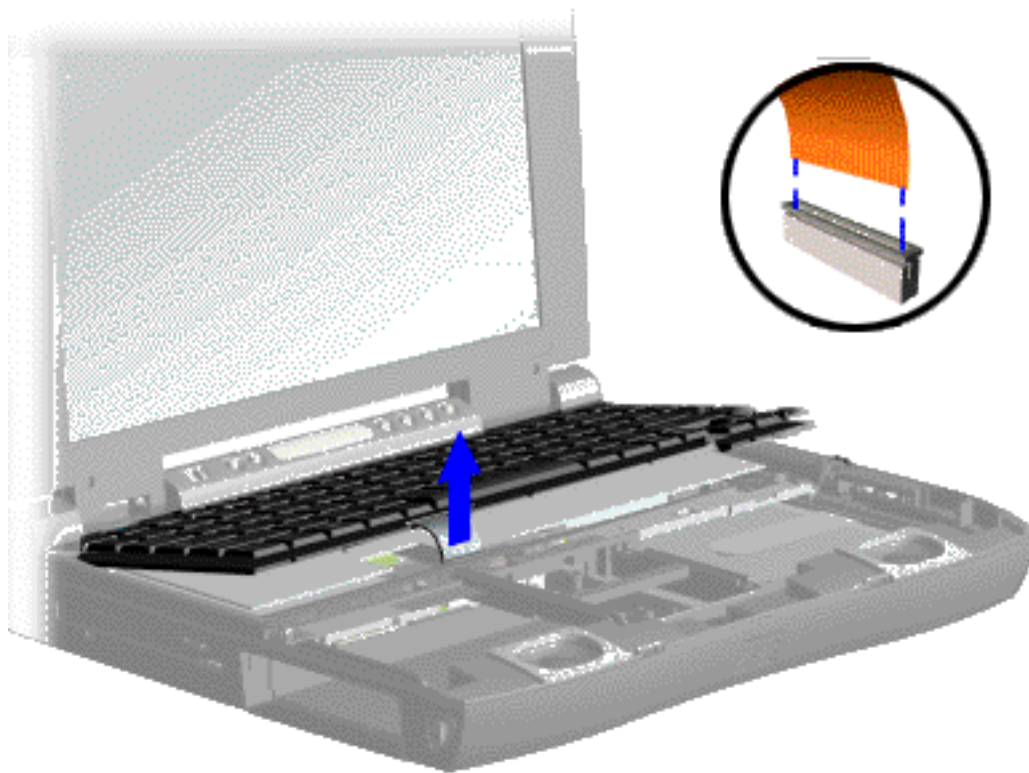

[Disconnecting the Flex Cable from the ZIF Connector on the System Board](#)

1. [Prepare the computer for disassembly](#)

2. [Remove the palmrest cover with touch pad](#)

3. Gently lift the front of the keyboard up, and disconnect the flex cable from the ZIF connector on the system board.

[Next](#)

Maintenance & Service Guide

Presario 1600 Series Portable Computers

[Notice](#) | [Preface](#) | [Home](#) | [Product Description](#) | [Troubleshooting](#) | [Illustrated Parts Catalog](#)
[Removal & Replacement Procedures](#) | [Specifications](#) | [Connector Pin Assignments](#) | [Battery Pack](#)

NOTE:

Use a pair of tweezers to properly replace the cable inside of the ZIF connector.

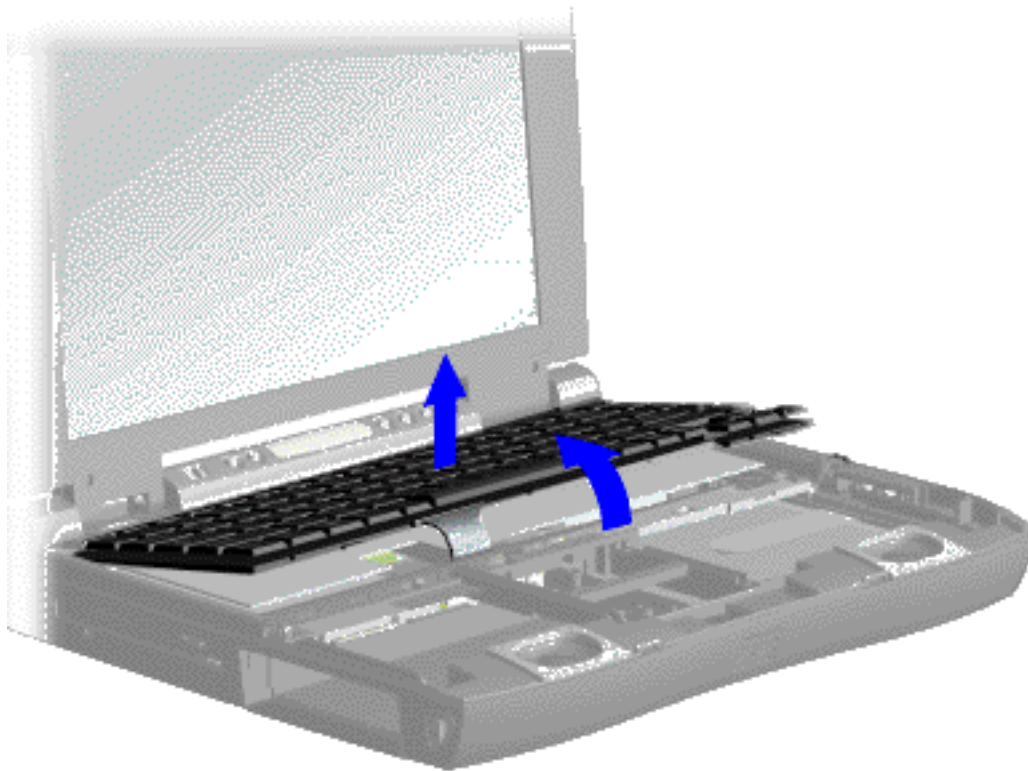

4. Lift the keyboard out of the chassis as shown.

To replace the keyboard, reverse the previous procedures.

[Back to Preparing the Computer for Disassembly](#)

[Removing the Keyboard](#)

Maintenance & Service Guide

Presario 1600 Series Portable Computers

[Notice](#) | [Preface](#) | [Home](#) | [Product Description](#) | [Troubleshooting](#) | [Illustrated Parts Catalog](#)
[Removal & Replacement Procedures](#) | [Specifications](#) | [Connector Pin Assignments](#) | [Battery Pack](#)

Removing The Heatspreader

[Removing the Battery Pack](#)
[Palmrest Cover with Touch Pad](#)
[Keyboard](#)
[Heatspreader](#)
[Status Panel](#)
[Interface Board](#)
[Hard Drive](#)
[Battery Charger Board](#)
[CD Drive](#)
[Display Assembly](#)
[Plastic Subpanel Assembly](#)
[CD Drive Cable](#)
[Speaker Assembly](#)
[Modem](#)
[Diskette Drive](#)
[Fan](#)
[Audio Assembly Board](#)
[System Board](#)
[Memory Module](#)

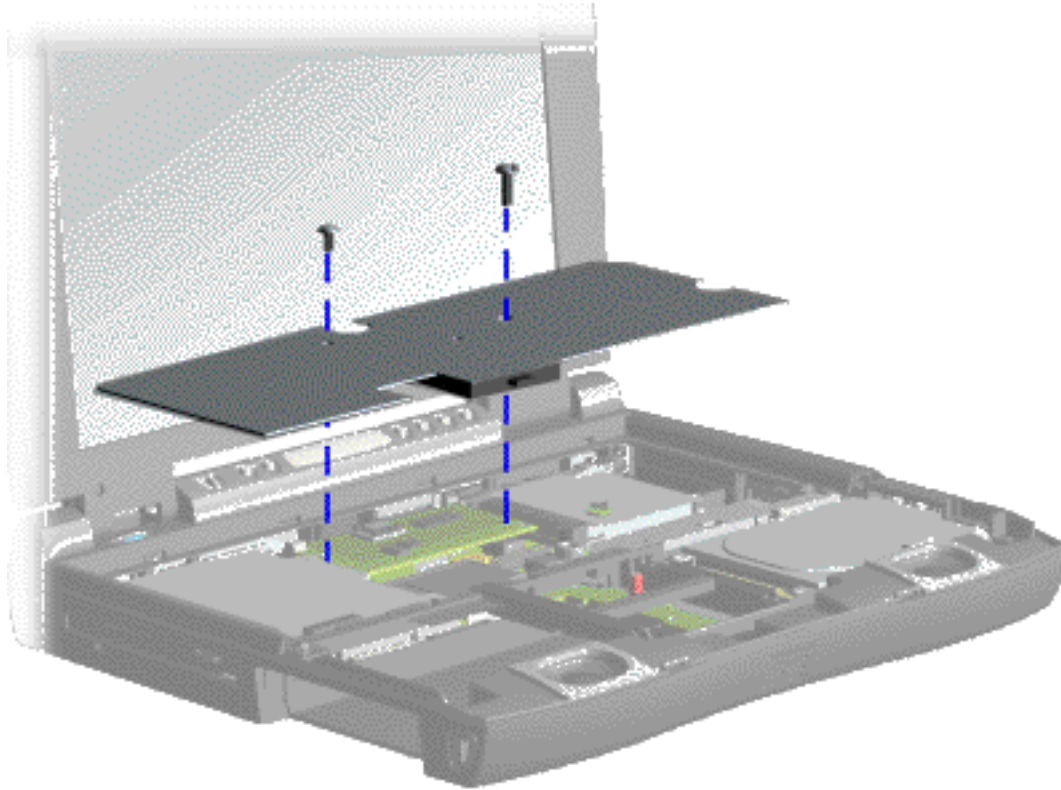

Removing Screws and Heatspreader

1. [Prepare the computer for disassembly.](#)
2. [Remove the palmrest cover with touch pad.](#)
3. [Remove the keyboard.](#)
4. Remove two screws from the heatspreader and lift out of the chassis as shown.

To replace the heatspreader, reverse the removal procedures.

[Back to Preparing the Computer for Disassembly](#)

Maintenance & Service Guide

Presario 1600 Series Portable Computers

[Notice](#) | [Preface](#) | [Home](#) | [Product Description](#) | [Troubleshooting](#) | [Illustrated Parts Catalog](#)
[Removal & Replacement Procedures](#) | [Specifications](#) | [Connector Pin Assignments](#) | [Battery Pack](#)

Removing The Status Panel



1. [Prepare the computer for disassembly.](#)

2. [Remove the palmrest cover with touch pad.](#)

3. [Remove the keyboard.](#)

4. Move the lever (located directly below the CD Play button on the status panel) to the right to release the status panel cover.

5. Support the front bottom corners of the status panel with the thumb and forefinger. Rotate and push the status panel backwards off the chassis as shown below.

[Next](#)

[Removing the Battery Pack](#)
[Palmrest Cover with Touch Pad](#)
[Keyboard](#)
[Heatspreader](#)
[Status Panel](#)

[Interface Board](#)
[Hard Drive](#)
[Battery Charger Board](#)
[CD Drive](#)
[Display Assembly](#)
[Plastic Subpanel Assembly](#)
[CD Drive Cable](#)
[Speaker Assembly](#)
[Modem](#)
[Diskette Drive](#)
[Fan](#)
[Audio Assembly Board](#)
[System Board](#)
[Memory Module](#)

Releasing and Removing the Status Panel Cover

NOTE:

When replacing the status panel ensure all cables are properly replaced under the status panel and not obstructing the status panel replacement.

Maintenance & Service Guide

Presario 1600 Series Portable Computers

[Notice](#) | [Preface](#) | [Home](#) | [Product Description](#) | [Troubleshooting](#) | [Illustrated Parts Catalog](#)
[Removal & Replacement Procedures](#) | [Specifications](#) | [Connector Pin Assignments](#) | [Battery Pack](#)

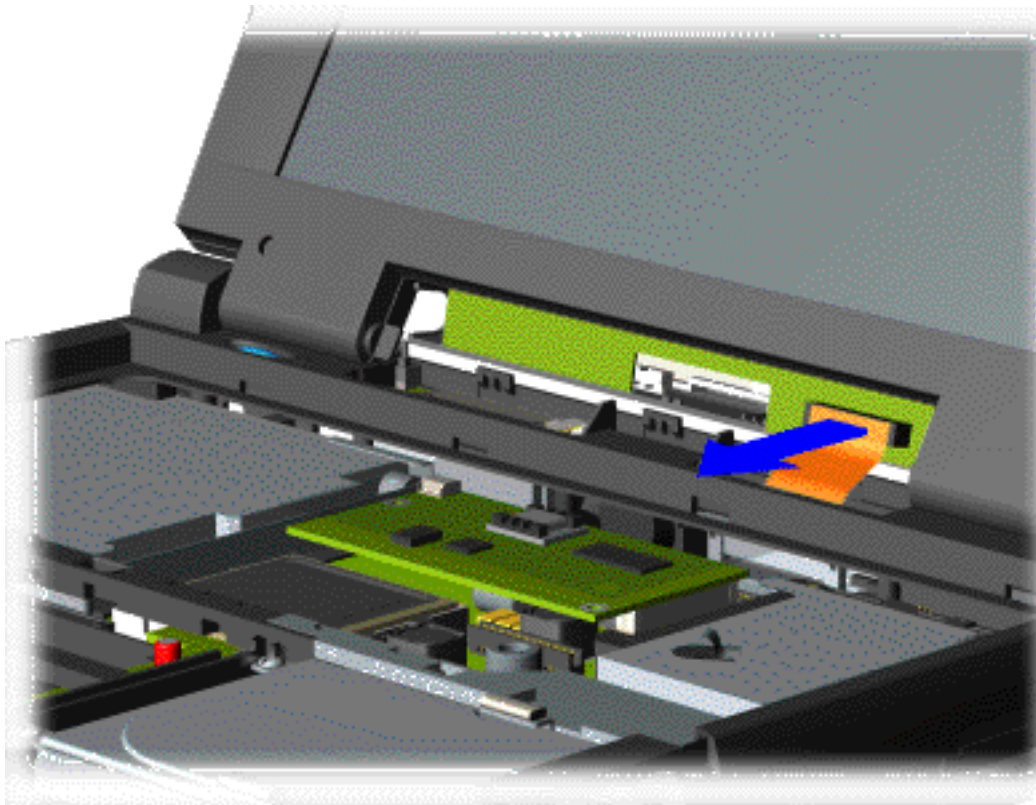

6. Disconnect the flex cable from the connector on the status panel header as shown below.

To replace the status panel, reverse the removal procedures.

[Back to Preparing the Computer for Disassembly](#)

[Disconnecting the Flex Cable from the Connector on the Status Panel Header](#)

Maintenance & Service Guide

Presario 1600 Series Portable Computers

[Notice](#) | [Preface](#) | [Home](#) | [Product Description](#) | [Troubleshooting](#) | [Illustrated Parts Catalog](#)
[Removal & Replacement Procedures](#) | [Specifications](#) | [Connector Pin Assignments](#) | [Battery Pack](#)

Removing The Interface Board

[Removing the Battery Pack](#)

[Palmrest Cover with Touch Pad](#)

[Keyboard](#)

[Heatspreader](#)

[Status Panel](#)

[Interface Board](#)

[Hard Drive](#)

[Battery Charger Board](#)

[CD Drive](#)

[Display Assembly](#)

[Plastic Subpanel Assembly](#)

[CD Drive Cable](#)

[Speaker Assembly](#)

[Modem](#)

[Diskette Drive](#)

[Fan](#)

[Audio Assembly Board](#)

[System Board](#)

[Memory Module](#)

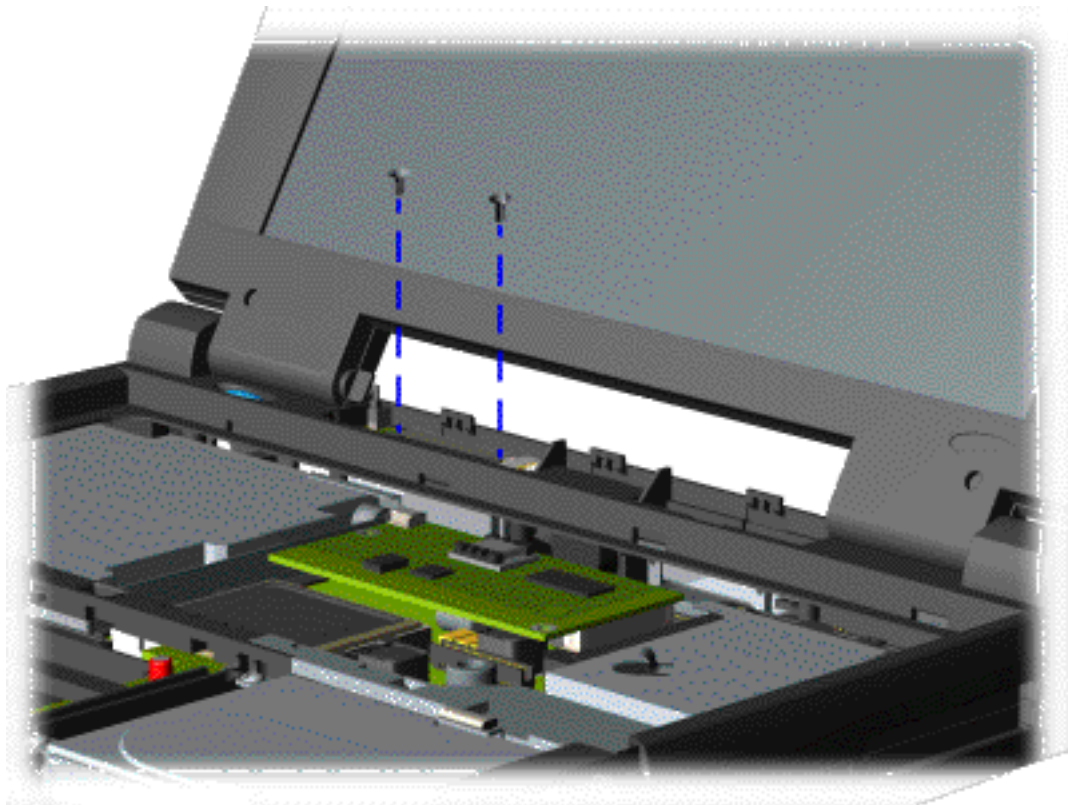

Removing the Screws from the Interface Board

1. [Prepare the computer for disassembly.](#)

2. [Remove the palmrest cover with touch pad.](#)

3. [Remove the keyboard.](#)

4. [Remove the status panel.](#)

5. Remove the two screws from the interface board as shown.

[Next](#)

Maintenance & Service Guide

Presario 1600 Series Portable Computers

[Notice](#) | [Preface](#) | [Home](#) | [Product Description](#) | [Troubleshooting](#) | [Illustrated Parts Catalog](#)
[Removal & Replacement Procedures](#) | [Specifications](#) | [Connector Pin Assignments](#) | [Battery Pack](#)

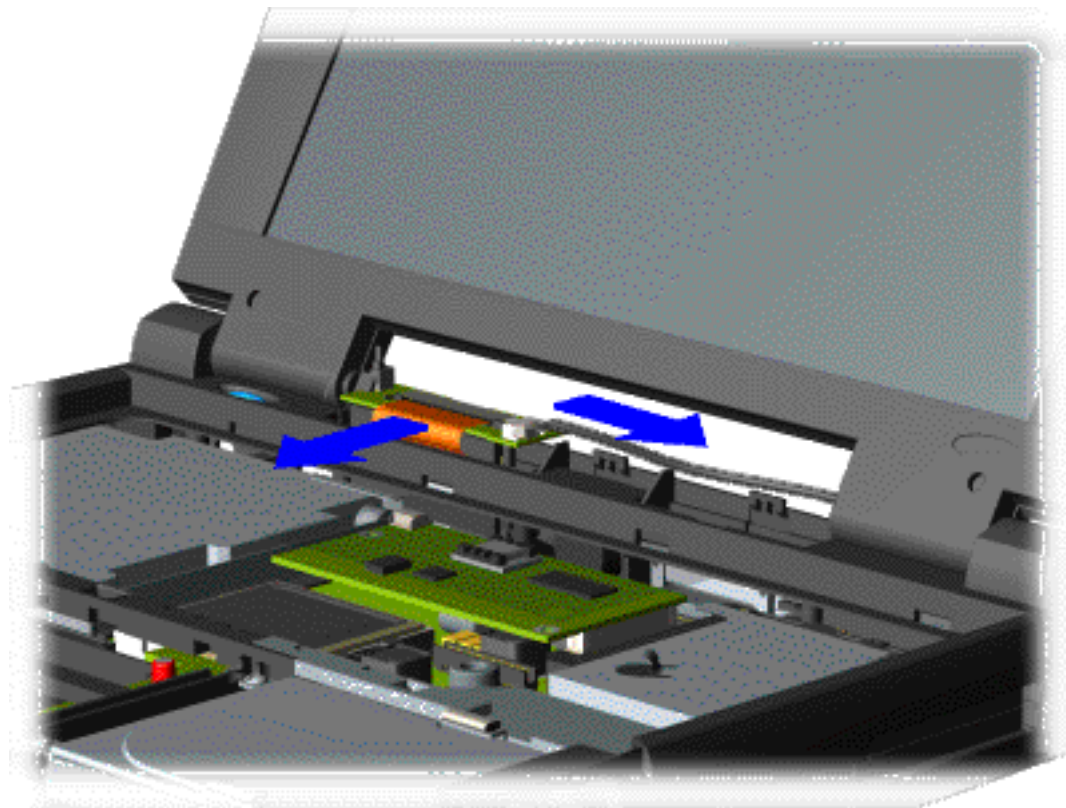

6. Slightly lift the interface board, disconnect the ZIF connector, and backlight power cable from the interface board as shown.

[Next](#)

[Disconnecting the ZIF Connector and Backlight Power Cable from the Interface Board](#)

Maintenance & Service Guide

Presario 1600 Series Portable Computers

[Notice](#) | [Preface](#) | [Home](#) | [Product Description](#) | [Troubleshooting](#) | [Illustrated Parts Catalog](#)
[Removal & Replacement Procedures](#) | [Specifications](#) | [Connector Pin Assignments](#) | [Battery Pack](#)

IMPORTANT:

When removing the interface board with the header attached occasionally the header will remain attached to the system board. If this occurs when removing the interface board with the header attached, separate the header from the connector on the system board.

NOTE:

When replacing interface board ensure both connectors on the board are properly seated.

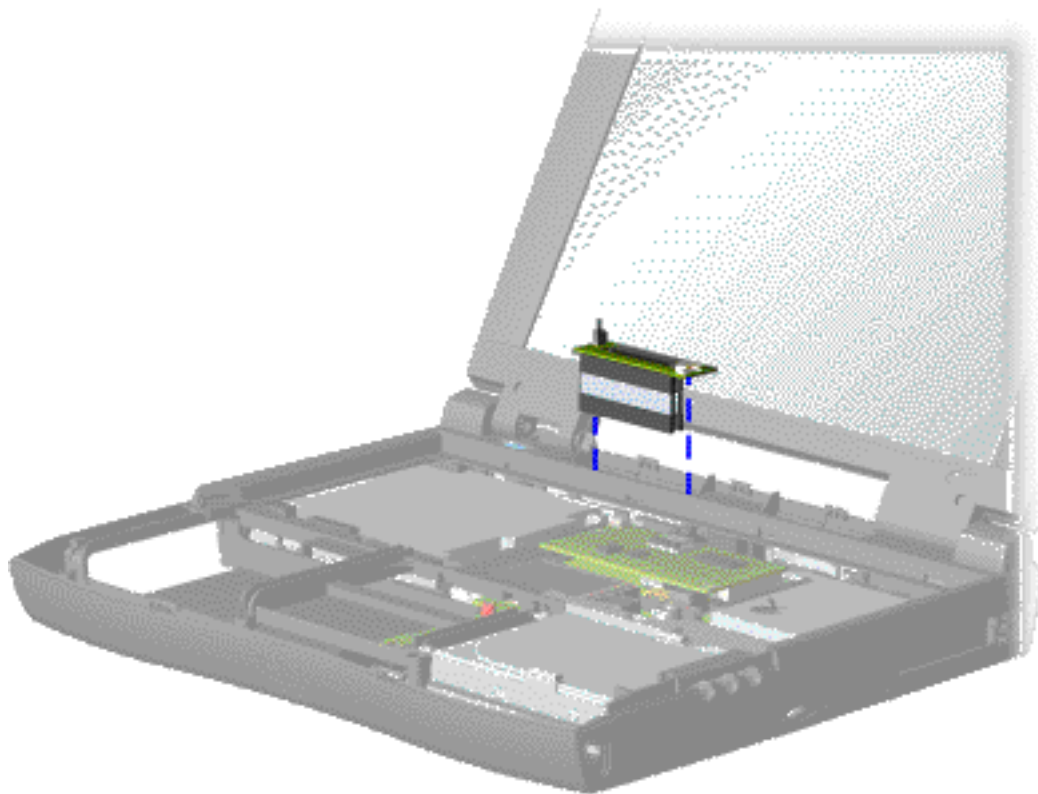

7. Lift the interface board up with the header attached from the system board as shown.

To replace the interface board, reverse the previous procedures.

[An illustration of locations of connectors on the interface board.](#)

[Back to Preparing the Computer for Disassembly](#)

[Removing the Interface Board with Header Attached](#)

Maintenance & Service Guide

Presario 1600 Series Portable Computers

[Notice](#) | [Preface](#) | [Home](#) | [Product Description](#) | [Troubleshooting](#) | [Illustrated Parts Catalog](#)
[Removal & Replacement Procedures](#) | [Specifications](#) | [Connector Pin Assignments](#) | [Battery Pack](#)

Interface Board

This page shows an Illustration and table of the locations of the connectors on the interface board.

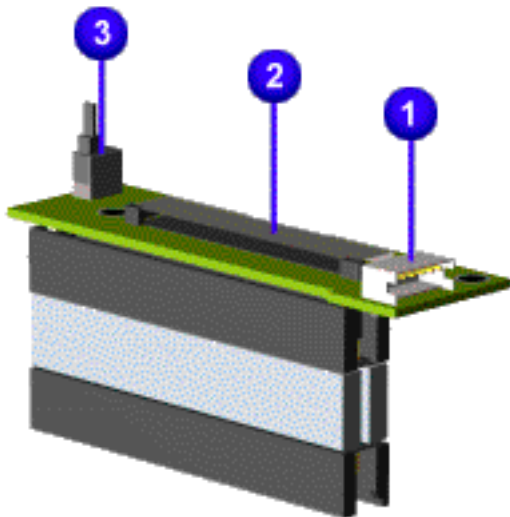

Interface Board Components	
Designator	Connector
1. JP1	Backlight Switch
2. JP3	Display Interface ZIF
3. JP4	Inverter/Backlight LIF Connector
4. None	Interface Header

[Interface Board Components](#)

[Back to Preparing the Computer for Disassembly](#)

Maintenance & Service Guide

Presario 1600 Series Portable Computers

[Notice](#) | [Preface](#) | [Home](#) | [Product Description](#) | [Troubleshooting](#) | [Illustrated Parts Catalog](#)
[Removal & Replacement Procedures](#) | [Specifications](#) | [Connector Pin Assignments](#) | [Battery Pack](#)

Removing The Hard Drive

[Removing the Battery Pack](#)

[Palmrest Cover with Touch Pad](#)

[Keyboard](#)

[Heatspreader](#)

[Status Panel](#)

[Interface Board](#)

[Hard Drive](#)

[Battery Charger Board](#)

[CD Drive](#)

[Display Assembly](#)

[Plastic Subpanel Assembly](#)

[CD Drive Cable](#)

[Speaker Assembly](#)

[Modem](#)

[Diskette Drive](#)

[Fan](#)

[Audio Assembly Board](#)

[System Board](#)

[Memory Module](#)

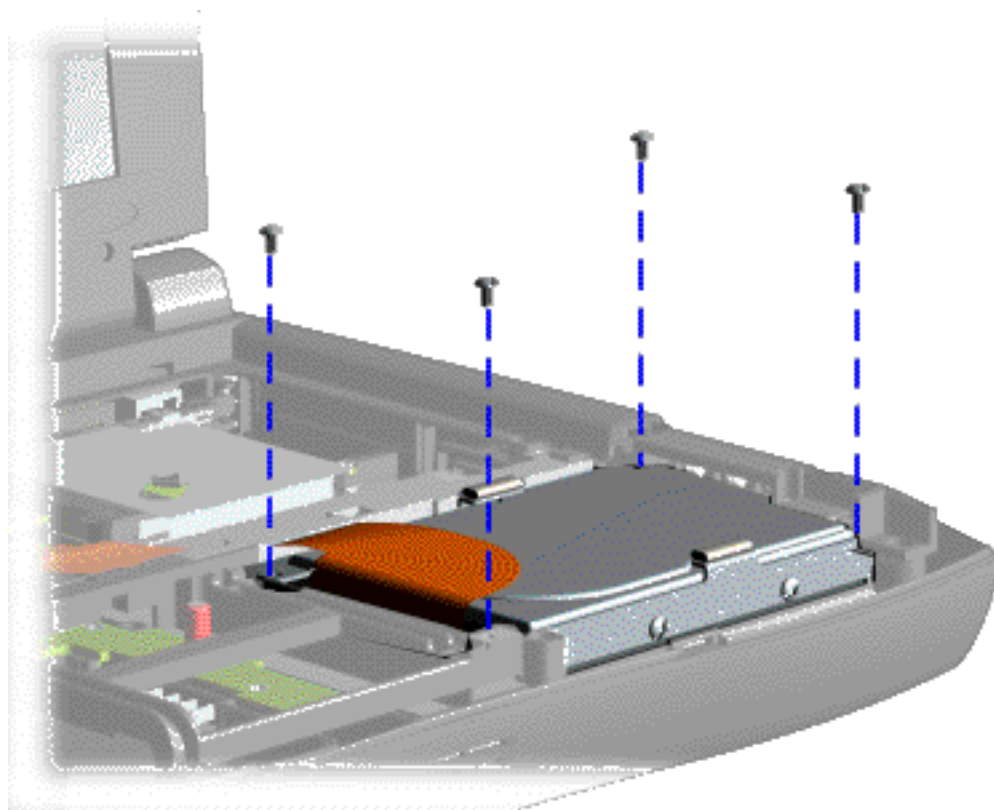

Removing the 3.2-GB or 4.0-GB Hard Drive with Mounting Bracket Attached

1. [Prepare the computer for disassembly.](#)

2. [Remove the palmrest cover with touch pad.](#)

3. Remove four screws from the hard drive mounting bracket and lift the hard drive with hard drive mounting bracket attached out of the chassis as shown.

[Next](#)

Maintenance & Service Guide

Presario 1600 Series Portable Computers

[Notice](#) | [Preface](#) | [Home](#) | [Product Description](#) | [Troubleshooting](#) | [Illustrated Parts Catalog](#)
[Removal & Replacement Procedures](#) | [Specifications](#) | [Connector Pin Assignments](#) | [Battery Pack](#)

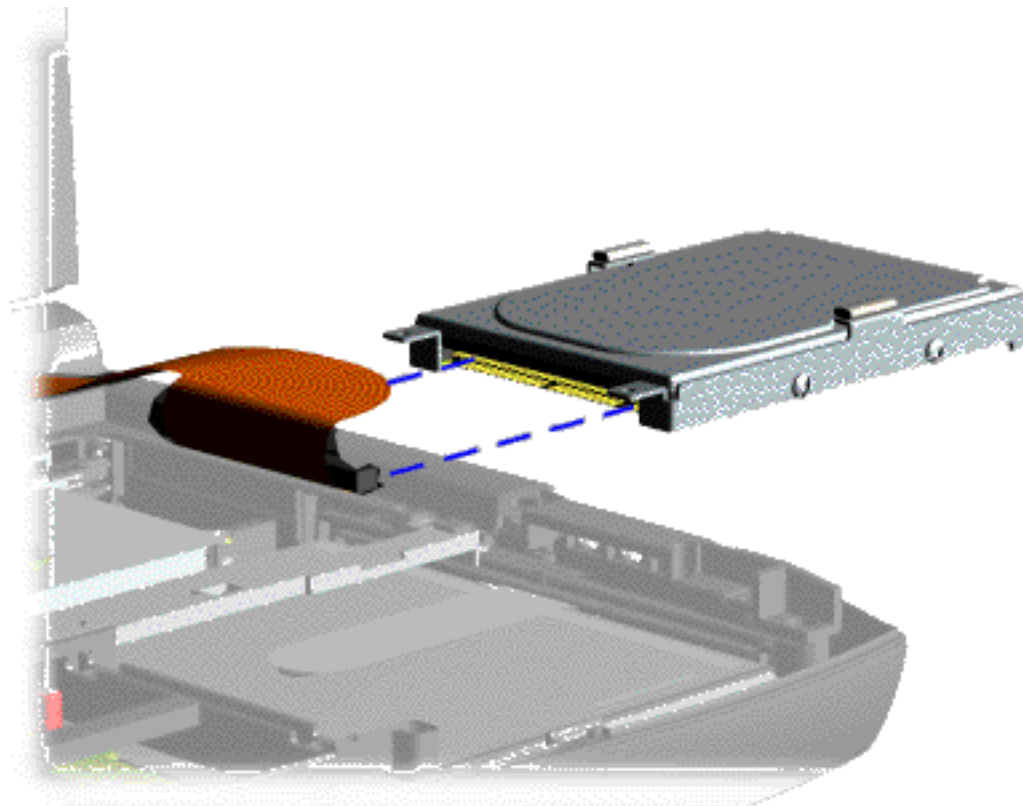

4. Disconnect the hard drive data cable from the hard drive as shown.

To replace the hard drive, reverse the previous procedures.

[Back to Preparing the Computer for Disassembly.](#)

[Disconnecting the Hard Drive Data Cable from the Hard Drive](#)

Maintenance & Service Guide

Presario 1600 Series Portable Computers

[Notice](#) | [Preface](#) | [Home](#) | [Product Description](#) | [Troubleshooting](#) | [Illustrated Parts Catalog](#)
[Removal & Replacement Procedures](#) | [Specifications](#) | [Connector Pin Assignments](#) | [Battery Pack](#)

Removing The Battery Charger Board

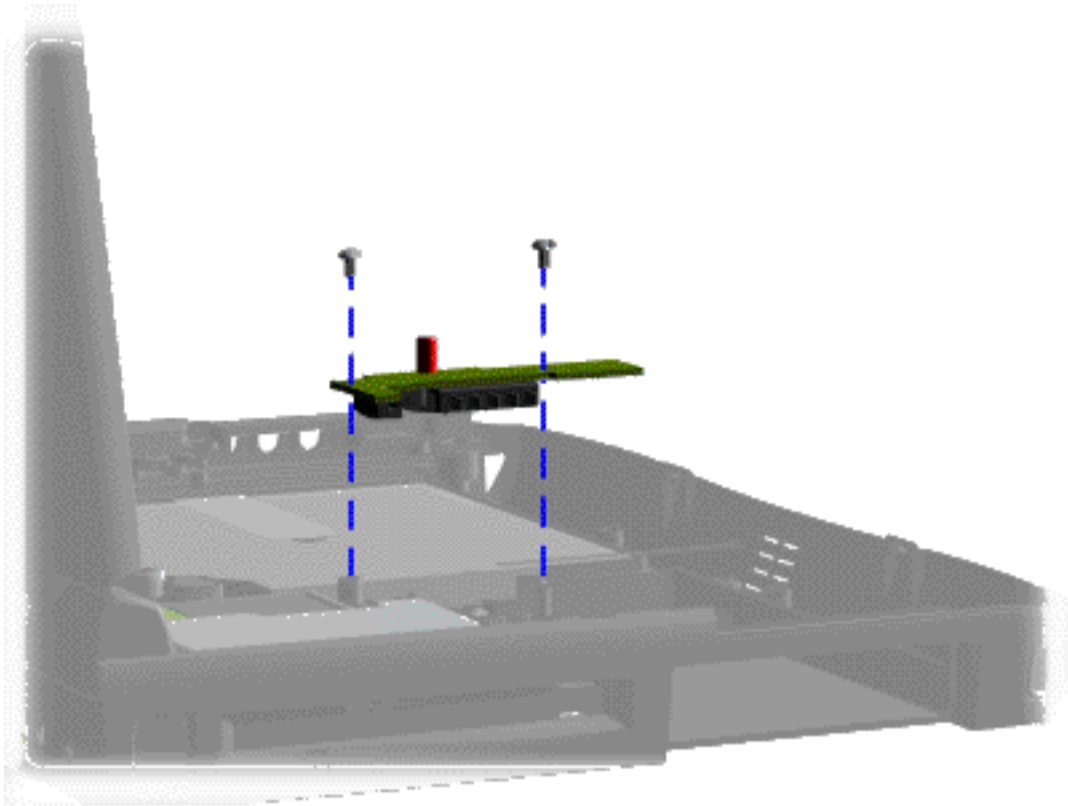

[Removing the Screws and the Battery Charger Board](#)

1. [Prepare the computer for disassembly.](#)

2. [Remove the palmrest cover with touch pad.](#)

3. [Remove the keyboard.](#)

4. [Remove the hard drives](#)

5. [Remove the stiffener bracket.](#)

6. Remove the two screws from the battery charger board, unplug the board from the system board, and lift out of the chassis as shown.

[Back to Preparing the Computer for Disassembly](#)

[Removing the Battery Pack](#)

[Palmrest Cover with Touch Pad](#)

[Keyboard](#)

[Heatspreader](#)

[Status Panel](#)

[Interface Board](#)

[Hard Drive](#)

[Battery Charger Board](#)

[CD Drive](#)

[Display Assembly](#)

[Plastic Subpanel Assembly](#)

[CD Drive Cable](#)

[Speaker Assembly](#)

[Modem](#)

[Diskette Drive](#)

[Fan](#)

[Audio Assembly Board](#)

[System Board](#)

[Memory Module](#)

NOTE:

When replacing the battery charger board, ensure the pins are aligned with the connector on the system board.

Maintenance & Service Guide

Presario 1600 Series Portable Computers

[Notice](#) | [Preface](#) | [Home](#) | [Product Description](#) | [Troubleshooting](#) | [Illustrated Parts Catalog](#)
[Removal & Replacement Procedures](#) | [Specifications](#) | [Connector Pin Assignments](#) | [Battery Pack](#)

Removing The CD Drive

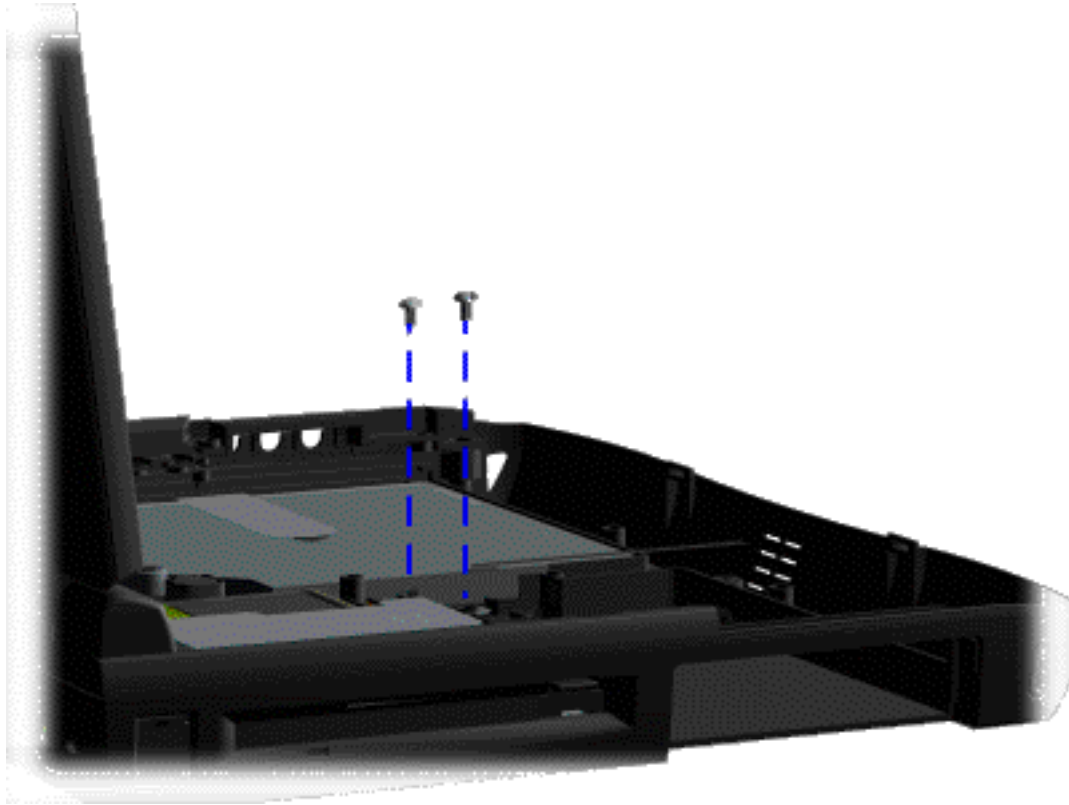

[Removing the Battery Pack](#)
[Palmrest Cover with Touch Pad](#)
[Keyboard](#)
[Heatspreader](#)
[Status Panel](#)
[Interface Board](#)
[Hard Drive](#)
[Battery Charger Board](#)
[CD Drive](#)
[Display Assembly](#)
[Plastic Subpanel Assembly](#)
[CD Drive Cable](#)
[Speaker Assembly](#)
[Modem](#)
[Diskette Drive](#)
[Fan](#)
[Audio Assembly Board](#)
[System Board](#)
[Memory Module](#)

Removing the Screws from the CD Drive

1. [Prepare the computer for disassembly](#)
2. [Remove the palmrest cover with touch pad.](#)
3. [Remove the keyboard.](#)
4. [Remove the hard drives.](#)
5. [Remove the stiffener bracket.](#)
6. [Remove the battery charger board.](#)
7. Remove the screw securing the PCMCIA shield.
8. Remove two screws located at the back CD drive and remove the hard drive cable shield as shown.

[Next](#)

Maintenance & Service Guide

Presario 1600 Series Portable Computers

[Notice](#) | [Preface](#) | [Home](#) | [Product Description](#) | [Troubleshooting](#) | [Illustrated Parts Catalog](#)
[Removal & Replacement Procedures](#) | [Specifications](#) | [Connector Pin Assignments](#) | [Battery Pack](#)

9. Open the CD drive tray using a small paper clip as shown.

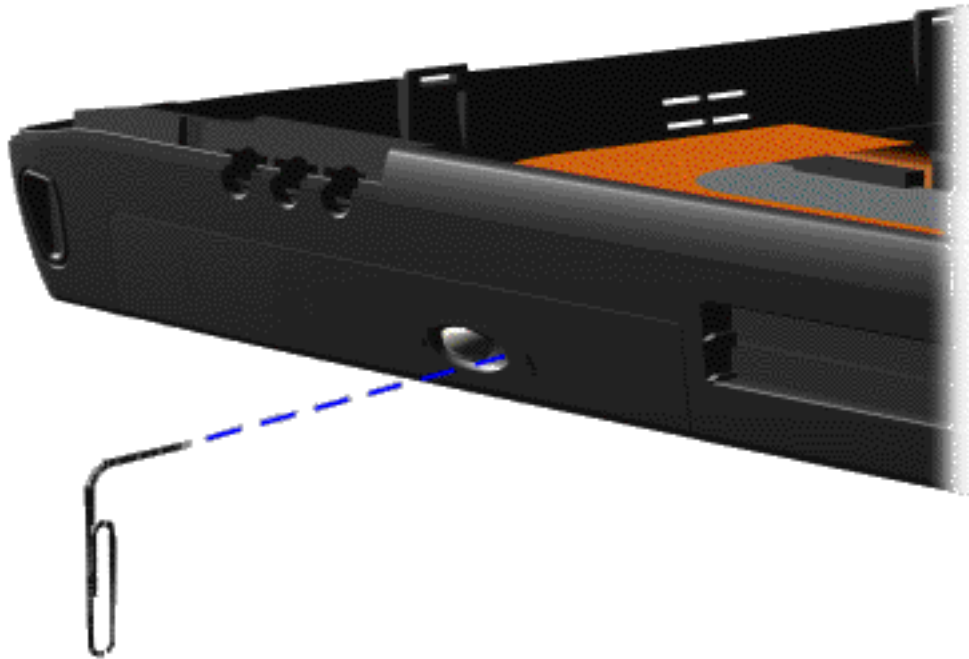

[Next](#)

[Opening the CD Drive Tray](#)

Maintenance & Service Guide

Presario 1600 Series Portable Computers

[Notice](#) | [Preface](#) | [Home](#) | [Product Description](#) | [Troubleshooting](#) | [Illustrated Parts Catalog](#)
[Removal & Replacement Procedures](#) | [Specifications](#) | [Connector Pin Assignments](#) | [Battery Pack](#)

10. Release the lever on the CD drive tray and gently push forward from the rear of the CD drive to access the CD drive cable as shown.

[Next](#)

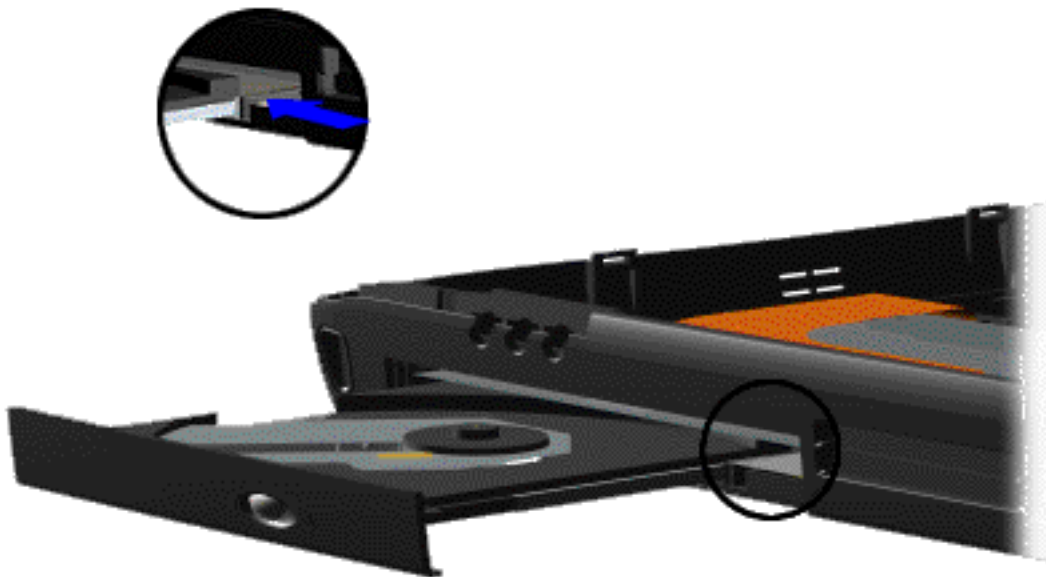

[Releasing the Lever](#)

Maintenance & Service Guide

Presario 1600 Series Portable Computers

[Notice](#) | [Preface](#) | [Home](#) | [Product Description](#) | [Troubleshooting](#) | [Illustrated Parts Catalog](#)
[Removal & Replacement Procedures](#) | [Specifications](#) | [Connector Pin Assignments](#) | [Battery Pack](#)

Compaq uses two vendors for CD drives and the CD drive cables are unique for each. If the replacement CD drive is the same as the original CD drive, it is not necessary to replace the CD drive cable.

IMPORTANT:

If the replacement CD drive is different from the original CD drive, the CD drive cable must be replaced with the cable supplied with the replacement CD drive.

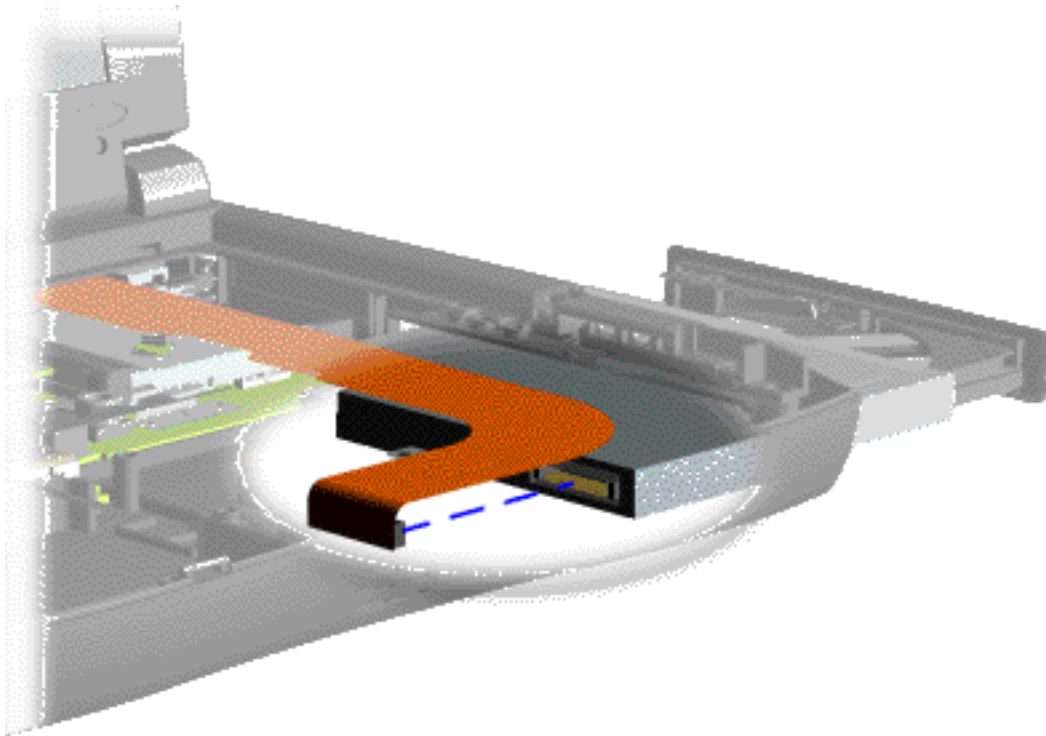

11. Disconnect the CD cable from the CD drive and push forward from the rear to remove the CD drive from the chassis as shown.

To replace the CD drive, reverse the previous procedures.

[Back to Preparing the Computer for Disassembly.](#)

Maintenance & Service Guide

Presario 1600 Series Portable Computers

[Notice](#) | [Preface](#) | [Home](#) | [Product Description](#) | [Troubleshooting](#) | [Illustrated Parts Catalog](#)
[Removal & Replacement Procedures](#) | [Specifications](#) | [Connector Pin Assignments](#) | [Battery Pack](#)

Removing The Display Assembly

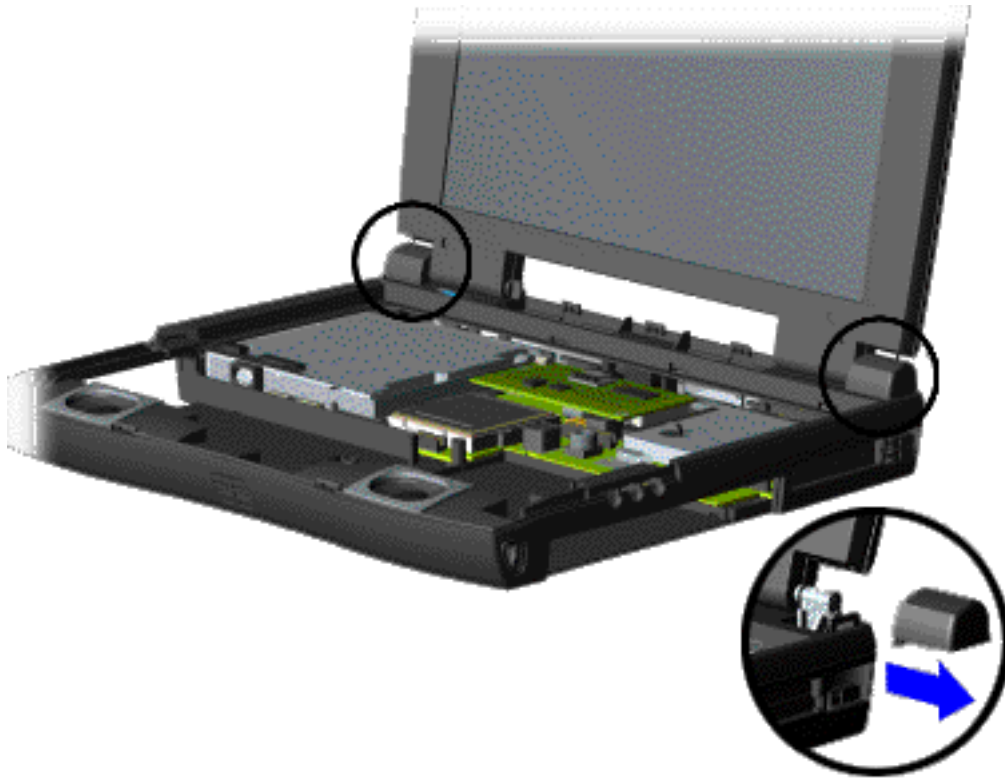

1. [Prepare the computer for disassembly.](#)

2. [Remove the palmrest cover with touch pad](#)

3. [Remove the keyboard.](#)

4. [Remove the heatspreader.](#)

5. [Remove the status panel.](#)

6. [Remove the interface board.](#)

7. [Disconnect the ZIF connector and backlight power cable from the interface board.](#)

8. Grasp the hinge covers and push out to release the covers from the hinges of the display panel assembly as shown.

[Next](#)

[Removing the Hinge Covers](#)

- [Removing the Battery Pack](#)
- [Palmrest Cover with Touch Pad](#)
- [Keyboard](#)
- [Heatspreader](#)
- [Status Panel](#)
- [Interface Board](#)
- [Hard Drive](#)
- [Battery Charger Board](#)
- [CD Drive](#)
- [Display Assembly](#)**
- [Plastic Subpanel Assembly](#)
- [CD Drive Cable](#)
- [Speaker Assembly](#)
- [Modem](#)
- [Diskette Drive](#)
- [Fan](#)
- [Audio Assembly Board](#)
- [System Board](#)
- [Memory Module](#)

Maintenance & Service Guide

Presario 1600 Series Portable Computers

[Notice](#) | [Preface](#) | [Home](#) | [Product Description](#) | [Troubleshooting](#) | [Illustrated Parts Catalog](#)
[Removal & Replacement Procedures](#) | [Specifications](#) | [Connector Pin Assignments](#) | [Battery Pack](#)

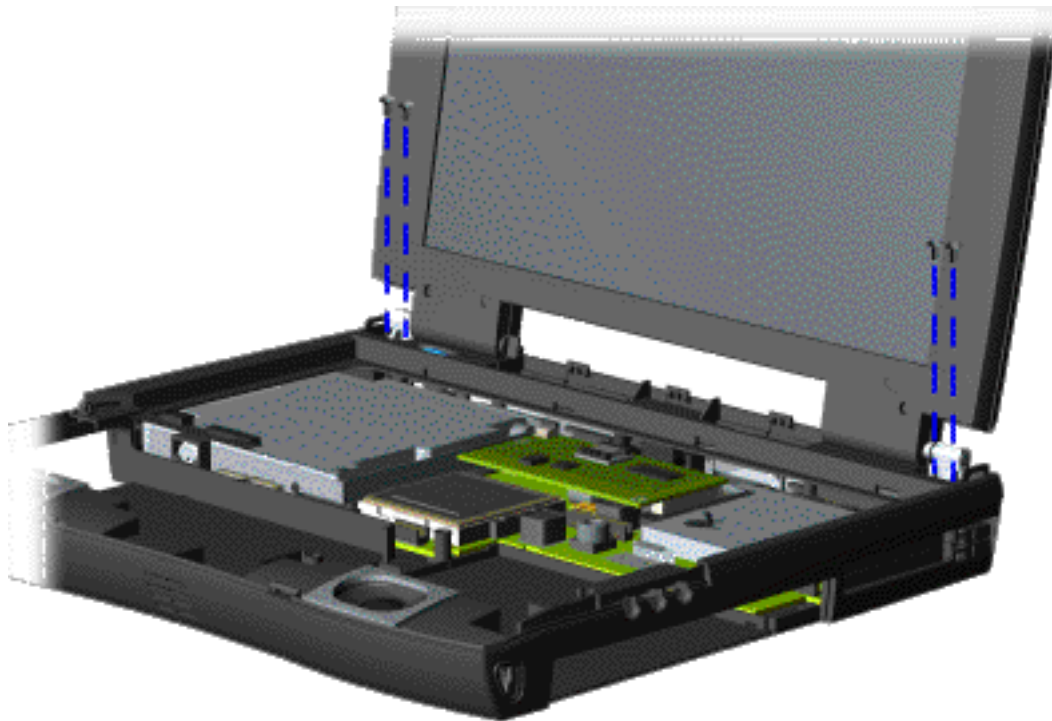

9. Support the back of the display assembly and remove the four screws from the display assembly as shown.

[Next](#)

[Removing Screws from the Display Assembly](#)

Maintenance & Service Guide

Presario 1600 Series Portable Computers

[Notice](#) | [Preface](#) | [Home](#) | [Product Description](#) | [Troubleshooting](#) | [Illustrated Parts Catalog](#)
[Removal & Replacement Procedures](#) | [Specifications](#) | [Connector Pin Assignments](#) | [Battery Pack](#)



10. Gently pull the flex cable attached to the display assembly through the slot on the plastic subpanel assembly.

11. Remove the display assembly with flex cable attached as shown.

[Back to Preparing the Computer for Disassembly.](#)

[Removing the Display Assembly with Flex Cable Attached](#)

Maintenance & Service Guide

Presario 1600 Series Portable Computers

[Notice](#) | [Preface](#) | [Home](#) | [Product Description](#) | [Troubleshooting](#) | [Illustrated Parts Catalog](#)
[Removal & Replacement Procedures](#) | [Specifications](#) | [Connector Pin Assignments](#) | [Battery Pack](#)

4. Pull side lever to release the memory modules and unplug the memory modules from the system board as shown.

To replace the memory modules, reverse the previous procedures.

[Back to Preparing the Computer for Disassembly.](#)

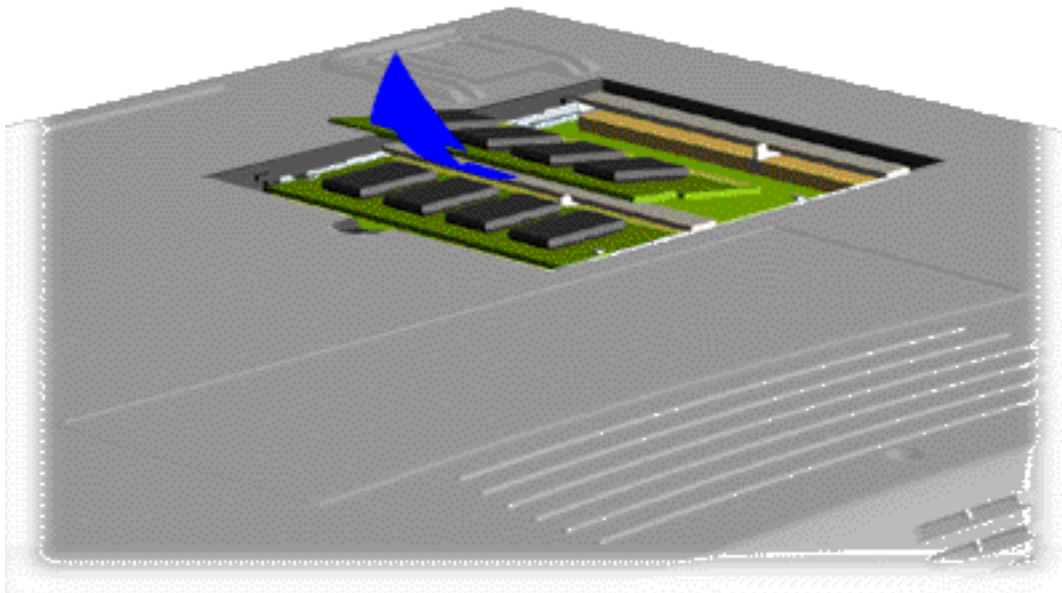

[Removing the Memory Module from the System Board](#)

Maintenance & Service Guide

Presario 1600 Series Portable Computers

[Notice](#) | [Preface](#) | [Home](#) | [Product Description](#) | [Troubleshooting](#) | [Illustrated Parts Catalog](#)
[Removal & Replacement Procedures](#) | [Specifications](#) | [Connector Pin Assignments](#) | [Battery Pack](#)

Rear Connectors

This section identifies the I/O pass-through connectors on the computer. Refer to [Appendix A](#) for connector pin assignments.

[Models and Features](#)

[Rear Connectors](#)

[Port Replicator](#)

[Power Management](#)

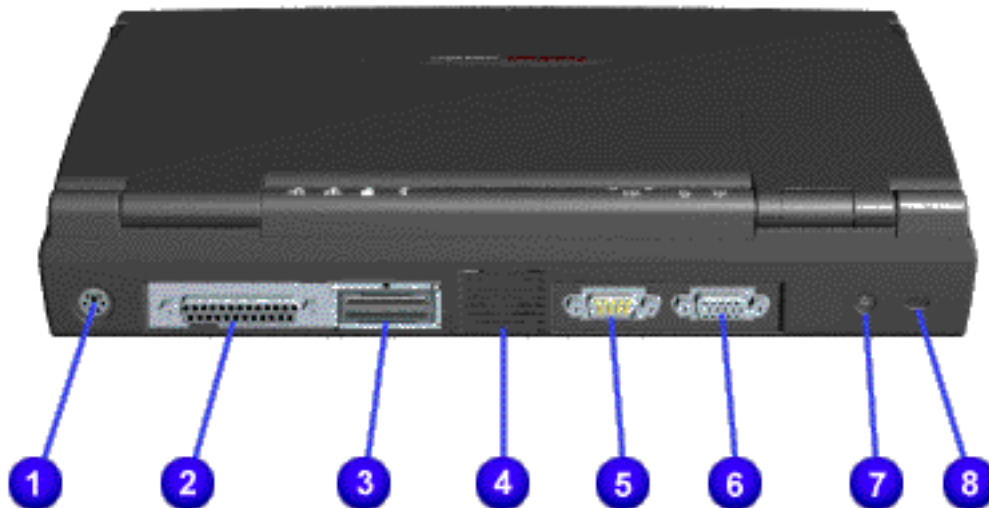

Rear Connectors

1. Keyboard/ Mouse Port	5. Port Serial Port
2. Parallel Printer Port	6. External Monitor Port
3. Port Replicator	7. AC Adapter Jack
4. Fan Exhaust	8. Security Slot

[Rear Connectors](#)

Maintenance & Service Guide

Presario 1600 Series Portable Computers

[Notice](#) | [Preface](#) | [Home](#) | [Product Description](#) | [Troubleshooting](#) | [Illustrated Parts Catalog](#)
[Removal & Replacement Procedures](#) | [Specifications](#) | [Connector Pin Assignments](#) | [Battery Pack](#)

Port Replicator

[Models and Features](#)

[Rear Connectors](#)

[Port Replicator](#)

[Power Management](#)

This section is an overview of the Compaq Presario Series Portable Computer Port Replicator and covers the following topics:

- [System Overview](#)
- [Features](#)
- [Port Replicator Rear Connectors](#)
- [80-Pin Connectors](#)

[System Overview](#)

A manual docking mechanism on the Compaq Presario Series Portable Computer Port Replicator docks Compaq Presario Series Portable Computers. When the computer is docked, the [80-pin external](#) options connector handles the entire electrical interface (both power and signal connections) between the computer and the [Port Replicator Rear Connectors](#).

[Features](#)

The Compaq Presario Series Portable Computer Port Replicator provides all the connectors supported by the Compaq Presario Series Portable Computers. They include:

- External keyboard
- External mouse
- MIDI/game port
- External monitor
- Serial
- Parallel
- AC Adapter
- Dual USB ports (Not supported on all models.)

Maintenance & Service Guide

Presario 1600 Series Portable Computers

[Notice](#) | [Preface](#) | [Home](#) | [Product Description](#) | [Troubleshooting](#) | [Illustrated Parts Catalog](#)
[Removal & Replacement Procedures](#) | [Specifications](#) | [Connector Pin Assignments](#) | [Battery Pack](#)

Power Management

[Models and Features](#)
[Rear Connectors](#)
[Port Replicator](#)
[Power Management](#)

The following power management features are available for conserving AC power and extending battery operating time:

- [Advanced Power Management \(APM\)](#)
- [Power Management Settings](#)
- [Sleep](#)
- [Hibernation](#)
- [Battery Operating Time](#)

Advanced Power Management (APM)

APM is installed on the computer and requires no action from the user to reduce power consumption. APM turns off the processor between keystrokes and when the system is idle. The idle function can be disabled by the user.

Power Management Settings

You can select power conservation settings through Power Management located on the System Features menu in Computer Setup. Computer Setup can be accessed by pressing **F10** when the cursor blinks on the upper-right corner of the display screen during system reboot. These settings control the power conservation rate and the timeout values for various system components. A timeout is a specified period of system or component inactivity. After this period, the system or component (for example, the hard drive) is shut down to conserve power until it is accessed again.

There are four categories of power management settings: Maximum Power Saving, Maximum Performance, Customized, and Disabled. The default setting for each feature is listed in Table 1-9.

Power Management Mode				
Power Savings	Settings	Maximum Power Savings	Maximum Performance	Disabled
Idle Mode*	Off, On, (Auto)	On	Off	Off
Sleep Timeout	Off, 5, (10) , 15, 20, 30, 40, 60 Minutes	5 Minutes	60 Minutes	Off
Resume On Time	(Off) , On	(Off) , On	(Off) , On	(Off) , On
Resume Time	(00:00:00)	(00:00:00)	(00:00:00)	(00:00:00)
Hard Disk Timeout	Disabled, 1, 2, 4, (5) , 6, 8, 10, 15	1 Minute	15 Minutes	Disabled
BIOS PM on AC	(Off) , On	(Off) , On	(Off) , On	(Off) , On

(Defaults) cannot be modified

* **Idle Mode:** Determines processor speed. For Auto, processor is throttled to 50% of maximum clock speed only during inactivity. When On, processor is always at 50% of maximum clock speed. When Off, processor is always at maximum clock speed.

Sleep

Sleep is a power conservation mode that performs the following functions:

- Places the computer in a lower power state after a selectable period of inactivity. Noticeable to the end-user, the panel is powered off and the hard drive is spun down.
- Automatically reduces the amount of power the computer uses.
- The computer is immediately ready for use when any key is pressed.
- Sleep mode is indicated by the Sleep (moon shaped) icon on the Status Panel.

The computer may be manually put in Sleep mode by pressing the **Fn + F4** keys.

Hibernation

Hibernation is a power conservation mode that performs the following functions:

- Saves all current information from memory and saves it to a file on the hard drive.
- Turns off the computer.
- Can be restored after any amount of time.

The Hibernation file is preinstalled on the hard disk. The Hibernation file is slightly larger than the total RAM memory of the computer (system memory, memory expansion board, and video memory). The Hibernation 100-MB file can be reinstalled with the QuickRestore CD. The system comes configured with a hibernation file large enough to support 96 MB of DRAM. Please refer to C:\HIBERNATE\HELP.TXT to customize the hibernation file size.

Hibernation is initiated by one of the following means:

- Automatically when the battery reaches a low battery level, if preselected.
- Manually by simultaneously pressing the power button. By holding the power button for more than four seconds, the system will power off instead of hibernating.

When the Power button is pushed, the computer exits Hibernation.

Battery Operating Time

Battery operating time is affected by variables, such as the following:

- Power conservation settings
- Hardware configuration
- Software applications
- Installed options
- Display brightness
- Hard drive usage
- Power button
- Changes in operating temperature
- Type and number of installed PC Cards

Refer to [Appendix B](#) for information on increasing battery pack operating time, conditioning the battery pack, and disposing of a used battery pack.

Maintenance & Service Guide

Presario 1600 Series Portable Computers

[Notice](#) | [Preface](#) | [Home](#) | [Product Description](#) | [Troubleshooting](#) | [Illustrated Parts Catalog](#)
[Removal & Replacement Procedures](#) | [Specifications](#) | [Connector Pin Assignments](#) | [Battery Pack](#)

Port Replicator Rear Connectors

This section covers external input/output (I/O) connectors. Refer to [Appendix A](#) for connector pin assignments.



Port Replicator Rear Connectors	
1. Keyboard	6. External Monitor
2. Mouse	7. Serial
3. Reserved	8. Parallel
4. Reserved	9. AC Adapter
5. MIDI/Game Pad/Joystick	

[Port Replicator Rear Connectors](#)

Maintenance & Service Guide

Presario 1600 Series Portable Computers

[Notice](#) | [Preface](#) | [Home](#) | [Product Description](#) | [Troubleshooting](#) | [Illustrated Parts Catalog](#)
[Removal & Replacement Procedures](#) | [Specifications](#) | [Connector Pin Assignments](#) | [Battery Pack](#)

80 Pin Connectors

The 80-pin Compaq Presario 1600 Series Portable Computer Port Replicator connector handles the entire electrical interface between the port Replicator and the computer.



CAUTION: Turn the computer power switch off before you connect or disconnect the port Replicator. Damage may occur to the computer if it is "hot" plugged to the port Replicator.

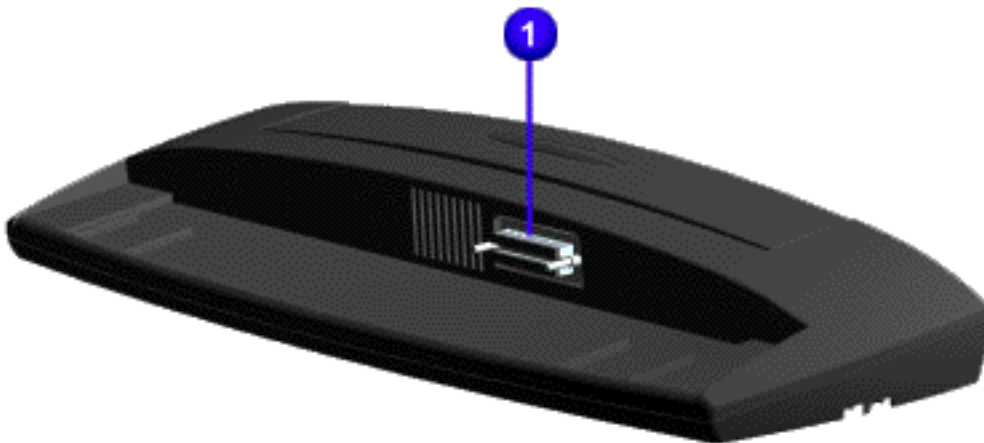

Free Manuals Download Website

<http://myh66.com>

<http://usermanuals.us>

<http://www.somanuals.com>

<http://www.4manuals.cc>

<http://www.manual-lib.com>

<http://www.404manual.com>

<http://www.luxmanual.com>

<http://aubethermostatmanual.com>

Golf course search by state

<http://golfingnear.com>

Email search by domain

<http://emailbydomain.com>

Auto manuals search

<http://auto.somanuals.com>

TV manuals search

<http://tv.somanuals.com>