

# Maintenance & Service Guide

**Presario 1800 Series  
Models: 1805 and 1810**

[Home Page](#) | [Notice](#) | [Preface](#) | [Product Description](#) | [Troubleshooting](#)  
[Illustrated Parts Catalog](#) | [Removal & Replacement Procedures](#) | [Specifications](#)  
[Pin Assignments](#) | [Battery Pack Operations](#)

[Notice](#)

[Preface](#)

[Product  
Description](#)

[Troubleshooting](#)

[Illustrated Parts  
Catalog](#)

[Removal &  
Replacement  
Procedures](#)

[Specifications](#)

[Connector Pin  
Assignments](#)

[Battery Pack  
Operations](#)



Compaq Presario 1800 Series Portable Computer is a continuation of the new generation of multimedia portable computers with an innovative integrated design, outstanding audio and video, advanced core features, and attractive styling. This full-function, Pentium II - based series of portable computers allows full desktop functionality and additional connectivity via the optional port replicator.

# **Maintenance & Service Guide**

**Presario 1800 Series  
Models: 1805 and 1810**

[| Home Page](#) | [| Notice](#) | [| Preface](#) | [| Product Description](#) | [| Troubleshooting](#)  
[| Illustrated Parts Catalog](#) | [| Removal & Replacement Procedures](#) | [| Specifications](#)  
[| Pin Assignments](#) | [| Battery Pack Operations](#)

---

## **Notice**

The information in this guide is subject to change without notice.

COMPAQ COMPUTER CORPORATION SHALL NOT BE LIABLE FOR TECHNICAL OR EDITORIAL ERRORS OR OMISSIONS CONTAINED HEREIN, NOR FOR INCIDENTAL OR CONSEQUENTIAL DAMAGES RESULTING FROM THE FURNISHING, PERFORMANCE, OR USE OF THIS MATERIAL.

This guide contains information protected by copyright. No part of this guide may be photocopied or reproduced in any form without prior written consent from Compaq Computer Corporation.

Ó 1998 Compaq Computer Corporation.  
All rights reserved. Printed in the U.S.A.

Compaq, Presario Registered U. S. Patent and Trademark Office.

Microsoft, MS-DOS, and Windows are registered trademarks of Microsoft Corporation. Windows 95 is a trademark of Microsoft Corporation.

The software described in this guide is furnished under a license agreement or nondisclosure agreement. The software may be used or copied only in accordance with the terms of the agreement.

Product names mentioned herein may be trademarks and/or registered trademarks of their respective companies.

Maintenance and Service Guide

Compaq Presario 1800 Series Portable Computers

First Edition (Oct. 1998)  
Compaq Computer Corporation

# Maintenance & Service Guide

Presario 1800 Series  
Models: 1805 and 1810

[Home Page](#) | [Notice](#) | [Preface](#) | [Product Description](#) | [Troubleshooting](#)  
[Illustrated Parts Catalog](#) | [Removal & Replacement Procedures](#) | [Specifications](#)  
[Pin Assignments](#) | [Battery Pack Operations](#)

## Preface

This Maintenance and Service Guide is a troubleshooting guide that can be used for reference when servicing the Compaq Presario 1800 Series Portable Computers.

Compaq Computer Corporation reserves the right to make changes to the Compaq Presario 1800 Series Portable Computers without notice.

## Symbols

The following words and symbols mark special messages throughout this guide.

 **WARNING:** Text set off in this manner indicates that failure to follow directions in the warning could result in bodily harm or loss of life.

 **CAUTION:** Text set off in this manner indicates that failure to follow directions could result in damage to equipment or loss of data.

**IMPORTANT:** Text set off in this manner presents clarifying information or specific instructions.

**NOTE:** Text set off in this manner presents commentary, sidelights, or interesting points of information.

## Technician Notes

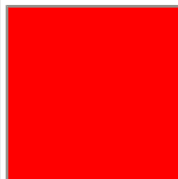
 **WARNING:** Only authorized technicians trained by Compaq should repair this equipment. All troubleshooting and repair procedures are detailed to allow only subassembly/module level repair. Because of the complexity of the individual boards and subassemblies, the user should not attempt to make repairs at the component level or to make modifications to any printed circuit board. Improper repairs can create a safety hazard. Any indications of component replacement or printed circuit board modifications may void any warranty.

## Serial Number

When requesting information or ordering spare parts, the computer serial number should be provided to Compaq. The serial number is located on the bottom of the computer.

## Locating Additional Information

The following documentation is available to support this product:

- | Compaq Presario 1800 Series Portable Computer documentation set
- | Introducing Windows 98 Guide
- | Service Training Guides
- | Compaq Service Advisories and Bulletins
- | Compaq QuickFind
- | Compaq Service Quick Reference Guide

# Maintenance & Service Guide

**Presario 1800 Series  
Models: 1805 and 1810**

[Home Page](#) | [Notice](#) | [Preface](#) | [Product Description](#) | [Troubleshooting](#)  
[Illustrated Parts Catalog](#) | [Removal & Replacement Procedures](#) | [Specifications](#)  
[Pin Assignments](#) | [Battery Pack Operations](#)

## Product Description

[Models and Features](#)

[Controls and Lights](#)

[Left Side Components](#)

[Right Side Components](#)

[Bottom of Unit](#)

[Rear Connectors](#)

[Port Replicator](#)

[Power Management for Windows 98](#)

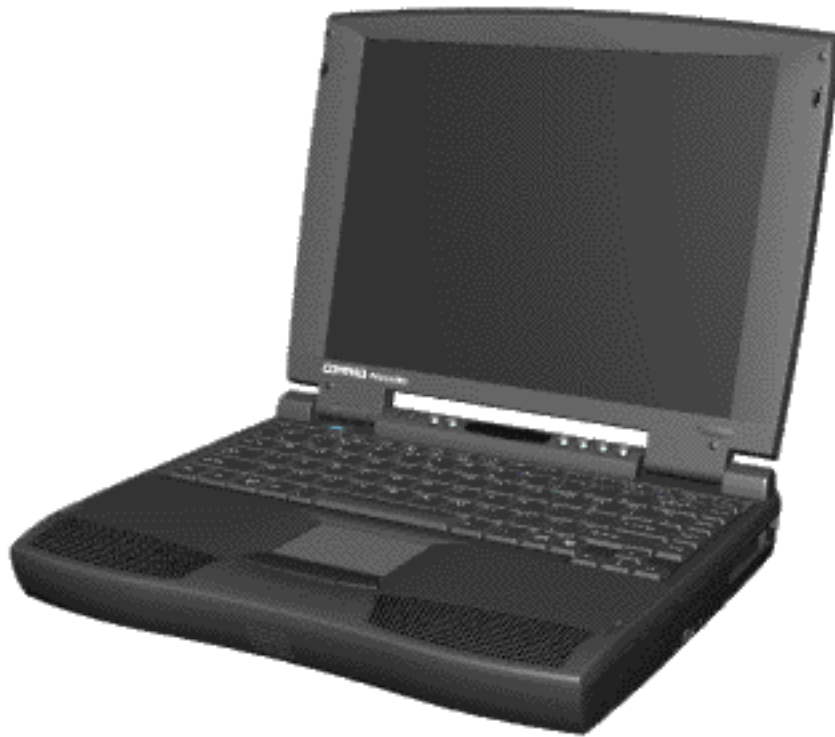

Compaq Presario 1800 Series Series Portable Computer is a continuation of the new generation of multimedia portable computers with an innovative integrated design, outstanding audio and video, advanced core features, and attractive styling. This full-function, Pentium II - based series of portable computers allows full desktop functionality and additional connectivity via the optional port replicator.

# Maintenance & Service Guide

**Presario 1800 Series  
Models: 1805 and 1810**

| [Home Page](#) | [Notice](#) | [Preface](#) | [Product Description](#) | [Troubleshooting](#)  
[Illustrated Parts Catalog](#) | [Removal & Replacement Procedures](#) | [Specifications](#)  
[Pin Assignments](#) | [Battery Pack Operations](#)

---

## Troubleshooting

### [Preliminary Steps](#)

### [Clearing the Power-On Password](#)

### [Power-On Self Test \(POST\)](#)

### [Compaq Diagnostics](#)

### [Diagnostic Error Codes](#)

### [Troubleshooting Without Diagnostics](#)

### [Solving Minor Problems](#)

### [Contacting Compaq Support](#)

This section covers troubleshooting information for the Compaq Presario 1800 Series Portable Computers. The basic steps in troubleshooting include:

1. Follow the [Preliminary Steps](#).
2. Run the [Power-On Self-Test \(POST\)](#).
3. Follow the recommended actions described in the diagnostic tables, if you are unable to run POST or if POST displays an error message.

When following the recommended actions in the Sections on POST and [Diagnostic Error Codes](#) perform them in the order listed. Rerun POST after each recommended action until the problem is solved and no error message occurs. Once the problem is solved, do not complete the remaining recommended actions.

#### **NOTE:**

If the problem is intermittent, check the computer several times to verify that the problem is solved.

# Maintenance & Service Guide

Presario 1800 Series

Models: 1805 and 1810

[Home Page](#) | [Notice](#) | [Preface](#) | [Product Description](#) | [Troubleshooting](#)  
[Illustrated Parts Catalog](#) | [Removal & Replacement Procedures](#) | [Specifications](#)  
[Pin Assignments](#) | [Battery Pack Operations](#)

---

## Illustrated Parts Catalog

[System Unit](#)

[Boards](#)

[Display  
Assembly](#)

[Mass Storage  
Devices](#)

[Miscellaneous  
Cable Kit](#)

[Cables](#)

[Miscellaneous  
Hardware and  
Plastics Kit](#)

[Miscellaneous  
Parts](#)

[Documentation  
and Software](#)

This section provides an breakdown and identifies the spare parts ordering number associated with each item(s) for the Compaq Presario 1800 Series Portable Computers.

# Maintenance & Service Guide

**Presario 1800 Series  
Models: 1805 and 1810**

[Home Page](#) | [Notice](#) | [Preface](#) | [Product Description](#) | [Troubleshooting](#)  
[Illustrated Parts Catalog](#) | [Removal & Replacement Procedures](#) | [Specifications](#)  
[Pin Assignments](#) | [Battery Pack Operations](#)

---

## Removal and Replacement Procedures

This section explains the removal and replacement procedures for the computer.

### Serial Number Location

[Disassembly Sequence](#)

[Electrostatic Discharge](#)

[Service Considerations](#)

[Cables and Connectors](#)

[Preparing the Computer for Disassembly](#)

[Battery Pack](#)

[Palmrest Cover with Touch Pad](#)

[Keyboard](#)

[Heatspreader](#)

[Modem](#)

[Processor](#)

[Status Panel](#)

[Interface Board](#)

[Hard Drives](#)

[Battery Charger Board](#)

[CD or DVD Drive](#)

[Display Panel Assembly](#)

[Upper CPU Cover](#)

[Speaker Assembly](#)

[Diskette Drive](#)

[Fan Assembly](#)

[Audio Board](#)

[System Board](#)

[Memory Module](#)



Report the computer **1** serial number to Compaq when requesting information or ordering spare parts.



## Maintenance & Service Guide

### Presario 1800 Series Models: 1805 and 1810

[Home Page](#) | [Notice](#) | [Preface](#) | [Product Description](#) | [Troubleshooting](#)  
[Illustrated Parts Catalog](#) | [Removal & Replacement Procedures](#) | [Specifications](#)  
[Pin Assignments](#) | [Battery Pack Operations](#)

## Specifications

This chapter covers the following specifications of Compaq Presario 1800 Series Portable Computers:

- [Computer models](#)
- [Physical and environmental](#)
- [System Interrupts](#)
- [System DMA](#)
- [System I/O Address](#)
- [System Memory Catalog](#)
- [Display](#)
- [Memory expansion](#)
- [Diskette drive](#)
- [Hard drive](#)
- [CD and DVD drive](#)
- [Battery pack](#)

### Physical and Environmental

Computer Specifications		
	U.S.	Metric
<b>Dimensions</b>		
Height	1.97 in	4.95 cm
Depth	12.20 in	31.00 cm
Width	10.08 in	25.40 cm
<b>Weight</b>		
Model 1805	7.326 lb	3.33 kg
Model 1810	7.326 lb	3.33 kg
<b>Stand-Alone (Battery Pack) Power Requirements</b>	<b>NiMH</b>	<b>Li-ion</b>
Nominal Operating	W @ 9.6 V	W @ 14.4 V
Maximum Average	W @ 9.6 V	W @ 14.4 V
Peak Operating	W @ 9.6 V	W @ 14.4 V
<b>AC Power Requirements</b>		
Operating Voltage	100-240 V	
Operating Current	0.8/0.4 A RMS	
Operating Frequency	47-63 Hz	
Maximum Transient	Meets IEC 801-4 and IEC801-5 1kV for 50 ns	
<b>Temperature</b>		
Operating	50° to 95 °F	10° to 35 °C
Nonoperating	-4° to 140 °F	-20° to 60 °C
<b>Relative Humidity (noncondensing)</b>		
Operating	10 to 90%	35°C to 90%
Nonoperating (tw = 38.7°C max)	5 to 95%	60°C to 95%
<b>Altitude</b>		
Operating	0 to 10,000 ft	0 to 3.15 km
Nonoperating	0 to 30,000 ft	0 to 9.14 km
<b>Shock</b>		
Operating	10 G, 11 ms, half sine	
Non operating	240 G, 2 ms, half sine	
<b>Vibration</b>		
Operating	0.5 G	
Nonoperating	1.5 G	
<b>NOTE:</b> Applicable product safety standards specify thermal limits for plastic surfaces. Compaq Presario 1800 Series Portable Computers operate well within this range of temperatures.		

### System Interrupts

System Interrupts	
Hardware IRQ	System Function
IRQ0	Timer Interrupt
IRQ1	Keyboard
IRQ2	Interrupt Controller Cascade
IRQ3	Internal Modem
IRQ4	Communication Port (COM1)
IRQ5	Audio Controller
IRQ6	Diskette Drive
IRQ7	Parallel Port (LPT 1) (default)
IRQ8	System CMOS/Real-Time Clock
IRQ9	IRQ Holder for PCI Steering
IRQ9	PCI-1131 CardBus Controller
IRQ9	IRQ Holder for PCI Steering
IRQ9	IRQ Holder for PCI Steering
IRQ9	PCI-1131 CardBus Controller
IRQ9	Video Controller
IRQ11	Intel PCI to USB Universal Host Controller
IRQ11	IRQ Holder for PCI Steering
IRQ12	PS/2 TouchPad/Mouse
IRQ13	Numeric data processor
IRQ14	Intel PCI Bus Master IDE Controller
IRQ14	Primary IDE Controller (dual fifo)
IRQ15	Intel PCI Bus Master IDE Controller
IRQ15	Secondary IDE Controller (dual fifo)

### System DMA

System DMA	
Hardware DMA	System Function
DMA 0	Audio Controller
DMA 1	Audio Controller
DMA 2	Diskette Drive
DMA 4	DMA Controller

### System I/O Address

System I/O Address	
I/O Address (Hex)	System Function (Shipping Configuration)
0000h-000Fh	DMA Controller
0020h-0021h	Interrupt Controller
0040h-0043h	System timer
0060h-0060h	Keyboard Controller
0061h-0061h	System speaker
0064h-0064h	Standard 101/102-Key or Microsoft Natural Keyboard
0070h-0071h	System CMOS/real time clock
0080h-0080h	Motherboard resources
0081h-008Fh	DMA Controller
00A0h-00A1h	Programmable interrupt controller
00C0h-00DFh	DMA
00ECh-00EFh	Motherboard resources
00F0h-00FFh	Numeric data processor
0170h-0177h	Intel PCI Bus Master IDE Controller
0170h-0177h	Secondary IDE Controller (dual fifo)
01F0h-01F7h	Intel PCI Bus Master IDE Controller
01F0h-01F7h	Primary IDE Controller (dual fifo)
0201h-0201h	Gameport Joystick
0220h-022Fh	ES1869 Plug and Play AudioDrive
02F8h-02FFh	Compaq Presario 56K-DF
0330h-0331h	ES1869 Plug and Play AudioDrive
0376h-0376h	Secondary IDE controller (dual fifo)
0376h-0376h	Intel PCI Bus Master IDE Controller
0378h-037Fh	Printer Port (LPT1)
0388h-038Bh	ES1869 Plug and Play AudioDrive
03B0h-03BBh	Video Controller
03C0h-03DFh	Video Controller
03F0h-03F5h	Standard Floppy Disk Controller
03F6h-03F6h	Intel PCI Bus Master IDE Controller
03F6h-03F6h	Primary IDE controller (dual fifo)
03F7h-03F7h	Standard Floppy Disk Controller
03F8h-03FFh	Communications Port (COM1)
04D0h-04D1h	Motherboard resources
0800h-0807h	ES1869 Control Interface
0CF8h-0CFFh	PCI bus
2180h-218Fh	Motherboard resources
8000h-803Fh	Motherboard resources
FCD0h-FCD7h	Primary IDE controller (dual fifo)
FCD0h-FCDFh	Intel PCI Bus Master IDEController
FCD8h-FCDFh	Secondary IDE controller (dual fifo)
FCE0h-FCFFh	Intel PCI to USB Universal Host Controller

### System Memory Catalog

System Memory Catalog	
Memory Address	System Function
00000000h-0009FFFFh	System board extension for PnP BIOS
000A0000h-000AFFFFh	Graphics Controller
000B0000h-000BFFFFh	Graphics Controller
000C0000h-000CBFFFh	Graphics Controller
000D0000h-000FFFFFh	System board extension for PnP BIOS
00100000h-03FFFFFFFh	System board extension for PnP BIOS
05000000h-05000FFFh	PCI-1131 CardBus Controller
05001000h-05001FFFh	PCI-1131 CardBus Controller
80000000h-803FFFFFFh	Intel Pentium(r) II Processor to PCI bridge
FD000000h-FDFFFFFFFh	Graphics Controller
FEA00000h-FEBFFFFFFFh	Graphics Controller
FED00000h-FEDFFFFFFFh	Graphics Controller
FFF80000h-FFFFFFFFFh	Motherboard resources

### Display (Information not available)

13.3" (Diagonal) TFT Display		
	U.S.	Metric
<b>Dimensions</b>		
Height	Information not available	Information not available
Width	Information not available	Information not available
<b>Display Dimensions</b>		
Width	Information not available	Information not available
Height	Information not available	Information not available
Depth	Information not available	Information not available
<b>Weight</b>	Information not available	Information not available
<b>Contrast Ratio</b>	Information not available	Information not available
<b>Brightness</b>	Information not available	Information not available
<b>Total Power Consumption</b>	Information not available	Information not available

### Memory Expansion

Memory Expansion		
System Memory	Expansion Board Memory	Total Memory
32-MB	16-MB	48-MB
32-MB	32-MB	64-MB
32-MB	64-MB	96-MB

### Diskette Drive (Information not available)

Diskette Drive	
Capacity per Diskette (High/Low)	Information not available
<b>Diskette Size</b>	Information not available
<b>Number of LED Indicators (Read/Write)</b>	Information not available
<b>Number of Drives Supported</b>	Information not available
<b>Drive Rotation (rpm)</b>	Information not available
<b>Transfer Rate (Kbps)</b>	Information not available
<b>Bytes per Sector</b>	Information not available
<b>Sectors per Disk (High/Low)</b>	Information not available
<b>Tracks per Side (High/Low)</b>	Information not available
<b>Access Times</b>	Information not available
Track-to-Track (ms)	
Average (ms)	
Setting Time (ms)	
Latency Average (ms)	
<b>Cylinders (High/Low)</b>	Information not available
<b>Number of Read/Write Heads</b>	Information not available

### Hard Drive (Information not available)

Hard Drives			
	3.2-GB	4.0-GB	6.4-GB
<b>Capacity Per Drive</b>	Information not available	Information not available	Information not available
<b>Drive Type</b>	Information not available	Information not available	Information not available
<b>Logical Configuration</b>	Information not available	Information not available	Information not available
Cylinders			
Heads			
Sectors per track			
Bytes per sector			
<b>Seek Times</b>	Information not available	Information not available	Information not available
(Typical, Including settling in ms)			
Single track			
Average			
Full stroke			
<b>Transfer Rate</b>	Information not available	Information not available	Information not available
At interface			

### DVD Drive (Information not available)

DVD Drive	
	DVD Drive
<b>Dimensions</b>	Information not available
<b>Weight</b>	Information not available
<b>Rotational Speed</b>	Information not available
<b>Typical Transfer Rate</b>	Information not available
Sustained Data Transfer Rate	
<b>Access Time</b>	Information not available
Average Random Access Time	
<b>Spin Up time</b>	Information not available
<b>Data Buffer Capacity</b>	Information not available

CD Drive	
	24x CD Drive
<b>Dimensions</b>	Information not available
<b>Weight</b>	Information not available
<b>Rotational Speed</b>	Information not available
<b>Typical Transfer Rate</b>	Information not available
Sustained Data Transfer Rate	
<b>Access Time</b>	Information not available
Average Random Access Time	
<b>Spin Up time</b>	Information not available
<b>Data Buffer Capacity</b>	Information not available

### Battery Pack

Battery Pack		
	Nickel Metal Hydride (NiMH)	Lithium Ion (Li ion) *
<b>Dimensions</b>		
Height	0.8 in (20.3 mm)	0.8 in (20.3 mm)
Length	5.7 in (145 mm)	5.7 in (145 mm)
Width	3.1 in (78.7 mm)	3.1 in (78.7 mm)
<b>Weight</b>	1.01 lb (458.1 g)	0.90 lb (408.2 g)
<b>Battery Pack Operating Time</b>	2:30 hr	3:00 hr
<b>Energy</b>		
Nominal Open Circuit Voltage	9.6 V	14.4 V
Capacity	3200mAH	2500mAH
Power	40 W	40 W
<b>Environmental Requirements</b>		
Operating Temperature	32° F (0-50° C)	32° F (0-50° C)
Non-operating Temperature	-20° C -60° C	-20° C -60° C
Charging Temperature	5° C-45° C	5° C-45° C



# Maintenance & Service Guide

## Presario 1800 Series

### Models: 1805 and 1810

[Home Page](#) | [Notice](#) | [Preface](#) | [Product Description](#) | [Troubleshooting](#)  
[Illustrated Parts Catalog](#) | [Removal & Replacement Procedures](#) | [Specifications](#)  
[Pin Assignments](#) | [Battery Pack Operations](#)

## Connector Pin Assignments

This appendix provides connector pin assignment tables for Compaq Presario 1800 Series Portable Computers. For more information on connectors, refer to the section on [Rear Connectors](#).

**NOTE:** The signals in all tables of this appendix are considered active high unless otherwise indicated by an asterisk (\*).

Parallel Connector			
			
Pin	Signal	Pin	Signal
1	Strobe*	10	Acknowledge*
2	Data Bit 0	11	Busy
3	Data Bit 1	12	Paper Out
4	Data Bit 2	13	Select
5	Data Bit 3	14	Auto Linefeed*
6	Data Bit 4	15	Error*
7	Data Bit 5	16	Initialize Printer*
8	Data Bit 6	17	Select In*
9	Data Bit 7	18-25	Signal Ground
* = Active low			

Serial Connector		
Connector	Pin	Signal
	1	Carrier Detect
	2	Receive Data
	3	Transmit Data
	4	Data Terminal Ready
	5	Signal Ground
	6	Data Set Ready
	7	Ready to Send
	8	Clear to Send
	9	Ring Indicator

Keyboard/Mouse		
Connector	Pin	Signal
	1	Data
	2	Not defined
	3	Ground
	4	+5 VDC
	5	Clock
	6	Not defined

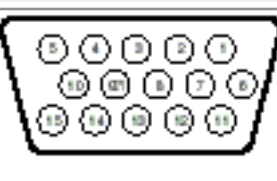
External VGA Monitor		
Connector	Pin	Signal
	1	Red Analog
	2	Green Analog
	3	Blue Analog
	4	Not connected
	5	Ground
	6	Ground Analog
	7	Ground Analog
	8	Ground Analog
	9	Not connected
	10	Ground
	11	Monitor Detect
	12	DDC2B Data
	13	Horizontal Sync
	14	Vertical Sync
	15	DDC2B Clock

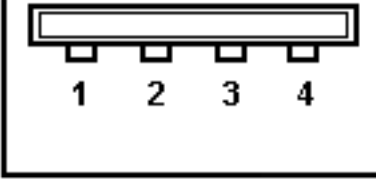
Universal Serial Bus		
Connector	Pin	Signal
	1	Ground
	2	D+
	3	D-
	4	Power

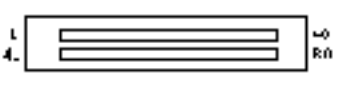
Port Replicator							
							
Pin	Signal	Pin	Signal	Pin	Signal	Pin	Signal
1	N.C.	21	Printer Data 0	41	N.C.	61	CTS
2	N.C.	22	Printer Data 1	42	N.C.	62	DCD
3	Kb Clk 1	23	Printer Data 2	43	Switch A	63	DSR
4	Joystick Data A	24	Printer Data 3	44	Switch B	64	TXD
5	Kb Data 1	25	Printer Data 4	45	Switch C	65	RTS
6	Joystick Data B	26	Printer Data 5	46	Switch D	66	N.C.
7	Kb Clk 2	27	Printer Data 6	47	N.C.	67	Detect
8	Joystick Data C	28	Printer Data 7	48	MIDI In	68	N.C.
9	Kb Data 2	29	USB 0 -	49	MIDI Out	69	V. Sync
10	Joystick Data D	30	USB 0 +	50	+5V	70	Ground
11	Lp Select In	31	USB 1 -	51	+5V	71	H. Sync
12	Lp Paper End	32	USB 1+	52	N.C.	72	Ground
13	Lp Initialize	33	Adapter In	53	N.C.	73	Blue
14	Lp Busy	34	Adapter In	54	N.C.	74	Ground
15	Lp Error	35	Adapter In	55	N.C.	75	Green
16	Lp Ack	36	Adapter In	56	Dock ID -	76	Ground
17	Lp Auto Feed	37	Adapter In	57	RXD	77	Red
18	Lp Strobe	38	Adapter In	58	Lp Select	78	Ground
19	DDC2BC	39	N.C.	59	RI	79	N.C.
20	DDC2BD	40	N.C.	60	DTR	80	N.C.

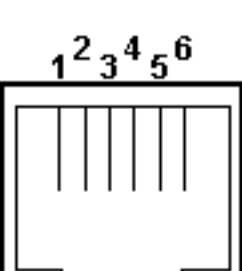
Modem		
Connector	Pin	Signal
	1	Unused
	2	Unused
	3	Tip
	4	Ring
	5	Unused
	6	Unused

# Maintenance & Service Guide

Presario 1800 Series  
Models: 1805 and 1810

[Home Page](#) | [Notice](#) | [Preface](#) | [Product Description](#) | [Troubleshooting](#)  
[Illustrated Parts Catalog](#) | [Removal & Replacement Procedures](#) | [Specifications](#)  
[Pin Assignments](#) | [Battery Pack Operations](#)

## Battery Pack Operating Time

This appendix covers the following information concerning battery pack operating time:

- Increase battery pack operating time
- Conditioning a battery pack
- Disposal of a used battery pack

### Increasing Battery Pack Operating Time

Battery pack operating time differs depending on several variables. To avoid unnecessary replacement, consider the following variables when determining how long a charged battery pack should last:

- Power management settings
- Hardware configuration
- Software applications
- Installed options
- Display brightness
- Hard drive usage
- Changes in operating temperature
- Type and number of installed PC Cards

**NOTE:** The power consumption requirements for PC Cards vary widely. Some cards drain the battery pack very rapidly.

Battery pack operating time can be increased by as much as 50 percent by controlling the energy required by the computer and the energy stored in the battery pack.

### Minimizing the Energy Required

To minimize the energy required by the computer, follow these steps:

- Set the power conservation levels in the Power Management utility to **Maximum**.
- Customize the timeout value to work more efficiently with the applications. The amount of battery life depends on the values selected.

### Maximizing the Energy Stored

To maximize the energy stored in the battery pack, follow these guidelines:

- Condition the battery pack at least every 30 days to improve overall battery performance.
- Keep a battery pack in the computer when using it with AC power to supply the battery pack with a constant trickle charge.
- Store the battery pack in a cool, dry place when not in use.

### Conditioning a Battery Pack

**CAUTION:** To avoid a loss of data, ensure that all data is saved before discharging a battery pack.

To condition a battery pack, complete the following steps:

1. Plug in the AC adapter and allow the battery to charge until the fast charge arrow on the display disappears. Your battery gauge may read 100 percent for a period of time before the arrow disappears. Do not unplug the AC adapter until the arrow disappears.
2. Unplug the AC adapter and allow the battery to drain until the computer reaches hibernation and turns itself off. **Do not plug in the AC adapter during this process or you will need to restart with Step No. 1.** You may use the computer while the battery is draining.
3. Your battery is re- conditioned.
4. Plug in the AC adapter and begin using the computer.

The table below shows battery pack charge times by model.

Battery Charge Time		
Computer	On Line	Off Line
Model 1/NiMH Battery Pack	4.0 hours premature termination	2:00 hr
Model 2/Li ion Battery Pack	4.5 hours premature termination	2:50 hr

### Disposal of a Used Battery Pack

In the interest of safeguarding our environment, Compaq Computer Corporation recommends that nickel metal hydride (NiMH) and lithium ion (Li ion) battery packs be recycled. Battery packs should be handled in accordance with country, state, province, or local regulations.

**CAUTION:** Never attempt to open or service a battery pack. Opening a battery pack not only damages the pack and makes it unusable, but also expose potentially harmful battery components.

# Maintenance & Service Guide

Presario 1800 Series

Models: 1805 and 1810

[Home Page](#) | [Notice](#) | [Preface](#) | [Product Description](#) | [Troubleshooting](#)  
[Illustrated Parts Catalog](#) | [Removal & Replacement Procedures](#) | [Specifications](#)  
[Pin Assignments](#) | [Battery Pack Operations](#)

## Models and Features

### **Models and Features**

### **Controls and Lights**

### **Left Side Components**

### **Right Side Components**

### **Bottom of Unit**

### **Rear Connectors**

### **Port Replicator**

### **Power Management for Windows 98**

### **Compaq Presario 1800 Series Portable Computer Models**

	<b>Model 1805</b>	<b>Model 1810</b>
<b>Display</b>	13.3" TFT	13.3" TFT
<b>Processor</b>	Pentium II/266 MMX	Pentium II/300 MMX
<b>Hard Drive</b>	3.2-GB or 4.0-GB	6.4-GB or 4.0-GB
<b>CD Drive</b>	24x MAX	DVD Drive
<b>Modem</b>	M++ 56.0 Kbps or K-56.0 Kbps with ITU V.90	M++-56.0 Kbps or K-56.0 Kbps with ITU V.90

# Maintenance & Service Guide

Presario 1800 Series  
Models: 1805 and 1810

[Home Page](#) | [Notice](#) | [Preface](#) | [Product Description](#) | [Troubleshooting](#)  
[Illustrated Parts Catalog](#) | [Removal & Replacement Procedures](#) | [Specifications](#)  
[Pin Assignments](#) | [Battery Pack Operations](#)

## Controls and Lights

[Models and Features](#)

**Controls and Lights**

[Left Side Components](#)

[Right Side Components](#)

[Bottom of Unit](#)

[Rear Connectors](#)

[Port Replicator](#)

[Power Management for Windows 98](#)

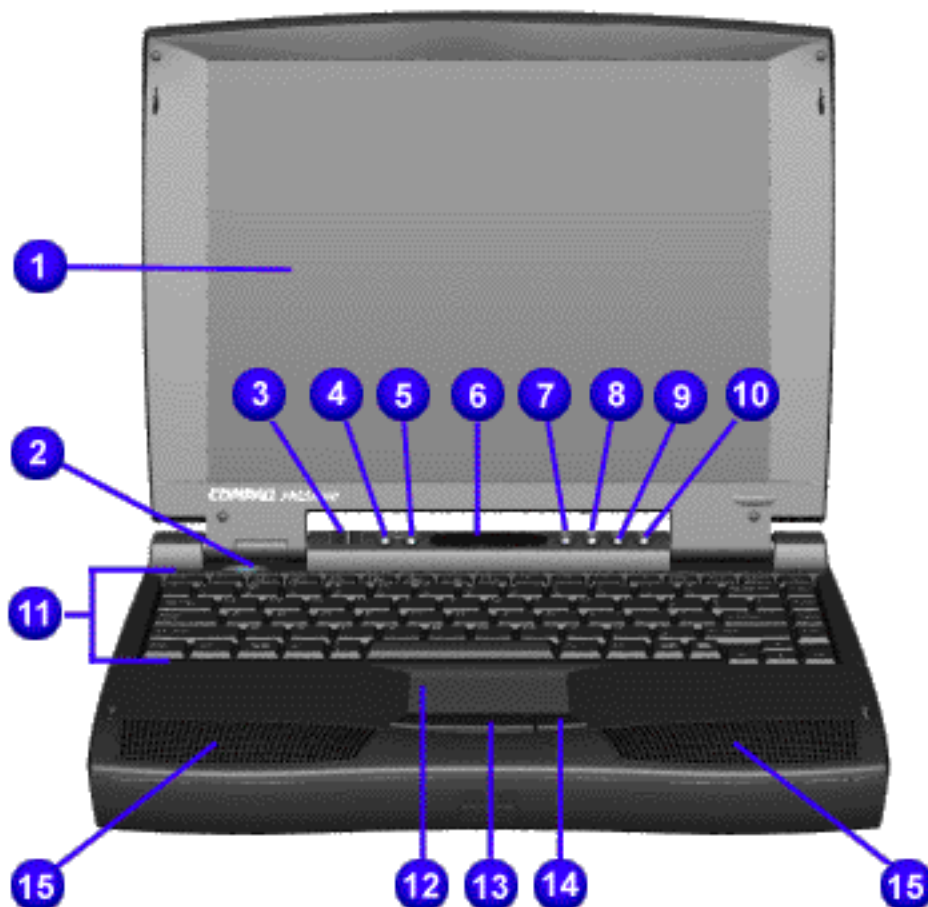

### Front of Unit

1. Display	9.DVD/CD Previous Track
2. Power (On/Off) Button	10. DVD/CD Next Track
3. DisqPlay Switch	11. Keyboard
4. Volume Control Down Button	12. Touch Pad
5. Volume Control Up Button	13. Left Touch Pad Button
6. Status Panel	14. Right Touch Pad Button
7. DVD/CD Play/Pause	15. Integrated Speakers
8. DVD/CD Stop	



# Maintenance & Service Guide

**Presario 1800 Series  
Models: 1805 and 1810**

[Home Page](#) | [Notice](#) | [Preface](#) | [Product Description](#) | [Troubleshooting](#)  
[Illustrated Parts Catalog](#) | [Removal & Replacement Procedures](#) | [Specifications](#)  
[Pin Assignments](#) | [Battery Pack Operations](#)

## Left Side Components

[Models and  
Features](#)

[Controls and  
Lights](#)

[Left Side  
Components](#)

[Right Side  
Components](#)

[Bottom of  
Unit](#)

[Rear  
Connectors](#)

[Port  
Replicator](#)

[Power  
Management  
for Windows  
98](#)

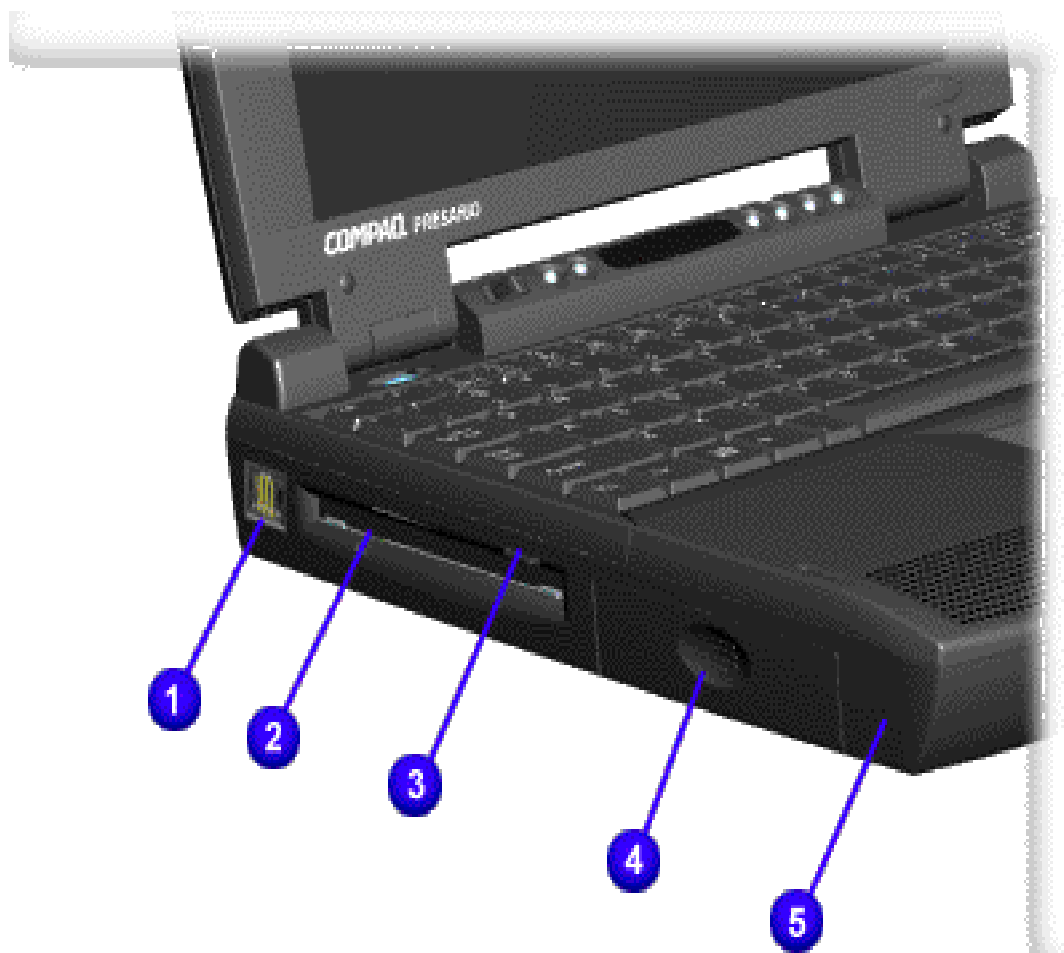

1.  
Modem  
Jack

2.  
Diskette  
Drive  
Slot

3.  
Diskette  
Eject  
Button

4.  
Battery  
Pack

5. Left  
Speaker  
Port

# Maintenance & Service Guide

**Presario 1800 Series  
Models: 1805 and 1810**

[Home Page](#) | [Notice](#) | [Preface](#) | [Product Description](#) | [Troubleshooting](#)  
[Illustrated Parts Catalog](#) | [Removal & Replacement Procedures](#) | [Specifications](#)  
[Pin Assignments](#) | [Battery Pack Operations](#)

## Right Side Components

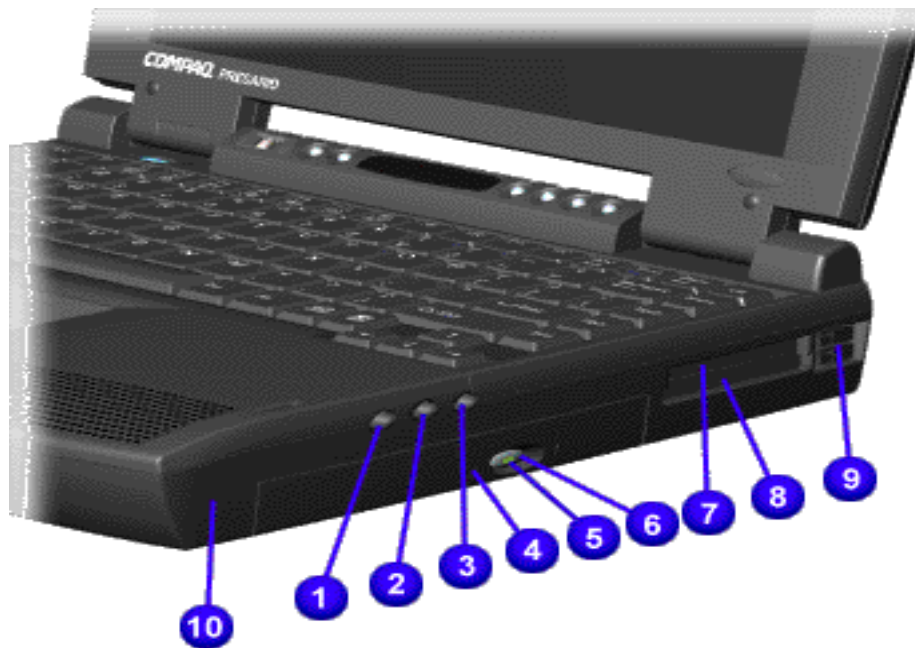

1. Headphone Out	6. CD or DVD Manual Eject Hole
2. Line-In Jack	7. PCMCIA (Top Slot)
3. External Microphone Jack	8. PCMCIA (Bottom Slot)
4. CD or DVD Drive	9. PCMCIA Eject Levers
5. CD or DVD Eject Button	10. Right Speaker Port

[Models and Features](#)

[Controls and Lights](#)

[Left Side Components](#)

[Right Side Components](#)

[Bottom of Unit](#)

[Rear Connectors](#)

[Port Replicator](#)

[Power Management for Windows 98](#)

# Maintenance & Service Guide

**Presario 1800 Series  
Models: 1805 and 1810**

[Home Page](#) | [Notice](#) | [Preface](#) | [Product Description](#) | [Troubleshooting](#)  
[Illustrated Parts Catalog](#) | [Removal & Replacement Procedures](#) | [Specifications](#)  
[Pin Assignments](#) | [Battery Pack Operations](#)

## Bottom of Unit

[Models and  
Features](#)

[Controls and  
Lights](#)

[Left Side  
Components](#)

[Right Side  
Components](#)

[Bottom of  
Unit](#)

[Rear  
Connectors](#)

[Port  
Replicator](#)

[Power  
Management  
for Windows  
98](#)

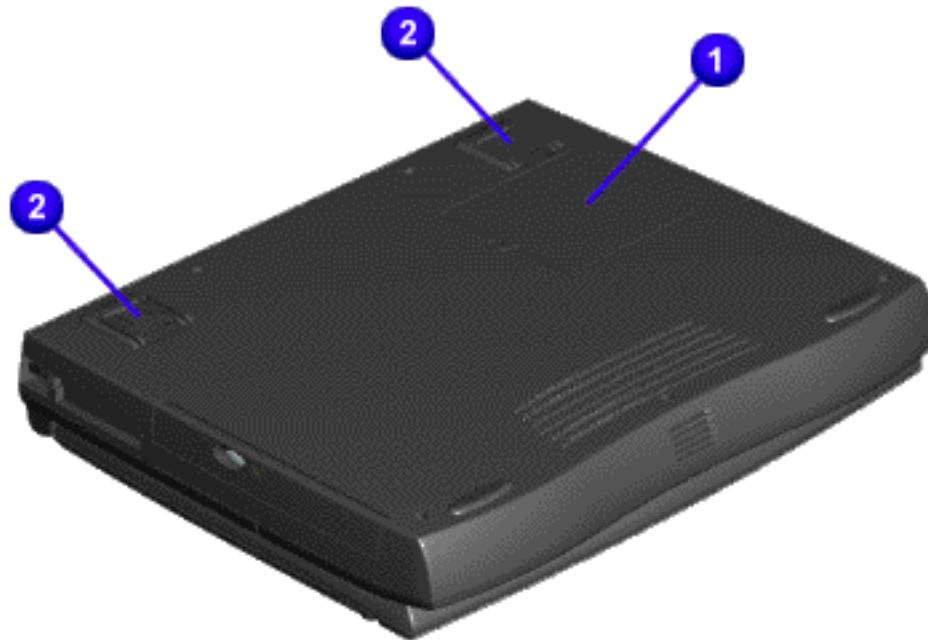

1. Memory Compartment	2. Feet
--------------------------	------------

# Maintenance & Service Guide

**Presario 1800 Series  
Models: 1805 and 1810**

[Home Page](#) | [Notice](#) | [Preface](#) | [Product Description](#) | [Troubleshooting](#)  
[Illustrated Parts Catalog](#) | [Removal & Replacement Procedures](#) | [Specifications](#)  
[Pin Assignments](#) | [Battery Pack Operations](#)

## Rear Connectors

[Models and Features](#)

[Controls and Lights](#)

[Left Side Components](#)

[Right Side Components](#)

[Bottom of Unit](#)

[Rear Connectors](#)

[Port Replicator](#)

[Power Management for Windows 98](#)

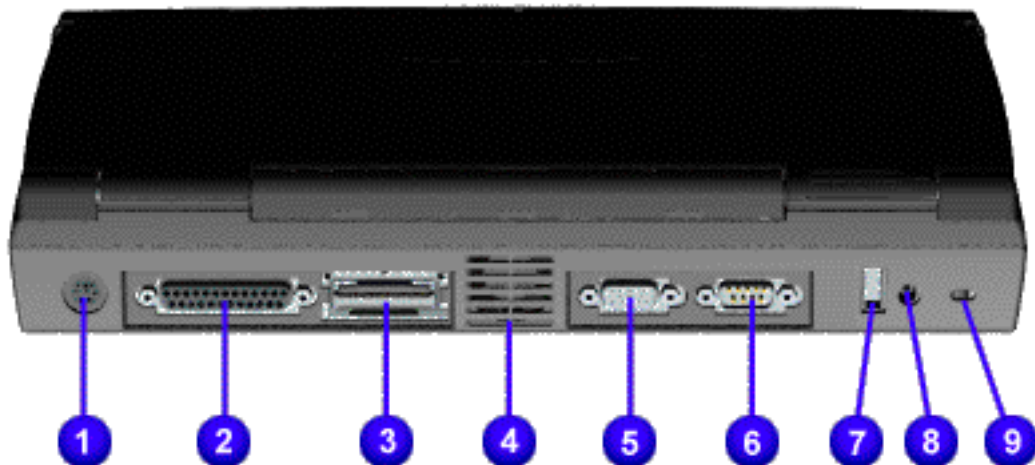

1. Keyboard/Mouse Port	6. External Monitor Port
2. Parallel Printer Port	7. USB
3. Port Replicator	8. AC Adapter
4. Fan Exhaust	9. Security Slot
5. Serial Port	



# Maintenance & Service Guide

## Presario 1800 Series Models: 1805 and 1810

[Home Page](#) | [Notice](#) | [Preface](#) | [Product Description](#) | [Troubleshooting](#)  
[Illustrated Parts Catalog](#) | [Removal & Replacement Procedures](#) | [Specifications](#)  
[Pin Assignments](#) | [Battery Pack Operations](#)

## Port Replicator

[Models and Features](#)

[Controls and Lights](#)

[Left Side Components](#)

[Right Side Components](#)

[Bottom of Unit](#)

[Rear Connectors](#)

**Port Replicator**

[Power Management for Windows 98](#)

This section is an overview of the Compaq Presario 1800 Series Portable Computer Port Replicator and covers the following topics:

- n [System Overview](#)
- n [Features](#)
- n [Port Replicator Rear Connectors](#)
- n [80-Pin Connectors](#)

### System Overview

A manual docking mechanism on the Compaq Presario 1800 Series Portable Computer Port Replicator docks Compaq Presario 1800 Series Portable Computers. When the computer is docked, the [80-pin external](#) options connector handles the entire electrical interface (both power and signal connections) between the computer and the Port Replicator Rear.

### Features

The Compaq Presario 1800 Series Portable Computer Port Replicator provides all the connectors supported by the Compaq Presario 1800 Series Portable Computers. They include:

- n External keyboard
- n External mouse
- n MIDI/game port
- n External monitor
- n Serial
- n Parallel
- n AC Adapter
- n Dual USB ports (Not supported on all models.)

# Maintenance & Service Guide

Presario 1800 Series  
Models: 1805 and 1810

[Home Page](#) | [Notice](#) | [Preface](#) | [Product Description](#) | [Troubleshooting](#)  
[Illustrated Parts Catalog](#) | [Removal & Replacement Procedures](#) | [Specifications](#)  
[Pin Assignments](#) | [Battery Pack Operations](#)

## Power Management for Windows 98

The following power management features are available for conserving AC power and extending battery operating time:

- Power Management Settings
- [Sleep](#)
- [Hibernation](#)
- [Battery operating time](#)
- [Rebooting After a Lockup](#)
- [Servicing Your Computer - Full Off Mode](#)

### Power Management Settings

Depending on your patterns of computer use, you can set different levels of power management. These different power management levels can be activated based on the amount of time passed since the last system activity. System activity examples, include keyboard or mouse movement, CD (while under program control that monitors Sleep), and modem use.

You can select different conditions or power schemes through Power Management. The optional settings are **Home/Office Desk**, **Portable/Laptop** and **Always On**. From the default settings, you can change the following settings.

- the System goes to Sleep (Standby) mode
- the screen times out and goes blank
- the hard drive spins down

Each of these system components will go to sleep after the selected or default periods of inactivity. (The setting for hard drive must be less than or equal to the setting for System.)

**IMPORTANT:** If you're on a network, it's recommended that you set **System Standby** to **Never**.

There are five categories of power management settings under the Control Panel. The default setting for each feature is listed below in the tables.

### Power Management Properties

Tab: <b>Power Schemes:</b>	Plugged in	Running on Batteries
<b>Always on System Standby:</b>	Never	15 minutes
<b>Turn OFF Monitor Always on System Standby:</b>	After 15 minutes	After 10 minutes
<b>Always on System Standby:</b>	After 15 minutes	After 10 minutes

### Power Management Properties

Tab: <b>ALARMS::</b>	
<b>Low Battery Alarm:</b>	10%
<b>Critical Battery Alarm</b>	0%
<b>Alarm Actions:</b>	X Display Message Notification
	<b>Text Action</b> <b>No Action</b>

### Power Management Properties

Tab: <b>POWER METER:</b>	Default
<b>Tab: ADVANCED</b>	Default

### Display Properties

Tab: **POWER METER: Monitor** Laptop Display (Maximum resolution according to unit display size)

### System Properties

Tab: Device Manager	
Default:	
<b>Disk Drives:</b>	<input checked="" type="checkbox"/> DMA
<b>CD ROM:</b>	<input checked="" type="checkbox"/> DMA

## Sleep

You can select Sleep mode instead of turning off the computer when you have finished using it. This allows the computer to wake up faster than turning it completely off and saves power over the active (On) mode. Compaq Presario Notebook computers have two levels of sleep, Hibernation and Sleep.

**Hibernation** - by pushing the power button once your computer will perform a save to disk followed by a shut down of the computer into Off mode.

**Sleep** - is a low power mode, also referred to as Standby mode. While in Sleep mode, your computer will maintain system information and open files. Unsaved information will be lost if you turn off your system prior to system wake-up, or if you lose power while using the AC adapter.

**CAUTION:** While in Sleep mode, your computer will maintain system information and open files. Unsaved information will be lost if you turn off your system prior to system wake-up, or if you lose power while using the AC adapter.

## Hibernation Mode

Hibernation helps conserve battery life and protects your data. Hibernation can be a routine power saving event, or can be the result of a low battery condition. As it enters Hibernation, your computer will display a progress screen, as it automatically saves the machine state before it shuts down and turns itself off. Your computer will automatically go into Hibernation, when the battery has little power left, or when the system (operating on battery power) has been in Sleep mode for more than an hour. You can also manually initiate Hibernation by pressing the power button once while the system is active. To restore the computer's previous state, simply press the power button once again. While waking up, the computer will display a progress screen.

The following table shows the conditions and indicators for getting in and out of the various power management modes, Sleep, Hibernation and Off.

Mode	To Initiate	To End	Indicators
Sleep	<u>Manual keys combination</u> - <b>Fn+F4</b>	Press any key	Flashing green Power LED
	<u>Time Out</u> <u>Default</u> 15 minutes. If on Battery power (system will not go to Sleep if on AC power)		
Hibernate	<u>Manual</u> - Press Power Button once	Press Power Button once	No Power LED, blank screen
	<u>Time Out</u> <u>Default</u> If low battery or after 1 hour of sleep (system will not Hibernate if on AC power)		
Off	Perform normal shutdown via the start button, or press and hold down the power button for 4 seconds	Press Power Button once	No Power LED, blank screen

## Servicing Your Computer - Full Off Mode

If you need to install or replace components in your system, you must turn the computer off completely. Follow the instructions above for properly putting the computer into Off mode, unplug from the outlet and remove the battery ([see battery section for instruction on removing battery](#)).

## Rebooting After a Lockup

Occasionally you may encounter a frozen keyboard or a locked screen. To reboot your computer (as if from a cold start) press and hold down the Power Button for at least four seconds, which will cause a manual shutdown. Then, restart it with a single press of the Power Button. If it still doesn't recover, press the Power Button and hold it for four seconds to shut it down, then, remove the battery and unplug the AC power for at least 30 seconds. Reinsert the battery or reconnect AC power and press the Power Button once to reboot.

## Battery Operating Time

Battery operating time is affected by variables, such as the following:

- Power conservation settings
- Hardware configuration
- Software applications
- Installed options
- Display brightness
- Hard drive usage
- Power button
- Changes in operating temperature
- Type and number of installed PC Cards

For more information on increasing battery pack operating time, conditioning the battery pack, and disposing of a used battery pack, refer to the [Battery Pack Operations](#).

# Maintenance & Service Guide

**Presario 1800 Series  
Models: 1805 and 1810**

| [Home Page](#) | [Notice](#) | [Preface](#) | [Product Description](#) | [Troubleshooting](#)  
[Illustrated Parts Catalog](#) | [Removal & Replacement Procedures](#) | [Specifications](#)  
[Pin Assignments](#) | [Battery Pack Operations](#)

---

## Preliminary Steps

Before running [POST](#), complete the following preliminary steps:

1. If a power-on password has been established, type the password and press the **Enter** key. If the password is not known, [clear the password](#).
2. Run [Computer Checkup](#).
3. Turn off the computer and its external devices.
4. Disconnect any external devices that you do not want to test. Do not disconnect the printer if you want to test it or use it to log error messages.

### **IMPORTANT:**

If the problem only occurs when an external device is connected to the computer, the problem may be related to the external device or its cable. Verify this by running POST with and without the external device connected.

5. Install loopback plugs in the serial and parallel connectors if you would like to test these ports.
6. Ensure the hard drive is installed in the computer.
7. Ensure that the battery pack is inserted in the computer and the computer is connected to an external AC power source.

When the preliminary steps are completed, you are ready to run [POST](#).



# Maintenance & Service Guide

Presario 1800 Series  
Models: 1805 and 1810

[Home Page](#) | [Notice](#) | [Preface](#) | [Product Description](#) | [Troubleshooting](#)  
[Illustrated Parts Catalog](#) | [Removal & Replacement Procedures](#) | [Specifications](#)  
[Pin Assignments](#) | [Battery Pack Operations](#)

## Power-On Self Test (POST)

### Running POST

To run POST, complete the following steps:

Turn off the computer, then turn on the computer.

If POST does not detect any errors, the computer will not beep. This indicates successful completion of POST test. POST has run successfully and boots from the hard drive (or from a bootable diskette if one is installed in the diskette drive).

If POST detects errors, the errors are indicated by screen and/or audible messages. Refer to "Power-On Self-Test (POST) Codes" in the tables for a list of POST codes and their relevant descriptions.

**NOTE:** If the system is not functioning well enough to run POST, or if the display is not functioning well enough to show POST error messages, refer to the Troubleshooting tables.

<b>Power-On Self-Test Messages</b>	
<b>102-System Board Failure</b>	
<b>Probable Cause</b>	<b>Recommended Action</b>
DMA, timers, etc.	Replace the system board.
<b>162-System Options Not Set</b>	
<b>Probable Cause</b>	<b>Recommended Action</b>
Configuration incorrect	Run Computer Setup.
CMOS reflects that an invalid configuration has been set.	Run Computer Setup.
RAM failure	1. Replace the memory modules. 2. Replace the system board.
Memory test data error	1. Replace the memory modules. 2. Replace the system board.
XX000YZZ RAM failure	Replace the system board.

<b>XX000YZZ 201-Memory Error</b>	
<b>Probable Cause</b>	<b>Recommended Action</b>
<b>301-Keyboard Error</b>	
<b>Probable Cause</b>	<b>Recommended Action</b>
Keyboard failure	1. Ensure the keys are not depressed during POST. 2. Reconnect the keyboard with the computer off. 3. Replace the keyboard.
<b>304-Keyboard or System Unit Error</b>	
<b>Probable Cause</b>	<b>Recommended Action</b>
Keyboard or system board error	1. Replace the keyboard. 2. Replace the TouchPad or mouse. 3. Replace the system board.
<b>601-Diskette Controller Error</b>	
<b>Probable Cause</b>	<b>Recommended Action</b>
Mismatch in drive type or failure in the diskette controller	1. Run Computer Checkup (TEST). 2. Check and/or replace cables. 3. Replace the system board.
<b>605-Diskette Drive Error</b>	
<b>Probable Cause</b>	<b>Recommended Action</b>
Mismatch in drive type	Run Computer Setup.
<b>1780-Primary Hard Drive 0 Failure</b>	
<b>Probable Cause</b>	<b>Recommended Action</b>
Disk 0 failed to respond	1. Run Computer Checkup (TEST). 2. Replace the hard drive.
Hard drive format error	1. Run Computer Checkup (TEST). 2. Replace the hard drive.
<b>1782-Hard Drive Controller</b>	
<b>Probable Cause</b>	<b>Recommended Action</b>
Hard drive controller failure	1. Run Computer Setup. 2. Replace the hard drive.



# Maintenance & Service Guide

Presario 1800 Series  
Models: 1805 and 1810

[Home Page](#) | [Notice](#) | [Preface](#) | [Product Description](#) | [Troubleshooting](#)  
[Illustrated Parts Catalog](#) | [Removal & Replacement Procedures](#) | [Specifications](#)  
[Pin Assignments](#) | [Battery Pack Operations](#)

---

## Clearing the Power-on Password



Clearing the power-on password requires removing all Setup attributes that are programmed in the CMOS.

If the password is not known, clear it by performing the following steps:

1. Turn off the computer.
2. Disconnect the power cord.
3. Remove the battery pack.
4. Remove the keyboard.
5. Remove the **1** RTC battery for 30 seconds. The password, together with other Setup attributes, will be cleared.
6. Reassemble the computer.
7. Turn on the computer to verify that the power-on password has been cleared. If it has not been cleared, repeat Steps 1 through

# Maintenance & Service Guide

Presario 1800 Series  
Models: 1805 and 1810

[Home Page](#) | [Notice](#) | [Preface](#) | [Product Description](#) | [Troubleshooting](#)  
[Illustrated Parts Catalog](#) | [Removal & Replacement Procedures](#) | [Specifications](#)  
[Pin Assignments](#) | [Battery Pack Operations](#)

---

## Compaq Diagnostics

Compaq Diagnostics is installed on the hard drive of the computer. Run the Diagnostics utilities when you want to view or test system information and if you have installed or connected devices. If you run Compaq Diagnostics from a diskette, ensure that it is version 10.11 or later.

The Diagnostics menu includes the following utilities:

- [Computer Checkup \(TEST\)](#)
- [View System Information \(INSPECT\)](#)
- [Prepare Computer for a Compaq Service Call \(RemotePaq\)](#)

If you have a problem you cannot solve, run the Diagnostics utilities before you call for support. Run Computer Checkup and select to save the device list to a file and to print or to save the log of errors. Run the View System Information (INSPECT) utility and select to print or to save that information. Have the files or the printed information available when you call for support.

### Computer Checkup (TEST)

Computer Checkup (TEST) determines whether the various computer components and devices are recognized by the system and are functioning properly. You can display, print, or save the information generated by Computer Checkup.

Follow these steps to run Computer Checkup:

1. Plug the computer into an external power source. (A low battery condition could interrupt the program.)
2. Turn on the external devices that you want to test. Connect the printer if you want to print a log of error messages.
3. Insert the Compaq Diagnostics diskette in drive A.
4. Turn on or restart the computer. The computer starts from drive A, and the **Diagnostics Welcome** screen appears.
5. Press **Enter** to continue. The **Diagnostics** menu appears.
6. Select Computer Checkup from the **Diagnostics** menu. A **Test Option** menu appears.
7. Select **View the Device List** from the **Test Option** menu. A list of the installed Compaq devices appears.
8. If the list of installed devices is correct, select **OK**. The **Test Option** menu appears.

**NOTE:** If the list is incorrect, ensure that any new devices are installed properly.

9. Select one of the following from the **Test Option** menu:

- Quick Check Diagnostics. Runs a quick, general test on each device with a minimal number of prompts. If errors occur, they display when the testing is complete. You cannot print or save the error messages.
- Automatic Diagnostics. Runs unattended, maximum testing of each device with minimal prompts. You can choose how many times to run the tests, to stop on errors, or to print or save a log of errors.
- Prompted Diagnostics. Allows maximum control over testing the devices. You can choose attended or unattended testing, decide to stop on errors, or choose to print or save a log of errors.

10. Follow the instructions on the screen as the devices are tested. When testing is complete, the **Test Option** menu appears.

11. Exit the **Test Option** menu.

12. Exit the **Diagnostics** menu.

### View System Information (INSPECT)

The View System Information (INSPECT) utility provides information about the computer and installed or connected devices. You can display, print, or save the information.

Follow these steps to run View System Information (INSPECT) from the Compaq Diagnostics diskette:

1. Turn on the external devices that you want to test. Connect the printer if you want to print the information.
2. Insert the Compaq Diagnostics diskette in drive A.
3. Turn on or restart the computer. The computer starts from drive A, and the **Diagnostics Welcome** screen appears.
4. Press **Enter** to continue. The Diagnostics menu appears.
5. Select **View System Information (INSPECT)** from the **Diagnostics** menu.
6. Select the item you want to view from the following list:

System	Memory
ROM	Audio
Keyboard	Operating system
System ports	System files
System storage	Windows files
Graphics	

7. Follow the instructions on the screen to cycle through the screens, to return to the list and choose another item, or to print the information.

# Maintenance & Service Guide

**Presario 1800 Series  
Models: 1805 and 1810**

[Home Page](#) | [Notice](#) | [Preface](#) | [Product Description](#) | [Troubleshooting](#)  
[Illustrated Parts Catalog](#) | [Removal & Replacement Procedures](#) | [Specifications](#)  
[Pin Assignments](#) | [Battery Pack Operations](#)

---

## Contacting Compaq Support

Obtain the following information before contacting Compaq Reseller Support:

- | Product name
- | Product serial number
- | Purchase date
- | Conditions under which the problem occurred
- | Any error messages that have occurred
- | Hardware configuration
- | Type of printer connected
- | Hardware/software being used
- | Printed result of Computer Checkup (TEST)
- | Printed copies of CONFIG.SYS and AUTOEXEC.BAT files, if possible

## Shipping Preparation

To ship the computer, complete the following steps:

1. Back up the critical hard drive files. Ensure that backup tapes/diskette are not exposed to electrical or magnetic fields while stored in transit.
2. Turn off the computer and external devices.
3. Disconnect the external devices from their power sources, then from the computer.

### **IMPORTANT:**

Ensure that there is no diskette in the diskette drive and that there are no PC Cards in the PC slots.

4. Close the display and all exterior doors of the computer.
5. Pack the computer with sufficient packing material to protect it. Use the original packing box or similar packaging.



# Maintenance & Service Guide

Presario 1800 Series  
Models: 1805 and 1810

[Home Page](#) | [Notice](#) | [Preface](#) | [Product Description](#) | [Troubleshooting](#)  
[Illustrated Parts Catalog](#) | [Removal & Replacement Procedures](#) | [Specifications](#)  
[Pin Assignments](#) | [Battery Pack Operations](#)

## Diagnostic Error Codes

Diagnostic error codes occur if the system recognizes a problem while running the Compaq Diagnostic program. These error codes help identify possibly defective subassemblies.

The following tables list error codes, a description of the error condition, and the action required to resolve the error condition.

**IMPORTANT:** Retest the system after completing each step. If the problem has been resolved, do not proceed with the remaining steps.

For the removal and replacement of a particular subassembly, see [Removal and Replacement Procedures](#).

Select error codes by number or type:

<a href="#">101 through 114</a>	<a href="#">Processor Test</a>
<a href="#">200 through 215</a>	<a href="#">Memory Test</a>
<a href="#">300 through 304</a>	<a href="#">Keyboard Test</a>
<a href="#">401 through 403</a>	<a href="#">Parallel Printer Test</a>
<a href="#">600 through 699</a>	<a href="#">Diskette Drive Test</a>
<a href="#">1101</a>	<a href="#">Serial Test</a>
<a href="#">1701 through 1736</a>	<a href="#">Hard Drive Test</a>
<a href="#">501 through 516</a>	<a href="#">Video Test</a>
<a href="#">2402 through 2456</a>	
<a href="#">2458 through 2480</a>	
<a href="#">3206</a>	<a href="#">Audio Test</a>
<a href="#">8601 through 8602</a>	<a href="#">Touch Pad Pointing Device Test</a>
<a href="#">3301 through 6623</a>	<a href="#">CD/DVD Test</a>

Processor Test Error Codes		
Error Code	Description	Recommended Action
101-xx	CPU test failed	Replace the processor and retest.
102-xx	Coprocessor or Weitek Error	1. Run the Configuration and Diagnostics Utilities. 2. Replace the processor board and retest.
103-xx	DMA page registers test failed	Replace the system board and retest.
104-xx	Interrupt controller master test failed	
105-xx	Port 61 error	
106-xx	Keyboard controller self-test failed	
107-xx	CMOS RAM test failed	
108-xx	CMOS interrupt test failed	
109-xx	CMOS clock test failed	
110-xx	Programmable timer load data test failed	
113-xx	Protected mode test failed	
114-01	Speaker test failed	1. Check system configuration. 2. Verify cable connections to speaker. 3. Replace the system board and retest.
Memory Test Error Codes		
200-xx	Memory machine ID test failed	1. Flash the system ROM and retest. 2. Replace the system board and retest.
202-xx	Memory system ROM checksum failed	
203-xx	Write/Read test failed	1. Remove the memory module and retest. 2. Install a new memory module and retest.
204-xx	Address test failed	
211-xx	Random pattern test failed	
214-xx	Noise test failed	
215-xx	Random address test failed	
Keyboard Test Error Codes		
300-xx	Failed ID Test	1. Check the keyboard connection. If disconnected, turn off the computer and connect the keyboard.
301-xx	Failed Selftest/Interface Test	
302-xx	Failed Individual Key Test	2. Replace the keyboard and retest.
304-xx	Failed Keyboard Repeat Test	3. Replace the system board and retest.
Parallel Printer Test Error Codes		
401-xx	Printer failed or not connected	1. Connect the printer. 2. Check power to the printer. 3. Install the loop-back connector and retest.
402-xx	Failed Port Test	
403-xx	Printer pattern test failed	4. Check port and IRQ configuration. 5. Replace the system board and retest.
Diskette Drive Test		
600-xx	Diskette ID drive types test failed	1. Replace the diskette media and retest. 2. Check and/or replace the diskette power and signal cables and retest. 3. Replace the diskette drive and retest. 4. Replace the system board and retest.
601-xx	Diskette format failed	
602-xx	Diskette read test failed	
603-xx	Diskette write, read, compare test failed	
604-xx	Diskette random read test failed	
605-xx	Diskette ID media failed	
606-xx	Diskette speed test failed	
609-xx	Diskette reset controller test failed	
610-xx	Diskette change line test failed	
697-xx	Diskette type error	
698-xx	Diskette drive speed not within limits	
699-xx	Diskette drive/media ID error	1. Replace media. 2. Run the Configuration and Diagnostics Utilities.
Serial Test Error Codes		
1101-xx	Serial port test failed	1. Check port configuration 2. Replace the system board and retest.
Hard Drive Test Error Codes		
1701-xx	Hard drive format test failed	1. Run the Configuration and Diagnostics Utilities and verify drive type. 2. Verify that all secondary drives have secondary drive capability. 3. Replace the hard drive and retest. 4. Replace the system board and retest.
1702-xx	Hard drive read test failed	
1703-xx	Hard drive write/read/compare test failed	
1704-xx	Hard drive random seek test failed	
1705-xx	Hard drive controller test failed	
1706-xx	Hard drive ready test failed	
1707-xx	Hard drive recalibration test failed	
1708-xx	Hard drive format bad track test failed	
1709-xx	Hard drive reset controller test failed	
1710-xx	Hard drive park head test failed	
1715-xx	Hard drive head select test failed	
1716-xx	Hard drive conditional format test failed	
1717-xx	Hard drive ECC* test failed	
1719-xx	Hard drive power mode test failed	
1724-xx	Network preparation test failed	
1736-xx	Drive monitoring test failed	
* ECC = Error Correction Code		
Video Test Error Codes		
501-xx	Video controller test failed	The following apply to error codes 501-xx through 516-xx:  1. Disconnect external monitor and test with internal LCD display. 2. Replace the display assembly and retest. 3. Replace the system board and retest.
502-xx	Video memory test failed	
503-xx	Video attribute test failed	
504-xx	Video character set test failed	
505-xx	Video 80 × 25 mode 9 × 14 character cell test failed	
506-xx	Video 80 × 25 mode 8 × 8 character cell test failed	
507-xx	Video 40 × 25 mode test failed	
508-xx	Video 320 × 200 mode color set 0 test failed	
509-xx	Video 320 × 200 mode color set 1 test failed	
510-xx	Video 640 × 200 mode test failed	
511-xx	Video screen memory page test failed	
512-xx	Video gray scale test failed	
514-xx	Video white screen test failed	
516-xx	Video noise pattern test failed	
2402-xx	Video memory test failed	The following steps apply to error codes 2402-xx through 2456-xx:  1. Run the Configuration and Diagnostics Utilities. 2. Replace the display assembly and retest. 3. Replace the system board and retest.
2403-xx	Video attribute test failed	
2404-xx	Video character set test failed	
2405-xx	Video 80 × 25 mode 9 × 14 character cell test failed	
2406-xx	Video 80 × 25 mode 8 × 8 character cell test failed	
2408-xx	Video 320 × 200 mode color set 0 test failed	
2409-xx	Video 320 × 200 mode color set 1 test failed	
2410-xx	Video 640 × 200 mode test failed	
2411-xx	Video screen memory page test failed	
2412-xx	Video gray scale test failed	
2414-xx	Video white screen test failed	
2416-xx	Video noise pattern test failed	
2418-xx	ECG/VGC memory test failed	
2419-xx	ECG/VGC ROM checksum test failed	
2421-xx	ECG/VGC 640 × 200 graphics mode test failed	
2422-xx	ECG/VGC 640 × 350 16 color set test failed	
2423-xx	ECG/VGC 640 × 350 64 color set test failed	
2424-xx	ECG/VGC monochrome text mode test failed	
2425-xx	ECG/VGC monochrome graphics mode test failed	
2431-xx	640 × 480 graphics test failure	
2432-xx	320 × 200 graphics (256 color mode) test failure	
2448-xx	Advanced VGA Controller test failed	
2451-xx	132-column Advanced VGA test failed	
2456-xx	Advanced VGA 256 Color test failed	
2458-xx	Advanced VGA BitBLT test	The following step applies to error codes 2458-xx through 2480-xx:  Replace the system board and retest.
2468-xx	Advanced VGA DAC test	
2477-xx	Advanced VGA data path test	
2478-xx	Advanced VGA BitBLT test	
2480-xx	Advanced VGA LineDraw test	
Audio Test Error Codes		
3206-xx	Audio System Internal Error	Replace the system board and retest.
TouchPad/Pointing Device Interface Test Error Codes		
8601-xx	Mouse test failed	1. Replace the TouchPad and retest. 2. Replace the system board and retest.
8602-xx	Interface test failed	
CD/DVD Drive Test Error Codes		
3301-xx	CD/DVD drive read test failed	1. Replace the CD/DVD and retest. 2. Verify that the speakers are connected. 3. Verify that drivers are loaded and properly installed. 4. Replace the CD/DVD drive and retest. 5. Replace the system board and retest.
3305-xx	CD/DVD drive seek test failed	
6600-xx	ID test failed	
6605-xx	Read test failed	
6608-xx	Controller test failed	
6623-xx	Random read test failed	

[Back to top](#)



# Maintenance & Service Guide

**Presario 1800 Series  
Models: 1805 and 1810**

[Home Page](#) | [Notice](#) | [Preface](#) | [Product Description](#) | [Troubleshooting](#)  
[Illustrated Parts Catalog](#) | [Removal & Replacement Procedures](#) | [Specifications](#)  
[Pin Assignments](#) | [Battery Pack Operations](#)

---

## Troubleshooting Without Diagnostics

This section provides information about how to identify and correct some common hardware, memory, and software problems. It also explains several types of common messages that may be displayed on the screen. The following pages contain troubleshooting information on:

[Audio](#)

[Battery/Battery gauge](#)

[CD/DVD drive](#)

[Diskette/Diskette drive](#)

[Display](#)

[Hard drive](#)

[Hardware Installation](#)

[Memory](#)

[PC Card](#)

[Power](#)

[Printer](#)

[Touch Pad](#)

[Keyboard/Numeric keypad](#)

Since symptoms can appear to be similar, carefully match the symptoms of the computer malfunction against the problem description in the Troubleshooting tables to avoid a misdiagnosis.

**WARNING:** To avoid a potential shock hazard during troubleshooting procedures, disconnect all power sources before removing the keyboard cover or the display bezel.

### Before Replacing Parts

Verify that cables are connected properly to the suspected defective parts.

- n Run Computer Setup after connecting external devices.
- n Verify that all required device drivers are installed.
- n Verify that all required changes have been made to the CONFIG.SYS file.
- n Verify that all required changes have been made to the AUTOEXEC.BAT file.
- n Verify that all printer drivers have been installed for each application.



# Maintenance & Service Guide

## Presario 1800 Series Models: 1805 and 1810

[Home Page](#) | [Notice](#) | [Preface](#) | [Product Description](#) | [Troubleshooting](#)  
[Illustrated Parts Catalog](#) | [Removal & Replacement Procedures](#) | [Specifications](#)  
[Pin Assignments](#) | [Battery Pack Operations](#)

## Solving Minor Problems

Some minor problems and possible solutions are outlined in the following tables. If the problem appears related to a software application, check the documentation provided with the software.

### Solving Audio Problems

Some common audio problems and solutions are listed in the following table.

Solving Audio Problems		
Problem	Probable Cause	Solution(s)
Computer does not beep after the Power-On Self-Test (POST).	This is typical; it indicates successful completion of the Power-On Self-Test (POST).	No action is required.

### Solving Battery Pack and Battery Gauge Problems

Some common causes and solutions for battery pack problems are listed in the following table. The "Solving Power Problems" section in this chapter may also be applicable.

Solving Battery Pack and Battery Gauge Problems		
Problem	Probable Cause	Solution(s)
Computer won't turn on when battery pack is inserted and power cord is unplugged.	Battery pack is discharged.	Connect the computer to an external power source and charge the battery pack.  Replace the battery pack with a fully charged battery pack.
		Check the battery connectors on the system board to verify they are evenly spaced and that they are not bent or broken.
Computer is beeping and battery LED icon is blinking.	Battery charge is low.	Immediately save any open file(s). Then do any one of the following: <ul style="list-style-type: none"> <li>• Connect the computer to an external power source to charge the battery pack.</li> <li>• Turn off the computer or initiate Hibernation until you can find another power source or charge the battery pack.</li> </ul>
Computer battery LED icon (front on the unit) blinks to indicate low battery condition, but computer does not beep.	Volume is turned down too low.	Adjust the volume.
Battery LED icon doesn't light and battery pack won't fast charge.	Battery pack is already charged.	No action is necessary.
	Battery pack was exposed to temperature extremes.	Allow time for the battery pack to return to room temperature.
	Battery pack is at end of its life.	Replace battery pack.
You have to set the date and time every time you turn on the computer.	RTC battery is dead.	Replace the RTC battery.

Problem	Probable Cause	Solution(s)
Battery charge does not last as long as expected.	Battery is being exposed to high temperatures or extremely cold temperatures.	Keep the battery pack within the recommended operating temperature range 50° F to 104° F (10° C to 40° C) or recommended storage range -4° F to 86° F (-20° C to 30° C). Recharge the battery pack.
	Battery has partially self-discharged.	Recharge the battery. Discharge the battery completely and then recharge it.
	Power management is disabled.	Set a power management level in Computer Setup.
	An external device or PC Card is draining the battery.	Turn off or disconnect external devices when not using them.
Battery pack is warm to the touch after charging.	Normal warming has occurred due to charging.	No action is required.
Battery pack operating time is far less than the documented average operating time.	Power management is turned off or disabled.	Enable power management in Computer Setup and in Windows Power Properties.
	An external device or PC Card is draining the battery.	Turn off or disconnect external devices when not using them.
	Battery pack has partially self-discharged.	Condition the battery pack by fully charging, fully discharging, then fully recharging it.  To maintain the charge, leave battery packs in the computer when it is connected to external power.  If the computer is disconnected from external power for more than two weeks, remove battery packs from the computer to reduce the discharge rate.
	Battery pack is being exposed to high temperatures or extremely cold temperatures.	Keep the battery pack within the recommended temperature ranges. Operating: 50° F to 104° F (10° C to 40° C) Storage: -4° F to 86° F (-20° C to 30° C)  Recharge the battery pack.

### Solving CD/DVD Drive Problems

Some common causes and solutions for CD/DVD drive problems are listed in the following table.

Solving CD/DVD Drive Problems		
Problem	Probable Cause	Solution(s)
CD/DVD drive cannot read a compact disc or digital versatile disc.	Compact disc or digital versatile disc is upside down or is improperly inserted in the CD/DVD drive.	Open the CD/DVD loading tray, lay the compact disc or digital versatile disc in it (label side up), then close the tray.
	CD is CD Plus or Pregap/Track 0 type.	Cannot read these type CDs in 24x. Remove the CD.

### Solving Diskette and Diskette Drive Problems

Some common causes and solutions for diskette and diskette drive problems are listed in the following table.

Solving Diskette and Diskette Drive Problems		
Problem	Probable Cause	Solution(s)
Diskette drive cannot write to a diskette.	Diskette is write-protected.	Disable the diskette's write-protect feature or use a diskette that is not write-protected.
	Computer is writing to the wrong drive.	Check the drive letter in the path statement.
	Not enough space is left on the diskette.	Use another diskette.
	Drive error has occurred.	Run Computer Checkup from the Compaq Diagnostics diskette.
	Diskette is not formatted.	Format the diskette. At the system prompt, enter  FORMAT A:
Diskette drive cannot read a diskette.	The wrong type of diskette is being used.	Use the type of diskette required by the drive.
	Diskette has a bad sector.	Copy files to hard drive or another diskette. Reformat bad floppy.
	Drive error has occurred.	Run Computer Checkup from the Compaq Diagnostics diskette.
	Diskette is not formatted.	Format the diskette. At the system prompt, enter  FORMAT A:
Cannot boot from diskette.	Bootable diskette is not in drive A.	Put the bootable diskette in drive A.
	Diskette Boot has incorrect setting in Computer Setup.	Run Computer Setup and set diskette as first to boot.

### Solving Display Problems

This section lists some common causes and solutions for computer display and external monitor problems.

You can perform a monitor self-test on an external VGA color or monochrome monitor by disconnecting the monitor from the computer. To do so, complete the following steps:

1. Turn off the monitor.
2. Turn off the computer.
3. Disconnect the monitor signal cable from the computer.
4. Turn on the monitor and allow it to warm up for one minute.

The display should be white. A narrow black border may also appear on the left and right sides of the display. Either of these displays indicates that the monitor is working properly.

Solving Display Problems		
Problem	Probable Cause	Solution(s)
Screen is dim.	Control for brightness (if applicable) is not set properly.	Adjust the Brightness of the display by using <b>Fn + F7</b> ( ) or <b>Fn + F8</b> ( - ).
	Computer screen is in direct light.	Tilt display or move computer.
Screen is blank.	Screen save was initiated by Power Management due to lack of user activity.	Press any key or touch the Touch Pad.
	Display has overheated.	If computer is in direct sunlight, move it and allow it to cool off.
Icon is blank and the Suspend display is flashing.	System is in Suspend mode.	Press any key or touch the Touch Pad.
Internal display is blank and the screen on an external monitor displays information.	Display function was switched to the external monitor.	Use <b>Fn + F2</b> to switch between <b>LCD</b> or <b>CRT</b> .

Problem	Probable Cause	Solution(s)
Internal display flashes or has garbled characters when computer is connected to external monitor.	Using 1024 × 768 or higher resolution on external monitor and have toggled back to internal display, which supports up to 800 × 600.	Restart the computer.
The light tubes on the edge of the display panel do not light up at all and Power-On Self-Test (POST) completes when the unit is powered up.**	Improper backlight or display cable connections	Replace the display assembly.
	Defective inverter board.	Replace the display assembly.
	Defective display panel.	Replace the display assembly.
	Defective system board.	Replace the system board.
The light tubes on the edge of the display panel do not light up at all and Power-On Self-Test (POST) does not complete when the unit is powered up.**	Defective system board.	Replace the system board.
Backlight (brightness) cannot be adjusted with <b>Fn + F7</b> ( ) or <b>Fn + F8</b> ( - ).***	Improper display cable connections.	1. Reseat the display cable to the system board.  2. Replace the display assembly.
	Defective inverter board.	Replace the display assembly.
	Defective display cable.	Replace the display assembly.
	Defective system board.	Replace the system board.
	Defective inverter board.	Replace the display assembly.
	Defective display cable.	Replace the display assembly.
	Defective system board.	Replace the system board.

\*\* This problem indicates that the backlight or its power circuitry has failed. Since you cannot observe the POST result on the display panel when the backlight is not functioning, connect the unit to an external monitor before powering the unit up. If an external monitor is not available, verify that POST completes by opening and closing the display, listening for the single or double beep, and watching for the LEDs turn on at the front of the computer.

Problem	Probable Cause	Solution(s)
This display panel has a continuous pattern across it (e.g., a "jailbars" pattern), has a single color on it, or has garbled graphics across the entire panel. This failure is for patterns across the entire panel (not just on one section).	Improper display cable connections	Reseat the display cable to the following until the problem is solved: <ol style="list-style-type: none"> <li>1. System board</li> <li>2. Display assembly</li> </ol>
	Defective display cable.	Replace the display assembly.
	Defective inverter board.	Replace the display assembly.
	Defective system board.	Replace the system board.

To perform a "self-test" on an external VGA color monitor, complete the following steps: The screen should be white. A narrow black border may also appear on the left and right sides of the display. Either of these displays indicates that the monitor is working properly.

### Solving Hard Drive Problems

Some common causes and solutions for hard drive problems are listed in the following table.

<b>CAUTION:</b>	To prevent loss of information, always maintain an up-to-date backup of your hard drive at all times, in case of errors or failures.
-----------------	--

Solving Hard Drive Problems		
Problem	Probable Cause	Solution(s)
Reading hard drive takes an unusually long time after restarting the computer.	System entered Hibernation due to low battery condition and is now exiting from it.	Give the system time to restore the previously saved data to its exact state before Hibernation.
Hard drive error occurs.	Hard drive has bad sectors or has failed.	Run Computer Checkup.
Hard drive does not work.	Hard drive is not seated properly.	Turn off and unplug the computer, remove the battery pack, and remove and then reinstall the hard drive.

### Solving Hardware Installation Problems

Some common causes and solutions for hardware installation problems are listed in the following table.

Solving Hardware Installation Problems		
Problem	Probable Cause	Solution(s)
A new device is not recognized as part of the computer system.	Cable(s) of new external device are loose or power cables are unplugged.	Ensure that all cables are properly and securely connected.
	Power switch of new external device is not turned on.	Turn off the computer, turn on the external device, then turn on the computer to integrate the device with the computer system.
	Device is not seated properly.	Turn off the computer and reinsert the device.

### Solving Keyboard/Numeric Keypad Problems

Some common causes and solutions for keyboard/numeric keypad problems are listed in the following table.

Solving Keyboard/Numeric Keypad Problems		
Problem	Probable Cause	Solution(s)
Embedded numeric keypad on computer keyboard is disabled.	Num Lock function is not enabled.	Press the <b>Shift+NumLk</b> keys to enable the Num Lock function and embedded numeric keypad. The Num Lock icon on the status panel turns on.
Embedded numeric keypad is on.	External numeric keypad is connected to the computer.	Disconnect the external numeric keypad from the computer.

### Solving Memory Problems

Some common causes and solutions for memory problems are listed in the following table.

Solving Memory Problems		
Problem	Probable Cause	Solution(s)
Memory count during Power-On Self-Test (POST) is incorrect.	Optional memory expansion card is installed incorrectly, is incompatible with the computer, or is defective.	Ensure that the optional memory expansion card is installed correctly.
"Out of Memory" message is displayed on the screen or insufficient memory error occurs during operation.	System ran out of memory for the application.	Check the application documentation for memory requirements.  Install additional memory.
	Too many TSR (terminate-and-stay-resident) applications are running.	Remove from memory any TSR applications that you do not need.

### Solving Minor Problems (continued)



## Maintenance & Service Guide

**Presario 1800 Series  
Models: 1805 and 1810**

| [Home Page](#) | [Notice](#) | [Preface](#) | [Product Description](#) | [Troubleshooting](#)  
[Illustrated Parts Catalog](#) | [Removal & Replacement Procedures](#) | [Specifications](#)  
[Pin Assignments](#) | [Battery Pack Operations](#)

### Solving PC Card Problems

Some common causes and solutions for PC Card problems are listed in the following table.

<b>Solving PC Card Problems</b>		
<b>Problem</b>	<b>Probable Cause</b>	<b>Solution(s)</b>
When turned on, the computer does not beep when a PC Card is inserted.	Card is not inserted properly.	Ensure the card is inserted in the correct orientation.
	PC Card beeps are disabled.	Double-click the PC Card icon in the Control Panel, click the <b>Global Settings</b> tab, the enable PC Card sound effects.
	Speaker is turned off or volume is turned down.	Press <b>volume buttons</b> to turn the speaker on, then increase the volume.
	PC Card drivers are not installed.	Double click the <b>Add New Hardware</b> icon in the Control Panel for installation instructions.  If PC Card or drivers are not compatible with Windows, install drivers and use the PC Card in MS-DOS mode.
	Card or card driver is not supported.	Contact your Compaq authorized service provider for a list of PC Cards tested successfully in Compaq PC Card platforms.
PC Card modem, fax, or network card does not work.	Card is not fully inserted into the slot or is not inserted properly.	Ensure the card is inserted in the correct orientation.
	Telephone cord is not plugged in all the way.	Check and secure telephone connection.
	Necessary drivers are not installed (turned on).	Install drivers.
PC Card modem or fax card does not work.	You are trying to access the card using the wrong COM port.	See <a href="#">Specifications</a> to verify COM port.
	The card conflicts with a serial device.	See <a href="#">Specifications</a> to verify address.
	The card is not supported.	Use supported cards only.

Modem network PC Card does not work.	Network driver is not installed or is not set up properly.	Install driver.
	Telephone cord is not properly connected.	Verify telephone connection.
Memory or storage card does not work.	SRAM and flash memory cards require the memory card driver to be loaded (turned on).  Flash memory cards require the Microsoft FlashFile System to be loaded.  Hard drives on flash mass storage cards require the PC Card ATA driver to be loaded.	Install driver.
	You are trying to access the hard drive card using the wrong drive letter.	Double-click <b>My Computer</b> to verify the drive letter assigned to the card.
	The card is not supported.	Contact your Compaq authorized service provider for a list of PC Cards tested successfully in Compaq PC Card platforms.

### Solving Power Problems

Also see "Solving Battery and Battery Gauge Problems" in this section.

<b>Solving Power Problems</b>		
<b>Problem</b>	<b>Probable Cause</b>	<b>Solution(s)</b>
Computer won't turn on and battery pack is not inserted.	Computer is not connected to a power source.	Insert battery or connect an external power source.
	Power cords to the external power source are unplugged.	Ensure that power cords connecting the computer and the external power source are plugged in properly.
	Power adapter is defective.	Replace AC Adapter and restart.
Computer turned off while it was left unattended and the power icon is off.	System board is defective.	Replace the system board.
	System initiated Hibernation due to a critical low-battery condition.	Replace the battery pack with a fully charged battery pack or connect the computer to an external power source. Then turn on the computer.
	System initiated Hibernation after a preset timeout.	Turn on the computer.

### Solving Printer Problems

If you experience problems printing, run a printer self-test. Refer to the documentation provided with your printer for instructions. If the self-test fails, it is a printer-specific problem. Also refer to the printing section of your application documentation.

<b>Solving Printer Problems</b>		
<b>Problem</b>	<b>Probable Cause</b>	<b>Solution(s)</b>
Printer will not turn on.	The signal cable may not be connected properly, or the printer is unplugged.	Ensure that the signal cable is properly connected and that the power cord is connected to the electrical outlet.
Printer will not print.	Printer is not turned on or is off line.	Turn the printer on and set it to on line.
	The device drivers for your application are not installed.	Refer to the printer documentation to install the correct printer driver.
	Printer that is set up for a network is not connected to the network.	Connect the printer to the network.
	Printer cable is too long, unshielded, or defective.	Replace the cable.
	Paper tray is empty.	Fill the paper tray with paper and set the printer to online.
Printer prints garbled information.	Correct printer drivers are not installed.	Refer to the printer documentation to install the correct printer driver.
	Cable is not connected properly.	Ensure that the printer signal cable is properly connected to the computer.
	Cable is defective.	Replace the printer cable and retest.

### Solving Touch Pad/Pointing Device Problems

Some common causes and solutions for Touch Pad/pointing device problems are listed in the following table.

<b>Solving Touch Pad/Pointing Device Problems</b>		
<b>Problem</b>	<b>Cause</b>	<b>Solution(s)</b>
Touch Pad or mouse does not work.	Incorrect or no device driver is installed.	Install the device driver and add to the AUTOEXEC.BAT file or CONFIG.SYS file.
	The device driver is not installed in Windows.	Install the Touch Pad/mouse driver in Windows.
External mouse does not work.	Mouse is not securely connected or is connected to an incorrect external connector.	Ensure that the mouse is securely connected to the appropriate external connector.
Touch Pad or mouse does not work even though the device is enabled in Windows.	Mouse is not enabled.	Enter MOUSE at the system prompt to activate the mouse device driver.
		Add a line in the AUTOEXEC.BAT file to automatically activate the mouse device driver each time computer is turned on or restarted.
	Cable not properly seated in Touch Pad board.	Reseat cable.
	Defective Touch Pad board.	Replace Touch Pad board.
	Defective system board.	Replace system board.
	Device driver is not correctly installed in Windows.	Install the appropriate device driver in Windows.
Cursor skips or moves abnormally when using the Touch Pad.	The Touch Pad needs to be cleaned.	Clean the Touch Pad with a cloth dampened with alcohol or an ammonia-based glass cleaner. Wipe up liquid with a dry cloth.

# Maintenance & Service Guide

**Presario 1800 Series  
Models: 1805 and 1810**

[Home Page](#) | [Notice](#) | [Preface](#) | [Product Description](#) | [Troubleshooting](#)  
[Illustrated Parts Catalog](#) | [Removal & Replacement Procedures](#) | [Specifications](#)  
[Pin Assignments](#) | [Battery Pack Operations](#)

## System Unit

### System Unit

#### Boards

#### Display Assembly

#### Mass Storage Devices

#### Miscellaneous Cable Kit

#### Cables

#### Miscellaneous Hardware and Plastics Kit

#### Miscellaneous Parts

#### Documentation and Software

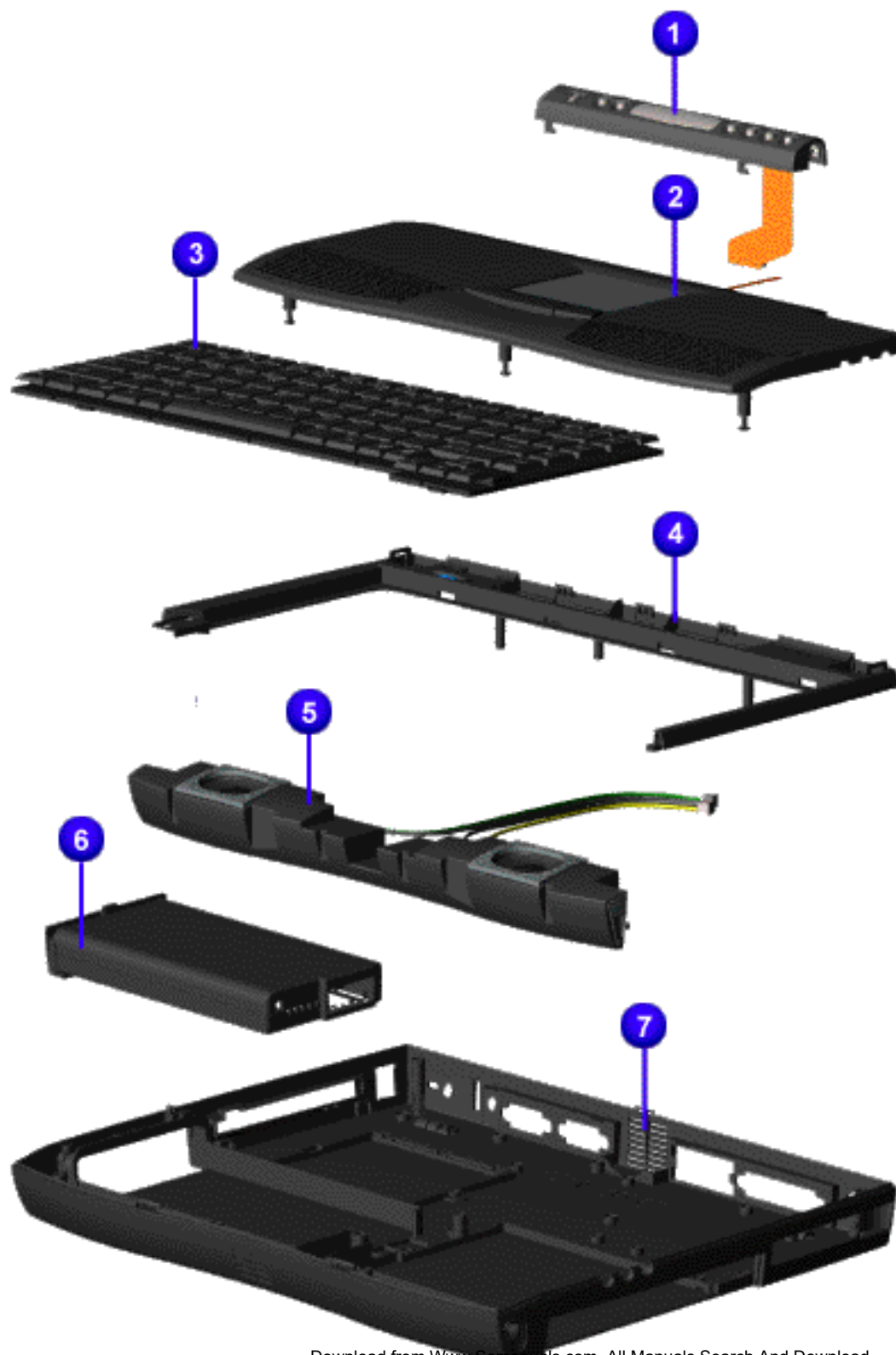

Description	Spare Part Number
1. Status Panel	293737-001
2. Palmrest Cover	332226-001
3. Keyboards	
4. Upper CPU Cover with Power Switch Connector (Top Plastics)	293739-001
5. Speaker Assembly w/Cable	293883-001
6. Battery Pack, Li ion	330936-001
7. CPU Base Assembly Enclosure, (Bottom Plastics)	331156-001

# Maintenance & Service Guide

**Presario 1800 Series  
Models: 1805 and 1810**

[Home Page](#) | [Notice](#) | [Preface](#) | [Product Description](#) | [Troubleshooting](#)  
[Illustrated Parts Catalog](#) | [Removal & Replacement Procedures](#) | [Specifications](#)  
[Pin Assignments](#) | [Battery Pack Operations](#)

## Boards

<a href="#">System Unit</a>
<b><a href="#">Boards</a></b>
<a href="#">Display Assembly</a>
<a href="#">Mass Storage Devices</a>
<a href="#">Miscellaneous Cable Kit</a>
<a href="#">Cables</a>
<a href="#">Miscellaneous Hardware and Plastics Kit</a>
<a href="#">Miscellaneous Parts</a>
<a href="#">Documentation and Software</a>

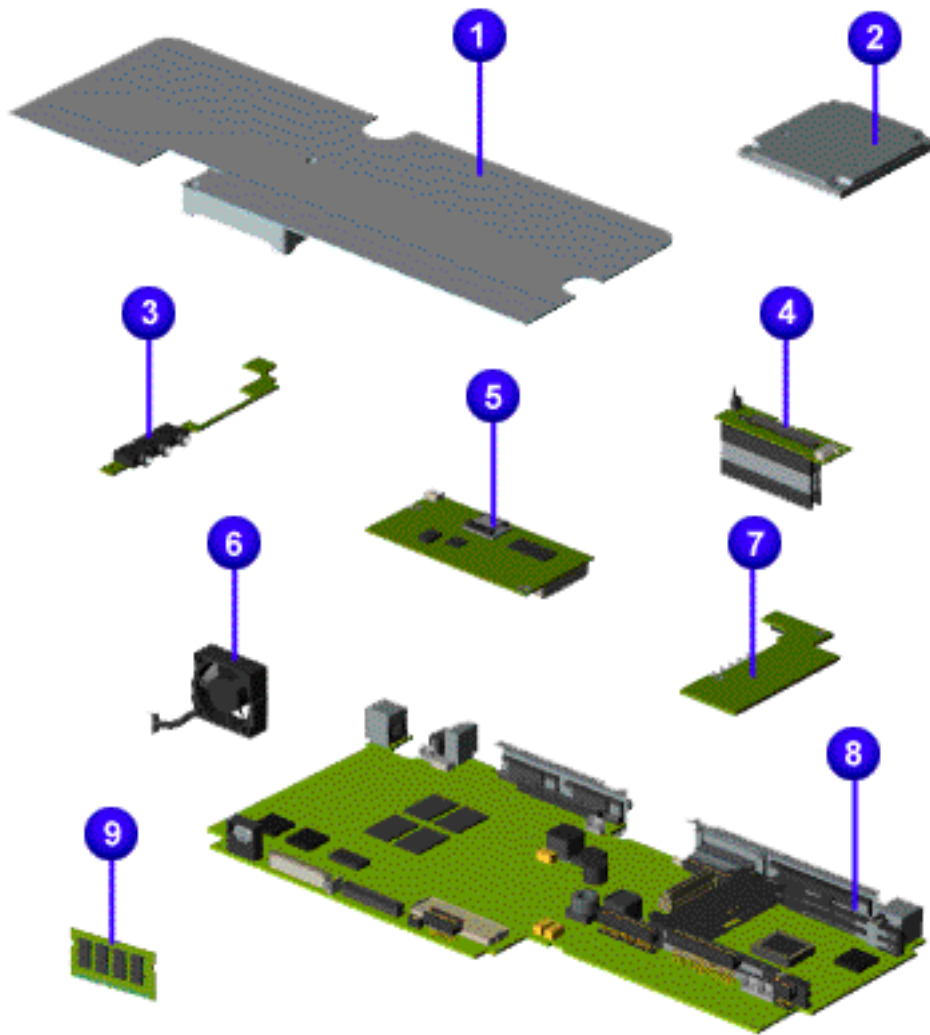

Description	Spare Part Number
1. Heatspreader	331164-001
2. Processors	
3. Audio Board	331010-001
4. LCD Interface Board TFT w/header	293156-001
5. Modems	
6. Fan w/Cable	332228-001
7. Voltage Converter	331019-001
8. System Board, w/o processor	331009-001
System Board, w/o processor	347731-001
9. Memory Module 16-MB 32-MB 64-MB	293726-001 293727-001 332208-001



# Maintenance & Service Guide

**Presario 1800 Series  
Models: 1805 and 1810**

[Home Page](#) | [Notice](#) | [Preface](#) | [Product Description](#) | [Troubleshooting](#)  
[Illustrated Parts Catalog](#) | [Removal & Replacement Procedures](#) | [Specifications](#)  
[Pin Assignments](#) | [Battery Pack Operations](#)

[System Unit](#)

[Boards](#)

[Display  
Assembly](#)

[Mass Storage  
Devices](#)

[Miscellaneous  
Cable Kit](#)

[Cables](#)

[Miscellaneous  
Hardware and  
Plastics Kit](#)

[Miscellaneous  
Parts](#)

[Documentation  
and Software](#)



Description	Spare Part Number
Display Assembly w/Cable, 13.3 inch TFT	331012-001

# Maintenance & Service Guide

Presario 1800 Series  
Models: 1805 and 1810

[Home Page](#) | [Notice](#) | [Preface](#) | [Product Description](#) | [Troubleshooting](#)  
[Illustrated Parts Catalog](#) | [Removal & Replacement Procedures](#) | [Specifications](#)  
[Pin Assignments](#) | [Battery Pack Operations](#)

## Mass Storage Devices

[System Unit](#)

[Boards](#)

[Display  
Assembly](#)

[Mass Storage  
Devices](#)

[Miscellaneous  
Cable Kit](#)

[Cables](#)

[Miscellaneous  
Hardware and  
Plastics Kit](#)

[Miscellaneous  
Parts](#)

[Documentation  
and Software](#)

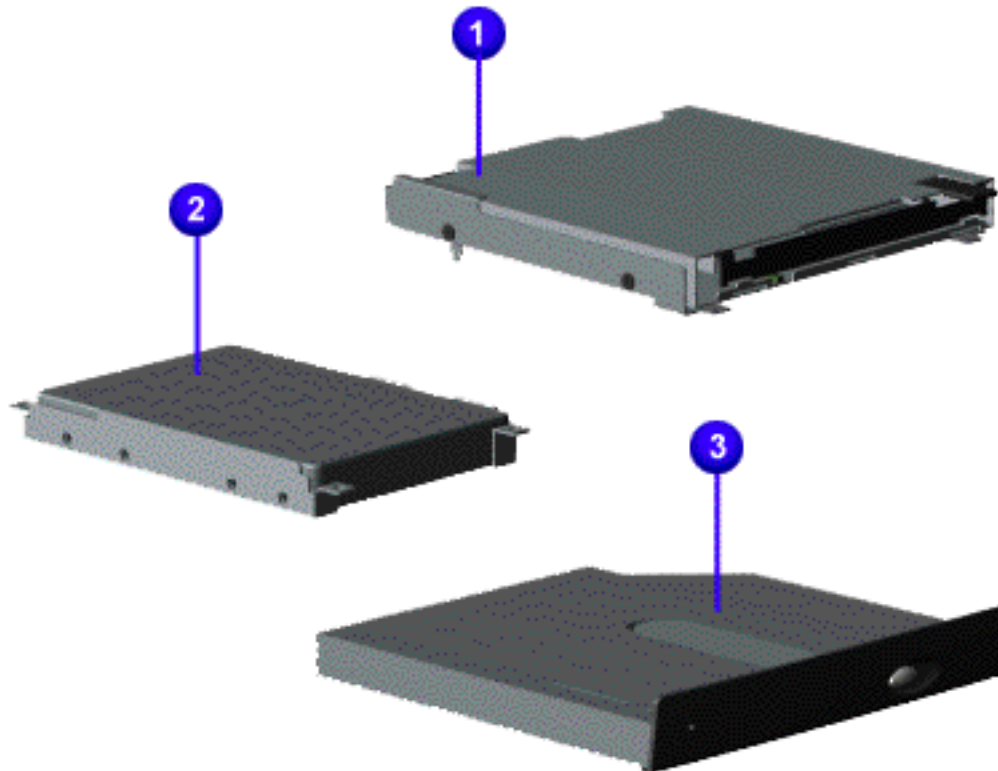

Description	Spare Part Number
1. Diskette Drive w/Cable, 1.44 MB, 3.5 inch	331165-001
2. Hard Drives	
3. 24x MAX CD Drive	330967-001
3. DVD Drive	347549-001

# Maintenance & Service Guide

Presario 1800 Series  
Models: 1805 and 1810

[Home Page](#) | [Notice](#) | [Preface](#) | [Product Description](#) | [Troubleshooting](#)  
[Illustrated Parts Catalog](#) | [Removal & Replacement Procedures](#) | [Specifications](#)  
[Pin Assignments](#) | [Battery Pack Operations](#)

## Miscellaneous Cables Kit

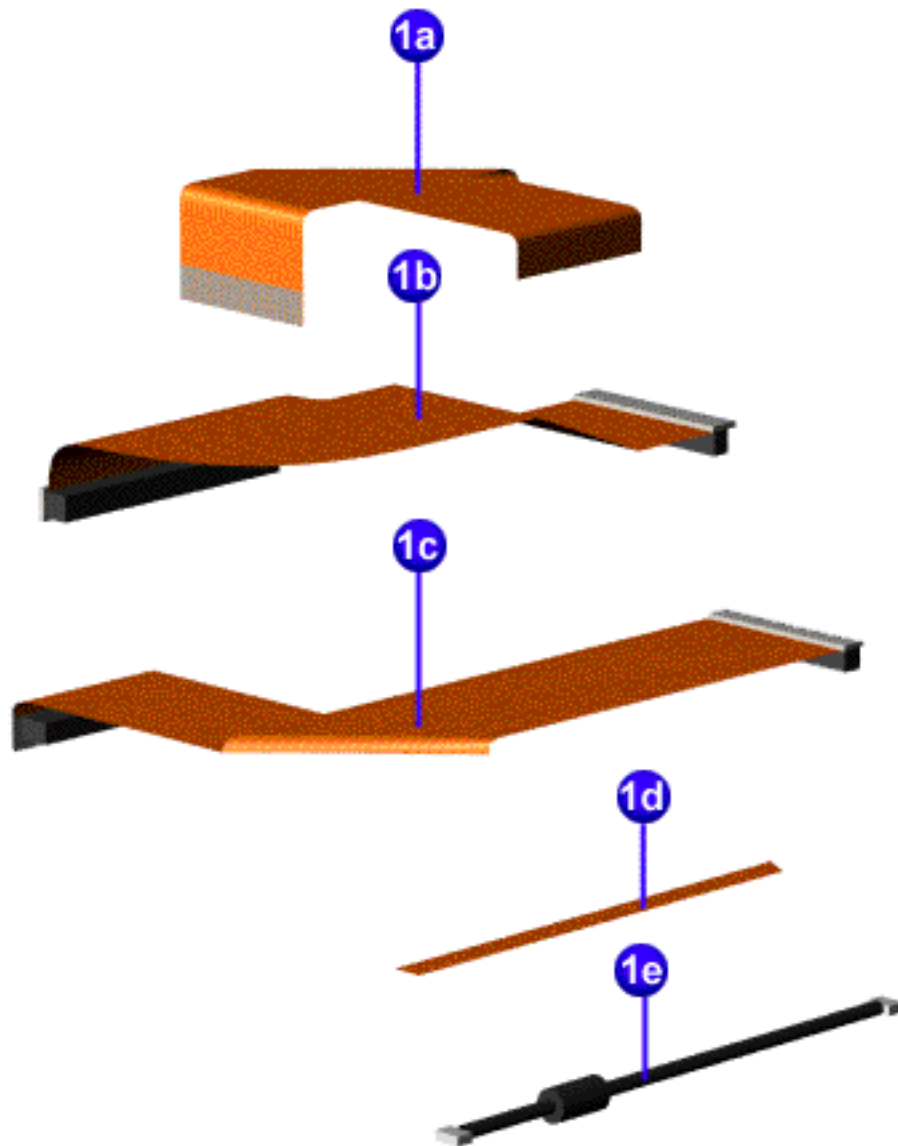

Miscellaneous Cables Kit  
Spare Part Number: 331167-001

Description	Quantity
1a. Cable, Diskette Drive	1
1b. Cable, Hard Drive	1
1c. Cable, CD/DVD Drive	1
1d. Cable, TouchPad SW Board	1
1e. Cable, Fax/Modem	1

[System Unit](#)

[Boards](#)

[Display  
Assembly](#)

[Mass Storage  
Devices](#)

[Miscellaneous  
Cable Kit](#)

[Cables](#)

[Miscellaneous  
Hardware and  
Plastics Kit](#)

[Miscellaneous  
Parts](#)

[Documentation  
and Software](#)

# Maintenance & Service Guide

**Presario 1800 Series  
Models: 1805 and 1810**

[Home Page](#) | [Notice](#) | [Preface](#) | [Product Description](#) | [Troubleshooting](#)  
[Illustrated Parts Catalog](#) | [Removal & Replacement Procedures](#) | [Specifications](#)  
[Pin Assignments](#) | [Battery Pack Operations](#)

## [System Unit](#)

## [Boards](#)

## [Display Assembly](#)

## [Mass Storage Devices](#)

## [Miscellaneous Cable Kit](#)

## [Cables](#)

## [Miscellaneous Hardware and Plastics Kit](#)

## [Miscellaneous Parts](#)

## [Documentation and Software](#)

### Power Cords

Description	Spare Part Number
Power Cord	

### Modem Cables

Description	Spare Part Number
1. Modem	



# Maintenance & Service Guide

Presario 1800 Series  
Models: 1805 and 1810

[Home Page](#) | [Notice](#) | [Preface](#) | [Product Description](#) | [Troubleshooting](#)  
[Illustrated Parts Catalog](#) | [Removal & Replacement Procedures](#) | [Specifications](#)  
[Pin Assignments](#) | [Battery Pack Operations](#)

## Miscellaneous Hardware and Plastics Kit

### System Unit

### Boards

### Display Assembly

### Mass Storage Devices

### Miscellaneous Cable Kit

### Cables

### Miscellaneous Hardware and Plastics Kit

### Miscellaneous Parts

### Documentation and Software

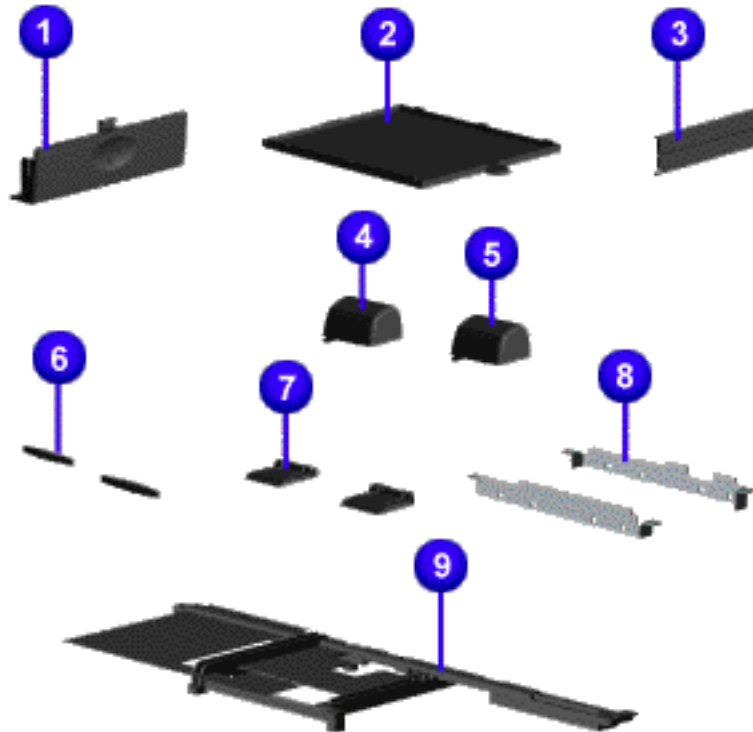

Miscellaneous Hardware and Plastics Kit  
Spare Part Number: 293761-001

### Description

### Quantity

1. Door, Battery Pack

1 each

2. Cover, Memory Module

1 each

3. Door, PCMCIA

2 each

4. Hinge (Clutch) Cover, Left

1 each

5. Hinge (Clutch) Cover, Right

1 each

6. Rubber Foot

10 each

7. Stand Foot (plastic)

10 each

8. Hard Drive Mounting Bracket

1 each

9. Stiffener Bracket

1 each

# Maintenance & Service Guide

**Presario 1800 Series  
Models: 1805 and 1810**

[Home Page](#) | [Notice](#) | [Preface](#) | [Product Description](#) | [Troubleshooting](#)  
[Illustrated Parts Catalog](#) | [Removal & Replacement Procedures](#) | [Specifications](#)  
[Pin Assignments](#) | [Battery Pack Operations](#)

## Miscellaneous Parts

[System Unit](#)

[Boards](#)

[Display  
Assembly](#)

[Mass Storage  
Devices](#)

[Miscellaneous  
Cable Kit](#)

[Cables](#)

[Miscellaneous  
Hardware and  
Plastics Kit](#)

[Miscellaneous  
Parts](#)

[Documentation  
and Software](#)

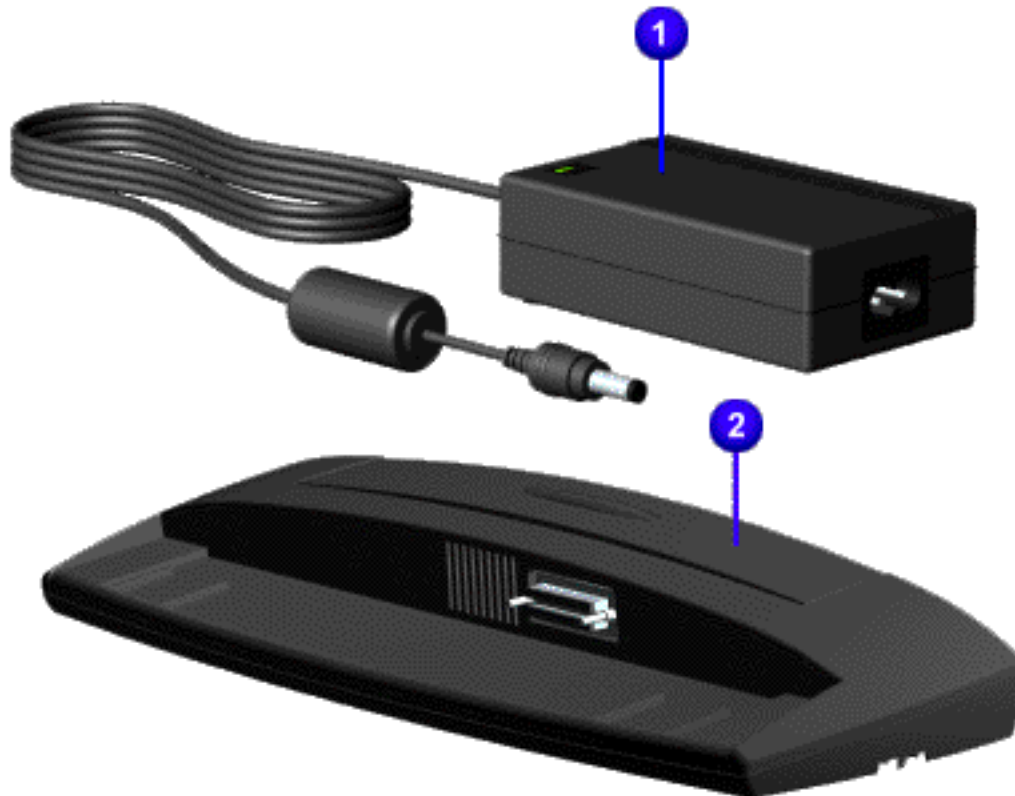

Description	Spare Part Number
1. AC Adapter	298239-001
2. Port Replicator	293857-001
Clock Battery (Not Shown)	117099-001
Miscellaneous Screw Kit (Not Shown)	293760-001
Logo Kit (Not Shown)	203727-001
Return Kit (Not Shown)	293799-001
PCMCIA Bracket (Not Shown)	331166-001

# Maintenance & Service Guide

**Presario 1800 Series  
Models: 1805 and 1810**

[Home Page](#) | [Notice](#) | [Preface](#) | [Product Description](#) | [Troubleshooting](#)  
[Illustrated Parts Catalog](#) | [Removal & Replacement Procedures](#) | [Specifications](#)  
[Pin Assignments](#) | [Battery Pack Operations](#)

## Documentation and Software

<b>System Unit</b>	<b>Description</b>	<b>Spare Part Number</b>		
<a href="#">Boards</a>	Quick Restore CD			
<a href="#">Display Assembly</a>	Not Available			
<a href="#">Mass Storage Devices</a>	Not Available			
<a href="#">Miscellaneous Cable Kit</a>	Not Available			
<a href="#">Cables</a>	Not Available			
<a href="#">Miscellaneous Hardware and Plastics Kit</a>	Not Available			
<a href="#">Miscellaneous Parts</a>	Quick Reference Guide			
<a href="#">Documentation and Software</a>	QuickFind for Windows, North America, Latin America, Asia Pacific			
	QuickFind for Windows, Europe, Middle East, Africa			
	* QuickFind is updated monthly. To complete the QuickFind part number, add the suffix from the table below for the desired month. If you do not specify the 3-digit suffix, the default is the current month in which the order is placed.			
	<b>QuickFind Part Number Suffix</b>			
	<b>Suffix</b>	<b>Month</b>	<b>Suffix</b>	<b>Month</b>
	-001	January	-007	July
	-002	February	-008	August
	-003	March	-009	September
	-004	April	-010	October
	-005	May	-011	November
	-006	June	-012	December

# Maintenance & Service Guide

Presario 1800 Series  
Models: 1805 and 1810

[Home Page](#) | [Notice](#) | [Preface](#) | [Product Description](#) | [Troubleshooting](#)  
[Illustrated Parts Catalog](#) | [Removal & Replacement Procedures](#) | [Specifications](#)  
[Pin Assignments](#) | [Battery Pack Operations](#)

## Electrostatic Discharge

A sudden discharge of static electricity from a finger or other conductor can destroy static-sensitive devices or microcircuitry. Often the spark is neither felt nor heard, but damage occurs. An electronic device exposed to electrostatic discharge (ESD) may not be affected at all and will work perfectly throughout a normal cycle. Although, it may function normally for a while, then degrade in the internal layers, reducing its life expectancy.

Networks built into many integrated circuits provide some protection, but in many cases, the discharge contains enough power to alter device parameters or melt silicon junctions.

## Generating Static

The table shows how different activities generate static electricity and at different electrostatic voltage levels.

Typical Electrostatic Voltages			
	Relative Humidity		
Event	10%	40%	55%
Walking across carpet	35,000 V	15,000 V	7,500 V
Walking across vinyl floor	12,000 V	5,000 V	3,000 V
Motions of bench worker	6,000 V	800 V	400 V
Removing DIPS from plastic tubes	2,000 V	700 V	400 V
Removing DIPS from vinyl trays	11,500 V	4,000 V	2,000 V
Removing DIPS from Styrofoam	14,500 V	5,000 V	3,500 V
Removing bubble pack from PCBs	26,000 V	20,000 V	7,000 V
Packing PCBs in foam-lined box	21,000 V	11,000 V	5,000 V
<b>NOTE:</b> 700 volts can degrade a product.			

[Return to Removal & Replacement Procedures](#)



# Maintenance & Service Guide

**Presario 1800 Series  
Models: 1805 and 1810**

[Home Page](#) | [Notice](#) | [Preface](#) | [Product Description](#) | [Troubleshooting](#)  
[Illustrated Parts Catalog](#) | [Removal & Replacement Procedures](#) | [Specifications](#)  
[Pin Assignments](#) | [Battery Pack Operations](#)

---

## Service Considerations

Listed below are some of the considerations that you should keep in mind during the disassembly and assembly of the computer.

## Tool and Software Requirements

To service the computer, you need the following:

- | Compaq screwdriver kit (Spare Part No. 161946-001)
- | Torx T-9 screwdriver
- | 5mm nut drivers (for screwlocks and standoffs)
- | Small, standard screwdriver
- | Small, Phillips screwdriver
- | Plastic shroud
- | Diagnostics software

## Screws

The screws used in the computer are not interchangeable. If an incorrect screw is used during the reassembly process, it can damage the unit. Compaq strongly recommends that all screws removed during disassembly be kept with the part that was removed, then returned to their proper locations.

**IMPORTANT:** As each subassembly is removed from the computer, it should be placed away from the work area to prevent damage.

## [Return to Removal & Replacement Procedures](#)

# Maintenance & Service Guide

Presario 1800 Series  
Models: 1805 and 1810

[Home Page](#) | [Notice](#) | [Preface](#) | [Product Description](#) | [Troubleshooting](#)  
[Illustrated Parts Catalog](#) | [Removal & Replacement Procedures](#) | [Specifications](#)  
[Pin Assignments](#) | [Battery Pack Operations](#)

---

## Cables and Connectors

Most cables used throughout the unit are ribbon cables. Cables must be handled with extreme care to avoid damage. Apply only the tension required to seat or unseat the cables during insertion or removal from the connector. Handle cables by the connector whenever possible. In all cases, avoid bending, twisting, or tearing the cables, and ensure that the cables are routed in such a way that they cannot be caught or snagged by parts being removed or replaced.

## Cables

Use the following precautions when handling cables to avoid damage to the cable or computer:

- | Always handle cables by their connectors.
- | Avoid bending, twisting, or pulling on the cables.
- | Apply minimum required force when seating or unseating the cables from their connectors.
- | Place the cables in such a manner that they cannot be caught or snagged by parts being removed or replaced.
- | Handle flex cables with extreme care; they can tear easily.

**CAUTION:** When serving these computers, ensure that cables are placed in their proper location during the reassembly process. Improper cable placement can cause severe damage to the unit.

Select the desired illustration.

Removing a Cable from a **ZIF Connector**.

The ribbon cable position for the **3.2-GB, 4.0-GB, and 6.4-GB hard drive**.

The ribbon cable position for the **CD or DVD drive**.

The ribbon cable position for the **diskette drive**.

The cable position for the **speaker assembly**.

## Plastic Parts

Plastic parts can be damaged by the use of excessive force during disassembly and reassembly. When handling the plastic parts, use care. Apply pressure only at the points designated in the maintenance instructions.

**[Back to Top of Page](#)**

**[Return to Removal & Replacement Procedures](#)**

# Maintenance & Service Guide

**Presario 1800 Series  
Models: 1805 and 1810**

| [Home Page](#) | [Notice](#) | [Preface](#) | [Product Description](#) | [Troubleshooting](#)  
[Illustrated Parts Catalog](#) | [Removal & Replacement Procedures](#) | [Specifications](#)  
[Pin Assignments](#) | [Battery Pack Operations](#)

## ZIF Connectors

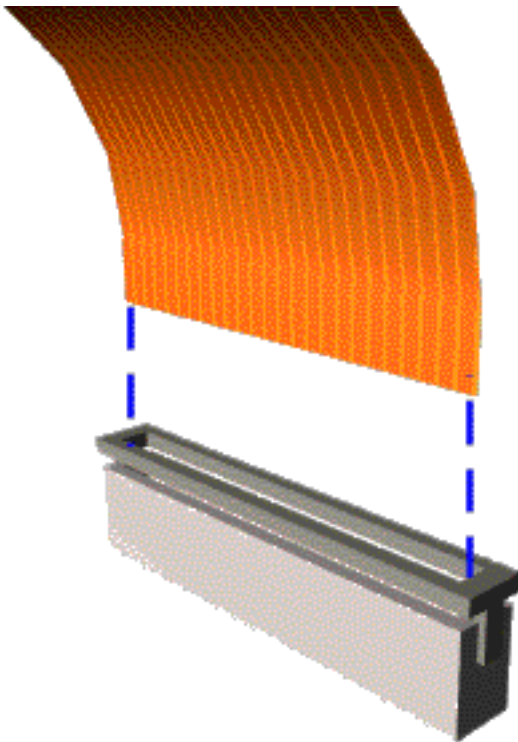

The computer uses a zero insertion force (ZIF) connector for the keyboard cable to the system board. To remove a cable from a ZIF connector, lift both corners of the ZIF connector and slide simultaneously with constant light force.

**CAUTION:** A ZIF connector and its attached cable can be easily damaged. Handle only the connector slide when removing or replacing a cable. Never pull or twist on the cable while it is connected.

**CAUTION:** When servicing this computer, ensure that cables are placed in their proper location during the reassembly process. Improper cable placement can damage the computer.

Back to [Cables and Connectors](#).

# **Maintenance & Service Guide**

## **Presario 1800 Series**

### **Models: 1805 and 1810**

[| Home Page](#) | [| Notice](#) | [| Preface](#) | [| Product Description](#) | [| Troubleshooting](#)  
[| Illustrated Parts Catalog](#) | [| Removal & Replacement Procedures](#) | [| Specifications](#)  
[| Pin Assignments](#) | [| Battery Pack Operations](#)

---

The ribbon cable position for the 3.2-GB, 4.0-GB, or 6.4-GB hard drive.

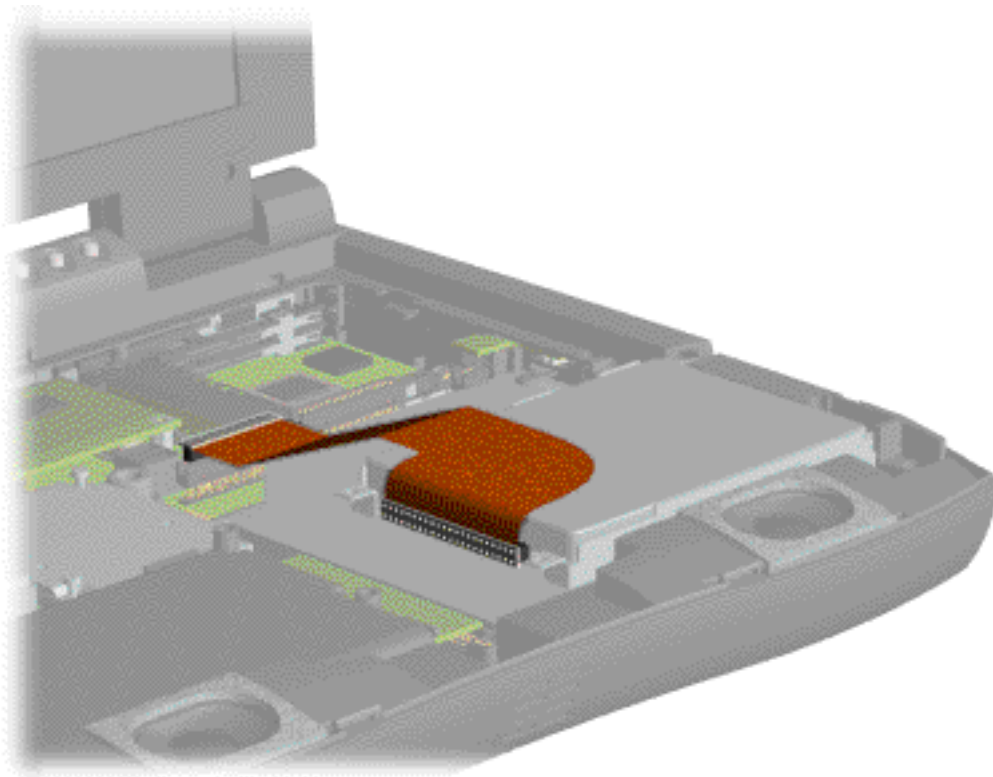

Back to [Cables and Connectors](#).



# **Maintenance & Service Guide**

## **Presario 1800 Series**

### **Models: 1805 and 1810**

[| Home Page](#) | [| Notice](#) | [| Preface](#) | [| Product Description](#) | [| Troubleshooting](#)  
[| Illustrated Parts Catalog](#) | [| Removal & Replacement Procedures](#) | [| Specifications](#)  
[| Pin Assignments](#) | [| Battery Pack Operations](#)

---

The ribbon cable position for the CD drive.

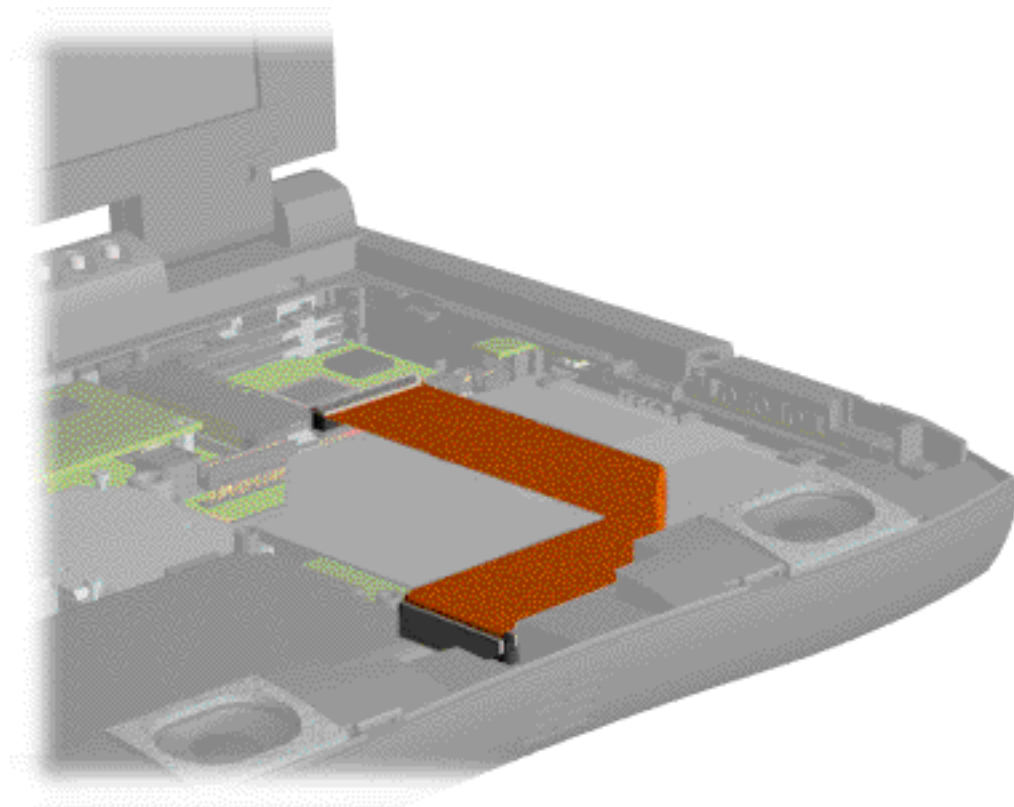

Back to [Cables and Connectors.](#)

# **Maintenance & Service Guide**

## **Presario 1800 Series**

### **Models: 1805 and 1810**

| [Home Page](#) | [Notice](#) | [Preface](#) | [Product Description](#) | [Troubleshooting](#)  
[Illustrated Parts Catalog](#) | [Removal & Replacement Procedures](#) | [Specifications](#)  
[Pin Assignments](#) | [Battery Pack Operations](#)

---

The ribbon cable position for the diskette drive.

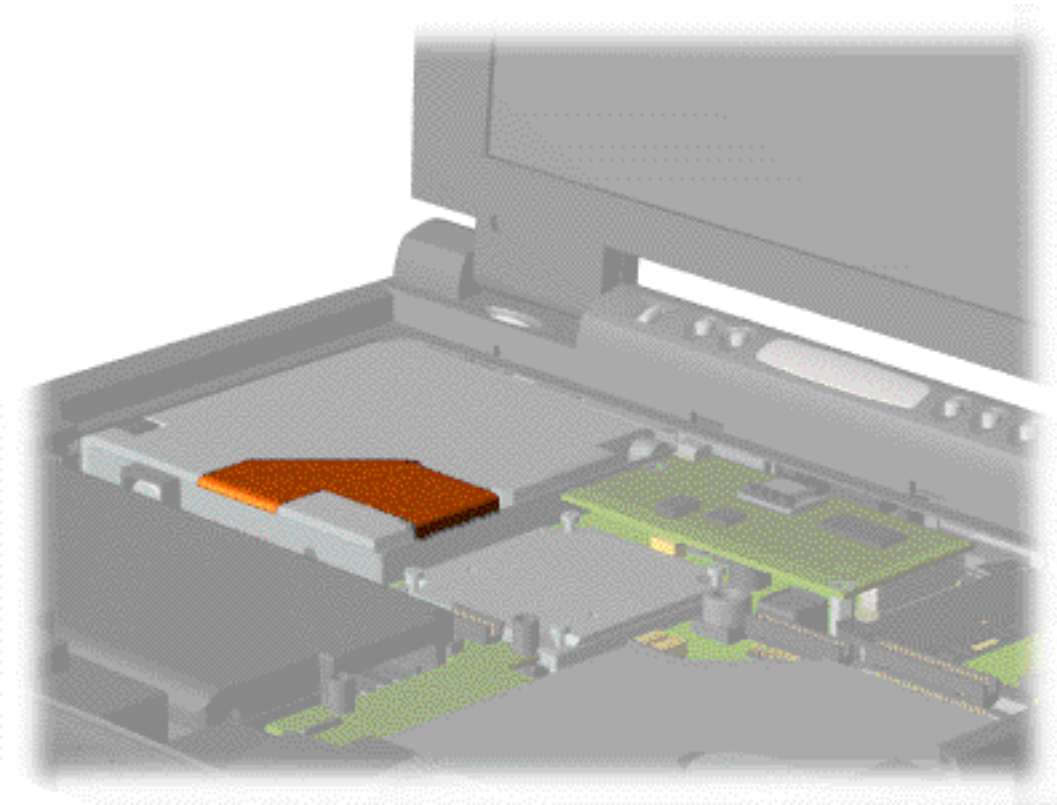

Back to [Cables and Connectors](#).

# Maintenance & Service Guide

**Presario 1800 Series  
Models: 1805 and 1810**

[Home Page](#) | [Notice](#) | [Preface](#) | [Product Description](#) | [Troubleshooting](#)  
[Illustrated Parts Catalog](#) | [Removal & Replacement Procedures](#) | [Specifications](#)  
[Pin Assignments](#) | [Battery Pack Operations](#)

---

The cable position for the speaker assembly.

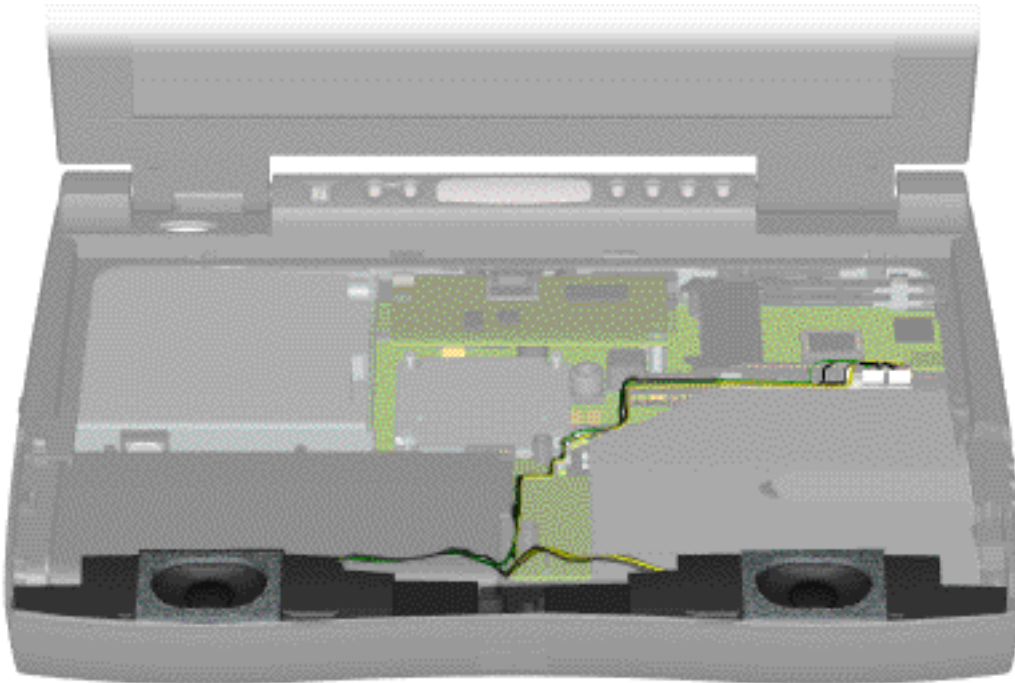

Back to [Cables and Connectors](#).

# Maintenance & Service Guide

Presario 1800 Series  
Models: 1805 and 1810

[Home Page](#) | [Notice](#) | [Preface](#) | [Product Description](#) | [Troubleshooting](#)  
[Illustrated Parts Catalog](#) | [Removal & Replacement Procedures](#) | [Specifications](#)  
[Pin Assignments](#) | [Battery Pack Operations](#)

## Preparing the Computer for Disassembly

[Electrostatic Discharge](#)

Before beginning removal and replacement procedures, complete the following procedures:

[Service Considerations](#)

1. Disconnect AC power and any external devices.

[Cables and Connectors](#)

2. Remove the battery pack.

**Preparing the Computer for Disassembly**

3. Remove any PC Cards.

[Battery Pack](#)

**IMPORTANT:**

The battery pack should be removed before performing any internal maintenance on the computer.

[Palmrest Cover with Touch Pad](#)

[Keyboard](#)

[Heatspreader](#)

[Modem](#)

[Processor](#)

[Status Panel](#)

[Interface Board](#)

[Hard Drives](#)

[Battery](#)

[Charger Board](#)

[CD or DVD Drive](#)

[Display Panel Assembly](#)

[Upper CPU Cover](#)

[Speaker Assembly](#)

[Diskette Drive](#)

[Fan Assembly](#)

[Audio Board](#)

[System Board](#)

[Memory Module](#)

**NOTE:**

The Compaq Presario 1800 Series Portable Computers have several screws of various sizes which are **not** interchangeable. Care must be taken during reassembly to ensure that the correct screws are used in their correct location. During removal please keep respective screws with their associate sub-assembly.

**WARNING:** Metal objects can damage the battery pack as well as the battery contacts in the battery compartment. To prevent damage, do not allow metal objects to touch the battery contacts. Place only the battery pack for the Compaq Presario 1800 Series Portable Computers into the battery compartment. Do not force the battery pack into the bay if insertion does not occur easily.

**CAUTION:** Do not crush, puncture, or incinerate the battery pack. Do not open a battery pack, as this damages the pack, makes it unusable, and exposes potentially harmful battery components. There are no field-serviceable parts located inside the battery pack.



# Maintenance & Service Guide

Presario 1800 Series  
Models: 1805 and 1810

[Home Page](#) | [Notice](#) | [Preface](#) | [Product Description](#) | [Troubleshooting](#)  
[Illustrated Parts Catalog](#) | [Removal & Replacement Procedures](#) | [Specifications](#)  
[Pin Assignments](#) | [Battery Pack Operations](#)

## Removing the Keyboard

[Electrostatic Discharge](#)

[Service Considerations](#)

[Cables and Connectors](#)

[Preparing the Computer for Disassembly](#)

[Battery Pack](#)

[Palmrest Cover with Touch Pad](#)

**[Keyboard](#)**

[Heatspreader](#)

[Modem](#)

[Processor](#)

[Status Panel](#)

[Interface Board](#)

[Hard Drives](#)

[Battery Charger Board](#)

[CD or DVD Drive](#)

[Display Panel Assembly](#)

[Upper CPU Cover](#)

[Speaker Assembly](#)

[Diskette Drive](#)

[Fan Assembly](#)

[Audio Board](#)

[System Board](#)

[Memory Module](#)

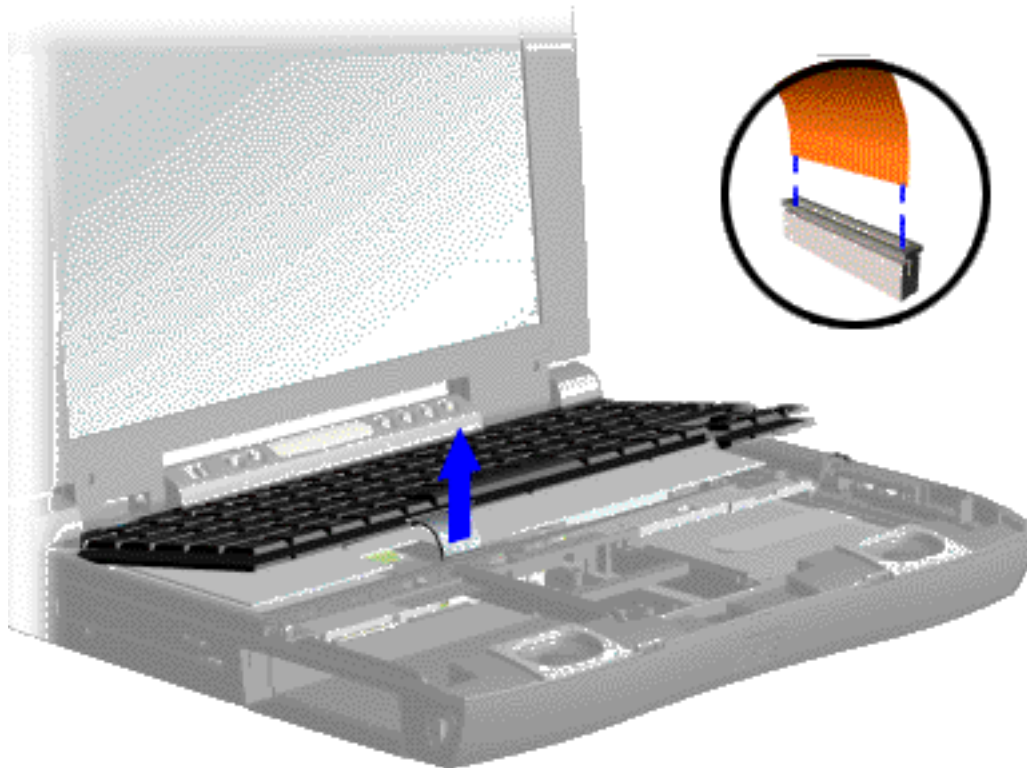

To remove the keyboard, complete the following steps:

1. [Prepare the computer for disassembly.](#)
2. [Remove the palmrest cover with touch pad.](#)
3. Gently lift up the front of the keyboard and disconnect the flex cable from the ZIF connector on the system board.

To remove a cable from a ZIF connector, lift both corners of the ZIF connector and slide simultaneously with constant light force.

**NOTE:** Then remove the cable. Refer to the section on [Cables and Connectors](#) for more information on removing a cable from the ZIF connector.

[Next Step](#)

# Maintenance & Service Guide

Presario 1800 Series  
Models: 1805 and 1810

[Home Page](#) | [Notice](#) | [Preface](#) | [Product Description](#) | [Troubleshooting](#)  
[Illustrated Parts Catalog](#) | [Removal & Replacement Procedures](#) | [Specifications](#)  
[Pin Assignments](#) | [Battery Pack Operations](#)

## Removing the Heatspreader

[Electrostatic Discharge](#)

[Service Considerations](#)

[Cables and Connectors](#)

[Preparing the Computer for Disassembly](#)

[Battery Pack](#)

[Palmrest Cover with Touch Pad](#)

[Keyboard](#)

[Heatspreader](#)

[Modem](#)

[Processor](#)

[Status Panel](#)

[Interface Board](#)

[Hard Drives](#)

[Battery Charger Board](#)

[CD or DVD Drive](#)

[Display Panel Assembly](#)

[Upper CPU Cover](#)

[Speaker Assembly](#)

[Diskette Drive](#)

[Fan Assembly](#)

[Audio Board](#)

[System Board](#)

[Memory Module](#)

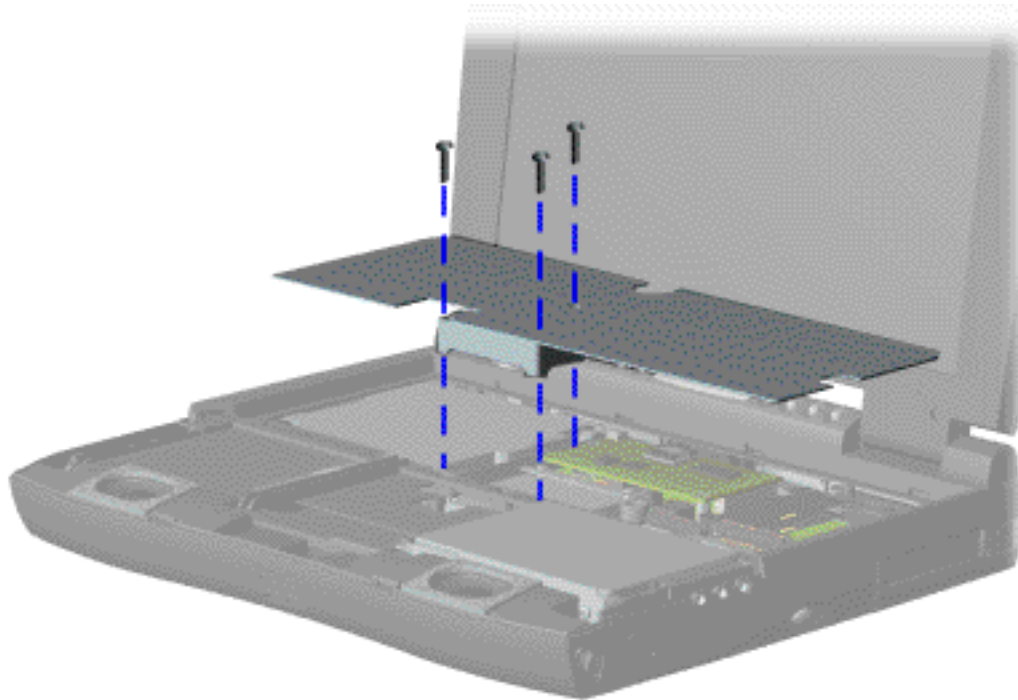

To remove the heatspreader, complete the following steps:

1. [Prepare the computer for disassembly.](#)

2. Remove the [palmrest cover with touch pad.](#)

3. Remove the [keyboard.](#)

4. Remove three screws from the heatspreader and lift out of the chassis.

To replace the heatspreader, reverse the previous procedures.

# Maintenance & Service Guide

**Presario 1800 Series  
Models: 1805 and 1810**

[Home Page](#) | [Notice](#) | [Preface](#) | [Product Description](#) | [Troubleshooting](#)  
[Illustrated Parts Catalog](#) | [Removal & Replacement Procedures](#) | [Specifications](#)  
[Pin Assignments](#) | [Battery Pack Operations](#)

## Removing the Modem

[Electrostatic Discharge](#)

[Service Considerations](#)

[Cables and Connectors](#)

[Preparing the Computer for Disassembly](#)

[Battery Pack](#)

[Palmrest Cover with Touch Pad](#)

[Keyboard](#)

[Heatspreader](#)

[Modem](#)

[Processor](#)

[Status Panel](#)

[Interface Board](#)

[Hard Drives](#)

[Battery Charger Board](#)

[CD or DVD Drive](#)

[Display Panel Assembly](#)

[Upper CPU Cover](#)

[Speaker Assembly](#)

[Diskette Drive](#)

[Fan Assembly](#)

[Audio Board](#)

[System Board](#)

[Memory Module](#)

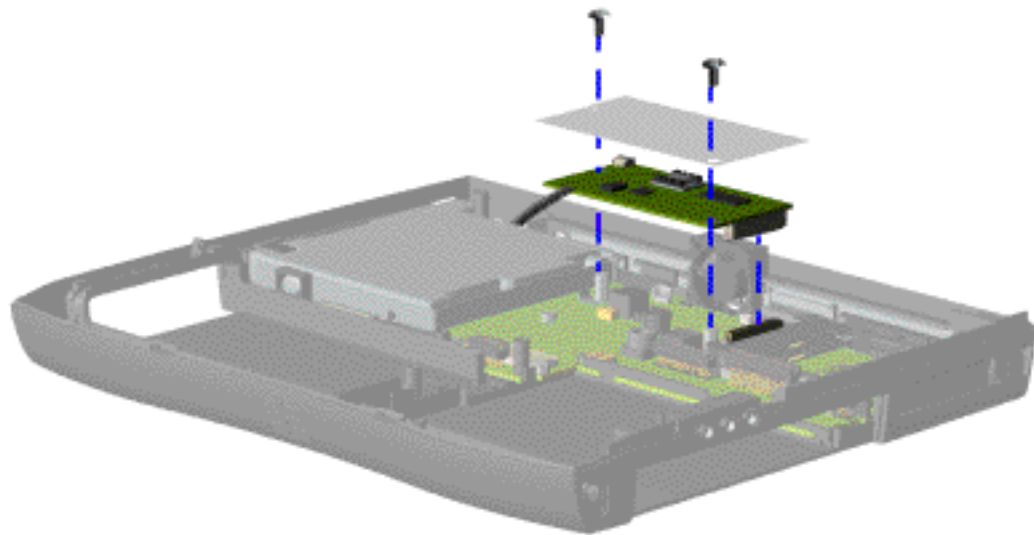

To remove the modem and shield, complete the following steps:

1. Prepare the [computer for disassembly](#).
2. Remove the [palmrest cover with touch pad](#).
3. Remove the [keyboard](#).
4. Remove the [heatspreader](#).
5. Remove two screws securing the shield and modem, lift off the shield, and pull the modem off the connector on the system board.

[Next Step](#)

# Maintenance & Service Guide

**Presario 1800 Series  
Models: 1805 and 1810**

| [Home Page](#) | [Notice](#) | [Preface](#) | [Product Description](#) | [Troubleshooting](#)  
[Illustrated Parts Catalog](#) | [Removal & Replacement Procedures](#) | [Specifications](#)  
[Pin Assignments](#) | [Battery Pack Operations](#)

---

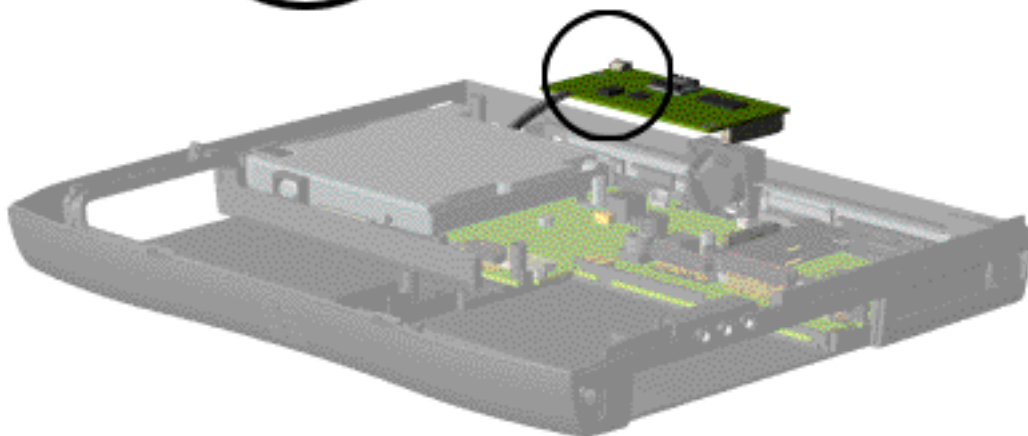
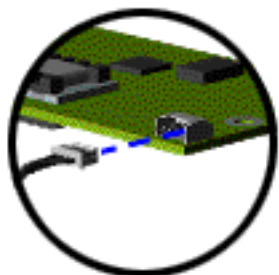

6. Disconnect the modem cable from the modem.

To replace the modem, reverse the previous procedures.

[Return to Removal & Replacement Procedures](#)

# Maintenance & Service Guide

Presario 1800 Series  
Models: 1805 and 1810

[Home Page](#) | [Notice](#) | [Preface](#) | [Product Description](#) | [Troubleshooting](#)  
[Illustrated Parts Catalog](#) | [Removal & Replacement Procedures](#) | [Specifications](#)  
[Pin Assignments](#) | [Battery Pack Operations](#)

## Removing the Processor

[Electrostatic Discharge](#)

[Service Considerations](#)

[Cables and Connectors](#)

[Preparing the Computer for Disassembly](#)

[Battery Pack](#)

[Palmrest Cover with Touch Pad](#)

[Keyboard](#)

[Heatspreader](#)

[Modem](#)

[Processor](#)

[Status Panel](#)

[Interface Board](#)

[Hard Drives](#)

[Battery Charger Board](#)

[CD or DVD Drive](#)

[Display Panel Assembly](#)

[Upper CPU Cover](#)

[Speaker Assembly](#)

[Diskette Drive](#)

[Fan Assembly](#)

[Audio Board](#)

[System Board](#)

[Memory Module](#)

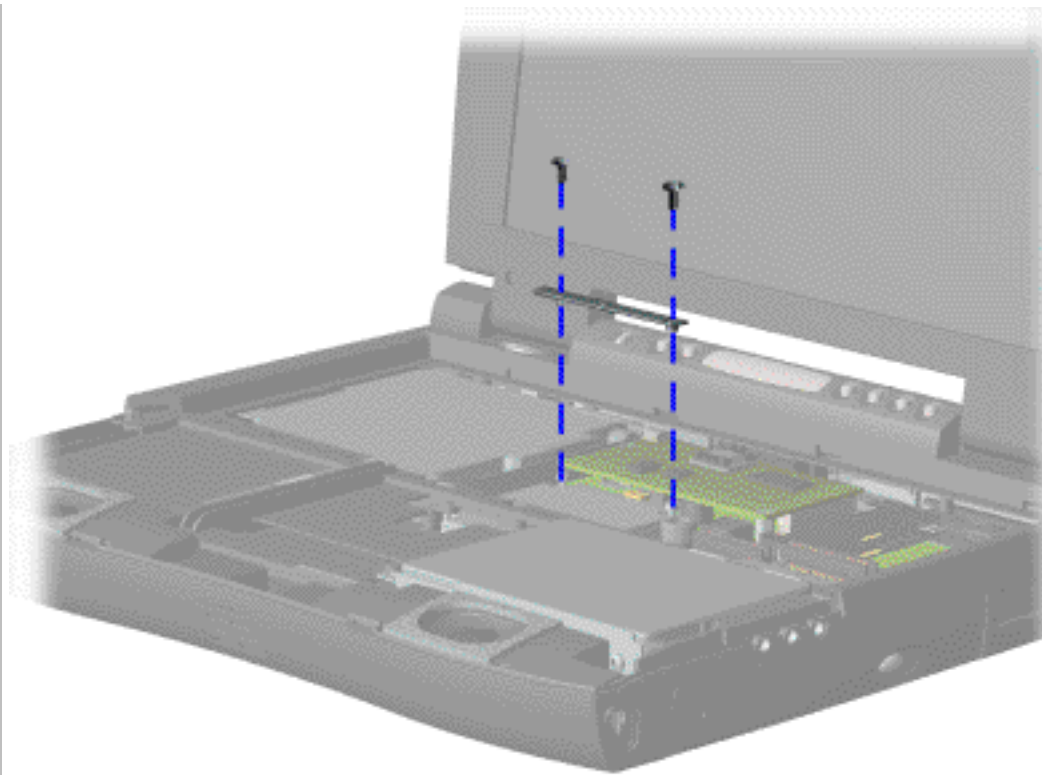

To remove the processor, complete the following steps:

1. [Prepare the computer for disassembly.](#)
2. Remove the [palmrest cover with touch pad.](#)
3. Remove the [keyboard.](#)
4. Remove the [heatspreader.](#)
5. Remove the [modem.](#)
6. Remove two screws securing the processor bracket.

[Next Step](#)



# Maintenance & Service Guide

**Presario 1800 Series  
Models: 1805 and 1810**

[Home Page](#) | [Notice](#) | [Preface](#) | [Product Description](#) | [Troubleshooting](#)  
[Illustrated Parts Catalog](#) | [Removal & Replacement Procedures](#) | [Specifications](#)  
[Pin Assignments](#) | [Battery Pack Operations](#)

---

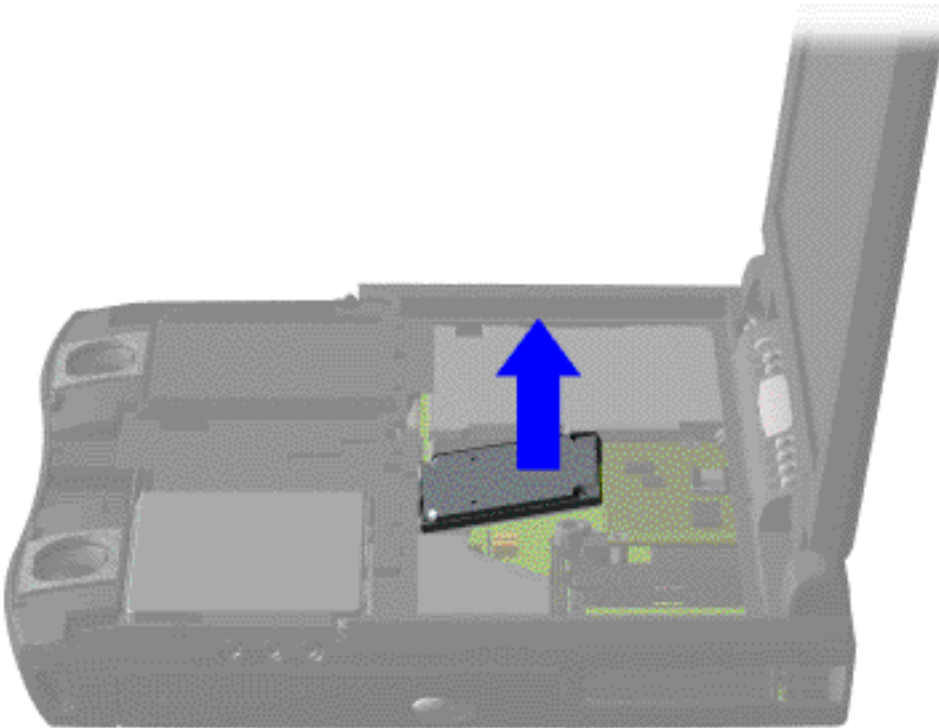

7. Insert a small blade screw driver under the right side on the processor and lift the processor from the chassis slot.

8. Lift the processor out of the processor chassis slot.

To replace the processor complete the following steps:

1. Insert the processor into the chassis slot on the system board and push down into the slot.

2. Replace the processor bracket.

[Return to Removal & Replacement Procedures](#)

# Maintenance & Service Guide

Presario 1800 Series  
Models: 1805 and 1810

[Home Page](#) | [Notice](#) | [Preface](#) | [Product Description](#) | [Troubleshooting](#)  
[Illustrated Parts Catalog](#) | [Removal & Replacement Procedures](#) | [Specifications](#)  
[Pin Assignments](#) | [Battery Pack Operations](#)

## Removing the Status Panel

[Electrostatic Discharge](#)

[Service Considerations](#)

[Cables and Connectors](#)

[Preparing the Computer for Disassembly](#)

[Battery Pack](#)

[Palmrest Cover with Touch Pad](#)

[Keyboard](#)

[Heatspreader](#)

[Modem](#)

[Processor](#)

[Status Panel](#)

[Interface Board](#)

[Hard Drives](#)

[Battery Charger Board](#)

[CD or DVD Drive](#)

[Display Panel Assembly](#)

[Upper CPU Cover](#)

[Speaker Assembly](#)

[Diskette Drive](#)

[Fan Assembly](#)

[Audio Board](#)

[System Board](#)

[Memory Module](#)

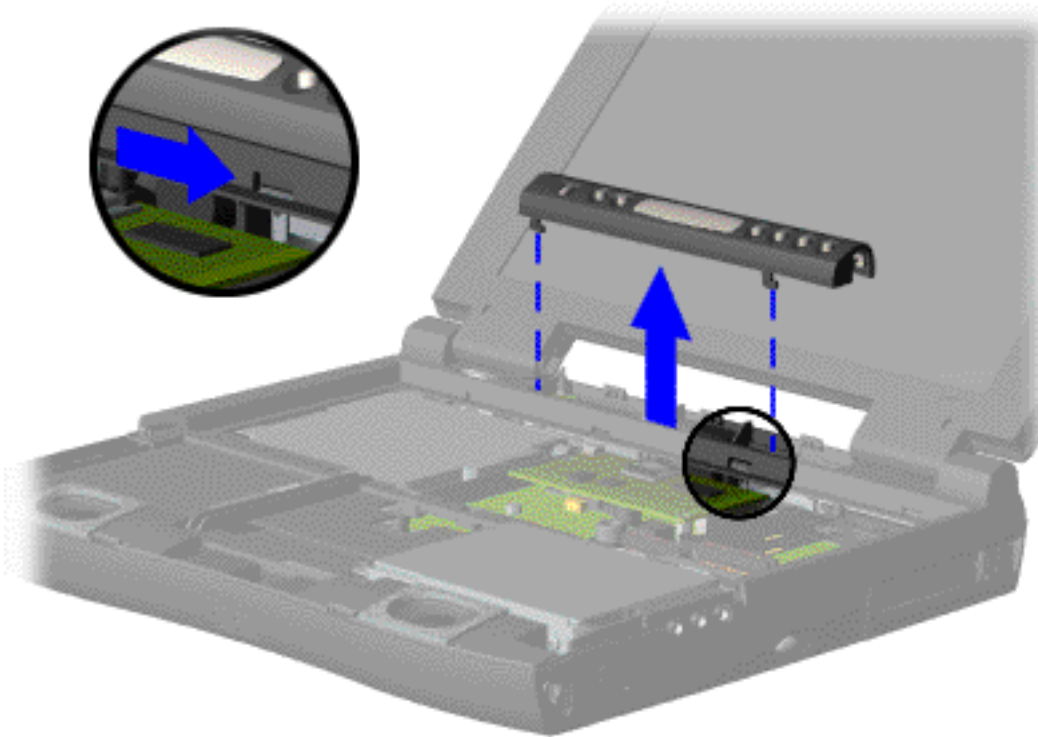

To remove the status panel, complete the following steps:

1. [Prepare the computer for disassembly.](#)
2. [Remove the palmrest cover with touch pad.](#)
3. [Remove the keyboard.](#)
4. Move the lever (located below the CD Play button on the status panel) to the right to release the status panel cover.
5. Support the front bottom corners of the status panel with the thumb and forefinger. Lift up the status panel off the chassis.

# Maintenance & Service Guide

Presario 1800 Series  
Models: 1805 and 1810

[Home Page](#) | [Notice](#) | [Preface](#) | [Product Description](#) | [Troubleshooting](#)  
[Illustrated Parts Catalog](#) | [Removal & Replacement Procedures](#) | [Specifications](#)  
[Pin Assignments](#) | [Battery Pack Operations](#)

## Removing the **Interface Board with Header**

[Electrostatic Discharge](#)

[Service Considerations](#)

[Cables and Connectors](#)

[Preparing the Computer for Disassembly](#)

[Battery Pack](#)

[Palmrest Cover with Touch Pad](#)

[Keyboard](#)

[Heatspreader](#)

[Modem](#)

[Processor](#)

[Status Panel](#)

[Interface Board](#)

[Hard Drives](#)

[Battery Charger Board](#)

[CD or DVD Drive](#)

[Display Panel Assembly](#)

[Upper CPU Cover](#)

[Speaker Assembly](#)

[Diskette Drive](#)

[Fan Assembly](#)

[Audio Board](#)

[System Board](#)

[Memory Module](#)

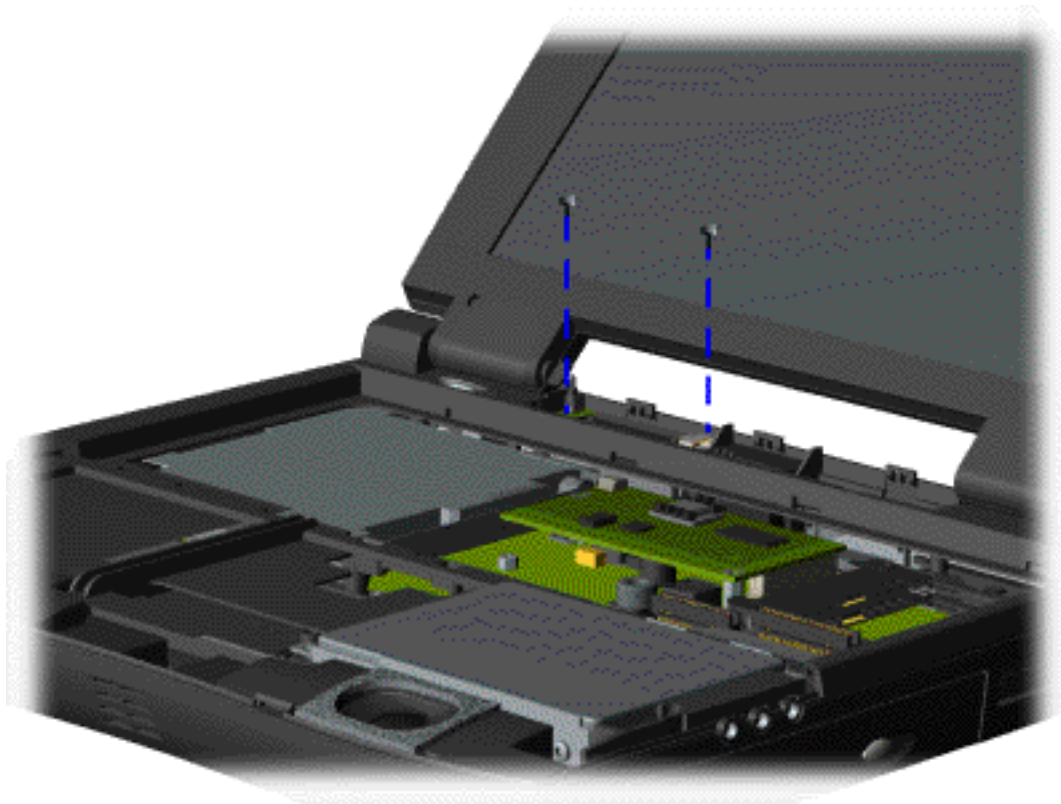

To remove the interface board with header, complete the following steps:

1. Prepare the computer for disassembly.
2. Remove the palmrest cover with touch pad.
3. Remove the keyboard.
4. Remove the status panel.
5. Remove the two screws from the interface board.

[Next Step](#)

# Maintenance & Service Guide

**Presario 1800 Series  
Models: 1805 and 1810**

[Home Page](#) | [Notice](#) | [Preface](#) | [Product Description](#) | [Troubleshooting](#)  
[Illustrated Parts Catalog](#) | [Removal & Replacement Procedures](#) | [Specifications](#)  
[Pin Assignments](#) | [Battery Pack Operations](#)

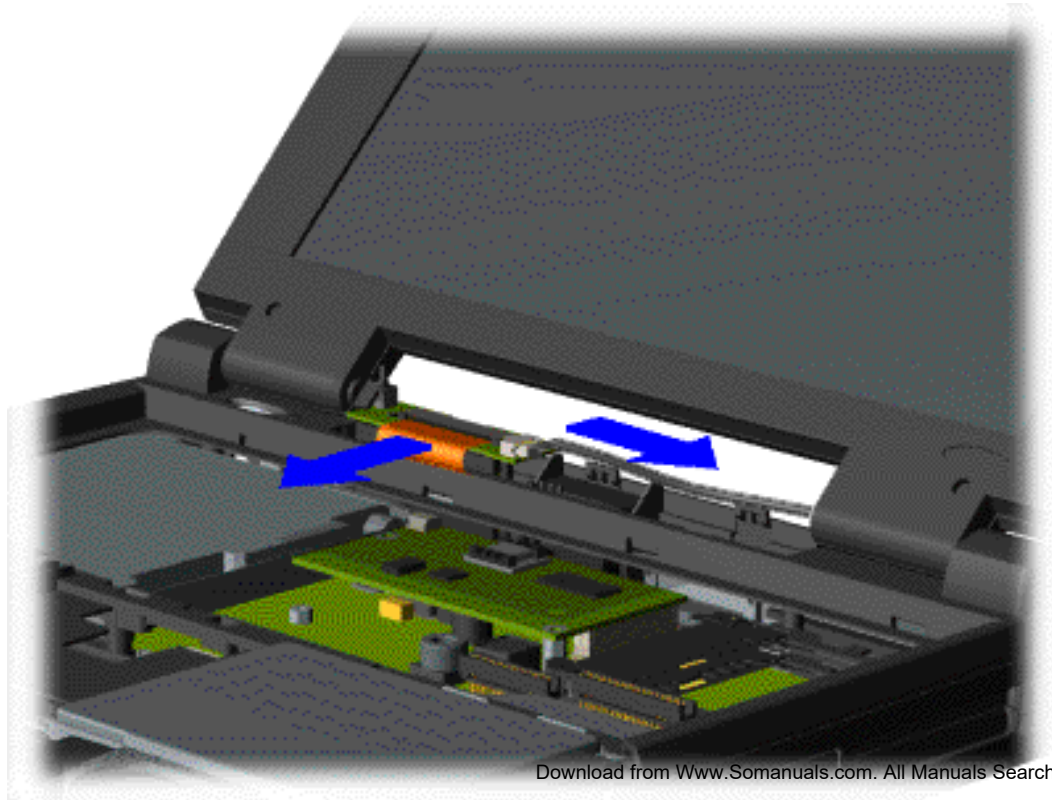

6. Slightly lift the interface board, disconnect the ZIF connector, and backlight power cable from the interface board.

[Next Step](#)

# Maintenance & Service Guide

**Presario 1800 Series  
Models: 1805 and 1810**

| [Home Page](#) | [Notice](#) | [Preface](#) | [Product Description](#) | [Troubleshooting](#)  
[Illustrated Parts Catalog](#) | [Removal & Replacement Procedures](#) | [Specifications](#)  
[Pin Assignments](#) | [Battery Pack Operations](#)

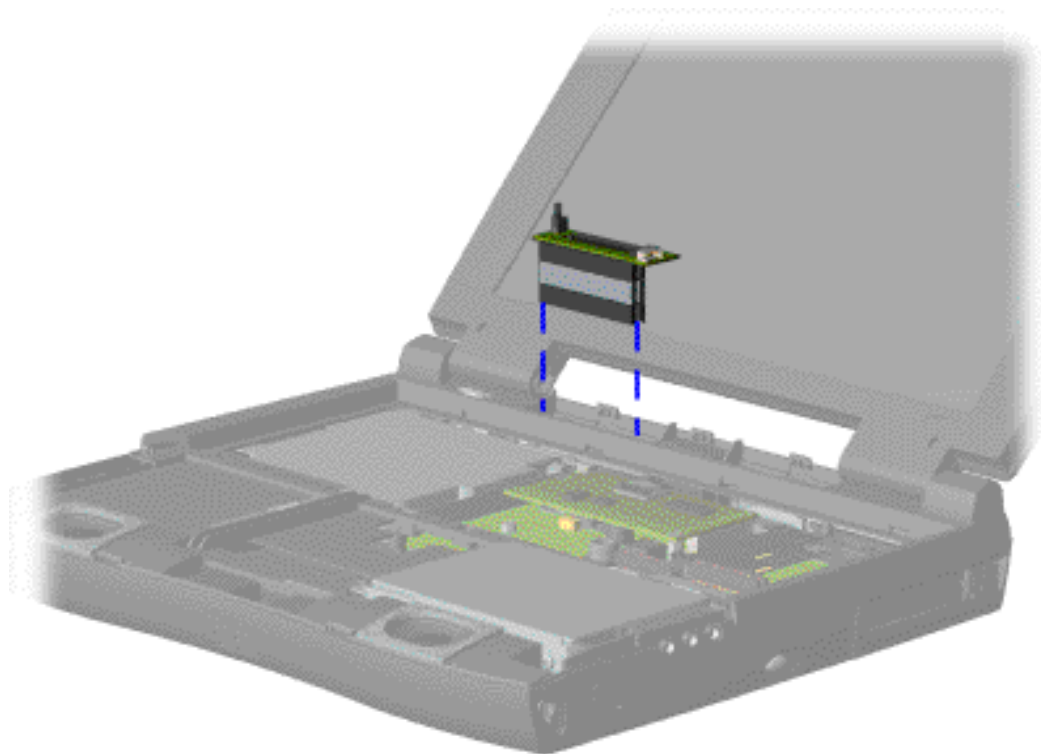

7. Lift the interface board up with the header attached from the system board.

**IMPORTANT:**

When removing the interface board with the header attached occasionally the header will remain attached to the system board. If this occurs when removing the interface board with the header attached, separate the header from the connector on the system board.

To replace the interface board, reverse the previous procedures.

**NOTE:**

When replacing interface board, ensure both connectors on the board are properly seated.



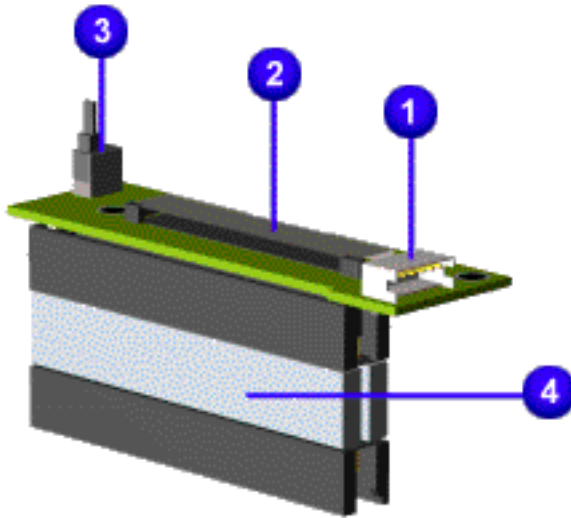

The following illustration and table indicates the locations of the connectors on the interface board.

<b>Interface Board Components</b>	
Designator	Connector
1. JP1	Backlight Switch
2. JP3	Display Interface ZIF
3. JP4	Inverter/Backlight LIF Connector
4. None	Interface Header

## [Return to Removal & Replacement Procedures](#)

# Maintenance & Service Guide

Presario 1800 Series  
Models: 1805 and 1810

[Home Page](#) | [Notice](#) | [Preface](#) | [Product Description](#) | [Troubleshooting](#)  
[Illustrated Parts Catalog](#) | [Removal & Replacement Procedures](#) | [Specifications](#)  
[Pin Assignments](#) | [Battery Pack Operations](#)

## Removing the 3.2-GB, 4.0-GB, or 6.4-GB Hard Drive

[Electrostatic Discharge](#)

[Service Considerations](#)

[Cables and Connectors](#)

[Preparing the Computer for Disassembly](#)

[Battery Pack](#)

[Palmrest Cover with Touch Pad](#)

[Keyboard](#)

[Heatspreader](#)

[Modem](#)

[Processor](#)

[Status Panel](#)

[Interface Board](#)

[Hard Drives](#)

[Battery Charger Board](#)

[CD or DVD Drive](#)

[Display Panel Assembly](#)

[Upper CPU Cover](#)

[Speaker Assembly](#)

[Diskette Drive](#)

[Fan Assembly](#)

[Audio Board](#)

[System Board](#)

[Memory Module](#)

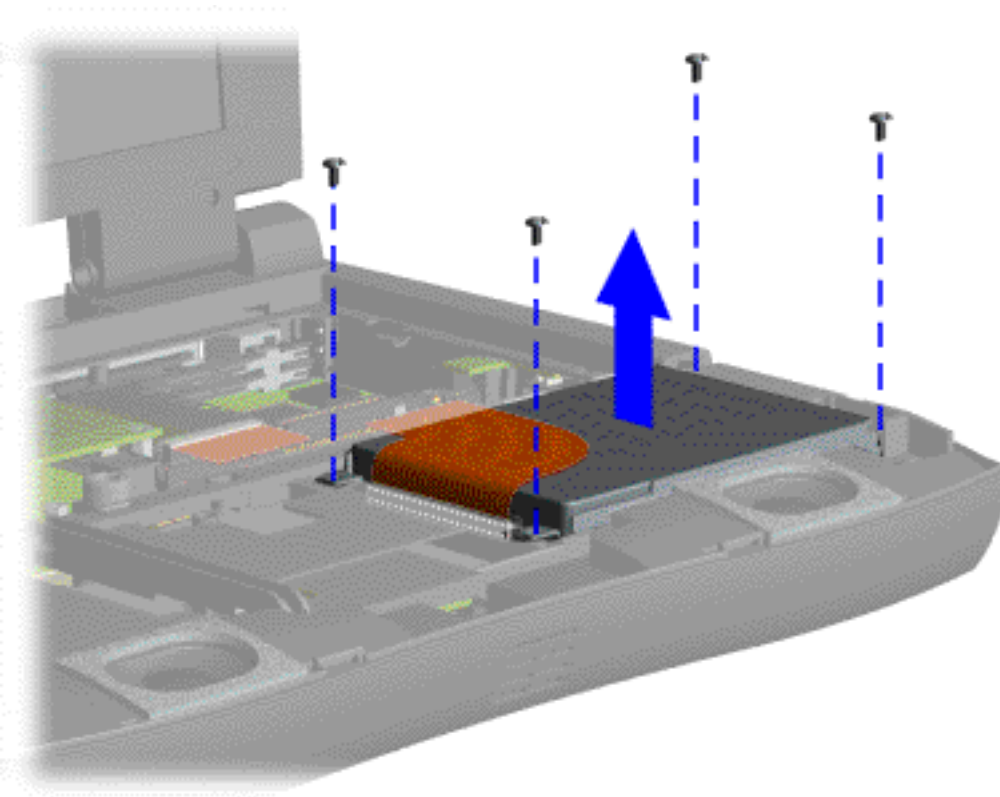

To remove the hard drive with the hard drive bracket attached, complete the following steps:

1. Prepare the [computer for disassembly](#).
2. Remove the [palmrest cover with touch pad](#).
3. Remove four screws from the hard drive mounting bracket and lift up the hard drive.

[Next Step](#)

# Maintenance & Service Guide

**Presario 1800 Series  
Models: 1805 and 1810**

[Home Page](#) | [Notice](#) | [Preface](#) | [Product Description](#) | [Troubleshooting](#)  
[Illustrated Parts Catalog](#) | [Removal & Replacement Procedures](#) | [Specifications](#)  
[Pin Assignments](#) | [Battery Pack Operations](#)

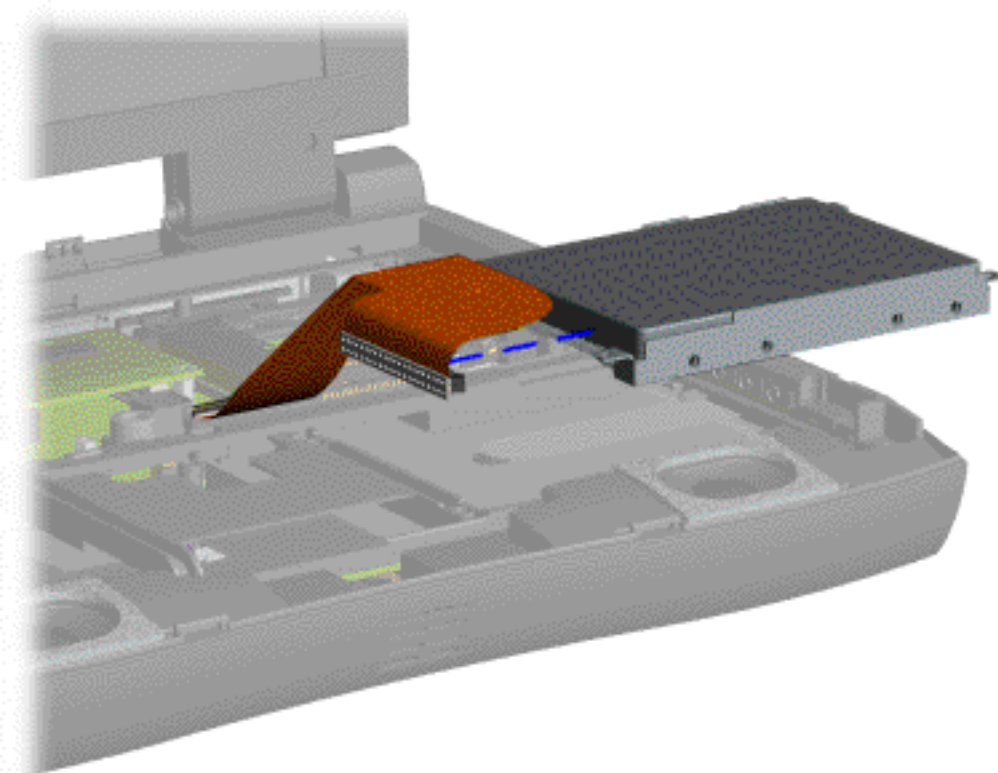

5. Disconnect the hard drive data cable from the hard drive and remove from the chassis.

[Next Step](#)

# Maintenance & Service Guide

## Presario 1800 Series Models: 1805 and 1810

[Home Page](#) | [Notice](#) | [Preface](#) | [Product Description](#) | [Troubleshooting](#)  
[Illustrated Parts Catalog](#) | [Removal & Replacement Procedures](#) | [Specifications](#)  
[Pin Assignments](#) | [Battery Pack Operations](#)

---

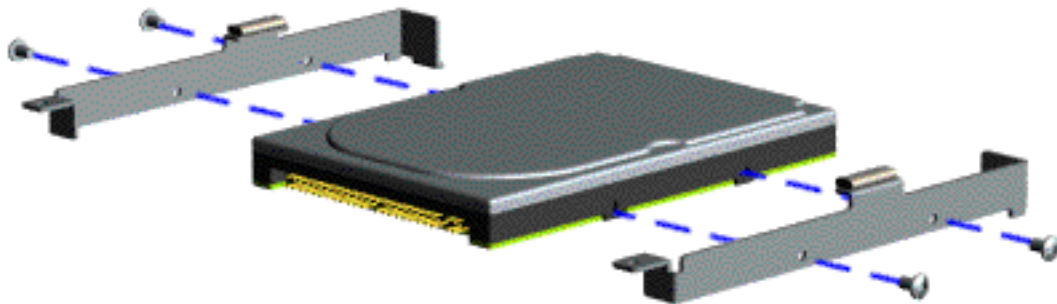

To remove the hard drive mounting bracket, complete the following step:

Remove four screws from the hard drive mounting bracket.

To replace the hard drive and hard drive mounting bracket, reverse the previous procedures.

[Return to Removal & Replacement Procedures](#)

# Maintenance & Service Guide

Presario 1800 Series  
Models: 1805 and 1810

[Home Page](#) | [Notice](#) | [Preface](#) | [Product Description](#) | [Troubleshooting](#)  
[Illustrated Parts Catalog](#) | [Removal & Replacement Procedures](#) | [Specifications](#)  
[Pin Assignments](#) | [Battery Pack Operations](#)

## Removing the Battery Charger Board

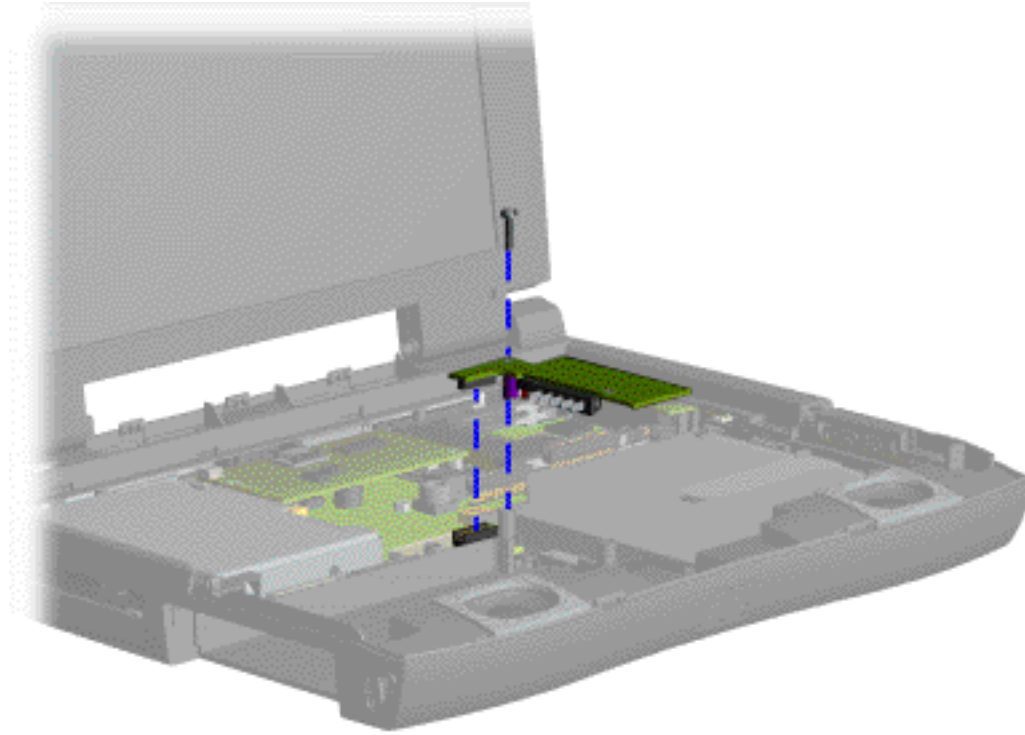

[Electrostatic Discharge](#)

[Service Considerations](#)

[Cables and Connectors](#)

[Preparing the Computer for Disassembly](#)

[Battery Pack](#)

[Palmrest Cover with Touch Pad](#)

[Keyboard](#)

[Heatspreader](#)

[Modem](#)

[Processor](#)

[Status Panel](#)

[Interface Board](#)

[Hard Drives](#)

[Battery Charger Board](#)

[CD or DVD Drive](#)

[Display Panel Assembly](#)

[Upper CPU Cover](#)

[Speaker Assembly](#)

[Diskette Drive](#)

[Fan Assembly](#)

[Audio Board](#)

[System Board](#)

[Memory Module](#)

To remove the battery charger board, complete the following steps:

1. Prepare the [computer for disassembly](#).
2. Remove the [palmrest cover with touch pad](#).
3. Remove the [keyboard](#).
4. Remove the [hard drive](#).
5. Remove the [stiffener bracket](#).
6. Remove screw from the battery charger board, unplug the board from the connector on the system board, and lift out of the chassis.

To replace the battery charger board, reverse the previous procedures.

**NOTE:** When replacing the battery charger board, ensure the pins are aligned with the connector on the system board.



# Maintenance & Service Guide

Presario 1800 Series  
Models: 1805 and 1810

[Home Page](#) | [Notice](#) | [Preface](#) | [Product Description](#) | [Troubleshooting](#)  
[Illustrated Parts Catalog](#) | [Removal & Replacement Procedures](#) | [Specifications](#)  
[Pin Assignments](#) | [Battery Pack Operations](#)

## Removing the CD or DVD Drive

[Electrostatic Discharge](#)

[Service Considerations](#)

[Cables and Connectors](#)

[Preparing the Computer for Disassembly](#)

[Battery Pack](#)

[Palmrest Cover with Touch Pad](#)

[Keyboard](#)

[Heatspreader](#)

[Modem](#)

[Processor](#)

[Status Panel](#)

[Interface Board](#)

[Hard Drives](#)

[Battery Charger Board](#)

[CD or DVD Drive](#)

[Display Panel Assembly](#)

[Upper CPU Cover](#)

[Speaker Assembly](#)

[Diskette Drive](#)

[Fan Assembly](#)

[Audio Board](#)

[System Board](#)

[Memory Module](#)

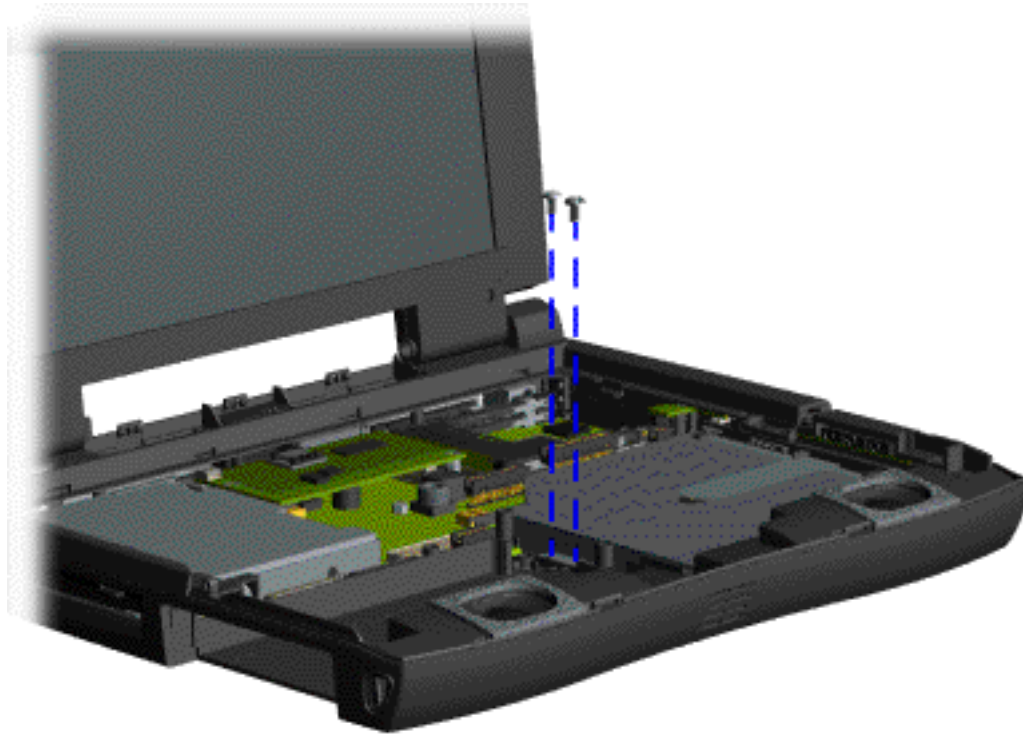

To remove the CD or DVD drive, complete the following steps:

1. Prepare the [computer for disassembly](#).
2. Remove the [palmrest cover with touch pad](#).
3. Remove the [keyboard](#).
4. Remove the [heatspreader](#).
4. Remove the [hard drive](#).
5. Remove the [stiffener bracket](#).
6. Remove the [battery charger board](#).
7. Remove two screws located at the back CD or DVD drive.

[Next Step](#)

# Maintenance & Service Guide

## Presario 1800 Series

### Models: 1805 and 1810

[Home Page](#) | [Notice](#) | [Preface](#) | [Product Description](#) | [Troubleshooting](#)  
[Illustrated Parts Catalog](#) | [Removal & Replacement Procedures](#) | [Specifications](#)  
[Pin Assignments](#) | [Battery Pack Operations](#)

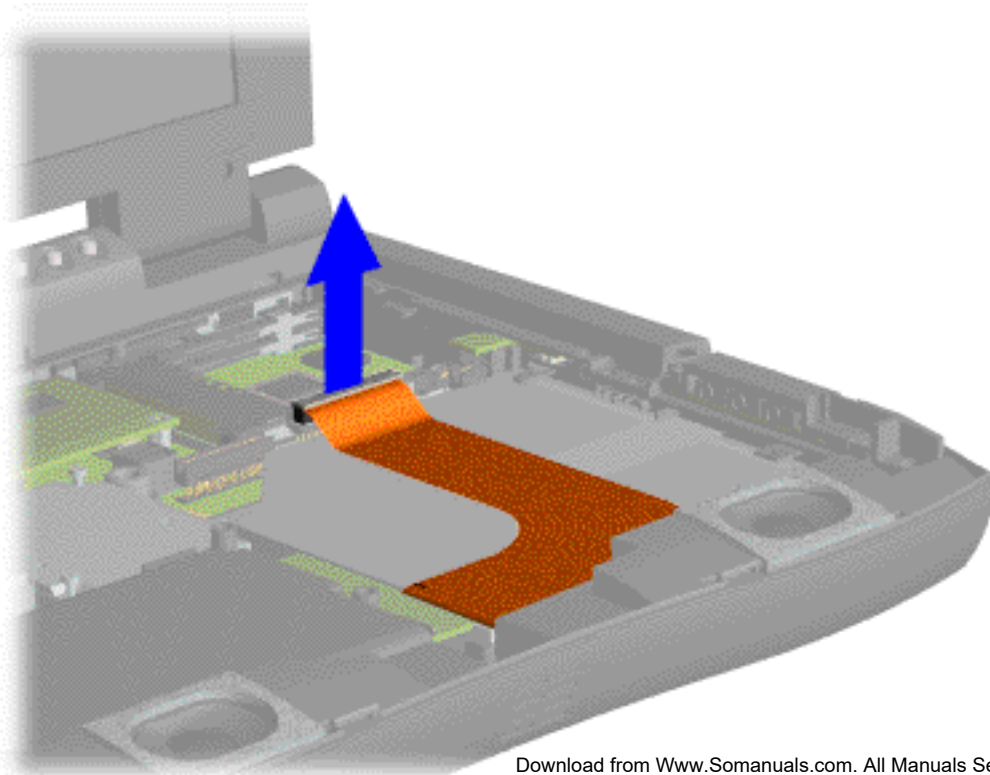

8. Disconnect the CD or DVD drive cable from the system board.

To replace the CD or DVD drive, reverse the previous procedures.

[Return to Removal & Replacement Procedures](#)

# Maintenance & Service Guide

Presario 1800 Series  
Models: 1805 and 1810

[Home Page](#) | [Notice](#) | [Preface](#) | [Product Description](#) | [Troubleshooting](#)  
[Illustrated Parts Catalog](#) | [Removal & Replacement Procedures](#) | [Specifications](#)  
[Pin Assignments](#) | [Battery Pack Operations](#)

## Removing the Display Panel Assembly

[Electrostatic Discharge](#)

[Service Considerations](#)

[Cables and Connectors](#)

[Preparing the Computer for Disassembly](#)

[Battery Pack](#)

[Palmrest Cover with Touch Pad](#)

[Keyboard](#)

[Heatspreader](#)

[Modem](#)

[Processor](#)

[Status Panel](#)

[Interface Board](#)

[Hard Drives](#)

[Battery Charger Board](#)

[CD or DVD Drive](#)

[Display Panel Assembly](#)

[Upper CPU Cover](#)

[Speaker Assembly](#)

[Diskette Drive](#)

[Fan Assembly](#)

[Audio Board](#)

[System Board](#)

[Memory Module](#)

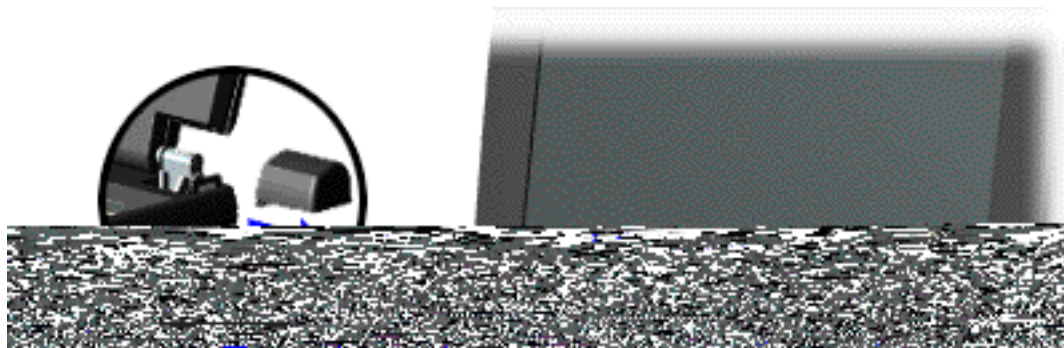

To remove the display panel assembly, complete the following steps:

1. [Prepare the computer for disassembly.](#)
2. Remove the [palmrest cover with touch pad.](#)
3. Remove the [keyboard.](#)
4. Remove the [heatspreader.](#)
5. Remove the [status panel.](#)
6. Remove the [interface board.](#)
7. Grasp the hinge covers, pull out and lift the covers off the chassis.

### IMPORTANT:

Carefully remove the display panel assembly hinge covers.

[Next Step](#)



































## Free Manuals Download Website

<http://myh66.com>

<http://usermanuals.us>

<http://www.somanuals.com>

<http://www.4manuals.cc>

<http://www.manual-lib.com>

<http://www.404manual.com>

<http://www.luxmanual.com>

<http://aubethermostatmanual.com>

Golf course search by state

<http://golfingnear.com>

Email search by domain

<http://emailbydomain.com>

Auto manuals search

<http://auto.somanuals.com>

TV manuals search

<http://tv.somanuals.com>