



# **Hardware and Software Guide**

Compaq Notebook Series

Document Part Number: 383161-001

May 2005

This guide explains how to identify, access, and use most of the hardware and software features available on your notebook. Modem information is not included in this guide.

© Copyright 2005 Hewlett-Packard Development Company, L.P.

Microsoft and Windows are U.S. registered trademarks of Microsoft Corporation. SD Logo is a trademark of its proprietor. Bluetooth is a trademark owned by its proprietor and used by Hewlett-Packard Company under license.

The information contained herein is subject to change without notice. The only warranties for HP products and services are set forth in the express warranty statements accompanying such products and services. Nothing herein should be construed as constituting an additional warranty. HP shall not be liable for technical or editorial errors or omissions contained herein.

Hardware and Software Guide  
Compaq Notebook Series  
First Edition May 2005  
Reference Number: V2000  
Document Part Number: 383161-001

---

# Contents

## 1 Component ID

Top Components . . . . .	1-1
Keys . . . . .	1-1
TouchPad . . . . .	1-3
Power Controls . . . . .	1-4
Lights . . . . .	1-5
Wireless and Volume Buttons . . . . .	1-6
Antennae . . . . .	1-7
Front Components . . . . .	1-8
Lights . . . . .	1-8
Speakers, Jacks and Display Release Button . . . . .	1-9
Rear Components . . . . .	1-10
Left-Side Components . . . . .	1-11
Ports and Jacks . . . . .	1-11
PC Card Slot and Button . . . . .	1-12
Vent and Security Cable Slot . . . . .	1-13
Right-Side Components . . . . .	1-14
Bottom Components . . . . .	1-16
Mini PCI and Memory Compartments . . . . .	1-16
Bays, Battery Latch and Vents . . . . .	1-17
Additional Components . . . . .	1-18
Hardware . . . . .	1-18
Optical Discs . . . . .	1-19
Labels . . . . .	1-19

## 2 Keyboard and Touchpad

TouchPad . . . . .	2-1
Identifying TouchPad Components . . . . .	2-1
Using the TouchPad. . . . .	2-2
Setting TouchPad Preferences . . . . .	2-3
Hotkeys . . . . .	2-5
Identifying Hotkeys . . . . .	2-5
Hotkey Quick Reference . . . . .	2-6
Using Hotkey Procedures . . . . .	2-7
Using Hotkey Commands . . . . .	2-7
Keypads . . . . .	2-14
Using the Embedded Numeric Keypad . . . . .	2-14
Using an External Numeric Keypad . . . . .	2-16

## 3 Power

Power Sources . . . . .	3-1
Selecting a Power Source . . . . .	3-1
Switching Between Battery and External Power. . . . .	3-2
Power Control and Light Locations . . . . .	3-3
Standby, Hibernation and Shutdown Overviews . . . . .	3-4
Standby . . . . .	3-4
Hibernation . . . . .	3-5
Leaving Your Work. . . . .	3-6
Interference with Drive Media . . . . .	3-6
Standby, Hibernation and Shutdown Procedures . . . . .	3-7
Turning the Notebook On or Off. . . . .	3-7
Initiating or Resuming from Standby . . . . .	3-8
Initiating or Restoring from Hibernation. . . . .	3-9
Using Emergency Shutdown Procedures . . . . .	3-10
Power Preferences . . . . .	3-11
Using Power Schemes . . . . .	3-11
Setting a Standby Password. . . . .	3-11
Setting Other Power Preferences. . . . .	3-11

---

Battery Pack . . . . .	3–13
Charging a Battery Pack . . . . .	3–13
Monitoring the Charge in a Battery Pack . . . . .	3–15
Managing Low-Battery Conditions . . . . .	3–17
Calibrating a Battery Pack . . . . .	3–19
Conserving Battery Pack Power . . . . .	3–23
Replacing a Battery Pack . . . . .	3–24
Storing a Battery Pack . . . . .	3–27
Disposing of a Used Battery Pack . . . . .	3–28

## 4 Multimedia

Internal Speakers . . . . .	4–1
Volume Controls . . . . .	4–2
External Audio Devices . . . . .	4–3
Using the Audio-Out (Headphone) Jack . . . . .	4–3
Using the Audio-In (Microphone) Jack . . . . .	4–4
External Video Devices . . . . .	4–5
Connecting an S-Video Device . . . . .	4–5
Displaying a Video Image . . . . .	4–6
CD and DVD Procedures . . . . .	4–7
Using Media Activity Hotkeys . . . . .	4–7
Protecting Playback . . . . .	4–8
Protecting a CD or DVD Write Process . . . . .	4–8
Multimedia Software . . . . .	4–9
Observing the Copyright Warning . . . . .	4–10
Installing Software . . . . .	4–11
Enabling AutoPlay . . . . .	4–12
Changing DVD Region Settings . . . . .	4–12
Using the Operating System . . . . .	4–13
Using WinDVD . . . . .	4–14
Using Other DVD Software . . . . .	4–14

## **5 Wireless (Select Models Only)**

Wireless Features . . . . .	5-1
Wireless Controls . . . . .	5-2
802.11 Wireless Devices (Select Models Only) . . . . .	5-3
Setting Up a WLAN in Your Home . . . . .	5-5
Connecting to a WLAN in Your Home . . . . .	5-6
Connecting to a Public WLAN . . . . .	5-7
Using Wireless Security Features . . . . .	5-7
Identifying an 802.11 Wireless Device . . . . .	5-8
Troubleshooting Devices . . . . .	5-8
Bluetooth Wireless Devices (Select Models Only) . . . . .	5-9
Wireless Device Power States . . . . .	5-11
Turning On the Devices . . . . .	5-13
Turning Off and Disabling the Devices . . . . .	5-14

## **6 Security**

Security Features . . . . .	6-1
QuickLock . . . . .	6-3
Setup Utility and Windows Passwords . . . . .	6-4
Coordinating Passwords . . . . .	6-6
Choosing a Password . . . . .	6-6
Setup Utility Administrator Password . . . . .	6-7
Setting an Administrator Password . . . . .	6-8
Entering an Administrator Password . . . . .	6-8
Setup Utility Power-On Password . . . . .	6-9
Setting a Power-On Password . . . . .	6-10
Entering a Power-On Password . . . . .	6-10
Setup Utility Device Security . . . . .	6-11
Antivirus Software . . . . .	6-12
Critical Security Updates for Windows XP . . . . .	6-13
Firewall Software . . . . .	6-14
Optional Security Cable . . . . .	6-15

---

## 7 Hardware Upgrades and Replacements

Device Connections . . . . .	7-1
Connecting a Powered Device. . . . .	7-1
Connecting a USB Device. . . . .	7-2
Connecting a 1394 Device. . . . .	7-3
Connecting a Communication Device. . . . .	7-4
Digital Memory Cards . . . . .	7-5
Using the Memory Reader Light. . . . .	7-6
Inserting a Digital Memory Card. . . . .	7-7
Removing a Digital Memory Card . . . . .	7-8
PC Cards. . . . .	7-9
Inserting a PC Card . . . . .	7-10
Stopping or Removing a PC Card . . . . .	7-11
Drives. . . . .	7-13
Adding a Drive to the System . . . . .	7-13
Using the IDE Drive Light . . . . .	7-13
Caring for Drives. . . . .	7-14
Replacing the Internal Hard Drive. . . . .	7-15
Memory . . . . .	7-19
Increasing Memory . . . . .	7-19
Removing or Inserting a Memory Module . . . . .	7-20

## 8 Software Updates and Recovery and System Software

Software Updates . . . . .	8-1
Preparing for a Software Update . . . . .	8-2
Downloading and Installing an Update . . . . .	8-4
Software Recovery . . . . .	8-9
Using System Restore . . . . .	8-9

Setup Utility . . . . .	8–11
Opening the Setup Utility . . . . .	8–11
Changing the Language of Computer Setup . . . . .	8–12
Navigating and Selecting in the Setup Utility . . . . .	8–13
Displaying System Information. . . . .	8–14
Restoring Default Settings in the Setup Utility . . . . .	8–15
Using Advanced Setup Utility Features . . . . .	8–16
Closing the Setup Utility . . . . .	8–17

## **A Specifications**

Operating Environment . . . . .	A–1
Rated Input Power . . . . .	A–2
Expansion Port Input/Output Signals. . . . .	A–3

## **Index**



# Component ID

## Top Components

### Keys



Component	Description
❶ <b>fn</b> key	Combines with other keys to perform system tasks. For example, pressing <b>fn+f7</b> decreases screen brightness.
❷ Function keys (12)	Perform system and application tasks. When combined with <b>fn</b> , the function keys perform additional tasks as hotkeys.

*(Continued)*

<b>3</b>	Keypad keys (15)	Can be used like the keys on an external numeric keypad.
<b>4</b>	Windows applications key	Displays a shortcut menu for items beneath the pointer.
<b>5</b>	Windows logo key	Displays the Microsoft® Windows® Start menu.

# TouchPad

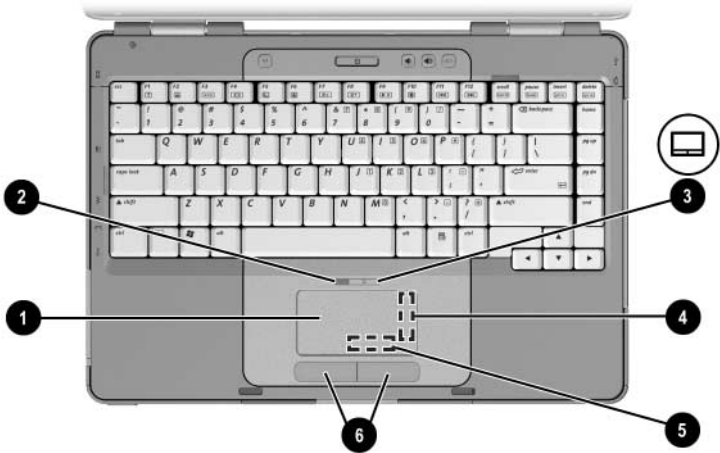

Component	Description
❶ TouchPad*	Moves the pointer.
❷ TouchPad light	On: TouchPad is enabled.
❸ TouchPad button	Enables/disables the TouchPad.
❹ TouchPad vertical scrolling region*	Scrolls upward or downward.
❺ TouchPad horizontal scrolling region	Scrolls toward left side or right side.
❻ Left and right TouchPad buttons*	Function like the left and right buttons on an external mouse.

\*This table describes default settings. For information about changing the functions of TouchPad components, refer to the [“Setting TouchPad Preferences”](#) section in [Chapter 2, “Keyboard and Touchpad.”](#)

## Power Controls



Component	Description
<b>1</b> Display switch*	If the notebook is closed while on, initiates standby.
<b>2</b> Power button*	When the notebook is <ul style="list-style-type: none"> <li>■ Off, press to turn on the notebook.</li> <li>■ On, briefly press to initiate hibernation.</li> <li>■ In standby, briefly press to resume from standby.</li> <li>■ In hibernation, briefly press to restore from hibernation.</li> </ul> <p>  If the system has stopped responding and Windows shutdown procedures cannot be used, press and hold for at least 4 seconds to turn off the notebook.                 </p>

\*This table describes default settings. For information about changing the function of the display switch or power button, refer to the [“Setting Other Power Preferences”](#) section in [Chapter 3, “Power.”](#)

# Lights

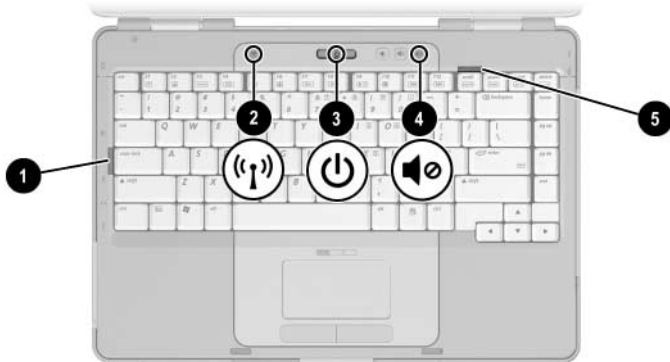



Component	Description
❶ Caps lock light	On: Caps lock is on.
❷ Wireless light (select models only)	On: One or more optional internal wireless devices, such as a WLAN and/or a Bluetooth device, are turned on.*
❸ Power/standby light†	On: Notebook is turned on. Blinking: Notebook is in standby. Off: Notebook is off.
❹ Mute light	On: Volume is muted.
❺ Num lock light	On: Num lock or the embedded numeric keypad is on.

\*For information about establishing a wireless connection, refer to [Chapter 5, “Wireless \(Select Models Only\).”](#)

†There are 2 power/standby lights. Both lights display the same information. The light on the power button is visible only when the notebook is open; the other power/standby light is always visible on the front of the notebook.

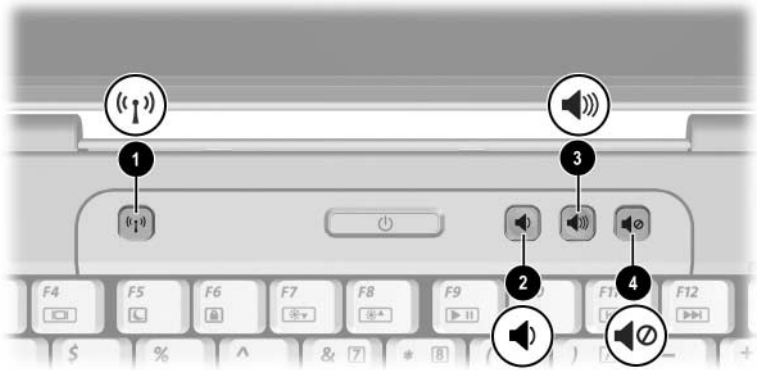
## Wireless and Volume Buttons



Component	Description
<b>1</b> Wireless button (select models only)	Turns the wireless functionality on or off, but does not create a wireless connection.   To establish a wireless connection, a wireless network must already be set up. For information about establishing a wireless link, refer to <a href="#">Chapter 5, "Wireless (Select Models Only)."</a>
<b>2</b> Volume down button	Decreases system volume.
<b>3</b> Volume up button	Increases system volume.
<b>4</b> Volume mute button	Mutes or restores volume.

## Antennae



Component	Description
Antennae (2)*	Send and receive wireless device signals.
	<p> <b>Exposure to Radio Frequency Radiation.</b> The radiated output power of this device is below the FCC radio frequency exposure limits. Nevertheless, the device should be used in such a manner that the potential for human contact during normal operation is minimized. To avoid the possibility of exceeding the FCC radio frequency exposure limits, human proximity to the antennae should be not less than 20 cm (8 inches) during normal operation, including when the notebook display is closed.</p>
<p>*The antennae are available on only select models. The antennae are not visible from the outside of the notebook. For optimal transmission, keep the areas immediately around the antennae free from obstructions.</p>	

# Front Components

## Lights

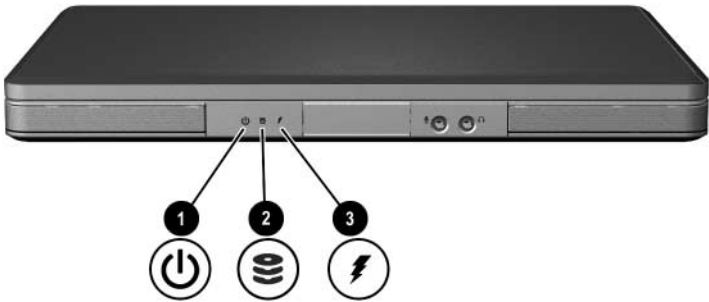

Component	Description
❶ Power/standby light*	On: Notebook is turned on. Blinking: Notebook is in standby. Off: Notebook is off.
❷ IDE (Integrated Drive Electronics) drive light	On or blinking: The internal hard drive or an optical drive is being accessed.
❸ Battery light	On: The battery pack is charging. Blinking: The battery pack has reached a low-battery condition. Off: The battery pack is fully charged or not inserted.

\*There are 2 power/standby lights. Both lights display the same information. The light on the power button is visible only when the notebook is open; the other power/standby light is always visible on the front of the notebook.



## Speakers, Jacks and Display Release Button

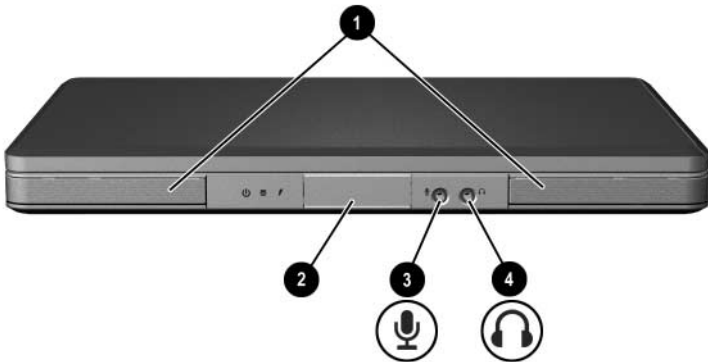

Component	Description
① Stereo speakers (2)	Produce stereo sound.
② Display release button	Opens the notebook.
③ Audio-in (microphone) jack	Connects an optional monaural (single sound channel) microphone.
④ Audio-out (headphone) jack	Connects optional headphones or powered stereo speakers. Also connects the audio function of an audio/video device such as a television or VCR.

## Rear Components



Component	Description
❶ Exhaust vent*	Provides airflow to cool internal components.  ⚠ To prevent overheating, do not obstruct vents. Do not allow a hard surface, such as a printer, or a soft surface, such as pillows or thick rugs or clothing, to block airflow.
❷ Power connector	Connects the AC adapter cable.

\*The notebook has 4 vents. This and all other vents are visible on the bottom of the notebook. One vent is also visible on the left side of the notebook.

# Left-Side Components

## Ports and Jacks

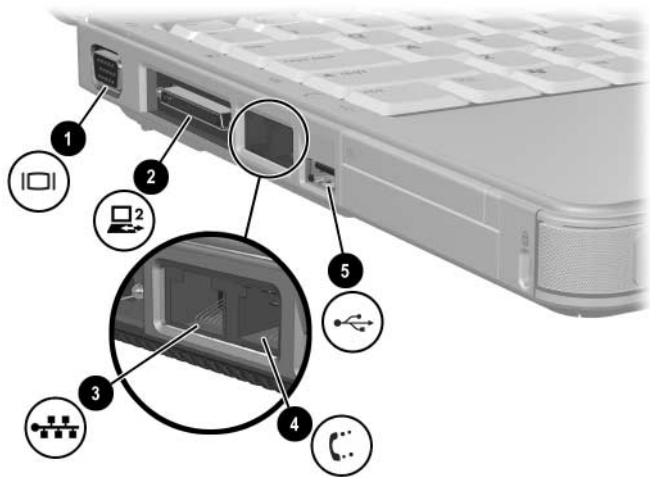

Component	Description
① External monitor port	Connects an optional VGA monitor or projector.
② Expansion Port 2 (select models only)*	Connects the notebook to an optional docking device.
③ RJ-45 (network) jack	Connects an optional network cable.
④ RJ-11 (modem) jack	Connects the modem cable.
⑤ USB port†	Connects an optional USB device.

\*For expansion port signal information, refer to the “[Expansion Port Input/Output Signals](#)” section in “[Appendix A.](#)”

†The notebook has 3 USB ports. The other USB ports are on the right side of the notebook.

## PC Card Slot and Button

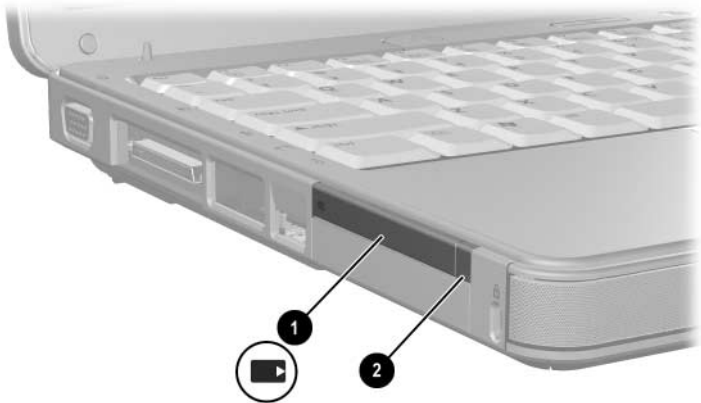

Component	Description
❶ PC Card slot	Supports an optional Type I or Type II 32-bit (CardBus) or 16-bit PC Card.
❷ PC Card eject button	Ejects an optional PC Card from the PC Card slot.

## Vent and Security Cable Slot

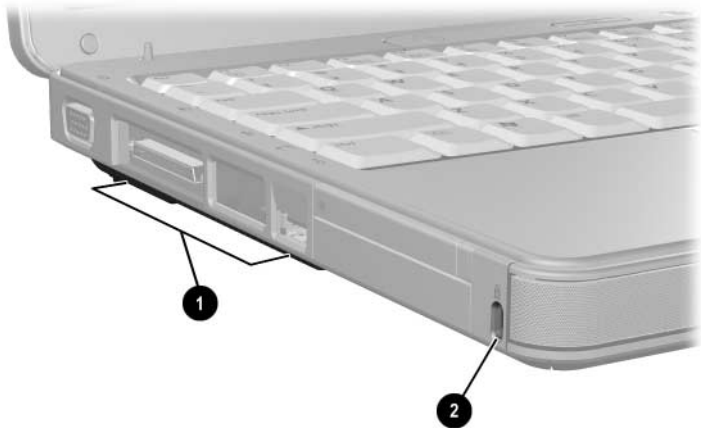

Component	Description
① Exhaust vent*	<p>Provides airflow to cool internal components.</p> <p>△ To prevent overheating, do not obstruct vents. Do not allow a hard surface, such as a printer, or a soft surface, such as pillows or thick rugs or clothing, to block airflow.</p>
② Security cable slot	<p>Attaches an optional security cable to the notebook.</p> <p>✎ The purpose of security solutions is to act as a deterrent. These solutions do not prevent the product from being mishandled or stolen.</p>

\*The notebook has 4 vents. This and all other vents are visible on the bottom of the notebook. One vent is also visible on the rear of the notebook.

## Right-Side Components

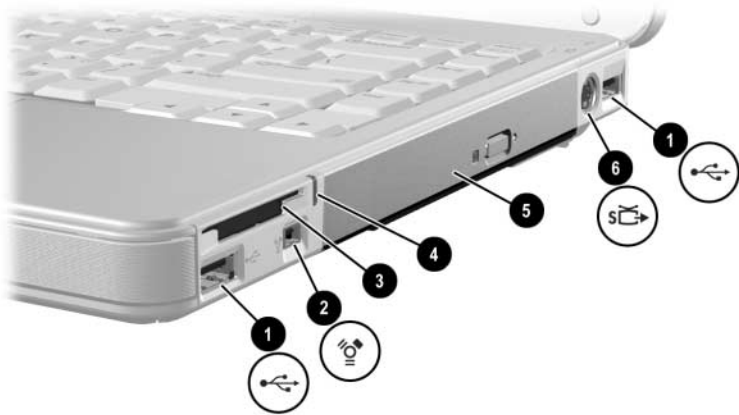

Component	Description
❶ USB ports (2)*	Connect optional USB devices.
❷ 1394 port	Connects an optional 1394a device such as a scanner, a digital camera, or a digital camcorder.
❸ Memory Reader (select models only)	Supports an optional digital memory card.†
❹ Memory Reader light (select models only)	On: An optional digital memory card is being accessed.

(Continued)

---

Component	Description
⑤ Optical drive <sup>‡</sup>	Supports an optical disc.
⑥ S-Video—out jack (select models only)	Connects an optional S-Video device such as a television, VCR, camcorder, projector, or video capture card.

---

\*The notebook has 3 USB ports. The other USB port is on the left side.

†The digital memory card could be a Secure Digital (SD) Memory Card, Memory Stick, Memory Stick Pro, xD-Picture Card, MultiMediaCard, or SmartMedia (SM) card.

‡The type of optical drive—for example, a DVD-ROM drive, a DVD/CD-RW Combo Drive, or a DVD+RW/R and CD-RW Combo Drive—varies by notebook model.

---

## Bottom Components

### Mini PCI and Memory Compartments

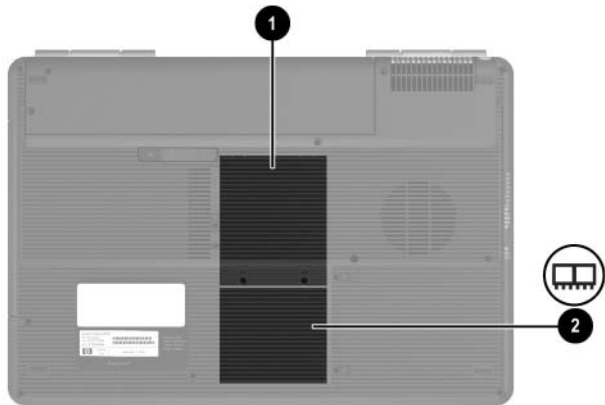

Component	Description
❶ Mini PCI compartment	<p>Holds an optional wireless LAN device.</p> <p>⚠ To prevent an unresponsive system and the display of a warning message, install only a Mini PCI device authorized for use in your notebook by the governmental agency that regulates wireless devices in your country. If you install an unauthorized device and then receive a warning message, remove the device to restore notebook functionality. Then contact Customer Care.</p>
❷ Memory compartment	<p>Contains 2 memory slots that support replaceable memory modules. The number of preinstalled memory modules varies by notebook model.</p>



## Bays, Battery Latch and Vents

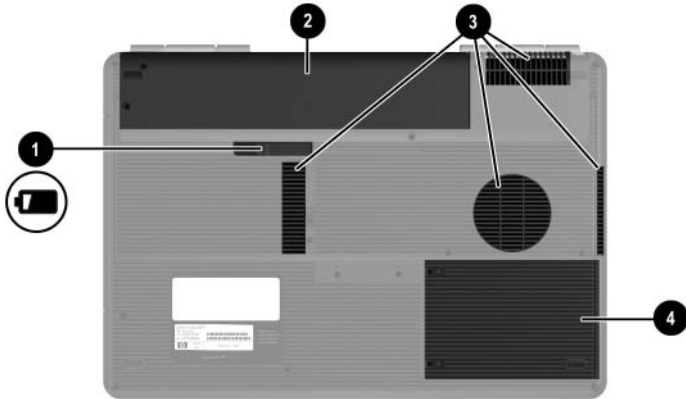

Component	Description
① Battery pack release latch	Releases a battery pack from the battery bay.*
② Battery bay	Holds a battery pack.
③ Exhaust vents (4)†	Provide airflow to cool internal components.  <div style="display: flex; align-items: center;"> <div style="margin-right: 10px;">△</div> <p>To prevent overheating, do not obstruct vents. Do not allow a hard surface, such as a printer, or a soft surface, such as pillows or thick rugs or clothing, to block airflow.</p> </div>
④ Hard drive bay	Holds the internal hard drive.

\*Battery packs vary by model.  
†The notebook has 4 vents. One vent is also visible on the left side of the notebook, and one vent is also visible on the rear of the notebook.

# Additional Components

## Hardware

The components included with your notebook vary by region, country, notebook model, and the optional hardware you purchased. The following sections identify the standard external components included with most notebook models.

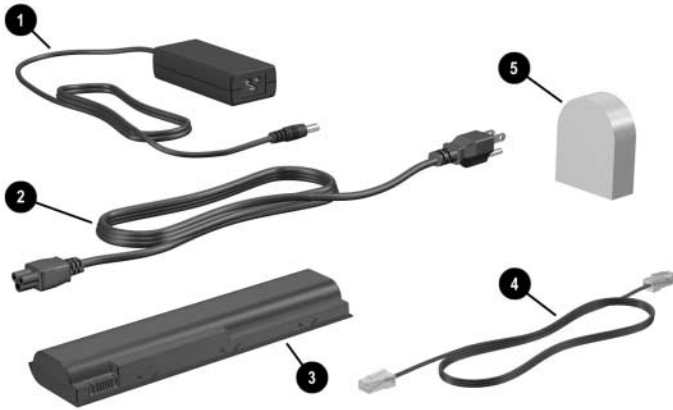

Component	Description
① AC adapter	Converts AC power to DC power.
② Power cord*	Connects an AC adapter to an AC outlet.
③ Battery pack*	Powers the notebook when the notebook is not connected to external power.
④ Modem cable*	Connects a modem to an RJ-11 telephone jack or to a country-specific modem adapter.
⑤ Country-specific modem adapter (included by region as required)*	Adapts the modem cable to a non-RJ-11 (modem) jack.

\*Power cords, modem cables, and modem adapters vary in appearance by region and country. Battery packs vary by model.

## Optical Discs

Software on optical discs, such as CDs or DVDs, is included with all notebook models.

- The software packaged in the “Required for Setup” bag is not preinstalled on your notebook. Depending on how you want to use your notebook, you may want to install some or all of these applications.
- The software packaged in the “Save for Later” bag is preinstalled or preloaded on your notebook. The software discs are provided in case you ever need to repair or reinstall this software.

## Labels

The labels affixed to the notebook provide information you may need when you troubleshoot system problems or travel internationally with the notebook.

- **Service Tag**—Provides the product name, product number (P/N), and serial number (S/N) of your notebook. You may need the product number and the serial number when you contact Customer Care. The Service Tag label is affixed to the bottom of the notebook. To display the information on the Service Tag on your screen, select **Start > Help and Support**.
- **Microsoft Certificate of Authenticity**—Contains the Microsoft® Windows® Product Key. You may need the Product Key to update or troubleshoot the operating system. This certificate is affixed to the bottom of the notebook.
- **Regulatory label**—Provides regulatory information about the notebook. The Regulatory label is affixed to the inside of the battery bay.

- **Modem Approval label**—Provides regulatory information about the modem and lists the agency approval markings required by some of the countries in which the modem has been approved for use. You may need this information when traveling internationally. The Modem Approval label is affixed to the inside of the memory compartment cover.
- **Wireless certification labels**—Some notebook models include an optional WLAN device and/or an optional Bluetooth® device. If your notebook model includes one or more wireless devices, a certificate providing regulatory information about each device and the approval markings of some of the countries in which the device has been approved for use is included with your notebook. You may need this information when traveling internationally. Wireless certification labels are affixed to the inside of the Mini PCI compartment cover.

---

# Keyboard and Touchpad

## TouchPad

### Identifying TouchPad Components

The TouchPad includes the following components:

- |                   |  |
|-------------------|--|
| ❶ TouchPad        | ❷ TouchPad vertical scrolling region   |
| ❸ TouchPad light  | ❹ Left and right TouchPad buttons      |
| ❺ TouchPad button | ❻ TouchPad horizontal scrolling region |

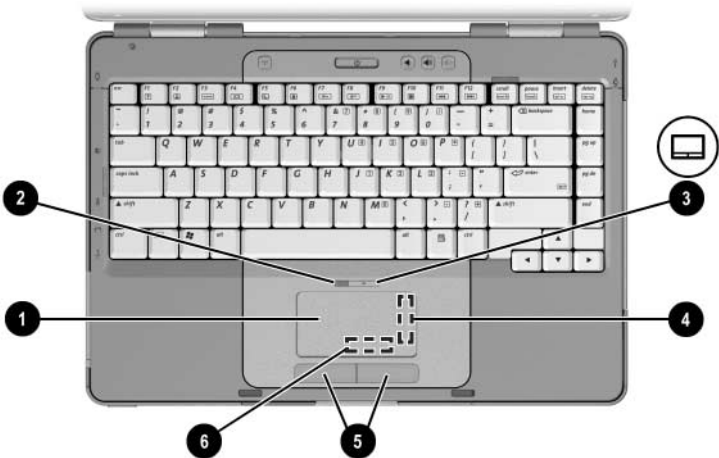

## Using the TouchPad

The TouchPad provides the navigation, selection, and scroll functions of an optional external mouse:

- To move the pointer, slide your finger across the TouchPad surface in the direction you want to move the pointer.
- To execute the click functions of the left or right button on an external mouse, press the left or right TouchPad button.
- To scroll, place your finger onto a scrolling region, and then slide your finger along the scrolling region in the direction you want to scroll. (Sliding your finger from the TouchPad to a scrolling region without first lifting your finger from the TouchPad and then placing it on the scrolling region will not activate the scrolling region.)
- To enable or disable the TouchPad, press the TouchPad button. When the TouchPad is enabled, the TouchPad light is on.

The TouchPad is enabled when the notebook is turned on. If you work with keystrokes rather than mouse actions, you may prefer to disable the TouchPad to prevent accidental TouchPad activity.

## Setting TouchPad Preferences

In the Windows Mouse Properties window you can

- Adjust basic pointing device settings such as click speed, pointer speed and shape, and mouse trails.
- Configure the right and left TouchPad buttons for right-handed or left-handed use. These buttons are set by default for right-handed use.

To access the Mouse Properties window:

- » Select **Start > Control Panel > Printers and Other Hardware > Mouse**.



All Windows instructions in your notebook documentation describe Microsoft Windows XP procedures based on the default Windows XP category view. To change to Windows XP classic view, select **Start > Help and Support > Customizing your computer > Files, folders, and programs > Use Windows classic folders**.

---

In the TouchPad Properties window you can access additional TouchPad preferences.

- » To access the TouchPad Properties window, use the TouchPad to select **Start > Control Panel > Printers and Other Hardware > Mouse > Device Settings**, and then select the **Settings** button. (If you follow this path using an optional external mouse, the TouchPad Properties window may be unavailable.)

Among the preferences available in the TouchPad Properties window are

- TouchPad Tapping, which enables you to tap the TouchPad once to select an item or twice to double-click an item.

To access TouchPad Tapping settings, select **Tapping**.

- Edge Motion, which sets the TouchPad to continue cursor movement when your finger reaches the edge of the TouchPad.

To access Edge Motion settings, select **Pointer Motion**.

- Long Distance Scrolling, which sets the scrolling region to continue scrolling when your finger reaches the end of the scrolling region.

To access Long Distance Scrolling, select **Virtual Scrolling**.

- PalmCheck, which helps keep the TouchPad from being accidentally activated while you are using the keyboard.

To access PalmCheck, select **Sensitivity**.



# Hotkeys

## Identifying Hotkeys

Hotkeys are preset combinations of the **fn** key ❶, the **esc** key ❷, and one of the function keys ❸.

The icons on the **f1** through **f12** keys represent hotkey functions. Hotkey functions and procedures are described in the following sections.

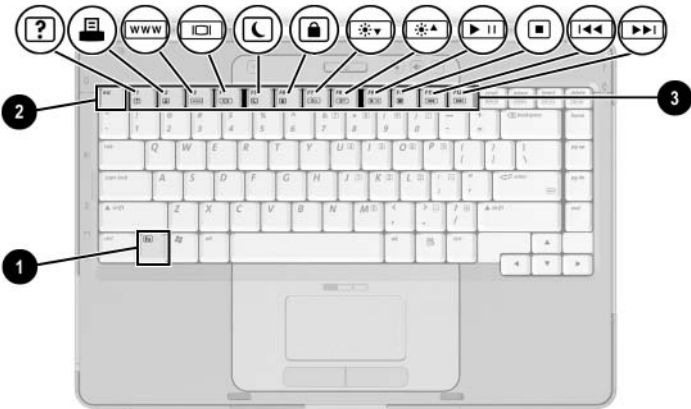

## Hotkey Quick Reference

The following table identifies the default hotkey functions. The function of the **fn+f5** hotkey can be changed. For instructions, refer to the [“Setting Other Power Preferences”](#) section in [Chapter 3, “Power.”](#)

<b>Default Function</b>	<b>Hotkey</b>
Opens Help and Support Center.	<b>fn+f1</b>
Opens print options window.	<b>fn+f2</b>
Opens default Internet browser.	<b>fn+f3</b>
Switches the image among displays.	<b>fn+f4</b>
Initiates standby.	<b>fn+f5</b>
Initiates QuickLock.	<b>fn+f6</b>
Decreases screen brightness.	<b>fn+f7</b>
Increases screen brightness.	<b>fn+f8</b>
Plays, pauses, or resumes an audio CD or DVD.	<b>fn+f9</b>
Stops an audio CD or DVD.	<b>fn+f10</b>
Plays the previous track or chapter on an audio CD or DVD.	<b>fn+f11</b>
Plays the next track or chapter on an audio CD or DVD.	<b>fn+f12</b>
Displays system information.*	<b>fn+esc</b>

\*To clear the system information display, press **esc**.

## Using Hotkey Procedures

### Using Hotkeys On the Internal Keyboard

To use a hotkey command on the notebook keyboard, use either of the following procedures:

- Briefly press **fn**, and then briefly press the second key of the hotkey command.
- Press and hold down **fn**, briefly press the second key of the hotkey command, and then release both keys at the same time.

### Using Hotkeys on an External Keyboard

To use a hotkey command on an external keyboard, press the **scroll lock** key twice, then the second key only of the hotkey combination. For example, to use the **fn+f5** command on an external keyboard, press **scroll lock+scroll lock+f5**.

## Using Hotkey Commands

### Open Help and Support Center (fn+f1)

The **fn+f1** hotkey opens the Help and Support Center.

In addition to providing information about your operating system, the Help and Support Center provides

- Information about your notebook, such as model and serial number, installed software, hardware components, and specifications.
- Answers to questions about using your notebook.
- Tutorials to help you learn to use notebook and operating system features.
- Updates for your operating system, drivers, and the software provided on your notebook.

- Checkups for notebook functionality.
- Automated and interactive troubleshooting, repair solutions, and system recovery procedures.
- Links to Customer Care.

You can also access the Help and Support Center by selecting **Start > Help and Support**.

## Open Print Window (fn+f2)

In Windows the **fn+f2** hotkey opens the print options window of the active Windows application.

## Open Internet Explorer (fn+f3)

The **fn+f3** hotkey opens Internet Explorer.

- Until you have set up your Internet or network services, the **fn+f3** hotkey opens the Windows Internet Connection Wizard.
- After you have set up your Internet or network services and your Web browser home page, you can use the **fn+f3** hotkey to quickly access your home page and the Internet.

## Switch Image (fn+f4)

The **fn+f4** hotkey switches the image among display devices connected to the system. For example, if an optional monitor is connected to the notebook through the monitor port, each time you press the **fn+f4** hotkey the image will switch among the notebook display, the monitor display, and a simultaneous display on both the notebook and the monitor.

Most monitors receive video information from the notebook using the external VGA video standard. The **fn+f4** hotkey can also toggle images among other devices receiving video information from the notebook.

The following video transmission types, with examples of devices that use them, are supported by the **fn+f4** hotkey:

- LCD (notebook display)
- External VGA (most monitors)
- S-Video (televisions, camcorders, VCRs, and video capture boards with S-Video-in jacks)
- Composite video (televisions, camcorders, VCRs, and video capture boards with composite video-in jacks)

## Initiate Standby (fn+f5)

The **fn+f5** hotkey is set by default to initiate standby.

When standby is initiated, your work is saved in random access memory (RAM), the screen clears, and power is conserved.

While the notebook is in standby, the power/standby lights blink.

- To initiate standby, the notebook must be on. If the notebook is in hibernation, you must restore from hibernation before you can initiate standby.
- To resume from standby or restore from hibernation, briefly press the power button.

For more information about using standby and hibernation, refer to [Chapter 3, “Power.”](#)

The function of the **fn+f5** hotkey can be changed in the operating system. For example, you can set the **fn+f5** hotkey to initiate hibernation instead of standby. In all Windows operating system windows, references to the *sleep button* apply to the **fn+f5** hotkey. For information about changing the function of the **fn+f5** hotkey, refer to the [“Setting Other Power Preferences”](#) section in [Chapter 3, “Power.”](#)

For more information about using standby and hibernation, refer to [Chapter 3, “Power.”](#)

## Initiate QuickLock (fn+f6)

The **fn+f6** hotkey initiates the QuickLock security feature.

QuickLock protects your work by displaying the operating system Log On window. While the Log On window is displayed, the notebook cannot be accessed until a Windows user password or a Windows administrator password is entered.

Before you can use QuickLock, you must set a Windows user password or a Windows administrator password. For instructions, refer to the Help and Support Center. To access the Help and Support Center, press the **fn+f1** hotkey or select **Start > Help and Support**.

- » To use QuickLock, press **fn+f6** to display the Log On window and lock the notebook. Then follow the instructions on the screen to enter your Windows user password or your Windows administrator password and access the notebook.

For information about combining Windows passwords with Compaq passwords, [Chapter 6, "Security."](#)

## Decrease Brightness (fn+f7)

The **fn+f7** hotkey decreases the brightness of the notebook screen. The longer you hold down the **fn+f7** hotkey, the more the screen dims. Decreasing screen brightness conserves power.

- » To increase screen brightness, press the **fn+f8** hotkey.

## Increase Brightness (fn+f8)

The **fn+f8** hotkey increases the brightness of the notebook screen. The longer you hold down the **fn+f8** hotkey, the more the screen brightens.

- » To decrease screen brightness, press the **fn+f7** hotkey.

## Media Activity Hotkeys (fn+f9 through fn+f12)

The following 4 media activity hotkeys can control the play of an audio CD or a DVD. To control the play of a video CD, use the media activity controls in your video CD player.

### **Play, Pause or Resume an Audio CD or a DVD (fn+f9)**

- If the audio CD or the DVD is not playing, press the **fn+f9** hotkey to begin or resume the play.
- If the audio CD or the DVD is playing, press the **fn+f9** hotkey to pause the play.

### **Stop an Audio CD or a DVD (fn+f10)**

The **fn+f10** hotkey stops the play of an audio CD or a DVD.

You must stop a CD or DVD that is playing before you can remove it from the optical drive.

### **Play Previous Track or Chapter of an Audio CD or a DVD (fn+f11)**

The **fn+f11** hotkey plays the previous track of an audio CD or the previous chapter of a DVD that is playing.

### **Play Next Track or Chapter of an Audio CD or a DVD (fn+f12)**

The **fn+f12** hotkey plays the next track of an audio CD or the next chapter of a DVD that is playing.



## Display System Information (fn+esc)

The **fn+esc** hotkey displays information about system hardware components and software version numbers.

» To clear the display, press **esc**.

In the **fn+esc** display, the version of the system BIOS (basic input-output system) is displayed as the BIOS date. On some notebook models, the BIOS date is displayed in decimal format. The BIOS date is sometimes called the *system ROM version number*. For information about updating the system ROM, refer to the “[Software Updates](#)” section in [Chapter 8, “Software Updates and Recovery and System Software.”](#)

## Keypads

You can do keypad work with your notebook by using the embedded numeric keypad in the notebook keyboard or by connecting an optional external numeric keypad.

The embedded numeric keypad cannot be used while an external keypad is connected to the notebook.

### Using the Embedded Numeric Keypad

The embedded numeric keypad consists of 15 keys that can be used like the keys on an external numeric keypad. When the embedded numeric keypad is turned on, each keypad key performs the functions indicated by the icon in the upper-right corner of the key.



## Turning the Embedded Numeric Keypad On and Off

When the embedded numeric keypad is off, press **fn+num lk** ❶ to turn the keypad on. The num lock light ❷ is turned on.

When the embedded numeric keypad is on, press **fn+num lk** to turn the keypad off. The num lock light is turned off.

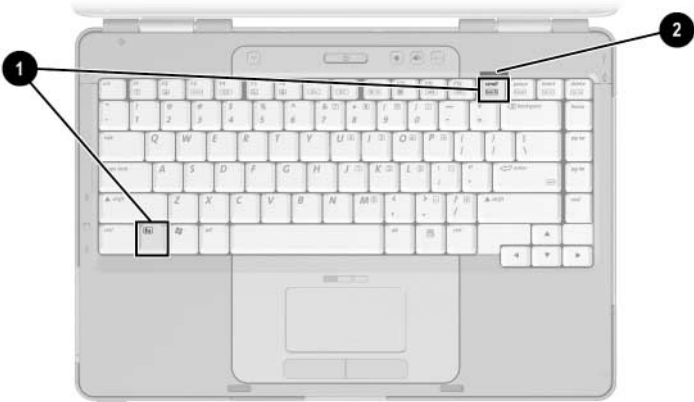

## Switching the Functions of Keypad Keys

You can temporarily switch the functions of an embedded numeric keypad key between its standard function and its keypad function.

- To use a key on the keypad as a keypad key while the keypad is turned off, press and hold **fn** while pressing the key.
- To use a key on the keypad as a standard key while the keypad is turned on:
  - Press and hold **fn** to type with the key in lowercase.
  - Press and hold **fn+shift** to type with the key in uppercase.

Releasing **fn** returns a keypad key to its set function. For example, a keypad key returns to its keypad function if the keypad is turned on or to its standard function if the keypad is turned off.

## Using an External Numeric Keypad

---



The embedded numeric keypad cannot be used while an optional external numeric keypad is connected to the notebook.

---

Most keys on most external numeric keypads function differently depending on whether num lock mode is on or off. For example:

- When num lock mode is on, most keypad keys type numbers.
- When num lock mode is off, most keypad keys function like the arrow, page up, or page down keys.

## Turning Num Lock Mode On and Off As You Work

To turn num lock mode on or off on an external numeric keypad as you work, press the **num lk** key on the external keypad, not on the notebook.

- When an external numeric keypad is turned on and is in num lock mode, the num lock light on the notebook is on.
- When an external numeric keypad is turned off or is turned on with num lock mode turned off, the num lock light on the notebook is off.

## Power Sources

### Selecting a Power Source

Use the following table to select a recommended power source for the way you plan to use the notebook.

Task	Recommended Power Source
Work in most software applications	<ul style="list-style-type: none"> <li>■ Charged battery pack in the notebook</li> <li>■ External power supplied through one of the following devices:               <ul style="list-style-type: none"> <li><input type="checkbox"/> AC adapter</li> <li><input type="checkbox"/> Optional docking device</li> <li><input type="checkbox"/> Optional combination power adapter</li> </ul> </li> </ul>
Charge or calibrate a battery pack in the notebook	<p>External power supplied through one of the following devices:</p> <ul style="list-style-type: none"> <li>■ AC adapter</li> <li>■ Optional docking device</li> <li>■ Optional combination power adapter</li> </ul> <p> Do not charge the notebook battery pack onboard aircraft. Charging the battery pack may damage aircraft electronic systems.</p>
Install or modify system software or write to an optical disc	<p>External power supplied through one of the following devices:</p> <ul style="list-style-type: none"> <li>■ AC adapter</li> <li>■ Optional docking device</li> </ul>

## Switching Between Battery and External Power

The notebook runs on external power whenever external power is available to the notebook. This conserves the charge in an inserted battery pack. External power can be supplied through the AC adapter, an optional docking device, or an optional combination power adapter.

Because the notebook switches between battery power and external power according to the availability of external power:

- If the notebook is running on battery power and you connect the notebook to external power, the notebook switches to external power.
- If the notebook is running on external power (and contains a charged battery pack) and you disconnect the notebook from external power, the notebook switches to battery power.

A Power Meter icon is displayed by default in the taskbar. The Power Meter icon changes shape whenever the power source changes between battery power and external power.

If the Power Meter icon is not displayed in your taskbar:

1. Select **Start > Control Panel > Performance and Maintenance > Power Options**.
2. Select the **Advanced** tab.
3. Select the **Always show icon on the taskbar** check box.
4. Select **OK**.

## Power Control and Light Locations

This illustration is provided as a quick reference to the locations of the power controls and lights on the notebook.

The function of each of these items is summarized in [Chapter 1, “Component ID.”](#) Instructions for using these items are provided in this chapter.

- |                       |                       |
|-----------------------|-----------------------|
| ① Display switch      | ④ Battery light       |
| ② Power button        | ⑤ Power/standby light |
| ③ Power/standby light | ⑥ <b>fn+f5</b> hotkey |



The power/standby lights display identical information. The power/standby lights are visible when the notebook is open or closed.

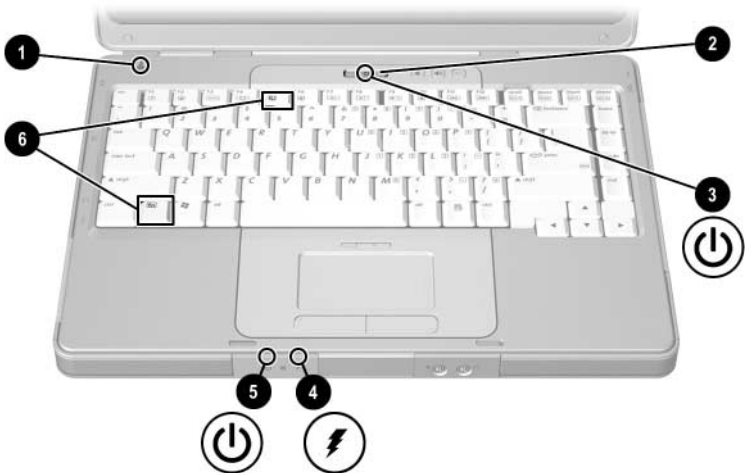



# Standby, Hibernation and Shutdown Overviews

## Standby

Standby reduces power to system components that are not in use. When standby is initiated, your work is saved in random access memory (RAM), the screen is cleared, and the power/standby lights blink. Saving your work before initiating standby is not usually necessary but is a recommended precaution. When you resume from standby, your work is returned instantly to the screen.

By default, the system initiates standby after 10 minutes of notebook inactivity when the notebook is running on battery power and after 25 minutes of inactivity when the notebook is running on external power. For information about changing these settings, refer to the [“Using Power Schemes”](#) section later in this chapter.

---

## Hibernation



**CAUTION:** If the configuration of the notebook system is changed during hibernation, it may not be possible to resume from hibernation. When the notebook is in hibernation:

- Do not add or remove a memory module.
  - Do not remove or replace the hard drive.
  - Do not connect or disconnect an external device.
  - Do not insert or remove a CD, DVD, PC Card, or digital memory card.
- 

Hibernation saves your work to a hibernation file on the hard drive and then shuts down the notebook. When hibernation is complete, the power/standby lights are turned off.

When you restore from hibernation, your work is returned to the screen where you left off. Restoring from hibernation takes a little longer than resuming from standby but is much faster than returning to your place manually after restarting the notebook.

To determine whether the notebook is in hibernation or turned off, press the power button.

- If the notebook is in hibernation, your work is returned to the screen.
- If the notebook is off, Windows loads.

When the notebook is running on battery power, hibernation is initiated by default after 30 minutes of notebook inactivity or whenever the notebook reaches a critical low-battery condition.

Hibernation is enabled by default but can be disabled. To prevent loss of work during a critical low-battery condition, disable hibernation only during a battery pack calibration.

- » To verify that hibernation is enabled, select **Start > Control Panel > Performance and Maintenance > Power Options > Hibernate** tab. If hibernation is enabled, the **Enable hibernation** check box is selected.

## Leaving Your Work

*If you plan to resume shortly*—Initiate standby for shorter times and hibernation for longer times or for power conservation.

The amount of time a battery pack can support standby or hibernation or hold a charge varies by notebook configuration and the condition of the battery pack. Standby requires more power than hibernation.

*If you plan to resume within 2 weeks*—Shut down the notebook. If possible, connect the notebook to external power to keep an inserted battery pack fully charged.

*If the notebook will be unused and disconnected from external power for more than 2 weeks*—Shut down the notebook. To extend the life of an inserted battery pack, remove the battery pack and store it in a cool, dry location.

*If an external power supply is uncertain*—Initiate hibernation or shut down the notebook. A power supply may become uncertain because of such conditions as an electrical storm or a nearly discharged battery pack.

## Interference with Drive Media

To prevent the loss of playback or playback quality, do not initiate standby or hibernation while playing a drive medium.

If standby or hibernation is initiated while a drive medium such as a CD or DVD is in use, you may see the warning message “Putting the computer into hibernation or standby may stop the playback. Do you want to continue?” If the message is displayed, select **No**. After you select No:

- Playback may resume.

– or –

- Playback may stop and the screen may be cleared. To return to your work, press the power button and then restart the disc.

## Standby, Hibernation and Shutdown Procedures

This section explains the default standby, hibernation, and shutdown procedures. For information about changing the function of some of the power features on your notebook, refer to the [“Power Preferences”](#) section later in this chapter.

The controls and lights discussed in this section are illustrated in in the [“Power Control and Light Locations”](#) section earlier in this chapter.

### Turning the Notebook On or Off

Task	Procedure	Results
Turn on the notebook.	<p>Press the power button.</p> <p> Pressing the power button turns on the notebook from standby, hibernation, or shutdown.</p>	<ul style="list-style-type: none"> <li>■ Power/standby lights are turned on.</li> <li>■ Operating system is loaded.</li> </ul>
Shut down the notebook.	<ul style="list-style-type: none"> <li>■ In Windows XP Home, select <b>Start &gt; Turn Off Computer &gt; Turn Off</b>.<sup>*†</sup></li> <li>■ In Windows XP Professional, select <b>Start &gt; Turn Off Computer &gt; Shut down &gt; OK</b>.<sup>*†</sup></li> </ul>	<ul style="list-style-type: none"> <li>■ Power/standby lights are turned off.</li> <li>■ Operating system is shut down.</li> <li>■ Notebook is turned off.</li> </ul>

\*If the system is unresponsive and you are unable to shut down the notebook with this procedure, refer to the [“Using Emergency Shutdown Procedures”](#) section later in this chapter.

†Depending on your network connections, the Turn Off Computer button may be called the *Shut Down* button.

## Initiating or Resuming from Standby

Task	Procedure	Result
Initiate standby.	<p>With the notebook on, use any of the following procedures:</p> <ul style="list-style-type: none"> <li>■ Press the <b>fn+f5</b> hotkey.</li> <li>■ Close the notebook.</li> </ul> <p> When the notebook is closed, the display presses the display switch, which then initiates standby.</p> <ul style="list-style-type: none"> <li>■ In Windows XP Home, select <b>Start &gt; Turn Off Computer &gt; Stand By</b>.*</li> <li>■ In Windows XP Professional, select <b>Start &gt; Turn Off Computer &gt; Stand by &gt; OK</b>.* (If Stand by is not displayed, press the down arrow, and then select <b>Stand by</b> from the drop-down list.)</li> </ul>	<ul style="list-style-type: none"> <li>■ Power/standby lights blink.</li> <li>■ Screen is cleared.</li> </ul>
Allow the system to initiate standby.	<p>No action is required. The system initiates standby</p> <ul style="list-style-type: none"> <li>■ After 10 minutes of inactivity while running on battery power.</li> <li>■ After 25 minutes of inactivity while running on external power.</li> </ul>	<ul style="list-style-type: none"> <li>■ Power/standby lights blink.</li> <li>■ Screen is cleared.</li> </ul>
Resume from standby.	<ul style="list-style-type: none"> <li>■ Briefly press the power button.</li> <li>– or –</li> <li>■ Open the notebook.<sup>†</sup></li> </ul>	<ul style="list-style-type: none"> <li>■ Power/standby lights are turned on.</li> <li>■ Your work is returned to the screen.</li> </ul>

\*Depending on your network connections, the Turn Off Computer button may be called the *Shut Down* button.

<sup>†</sup>Depending on your notebook configuration, you may also be able to resume from standby by moving or activating a control on an optional mouse or by opening the display if the notebook was closed while in standby.

## Initiating or Restoring from Hibernation

Hibernation cannot be initiated unless it is enabled. Hibernation is enabled by default. To verify that hibernation remains enabled, select **Start > Control Panel > Performance and Maintenance > Power Options > Hibernate** tab. If hibernation is enabled, the Enable hibernation check box is selected.

Task	Procedure	Result
Initiate hibernation.	In Windows XP Home, select <b>Start &gt; Turn Off Computer</b> . <sup>*</sup> Then hold down <b>shift</b> as you select the <b>Stand By</b> button. In Windows XP Professional, select <b>Start &gt; Turn Off Computer &gt; Hibernate</b> . <sup>*</sup> (If Hibernate is not displayed, press the down arrow, and then select <b>Hibernate</b> from the drop-down list.)	<ul style="list-style-type: none"> <li>■ Power/standby lights are turned off.</li> <li>■ Screen is cleared.</li> </ul>
Allow the system to initiate hibernation.	No action is required. If the notebook is running on battery power and hibernation is enabled, the system initiates hibernation <ul style="list-style-type: none"> <li>■ After 30 minutes of notebook inactivity.</li> <li>■ Whenever the battery pack reaches a critical low-battery condition.</li> </ul>	<ul style="list-style-type: none"> <li>■ Power/standby lights are turned off.</li> <li>■ Screen is cleared.</li> </ul>
Restore from hibernation.	Press the power button. <sup>†</sup>	<ul style="list-style-type: none"> <li>■ Power/standby lights are turned on.</li> <li>■ Your work is returned to the screen.</li> </ul>

<sup>\*</sup>Depending on your network connections, the Turn Off Computer button may be called the *Shut Down* button.

<sup>†</sup>If the system initiated hibernation because of a critical low-battery condition, connect external power or insert a charged battery pack before you press the power button. (The system may not respond if the drained battery pack is the only power source.)

## Using Emergency Shutdown Procedures

If the notebook does not respond to the standard Windows shutdown procedure for your operating system, try the following emergency shutdown procedures in the sequence provided:

- Press **ctrl+alt+del**. Then
  - In Windows XP Home, select **Shut Down > Turn Off**.
  - In Windows XP Professional, select **Shut down** from the drop-down list, and then select **OK**.
- Press and hold down the power button for at least 4 seconds.
- Unplug the notebook from external power and remove the battery pack. For battery pack removal instructions refer to the [“Replacing a Battery Pack”](#) section later in this chapter.

# Power Preferences

## Using Power Schemes

A power scheme controls the amount of power the notebook uses while running on external power or on a battery pack, and also sets the notebook to initiate standby or hibernation after a period of inactivity you specify.

- » To select a preset power scheme or create a custom power scheme, select **Start > Control Panel > Performance and Maintenance > Power Options**, and then follow the instructions on the screen.

## Setting a Standby Password

To set the notebook to prompt for a password before resuming from standby, select **Start > Control Panel > Performance and Maintenance > Power Options**. Select the **Advanced** tab, select the check box for **Prompt for password when computer resumes from standby**, and then select **OK**. For information about other passwords and security features, refer to [Chapter 6, "Security."](#)

## Setting Other Power Preferences

You can change the function of the power button, the **fn+f5** hotkey, and the display switch.

By default, when the notebook is on:

- Briefly pressing the power button initiates hibernation.
- Pressing the **fn+f5** hotkey, called the *sleep button* in all Microsoft operating systems, initiates standby.
- Closing the notebook presses the display switch, which initiates standby.



To change the function of the power button, the **fn+f5** hotkey, or the display switch:

1. Select **Start > Control Panel > Performance and Maintenance > Power Options > Advanced** tab.
  - ❑ To change the function of the power button, select a function from the drop-down list for “When I press the power button on my computer.”
  - ❑ To change the function of the **fn+f5** hotkey, select a function from the drop-down list for “When I press the sleep button on my computer.”
  - ❑ To change the function of the display switch, select a function from the drop-down list for “When I close the lid of my portable computer.” (The function of the display switch when you *open* the display is unaffected by these settings. When you open the display while the notebook is in standby, the display switch turns on the notebook.)
2. Select **OK**.

The Hibernate function is available in the power button, sleep button, and display switch drop-down lists only if hibernation is enabled. If the Hibernate function is not available on these lists, select **Start > Control Panel > Performance and Maintenance > Power Options > Hibernate** tab. Select the **Enable hibernation** check box, and then select **OK**.

# Battery Pack

## Charging a Battery Pack

To prolong battery life and optimize the accuracy of battery charge displays:

- If you are charging a *new* battery pack:
  - ❑ Charge the battery pack while the notebook is connected to external power through the AC adapter.
  - ❑ When you charge the battery pack, charge it fully.
- If you are charging an *in-use* battery pack:
  - ❑ Allow the battery pack to discharge to about 10 percent of a full charge through normal use before charging it.
  - ❑ When you charge the battery pack, charge it fully.

A battery pack inserted in the notebook charges whenever the notebook is connected to external power through an AC adapter, an optional docking device, or an optional combination power adapter.



**WARNING:** Do *not* charge the notebook battery pack onboard aircraft. Charging the battery pack may damage aircraft electronic systems.

---

A battery pack inserted in the notebook charges whether the notebook is off or in use, but the battery pack charges faster while the notebook is off. Charging may be delayed if a battery pack is new, has been unused for 2 weeks or more, or is much warmer or cooler than room temperature.

The battery light displays charge status:

- On: the battery pack is charging.
- Blinking: the battery pack has reached a low-battery condition and is not charging.
- Off: the battery pack is fully charged or not installed.

For information about determining the amount of charge in a battery pack, refer to the [“Monitoring the Charge in a Battery Pack”](#) section next in this chapter.

## Monitoring the Charge in a Battery Pack

### Obtaining Accurate Charge Reports

To increase the accuracy of battery charge reports:

- Allow a battery pack to discharge to about 10 percent of a full charge through normal use before charging it.
- When you charge a battery pack, charge it fully. The charge in even a new battery pack may be reported inaccurately until the battery pack has been fully charged at least once.
- If a battery pack has been unused for one month or more, calibrate the battery pack instead of simply charging it.

For information about battery calibration, refer to the [“Calibrating a Battery Pack”](#) section later in this chapter.

## Displaying Charge Reports

To display battery charge information on the screen, use the operating system Power Meter feature. To access the Power Meter display:

- Select **Start > Control Panel > Performance and Maintenance > Power Options > Power Meter** tab.

– or –

- Select the **Power Meter** icon, which is displayed by default in the taskbar. To display the Power Meter icon if the default setting has been changed, select **Start > Control Panel > Performance and Maintenance > Power Options**. Select the **Advanced** tab, select the **Always show icon on the taskbar** check box, and then select **OK**.

Power Meter displays battery status in both percent and time:

- The percent indicates the amount of charge remaining in the battery pack.
- The time indicates the approximate running time remaining on the battery pack *if the battery pack continues to provide power at the current level*. For example, the time remaining will decrease if you start playing a DVD and will increase if you stop playing a DVD.

## Managing Low-Battery Conditions

This section describes default low-battery condition alerts and system responses. The default battery light responses cannot be changed. To change other responses, select **Start > Control Panel > Performance and Maintenance > Power Options**, and then follow the instructions on the screen.

### Identifying Low-Battery Conditions

When a battery pack that is the only power source for the notebook reaches a *low-battery condition*, a text warning message is displayed, and the battery light blinks.

If a low-battery condition is not resolved and the amount of charge remaining in the battery pack continues to drop, the notebook eventually enters a *critical low-battery condition*. If the notebook is on or in standby when a critical low-battery condition is reached:

- If hibernation is enabled, the system initiates hibernation. Some unsaved work may be lost.
- If hibernation is disabled, the notebook remains briefly in standby, and then shuts down. All unsaved work is lost.

Hibernation is enabled by default. To verify that hibernation remains enabled, select **Start > Control Panel > Performance and Maintenance > Power Options > Hibernate** tab. If hibernation is enabled, the **Enable hibernation** check box is selected.

## Resolving Low-Battery Conditions

---



**CAUTION:** To prevent problems when restoring from hibernation: If the notebook has reached a critical low-battery condition and has begun to initiate hibernation, do not restore power until hibernation is complete. When hibernation is complete, the power/standby lights are turned off.

---

To resolve a low-battery condition:

- If external power is available, connect the notebook to the external power source.
- If a charged battery pack is available, shut down the notebook or initiate hibernation. Insert a charged battery pack, and then turn on the notebook.
- If no power source is available, save your work. Then initiate hibernation or shut down the notebook.

# Calibrating a Battery Pack

## When to Calibrate

Even if a battery pack is heavily used, calibration should be necessary only once a month. You do not have to calibrate a new battery pack before first use.

Calibration does not usually increase battery run time, but it can increase the accuracy of battery charge displays, especially under the following conditions:

- When the battery pack has been unused for one month or more.
- When the notebook has been running primarily on external power (and rarely on battery power) for more than one month.
- When battery charge displays report large changes in the percent of power remaining within 2 minutes. For example, if the Power Meter displays 20 percent of a full charge remaining and then less than 2 minutes later displays only 5 percent of a full charge remaining, the rapid drop in charge remaining indicates that the battery pack needs calibration.

For more information about battery charge displays, refer to the [“Monitoring the Charge in a Battery Pack”](#) section earlier in this chapter.



## How to Calibrate

To calibrate a battery pack, you must fully charge, fully discharge, and then fully recharge the battery pack.

### Charging the Battery Pack

Charge the battery pack while the notebook is on. To charge the battery pack:



**WARNING:** Do *not* charge the notebook battery pack onboard aircraft. Charging the battery pack may damage aircraft electronic systems.

---

1. Insert the battery pack into the notebook.
2. Connect the notebook to external power through the AC adapter or an optional combination power adapter. (The notebook battery light is on as the battery pack charges.)
3. Leave the notebook connected to external power until the battery pack is fully charged. (The notebook battery light is turned off.)

### Discharging the Battery Pack



**CAUTION:** To prevent loss of work, save your work before beginning an unattended discharge procedure.

---

The notebook must remain on throughout the discharge process. The battery pack can discharge whether or not you are using the notebook, but the battery pack will discharge faster if the notebook is in use.

---

If you use the notebook occasionally during the discharge process described below and have set energy-saving timeouts, expect the following performance from your system during the discharge:

- Any unsaved work from your current session will be lost when the battery pack is fully discharged and the notebook is shut down.
- The system will not turn off a connected optional monitor.
- The system will not decrease hard drive speed while the notebook is idle.
- System-initiated standby will not occur.

To fully discharge the battery pack:

1. Disable hibernation. To disable hibernation:

Select **Start > Control Panel > Performance and Maintenance > Power Options > Hibernate** tab. Then clear the **Enable hibernation** check box.

2. Display the settings on the Power Schemes tab. To access the Power Schemes tab:

Select **Start > Control Panel > Performance and Maintenance > Power Options > Power Schemes** tab.

3. Record all settings in the Plugged in column and all settings in the Running on batteries column, so you can reset them after calibration.
4. Use the drop-down lists to set each item in both columns to **Never**.
5. Select **OK**.
6. Disconnect the notebook from the external power source, but do *not* turn off the notebook.
7. Run the notebook on battery power until the battery pack is fully discharged. When the battery pack is fully discharged, the notebook is shut down.

## Recharging the Battery Pack

---



**CAUTION:** To prevent an unintended battery drain and a potential loss of work when the notebook reaches a critical low-battery condition, reenale hibernation after calibrating the battery pack. To reenale hibernation: Select **Start > Control Panel > Performance and Maintenance > Power Options > Hibernate** tab. Select the **Enable hibernation** check box, and then select **OK**.

---

1. Connect the notebook to external power and maintain the connection until the battery pack is fully recharged and the battery light is turned off.

You can use the notebook while the battery pack is recharging, but the battery pack will charge faster if the notebook is turned off.

2. If the notebook is turned off, turn on the notebook when the battery light is turned off, indicating that the battery pack is fully charged.
3. Display the settings on the Power Schemes tab. To access the Power Schemes tab:  
Select **Start > Control Panel > Performance and Maintenance > Power Options > Power Schemes** tab.
4. Reenter the settings you recorded earlier for the items in the Plugged in column and the Running on batteries column.
5. Select **OK**.

## Conserving Battery Pack Power

To extend the time that a battery pack can run the notebook from a single charge, use the following battery conservation settings and procedures.

## Conserving Power as You Work

To conserve power as you work:

- Prevent devices you are not using from drawing power from the notebook. For example:
  - ❑ Turn off wireless and local area network (LAN) connections and close modem applications.
  - ❑ Disconnect from the notebook any external devices that are not plugged into an external power source.
  - ❑ Stop or remove an inserted PC Card.
  - ❑ Disable or remove an inserted digital memory card.
  - ❑ Turn off a device connected to the S-Video-out jack.
- Use optional, externally powered speakers instead of the internal speakers whenever possible. When you use the internal speakers, minimize system volume. Volume can be adjusted with the volume buttons.
- Minimize screen brightness.
  - ❑ To decrease screen brightness, press the **fn+f7** hotkey.
  - ❑ To increase screen brightness, press the **fn+f8** hotkey.
- If you leave your work, initiate standby or hibernation, or shut down the notebook.

## Selecting Power Conservation Settings

To set the notebook to use less power:

- Select a short wait for the screen saver and select a screen saver with minimal graphics and motion. To select a screen saver and a screen saver wait time, select **Start > Control Panel > Appearance and Themes > Display > Screen Saver** tab, and then follow the instructions on the screen.
- Select or create a power scheme that minimizes power use. For more information about using power schemes, refer to the [“Using Power Schemes”](#) section earlier in this chapter.

## Replacing a Battery Pack



---

**CAUTION:** To prevent loss of work when removing a battery pack that is the only power source, shut down the notebook or initiate hibernation before removing the battery pack. (If you initiate hibernation, do not begin the following procedure until the power/standby lights are turned off, indicating that hibernation is complete.)

---

## Removing a Battery Pack

Although battery packs vary by model, the removal procedure is the same for all models.

To remove a battery pack:

1. Turn the notebook upside down.
2. Slide the battery release latch **1** to release the battery pack.
3. Pull the battery pack out of the battery bay **2**.

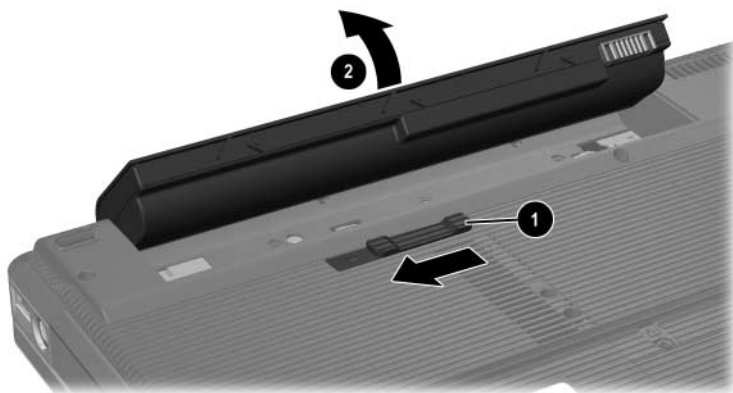

## Inserting a Battery Pack

Although battery packs vary by model, the insertion procedure is the same for all models.

To insert a battery pack:

1. Turn the notebook upside down on a flat surface.
2. Insert the battery pack into the battery bay **1** and rotate the battery pack **2** until it is seated.

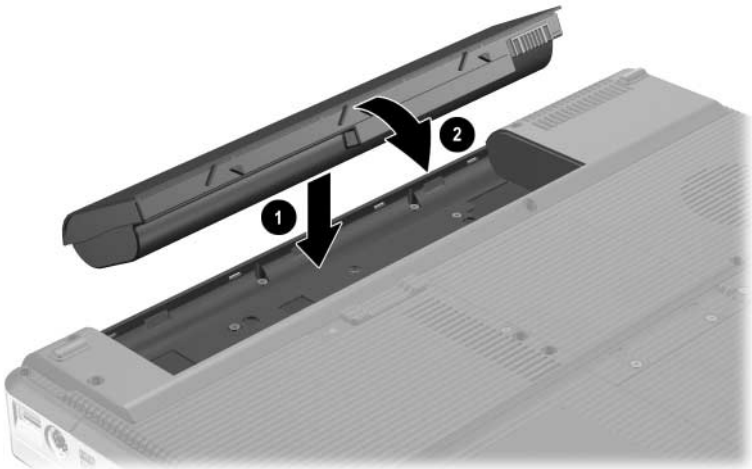

## Storing a Battery Pack



---

**CAUTION:** To prevent damage to a battery pack, do not expose it to high temperatures for extended periods of time.

---

If the notebook will be unused and disconnected from external power for more than 2 weeks, remove and store the battery pack.

High temperatures, which may be present in parked cars or some workplaces, accelerate the self-discharge rate of a stored battery pack. To prolong the charge of a stored battery pack, place it in a location that is cool and dry.

Calibrate a battery pack that has been stored for one month or more before using it.



## Disposing of a Used Battery Pack

---



**WARNING:** To reduce the risk of fire or burns, do not disassemble, crush, or puncture a battery pack; short the external contacts on a battery pack; or dispose of a battery pack in fire or water. Do not expose a battery pack to high temperatures above 60°C (140°F). Replace only with the HP battery pack approved for this computer.

---



When a battery pack has reached the end of its useful life, do not dispose of the battery pack in general household waste. Follow the local laws and regulations in your area for computer battery pack disposal.

In Europe, dispose of or recycle the battery packs by using the public collection system or by returning them to HP, a service partner, or their agents.

---

## Internal Speakers

The internal speakers, identified in the following illustration, play sound in stereo from applications, the operating system, games, drive media, the Internet, and other sources.

If an external device, such as headphones, is connected to the audio-out jack, the internal speakers are disabled.



## Volume Controls

You can adjust volume with the volume buttons on the notebook or the volume control software available in your operating system and in some multimedia applications. The volume mute button on the notebook overrides all software volume settings.

- To access the operating system volume controls, select **Start > Control Panel > Sounds, Speech, and Audio Devices > Sounds and Audio Devices**, and then select the **Volume** tab.
  - To access additional sound quality settings, such as balance, select the **Advanced** button in the Device volume pane.
  - To display a volume icon on your taskbar, select the check box for **Place volume icon in the taskbar**, and then select **OK**.
- To adjust volume using the notebook volume buttons:
  - To decrease volume, press the volume down button ❶.
  - To increase volume, press the volume up button ❷.
  - To mute or restore volume, press the volume mute button ❸.

When volume is muted, the mute light (on the volume mute button) is turned on. When volume is restored, the mute light is turned off.

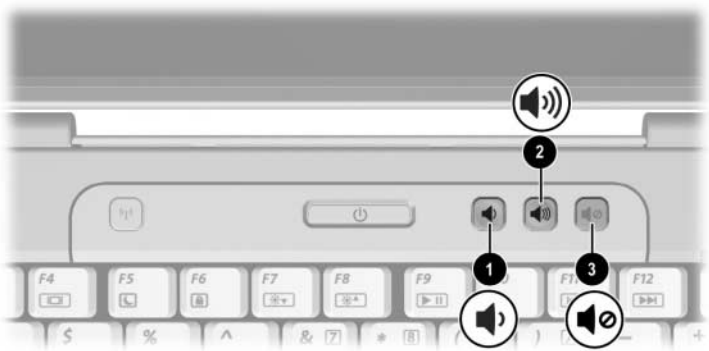

## External Audio Devices

### Using the Audio-Out (Headphone) Jack



**WARNING:** To reduce the risk of personal injury, adjust the volume before putting on headphones.



**CAUTION:** To prevent possible damage to an external device, do not plug a monaural (single sound channel) plug into the audio-out jack.

The audio-out jack, sometimes called a *headphone* jack, connects optional headphones or externally-powered stereo speakers. The audio-out jack, identified in the following illustration, is also used to connect the audio functions of an audio/video device such as a television or VCR.

When you connect a device to the audio-out jack, use only a 3.5-mm plug.

When a device is connected to the audio-out jack, the internal speakers are disabled.

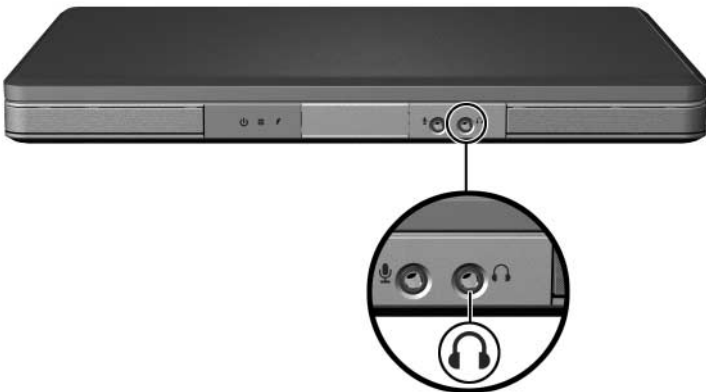

## Using the Audio-In (Microphone) Jack

The audio-in jack, identified in the following illustration, connects an optional monaural (single sound channel) microphone. The audio-in jack is sometimes called a *microphone* jack.

It is recommended that you use an electret condenser microphone with a 3.5-mm plug. If you connect a dynamic microphone, the recommended sensitivity may not be achieved.

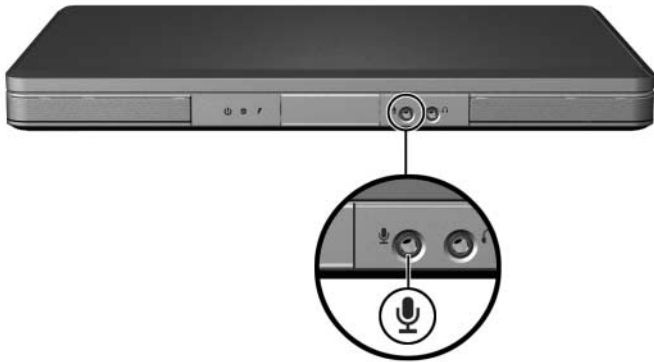

## External Video Devices

### Connecting an S-Video Device

#### Connecting the Audio

The S-Video-out jack, available only on select models, supports video signals only.

If you are setting up a configuration that combines audio and video functions, such as playing a DVD movie on your notebook and displaying it on your television, you need a standard 3.5-mm audio cable available from most computer or electronics retailers.

Plug the stereo end of the audio cable into the audio-out (headphone) jack on the notebook. Plug the other end of the cable into the audio-in jack on the external device. For more information about the notebook audio-out jack, refer to the [“Using the Audio-Out \(Headphone\) Jack”](#) section earlier in this chapter.



S/PDIF audio support is only available through an optional expansion product.

---

## Connecting the Video

To transmit video signals through the S-Video-out jack, you need a standard S-Video cable, available from most computer or electronics retailers.

Plug one end of the S-Video cable into the notebook S-Video-out jack, illustrated below. Plug the other end of the cable into the S-Video-in jack on the external device.

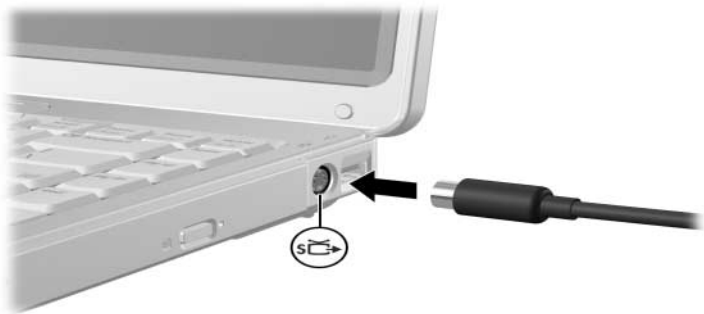

## Displaying a Video Image

To display an image on the notebook display or a video device display, both the notebook and the video device must be turned on.

- » To switch the image between the notebook display and the video device display, repeatedly press the **fn+f4** hotkey. Pressing the **fn+f4** hotkey switches the image among the notebook display, any connected displays, and simultaneous display.

For more information about **fn+f4** and other hotkeys, refer to the “Hotkeys” section in [Chapter 2, “Keyboard and Touchpad.”](#)

# CD and DVD Procedures

## Using Media Activity Hotkeys

Media activity hotkeys are preset combinations of the **fn** key ❶ and 4 of the function keys. You can use these hotkeys to control the play of an audio CD or a DVD that is inserted in the optical drive. You can also use an optional remote control that is included with some notebooks.

To control the play of an inserted video CD, use the media activity controls in your video CD player application.

- To play, pause, or resume an inserted audio CD or a DVD, press the **fn+f9** hotkey ❷.
- To stop an inserted audio CD or a DVD that is playing, press the **fn+f10** hotkey ❸.
- To play the previous track of an audio CD or the previous chapter of a DVD that is playing, press the **fn+f11** hotkey ❹.
- To play the next track of an audio CD or the next chapter of a DVD that is playing, press the **fn+f12** hotkey ❺.

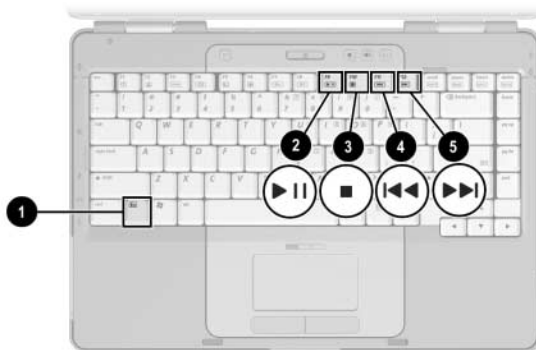

For more information about these and other hotkeys, refer to the “Hotkeys” section in [Chapter 2, “Keyboard and Touchpad.”](#)



## Protecting Playback

To prevent the loss of playback or playback quality:

- Save your work and close all open applications before playing a CD or a DVD.
- Dock or undock the notebook from an optional docking device *before* or *after* playing a disc, not *while* playing a disc.

To prevent the loss of playback while the notebook is in Windows, do not initiate standby or hibernation while playing a disc. If standby or hibernation is initiated while a disc is in use, you may see the warning message “Putting the computer into Hibernation or Standby might stop the playback. Do you want to continue?” If this message is displayed, select **No**. After you select No:

- Playback may resume.

– or –

- Playback may stop and the screen may clear. To return to your work, press the power button and then restart the disc.

## Protecting a CD or DVD Write Process



---

**CAUTION:** To prevent loss of work and damage to a disc:

- Before writing to a disc, connect the notebook to a reliable external power source. Do not write to a disc while the notebook is running on battery power.
  - Before writing to a disc, close all open applications (including screen savers and antivirus software) except the disc software you are using.
  - Do not copy directly from a source disc to a destination disc or from a network drive to a destination disc. Instead, copy from a source disc or network drive to your hard drive, and then copy from your hard drive to the destination disc.
  - Do not use the notebook keyboard or move the notebook while the notebook is writing to a disc. The write process is sensitive to vibration.
-

## Multimedia Software

The multimedia software included with your notebook is determined by your region and notebook model.

The following list describes the capabilities of some of the multimedia software that may be included with your notebook.

- Windows Media Player—Plays audio CDs and DVDs, and copies audio and data CDs. It also plays common audio and video file types, such as MP3, WMA, AVI, MPG, and WMV. This software is included with the Windows operating system.
- InterVideo WinDVD—Plays video CDs and DVD movies. This software is preinstalled on select notebooks. You can also obtain this software by any of the following methods:
  - Install WinDVD from the *Application and Driver Recovery* disc provided with most notebooks.
  - If you do not have the *Application and Driver Recovery* disc, contact Customer Care for a copy of the restore solution for your notebook.
  - Download the software from the technical support Web site at <http://www.compaq.com/consumersupport>.

- **InterVideo WinDVD Creator Plus**—Provides the ability to create, edit, and burn movies to a DVD or video CD. This software is located on the *InterVideo WinDVD Creator CD*, included with select notebooks.
- **Sonic RecordNow!**—Enables you to create copies of data and audio CDs and DVDs, and create personalized audio CDs and DVDs. RecordNow! is preinstalled on select notebooks.



For more information about using multimedia software, refer to the online Help for the software.

---

Your notebook may include additional multimedia software. Be sure to explore

- Your desktop icons.
- The software listed at **Start > All Programs**.
- The preloaded items that may be available at **Start > All Programs > Software Setup**.

## Observing the Copyright Warning

It is a criminal offense, under applicable copyright laws, to make unauthorized copies of copyright-protected material, including computer programs, films, broadcasts, and sound recordings. This notebook should not be used for such purposes.

## Installing Software

To install software from a CD that is included with the notebook:

1. Connect the notebook to a reliable AC outlet.
2. Close any open applications.
3. Insert the CD into the optical drive.
  - ❑ If autorun is enabled, an installation wizard is displayed.
  - ❑ If autorun is disabled:
    - a. Select **Start > Run**.
    - b. Enter `x:\setup.exe` (where *x* is your CD drive designation)
    - c. Select **OK**.
4. When the installation wizard is displayed, follow the installation instructions on the screen.
5. Restart the notebook if prompted.



Repeat the installation procedure for all software you want to install.

---



WinDVD Creator has special drive requirements for proper installation. To install WinDVD Creator, refer to the instructions provided with the *InterVideo WinDVD Creator* CD.

---

## Enabling AutoPlay

AutoPlay is an option in Windows that turns the Autorun feature on or off. Autorun starts a program or plays a title on a disc as soon the disc is inserted into the drive and the drive door is closed. By default, AutoPlay is enabled on the notebook.

To disable AutoPlay or to enable AutoPlay if the feature has been turned off, refer to your operating system documentation or visit the Microsoft Web site at <http://www.microsoft.com>.

## Changing DVD Region Settings



**CAUTION:** The region settings on your DVD drive can be changed only 5 times.

- The region setting you select the fifth time becomes the permanent region setting on the DVD drive.
- The number of allowable region changes remaining on the drive is displayed in the **Remaining Times Until Permanent** field in the WinDVD window. The number in the field includes the fifth and permanent change.

---

Most DVDs that contain copyrighted files also contain region codes. The region codes help protect copyrights internationally.

You can play a DVD containing a region code only if the region code on the DVD matches the region setting on your DVD drive.

If the region code on a DVD does not match the region setting on your drive, a “Playback Of Content From This Region Is Not Permitted” message is displayed when you insert the DVD. To play the DVD, you must change the region setting on your DVD drive. DVD region settings can be changed through the operating system or through some DVD players.

## Using the Operating System

To change settings through the operating system:

1. Open Device Manager by selecting **Start > My Computer**. Right-click in the window and select **Properties > Hardware tab > Device Manager**.
2. Select **DVD/CD-ROM drives**, right-click the DVD drive for which you want to change region settings, and then select **Properties**.
3. Make the desired changes on the DVD **Region** tab.
4. Select **OK**.

For additional information, refer to the Windows operating system Help and Support.

## Using WinDVD

To change the region settings on a drive using WinDVD:

1. Open WinDVD through one of the following methods:
  - Select the WinDVD Player icon on the notification area.
  - Select **Start > (All) Programs > InterVideo WinDVD > InterVideo WinDVD**.
2. Right-click the WinDVD player window.
3. Select **Setup**.
4. Select the button for the region.
5. Select **OK**.

## Using Other DVD Software

To change region settings on a drive using a DVD player other than WinDVD, refer to the documentation provided with the player.

---

## Wireless (Select Models Only)

### Wireless Features

If your notebook is equipped with an 802.11 wireless device and/or a Bluetooth wireless device, you have a wireless notebook.

- An 802.11 wireless notebook can connect to wireless local area networks (WLANs) in corporate offices, your home, and public places such as airports, restaurants, coffee shops, hotels, and universities. Hotspots are public places where you can access a wireless network. Contact your Internet service provider (ISP) or search the Web for a list of hotspots near you.
- A Bluetooth wireless notebook can connect to other Bluetooth wireless-enabled devices such as notebooks, phones, printers, headsets, speakers, and cameras.



## Wireless Controls

Your notebook has a wireless button that can enable and disable 802.11 and Bluetooth wireless devices and wireless lights to indicate the state of the wireless devices. By default, the 802.11 and Bluetooth wireless devices and wireless lights are turned on when you turn on the notebook.

The following illustration shows the wireless button ❶ and wireless light ❷.

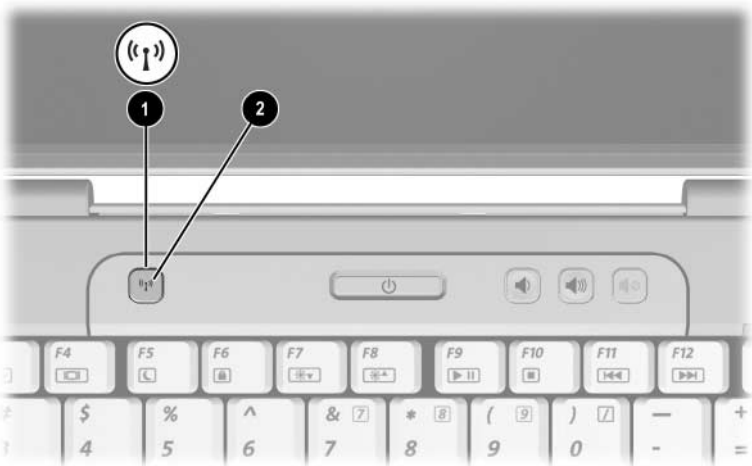

In addition to the wireless button and wireless lights, your wireless notebook may have the following software controls to turn on, turn off, enable, and disable your wireless devices:

Wireless Control	Description
Wireless Assistant utility (select models only)	Enables you to turn on and off 802.11 and Bluetooth wireless devices individually. For more information on using Wireless Assistant, refer to <a href="#">“Wireless Device Power States.”</a>
Wireless device controls in the Setup utility	Enable and disable 802.11 and Bluetooth wireless devices.

## 802.11 Wireless Devices (Select Models Only)

With an 802.11 wireless device, you can access a wireless local area network (commonly referred to as wireless network, wireless LAN, or WLAN), which is composed of other computers and accessories linked by a wireless router or a wireless access point.

- A large-scale WLAN, such as a corporate or public WLAN, typically uses wireless access points that can handle a large number of computers and accessories and can separate critical network functions.
- A home or small office WLAN typically uses a wireless router, which enables several wireless and wired computers to share an Internet connection, a printer, and files without additional pieces of hardware or software. The terms *wireless access point* and *wireless router* are often used interchangeably.

There are 3 popular implementations of 802.11 wireless devices:

- 802.11b
- 802.11b/g
- 802.11a/b/g

Computers with 802.11 wireless devices may support 1 or more of 3 industry standards:

- 802.11b, the first popular standard, supports data rates of up to 11 Mbps and operates at a frequency of 2.4 GHz.
- 802.11g supports data rates of up to 54 Mbps and operates at a frequency of 2.4 GHz. An 802.11g WLAN device is backward compatible with 802.11b devices, so they can operate on the same network.
- 802.11a supports data rates of up to 54 Mbps and operates at a frequency of 5 GHz. 802.11a is not compatible with 802.11b and 802.11g.

For information on identifying the type of wireless device in your computer, refer to [“Identifying an 802.11 Wireless Device.”](#)

## Setting Up a WLAN in Your Home

Microsoft Windows XP supports WLAN configuration with the Zero Client Configuration feature.

To set up a WLAN and connect to the Internet in your home, you need the following equipment:

- A broadband modem (either DSL or cable) ❶ and high-speed Internet service purchased from an Internet service provider (ISP).
- A wireless router (purchased separately) ❷.
- Your wireless notebook ❸, which varies in appearance by model.

The illustration below shows an example of a completed wireless network installation that is connected to the Internet.

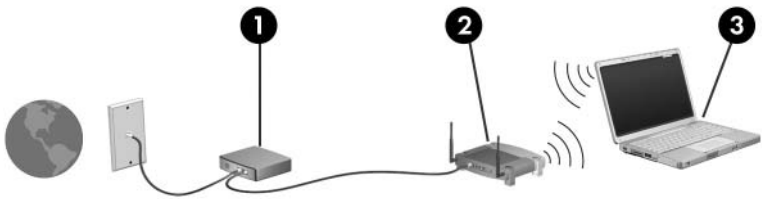

As your network grows, additional wireless and wired computers can be connected to the network to access the Internet.



If you need technical assistance to install your home WLAN, contact the router manufacturer or your ISP.

---

## Connecting to a WLAN in Your Home

To connect to a WLAN connection in your home:

- Verify that all drivers required by your 802.11 wireless device are installed and that the wireless device is correctly configured.
  -  If you are using an integrated 802.11 wireless device, all required drivers are installed and the device is preconfigured and ready to use.
- Verify that your 802.11 wireless device is turned on. When the wireless device is on, the wireless lights are turned on. If the wireless lights are off, turn on the wireless device. For information about turning on a wireless device, refer to [“Wireless Device Power States.”](#)
- Verify that your router is correctly installed and configured. For instructions, refer to your router documentation.
- Use the Wireless Network Connection feature of Microsoft Windows XP to connect your notebook to the WLAN. For additional information about this feature, select **Start > Help and Support**.



Functional range for subsequent WLAN connections will vary, depending on your computer WLAN implementation, router manufacturer, and interference from walls and other electronic devices.

---

For more information about connecting to a WLAN in your home:

- Refer to information from your ISP and the documentation included with your wireless router and other WLAN equipment.
- Access the information and Web site links provided at **Start > Help and Support**.

## Connecting to a Public WLAN

Contact your ISP or search the Web for a list of public WLANs near you. Web sites that list public WLANs include Cisco Hotspot Locator, Hotspotlist, and Geektools.

When you are within range of a public WLAN, a Wireless Network Connection interactive message is displayed at the bottom of your computer screen. Check with each public WLAN location for cost and connection requirements.

## Using Wireless Security Features

When you set up your home WLAN or access an existing public WLAN, always ensure that security features are protecting the WLAN. If you do not enable security on your WLAN, an unauthorized wireless user can access your data and use your Internet connection without your knowledge.

The most common security levels are Wi-Fi Protected Access (WPA)-Personal and Wired Equivalent Privacy (WEP). In addition to enabling WPA-Personal or WEP security encryption on the router, you may want to use one or more of the following security measures:

- Change the default network name (SSID) and password.
- Use a firewall.
- Set security on your Web browser.
- Enable MAC address filtering on the router.

## Identifying an 802.11 Wireless Device

You may need to know the name of the integrated 802.11 wireless device installed in your notebook. To identify an integrated 802.11 wireless device:

1. Display the names of the network devices on your notebook:
  - a. Select **Start > My Computer**.
  - b. Right-click in the My Computer window.
  - c. Select **Properties > Hardware tab > Device Manager > Network Adapters**.
2. Identify the 802.11 wireless device from the list that is displayed:
  - ❑ The listing for an 802.11 wireless device includes the term *wireless LAN*, *WLAN*, or *802.11*.
  - ❑ If no 802.11 wireless device is listed, either your notebook does not have an integrated 802.11 wireless device, or the driver for the 802.11 wireless device is not properly installed.

## Troubleshooting Devices

For more troubleshooting information, you can access the information at **Start > Help and Support**.

## Bluetooth Wireless Devices (Select Models Only)

A Bluetooth wireless device provides short-range wireless communications that replace the physical cable connections that traditionally link electronic devices such as

- Network access points.
- Computers (desktop, notebook, PDA).
- Phones (cellular, cordless, smart phone).
- Imaging devices (printer, camera).
- Audio devices (headset, speakers).

The devices are represented in the Bluetooth for Windows software by graphical icons that resemble the physical features of the devices.

The Bluetooth for Windows software provides the following functions:

- Personal Information Management (PIM) item transfer—Enables the exchange of information files such as business cards, calendar items, notes, and message items between Bluetooth computers or devices.
- PIM synchronization—Synchronizes PIM data between a Bluetooth wireless device and a notebook, PDA, or cell phone using Bluetooth.
- File Transfer—Enables the exchange of files between Bluetooth computers or devices.
- Network access (Personal Area Networking Profile)—Enables 2 or more Bluetooth devices to form an ad hoc (peer-to-peer) network. Provides a mechanism that enables a Bluetooth device to access a remote network through a network access point. The network access points can be traditional LAN data access points or group ad hoc networks that represent a set of devices that are attached only to one another.



- Dial-up networking—Connects Bluetooth devices to the Internet.
- Bluetooth serial port—Transfers data over the Bluetooth link using a virtual COM port.
- Hands-Free—Enables a vehicle-embedded, hands-free unit or a notebook serving as a hands-free unit to establish a wireless connection to a cellular phone and to act as the Bluetooth cellular phone audio input and output mechanism.
- Basic imaging—Provides a wireless connection between a Bluetooth-enabled camera and other Bluetooth devices. The camera can be controlled remotely by a notebook, and images can be transferred from a camera to be stored on a notebook or to be printed.
- Human interface device—Provides a wireless connection to other Bluetooth devices, such as keyboards, pointing devices, gaming devices, and remote monitoring devices.
- Fax—Provides a Bluetooth connection that enables a notebook to send or receive a fax message using a Bluetooth cellular phone or modem.
- Headset—Provides a wireless connection between a headset and a notebook or cellular phone. The headset acts as the device's audio input and output mechanism and increases mobility.

## Wireless Device Power States

The wireless button ❶ enables and disables 802.11 and Bluetooth wireless devices, in conjunction with the Wireless Assistant software utility. By default, any 802.11 or Bluetooth wireless device and the wireless light ❷ are turned on when you turn on the notebook.



Turning on a wireless device does not automatically connect your notebook to a WLAN. For information on setting up a WLAN, refer to [“802.11 Wireless Devices \(Select Models Only\).”](#)

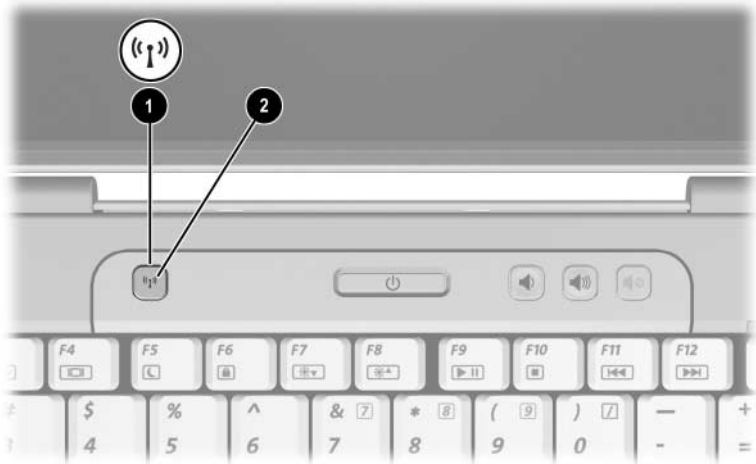

The 802.11 and Bluetooth wireless devices have 2 power states:

- Enabled
- Disabled

You can enable and disable the wireless devices with the wireless button. You can also enable and disable the wireless devices in the Setup utility.

---



You cannot use the wireless button or Wireless Assistant to control the wireless devices if they are disabled in the Setup utility.

---

When the wireless devices are enabled with the wireless button, you can use Wireless Assistant to turn the devices on or off individually. When the wireless devices are disabled, you must enable them before you can turn them on or off with Wireless Assistant.

To view the state of the wireless devices, place the pointer over the Wireless Assistant icon in the notification area, or open Wireless Assistant by double-clicking the icon in the notification area.

---



Wireless Assistant refers to an 802.11 wireless device as WLAN and Wireless LAN.

---

Wireless Assistant displays the status of the devices as on, off, or disabled.

For more information about Wireless Assistant:

1. Open Wireless Assistant by double-clicking the icon in the notification area.
  2. Select the **Help** button.
- 



You cannot use the wireless button or Wireless Assistant to control the wireless devices if they are disabled in the Setup utility.

---

## Turning On the Devices

If	And	Then
<ul style="list-style-type: none"> <li>■ Wireless Assistant shows that both WLAN (802.11) and Bluetooth are turned off</li> <li>■ Wireless light is off</li> </ul>	You want to turn on one or both devices	<ol style="list-style-type: none"> <li>1. Right-click the <b>Wireless Assistant</b> icon in the notification area.</li> <li>2. Select the device or devices you want to turn on.</li> </ol> <p> If the wireless devices are turned off, pressing the wireless button disables both devices. It does not turn on the devices.</p>
<ul style="list-style-type: none"> <li>■ Wireless Assistant shows that both WLAN and Bluetooth are disabled</li> <li>■ Wireless light is off</li> </ul>	You want to turn on one or both devices	<ol style="list-style-type: none"> <li>1. Press the wireless button. (The devices return to their previous on or off state.)*</li> <li>2. If the wireless devices are turned off, right-click the <b>Wireless Assistant</b> icon in the notification area.</li> <li>3. Select the device or devices you want to turn on.</li> </ol>
<ul style="list-style-type: none"> <li>■ Wireless Assistant shows that one device is turned on and the other device is turned off</li> <li>■ Wireless light is on</li> </ul>	You want to turn on the device that is off	<ol style="list-style-type: none"> <li>1. Right-click the <b>Wireless Assistant</b> icon in the notification area.</li> <li>2. Select the device you want to turn on.</li> </ol>

\*Pressing the button does not turn on both devices.



If you want your wireless devices to be turned on when you turn on your notebook, you must turn them on before you shut down or restart the notebook.

## Turning Off and Disabling the Devices

If	And	Then
■ Wireless Assistant shows that both WLAN and Bluetooth are turned on	You want to disable both devices	Press the wireless button.
	You want to turn off one or both devices	<ol style="list-style-type: none"><li>1. Right-click the <b>Wireless Assistant</b> icon in the notification area.</li><li>2. Select the device or devices you want to turn off.</li></ol>
■ Wireless light is on		
■ Wireless Assistant shows that both WLAN and Bluetooth are turned off	You want to disable both devices	Press the wireless button.
■ Wireless light is off		
■ Wireless Assistant shows that one device is turned on and the other device is turned off	You want to disable both devices	Press the wireless button.*
	You want to turn off the device that is on	<ol style="list-style-type: none"><li>1. Right-click the <b>Wireless Assistant</b> icon in the notification area.</li><li>2. Select the device you want to turn off.</li></ol>
■ Wireless light is on		

\*If the wireless devices are not both turned on when you disabled them, pressing the wireless button a second time returns the devices to their previous on or off state.

---

## Security Features

---



Security solutions are designed to act as deterrents. These deterrents may not prevent a product from being mishandled or stolen.

---

Security features provided with your notebook can protect the notebook, personal information, and data from a variety of risks. Depending on how and where you use your notebook, some security features may be unnecessary.

It is recommended that you follow the procedures described later in this guide for using

- Antivirus software
- Windows updates
- Firewall software

In addition to the Windows operating system security measures, the following table may help you decide which other security features to use. Most of these additional security features can be configured in the Setup utility.

To Protect Against	Use This Security Feature
Unauthorized use of the notebook	<ul style="list-style-type: none"> <li>■ QuickLock</li> <li>■ Power-on password in the Setup utility*</li> </ul>
Unauthorized access to the Setup utility ( <b>f10</b> )	Administrator password in the Setup utility*
Unauthorized startup from an optical or diskette drive	Device security feature in the Setup utility*
Computer viruses	Norton AntiVirus software
Unauthorized access to data	<ul style="list-style-type: none"> <li>■ Firewall software</li> <li>■ Windows updates</li> </ul>
Unauthorized access to the Setup utility BIOS settings and other system identification information	Administrator password in the Setup utility*
Unauthorized removal of the notebook	Security cable slot (used with an optional security cable) For additional information on the security cable slot, refer to <a href="#">“Optional Security Cable.”</a>

---

\*The Setup utility is a non-Windows utility accessed by pressing **f10** when the notebook is turned on or restarted. When using the Setup utility, you must use the keys on your notebook to navigate and make selections.

---

## QuickLock

QuickLock protects your notebook by displaying the Windows operating system Log On window. While the Log On window is displayed, the notebook cannot be accessed until a Windows user password or Windows administrator password is entered.

Before you can use the QuickLock feature, you must set a Windows user password or Windows administrator password. To set a Windows password, refer to the Help and Support Center by selecting **Start > Help and Support**.

Then

- To initiate QuickLock, press **fn+f6**.
- To exit QuickLock, enter your Windows user password or Windows administrator password.



## Setup Utility and Windows Passwords

Most security features use passwords. Whenever you set a password, write down the password and store it in a secure location away from the notebook.

Setup utility security features and Windows operating system security features function independently. For example, a device disabled in the Setup utility cannot be enabled in Windows. Note the following password considerations:

- *Setup utility passwords* are set in the Setup utility.
- *Windows passwords* are set in the Windows operating system.
- If you forget the power-on password and the administrator password set in the Setup utility, you cannot start up the notebook or restore from hibernation. Call Customer Care or your service partner for additional information.
- A Setup utility administrator password and a Windows administrator password have different functions. A Windows administrator password cannot be used to access the Setup utility, and a Setup utility administrator password cannot provide administrator-level access to your notebook contents.
- If you forget the administrator password set in the Setup utility, you will not be able to access the Setup utility.

The following table lists commonly used Setup utility and Windows passwords and describes their functions. For additional information about Windows passwords, such as screen-saver passwords, select **Start > Help and Support**.

<b>Setup Utility Passwords</b>	<b>Function</b>
Administrator password	Protects access to the Setup utility.
Power-on password	Protects access to the notebook contents when the notebook is turned on, restarted, or restored from hibernation.
<b>Windows Passwords</b>	<b>Function</b>
Administrator password*	Protects access to Windows administrator-level notebook contents.
User password*	Protects access to a Windows user account.
Standby password	Protects access to notebook contents when the notebook is resumed from standby or restored from hibernation.

\*For information about setting a Windows password, select **Start > Help and Support**.

## Coordinating Passwords

A Setup administrator password and a Windows administrator password have different functions. A Windows administrator password cannot be used to access Setup, and a Setup administrator password cannot provide administrator-level access to your notebook contents.

Setup utility and Windows passwords function independently. You must use a Setup utility password at a Setup utility password prompt and a Windows password at a Windows password prompt. For example:

- If a Setup utility power-on password is set, the power-on password (not a Windows password) must be entered when the notebook is turned on, restarted, or restored from hibernation.
- If a Windows standby password is set, the Windows standby password (not a Setup utility power-on password) must be entered when the notebook is resumed from standby or restored from hibernation.

## Choosing a Password

The same password used for a Setup utility password can be used for another Setup utility password or for a Windows password, with the following considerations:

- A Setup utility password can be any combination of up to 8 letters and numbers and is not case sensitive.
- A Setup utility password must be set and entered with the same keys. For example, a Setup utility password set with keyboard number keys will not be recognized if it is thereafter entered with embedded numeric keypad number keys.

## Setup Utility Administrator Password

The Setup utility administrator password protects the configuration settings and system identification information in the Setup utility. After this password is set, it must be entered to access the Setup utility.

The administrator password

- Is not interchangeable with a Windows administrator password, although both passwords can be identical.
- Does not display as it is set, entered, changed, or deleted.
- Must be set and entered with the same keys. For example, an administrator password set with keyboard number keys will not be recognized if you enter it thereafter with embedded numeric keypad number keys.
- Can include any combination of up to 8 letters and numbers and is not case sensitive.

## Setting an Administrator Password

An administrator password is set, changed, or deleted in the Setup utility.

To manage this password:

1. Open the Setup utility by turning on or restarting the notebook, and then pressing **f10** while the Setup message is displayed in the lower-left corner of the screen.
2. Use the arrow keys to select **Security > Administrator Password**, and then press **enter**.
  - ❑ To set an administrator password, type your password in the **Enter New Password** and **Confirm New Password** fields, and then press **enter**.
  - ❑ To change an administrator password, type your current password in the **Enter Current Password** field, type the new password in the **Enter New Password** and **Confirm New Password** fields, and then press **enter**.
  - ❑ To delete an administrator password, type your current password in the **Enter Password** field, and press **enter** 4 times.
3. To save your preferences and exit the Setup utility, press **f10** and follow the instructions on the screen.

Your preferences are in effect when the notebook restarts.

## Entering an Administrator Password

At the **Enter Password** prompt, type your administrator password (using the same kind of keys you used to set the password), and then press **enter**. After 3 unsuccessful attempts to enter the administrator password, you must restart the notebook and try again.

## Setup Utility Power-On Password

The Setup utility power-on password prevents unauthorized use of the notebook. After this password is set, it must be entered each time the notebook is turned on, restarted, or restored from hibernation. A power-on password

- Does not display as it is set, entered, changed, or deleted.
- Must be set and entered with the same keys. For example, a power-on password set with keyboard number keys will not be recognized if you enter it thereafter with embedded numeric keypad number keys.
- Can include any combination of up to 8 letters and numbers and is not case sensitive.

## Setting a Power-On Password

A power-on password is set, changed, or deleted in the Setup utility.

To manage the password:

1. Open the Setup utility by turning on or restarting the notebook, and then pressing **f10** while the Setup message is displayed in the lower-left corner of the screen.
2. Use the arrow keys to select **Security > Power-On password**, and then press **enter**.
  - ❑ To set a power-on password, type the password in the **Enter New Password** and **Confirm New Password** fields, and then press **enter**.
  - ❑ To change a power-on password, type the current password in the **Enter Current Password** field, type the new password in the **Enter New Password** and **Confirm New Password** fields, and then press **enter**.
  - ❑ To delete a power-on password, type the current password in the **Enter Current Password** field, and then press **enter** 4 times.
3. To save your preferences and exit the Setup utility, press **f10**, and then follow the instructions on the screen.

Your preferences are in effect when the notebook restarts.

## Entering a Power-On Password

At the **Enter Password** prompt, type your password (using the same kind of keys you used to set the password), and then press **enter**. After 3 unsuccessful attempts to enter the password, you must restart the notebook and try again.

## Setup Utility Device Security

From the Device Security menu in the Setup utility, you can disable the ability of the notebook to start from an optical drive or a diskette drive.

To disable or reenble notebook capabilities in the Setup utility:

1. Open the Setup utility by turning on or restarting the notebook, and then pressing **f10** while the Setup message is displayed in the lower-left corner of the screen.
2. Select **Security > Device Security**, and then press **enter**.
3. Use the arrow keys to select an item. Then:
  - ❑ To disable an item, press **f5** or **f6** to toggle the field for the item to **Disable**, and then press **enter**.
  - ❑ To reenble an item, press **f5** or **f6** to toggle the field for the item to **Enable**, and then press **enter**.
4. When a confirmation prompt with your preference selected is displayed, press **enter**.
5. To save your preferences and exit the Setup utility, press **f10**, and then follow the instructions on the screen.

Your preferences are in effect when the notebook restarts.



## Antivirus Software

When you use the notebook for e-mail, network, or Internet access, you expose the notebook to computer viruses. Computer viruses can disable your operating system, applications, or utilities or cause them to function abnormally. Antivirus software can detect most viruses, destroy them, and in most cases, repair damage they have caused.

To protect your notebook against viruses, it is recommended that you use antivirus software. To provide protection against newly discovered viruses, the antivirus software must be updated.

Norton AntiVirus is preinstalled on the notebook. For more information about using and updating the Norton AntiVirus software:

- » Select **Start > All Programs > Norton AntiVirus > Help and Support**.

For more information about computer viruses:

1. Select **Start > Help and Support**.
2. Type viruses into the **Search** field.
3. Press **enter**.

# Critical Security Updates for Windows XP

---



**CAUTION:** To protect your notebook from security breaches and computer viruses, it is recommended that you install every critical update from Microsoft as soon as you receive an alert. You should also run Windows Update on a monthly basis to install the latest recommended updates from Microsoft.

---

A *Critical Security Updates for Windows XP* disc may have been included with your notebook to provide additional updates delivered after the notebook was configured.

To update your system using the *Critical Security Updates for Windows XP* disc:

1. Insert the disc into the drive. The disc automatically runs the installation application.
2. Follow the on-screen instructions to install all updates. This could take several minutes.
3. Remove the disc.

Additional updates to your operating system and other software included on your notebook may have become available after your notebook was shipped. To be certain that all available updates are installed on your notebook, use the update link at **Start > Help and Support**.

Updates to Windows and Microsoft applications are released periodically. You can obtain future updates from the Microsoft Web site as well as through the update link in the Help and Support Center.

## Firewall Software

When you use the notebook for e-mail, network, or Internet access, it is possible for unauthorized persons to obtain information about you, your notebook, and your data. To protect your privacy, it is recommended that you use firewall software.

Firewalls monitor all incoming and outgoing traffic on your notebook by including features such as logging and reporting, automatic alarms, and user interfaces for configuring the firewall.

Your notebook comes with preinstalled firewall software. Refer to the firewall documentation or contact the firewall manufacturer.



Under some circumstances a firewall can block access to Internet games, interfere with printer or file sharing on a network, or block authorized e-mail attachments. To temporarily solve the problem, disable the firewall, perform the task that you want to perform, and then reenable the firewall. To permanently resolve the problem, reconfigure the firewall.

---

## Optional Security Cable



Security solutions are designed to act as deterrents. These deterrents may not prevent a product from being mishandled or stolen.

To install a security cable:

1. Loop the security cable around a secured object.
2. Insert the key ❶ into the cable lock ❷.
3. Insert the cable lock into the security cable slot ❸, and then lock the cable lock with the key.

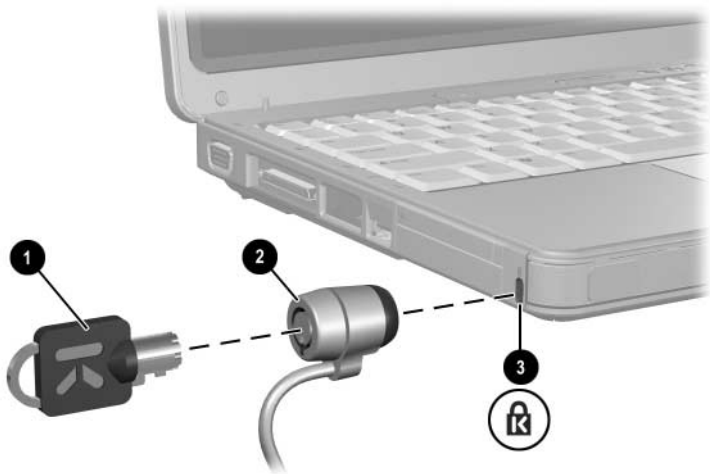

---

# Hardware Upgrades and Replacements

## Device Connections

### Connecting a Powered Device

To connect the notebook to an optional external device that has a power cord:

1. Be sure the device is turned off.
2. Connect the device to the jack or jack on the notebook specified by the device manufacturer.
3. Plug the device power cord into a grounded AC outlet.
4. Turn on the device.



If a properly connected monitor or other display device does not display an image, try pressing the **fn+f4** hotkey to switch the image to the new device.

---

To disconnect a powered external device from the notebook:

1. Turn off the device.
2. Disconnect the device from the notebook.

## Connecting a USB Device

USB (Universal Serial Bus) is a hardware interface that can be used to connect an external device such as a USB keyboard, mouse, drive, printer, scanner, or hub to the notebook or an optional docking device.

A hub is a connecting device that can be either powered or unpowered. USB hubs can be connected to a USB port on the notebook or to other USB hubs. Hubs support varying numbers of USB devices and are used to increase the number of USB devices in the system.

- Powered hubs must be connected to external power.
- Unpowered hubs must be connected either to a USB port on the notebook or to a port on a powered hub.

The 3 USB ports on the notebook support USB 2.0-compliant, USB 1.1-compliant, and USB 1.0-compliant devices.

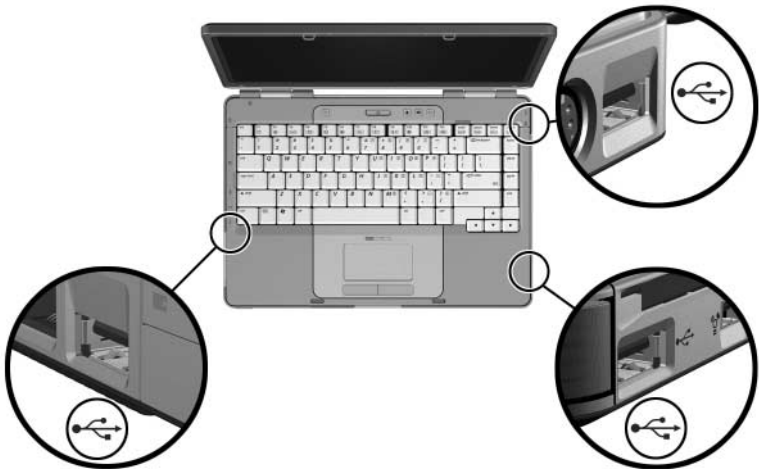

## Connecting a 1394 Device

IEEE 1394 is a hardware interface that can be used to connect a high-speed multimedia or data storage device to the notebook. Scanners, digital cameras, and digital camcorders often require a 1394 connection.

You may have to load device-specific drivers and other software before using some 1394 devices. For information about device-specific software, refer to the device documentation or to the Web site of the device manufacturer or provider.

The notebook 1394 port, illustrated below, supports IEEE 1394a devices.

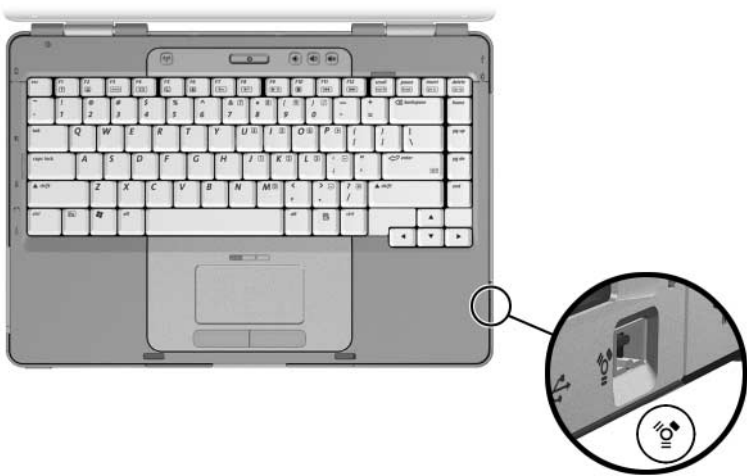

## Connecting a Communication Device

For information about using an optional wireless device, refer to [Chapter 5, “Wireless \(Select Models Only\).”](#)

For information about using the Network Service Boot to connect the notebook to a PXE (Preboot Execution Environment) server during startup, refer to the [“Using Advanced Setup Utility Features”](#) section in [Chapter 8, “Software Updates and Recovery and System Software.”](#)

For more information about modem, wireless, and network connections, select **Start > Help and Support**. The Help and Support utility provides communication information that includes instructions, tutorials, and wizards that can help you set up or troubleshoot a variety of connections.



## Digital Memory Cards

The Memory Reader in the notebook can support:

- Memory Stick and Memory Stick Pro
- xD-Picture Card (XD)
- MultiMediaCard
- SmartMedia (SM) card
- Secure Digital (SD) Memory Card

Digital memory cards are often used for digital storage on cameras, camcorders, and other handheld devices.

You can set the notebook to open the files on a digital memory card in ways you specify. For example, you could set a digital memory card to open with a slide show of the photographs it contains. For instructions, refer to the [“Protecting Playback”](#) section in [Chapter 4, “Multimedia.”](#)

The Memory Reader light and the Memory Reader described in the following sections are available only on models which include a Memory Reader.

## Using the Memory Reader Light

The Memory Reader light is turned on when an inserted digital memory card is being accessed. The Memory Reader light is turned off when an inserted digital memory card is inactive or when the Memory Reader is vacant.



## Inserting a Digital Memory Card



**CAUTION:** To prevent damage to digital memory card connectors:

- Use minimal force when inserting a digital memory card into the Memory Reader.
- Do not move or transport the notebook while a digital memory card is inserted in the Memory Reader.

---

To insert a digital memory card:

1. Hold the card label-side up with the connectors facing the notebook.
2. Gently slide the card into the Memory Reader until the card is seated. (The card will extend outward slightly beyond the notebook.)

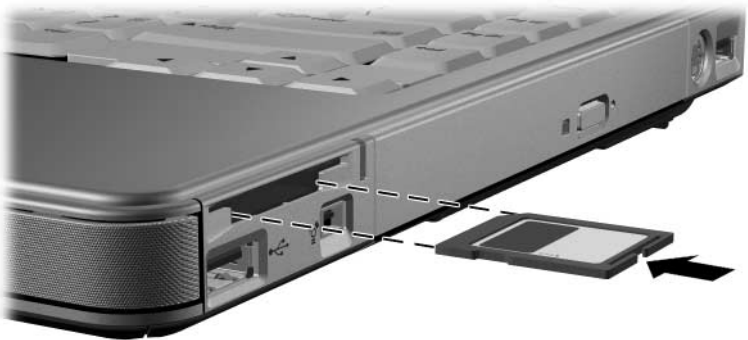

## Removing a Digital Memory Card

To remove a digital memory card:

1. Close all applications and complete all activities that are using the card. (To stop a data transfer, select the **cancel** button in the Windows Copying window.)
2. Select the **My Computer** icon on the Windows Desktop.
3. Right-click the drive assigned to the card, and then select **Eject**. (The card is stopped but is not released from the Memory Reader.)
4. Slide the card out of the slot.



## PC Cards

A PC Card is a credit card–sized accessory designed to conform to the standard specifications of the Personal Computer Memory Card International Association (PCMCIA). PC Cards can be used to add modem, sound, storage, wireless communication, or digital camera functions to the notebook.

The notebook PC Card slot supports one Type I or Type II 32-bit (CardBus) or 16-bit PC Card.



**CAUTION:** To preserve support for all PC Cards, do not install all of the software or any of the enablers provided by a single PC Card manufacturer. If you are instructed by the documentation included with a PC Card to install device drivers:

- Install only the device drivers for your operating system.
  - Do not install other software, such as card services, socket services, or enablers, that may also be supplied by the PC Card manufacturer.
-

## Inserting a PC Card



**CAUTION:** To prevent damage to the PC Card connectors:

- Use minimal force when inserting a PC Card into a PC Card slot.
- Do not move or transport the notebook while a PC Card is inserted.

1. Hold the PC Card label-side up with the connectors facing the notebook.
2. Gently slide the card into the slot until the card is seated.

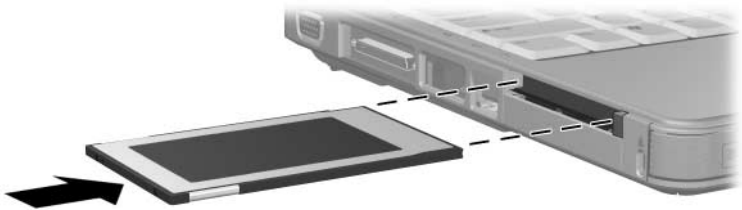

## Stopping or Removing a PC Card



**CAUTION:** To prevent loss of work or an unresponsive system, stop a PC Card before removing it.

---



Stopping a PC Card, even if it is not in use, conserves power.

---

To stop or remove a PC Card:

1. Close all applications and complete all activities that are supported by the PC Card. Then

- To stop the PC Card:

Select the **Safely Remove Hardware** icon on the taskbar, and then select the PC Card. (To display the Safely Remove Hardware icon, right-click the taskbar, select **Properties**, clear the Hide inactive icons check box, and then select **OK**.)

- To remove the PC Card, stop the PC Card as described above, and then proceed to step 2.

2. Press the PC Card eject button **1**. (You may need to press the button once to extend the button, and then press the button again to release the PC Card.)
3. Gently slide out the PC Card **2**.

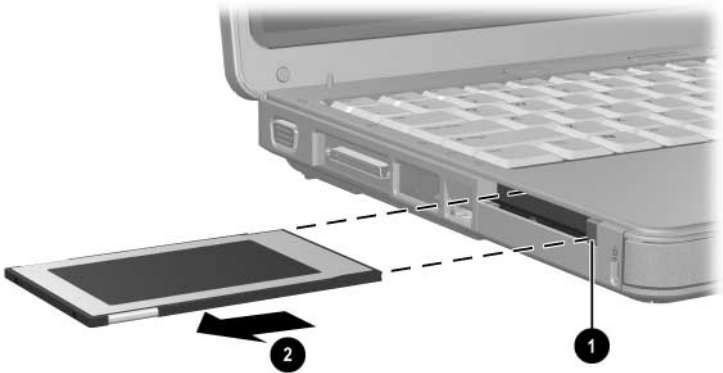



## Drives

### Adding a Drive to the System

The internal hard drive and optical drive are standard features of the notebook. The type of optical drive varies by notebook model.

An optional drive can be added to the system by connecting it, as instructed in the drive documentation, to one of the USB ports or to the 1394 port. Hard drive capacity can also be added with a microdrive PC Card or a digital memory card such as a Secure Digital (SD) Memory Card.

### Using the IDE Drive Light

Internal hard drive or optical drive activity is indicated by the IDE (Integrated Drive Electronics) drive light.

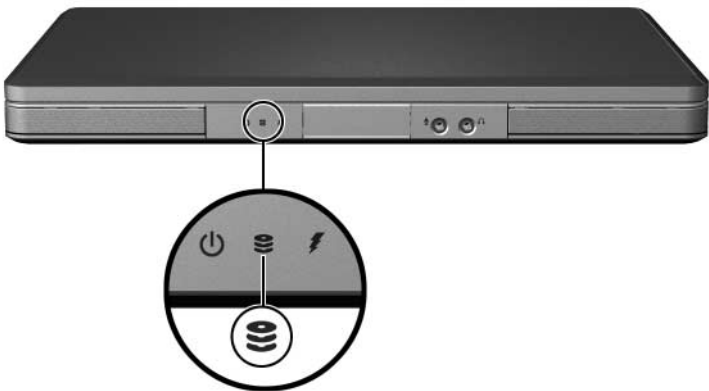

## Caring for Drives

---



**CAUTION:** To prevent damage to the notebook or a drive and loss of work:

- Do not remove the internal hard drive except for repair or replacement. For instructions, refer to the [“Replacing the Internal Hard Drive”](#) section next in this chapter.
  - Electrostatic discharge can damage electronic components. To prevent electrostatic damage to the notebook or a drive, follow these 2 precautions: (1) Discharge yourself from static electricity before handling a drive by touching a grounded metal object and (2) Avoid touching the connectors on a drive. For more information about preventing electrostatic damage, refer to the “Electrostatic Discharge” chapter in *Regulatory and Safety Notices* guide.
  - Excessive force can damage drive connectors. When you insert a drive, use only enough force to seat the drive.
  - Handle a drive carefully. Do not drop it.
  - Avoid exposing a hard drive or a diskette to devices with magnetic fields. Products with magnetic fields include video and audio tape erasure products, monitors, and speakers. Security devices with magnetic fields include airport walk-through devices and security wands. The airport security devices that check carry-on luggage, usually while it is placed on a conveyor belt, use x-rays instead of magnetism and will not damage a hard drive or a diskette.
  - Do not spray a drive with cleaning products.
  - Avoid exposing a drive to liquids or temperature extremes.
  - If you mail a drive, ship it in packaging that protects it from shock, vibration, extreme temperatures, and high humidity. Label the package “FRAGILE.”
-

## Replacing the Internal Hard Drive

The hard drive in the hard drive bay is the internal hard drive. Remove the internal hard drive only for repair or replacement.



**CAUTION:** To prevent an unresponsive system and loss of work, do not begin this procedure until you

- Save your work, close all open applications, and shut down the notebook. If you are unsure whether the notebook is off or in hibernation, turn the notebook on and then shut it down through the operating system.
- Disconnect all external devices connected to the notebook.
- Disconnect the notebook from external power and remove the battery pack.

---

For battery pack removal instructions, refer to the [“Replacing a Battery Pack”](#) section in [Chapter 3, “Power.”](#)

To replace the internal hard drive:

1. Turn the notebook upside down.
2. Loosen the 2 hard drive security screws.

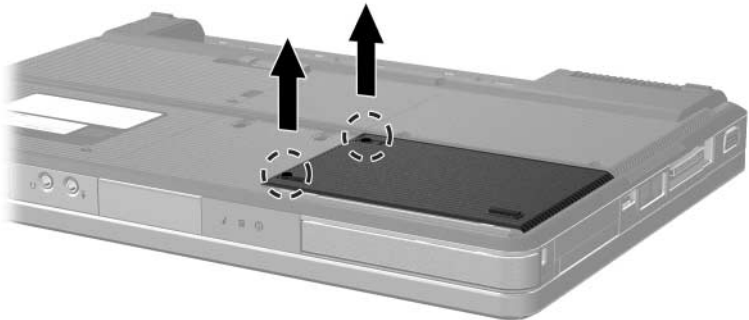

3. To remove the hard drive cover and expose the hard drive tab **1**, slide the cover **2** slightly toward the left and then lift the cover upward and away from the notebook.

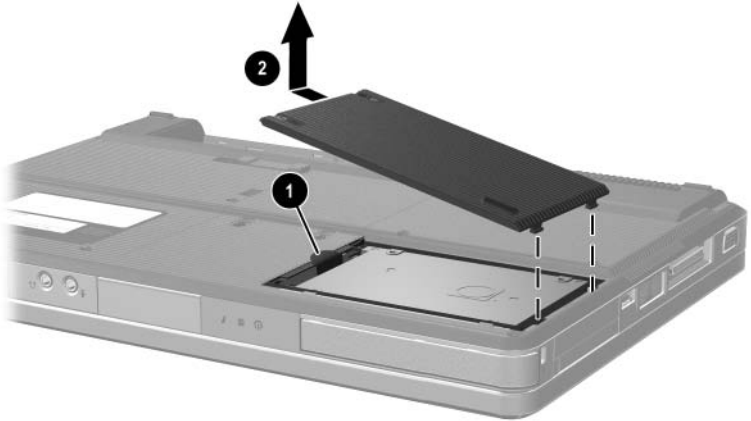

4. To remove the hard drive, pull upward on the hard drive tab **1** to release the hard drive, and then lift the hard drive **2** out of the hard drive bay.

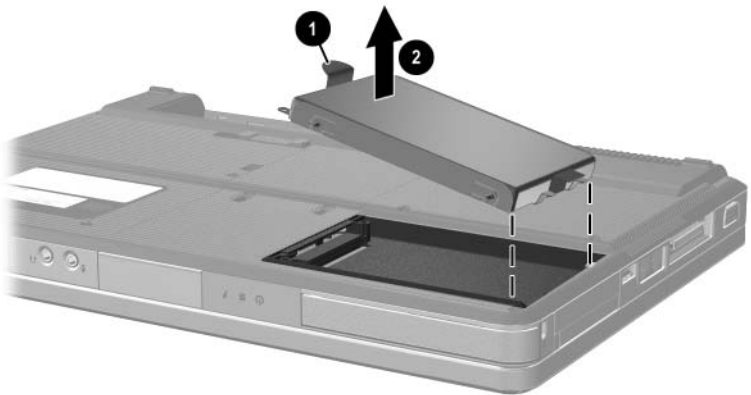

5. To insert the replacement hard drive, tilt the connector edge of the hard drive ❶ downward, and then lower the hard drive into the hard drive bay until it is seated ❷.

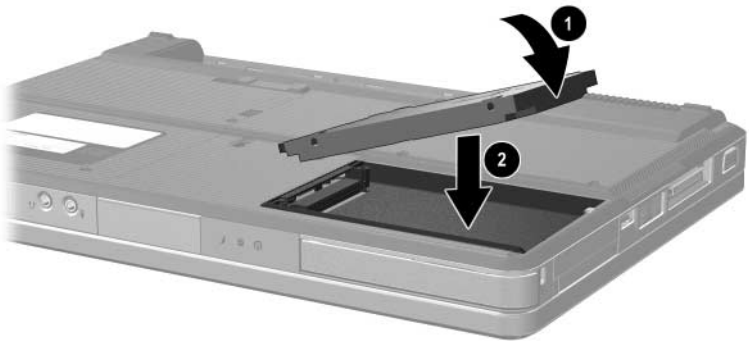

6. Replace the hard drive cover.
  - a. Place the cover ❶ over the hard drive bay.
  - b. Slide the cover slightly toward the right side of the notebook until the cover is seated ❷.

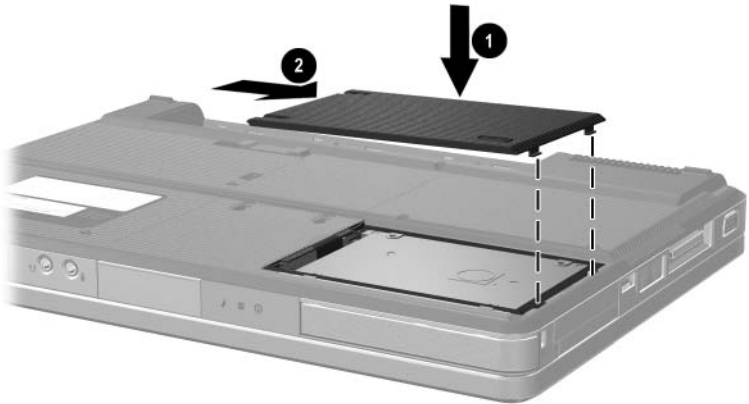

7. Tighten the 2 hard drive security screws.

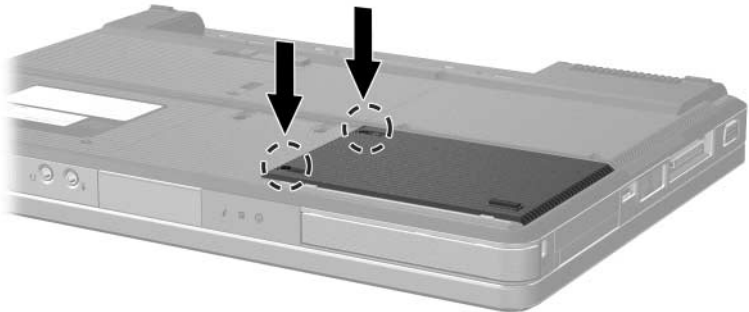

## Memory

The notebook has 2 memory slots. Depending on your notebook model, either one or both memory slots may contain a replaceable memory module.

## Increasing Memory

You can increase the amount of RAM (random access memory) in the notebook by adding memory modules to vacant memory slots or by replacing installed memory modules.

When RAM is increased, the operating system increases the hard drive space reserved for the hibernation file. Before you increase RAM, it is recommended that you verify that your hard drive has enough free space for the larger hibernation file.

- To display the amount of RAM in the system:

Select **Start > Help and Support**.

- To display both the amount of free space on your hard drive and the amount of space required by the hibernation file:

Select **Start > Control Panel > Performance and Maintenance > Power Options > Hibernate** tab.

## Removing or Inserting a Memory Module

---



**WARNING:** To prevent exposure to electrical shock, access only the memory compartment during this procedure. The memory compartment, the battery bay, and the hard drive bay are the only user-accessible internal compartments on the notebook. All other areas that require a tool to access should be opened only by a service partner.

---



**WARNING:** To prevent exposure to electrical shock and damage to the notebook, shut down the notebook, unplug the power cord, and remove the battery pack before installing a memory module.

---



**CAUTION:** To prevent electrostatic discharge from damaging electronic components: before beginning this procedure, discharge yourself of static electricity by touching a grounded metal object. For more information about preventing electrostatic damage, refer to the “Electrostatic Discharge” chapter in *Regulatory and Safety Notices* guide.

---

1. Save your work and close all open applications.
2. Shut down the notebook.  
If you are unsure whether the notebook is off or in hibernation, turn the notebook on, and then shut it down through the operating system.
3. Disconnect all external devices connected to the notebook.
4. Disconnect the notebook from external power.
5. Remove the battery pack.

For instructions, refer to the [“Replacing a Battery Pack”](#) section in [Chapter 3, “Power.”](#)



6. Turn the notebook upside down.
7. Loosen the 2 memory compartment screws **1**, and then lift up and remove the memory compartment cover **2**.

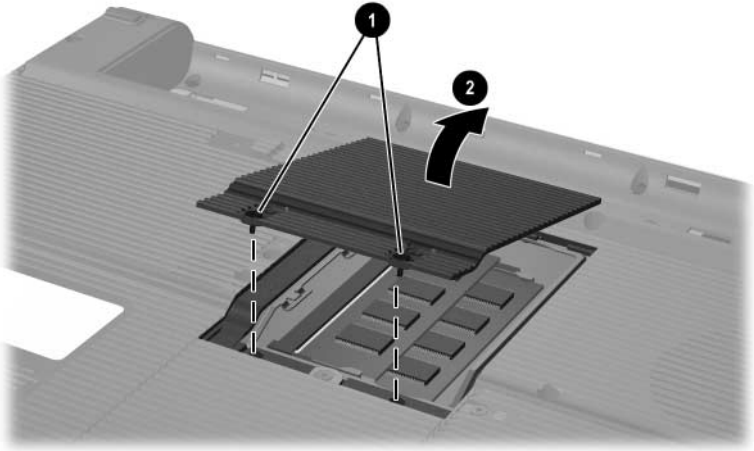

8. Remove or insert the memory module.

To remove a memory module:

- a. Pull away the retention clips on each side of the module ❶. (The module tilts upward.)
- b. Grasp the edges of the module and gently pull the module out of the memory slot ❷.
- c. To protect a memory module after removal, place it in an electrostatic-safe container.

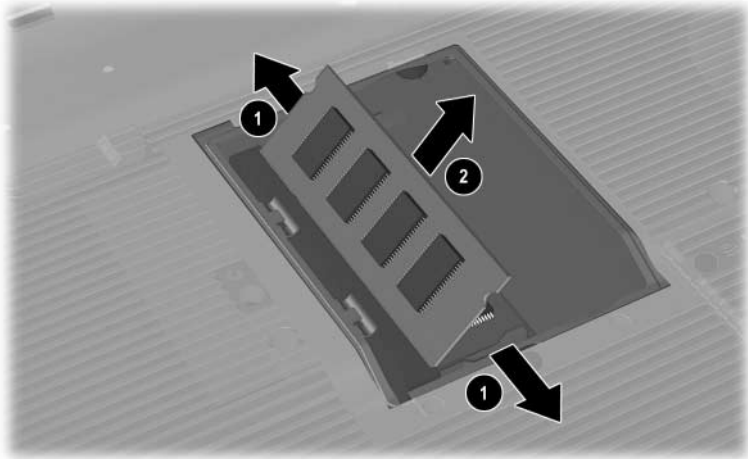

To insert a memory module:

- a. Align the keyed (notched) edge of the module with the keyed area in the memory slot **1**.

If you are inserting a single memory module into a vacant memory compartment, insert the module into the lower slot. (The illustration below shows a memory module being inserted into the second slot of a memory compartment that already contains a memory module.)

- b. With the module at a 45-degree angle from the surface of the memory compartment, press the module into the memory slot until it is seated **2**.
- c. Push the module downward until the retention clips snap into place **3**.

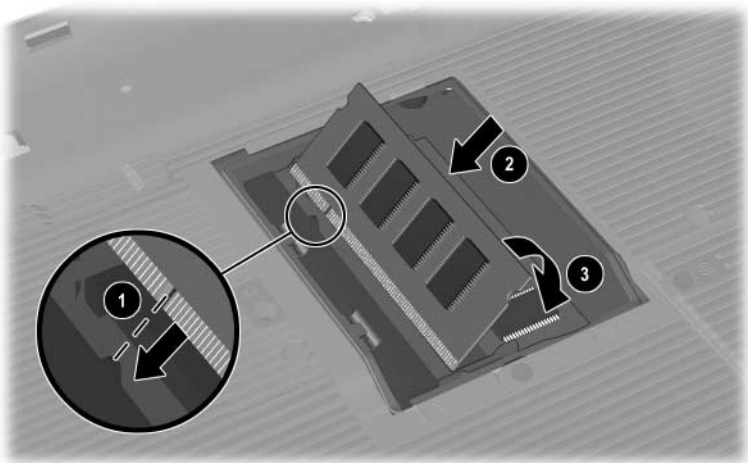

9. To close the memory compartment, align the tabs on the memory compartment cover with the cover slots on the notebook, and then slide the cover over the memory compartment until it is seated **1**.
10. Tighten the 2 memory compartment screws **2**.

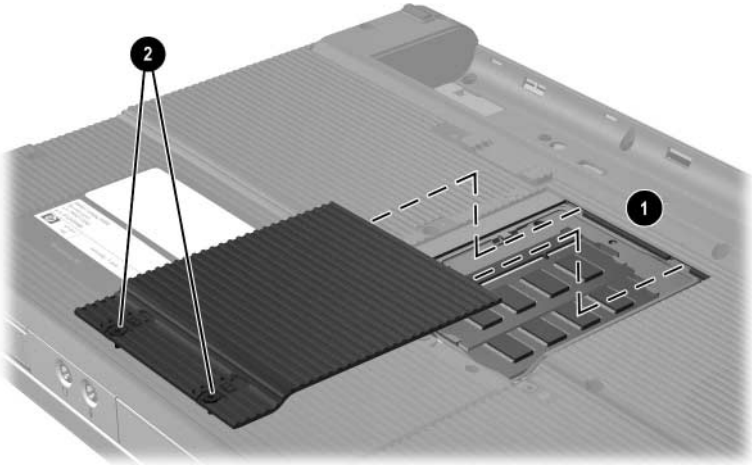

11. Replace the battery pack, reconnect the notebook to external power, and then restart the notebook.

---

# Software Updates and Recovery and System Software

## Software Updates

For optimal notebook performance and to make sure your notebook remains compatible with changing technologies, install the latest versions of the software provided with your notebook as they become available.

As with any other software modification, it is strongly recommended that you set a restore point before beginning a software update. For instructions, refer to “[Using System Restore](#)” later in this chapter.

You may find that the easiest way to update the software provided with your notebook is to use the software update links provided at **Start > Help and Support**.

If you prefer to work from more detailed instructions, the supplementary information in the following sections may help you to

- Prepare for any update by identifying your notebook category, product name, product number, and serial number.
- Prepare for a ROM (read-only memory) update by identifying the ROM version currently installed on the notebook.
- Access updates at the <http://www.compaq.com/consumersupport> Web site.
- Download and install updates.

## Preparing for a Software Update

If your notebook connects to a network, consult with your network administrator before installing any software updates, particularly a ROM update.

## Accessing Notebook Product Information

To access the updates for your notebook, you may need the following information:

- The product category is Notebook.
- The product name, product number (P/N), and serial number (S/N) are provided on the Service Tag. The information on the Service Tag is provided at **Start > Help and Support**, and on the Service Tag label affixed to the bottom of the notebook.

## Accessing Notebook ROM Information

To determine whether an available ROM update is a later ROM version than the ROM version currently installed on the notebook, you need to know the version of the currently installed ROM.

- » To display ROM information from within Windows, press the **fn+esc** hotkey. In the **fn+esc** display, the version of the system ROM is displayed as the BIOS (basic input-output system) date. On some notebook models, the BIOS date is displayed in decimal format. To clear the display, press **esc**.

ROM information can also be displayed in the Setup utility. The procedure for displaying ROM information is described in this section. For more information about using the Setup utility, refer to the “[Setup Utility](#)” section later in this chapter.

To display ROM information in the Setup utility:

1. To open the Setup utility, turn on or restart the notebook in Windows, and then press **f10** while the prompt “Press <F10> to enter setup” is displayed in the lower-left corner of the screen.
2. If the Setup utility does not open with system information displayed, use the arrow keys to select the **Main** menu. (When the Main menu is selected, ROM and other system information is displayed.)
3. To close the Setup utility without changing any settings, use the arrow keys to select the **Exit** menu > **Exit Discarding Changes**, and then press **enter**. (The notebook restarts in Windows.)

## Downloading and Installing an Update

Most software at the <http://www.compaq.com/consumersupport> Web site (English only) is packaged in compressed files called *SoftPaqs*. Some ROM updates may be packaged in compressed files called *ROMPaqs*. Other ROM updates may be provided in compressed files called *CPQFlash SoftPaqs*.

Most download packages contain a file named *Readme.txt*. A *Readme.txt* file contains detailed descriptive, installation, and troubleshooting information about the download. The *Readme.txt* files included with *ROMPaqs* are in English only.

The following sections provide instructions for downloading and installing

- A ROM update.
- A *SoftPaq* containing an update other than a ROM update; for example, an application update.



## Downloading and Installing a ROM Update



**CAUTION:** To prevent serious damage to the notebook or an unsuccessful installation, download and install a ROM update only while the notebook is connected to reliable external power using the AC adapter. (Do not download or install a ROM update while the notebook is docked in an optional docking device or running on battery power.) During the download and installation:

- Do not unplug the notebook from the AC outlet.
- Do not shut down the notebook or initiate standby or hibernation.
- Do not insert, remove, connect, or disconnect any device, cable, or cord.

---

### Downloading a ROM Update

1. Access the page at the <http://www.compaq.com/consumersupport> Web site that provides software for your notebook.
2. Select **Start > Help and Support**, and then select a software update link.
3. Follow the instructions on the screen to identify your notebook and access the ROM update you want to download.
4. At the download area:
  - a. Record the date, name, or other identifier of any ROM update that is later than the ROM currently installed on your notebook. (You may need this information to locate the update later, after it has been downloaded to the hard drive.)
  - b. Record the path to the default or custom location on the hard drive to which the ROM package will download. (You may need to access the ROM package after it has been downloaded.)
  - c. Follow the online instructions to download your selection to the hard drive.

## Installing a ROM Update

ROM installation procedures vary. Follow any instructions that are displayed on the screen after the download is complete. If no instructions are displayed:

1. Open Windows Explorer. To open Windows Explorer from the **Start** button:

Select **Start > All Programs > Accessories > Windows Explorer**.

2. In the left pane of the Windows Explorer window, select **My Computer** > your hard drive designation. (The hard drive designation is typically Local Disk C.) Then follow the path you recorded earlier to the folder on your hard drive containing the update.
3. To begin the installation, open the folder, and then double-click the file with an .exe extension—for example, Filename.exe. (The ROM update installation begins.)
4. To complete the installation, follow the instructions on the screen.



After a message on the screen reports a successful installation, you can delete the downloaded file from the destination folder.

---

## Downloading and Installing a Non-ROM SoftPak

To update software other than the ROM:

1. Access the page at the <http://www.compaq.com/consumersupport> Web site that provides software for your notebook.
2. Select **Start > Help and Support**, and then select a software update link.
3. Follow the instructions on the screen to identify your notebook and access the SoftPak you want to download.
4. At the download area:
  - a. Write down the date, name, or other identifier of the SoftPak you plan to download. (You may need this information to locate the update later, after it has been downloaded to the hard drive.)
  - b. Follow the online instructions to download the SoftPak to the hard drive.
5. When the download is complete, open Windows Explorer. To open Windows Explorer from the Start button:  
Select **Start > All Programs > Accessories > Windows Explorer**.

6. In the left pane of the Windows Explorer window, select **My Computer** > your hard drive designation (which is typically Local Disk C) > **SWSetup**.

The destination folder for most downloads from the <http://www.compaq.com/consumersupport> Web site is the SWSetup folder. If you don't see the download in the SWSetup folder, look in the My Documents folder.

7. In the destination folder, select the name or number of the software package you have downloaded.
8. Select the file that includes an .exe extension—for example, Filename.exe. (The installation begins.)
9. To complete the installation, follow the instructions on the screen.



After a message on the screen reports a successful installation, you can delete the downloaded file from the destination folder.

---

# Software Recovery

## Using System Restore

System Restore is an operating system feature that enables you to undo harmful changes to your notebook software by restoring your software to an earlier time, called a *restore point*, when your software was functioning optimally.

Restore points are restorable, benchmark “snapshots” of your application, driver, and operating system files. The notebook sets restore points at regular intervals and may set additional restore points whenever you change your personal settings or add software or hardware.

Manually setting additional restore points provides additional protection for your system files and settings. It is recommended that you manually set restore points

- Before you add or extensively modify software or hardware.
- Periodically, whenever the system is performing optimally.

Restoring to any restore point does not affect your data files. For example, restoring your system software to an earlier time will not affect documents or emails that you saved after that time. All System Restore procedures are reversible.

## Setting a Restore Point

To set a system restore point manually:

1. Select **Start > Help and Support > System Restore**.
2. Select **Create a restore point**, and then follow the instructions on the screen.

## Restoring to a Restore Point

To restore the notebook to a restore point:

1. Make sure the notebook is connected to reliable external power through the AC adapter.
2. Select **Start > Help and Support > System Restore**.
3. Select **Restore my computer to an earlier time**, and then follow the instructions on the screen.

## Setup Utility

The Setup utility is a ROM-based information and customization utility that can be used even when your operating system is not working or will not load.

The utility reports information about the notebook and provides settings for startup, security, and other preferences.

Step-by-step instructions for setting specific preferences are included by topic earlier in this guide. For example, procedures for setting password and other security preferences are provided in [Chapter 6, “Security.”](#)

## Opening the Setup Utility

To open the Setup Utility:

1. Turn on or restart the notebook in Windows.
2. Before Windows opens and while the “Press <F10> to enter setup” prompt is displayed in the lower-left corner of the screen, press **F10**.

## Changing the Language of Computer Setup

The following procedure explains how to change the language of the Setup utility. If the notebook is not in the Setup utility, begin at step 1. If the notebook is in the Setup utility, begin at step 2.

1. To open the Setup utility, turn on or restart the notebook in Windows, and then press **f10** while the prompt “Press <F10> to enter setup” is displayed in the lower-left corner of the screen.
2. Use the arrow keys to select the **Advanced** menu.
3. Press **f5** or **f6** (or use the arrow keys) to select a language, and then press **enter**.
4. When a confirmation prompt with your preference selected is displayed, press **enter** to save your preference.
5. To set your preferences and exit the Setup utility, press **f10**, and then follow the instructions on the screen.

Your preferences are in effect when the notebook restarts in Windows.



## Navigating and Selecting in the Setup Utility

Because the Setup utility is not Windows-based, it does not support the TouchPad. Navigation and selection are by keystroke.

- To choose a menu or a menu item, use the arrow keys.
- To choose an item in a drop-down list or to toggle a field, for example an Enable/Disable field, use either the arrow keys or **f5** or **f6**.
- To select an item, press **enter**.
- To close a text box or return to the menu display, press **esc**.

To display additional navigation and selection information while the Setup utility is open, press **f1**.

## Displaying System Information

The following procedure explains how to display system information in the Setup utility. If the Setup utility is not open, begin at step 1. If the Setup utility is open, begin at step 2.

1. To open the Setup utility, turn on or restart the notebook in Windows, and then press **F10** while the prompt “Press <F10> to enter setup” is displayed in the lower-left corner of the screen.
2. Access the system information on the **Main** and **Advanced** menus.
  - ❑ To display most of the system information available in the Setup utility, use the arrow keys to select the **Main** menu.
  - ❑ To display video memory information, use the arrow keys to select the **Advanced** menu.
3. To close the Setup utility without changing any settings, use the arrow keys to select the **Exit** menu > **Exit Discarding Changes**, and then press **enter**. (The notebook restarts in Windows.)

## Restoring Default Settings in the Setup Utility

The following procedure explains how to restore the Setup utility default settings. If the notebook is not in the Setup utility, begin at step 1. If the notebook is in the Setup utility, begin at step 2.

1. To open the Setup utility, turn on or restart the notebook in Windows, and then press **f10** while the prompt “Press <F10> to enter setup” is displayed in the lower-left corner of the screen.
2. Select **Exit > Load Setup Defaults**, and then press **f10**.
3. When the Setup Confirmation is displayed, press **enter** to save your preferences.
4. To set your preferences and exit the Setup utility, press **f10**, and then follow the instructions on the screen.

The Setup utility default settings are set when you exit the Setup utility and are in effect when the notebook restarts. Identification information, including ROM version information, is retained.

## Using Advanced Setup Utility Features

This guide describes the Setup utility features recommended for all users. For more information about the Setup utility features recommended for advanced users only, refer to the Help and Support Center by selecting **Start > Help and Support**.

The Setup utility features available for advanced users include a hard drive self-test, a Network Service Boot, and settings for boot order preferences.

The “<F12> to boot from LAN” message that is displayed in the lower-left corner of the screen each time the notebook is started or restarted in Windows or restored from hibernation is the prompt for a Network Service Boot.

The “Press <ESC> to change boot order” message that is displayed in the lower-left corner of the screen each time the notebook is started or restarted in Windows or restored from hibernation is the prompt to change the boot order.

## Closing the Setup Utility

You can close the Setup utility with or without saving changes.

- To close the Setup utility and save your changes from the current session, use either of the following procedures:
  - Press **f10**, and then follow the instructions on the screen.
  - or –
  - If the Setup utility menus are not visible, press **esc** to return to the menu display. Then use arrow keys to select the **Exit** menu > **Exit Saving Changes**, and then press **enter**.

When you use the **f10** procedure, you are offered an option to return to the Setup utility. When you use the Exit Saving Changes procedure, the Setup utility closes when you press **enter**.

- To close the Setup utility without saving your changes from the current session:

If the Setup utility menus are not visible, press **esc** to return to the menu display. Then use arrow keys to select the **Exit** menu > **Exit Discarding Changes**, and then press **enter**.

After the Setup utility closes, the notebook restarts in Windows.

---

# Specifications

## Operating Environment

The operating environment information in the following table may be helpful if you plan to use or transport the notebook in extreme environments.

<b>Factor</b>	<b>Metric</b>	<b>U.S.</b>
<b>Temperature</b>		
Operating	10°C to 35°C	50°F to 95°F
Nonoperating	-20°C to 60°C	-4°F to 140°F
<b>Relative humidity (noncondensing)</b>		
Operating	10% to 90%	10% to 90%
Nonoperating	5% to 95%	5% to 95%
<b>Maximum altitude (unpressurized)</b>		
Operating	-15 m to 3,048 m	-50 ft to 10,000 ft
Nonoperating	-15 m to 12,192 m	-50 ft to 40,000 ft

## Rated Input Power

The power information in this section may be helpful if you plan to travel internationally with the notebook.

The notebook operates on DC power, which can be supplied by an AC or a DC power source. Although the notebook can be powered from a stand-alone DC power source, it is strongly recommended that the notebook be powered only with an AC adapter or DC power cord supplied with or approved for a Compaq notebook.

The notebook is capable of accepting DC power within the following specifications.

<b>Input Power</b>	<b>Rating</b>
Operating voltage	18.5 V DC @ 3.5A - 65 W
Operating current	3.5 A

This product is designed for IT power systems in Norway with phase-to-phase voltage not exceeding 230V.

## Expansion Port Input/Output Signals

The expansion port signal information in this section may be helpful if you plan to use an optional expansion product that connects to the Expansion Port 2 on your notebook (The term *Expansion Port 2* describes the type of expansion port).

The expansion port is illustrated in the “[Left-Side Components](#)” section of [Chapter 1, “Component ID.”](#)

The following table identifies the input and output signals supported by the expansion port on your notebook.

Feature	Support
USB 2.0	Yes
10/100 Ethernet	Yes
Gigabit Ethernet	No
IEEE 1394 (4-pin port)	Yes
Consumer IR (for optional remote control only)	Yes
Power inputs	90-135W maximum
Composite TV*	Yes
S-Video TV	Yes
Component TV	No
S/PDIF audio*	Yes
DVI	No
Headphone/speaker audio-out	Yes
Microphone audio-in	Yes

\*Requires the use of an optional expansion product.



---

# Index

1394 port 1–14, 7–3

## A

AC adapter 1–18

AC power vs. battery power  
3–1

administrator password 6–5,  
6–7

airport security devices 7–14

altitude specifications A–1

antennae 1–7

antivirus software 6–12

applications key, Windows  
1–2

audio-in (microphone) jack  
1–9, 4–4

audio-out (headphone) jack  
1–9, 4–3

## B

base, docking. *See* docking  
device

battery bay 1–17, 1–19

battery light 1–8  
displaying charge status  
3–14, 3–17  
identifying 1–8, 3–3

battery pack

battery power vs. AC  
power 3–1

calibrating 3–19

charging 3–13

conserving power 3–23

diagnostic information  
8–14

disposing of 3–28

inserting 3–26

low-battery conditions  
3–17

monitoring charge 3–15

recycling 3–28

removing 3–25

storing 3–27

battery pack release latch  
1–17, 3–25

bays

battery 1–17, 1–19

hard drive 1–17

*See also* compartments

BIOS information, displaying  
6–2, 8–3

## Bluetooth device

- wireless light 1–5

## Bluetooth label 1–20

## boot order 8–16

## buttons

- display release 1–9

- mute 1–6, 4–2

- PC Card eject 1–12, 7–12

- power 1–4, 3–7, 3–11

- TouchPad 1–3, 2–1

- volume 4–2

- volume down 1–6

- volume up 1–6

- wireless 1–6

**C**

- cable lock, security 1–13, 6–15

## cables

- audio 4–5

- modem 1–18

- network 1–11

- S-Video 4–5

- See also* power cord

- calibration, battery 3–19

- camcorder, connecting 7–3

- camera, connecting 7–3

- caps lock light 1–5

- card and socket services,

  - PC Card 7–9

- card. *See* digital memory

  - cards; memory; PC Card

- category view, Windows XP

  - 2–3

## CDs

- audio, hotkeys 4–7

- copying 4–8

- creating 4–8

- playing 4–7, 4–8

- writing to 4–8

## Certificate of Authenticity

- label 1–19

- classic view, Windows 2–3

- combination power adapter 3–1, 3–13

## compartments

- memory 1–16, 7–19

- Mini PCI 1–16

- See also* bays

- composite video 2–9

## connectors

- drive 7–14

- power 1–10

- See also* jacks; ports

- conservation, power 3–23

## cord, power

- See also* cables

- cord, power, identifying 1–18

- country-specific modem

  - adapter 1–18

- critical low-battery condition

  - 3–17

**D**

- default Setup utility settings, restoring 8–15
- device disabling 6–11
- device security 6–11
- device, connecting powered 7–1
- digital memory cards
  - inserting 7–7
  - removing 7–8
- disc, optical. *See* CDs; DVDs
- diskette
  - affected by airport security 7–14
  - protecting playback 3–6
- display release button 1–9
- display switch
  - identifying 1–4, 3–3
  - setting preferences 3–11
- display, internal
  - controlling brightness 2–11
  - switching image 2–9
- docking device
  - docking, undocking while using disc, diskette 4–8
  - expansion port on notebook 1–11
  - monitor port 2–9
  - USB support 7–2
- docking device as power source 3–1

## drives

- adding to system 7–13
- affected by airport security 7–14
- avoiding standby and hibernation while using discs, diskettes 3–6, 4–8
- boot order 8–16
- caring for 7–14
- IDE drive light 7–13
- shipping 7–14
- USB 7–2
- See also* CDs; DVDs; hard drive

## DVDs

- hotkeys 4–7
- playing 4–7, 4–8
- writing to 4–8

**E**

- eject buttons, PC Card 7–12
- electrostatic discharge (ESD) 7–14, 7–20
- emergency shutdown procedures 3–10
- enablers, PC Card 7–9
- environmental specifications A–1, A–2
- ESD (electrostatic discharge) 7–14, 7–20
- exhaust vent 1–10, 1–13, 1–17
- Expansion Port 2 1–11, A–3
- external monitor port 1–11
- external numeric keypad 2–16

**F**

- F12 to boot from LAN
  - message 8–16
- firewall software 6–14
- fn** key 1–1
- function keys (**f1**, **f2**, etc.) 2–5

**H**

- hard drive
  - affected by airport security 7–14
  - displaying amount of free space on 7–19
  - replacing internal 7–15
  - self-test 8–16
  - space on, required for hibernation file 7–19
- hard drive bay
  - identifying 1–17
  - replacing hard drive 7–15
- headphone (audio-out) jack 1–9, 4–3
- headphones 4–3
- Help and Support Center 2–7
- hibernation
  - avoiding when using discs, diskettes 3–6, 4–8
  - defined 3–5
  - enabling/disabling 3–5
  - identifying 7–15
  - initiated during critical low-battery condition 3–17
  - initiating 3–9
  - restoring from 3–5, 3–9
  - setting preferences 3–11
  - when to use 3–5

- hibernation file 3–5, 7–19
- hotkey commands
  - access Help and Support Center 2–7
  - control media activity (play, pause, stop, etc.) 2–12, 4–7, 8–3
  - decrease display brightness 2–11
  - display system information 2–13
  - increase display brightness 2–11
  - initiate QuickLock 2–11
  - initiate standby 3–8, 3–11
  - open Internet Explorer 2–8
  - open print options window 2–8
  - Quick Reference 2–6
  - switch image 2–9
- hotkeys
  - identifying 1–1, 2–5
  - procedures 2–7
  - Quick Reference 2–6
  - using with external keyboard 2–7
- hub, USB 7–2
- humidity specifications A–1

**I**

- IDE drive light 1–8, 7–13
- identifying components
  - bottom 1–16
  - front 1–8
  - left-side 1–10
  - rear 1–10
  - right-side 1–14
  - top 1–1
- IEEE 1394 port 1–14, 7–3
- Internet Connection Wizard 2–8
- Internet Explorer 2–8

**J**

- jacks
  - audio-in (microphone) 1–9, 4–4
  - audio-out (headphone) 1–9, 4–3
  - RJ-11 (modem) 1–11
  - RJ-45 (network) 1–11
  - S-Video-out 1–15, 4–5
  - S-Video-out 1–15
  - See also* connectors; ports

**K**

- keyboard, external 2–7
- keypad, embedded numeric
  - identifying 1–2, 2–14
  - procedures 2–15
- keypad, external numeric
  - procedures 2–16

## keys

- fn** 1–1
- function (**f1**, **f2**, etc.) 1–1
- hotkeys 1–1, 2–5
- keypad 1–2, 2–14
- num lock** 2–15
- scroll lock** 2–7
- shift** 2–16, 3–9
- Windows applications 1–2
- Windows logo 1–2
- See also* buttons; display switch

**L**

- labels
  - Bluetooth 1–20
  - Microsoft Certificate of Authenticity 1–19
  - Modem Approval 1–20
  - Regulatory 1–19
  - Service Tag 1–19
  - wireless certification 1–20
  - WLAN 1–20
- language, changing in Setup utility 8–12
- latch, battery pack release 1–17
  - See also* buttons; display switch

## lights

- battery 1–8, 3–14, 3–17
  - caps lock 1–5
  - IDE drive 1–8, 7–13
  - Memory Reader 1–14, 7–6
  - mute 1–5, 4–2
  - num lock 1–5, 2–15
  - power/standby 1–5, 1–8, 3–7
  - TouchPad 1–3, 2–1
  - wireless 1–5
- lock, security cable 1–13, 6–15
- lock-up, system 3–10
- low-battery condition 3–17

**M**

## memory

- displaying amount of 2–7, 7–19
  - increasing RAM 7–19
- memory compartment 1–16, 7–21
- memory module, removing or inserting 7–20
- Memory Reader 1–14, 7–5, 7–6
- Memory Reader light 1–14, 7–6
- Memory Stick, Memory Stick Pro 7–5
- microphone 4–4
- microphone (audio-in) jack 1–9, 4–4

## Microsoft Certificate of Authenticity label 1–19

## Mini PCI compartment 1–16

## model, identifying notebook 2–7, 8–2

## modem (RJ-11) jack 1–11

## Modem Approval label 1–20

## modem cable 1–18

## modem, country-specific adapter 1–18

## monitor

- connecting 7–1
  - switching image 2–9, 7–1
- mouse, external
- setting preferences 2–3
  - USB 7–2

## MultiMediaCard 7–5

## mute button 1–6, 4–2

## mute light 1–5, 4–2

**N**

## network (RJ-45) jack 1–11

## network cable 1–11

## Network Service Boot 8–16

## Norton AntiVirus 6–12

## notebook model, family, type, and serial number 2–7, 8–2

**num lock** key 2–15

## num lock light 1–5, 2–15

numeric keypad. *See* keypad, external numeric; keypad, embedded numeric

**O**

- operating environment
  - specifications A-1
- operating system
  - Internet Connection Wizard 2-8
  - loading 3-7
  - Microsoft Certificate of Authenticity label 1-19
  - passwords 6-4
  - Product Key 1-19
  - security 6-1
  - shutting down 3-7, 3-10
- optical disc. *See* CDs; DVDs
- optical drive
  - identifying 1-15
  - See also* CDs; drives; DVDs

**P**

- passwords
  - administrator 6-5, 6-7
  - power-on 6-5, 6-9
  - QuickLock 2-11
  - Setup utility 6-4
  - standby 3-11, 6-5
  - user 6-5
  - Windows 6-4
  - Windows administrator 2-11
  - Windows user 2-11
- PC Card
  - configuring 7-9
  - inserting, removing 7-10
  - stopping 7-11
  - types supported 7-9

- PC Card eject button 1-12, 7-11
- PC Card slot 1-12, 7-10
- pointing device 2-2
- ports
  - 1394 1-14, 7-3
  - expansion 1-11
  - external monitor 1-11, 2-9
  - IEEE 1394 1-14
  - USB 1-11, 1-14, 7-2
  - See also* connectors; jacks
- power
  - conserving 3-5, 3-23
  - control and light locations 3-3
  - schemes 3-11
  - setting preferences 3-11
  - sources 3-1
  - switching between AC and battery 3-2
  - See also* battery pack; hibernation; shutdown procedures; standby
- power button
  - default functions 3-7
  - identifying 1-4, 3-3
  - resetting notebook with 3-10
  - setting preferences 3-11
- power connector 1-10
- power cord
  - external device 7-19
  - notebook 1-18
  - See also* cables
- Power Meter icon 3-2, 3-16

- power/standby light 1–5, 1–8, 3–7
- powered device, connecting 7–1
- power-on password 6–5, 6–9
- Product Key 1–19
- product name and number, notebook 1–19, 2–7
- projector
  - connecting 1–11, 7–1
  - switching image 2–9
- PXE server 7–4
- Q**
- QuickLock 2–11, 6–3
- R**
- RAM (random access memory) 7–19
- regulatory information
  - Modem Approval label 1–20
  - Regulatory label 1–19
  - wireless certification labels 1–20
- release latch, battery pack 1–17, 3–25
- remote control 4–7
- reset (emergency shutdown procedures) 3–10
- restore point 8–9
- RJ-11 (modem) jack 1–11
- RJ-45 (network) jack 1–11
- ROM
  - determining current version of 8–3

- downloading and installing 8–5
- obtaining updates 8–4
- ROMPaq 8–4
- S**
- scanner 7–3
- screen saver 3–24
- scroll lock** key 2–7
- scrolling regions, TouchPad 1–3, 2–2
- Secure Digital (SD) Memory Card 7–5
- security cable lock, connecting 6–15
- security cable slot 1–13
- security features 6–1
- See also* software
- serial number, notebook 1–19, 2–7
- series, notebook 8–2
- Service Tag 1–19
- Setup 6–5
- Setup utility
  - changing language 8–12
  - displaying system information 8–14
  - navigation and selection 8–13
  - Network Service Boot 7–4, 8–16
  - opening 8–11
  - restoring default settings 8–12, 8–15



- Setup utility passwords 6-4, 6-5
  - shift** key
    - embedded numeric keypad function 2-16
    - hibernation function 3-9
  - shutdown procedures 3-7
  - sleep button 2-10
  - sleep. *See* standby
  - slots
    - memory 7-19
    - PC Card 1-12
    - security cable 1-13
  - SmartMedia (SM) card 7-5
  - socket services, PC Card 7-9
  - SoftPaq 8-4, 8-7
  - software
    - antivirus 6-12
    - firewall 6-2, 6-14
    - Internet Connection Wizard 2-8
    - Power Meter 3-16
    - ROMPaq 8-4
    - security features 6-1
    - Setup utility 8-11
    - SoftPaq 8-4
    - System Restore 8-9
    - updating 8-1
  - speakers
    - external 4-3
    - internal 1-9, 4-1
  - specifications
    - operating environment A-1
    - rated input power A-2
  - standby
    - avoiding when using discs, diskettes 3-6, 4-8
    - initiated during critical low-battery condition 3-17
    - initiating 3-8
    - password 3-11
    - power/standby light 1-5, 1-8
    - resuming from 3-8
    - setting preferences 3-11
  - standby password 6-5
  - stereo speakers
    - external 4-3
    - internal 1-9, 4-1
  - S-Video-out jack 1-15, 4-5
  - switch, display
    - identifying 1-4, 3-3
    - setting preferences 3-11
  - system information,
    - displaying 8-3, 8-14
  - system lock-up 3-10
  - System Restore 8-9
- T**
- telephone jack (RJ-11 jack) 1-11
  - television
    - connecting audio 4-3
    - connecting video 4-6
  - temperature
    - specifications A-1
    - storage, battery pack 3-27
  - 1394 port 1-14, 7-3
  - TouchPad 1-3, 2-1

- traveling with notebook
  - battery pack temperature considerations 3–27
  - environmental specifications A–1
  - Modem Approval label 1–20
  - wireless certification labels 1–20
- turning off notebook 3–7, 3–10
- turning on notebook 3–7
- tutorials 2–7, 7–4

## **U**

- unresponsive system, emergency shutdown procedures 3–10
- USB devices, connecting 7–2
- USB ports, identifying 1–11, 1–14
- user password 6–5

## **V**

- VCR
  - connecting audio 4–3
  - connecting video 4–5
- vents, exhaust 1–10, 1–13, 1–17
- video device
  - connecting 4–5, 7–1
  - turning on or off 4–6
- viruses, antivirus software 6–12
- volume buttons 1–6
- volume, adjusting 4–2

## **W**

- Windows applications key 1–2
- Windows category vs.
  - Windows classic view 2–3
- Windows firewall 6–2
- Windows logo key 1–2
- Windows passwords 6–5
- wireless button 1–6
- wireless certification label 1–20
- wireless device antennae 1–7
- wireless devices
  - antennae 1–7
  - lights 1–5
  - Mini PCI compartment 1–16
  - wireless functionality
    - on/off button 1–6
    - wireless light 1–5
- wireless LAN device, wireless button 1–6
- wireless light 1–5
- WLAN label 1–20

## **X**

- xD-Picture Card 7–5

## Free Manuals Download Website

<http://myh66.com>

<http://usermanuals.us>

<http://www.somanuals.com>

<http://www.4manuals.cc>

<http://www.manual-lib.com>

<http://www.404manual.com>

<http://www.luxmanual.com>

<http://aubethermostatmanual.com>

Golf course search by state

<http://golfingnear.com>

Email search by domain

<http://emailbydomain.com>

Auto manuals search

<http://auto.somanuals.com>

TV manuals search

<http://tv.somanuals.com>