



Getting Started

Evo Notebook N610c Series

Document Part Number: 279359-001

July 2002

This guide explains how to set up your hardware and software, identify the exterior components of the notebook, find and install the latest versions of Compaq software, and find additional information and support.

© 2002 Compaq Information Technologies Group, L.P.

Compaq, the Compaq logo, Evo, RomPaq, and SoftPaq are trademarks of Compaq Information Technologies Group, L.P. in the U.S. and/or other countries. Microsoft and Windows are trademarks of Microsoft Corporation in the U.S. and/or other countries. All other product names mentioned herein may be trademarks of their respective companies.

Compaq shall not be liable for technical or editorial errors or omissions contained herein. The information is provided "as is" without warranty of any kind and is subject to change without notice. The warranties for Compaq products are set forth in the express limited warranty statements accompanying such products. Nothing herein should be construed as constituting an additional warranty.

Getting Started

First Edition July 2002

Document Part Number: 279359-001

Contents

1 Hardware and Software Setup

Setting Up the Hardware	1-1
Setting Up the Software	1-4
Installing Optional Applications	1-5
Notebook Support and Safety Tips	1-6

2 A Look at the Notebook

Display Components	2-1
Pointing Device Components	2-2
Pointing Stick Model	2-2
TouchPad Model	2-3
Dual Pointing Device Model	2-4
Top Components	2-5
Speakers and Memory Compartment	2-5
Lights	2-6
Buttons, Keys and Switches	2-8
Left Side Components	2-9
Right Side Components	2-10
Front Panel Components	2-11
Rear Panel Components	2-12
Bottom Components	2-13
Additional Standard Components	2-15

3 How to Get Information, Help and Updates

Using the Documentation Library CD	3-1
Viewing Guides on the CD	3-2
Contacting Technical Support	3-3
Updating Compaq Software	3-4
Obtaining the Compaq Support Software CD	3-5
Preparing to Update Software	3-5
Displaying ROM Information in Computer Setup	3-6
Downloading Software from Compaq	3-6
Downloading System ROM	3-7
Downloading Other SoftPaqs	3-8
Restoring Software	3-9
Installing a Retail Version of an Operating System	3-10

Index

Hardware and Software Setup

Setting Up the Hardware



CAUTION: *Setup must begin with connecting the notebook to AC power.* To ensure that the correct drivers load and to prevent file corruption or damage to the components during initial setup:

- Do not remove the battery pack until the notebook has been connected to external AC power.
- Run the notebook on external AC power, not on battery power, throughout initial setup.
- Do not set up the notebook while it is docked in an optional Port Replicator.

-
1. Place the notebook on a flat surface near an electrical outlet, then connect the notebook to external AC power.

Plug the AC Adapter cable into the DC power connector **1**. Plug the power cord into the AC Adapter **2** and into an electrical outlet **3**. (Power cords and outlets vary by country.)

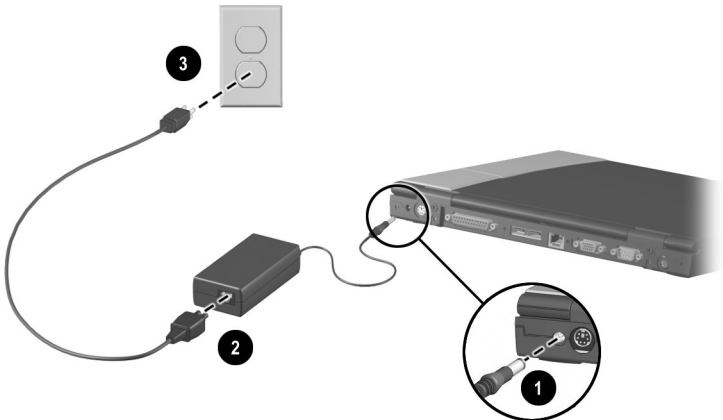

Connecting the notebook to external power

2. Open the notebook by sliding the display release latch to the right **1** and raising the display **2**.

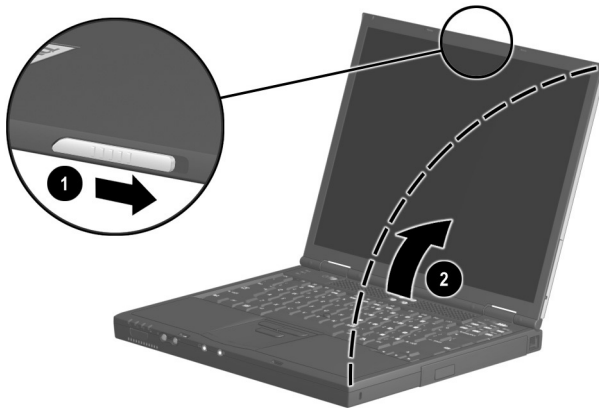

Opening the notebook

3. Turn on the notebook by sliding and releasing the power switch ❶.

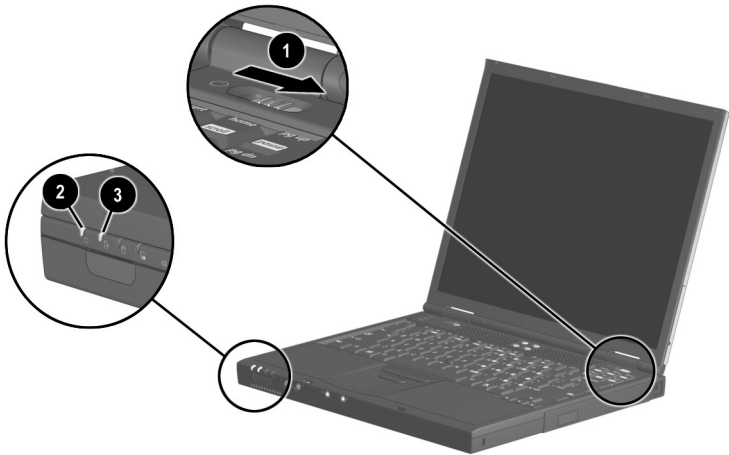

Turning on the notebook

When the notebook is turned on:

- The power/standby light ❷ turns on.
- The battery pack in the battery bay begins to charge and the battery light ❸ turns on. The battery light remains on while the battery pack is charging and turns off when the battery pack is fully charged.
- You are prompted to begin software setup.

Setting Up the Software

The initial setup prompt is displayed on the screen as soon as the notebook is connected to external power.

Before responding to the initial setup prompt and proceeding through the online instructions, read the following caution and setup information:



CAUTION: To ensure that the correct drivers load and to prevent file corruption or damage to the components during initial setup:

- Do not unplug the notebook from the electrical outlet.
 - Do not shut down the notebook.
 - Do not remove or insert a drive.
-
- After you begin initial software setup, you must complete the entire process. Setup time varies depending on notebook configuration.
 - If you are prompted to select a language or operating system, choose carefully and keep in mind the following facts:
 - The languages and operating system that you do not choose will be deleted from the system and cannot be restored during initial setup.
 - An operating system available during initial setup is enhanced by Compaq. When an operating system is deleted, the enhancements are also deleted.
 - During the setup process, you must accept the End User License Agreement to continue.

Installing Optional Applications

You can install third-party applications or preloaded Compaq utilities at any time after initial setup is complete.

- To install a third-party application, refer to the documentation included with the application.
- To install a preloaded Compaq application, access the Setup Compaq Software utility:
 - ❑ **In Windows 2000 Professional**, the Setup Compaq Software icon is on the desktop. Select Setup Compaq Software icon > Next. Select the check box for the application you want to install. (Clear check boxes for preloaded software you do not want to install.)
 - ❑ **In Windows XP Professional**, select Start > All Programs > Setup Compaq Software icon > Next. Select the check box for the application you want to install. (Clear check boxes for preloaded software you do not want to install.)



To view the descriptions and space requirements of preloaded Compaq utilities without installing them, select the Setup Compaq Software icon > Next. After viewing the utility information, select Cancel.

Notebook Support and Safety Tips

After setting up the software, locate the support and safety information included with your notebook.

- View Compaq Help and Support by selecting Start > Compaq Info Center > Compaq Help and Support. This area provides links to the Compaq Web site where you can:
 - ❑ Download the latest software and drivers for your notebook.
 - ❑ Open an online service event with a Compaq support specialist.
 - ❑ Get information about your notebook, including reference guides, specifications, white papers, and customer advisories.
- Read suggestions for creating a safe and comfortable work environment. Ergonomic and safety information about the notebook is provided on this CD in the *Safety & Comfort Guide*.



WARNING: This is a Class B digital device, pursuant to Part 15 of the FCC Rules. For more Class B information, refer on this CD to *Regulatory and Safety Notices*. To reduce the risk of personal injury, electric shock, fire, or damage to the equipment:

- Do not disable the power cord grounding plug. It is an important safety feature.
- Plug the power cord into a grounded (earthed) electrical outlet that is easily accessible at all times.
- Do not place anything on power cords or cables. Arrange them so that no one can accidentally step on or trip over them.
- Disconnect power from the equipment by unplugging the power cord from the electrical outlet.
- Do not pull on a cord or cable. When unplugging from the electrical outlet, grasp the cord by the plug.

-
- Hibernation is enabled by default. Compaq recommends that you do not disable it.

Confirming Hibernation Setting



Hibernation is an energy-saving feature enabled at the factory that can be initiated by you or by the system. This feature protects your notebook by saving all information in RAM (random access memory) to a hibernation file on the hard drive and shutting down the notebook. For more information about using Hibernation, refer to the *Software Guide*, “Power” chapter on the *Documentation Library* CD included with the notebook.

To verify that Hibernation is enabled:

- **In Windows 2000 Professional**, select Start > Settings > Control Panel > Power Options icon > Hibernate tab. Make sure that the Enable Hibernate Support check box is selected.
- **In Windows XP Professional**, select Start > Control Panel > Power Options icon > Hibernate tab. Make sure that the Enable Hibernate Support check box is selected.

A Look at the Notebook

Display Components



Identifying display components

❶ Display release latch	Opens the notebook.
❷ MultiPort	Supports an optional USB-enabled wireless device such as a Bluetooth, 802.11 wireless LAN, or PC Smart Card Reader module.

Pointing Device Components

Pointing Stick Model

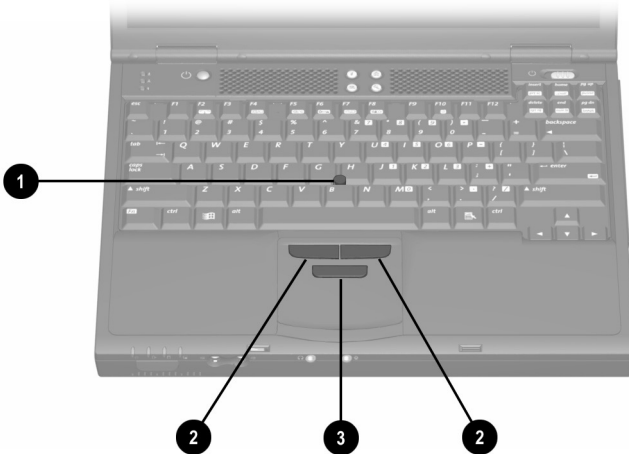

Identifying pointing stick components

1 EasyPoint IV 3D Pointing Stick	Moves the pointer and selects or activates items on the screen.
2 Left and right pointing-stick buttons	Function like the left and right buttons on an external mouse.
3 Scroll pointing-stick button	Functions like the scroll button on an external mouse.

TouchPad Model



Identifying TouchPad components

❶ TouchPad	Moves the pointer and selects or activates items on the screen. Can be set to perform other mouse functions, such as scrolling, selecting, and double-clicking.
❷ Left and right TouchPad buttons	Function like the left and right buttons on an external mouse.

Dual Pointing Device Model

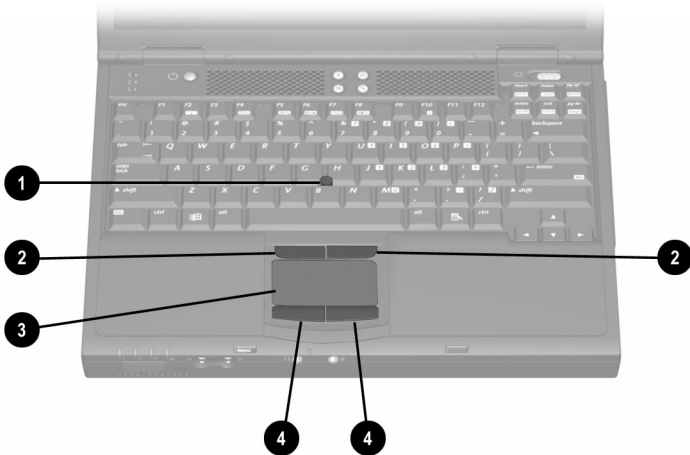

Identifying dual pointing device components

①	Pointing stick	Moves the pointer and selects or activates items on the screen.
②	Left and right pointing-stick buttons	Function like the left and right mouse buttons on an external mouse.
③	TouchPad	Moves the pointer and selects or activates items on the screen. Can be set to perform other mouse functions, such as scrolling, selecting, and double-clicking.
④	Left and right TouchPad buttons	Function like the left and right buttons on an external mouse.

Top Components

Speakers and Memory Compartment

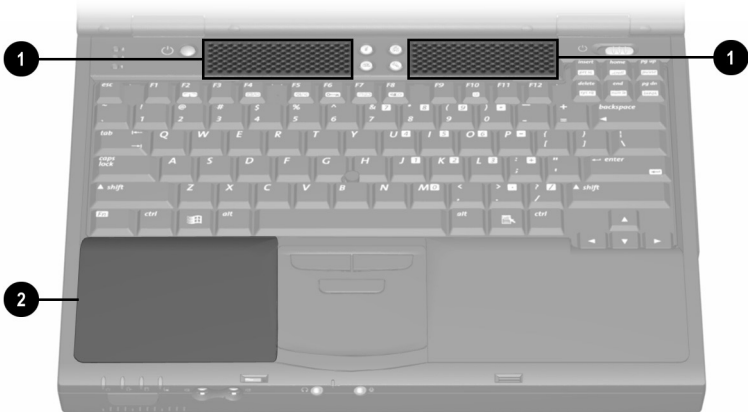

Identifying the speakers and memory compartment

① Stereo speakers (2)	Produce stereo sound.
② Memory expansion compartment	Contains 2 memory expansion slots for optional memory expansion boards.

Lights

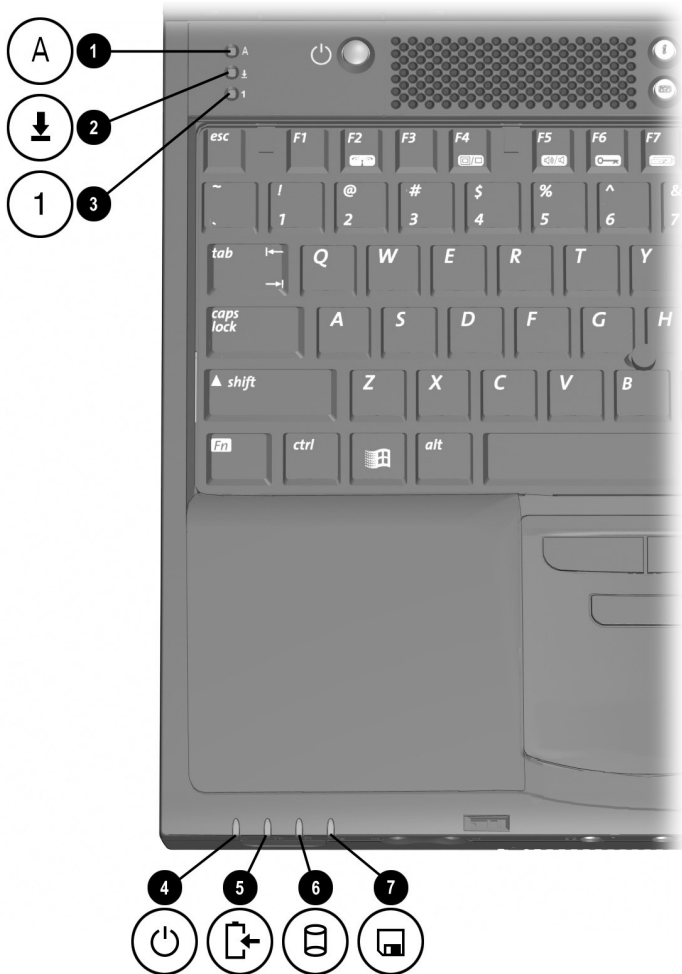

Identifying lights on top of the notebook

Lights (*Continued*)

① Caps lock light	On: Caps lock is on.
② Scroll lock light	On: Scroll lock is on.
③ Num lock light	On: Num lock is on or the embedded numeric keypad is enabled.
④ Power/standby light	<p>On: Power is turned on. Blinking: Notebook is in Standby.</p> <p> The power/standby light also blinks when a battery pack, which is the only available power source, reaches a critical low-battery condition while Hibernation is disabled.</p>
⑤ Battery light	<p>On: A battery pack is charging. Blinking: A battery pack, which is the only available power source, has reached a low-battery condition.</p>
⑥ IDE (Integrated Drive Electronics) drive light	<p>On: One of the following drives is being accessed:</p> <ul style="list-style-type: none"> ■ Hard drive in the hard drive bay. ■ Optional hard drive, CD drive, DVD drive, Zip drive, or SuperDisk drive in the MultiBay.
⑦ Diskette drive light	<p>On: A standard diskette drive in the MultiBay or optional external diskette drive bay is being accessed.</p>

Buttons, Keys and Switches

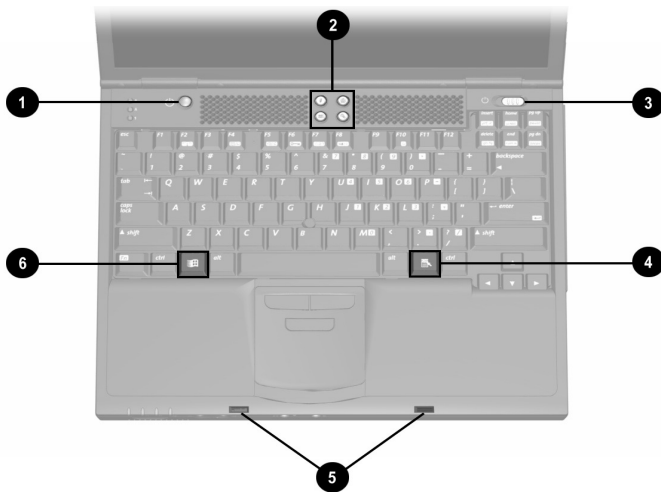

Identifying buttons, keys and switches on the top of the notebook

❶ Standby button	Initiates and resumes from Standby.
❷ Easy Access Buttons (4)	Programmable buttons that provide quick access to Internet or network destinations, or to software applications or data files in the system.
❸ Power switch	Turns the notebook on or off or resumes from Hibernation.
❹ Applications key	Displays a shortcut menu for items beneath the pointer.
❺ Display release latch recesses (2)	Secure the display when it is closed.
❻ Microsoft logo key	Displays the Windows Start menu.
 This table describes default settings. For more information about optional power settings, refer on this CD to the "Power" chapter in the <i>Software Guide</i> .	

Left Side Components

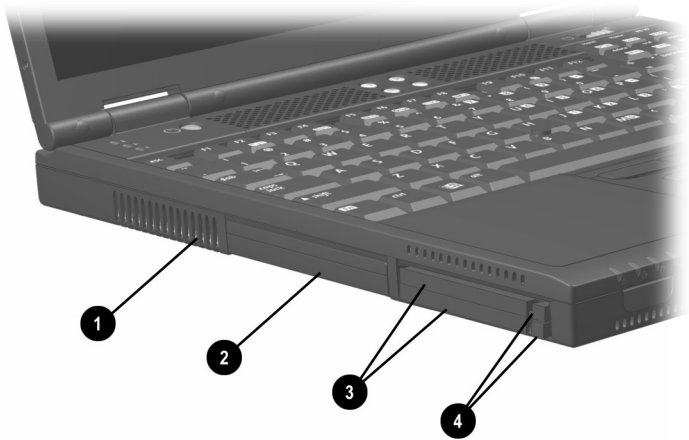

Identifying left side components

❶ Exhaust vent	Allows airflow to cool internal components.
	 To prevent overheating, do not obstruct vents. Using the notebook on a soft surface, such as a pillow, blanket, rug, or thick clothing, may block airflow.
❷ Hard drive bay	Holds the primary hard drive.
❸ PC Card slots (2)	Support optional Type I or Type II 32-bit (CardBus) or 16-bit PC Cards.
❹ PC Card eject buttons (2)	Top button: Ejects an optional PC Card from the top PC Card slot. Bottom button: Ejects an optional PC Card from the bottom PC Card slot.

Right Side Components

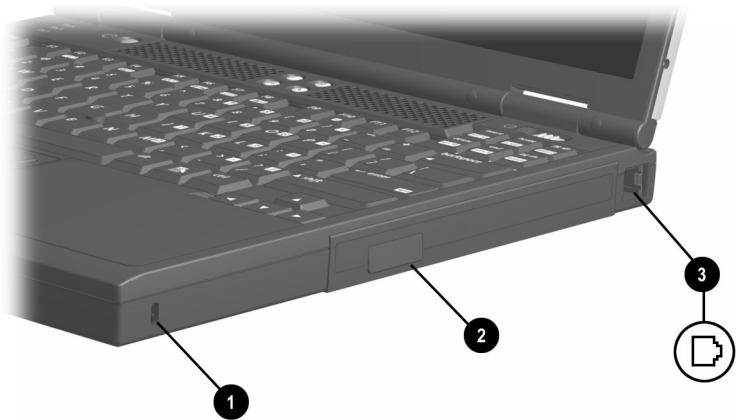

Identifying right side components

❶ Security cable slot	Attaches an optional security cable to the notebook.
❷ MultiBay	Supports an optional MultiBay device, such as a drive or battery pack.
❸ RJ-11 jack	Connects the modem cable.

Front Panel Components

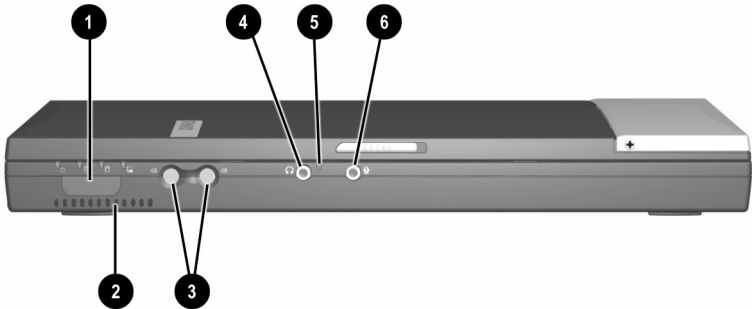

Identifying front panel components

<p>❶ Infrared port</p>	<p>Links another IrDA-compliant device for wireless communication.</p>
<p>❷ Intake vent</p>	<p>Allows airflow to cool internal components.</p>
<p>❸ Volume buttons (2)</p>	<p>Adjust system volume. To mute or restore volume, press both volume buttons at the same time.</p>
<p>❹ Stereo speaker/headphone (line-out) jack</p>	<p>Connects optional, powered stereo speakers, headphones, headset, or television audio.</p>
<p>❺ Microphone</p>	<p>Inputs single-channel sound. Can be used whether the notebook is open or closed.</p>
<p>❻ Microphone jack</p>	<p>Connects an optional single-sound channel microphone.</p>

⚠ To prevent overheating, do not obstruct vents. Using the notebook on a soft surface, such as a pillow, rug, or thick clothing, may block airflow.

🔇 Internal speakers are muted when a headphone is connected to the line-out jack.

Rear Panel Components

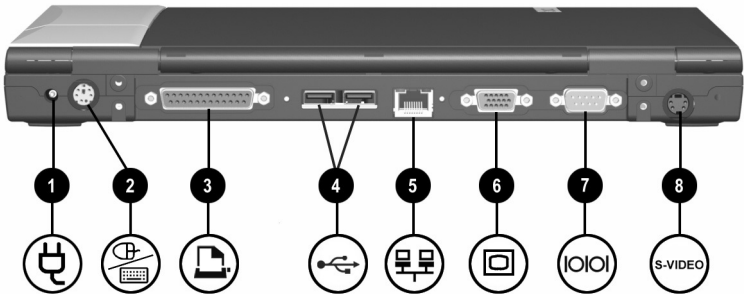

Identifying rear panel components

① DC power connector	Connects an AC Adapter or an optional Automobile Power Adapter/Charger, Aircraft Power Adapter, or DC cable.
② Keyboard/pointing device (PS/2) connector	Connects an optional PS/2 device such as a keyboard or mouse.  To connect a keyboard and a mouse at the same time, use an optional Y-adapter.
③ Parallel connector	Connects an optional parallel device, such as an external diskette drive bay.
④ USB connectors (2)	Connect optional USB devices.
⑤ RJ-45 jack	Connects a network cable.
⑥ External monitor connector	Connects an optional external monitor or overhead projector.
⑦ Serial connector	Connects an optional serial device.
⑧ S-video-out jack	Connects an optional S-video device, such as a television, VCR, camcorder, overhead projector, or video capture card.

Bottom Components

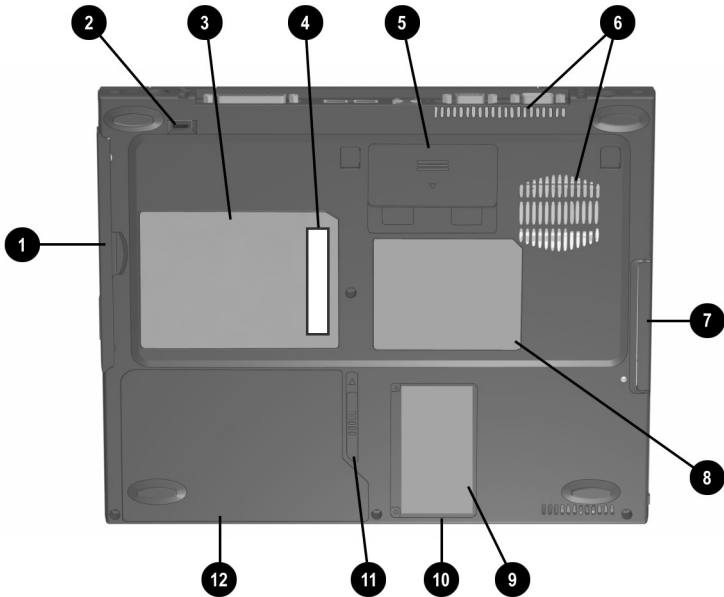

Identifying bottom components





The location of the Certificate of Authenticity label ⑨ may vary by model and configuration.

Bottom Components

① MultiBay recess	Provides a grip area for removing an optional MultiBay device from the MultiBay.
② MultiBay release latch	Releases an optional MultiBay device from the MultiBay.
③ System label	Provides regulatory information about the notebook.

Bottom Components (Continued)

4 Serial number	Identifies the notebook.  You may need this number if you call Compaq customer support.
5 Docking restraint latch recess	Helps secure the notebook to a Port Replicator.
6 Intake vents	Provide airflow to cool internal components.  To prevent overheating, do not obstruct vents. Using the notebook on a soft surface, such as a pillow, rug, or thick clothing, may block airflow.
7 Hard drive bay	Secures the primary hard drive in the hard drive bay.
8 Modem agency approvals label	Lists the countries in which the modem has been approved for use.  You will need this information to use the modem while traveling internationally.
9 Certificate of Authenticity label	Contains your Product Key number, which will be needed to update or troubleshoot your operating system.
10 Mini PCI (Peripheral Component Interconnect) compartment	Contains the mini PCI modem card.
11 Battery release latch	Releases the primary battery pack from the battery bay.
12 Battery bay	Holds the primary battery pack.

Additional Standard Components

The components included with the notebook vary by geographical region and the notebook hardware configuration ordered.

The following illustration and table identify the standard external components included with most notebook models.



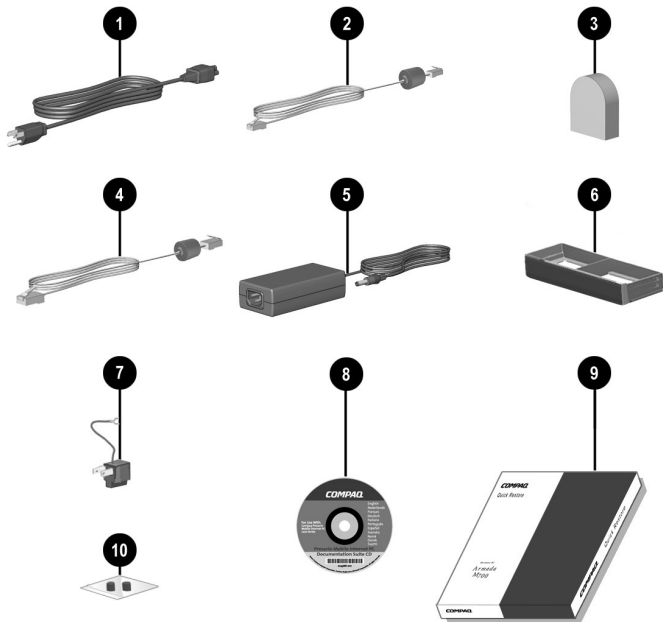

This illustration does not include printed documentation or components such as the hard drive and primary battery pack, which ship inside notebook bays identified in previous sections.



Identifying additional standard components

Additional Standard Components

①	Power cord	Connects the AC Adapter to an AC electrical outlet.
②	Modem cable	Connects the modem to an RJ-11 telephone jack or to a country-specific modem adapter.  The modem cable has a 6-pin RJ-11 connector at each end.
③	Country-specific modem adapter (included with internal modem models by region as required)	Adapts the modem cable to a non-RJ-11 telephone jack.
④	Network cable	Connects the notebook to an Ethernet network jack.  The network cable has an 8-pin RJ-45 connector at each end.
⑤	AC Adapter	Converts AC power to DC power.
⑥	Weight saver	Protects the MultiBay and reduces notebook weight when a MultiBay device is not inserted.
⑦	Japan-specific outlet adapter (Japan only)	Connects the AC Adapter to a 2-prong electrical outlet.

Additional Standard Components (*Continued*)

⑧ <i>Documentation Library CD</i>	Contains the following guides:
	<ul style="list-style-type: none">■ <i>Hardware Guide</i>■ <i>Software Guide</i>■ <i>Modem and Networking</i>■ <i>Modem Command Guidelines (Advanced Users Only)</i>■ <i>Maintenance, Shipping and Travel</i>■ <i>Troubleshooting</i>■ <i>Regulatory and Safety Notices</i>■ <i>Safety & Comfort Guide</i>
⑨ <i>QuickRestore kit</i>	Contains the software preinstalled on the notebook.
⑩ Bag containing 2 spare pointing stick caps (pointing stick and dual pointing device models only)	Replace worn pointing stick cap.

How to Get Information, Help and Updates

Using the *Documentation Library CD*

Included with the notebook is the *Documentation Library CD*, which contains detailed information and instructions for using your notebook:

- *Hardware Guide*—Contains information specific to your notebook. It includes an illustrated reference to all exterior components and detailed steps for replacing battery packs, using keyboard features and drives, connecting external equipment, and upgrading the notebook.
- Feature guides on these topics:
 - ❑ *Software Guide*—describes Compaq software, including details about power and security features.
 - ❑ *Modem and Networking* guide—provides details about modem connections and equipment.
 - ❑ *Modem Command Guidelines (Advanced Users Only)*—contains modem commands and programming information.
 - ❑ *Maintenance, Shipping and Travel* guide—details steps for notebook maintenance and guidelines for using the notebook internationally.
 - ❑ *Troubleshooting* guide—includes solutions for common problems encountered by users.

- *Regulatory and Safety Notices*—includes governmental agency information.
- *Safety & Comfort Guide*—describes the best ways to set up a safe and comfortable work environment, including ergonomic and safety information.

Viewing Guides on the CD

To view a guide:

1. Insert the *Documentation Library* CD into the CD drive.
 - ❑ If autorun is enabled, the reference library menu will appear on the screen (this may take a few seconds). If autorun is enabled, go to step 2.
 - ❑ If autorun is disabled, select Start > Run. Type:
X:\CompaqPortable.exe
(where X is your CD drive designation), then select the OK button.
2. Select the guide you want to read from the reference library menu.
3. If prompted, accept the Adobe Acrobat Reader license agreement or install Acrobat Reader by following the instructions on the screen.

Contacting Technical Support

If you cannot solve a problem using the documentation provided with the notebook, you may need to call technical support. Refer to *Worldwide Telephone Numbers* booklet included with the notebook, for the phone number of a Compaq office near you, or visit:

<http://www.compaq.com>

To receive the fastest possible solution, have the following information or items available when you call:

- The notebook.
- Serial number and model description on the bottom of the notebook. (See Chapter 2, “A Look at the Notebook” for the location of the serial number label.)
- Purchase date on your invoice.
- Conditions under which the problem occurred.
- Error messages that have displayed.
- Type of printer connected.
- Operating system version number and registration number. To view these numbers, access the Control Panel > System > General tab.
- Configuration or diagnostic information. Refer on the *Documentation Library* CD to the *Software Guide*, “Computer Setup and Diagnostics Utilities” chapter for details about accessing, saving, or printing this information.
- Determine the version of the system ROM installed on the notebook. See “Displaying ROM Information in Computer Setup” for instructions.

Updating Compaq Software

For optimal notebook performance and to make sure your notebook remains compatible with changing technologies, Compaq recommends that you install the latest versions of Compaq software as they become available.

To update Compaq software:

1. Obtain the *Compaq Support Software CD*.
2. Download software updates from the Compaq Web site.
Prepare for any software update by identifying your notebook type, series or family, and model. Prepare for a system ROM update by identifying the ROM version currently installed on the notebook.



The notebook system ROM (Read Only Memory) stores the BIOS (Basic Input Output System). The BIOS determines how the notebook hardware interacts with the operating system and external devices and also supports such notebook services as time and date.



If your notebook connects to a network, Compaq recommends that you consult with your Network Administrator before installing any software updates, especially system ROM updates.

Obtaining the *Compaq Support Software CD*

The *Compaq Support Software CD* provides the latest Compaq software and instructions for installing and using it. The CD includes device drivers, ROM updates, and utilities.

To purchase the current *Compaq Support Software CD* or a subscription that provides both the current version and future versions of the CD, refer to the *Worldwide Telephone Numbers* booklet, included with the notebook, to contact a Compaq authorized dealer, reseller, or service provider.

Preparing to Update Software

To access software updates from the Compaq Web site, the following information will be needed:

- The product *category* is Notebook.
- The product *family* name and *series* number are printed in the lower left corner of the display bezel.
- More complete *model* information is provided on the serial number label on the bottom of the notebook.

To determine whether available ROM updates contain later ROM versions than those currently installed on the notebook, you will need to know the version of the system ROM currently installed.

ROM version information can be displayed by pressing **Fn+esc** or by accessing Compaq Computer Setup.

Displaying ROM Information in Computer Setup

Computer Setup is a non-Windows utility. For general information about using Computer Setup, refer to the “Setup and Diagnostics Utilities” chapter in the *Software Guide* on the *Documentation Library* CD included with the notebook.

To display ROM information in Computer Setup:

1. To open Computer Setup, turn on or restart the notebook. Press **F10** while the F10 = ROM Based Setup message is displayed in the lower left of the screen.
 - ❑ To change the language, press **F2**.
 - ❑ For navigation instructions, press **F1**.
2. Select the File menu > System Information. The system ROM information is displayed.
3. To exit Computer Setup without changing any settings, use the arrow keys to select File > Ignore Changes and Exit, then follow the instructions on the screen. After Computer Setup closes, the notebook restarts in Windows.

Downloading Software from Compaq

Most software at the Compaq Web site is packaged in a compressed file called a *SoftPaq*[™]. Some ROM updates may be packaged in a compressed file called a *RomPaq*[™]. Other ROM updates may be provided as a CPQFlash SoftPaq.

Most download packages contain a file named Readme.txt. A Readme.txt file contains information regarding installing and troubleshooting the file. The Readme.txt files included with ROMPaqs are English only.

Downloading System ROM



CAUTION: To prevent an unsuccessful installation, download and install the system ROM only while the notebook is connected to reliable external power using the AC Adapter. Do not download or install a system ROM while the notebook is running on battery power, docked in an optional Port Replicator, or connected to an optional power source. During the download and installation:

- Do not unplug the notebook from the electrical outlet.
- Do not shut down the notebook.
- Do not remove or insert a drive.

To download and install a system ROM:

1. Access the page at the Compaq Web site that provides software for your notebook. For home and small office products or corporate products, visit:
<http://www.compaq.com/support>
2. Follow the instructions on the screen to locate the system ROM you want to download.
3. At the download area:
 - a. Write down the information (date and name) of any update that is later than the system ROM currently installed on your notebook.
 - b. Select the software you want and follow the downloading instructions on the Web page.
4. When the download is complete, open Windows Explorer.
5. In Windows Explorer, select My Computer > the hard drive designation (usually, drive C) > Compaq.

6. In the Compaq folder, select the name or number of the software package containing the system ROM update. The system ROM installation begins.
7. To complete the installation, follow the instructions on the screen.



After a message on the screen reports a successful installation, you can delete the download package from the Compaq folder.

Downloading Other SoftPaqs

To update other SoftPaqs:

1. Access the page at the Compaq Web site that provides software for your notebook.
<http://www.compaq.com/support>
2. Follow the instructions on the screen to find the software you want to update.
3. At the download area, select the software you want and follow the downloading instructions on the Web page.
4. When the download is complete, open Windows Explorer.
5. In Windows Explorer, select My Computer > the hard drive designation (usually, drive C) > Compaq.
6. In the Compaq folder, select the name or number of the software package containing the update.
7. Select the file that includes an .exe extension, for example, Filename.exe. The installation begins.
8. To complete the installation, follow the instructions on the screen.



After a message on the screen reports a successful installation, you can delete the download package from the Compaq folder.

Restoring Software

The *QuickRestore* kit included with the notebook provides all the software that shipped preinstalled or preloaded on your notebook and instructions for restoring it.

You can use *QuickRestore* to install or reinstall individual software items, such as applications, or to restore the entire notebook factory image. The factory image is the original software on your notebook when it was shipped.

When you restore to the factory image:

- The notebook reverts to the original factory settings.
- Software you installed after the initial software setup, including drivers, applications, or utilities, will be erased.

For information about using a *QuickRestore* CD to start up the notebook, refer to the documentation included with the *QuickRestore* kit.



CAUTION: To prevent an unsuccessful restoration, use *QuickRestore* only while the notebook is connected to reliable external power using the AC Adapter. Do not use *QuickRestore* while the notebook is running on battery power, docked in an optional Port Replicator, or connected to an optional power source. During a restoration or installation:

- Do not unplug the notebook from the electrical outlet.
 - Do not shut down the notebook.
 - Do not remove or insert a drive.
-

Installing a Retail Version of an Operating System

A Windows operating system provided on the notebook or on a *QuickRestore* CD is enhanced by Compaq. The Compaq enhancements add power and security features and provide supplementary support for external devices such as drives and PC Cards.



CAUTION: Replacing an operating system enhanced by Compaq with a retail version of an operating system will result in the loss of all Compaq enhancements. In some cases, the loss of these enhancements may result in an unresponsive system. In other cases, complete USB support may become unavailable.

Index

A

- AC Adapter
 - connecting 1–2
 - function of 2–16
- adapter
 - for AC power cord. *See* AC Adapter
- Adobe Acrobat Reader 3–2
- Aircraft Power Adapter (optional) 2–12
- application key 2–8
- AT commands 3–1
- Automobile Power Adapter/Charger (optional) 2–12

B

- battery bay
 - device supported 2–14
 - release latch 2–14
- battery light 1–3, 2–7
- battery packs
 - charging 1–3
 - MultiBay (optional), replacing with weight saver 2–16
- battery release latch 2–14
- buttons
 - standby 2–8
 - volume 2–11
 - See also* key; latch; switch

C

- cable
 - AC Adapter 1–2
 - DC 2–12
 - modem 2–16
 - modem vs. network 2–16
 - network 2–16
- cap, replacing pointing stick 2–17
- caps lock light 2–7
- CD
 - Compaq Support Software CD* 3–5
 - Documentation Library* 3–1
 - QuickRestore* kit 3–9
- CD drive (optional) 2–7
- Certificate of Authenticity label 1–4
- commands, modem 3–1
- Compaq Help and Support 1–6
- Compaq Support Software CD* 3–5
- Compaq telephone numbers 3–3
- Compaq Web site
 - accessing 1–6
 - obtaining worldwide telephone numbers from 3–3
 - updating software from 3–4
- compartment
 - memory expansion 2–5
 - mini PCI 2–14

Computer Setup
 displaying ROM information
 with 3-6

connectors
 DC power 1-2, 2-12
 external monitor 2-12
 keyboard/pointing device 2-12
 keyboard/pointing device
 (PS/2) 2-12
 parallel 2-12
 serial 2-12
 See also jack

cord. *See* connectors

country-specific modem adapter
 2-16

CPQFlash file 3-6

customer support 3-3

D

DC cable 2-12

DC power connector
 connecting AC Adapter to 1-2
 devices supported 2-12

diskette drive light 2-7

display release latch 2-8

display switch
 default function 2-8
 identifying 2-8

display, internal
 closing 2-8
 opening 1-2

docking base (optional)
 using during initial setup 1-1

Documentation Library CD
 documents provided 2-17
 viewing 3-2

drives
 diskette drive light 2-7
 IDE drive light 2-7
 replacing with weight saver
 2-16

DVD drive (optional) 2-7

E

EasyPoint IV 3D Pointing Stick.
 See pointing device

electrostatic discharge 3-2

ergonomic information 1-6

external diskette drive bay
 (optional) 2-7

external monitor connector 2-12

F

family, identifying notebook 3-5

FCC (Federal Communications
 Commision) 1-6

H

hard drive 2-7

hard drive bay 2-7

Hardware Guide 3-1

help
 accessing Compaq support 1-6

helpline 3-3

Hibernation
 defined 1-7
 enabling 1-7

I

IDE (Integrated Drive Electronics)
 light 2-7

identifying components
 bottom 2-13
 front panel 2-11

- left side 2–9
- pointing device (dual pointing stick/TouchPad models) 2–4
- pointing device (pointing stick models) 2–2
- pointing device (TouchPad models) 2–3
- rear panel 2–12
- right side 2–10
- shipped with computer 2–15
- top (buttons, keys, and switches) 2–8
- top (lights) 2–6
- top (speakers and memory compartment) 2–5

J

- jack
 - S-video 2–12
 - See also* connectors
- Japan-specific outlet adapter 2–16

K

- key
 - Microsoft logo 2–8
 - Windows application 2–8
 - See also* buttons; latch; switch
- keyboard/pointing device (PS/2) connector
 - identifying 2–12

L

- label
 - Certificate of Authenticity 1–4
 - modem agency approvals 2–14
 - serial number 2–14
 - system 2–13

- language, choosing
 - during initial setup 1–4
- latch
 - battery release 2–14
 - display release 1–2
 - MultiBay release 2–13
 - See also* buttons; key; switch

light

- battery 1–3, 2–7
- caps lock 2–7
- diskette drive 2–7
- IDE drive 2–7
- num lock 2–7
- power/standby 1–3, 2–7
- scroll lock 2–7

M

- Maintenance, Shipping and Travel guide* 3–1
- manuals. *See* Documentation Library CD
- Microsoft logo key 2–8
- mini PCI (Peripheral Component Interconnect) compartment 2–14
- model, identifying notebook 3–5
- modem
 - cable 2–16
 - card 2–14
 - commands 3–1
 - compartment 2–14
 - country-specific, adapter 2–16
 - modem agency approvals label 2–14
 - Modem and Networking guide* 3–1
 - Modem Command Guidelines (Advanced Users Only)* 3–1

monitor, external (optional) 2–12

MultiBay

- diskette drive light 2–7
- IDE drive light 2–7
- release latch 2–13
- using weight saver in 2–16

N

network

- cable 2–16

notebook model, family, type 3–5

num lock light 2–7

O

opening the computer 1–2

operating system

- choosing, during initial setup 1–4
- enhanced by Compaq 1–4
- installing retail version of 3–10
- Product Key number 2–14
- reinstalling 3–9

overhead projector (optional)

- connector 2–12

P

parallel connector

- identifying 2–12

phone numbers, worldwide 3–3

pointing device

- replacing pointing stick cap 2–17

power connector, DC

- connecting AC Adapter 1–2
- devices supported 2–12

power cord 1–2, 2–15

power switch

- default functions 2–8
- turning on the computer with 1–3

power/standby light 2–7

problems and solutions

- addressed in *Troubleshooting* guide 3–1

Product Key number 2–14

PS/2 connector. *See*

- keyboard/pointing device (PS/2) connector

Q

QuickRestore kit 2–17, 3–9

R

Regulatory and Safety Notices 3–2

regulatory information

- modem agency approvals label 2–13

Regulatory and Safety Notices

- 1–6
- system label 2–13

reinstalling software 3–9

RJ-11 jack

- modem cable 2–16

RJ-45 jack

- network cable 2–16

ROM. *See* system ROM (Read

- Only Memory)

RomPaq

- defined 3–6
- downloading and installing 3–7

S

S (Status) registers 3–1
Safety & Comfort Guide 3–2
scroll lock light 2–7
serial connector
 identifying 2–12
serial number label 2–14
series, identifying notebook 3–5
Setup Compaq Software icon 1–5
SoftPaq
 defined 3–6
 downloading and installing 3–6
software
 Adobe Acrobat Reader 3–2
 Compaq Support Software CD
 subscription 3–5
 determining notebook model,
 family, type 3–5
 installing 1–4
 QuickRestore kit 2–17
 reinstalling 3–9
 setting up 1–4
 Setup Compaq Software icon
 1–5
 Software Guide 2–17
 See also operating system
 See also software updates
Software Guide 3–1
software updates
 downloading from Compaq
 3–6
standby button
 default functions 2–8
SuperDisk drive (optional) 2–7

support

 accessing Compaq Help and
 Support 1–6
S-video jack 2–12
switch
 display 2–8
 power 1–3, 2–8
 See also buttons; key; latch
system information, obtaining 3–3
system label 2–13
system ROM (Read Only
 Memory)
 defined 3–4
 determining current version of
 3–5
 downloading and installing 3–7

T

technical support 3–3
telephone numbers, worldwide
 3–3
Troubleshooting guide 3–1
turning the computer on and off
 1–3, 2–8

U

user guides. *See Documentation
Library CD*
utilities, Compaq
 QuickRestore kit 2–17
 viewing descriptions of 1–5

V

vents
 exhaust 2–9
 intake 2–14
volume, adjusting 2–11

W

- weight saver 2–16
- Windows application key 2–8
- worldwide telephone numbers 3–3

Z

- Zip drive (optional) 2–7

Free Manuals Download Website

<http://myh66.com>

<http://usermanuals.us>

<http://www.somanuals.com>

<http://www.4manuals.cc>

<http://www.manual-lib.com>

<http://www.404manual.com>

<http://www.luxmanual.com>

<http://aubethermostatmanual.com>

Golf course search by state

<http://golfingnear.com>

Email search by domain

<http://emailbydomain.com>

Auto manuals search

<http://auto.somanuals.com>

TV manuals search

<http://tv.somanuals.com>