

# **COMPAQ**

## **1400P** *Color Inkjet Printer*

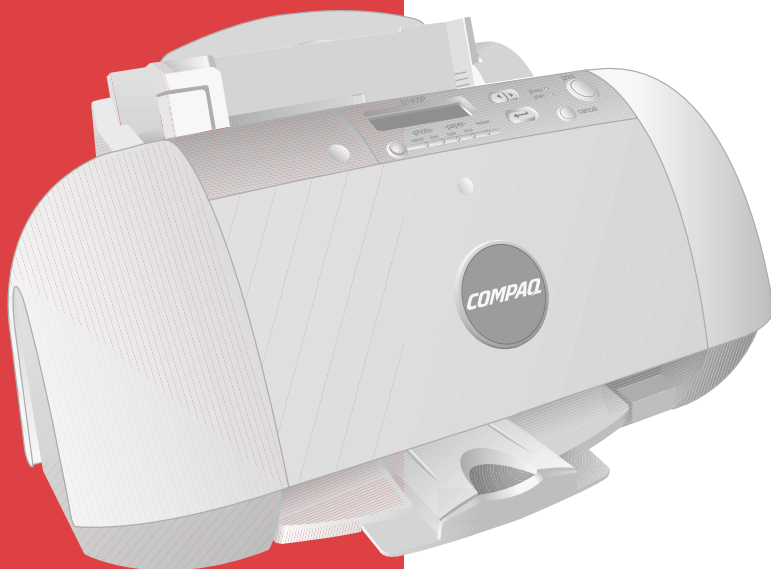

### ***Getting Started Guide***

# Notice

- Copyright 2001 Compaq Computer Corporation

COMPAQ and the Compaq logo Registered in U.S. Patent and Trademark Office. Microsoft and Windows are trademarks of Microsoft Corporation.

All other product names mentioned herein may be trademarks or registered trademarks of their respective companies.

Compaq shall not be liable for technical or editorial errors or omissions contained herein. The information in this document is subject to change without notice.

THE INFORMATION IN THIS PUBLICATION IS SUBJECT TO CHANGE WITHOUT NOTICE AND IS PROVIDED "AS IS" WITHOUT WARRANTY OF ANY KIND. THE ENTIRE RISK ARISING OUT OF THE USE OF THIS INFORMATION REMAINS WITH RECIPIENT. IN NO EVENT SHALL COMPAQ BE LIABLE FOR ANY DIRECT, CONSEQUENTIAL, INCIDENTAL, SPECIAL, PUNITIVE OR OTHER DAMAGES WHATSOEVER (INCLUDING WITHOUT LIMITATION, DAMAGES FOR LOSS OF BUSINESS PROFITS, BUSINESS INTERRUPTION OR LOSS OF BUSINESS INFORMATION), EVEN IF COMPAQ HAS BEEN ADVISED OF THE POSSIBILITY OF SUCH DAMAGES. THE FOREGOING SHALL APPLY REGARDLESS OF THE NEGLIGENCE OR OTHER FAULT OF EITHER PARTY AND REGARDLESS OF WHETHER SUCH LIABILITY SOUNDS IN CONTRACT, NEGLIGENCE, TORT, OR ANY OTHER THEORY OF LEGAL LIABILITY, AND NOTWITHSTANDING ANY FAILURE OF ESSENTIAL PURPOSE OF ANY LIMITED REMEDY.

The limited warranties for Compaq products are exclusively set forth in the documentation accompanying such products. Nothing herein should be construed as constituting a further or additional warranty.

Compaq 1400P  
First Edition (August 2001)

# Getting Started Guide

Thank you for purchasing a Compaq 1400P color inkjet printer! Your new printer is an excellent choice for your everyday printing needs, yet it is also capable of printing your high resolution digital photos directly from your camera's memory card.

This booklet guides you step by step from setup through printing your first document or digital photo.

See page 24 for information about contacting Compaq and locating your printer warranty.

## Setup

To setup your printer, follow these easy steps.

### Step 1: Check the printer parts

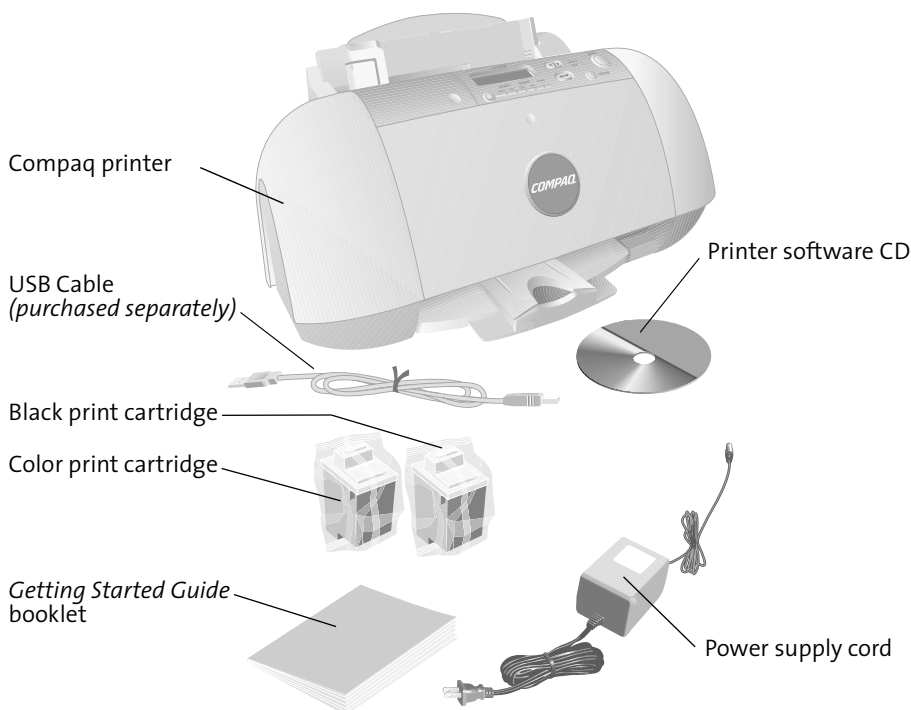

## Step 2: Load up to 100 sheets of plain paper

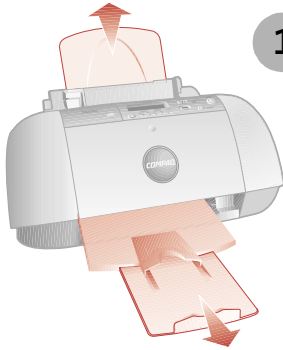

**1** Make sure you fully extend the paper supports.

**2** You can use many different types and sizes of paper.

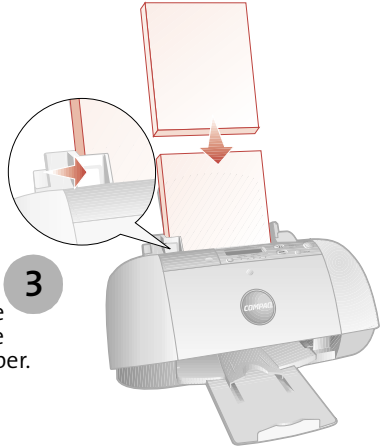

To avoid paper misfeeds, slide the paper guide to the left side of the paper.

**3**

## Step 3: Connect the power supply



**1**

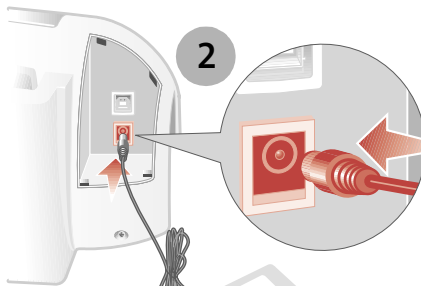

**2**

**3**

## Step 4: Select your language

When the power is connected, the printer will ask you to select your language. Press the **Enter** button to confirm you would like to set the language, and then use the **Up** and **Down** arrow buttons to find the language you wish to use for the LCD panel. Once you have found your language, press **Enter** to select it.

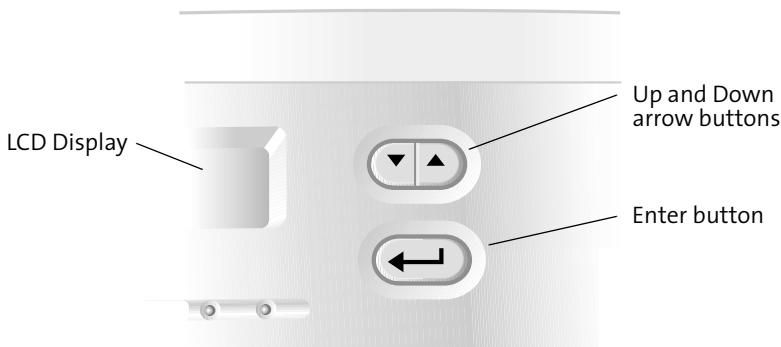

Note that the printer will only ask you to set the language on the very first time the printer is powered up. If you wish to select a different language at a later time, press the **Setup** button repeatedly until you find the language menu. See “Control Panel Features” on page 10 for the location of the **Setup** button.

## Step 5: Install the print cartridges

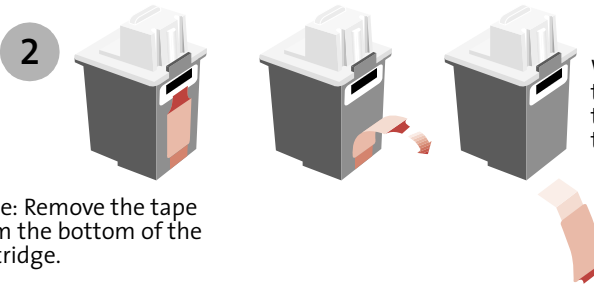
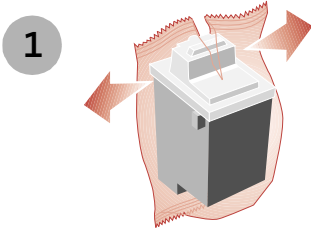

Warning: Do **not** touch the gold contact areas on the back and bottom of the print cartridges.

Note: Remove the tape from the bottom of the cartridge.

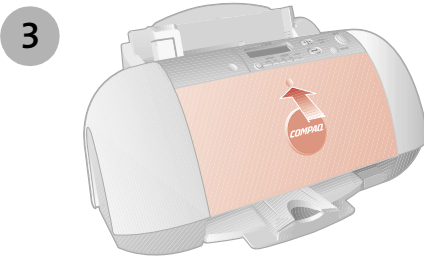

First, push gently at the top of the front cover to release the latch, then pull the cover toward you to open it.

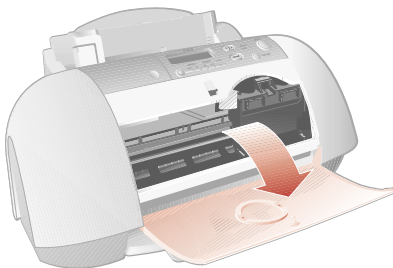

Note: The cartridge carrier moves to the loading position when you open the front cover.

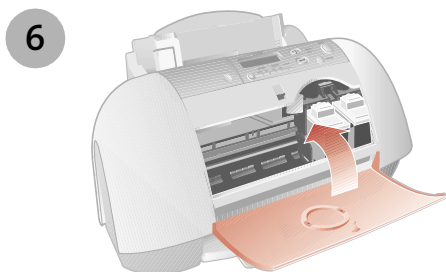
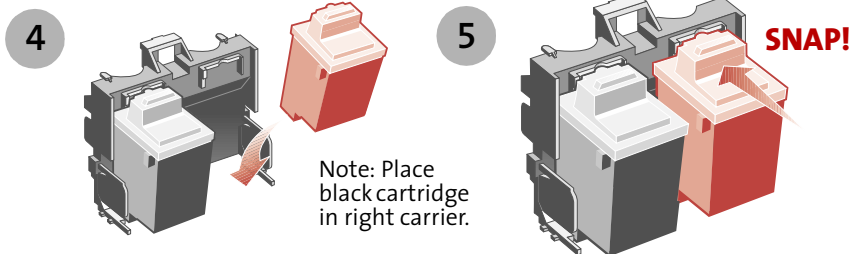

## Step 6: Align the cartridges

After installing the print cartridges and closing the cover, an alignment page will be automatically printed. From each alignment group on the alignment page, find the number under the alignment pattern that comes closest to forming a straight line.

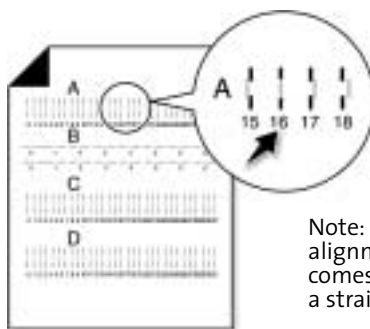

Note: In this example for alignment group A, 16 comes closest to forming a straight line.

Using the same **Up**, **Down** and **Enter** buttons used in step 4, change the value for the letter displayed on the printer LCD, and then press Enter to select it. The next alignment letter will be shown until you have set all the alignment values for the page.

## Step 7: Connect the USB cable

The Compaq 1400P can print photos directly from your digital camera memory card without the use of a PC (see “Printing directly from a memory card” on page 9). However, you can maximize the value of your printer by attaching it to your PC and installing the printer software.

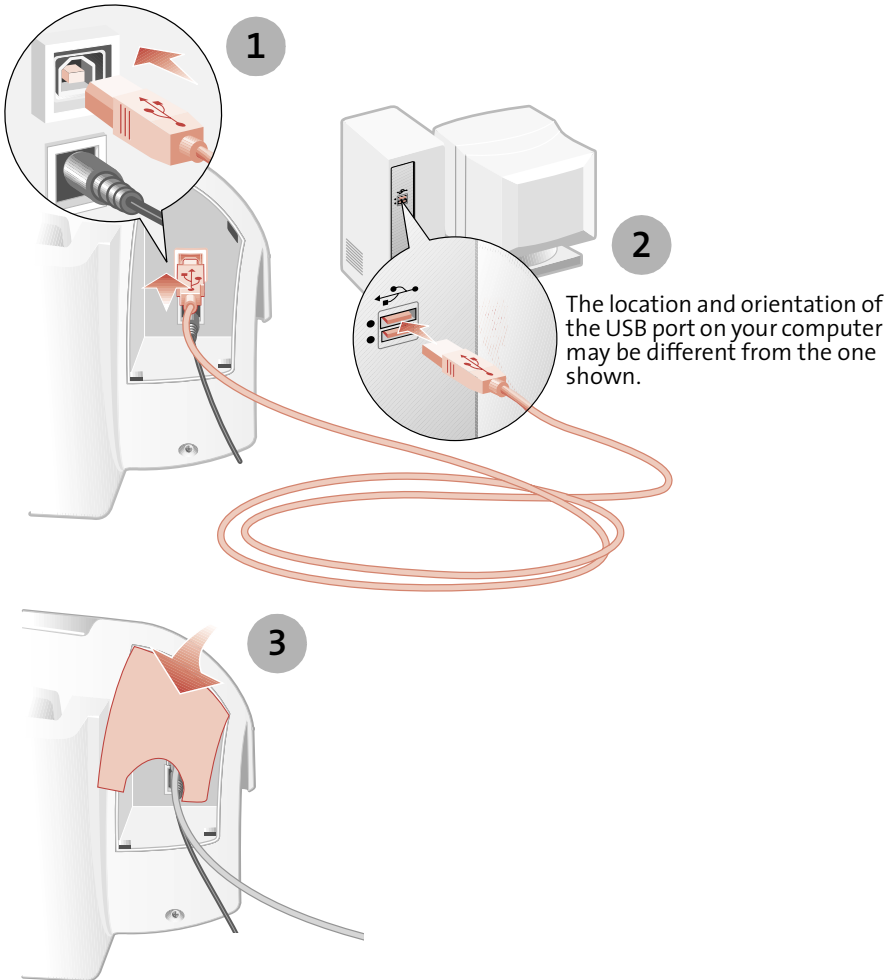



## Step 8: Install the printer software

If your computer is not already on, please turn it on now.

1

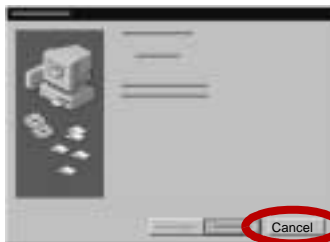

Click **Cancel** on any screens similar to the one shown.

2

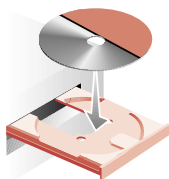

3

Wait for the Compaq printer software installation screen shown in ❶ to appear. If it doesn't, see page 21.

4



Click **Next** and follow the instructions until the installation is complete.

## *Congratulations!*

You have finished setting up your printer.



# Printing

There are two ways you can print using your Compaq 1400P:

- > Print photos directly from your memory card -- no PC required
- > Print from an application using your computer

Either way, your Compaq 1400P will deliver excellent results.

## Printing directly from a memory card

The Compaq 1400P is equipped with a CompactFlash slot which enables you to print your photos without the use of a PC. Most digital cameras store their photos on a memory card. Once you have taken some photos, you can remove the memory card from your camera and place it directly into the CompactFlash slot on your printer for quick and easy prints.

## Supported cards

The Compaq 1400P supports the following types of memory cards:

- > CompactFlash certified Type I or Type II
- > SmartMedia, using an optional adapter (purchased separately)

These cards are available from several different vendors.

## Inserting a memory card

The memory card slot is located beneath a small door.

1

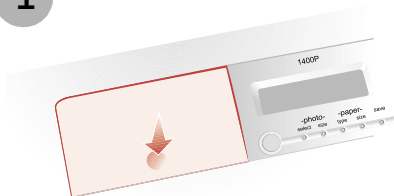

Push down gently at the bottom of the door to release the latch.

2

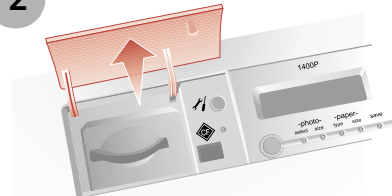

Lift up on the door to reveal the card slot.

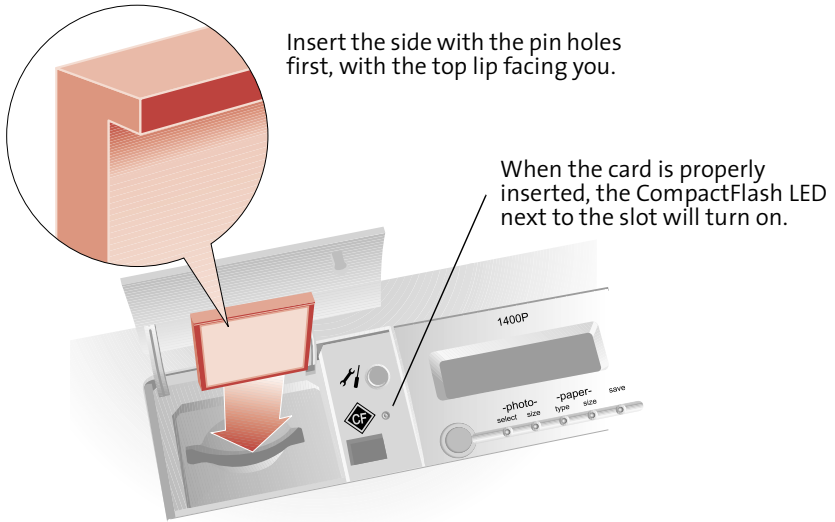

**WARNING:** Never remove the memory card when the CompactFlash light is flashing, or you could damage the card.

Once the card has been properly inserted, the LCD will display the number of photos found on the card.

## Control Panel Features

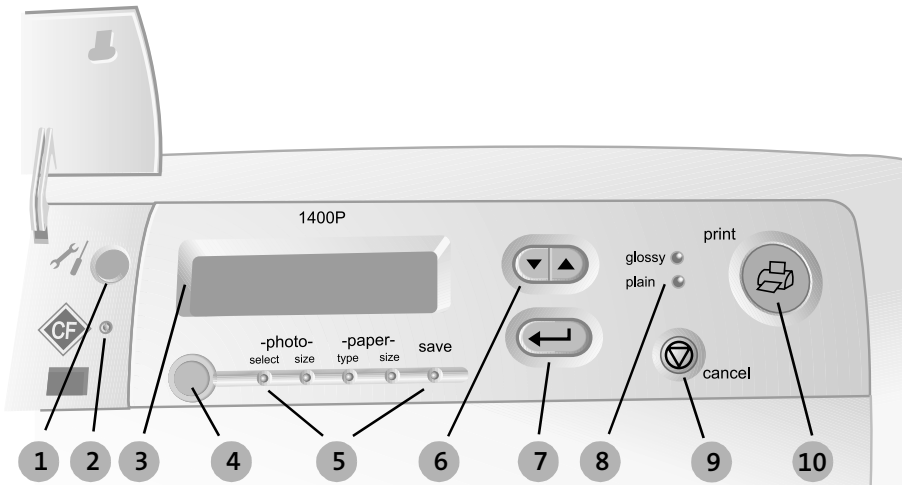

#	Button/Light	Description
1	Setup	Provides access to the system setup menu. Use this button to cycle through all setup menus, and the Up/Down buttons to change the settings.
2	Card Access Light	Turns on when a CompactFlash card is properly inserted. It also flashes when the card is being accessed.
3	LCD Display	Displays menus and status messages.
4	Menu	Selects one of the menus (photo select, photo size, etc.) once a card has been inserted.
5	Settings Lights	Indicates which settings menu is active.
6	Up/Down Arrows	Use to change the setting while in a menu.
7	Enter	Confirms current setting value.
8	Paper Lights	Indicates paper type selected.
9	Cancel	Cancels current menu or print job.
10	Print	Starts a print job, or form feeds the paper.

## Setup

The **Setup** button is located under the memory card door at the left of the control panel. Press the **Setup** button if you want to:

- ▶ **Clean your printer cartridges.** If you notice white lines or missing colors in your prints, select this option to try and clean the cartridges.
- ▶ **Align your printer cartridges.** If you change print cartridges, you will want to align them for optimal printing.
- ▶ **Set the photo cropping.** Control whether the full image is printed, or whether it is cropped to the exact photo size selected. See the section, “About Photo Cropping” on page 12.
- ▶ **Set the measuring units.** By default, the printer shows units in inches. If you prefer metric, you can change the units to centimeters.
- ▶ **Set the language.** Choose your preferred language for the printer menus.

**Note:** In all of the menus, an asterisk (\*) is used to indicate your current selection.

## About Photo Cropping

When the printer scales a photo to your selected photo size, it attempts to find the best fit possible without omitting any part of the original photo. Depending on the photo, this means it might not fill up the entire selected size in both directions.

If you prefer that the photo is the exact size you selected (for example, 4x6"), then the photo can be cropped. This removes a small part of the photo. Incidentally, it is what a traditional photo processor does when enlarging your prints. The photo will fill the photo size to all four sides.



**No Cropping.** The full photo is printed, but it does not fill the entire photo size. This is the printer default.



**Cropping.** Fills the photo size, but some of the original photo must be cropped (in this case, on the left and right).

## About DPOF

DPOF (Digital Print Order Format) is a standard adopted by many digital camera manufacturers. It allows you to mark photos for printing using your digital camera (check your camera's documentation to determine if it supports DPOF). The 1400P can then read the DPOF file to determine which photos to print or save, so you don't have to print an index or select photos on the printer.

## Printing your photos

Once you have placed your memory card in the card slot, it takes only a few steps to print your photos.

### Step 1: Print an index

The first thing you will want to do is print an index (unless you are using DPOF, in which case you can proceed to Step 3).

When a memory card is placed in the card slot, the printer is ready to print an index...simply press the **Print** button. If you have changed any of the settings (or you are unsure), you can always remove the card and reinsert it, then press **Print**.

The index may be several pages long, depending on the number of photos contained on your card (each index page shows up to 25 photos). The index number, filename, date, and time are shown beneath each index photo.

You will use the index number to select the photos you wish to print. If you add or delete photos later, you will need to reprint the index page to see the new index numbers.

### Step 2: Select the photos to print

Press the **Menu** button to access the Photo Select menu. By default, all photos are selected (or all DPOF photos, if a DPOF file is present). If you don't want to print all the photos, use the following method to select individual photos:

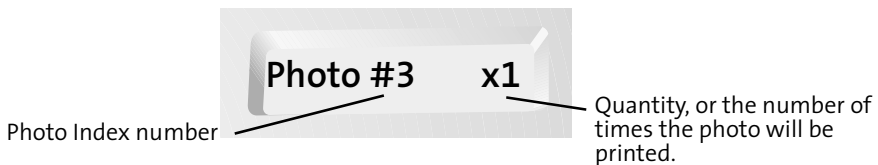

- 1 Press the **Up** and **Down** arrow buttons to find the index number of the photo you wish to print.
- 2 Press the **Enter** button to select the photo.
- 3 The quantity will start to blink...use the **Up** and **Down** arrows to increase or decrease the number of times you want the photo to be printed, from 0-9.
- 4 Press the **Enter** button to select the quantity.

Repeat the above steps until you have selected all your photos.

## Step 3: Select the photo size

Press the **Menu** button to move from the Photo Select menu to the Photo Size menu. Use the **Up** and **Down** arrow buttons to find a photo size, and the **Enter** button to select it.

The Compaq 1400P saves paper by fitting as many photos on a page as possible. The table below lists the paper sizes and the number of photos per page for each photo size.

Paper	Index	2.5x3" 6x8cm	3.5x5" 9x13cm	4x6" 10x15cm	5x7" 13x18cm	8x10" 20x25cm
Letter, A4	25	9	4	2	2	1
A5	9	4	1	1	1	-
A6, 4x6	4	2	1	1	-	-
Hagaki	4	2	1	1	-	-

**Note:** Some photos may be turned sideways to fit on the page.

## Step 4: Select the paper type

Press the **Menu** button to move from the Photo Size menu to the Paper Type menu. The LCD will display the currently selected paper type. If this is incorrect, use the **Up** and **Down** arrow buttons to find the correct paper type, and the **Enter** button to select it. There are two paper types available: Plain and Glossy.

For easy reference, the Paper Lights (located next to the **Print** button) show the current paper type selected. Make sure your selection matches the type of paper you have loaded into the printer.

## Step 5: Select the paper size

Press the **Menu** button to move from the Paper Type menu to the Paper Size menu. The LCD will display the currently selected paper size. If this is incorrect, use the **Up** and **Down** arrow buttons to find the correct paper size, and the **Enter** button to select it.

The Compaq 1400P supports many sizes of paper, as shown in the table above. Select the paper size you have loaded into the printer.



## Step 6: Print!

You have made all of the necessary selections. To print your photos, simply press the **Print** button.

If you would like to review your selections first, repeatedly press the **Menu** button to return to the previous menus. Each menu will show your selection, each indicated by an asterisk (\*). When you have completed your review and you are ready to print, press the **Print** button.

As each photo is processed, the LCD will display the printer's progress. Depending on the number of photos and the photo size selected, several photos may be processed before actually beginning to print the page.

# Printing using your computer

Although the Compaq 1400P will print photo quality images, it is also an excellent everyday printer.

## Basic printing

Basic printing is as easy as:

- 1 Load the paper.
- 2 Open the file you want to print.
- 3 Customize the printer settings. (For help, see the section below, “Using the printer software.”)
- 4 Print your document.

## Using the printer software

Use the Printer Properties (or Printing Preferences) to customize settings so your document prints the way you want it. There are several ways to access your Printer Properties:

- > From the Start menu, click **Programs ▶ Compaq 1400P ▶ Compaq 1400P Properties**.
- > From the Start menu, click **Settings ▶ Printers**. From the Printers folder, **right-click** on the Compaq 1400P icon and select **Properties**.
- > From your software application, click **File ▶ Print ▶ Properties**.

For example, to print the first page of the Getting Started Guide:

- 1 Load plain paper. For help, see page 2.
- 2 From the Start menu on your desktop, click **Programs ▶ Compaq 1400P ▶ Compaq 1400P Getting Started Guide**.
- 3 From the Guide, click **File ▶ Print ▶ Properties**
  - a From the Quality/Color tab, drag the Print Quality slider to the left to print *quickly*, but in *lower quality*.

Note: Selecting a higher Quality/Speed setting results in better print quality, but your documents may take longer to print.

- b To learn more:
  - > Explore the other tabs in the Printer Properties.
  - > Explore the menus.
  - > Click **Help** to view the printer software Help. From the **File** menu, click **Exit** when you are finished viewing the Help.
- c Click **OK** to apply the settings and close the Printer Properties.
- 4 In the Print Range area of the Print dialog box, select **Current Page**.
- 5 Click **OK** to print the current page of the Getting Started Guide.

## Printing photos

To print the best looking photos:

- 1 Use photo paper. We recommend Compaq Inkjet Photo-Glossy Media.
- 2 In Printer Properties:
  - > Select the Glossy paper type, if you are using glossy paper.
  - > Select the Color Photo icon.
  - > Choose a print quality of 1200x1200 dpi or higher.
- 3 Close Printer Properties and print.
- 4 Using photo paper and an optional photo cartridge will provide superior prints, but it is not required to get great looking photos from your 1400P.

## Printing envelopes

To print on envelopes:

- 1 Load up to 10 envelopes vertically, with the print side facing you.
- 2 Adjust the paper guide so it is against the side of the envelopes.
- 3 The stamp location is in the upper-left corner.
- 4 Select the envelope type from the Paper tab of Printer Properties.
- 5 Close Printer Properties and print.

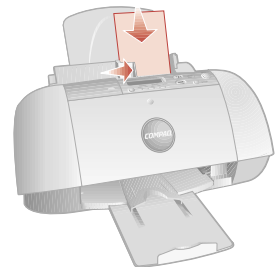

## Printing multiple pages per sheet of paper

You can print two, four, or nine “pages” of your document on a single sheet of paper. This will save you both print time and paper. Explore the **Layout** tab of the Printer Properties for these and many other layout options.

## Printing banners

To print a banner, you should have banner paper and software that supports banner printing.

- > Place the banner paper behind the printer.
- > Bring the unattached edge of the first page over the printer and into the sheet feeder.
- > Place the paper guide against the side of the paper.
- > Select **Banner** or **Banner A4** on the **Paper** tab of the Printer Properties.
- > Print your banner.

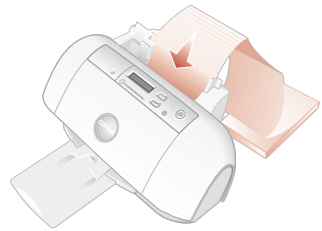

## Printing transparencies

If you have transparency film:

- > Load the transparency so the rough side is facing you (smooth side down).
- > Place the paper guide against the edge of the transparency.
- > Select **Transparency** on the **Paper** tab of Printer Properties.
- > Print your transparency.

## Getting more from your printer

Your printer is capable of printing many types of projects. Create handouts, booklets, posters, and more. Explore the Compaq 1400P Printer Properties for additional features.

Compaq Inkjet Media is specifically engineered to give the best results when used with your Compaq inkjet printer. Compaq Inkjet Media may be purchased at your local retailer or on the internet.

With printing software, you can create greeting cards, iron-on transfers, and many other printing projects. Check the Compaq website periodically for printer activities and ideas.

From the Start menu, simply click **Compaq 1400P** ▶ **Compaq Online**.

# Saving

There are two ways you can save your photos using your Compaq 1400P:

- > Save photos using the Compaq 1400P control panel
- > Save photos using your computer

Both methods require the printer to be attached to your computer. The Compaq 1400P printer software must also be installed. If you have not installed the software yet, See “Install the printer software” on page 7.

## Saving photos using the control panel

You can choose photos on a memory card using the front panel of your printer, then save your photos to your computer. For a list of supported memory cards, and for instructions on inserting the card into the printer, See “Supported cards” on page 9.

Once you have inserted a memory card, follow these steps to save your photos to your PC.

### Step 1: Select photos

Select the photos you want to save. You can save all the photos, or just the photos selected in a DPOF file, or individually selected photos. The selection method is the same as the one you use to print photos. See “Select the photos to print” on page 13.

Note that if you choose to save all photos, then all files on the memory card will be saved to your computer...including non-photo files (such as audio files, etc.).

### Step 2: Select save

To save your selected photos, use the **Save** menu.

- > Press the **Menu** button until the **Save** menu is displayed. The LCD will display “**Save to PC? No**”.
- > Use the **Up** or **Down** arrow buttons to change the selection to **Yes**.
- > Press **Enter** to save your photos.

The PhotoSaver wizard will launch on your computer.

## Step 3: Follow the wizard

If you want to change any of the wizard options, use your mouse to make changes on the wizard screens. If you do not make any selections within thirty seconds, the PhotoSaver wizard will automatically continue with the default options.

By default, your photos will be saved under your **My Pictures** directory, in a new folder created with the current date and time.

## Saving photos using your computer

You can launch the PhotoSaver wizard from your computer, rather than the front panel of the printer.

### Using the PhotoSaver

Use the PhotoSaver wizard to select and save photos. To start the PhotoSaver:

- > From the Start menu, click  
**Programs ▶ Compaq 1400P ▶ Compaq 1400P PhotoSaver.**

and the PhotoSaver wizard will appear:





The PhotoSaver wizard will guide you through the process of selecting and saving your photos to your computer.

# Help

Your printer has been designed for ease of use. There may be occasions when you have questions or need general printing help. This section is designed to answer your most frequently asked questions. For additional help, press the **Help** button on the Printer Properties dialog.

## The installation screen did not appear

- 1 Make sure you click **Cancel** on any screens similar to  in step 8 on page 7.
- 2 Make sure the Compaq printer software CD is in your CD-ROM drive.
- 3 From the desktop, double-click **My Computer**.
- 4 Double-click the CD-ROM drive icon.
- 5 If necessary, double-click **setup.exe**.
- 6 Continue with  in step 8 on page 7.

## The memory card light is blinking

This means the printer is accessing the memory card. Do not remove the card when the light is blinking, or you could damage the memory card.

## The printer isn't working

Try the following:

- > Check the printer cable. Is it securely plugged into the printer and your computer?
- > Check the printer status:
  - a From the Start menu, click **Settings ▶ Printers**.
  - b From the Printers folder, double-click the icon for your printer.
  - c From the Printer menu, make sure:
    - > **Default Printer** is selected.
    - > **Pause Printing** is not selected.
- > If you have connected your printer to a device such as a scanner or fax machine, disconnect the printer from that device and connect the printer directly to your computer.

## Getting Started Guide

- > Check the printer port:
  - a From the File menu of a software application, click **Print** or **Printer Setup**.
  - b In the **Where** area, make sure your printer port is set to USB.
- > Make sure you have not installed multiple copies of the printer software:
  - a From the Start menu, click **Settings** ▶ **Printers**.
  - b In the Printers folder, make sure there is only one icon for your printer.
  - c If you have two printer icons for the same printer, try printing a test page from each icon. Right-click the icon, select Properties, and then click the **Print Test Page...** button. If the test page prints from one icon and not the other, delete the icon for the printer that does not print.

## Uninstalling the software

If there is still a problem, uninstall and then reinstall the printer software:

- 1 From the Start menu, click:  
**Programs** ▶ **Compaq 1400P** ▶ **Uninstall Compaq 1400P**.
- 2 Follow the instructions on your screen.
- 3 To reinstall the printer software, See “Install the printer software” on page 7.

## Printer prints blank pages

Make sure you have removed the transparent tape covering the bottom of the print cartridges. For help, see page 4.

## Paper misfeeds or multiple sheets feed

- > Make sure you are using a paper recommended for inkjet printers.
- > Do not force the paper down into the printer when you load it. Align the top of the paper with the top of the paper support.
- > Do not load too much paper in the sheet feeder. The printer will hold up to 100 sheets of plain printer paper (and less sheets for heavier paper).
- > Adjust the left paper guide so it rests against the left edge of the paper, but not so tight as to bow the paper in the feeder.
- > Make sure the printer is on a flat, level surface.



## Paper Jams

Try removing the paper from the sheet feeder. If the paper is lodged too far into the printer and can't be removed:

- 1 Unplug the power cord from the printer.
- 2 Pull firmly on the paper to remove it. Lower the front cover and pull the paper from the front if necessary.
- 3 Close the front cover.
- 4 Plug the power cord back into the printer to turn it on.
- 5 Print your document again.

## Pages have poor print quality

- > Check the ink level graphic on the Cartridges tab of your Printer Properties. An ink cartridge may be out of ink or low on ink.
- > Check the print quality setting on your Printer Properties. Try a higher or lower quality setting. You may have selected a lower setting which may print lower quality prints or too high of a setting which could smear the ink.
- > Use a different brand of paper. Each brand of paper accepts ink differently and prints with slight color variations. It is recommended that you use Compaq Inkjet Media for the best results.
- > Align and/or clean the print cartridges from the Printer Properties Maintenance tab.
- > Don't use refilled print cartridges. For best results, use Compaq recommended supplies.

## Printing is slow

Printing can be slow for several normal reasons.

- > If you are printing multiple large photos, printing can take longer.
- > Pages with many graphics will print slower than pages with mostly text.
- > High resolutions will take longer to print, such as 2400 x 1200 dpi. Use a lower resolution unless you require very high quality.
- > If you are printing from your PC, try closing any unneeded applications. Your PC may need additional RAM or a higher processor speed.

## Contacting Compaq

Visit our Web site at **www.compaq.com** to:

- > Access publications for your printer.
- > Download software updates.
- > Search for solutions to common problems.
- > Learn new ways to use your printer.
- > Look for special offers and purchase inkjet supplies and media.

To quickly navigate to the Compaq website, click:

**Start ▶ Program Files ▶ Compaq 1400P ▶ Compaq Online.**

## Compaq Warranty Information

### How do I obtain warranty service?

You may access product technical support on Compaq's website at [www.compaq.com](http://www.compaq.com) or you may call Compaq's Technical Support Center. Compaq's highly trained technicians will first try to resolve the problem through our online services or by telephone. If your problems cannot be resolved using these methods, Compaq will ship an exchange printer to you. Upon receipt of the exchange printer, remove the ink cartridges and cable from the printer you are returning. You will need to use these with your exchange printer. Cable and ink cartridges are not shipped with the exchange printer.

### How do I obtain online support?

Compaq offers free technical support via its Internet web site at [www.compaq.com](http://www.compaq.com). Select Support. You may also visit the Compaq Support Forum at [forum.compaq.com](http://forum.compaq.com) to quickly receive answers to your Compaq Inkjet Printer questions.

### What is not covered by this limited warranty?

- > Product purchased from anyone other than Compaq or a Compaq authorized reseller
- > Product purchased outside the United States or Canada
- > Software products except for obligations specified in the software program license agreement
- > Routine cleaning, or normal cosmetic and mechanical wear
- > Damage from misuse, abuse, or neglect
- > Damage from use outside the product's usage parameters
- > Damage from use of parts not manufactured or sold by Compaq
- > Damage from modification or incorporation into other products
- > Damage from repair or replacement of warranted parts by other than a Compaq authorized service provider
- > Damage to or loss of any programs or data
- > Damage resulting from an act of God

### Limited Warranty Statement for the United States and Canada

This One Year Limited Warranty applies in the United States and Canada to Hardware Products manufactured or distributed by Compaq Computer Corporation (Compaq) under the Compaq brand name.

A Compaq Hardware Product is defined as Compaq Inkjet Printer. Contact your Compaq authorized reseller or Compaq if you have any questions about this Limited Warranty. Compaq's obligations with respect to Software distributed by Compaq under the Compaq brand name are set forth in the applicable end-user license agreement. Compaq has no other obligation to repair or replace software under this limited warranty. Non-Compaq Hardware and Software Products are provided on an as is basis. However, non-Compaq manufacturers, suppliers, or publishers may provide their own warranties.

### Terms of the Warranty

Compaq warrants that the Hardware Product you have purchased from Compaq or from a Compaq Authorized Reseller is free from

## Getting Started Guide

defects in materials or workmanship under normal use during the warranty period. The warranty period commences on the date of purchase. Please retain a copy of your sales receipt. Your sales receipt is your proof of the date of purchase. This warranty extends only to you, the original Purchaser. It is non-transferable. It excludes expendable parts.

During the warranty period, Compaq will, at no additional charge, repair or replace defective parts with new parts or, at the option of Compaq, serviceable used parts that are equivalent or superior to new parts in performance.

All exchanged parts and Products replaced under this warranty will become the property of Compaq. If, after repeated efforts, Compaq is unable to restore the Product to good working order, you are entitled to a refund of the purchase price.

This Limited Warranty is valid only within the United States or Canada, and within the country in which the Hardware Product was purchased.

This Limited Warranty extends only to Products purchased from Compaq or from a Compaq authorized reseller.

This Limited Warranty also does not extend to any Product that has been damaged or rendered defective (a) as a result of accident, misuse, or abuse; (b) as a result of an act of God; (c) by operation outside the usage parameters stated in the Product's User's Guide; (d) by the use of parts not manufactured or sold by Compaq; (e) by modification of the Product; or (f) as a result of service by anyone other than Compaq, a Compaq authorized reseller, or a Compaq authorized service provider. Compaq is not responsible for damage to or loss of any programs or data. Contact your local Compaq authorized service provider for geographic restrictions, proof-of-purchase requirements, response time commitments and other specific on-site service requirements.

EXCEPT AS EXPRESSLY SET FORTH IN THIS WARRANTY, COMPAQ MAKES NO OTHER WARRANTIES, EXPRESSED OR IMPLIED, INCLUDING ANY IMPLIED WARRANTIES OF MERCHANTABILITY

AND FITNESS FOR A PARTICULAR PURPOSE. COMPAQ EXPRESSLY DISCLAIMS ALL WARRANTIES NOT STATED IN THIS LIMITED WARRANTY. ANY IMPLIED WARRANTIES THAT MAY BE IMPOSED BY LAW ARE LIMITED TO THE TERMS OF THIS EXPRESS LIMITED WARRANTY.

### Limitation of Remedy

Compaq is not liable for any damages caused by the Product or the failure of the Product to perform, including any lost profits, lost savings, incidental damages, or consequential damages. Compaq is not liable for any claim made by a third party or made by you for a third party.

This limitation applies whether damages are sought, or a claim made, under this warranty or as a tort claim (including negligence and strict product liability), a contract claim, or any other claim. This limitation cannot be waived or amended by any person. This limitation of liability will be effective even if Compaq or an authorized representative of Compaq has been advised by you of the possibility of any such damages. This limitation

of liability, however, will not apply to claims for personal injury.

### U.S.A. State Laws

Some states do not allow limitation on how long an implied warranty lasts. In such states, the limitations or exclusions of this Limited Warranty may not apply to you. Some states do not allow the exclusion or limitation in incidental or consequential damages for consumer products. In such states, the exclusion or limitation of this Limited Warranty may not apply to you. This Limited Warranty gives you specific legal rights. You may also have other rights that may vary from state to state. You are advised to consult applicable state laws for a full determination of your rights.

### Notices

This section contains information about:

- > Notices
- > Safety information

### Electronic emission notices

#### Federal Communications Commission (FCC) compliance information statement

This equipment has been tested and found to comply with the limits for a Class B digital device, pursuant to Part 15 of the FCC Rules. Operation is subject to the following two conditions: (1) this device may not cause harmful interference, and (2) this device must accept any interference received, including interference that may cause undesired operation.

The FCC Class B limits are designed to provide reasonable protection against harmful interference in a residential installation. This equipment generates, uses and can radiate radio frequency energy and, if not installed and used in accordance with the instructions, may cause harmful interference to radio communications. However, there is no guarantee that

interference will not occur in a particular installation. If this equipment does cause harmful interference to radio or television reception, which can be determined by turning the equipment off and on, the user is encouraged to try to correct the interference by one or more of the following measures:

- > Reorient or relocate the receiving antenna.
- > Increase the separation between the equipment and receiver.
- > Connect the equipment into an outlet on a circuit different from that to which the receiver is connected.
- > Consult your point of purchase or service representative for additional suggestions.

The manufacturer is not responsible for any radio or television interference caused by using other than recommended cables or by unauthorized changes or modifications to this equipment. Unauthorized changes or modifications could void the user's authority to operate this equipment.

To assure compliance with FCC regulations on electromagnetic interference for a Class B computing device, use a properly shielded and

grounded cable. Use of a substitute cable not properly shielded and grounded may result in a violation of FCC regulations.

Any questions regarding this compliance information statement should be directed to:

Compaq Computer Corporation  
P. O. Box 692000  
Mail Stop 510101  
Houston, TX 77269-2000  
Or, call (281) 514-3333

### Service and Support

Please refer to your Limited Warranty Statement for information on how to obtain service and support for your product.

#### Industry Canada compliance statement

This Class B digital apparatus meets all requirements of the Canadian Interference-Causing Equipment Regulations.

#### Avis de conformité aux normes d'Industrie Canada

Cet appareil numérique de la classe B respecte toutes les exigences du Règlement sur le matériel brouilleur du Canada.

## European Community (EC) directives conformity

This product is in conformity with the protection requirements of EC Council directives 89/336/EEC and 73/23/EEC on the approximation and harmonization of the laws of the Member States relating to electromagnetic compatibility and safety of electrical equipment designed for use within certain voltage limits.

A declaration of conformity with the requirements of the Directive has been signed by the assigned parties within Compaq Computer Corporation.

This product satisfies the Class B limits of EN 55022 and safety requirements of EN 60950.

## Japanese VCCI Notice

この装置は、情報処理装置等電磁障害防止規制協議会（V.C.C.I）の基準に基づきクラスB規格技術の装置です。この装置は、家庭環境で使用することを目的としていますが、この装置が他の家電製品の電磁波を発生させる原因となることがあります。取扱説明書に従って正しい取り扱いをして下さい。

## The United Kingdom Telecommunications Act 1984

This apparatus is approved under the approval number NS/G/1234/J/100003 for the indirect connections to the public telecommunications systems in the United Kingdom.

## Energy Star



The EPA ENERGY STAR Computers program is a partnership effort with computer manufacturers to promote the introduction of energy-efficient products and to reduce air pollution caused by power generation.

Companies participating in this program introduce personal computers, printers, monitors, or fax machines that power down when they are not being used. This feature will cut the energy used by up to 50 percent. Compaq is proud to be a participant in this program.

As an Energy Star Partner, Compaq Computer Corporation has determined that this product meets the Energy Star guidelines for energy efficiency.

## AC Adapter information

If your AC Adapter fails, replace it only with the Compaq replacement part.

You should use the AC adapter which is specified in this user manual.

## Safety information

- > If your product is NOT marked with this symbol , it MUST be connected to an electrical outlet that is properly grounded.
- > The power cord must be connected to an electrical outlet that is near the product and easily accessible.
- > Refer service or repairs, other than those described in the operating instructions, to a professional service person.
- > This product is designed, tested, and approved to meet strict global safety standards with the use of specific authorized components. The safety features of some parts may not always be obvious. The printer manufacturer is not responsible for the use of other replacement parts.

# Getting Started Guide



## Free Manuals Download Website

<http://myh66.com>

<http://usermanuals.us>

<http://www.somanuals.com>

<http://www.4manuals.cc>

<http://www.manual-lib.com>

<http://www.404manual.com>

<http://www.luxmanual.com>

<http://aubethermostatmanual.com>

Golf course search by state

<http://golfingnear.com>

Email search by domain

<http://emailbydomain.com>

Auto manuals search

<http://auto.somanuals.com>

TV manuals search

<http://tv.somanuals.com>